

FCC CERTIFICATION TEST REPORT

For
FCC ID: X8F-GT1

Report Reference No..... : 14FAB09010 31

Date of issue : 2014-09-17

Testing Laboratory : ATT Product Service Co., Ltd.

Address : No. 3, ChangLianShan Industrial Park, ChangAn Town,
DongGuan City, GuangDong, China.

Applicant's name..... : SkyHawke Technologies, LLC

Address : 274 Commerce Park Drive N/A Ridgeland Mississippi
United States 39157 Richard Root

Manufacturer : Season Group USA, LLC

Test specification:

Test item description..... : Game Tracker

Trade Mark..... : --

Model/Type reference : GT1

Ratings : Rechargeable battery 3.7Vd.c 770mAh; with micro USB port
(DC 5V, 500mA)

Responsible Engineer

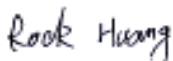

(Rock Huang/ Engineer)

Approved by

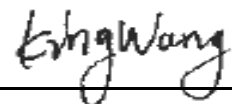

(King Wang /EMC Manager)

TABLE OF CONTENTS

TEST REPORT DECLARE	3
1. Summary of test Standards and results	4
2. General test information	5
2.1 ACCREDITATIONS.....	5
2.2 Description of EUT	5
2.3 Accessories of EUT	5
2.4 Assistant equipment used for test	5
2.5 Block diagram of EUT configuration for test.....	6
2.6 Test environment conditions	6
2.7 Measurement uncertainty	6
3. 20dB Bandwidth.....	7
3.1 Test equipment	7
3.2 Block diagram of test setup	7
3.3 Applicable Standard.....	7
3.4 Test Procedure	7
3.5 Test Result.....	8
3.6 Original test data.....	8
4.1 Test equipment	9
4.2 Block diagram of test setup	9
4.3 Test Procedure	9
4.4 Limit.....	9
4.5 Test Result.....	10
5.1 Test equipment	11
5.2 Block diagram of test setup	11
5.3 Limit.....	13
5.4 Test Procedure	14
5.5 Test result	14
6. Antenna Requirements	15
6.1 Limit.....	15
6.2 Result.....	15
7. Power Line Conducted Emission	16
7.1 Test equipment	16
7.2 Block diagram of test setup	16
7.3 Power Line Conducted Emission Limits(Class B)	16
7.4 Test Procedure	17
7.5 Test Result.....	18
8.EUT TEST PHOTO	20

TEST REPORT DECLARE

Applicant	:	SkyHawke Technologies, LLC
Address	:	274 Commerce Park Drive N/A Ridgeland Mississippi United States 39157 Richard Root
Equipment under Test	:	Game Tracker
Model No	:	GT1
Trade Mark	:	--
Manufacturer	:	Season Group USA, LLC
Address	:	Season Group USA, LCC 3503 Crosspoint, Suite #2 San Antonio, Texas 78217

Test Standard Used: FCC Rules and Regulations Part 15 Subpart C: 2013

Test procedure used: ANSI C63.4: 2009, ANSI C63.10:2009

We Declare:

The equipment described above is tested by ATT Product Service Co., Ltd. and in the configuration tested the equipment complied with the standards specified above. The test results are contained in this test report and ATT Product Service Co., Ltd. is assumed of full responsibility for the accuracy and completeness of these tests.

After test and evaluation X/Y/Z axis of the EUT. will record worst case in this report. our opinion is that the equipment provided for test compliance with the requirement of the above FCC standards.

Report No:	14FAB09010 31		
Date of Test:	2014/09/08-2014/09/15	Date of Report:	2014/09/17

Note: This report applies to above tested sample only. This report shall not be reproduced in parts without written approval of ATT Product Service Co., Ltd.

1. Summary of test Standards and results

The EUT have been tested according to the applicable standards as referenced below.

Description of Test Item	Standard	Results
Field Strength of Fundamental Emissions	&15. 225 (a) ANSI C63.10 :2009	PASS
Radiated Emission	15.209,&15.205,&15.225 ANSI C63.10 :2009	PASS
Conducted Emissions	&15.207(a) ANSI C63.10 :2009	PASS
frequency tolerance of the carrier signal	&15.225 (a)	PASS

2. General test information

2.1 ACCREDITATIONS

The measuring facility of laboratories has been authorized or registered by the following approval agencies.

USA **FCC** **Registration Number :923232**
Canada **INDUSTRY CANADA** **Registration Number 11033A**

2.2 Description of EUT

EUT* Name	:	Game Tracker
Model Number	:	GT1
Trade Mark	:	--
EUT function description	:	Please reference user manual of this device
Power supply	:	Rechargeable battery 3.7Vd.c 770mAh; with micro USB port
Operation frequency	:	13.56MHz
Modulation	:	ASK
Antenna Type	:	built-in FPC antenna, maximum PK gain:0dBi
Date of Receipt	:	2014/09/06
Sample Type	:	Series production

2.3 Accessories of EUT

Description of Accessories	Manufacturer	Model number or Type	Other
/	/	/	/

2.4 Assistant equipment used for test

Description of Assistant equipment	Manufacturer	Model number or Type	EMC Compliance	SN
Notebook Computer	lenovo	7457	FCC DOC approved	7457A82
Mouse	DELL	MSU1175	FCC DOC approved	13A00303345DN
Headphone	Senicc	ST-2688	--	150 cm non-shielding
Printer	Epson	P952B	FCC DOC approved	AXQ0018586

2.5 Block diagram of EUT configuration for test

Tested mode, channel, information	
Test Mode	Frequency (MHz)
Tx	13.56MHz

2.6 Test environment conditions

During the measurement the environmental conditions were within the listed ranges:

Temperature range:	21-25°C
Humidity range:	40-75%
Pressure range:	86-106kPa

2.7 Measurement uncertainty

Test Item	Uncertainty
Uncertainty for Conduction emission test	2.44dB
Uncertainty for Radiation Emission test (9KHz-30MHz)	3.21dB
Uncertainty for Radiation Emission test (30MHz-200MHz)	3.42 dB (Polarize: V)
	3.52 dB (Polarize: H)
Uncertainty for Radiation Emission test (200MHz-1GHz)	3.52 dB (Polarize: V)
	3.54 dB (Polarize: H)
Uncertainty for radio frequency	1×10 ⁻⁹
Uncertainty for conducted RF Power	0.65dB

Note: This uncertainty represents an expanded uncertainty expressed at approximately the 95% confidence level using a coverage factor of k=2.

3. 20dB Bandwidth

3.1 Test equipment

Item	Equipment	Manufacturer	Model No.	Serial No.	Cal Due.	Cal. Interval
	EMI Test Receiver	R&S	ESCI	101307	2014/12/26	1Y
	Attenuator	Mini-Circuits	BW-S10W2	101109	2014/12/27	1Y
	RF Cable	Micable	C10-01-01-1	100309	2014/12/27	1Y

3.2 Block diagram of test setup



3.3 Applicable Standard

Intentional radiators operating under the alternative provisions to the general emission limits, as contained in §§ 15.217 through 15.257 and in Subpart E of this part, must be designed to ensure that the 20 dB bandwidth of the emission, or whatever bandwidth may otherwise be specified in the specific rule section under which the equipment operates, is contained within the frequency band designated in the rule section under which the equipment is operated...

3.4 Test Procedure

1. Check the calibration of the measuring instrument using either an internal calibrator or a known signal from an external generator.
2. Position the EUT on the test table without connection to measurement instrument. Turn on the EUT. Then set it to any one convenient frequency within its operating range. Set a reference level on the measuring instrument equal to the highest peak value.
3. Measure the frequency difference of two frequencies that were attenuated 20 dB from the reference level. Record the frequency difference as the emission bandwidth.
4. Repeat above procedures until all frequencies measured were complete..

3.5 Test Result

EUT: Game Tracker		M/N: GT1			
Mode	Freq (MHz)	Result (KHz)	Limit (MHz)	Margin (MHz)	Conclusion
Tx	13.56	7.98	/	/	PASS
Test Date : 2014/09/08			Test Engineer : Vito		

3.6 Original test data

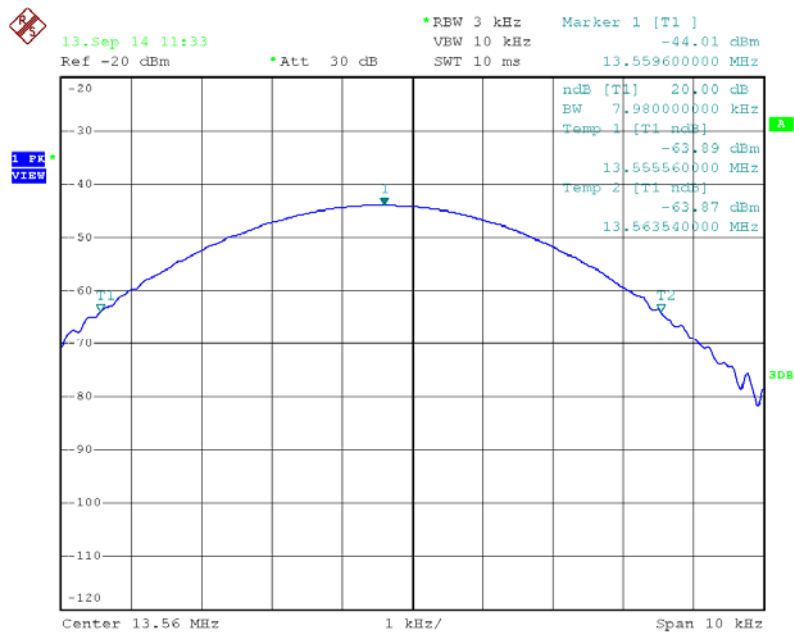

4. Frequency tolerance of the carrier signal

4.1 Test equipment

Item	Equipment	Manufacturer	Model No.	Serial No.	Cal Due.	Cal. Interval
1	EMI Test Receiver	R&S	ESCI	101307	2014/12/26	1Y
2	Attenuator	Mini-Circuits	BW-S10W2	101109	2014/12/27	1Y
3	RF Cable	Micable	C10-01-01-1	100309	2014/12/27	1Y

4.2 Block diagram of test setup

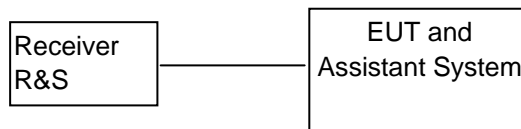

4.3 Test Procedure

The frequency tolerance of the carrier signal shall be maintained within $\pm 0.01\%$ of the operating frequency over a temperature variation of $-20\text{ }^{\circ}\text{C}$ to $+50\text{ }^{\circ}\text{C}$ at normal supply voltage, and for a variation in the primary supply voltage from 85 % to 115 % of the rated supply voltage at a temperature of $20\text{ }^{\circ}\text{C}$. For battery-operated equipment, the equipment tests shall be performed using a new battery.

4.4 Limit

According 15.225 (e): The frequency tolerance of the carrier signal shall be maintained within $\pm 0.01\%$ of the operating frequency.

4.5 Test Result

Test Conditions	Frequency	Limit
+50°C, Nominal voltage	13.5602	Within $\pm 0.01\%$ operating Frequency (13.5582 ~ 13.561 MHz)
+20°C, 85 % Normal voltage	13.5598	
+20°C, Nominal voltage	13.5599	
+20°C, 115 % Normal voltage	13.5606	
-20°C, Nominal voltage	13.5601	

5. RADIATED EMISSION

5.1 Test equipment

Item	Equipment	Manufacturer	Model No.	Serial No.	Cal Due.	Cal. Interval
1	EMI Test Receiver	R&S	ESCI	101307	2014/12/26	1Y
2	Spectrum analyzer	Agilent	E4407B	US40240708	2015/07/13	1Y
3	Loop antenna	Chase	HLA6120	20129	2014/12/27	1Y
4	Trilog Broadband Antenna	Schwarzbeck	VULB9163	9163-462	2014/12/27	1Y
5	Double Ridged Horn Antenna	R&S	HF907	100276	2014/12/27	1Y
6	Pre-Amplifier	R&S	SCU-01	10049	2014/12/27	1Y
7	Pre-amplifier	A.H.	PAM0-0118	360	2014/12/27	1Y
8	RF Cable	R&S	R01	10403	2014/12/27	1Y
9	RF Cable	R&S	R02	10512	2014/12/27	1Y
10	Horn Antenna	EMCO	3116	9608-4877	2014/12/27	1Y

5.2 Block diagram of test setup

In 3m Anechoic Chamber Test Setup Diagram for below 30MHz

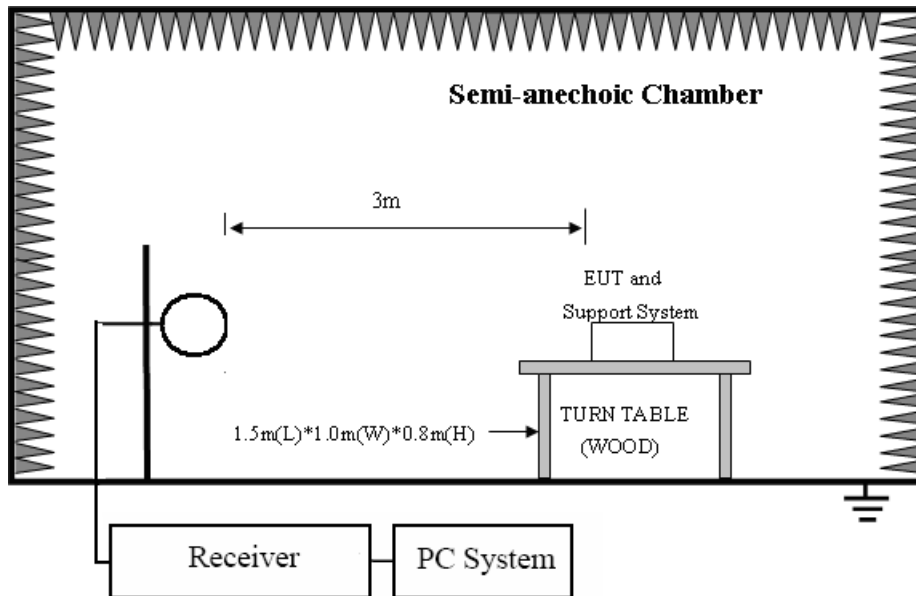

In 3m Anechoic Chamber Test Setup Diagram for below 1GHz

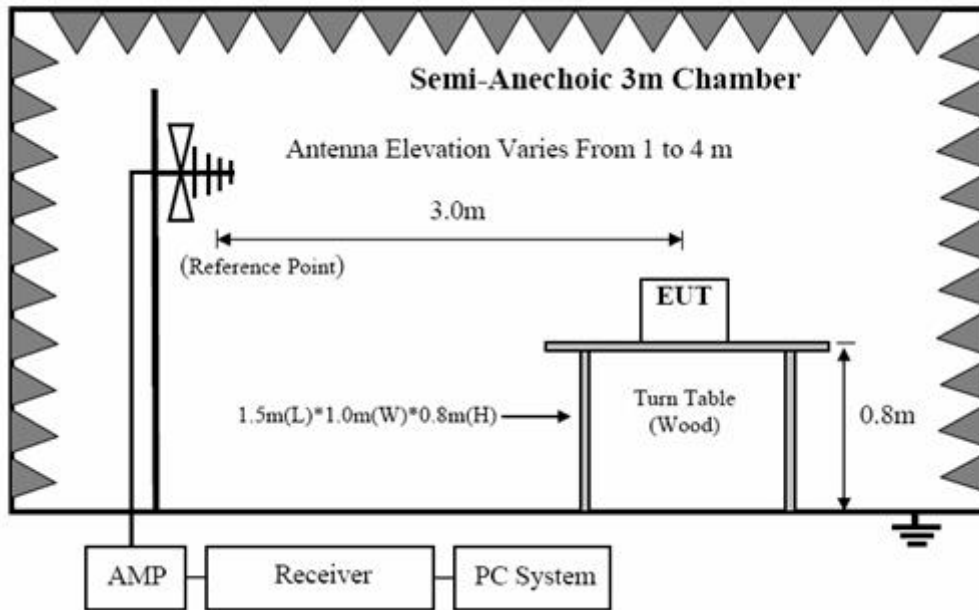

In 3m Anechoic Chamber Test Setup Diagram for frequency above 1GHz

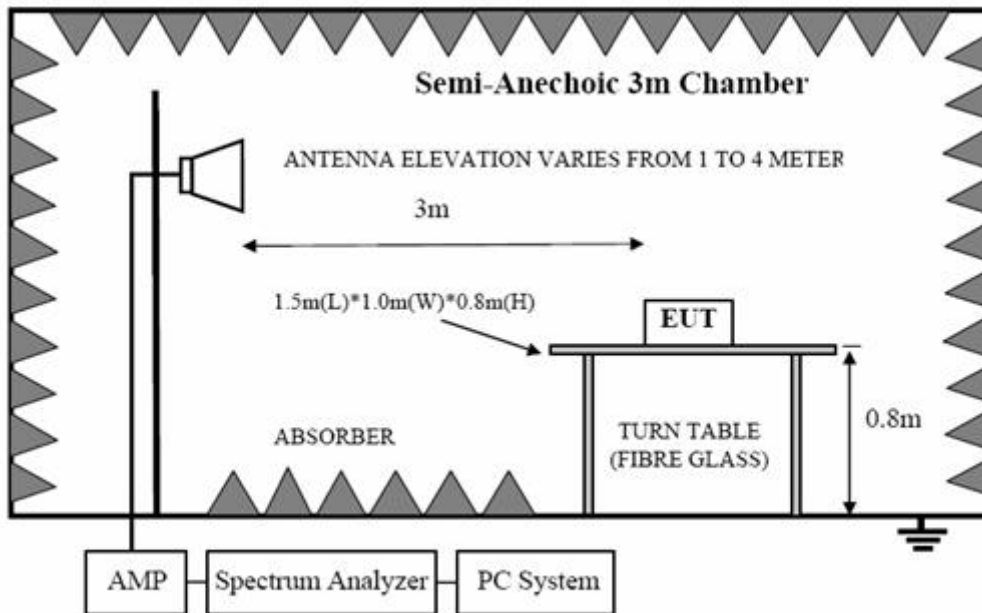

Note: For harmonic emissions test a appropriate high pass filter was inserted in the input port of AMP.

5.3 Limit

5.3.1 FCC 15.205 Restricted frequency band

MHz	MHz	MHz	GHz
0.090 - 0.110	16.42 - 16.423	399.9 - 410	4.5 - 5.15
¹ 0.495 - 0.505	16.69475 - 16.69525	608 - 614	5.35 - 5.46
2.1735 - 2.1905	16.80425 - 16.80475	960 - 1240	7.25 - 7.75
4.125 - 4.128	25.5 - 25.67	1300 - 1427	8.025 - 8.5
4.17725 - 4.17775	37.5 - 38.25	1435 - 1626.5	9.0 - 9.2
4.20725 - 4.20775	73 - 74.6	1645.5 - 1646.5	9.3 - 9.5
6.215 - 6.218	74.8 - 75.2	1660 - 1710	10.6 - 12.7
6.26775 - 6.26825	108 - 121.94	1718.8 - 1722.2	13.25 - 13.4
6.31175 - 6.31225	123 - 138	2200 - 2300	14.47 - 14.5
8.291 - 8.294	149.9 - 150.05	2310 - 2390	15.35 - 16.2
8.362 - 8.366	156.52475 - 156.52525	2483.5 - 2500	17.7 - 21.4
8.37625 - 8.38675	156.7 - 156.9	2690 - 2900	22.01 - 23.12
8.41425 - 8.41475	162.0125 - 167.17	3260 - 3267	23.6 - 24.0
12.29 - 12.293	167.72 - 173.2	3332 - 3339	31.2 - 31.8
12.51975 - 12.52025	240 - 285	3345.8 - 3358	36.43 - 36.5
12.57675 - 12.57725	322 - 335.4	3600 - 4400	(²)

5.3.2 FCC 15.209 Limit

FREQUENCY MHz	DISTANCE Meters	FIELD STRENGTHS LIMIT	
		μV/m	dB(μV)/m at 3 m
0.009 ~ 0.49	300	2400/F(kHz)	65.0
0.49 ~ 1.705	30	2400/F(kHz)	45.0
1.705 ~ 30	30	30	69.5
30 ~ 88	3	100	40.0
88 ~ 216	3	150	43.5
216 ~ 960	3	200	46.0
960 ~ 1000	3	500	54.0
Above 1000	3	74.0 dB(μV)/m (Peak) 54.0 dB(μV)/m (Average)	

5.3.3 FCC 15.225 Limit

Fundamental frequency	Field strength of fundamental (microvolts/meter) at 30 meter	Field strength of fundamental (dBuV/m) at 3 meter
13.553–13.567 MHz	15848	124.0
13.410-13.553 MHz and 13.567-13.710 MHz	334	90.5
13.110-13.410 MHz and 13.710-14.010 MHz	106	80.5

5.3.4 Limit for this EUT

The radiated emission tests were performed in the 3 meters test site, using the setup accordance with the ANSI C63.4:2009. The specification used was the FCC 15.209, and FCC 15.225 limits.

5.4 Test Procedure

- (1) EUT was placed on a non-metallic table, 80 cm above the ground plane inside a semi-anechoic chamber.
- (2) Setup EUT and assistant system according clause 2.4 and 8.2
- (3) Test antenna was located 3m from the EUT on an adjustable mast. Below pre-scan procedure was first performed in order to find prominent radiated emissions.
 - (a) Change work frequency or channel of device if practicable.
 - (b) Change modulation type of device if practicable.
 - (c) Change power supply range from 85% to 115% of the rated supply voltage
 - (d) Rotated EUT though three orthogonal axes to determine the attitude of EUT arrangement produces highest emissions
- (4) Spectrum frequency from 9KHz to 25GHz (tenth harmonic of fundamental frequency) was investigated, and no any obvious emission were detected from 9KHz to 30MHz and 18GHz to 25GHz, so below final test was performed with frequency range from 30MHz to 18GHz.
- (5) For final emissions measurements at each frequency of interest, the EUT were rotated and the antenna height was varied between 1m and 4m in order to maximize the emission. Measurements in both horizontal and vertical polarities were made and the data was recorded. In order to find the maximum emission, the relative positions of equipments and all of the interface cables were changed according to ANSI C63.10 2009 on Radiated Emission test.
- (6) For emissions from 30MHz to 1GHz, Quasi-Peak values were measured with EMI Receiver and the bandwidth of Receiver is 120 KHz.

5.5 Test result

PASS. (See below detailed test result)

According to the recorded data in following table, the EUT complied with the FCC Title 47, Part 15, Subpart C and section 15.205, 15.209 and 15.225, Vertical and Horizontal mode all have been tested, Horizontal mode is the worse case .with the worst margin reading of:

Radiated Emission Test Result

EUT:	Game Tracker	Model No.:	GT1
Temperature:	24°C	Relative Humidity:	55%
Distance:	3m	Test Power:	DC 3.7V
Polarization:	Vertical	Test Result:	Pass
Standard:	(RE)FCC Part 15_3m	Test By:	Vito
Test Mode:	Tx 13.56MHz		
Note:			

Frequency (MHz)	Receiver		Rx Antenna		Cable Loss (dB)	Amplifier Gain (dB)	Result Level (dB μ V/m)	FCC 15.225 & 15.109	
	Reading (dB μ V)	Detector (PK/QP/ AV)	Polar (H/V)	Factor (dB)				Limit (dB μ V/m)	Margin (dB)
0.02	33.93	PK	V	23.53	0.02	0	57.48	121.58	-64.1
5.64	22.05	PK	V	26.12	0.11	0	48.28	69.50	-21.22
11.97	22.86	PK	V	26.65	0.12	0	49.63	69.50	-19.87
13.28	16.28	PK	V	26.71	0.13	0	43.12	80.50	-37.38
13.48	16.53	PK	V	26.71	0.13	0	43.37	90.50	-47.13
13.56	77.73	PK	V	26.72	0.13	0	104.58	124.00	-19.42
13.67	17.03	PK	V	26.72	0.13	0	43.88	90.50	-46.62
13.80	19.35	PK	V	26.73	0.13	0	46.21	80.50	-34.29
27.13	28.33	PK	V	28.63	0.18	0	57.14	69.50	-12.16
125.88	44.58	QP	H	12.42	2.57	26.9	32.67	43.50	-10.83
125.88	42.61	QP	V	12.42	2.57	26.9	30.7	43.50	-12.80

6. Antenna Requirements

6.1 Limit

For intentional device, according to FCC 47 CFR Section 15.203, an intentional radiator shall be designed to ensure that no antenna other than that furnished by the responsible party shall be used with the device. And according to FCC 47 CFR Section 15.225 (b), if transmitting antennas of directional gain greater than 6dBi are used, the power shall be reduced by the amount in dB that the directional gain of the antenna exceeds 6dBi.

6.2 Result

The EUT has an internal chip antenna permanently soldering on the printed circuit board, which complied with 15.203, the maximum gain was 0dBi.

7. Power Line Conducted Emission

7.1 Test equipment

Item	Equipment	Manufacturer	Model No.	Serial No.	Cal Due.	Cal. Interval
	Test Receiver	R&S	ESCI	101308	2014/12/26	1 Year
	LISN 1	AFJ	LS16	16011103219	2014/12/28	1 Year
	LISN 2	R&S	ESH2-Z5	100309	2014/12/28	1 Year
	Pulse Limiter	MTS-systemtechnik	MTS-IMP-136	261115-010-0024	2014/12/28	1 Year

7.2 Block diagram of test setup

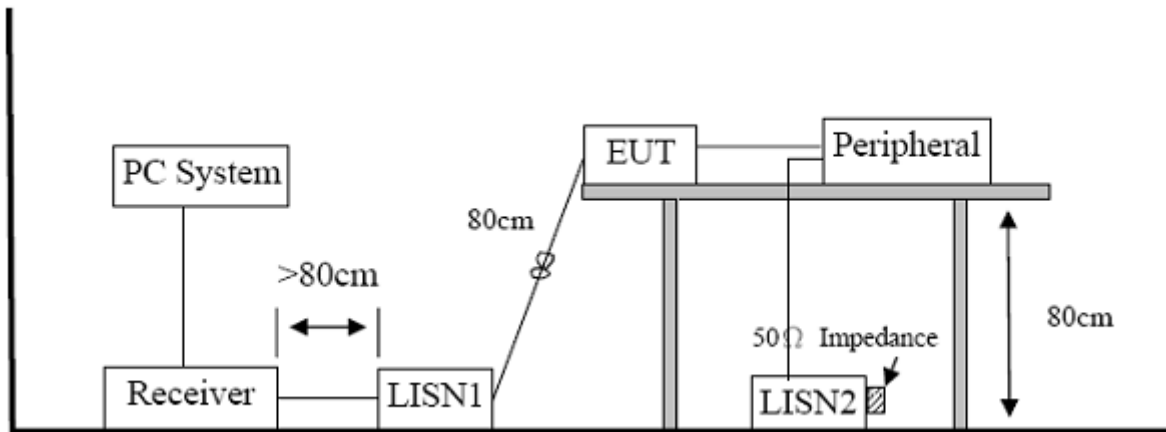

7.3 Power Line Conducted Emission Limits(Class B)

Frequency	Quasi-Peak Level dB(μV)	Average Level dB(μV)
150kHz ~ 500kHz	66 ~ 56*	56 ~ 46*
500kHz ~ 5MHz	56	46
5MHz ~ 30MHz	60	50

Note 1: * Decreasing linearly with logarithm of frequency.

Note 2: The lower limit shall apply at the transition frequencies

7.4 Test Procedure

The EUT and Support equipment, if needed, were put placed on a non-metallic table, 80cm above the ground plane. Configuration EUT to simulate typical usage as described in clause 2.4 and test equipment as described in clause 10.2 of this report. All I/O cables were positioned to simulate typical actual usage as per ANSI C63.4: 2009. All support equipment power received from a second LISN. Emissions were measured on each current carrying line of the EUT using an EMI Test Receiver connected to the LISN powering the EUT. The Receiver scanned from 150 kHz to 30MHz for emissions in each of the test modes. During the above scans, the emissions were maximized by cable manipulation. The test mode(s) described in clause 2.4 were scanned during the preliminary test. After the preliminary scan, we found the test mode producing the highest emission level. The EUT configuration and worse cable configuration of the above highest emission levels were recorded for reference of the final test. EUT and support equipment were set up on the test bench as per the configuration with highest emission level in the preliminary test. A scan was taken on both power lines, Neutral and Line, recording at least the six highest emissions. Emission frequency and amplitude were recorded into a computer in which correction factors were used to calculate the emission level and compare reading to the applicable limit. The test data of the worst-case condition(s) was recorded. The bandwidth of test receiver is set at 9 KHz.

7.5 Test Result

PASS. (See below detailed test result)

EUT:	Game Tracker	Model No.:	GT1
Temperature:	24°C	Relative Humidity:	55%
Probe:	L1	Test Power:	Via PC USB supply
Standard:	(CE)FCC PART 15 class B_QP	Test Result:	Pass
Test Mode:	Tx	Test By:	Vito
Note:	PC Mains		

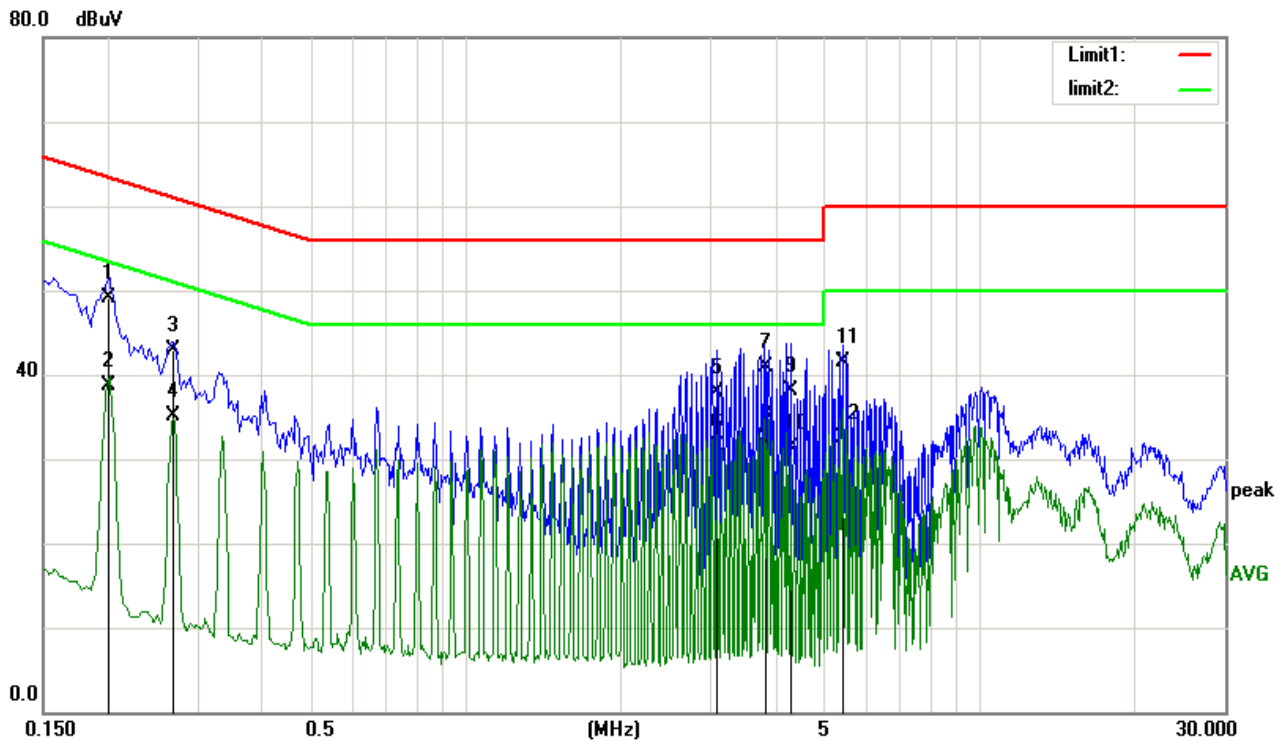

No.	Frequency (MHz)	Reading (dBuV)	Correct Factor(dB)	Result (dBuV)	Limit (dBuV)	Margin (dB)	Remark
1	0.1997	38.04	11.13	49.17	63.62	-14.45	QP
2	0.1997	27.60	11.13	38.73	53.62	-14.89	AVG
3	0.2689	32.33	10.65	42.98	61.15	-18.17	QP
4	0.2689	24.41	10.65	35.06	51.15	-16.09	AVG
5	3.0826	27.81	10.14	37.95	56.00	-18.05	QP
6	3.0826	21.37	10.14	31.51	46.00	-14.49	AVG
7	3.8222	30.83	10.15	40.98	56.00	-15.02	QP
8	3.8222	22.45	10.15	32.60	46.00	-13.40	AVG
9	4.2935	27.95	10.13	38.08	56.00	-17.92	QP
10	4.2935	21.10	10.13	31.23	46.00	-14.77	AVG
11	5.4351	31.31	10.10	41.41	60.00	-18.59	QP
12	5.4351	22.33	10.10	32.43	50.00	-17.57	AVG

EUT:	Game Tracker	Model No.:	GT1
Temperature:	24°C	Relative Humidity:	55%
Probe:	N	Test Power:	Via PC USB supply
Standard:	(CE)FCC PART 15 class B_QP	Test Result:	Pass
Test Mode:	Tx	Test By:	Vito
Note:	PC Mains		

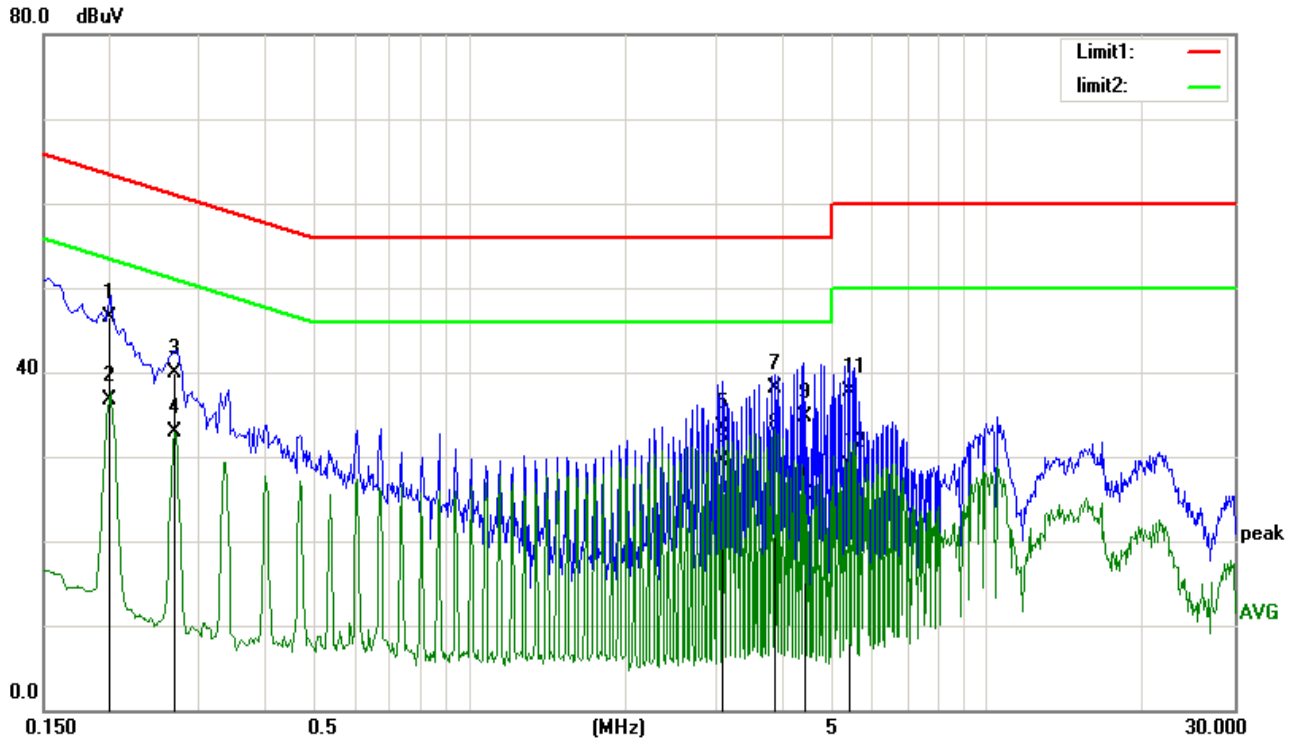

No.	Frequency (MHz)	Reading (dBuV)	Correct Factor(dB)	Result (dBuV)	Limit (dBuV)	Margin (dB)	Remark
1	0.2006	35.41	11.12	46.53	63.58	-17.05	QP
2	0.2006	25.60	11.12	36.72	53.58	-16.86	AVG
3	0.2692	29.25	10.65	39.90	61.14	-21.24	QP
4	0.2692	22.22	10.65	32.87	51.14	-18.27	AVG
5	3.0884	23.45	10.14	33.59	56.00	-22.41	QP
6	3.0884	19.28	10.14	29.42	46.00	-16.58	AVG
7	3.8973	28.01	10.14	38.15	56.00	-17.85	QP
8	3.8973	21.00	10.14	31.14	46.00	-14.86	AVG
9	4.4373	24.59	10.12	34.71	56.00	-21.29	QP
10	4.4373	15.39	10.12	25.51	46.00	-20.49	AVG
11	5.4448	27.51	10.10	37.61	60.00	-22.39	QP
12	5.4448	18.88	10.10	28.98	50.00	-21.02	AVG

8.EUT TEST PHOTO

Conducted Measurement Photos



Radiated Measurement Photos (Below 30MHz)

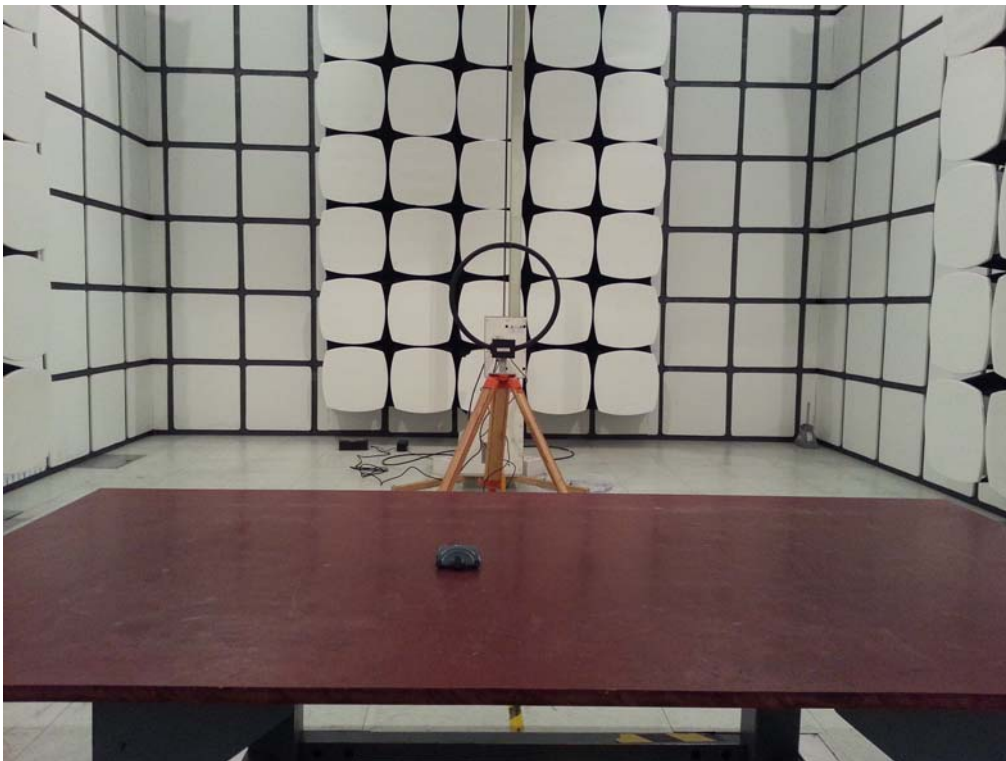

Radiated Measurement Photos (30MHz~1GHz)

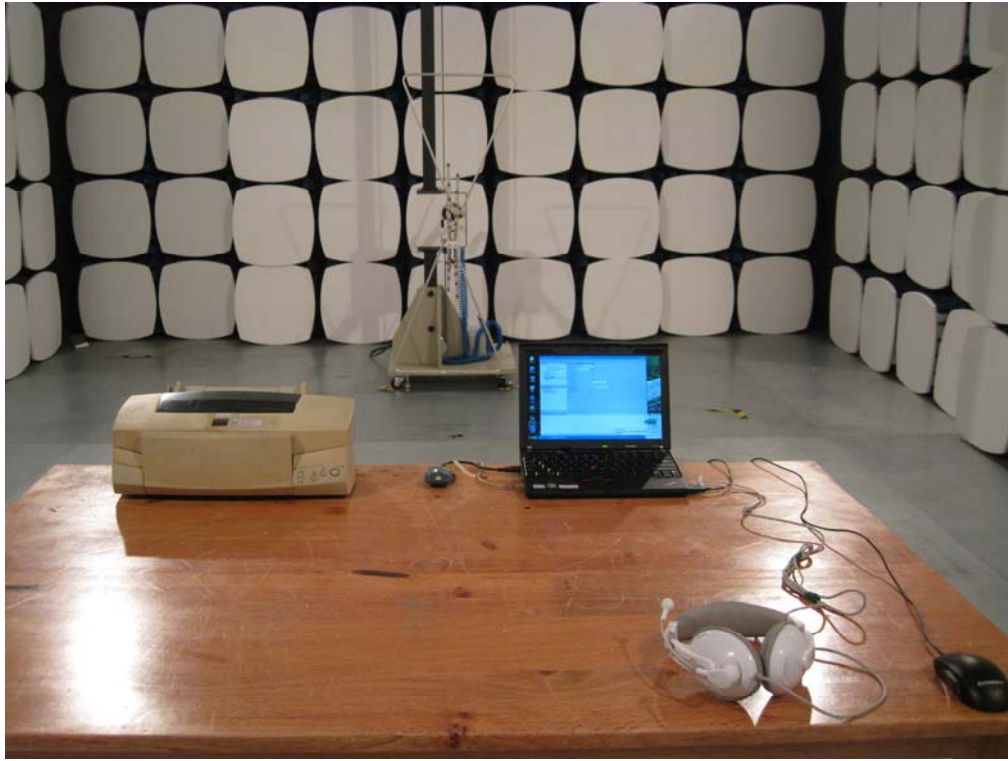

EUT PHOTO





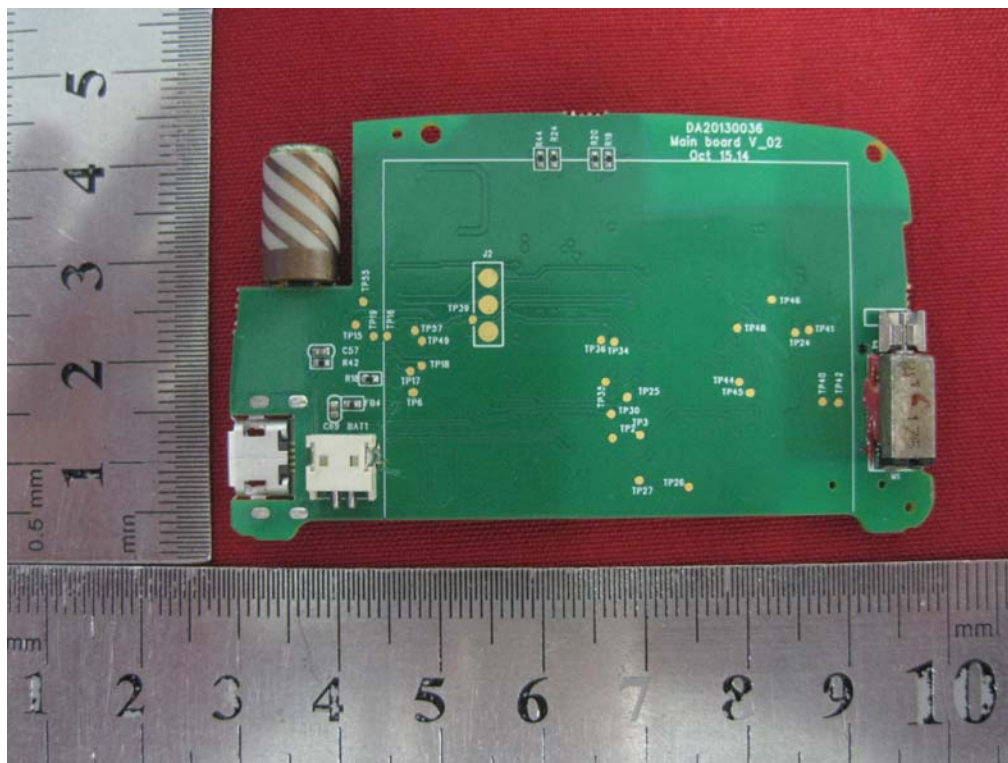
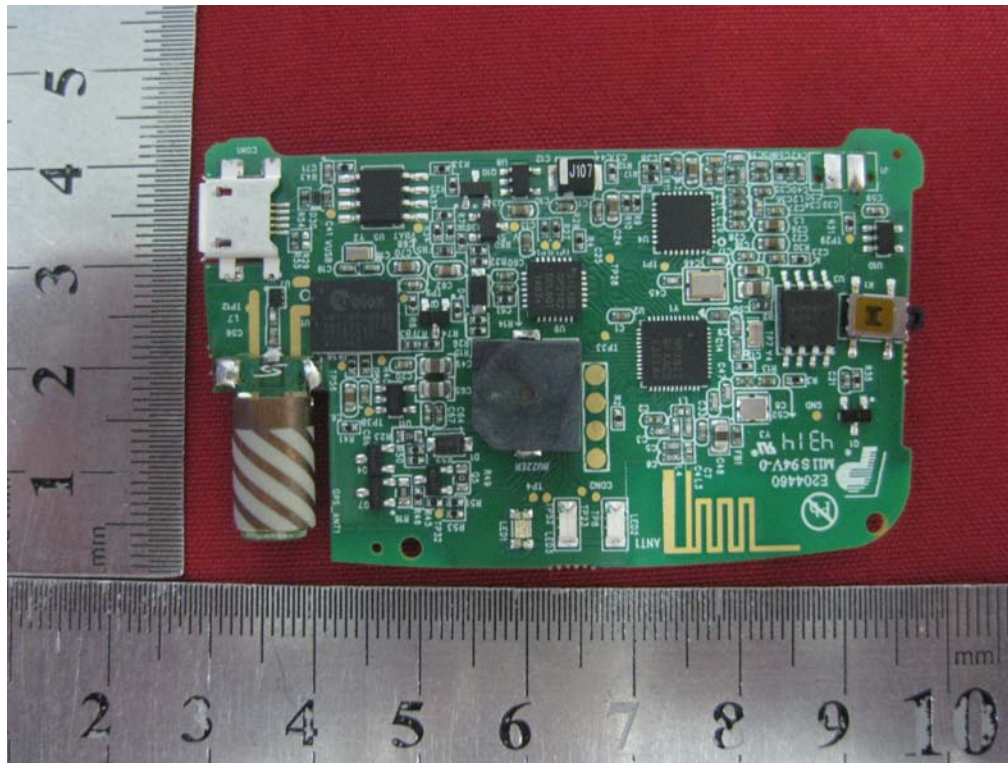

END OF REPORT