

FCC COMPLIANCE REPORT
for
ZIONCOM TECHNOLOGY LIMITED
Wireless Router
Model Number: IP0494; RG300EX Lite

Prepared for : ZIONCOM TECHNOLOGY LIMITED
Address : Building A1~A2,lantian Science and Technology Park,Xinyu Road
Xinqiao Henggang Block Shajing Street,Baoan District,
Shenzhen City

Prepared By : NS Technology Co., Ltd.
Address : Chenwu Industrial Zone, Houjie Town, Dongguan City,
Guangdong, China

Tel: +86-769-85935656

Fax: +86-769-85991080

Report Number : NSE-F10044644
Date of Test : Mar. 10~Mar . 28, 2010
Date of Report : Mar. 30, 2010





TABLE OF CONTENTS

	Page
Test Report Declaration	Page
1. GENERAL PRODUCT INFORMATION	4
1.1. Product Function	4
1.2. Description of Device (EUT)	4
1.3. Difference between Model Numbers	4
1.4. Independent Operation Modes	4
1.5. Test Supporting System	5
2. TEST SITES	6
2.1. Test Facilities	6
2.2. List of Test and Measurement Instruments	7
3. TEST SET-UP AND OPERATION MODES	8
3.1. Principle of Configuration Selection.....	8
3.2. Block Diagram of Test Set-up.....	8
3.3. Test Operation Mode and Test Software.....	8
3.4. Special Accessories and Auxiliary Equipment	8
3.5. Countermeasures to Achieve EMC Compliance.....	8
4. TEST SUMMARY	9
5. DATA RATE VS POWER	10
6. EMISSION TEST RESULTS	11
6.1. Conducted Emission at The Mains Terminals Test.....	11
6.2. Radiated Emission.....	14
6.3. 6dB Bandwidth	70
6.4. Power Spectral Density Test	73
6.5. Output Power Test.....	76
6.6. Band Edge	77
6.7. ANTENNA REQUIREMENT	110





NS Technology Co., Ltd.

Applicant:	ZIONCOM TECHNOLOGY LIMITED		
Address:	Building A1~A2,lantian Science and Technology Park,Xinyu Road Xinqiao Henggang Block Shajing Street,Baoan District, Shenzhen City		
Manufacturer:	ZIONCOM TECHNOLOGY LIMITED		
Address:	Building A1~A2,lantian Science and Technology Park,Xinyu Road Xinqiao Henggang Block Shajing Street,Baoan District, Shenzhen City		
E.U.T:	Wireless Router		
Model Number:	IP0494; RG300EX Lite		
Trade Name:	-----		
Operating Frequency:	IEEE802.11b 2412~2462MHz; IEEE802.11g 2412~2462MHz IEEE802.11n HT20:2412~2462MHz;IEEE802.11n HT40:2422~2452MHz		
Date of Receipt:	Mar.4, 2010	Date of Test:	Mar. 10~Mar . 28, 2010
Test Specification:	FCC Part 15 Subpart C: Oct. 2009 ANSI C63.4:2003		
Test Result:	The equipment under test was found to be compliance with the requirements of the standards applied.		
		Issue Date: Mar.30, 2010	
Tested by:	Reviewed by:	Approved by:	
			
Jade/ Engineer	Iceman Hu / Supervisor	Steven Lee / Manager	
Other Aspects:	None.		
<i>Abbreviations: OK/P=passed fail/F=failed n.a/N=not applicable E.U.T=equipment under tested</i>			
<i>This test report is based on a single evaluation of one sample of above mentioned products ,It is not permitted to be duplicated in extracts without written approval of NS Technology Co., Ltd.</i>			



1. GENERAL PRODUCT INFORMATION

1.1. Product Function

Details please refer to Technical Construction Form and User Manual.

1.2. Description of Device (EUT)

E.U.T.	: Wireless Router
Model No.	: IP0494
Operating Frequency	: 2412~2462MHz
Number of Channels	: IEEE 802.11b/g,802.11n HT20:11 Channels IEEE 802.11n HT40:7 Channels
Type of Modulation	: DSSS for IEEE 802.11b, OFDM for IEEE 802.11g and IEEE 802.11n
Data Rate	: IEEE 802.11b:11/5.5/2/1M bps IEEE 802.11g:54/48/36/24/18/12/9/6Mbps IEEE 802.11n HT20:130/117/104/78/65/58.5/52/39/26/ 19.5/13/6.5Mbps IEEE 802.11n HT40:135/121.5/108/81/54/40.5/ 27/13.5Mbps
Antenna Type	: External
Antenna Gain	: 5dBi
System Input Voltage	: DC 5V from adapter input AC 120V/60Hz
Temperature Range	: 0 ~+ 40°C
Adapter	: M/N:FLDE0501000K I/P:100-240V~50/60Hz 0.2A O/P:5V___1A DC Line:Unshielded,Undetachable ,1.5m
Lan Cable	: Unshielded,Detachable ,0.9m

1.3. Difference between Model Numbers

Note :The products are different only for model number,But the others are identical.

1.4. Independent Operation Modes

The basic operation modes are:

- 1.4.1. IEEE 802.11b; TX CH1 (2412MHz)
- 1.4.2. IEEE 802.11b; TX CH 6 (2437MHz)
- 1.4.3. IEEE 802.11b; TX CH11 (2462MHz)
- 1.4.4. IEEE 802.11g; TX CH1 (2412MHz)
- 1.4.5. IEEE 802.11g; TX CH 6 (2437MHz)
- 1.4.6. IEEE 802.11g; TX CH11 (2462MHz)
- 1.4.1. IEEE 802.11n HT20; TX CH1 (2412MHz)
- 1.4.2. IEEE 802.11n HT20; TX CH 6 (2437MHz)
- 1.4.3. IEEE 802.11n HT20; TX CH11 (2462MHz)
- 1.4.4. IEEE 802.11n HT40; TX CH1 (2422MHz)
- 1.4.5. IEEE 802.11n HT40; TX CH 4 (2437MHz)
- 1.4.6. IEEE 802.11 HT40n; TX CH7 (2452MHz)



1.5. Test Supporting System

1.5.1. PC

Model Number : a6608cn
Serial Number : 3CR8382430
Manufacturer : HP
Data Cable : Shielded, Detachable, 1.5m
Power Cord : Unshielded, Detachable, 1.5m

1.5.2. Monitor

Model Number : KB744AA
Serial Number : 3CR8382430
Manufacturer : HP
Data Cable : Shielded, Detachable, 1.5m
Power Cord : Shielded, Detachable, 1.5m

1.5.3. Keyboard

Model Number : SK-8115
Serial Number : CN-0DJ313-91D-0AE4
Manufacturer : HP

1.5.4. Mouse

Model Number : M056UO
Manufacturer : DELL
Data Cable : Shielded, Undetachable, 1.8m

2. TEST SITES

2.1. Test Facilities

EMC Lab : Certificated by TUV Rheinland, Germany.
Date of registration: July 28, 2003

Certificated by FCC, USA
Registration No.: 502831
Date of registration: February 09, 2009

Certificated by VCCI, Japan
Registration No.: R-2527 & C-2770
Date of registration: March 23, 2007

Certificated by CNAL, CHINA
Registration No.: L1744
Date of registration: November 25, 2004

Certificated by Intertek ETL SEMKO
Registration No.: TMP-013
Date of registration: June 11, 2005

Certificated by TUV/PS, Hong Kong
Date of registration: December 1, 2005

Certificated by Industry Canada
Registration No.: 5936A
Date of registration: March 4, 2009

Certificated by ATCB, America
Date of registration: August 03, 2006

Name of Firm : NS Technology Co., Ltd.

Site Location : Chenwu Industrial Zone, Houjie Town, Dongguan City,
Guangdong, China



2.2. List of Test and Measurement Instruments

2.2.1. For conducted emission at the mains terminals test

Equipment	Manufacturer	Model No.	Serial No.	Last Cal.	Next Cal.
EMI Test Receiver	Rohde&Schwarz	ESCS30	100340	May 31,09	May 31,10
Artificial Mains Network	Rohde&Schwarz	ESH3-Z5	100317	May 31,09	May 31,10
Artificial Mains Network (AUX)	Kyoritsu	KNW-407	8-1579-1	Jan.19,09	Jan.19,11
Pulse Limiter	Rohde&Schwarz	ESH3-Z2	100168	May 2,09	May 2,10

2.2.2.For radiated emission test (30MHz-1GHz)

Equipment	Manufacturer	Model No.	Serial No.	Last Cal.	Next Cal.
EMI Test Receiver	Rohde & Schwarz	ESCS30	100340	May 31,09	May 31,10
Spectrum Analyzer	HP	8593E	3448U00806	May 31,09	May 31,10
Bilog Antenna	Teseq	CBL 6111D	25758	Oct. 27,09	Oct. 27,10
Signal Amplifier	Agilent	8447D	2944A10488	May 2,09	May 2,10
50Ω Coaxial Switch	ANRITSU	MP59B	6200530577	May 2,09	May 2,10

2.2.3.For radiated emission test(1GHz-18GHz)

Equipment	Manufacturer	Model No.	Serial No.	Last Cal.	Next Cal.
Spectrum Analyzer	HP	8593E	3448U00806	May 31,09	May 31,10
Horn Antenna	EMCO	3117	00062558	Jan. 19,09	Jan. 19,11
Signal Amplifier	BURGEON	PEC-38-30M18G -12-SFF	NSEMC001	May 31,09	May 31,11

2.2.4.For output power Test

Equipment	Manufacturer	Model No.	Serial No.	Last Cal.	Next Cal.
RF Probe	Rohde&Schwarz	URV5-Z4	100657	Jul.31,09	Jul.31,10
Power Meter	Rohde&Schwarz	NRVS	101732	Jul.31,09	Jul.31,10

2.2.5.For power spectral density Test

Equipment	Manufacturer	Model No.	Serial No.	Last Cal.	Next Cal.
Spectrum Analyzer	Rohde&Schwarz	FSL3	101507	Jul.31,09	Jul.31,10

2.2.6.For Band edge compliance and 6dB bandwidth test

Equipment	Manufacturer	Model No.	Serial No.	Last Cal.	Next Cal.
Spectrum Analyzer	Rohde&Schwarz	FSL3	101507	Jul.31,09	Jul.31,10

3. TEST SET-UP AND OPERATION MODES

3.1. Principle of Configuration Selection

The equipment under test (EUT) was configured to measure its highest possible radiated level. The test modes were adapted accordingly in reference to the Operating Instructions.

3.2. Block Diagram of Test Set-up

System Diagram of Connections Between EUT and Simulators

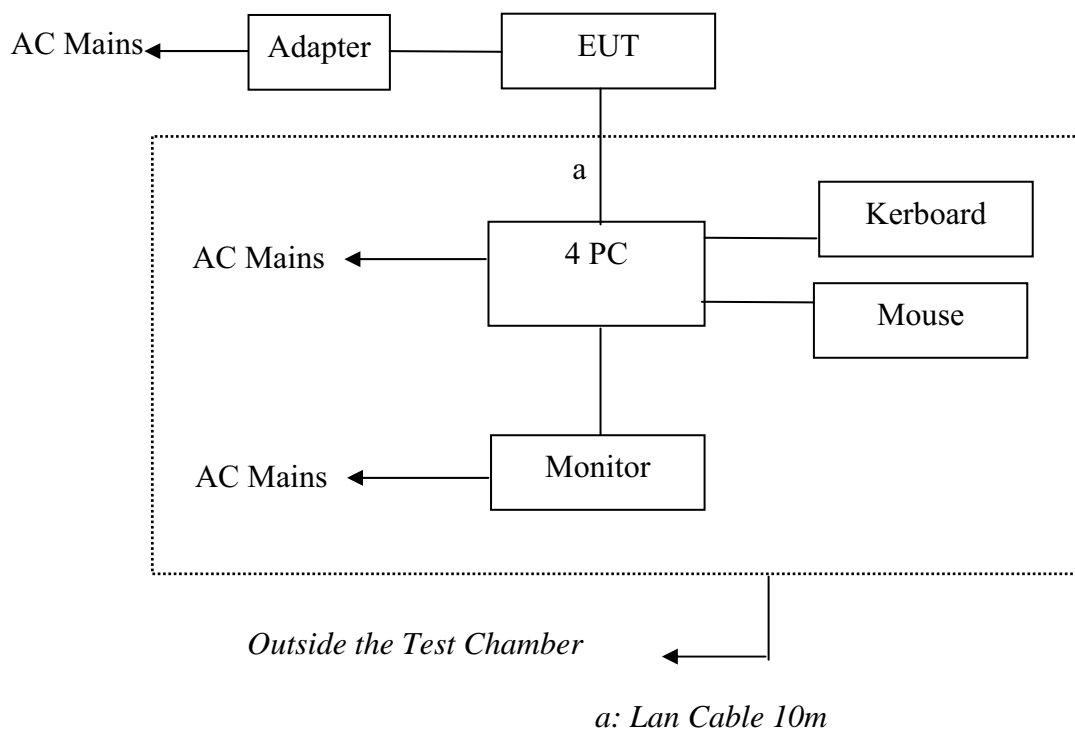

(EUT : Wireless Router)

3.3. Test Operation Mode and Test Software

Refer to clause 1.4

3.4. Special Accessories and Auxiliary Equipment

None.

3.5. Countermeasures to Achieve EMC Compliance

None.

4. TEST SUMMARY

Test items and result lists

No.	Item	Standard	Results
1	Data rate VS power	N/A	N/A
2	Conduction Emission Test	FCC Part15C: 15.207 ANSI C63.4-2003 KDB558074	PASS
3	Radiated Emission Test	FCC Part15C: 15.209 ANSI C63.4-2003 KDB558074	PASS
4	Band Edge Compliance Test	FCC Part15: 15.247 KDB558074	PASS
5	Output Power Test	FCC Part15: 15.247 KDB558074	PASS
6	6dB Bandwidth Test	FCC Part15: 15.247 KDB558074	PASS
7	Power Spectral Density Test	FCC Part15: 15.247 KDB558074	PASS
8	Antenna requirement	FCC Part 15:15.203	PASS

5. DATA RATE VS POWER

Mode	data rate (Mbps)	CH	Read (dBm)	Factor (dB)	Result (dBm)
11b	1	CH6	11.02	6	17.02
	2	CH6	11.26	6	17.26
	5.5	CH6	11.38	6	17.38
	11	CH6	11.94	6	17.94
11g	54	CH6	11.42	6	17.42
	48	CH6	10.26	6	16.26
	36	CH6	10.35	6	16.35
	24	CH6	10.39	6	16.39
	18	CH6	10.24	6	16.24
	12	CH6	10.44	6	16.44
	9	CH6	10.36	6	16.36
11n HT20	6	CH6	10.11	6	16.11
	6	CH6	9.76	6	15.76
	13	CH6	9.85	6	15.85
	19.5	CH6	9.87	6	15.87
	26	CH6	9.69	6	15.69
	39	CH6	9.42	6	15.42
	52	CH6	9.62	6	15.62
	58.5	CH6	9.68	6	15.68
	65	CH6	9.77	6	15.77
	78	CH6	9.84	6	15.84
	104	CH6	9.88	6	15.88
	117	CH6	10.03	6	16.03
11n HT40	130	CH6	10.12	6	16.12
	135	CH3	9.84	6	15.84
	121.5	CH3	9.36	6	15.36
	108	CH3	8.87	6	14.87
	81	CH3	8.88	6	14.88
	54	CH3	8.89	6	14.89
	40.5	CH3	8.75	6	14.75
	27	CH3	8.49	6	14.49
13.5	CH3	8.18	6	14.18	

Result=Read+Factor

Factor= RF attenuator loss(3dB)+Cable loss(3dB)

When IEEE 802.11b's data rate was 11Mbps ; IEEE 802.11g's data rate was 54Mbps,
When IEEE 802.11n HT20's data rate was 130Mbps ; IEEE 802.11n HT40's data rate
was 135Mbps the EUT have maximum output power and all the test was performed in
this data rate set.

6. EMISSION TEST RESULTS

6.1. Conducted Emission at The Mains Terminals Test

RESULT : **Pass**
 Test procedure : FCC Part 15 Subpart C
 Frequency range : 0.15 ~ 30MHz
 Test Site : Shielded Room
 Limits : FCC Part 15 Subpart C

Test Setup

Date of test : Jan. 20, 2010
 Model No. : IP0494
 Input Voltage : DC 5V from adapter input AC 120V/60Hz
 Operation Mode : TX Mode

The EUT was put on a wooden table which was 0.8metre high above the ground and connected to the AC mains through a Artificial Mains Network (A.M.N). The mains lead in excess of 1 m separating the EUT from the AMN was folded at the cable centre into a bundle no longer than 0.4 m.

The EUT was kept 0.4m from any other earthed conducting surface. Both sides of AC line were checked to find out the maximum conducted emission levels according to the test procedure during conducted emission test.

The bandwidth of the test receiver (R&S ESCS30) was set at 9 kHz.

The frequency range from 150 kHz to 30 MHz was investigated.

The test data of the worst case condition(s) was reported on the following page.

When IEEE 802.11b's data rate was 11Mbps ; IEEE 802.11g's data rate was 54Mbps, When IEEE 802.11n HT20's data rate was 130Mbps ; IEEE 802.11n HT40's data rate was 135Mbps the EUT have maximum output power and all the test was performed in this data rate set.

Note: Test uncertainty: ± 2.54 dB at a level of confidence of 95%.

NS Technology

Chenwu Industrial Zone, Houjie Town,
Dongguan, Guangdong, China
Tel: +86-769-85935656
Fax: +86-769-85991080

Data: 96 File: D:\Conduction\Z\Zioncom.EMI (96)

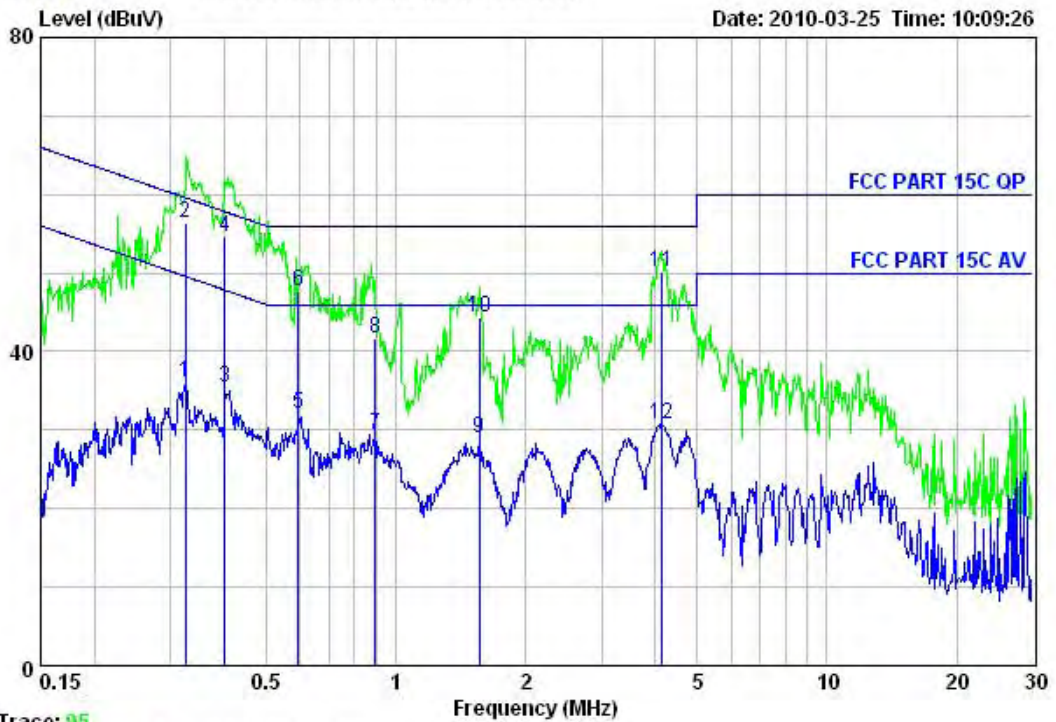

Trace: 95

Test Site : 843 Shielded Room
 Limit : FCC PART 15C QP LINE Phase: NEUTRAL
 EUT : Wireless Router
 Power : DC 5V From Adapter Input AC 120V/60Hz
 M/N : IPO494
 Test Engineer: Jade
 Comment : Temp: 25.3°C Humi: 55% Press: 101.51kPa
 Test Mode : TX Mode

	Freq. (MHz)	Level (dBuV)	Limits (dBuV)	Margin (dB)	Remark
1	0.33	36.21	49.57	13.36	Average
2	0.33	56.30	59.57	3.27	QP
3	0.40	35.42	47.81	12.39	Average
4	0.40	54.50	57.81	3.31	QP
5	0.59	32.01	46.00	13.99	Average
6	0.59	47.70	56.00	8.30	QP
7	0.89	29.44	46.00	16.56	Average
8	0.89	41.60	56.00	14.40	QP
9	1.56	28.86	46.00	17.14	Average
10	1.56	44.30	56.00	11.70	QP
11	4.14	50.20	56.00	5.80	QP
12	4.14	30.76	46.00	15.24	Average



NS Technology

Chenwu Industrial Zone, Houjie Town,
Dongguan, Guangdong, China
Tel: +86-769-85935656
Fax: +86-769-85991080

Data: 94 File: D:\Conduction\Z\Zioncom.EMI (96)

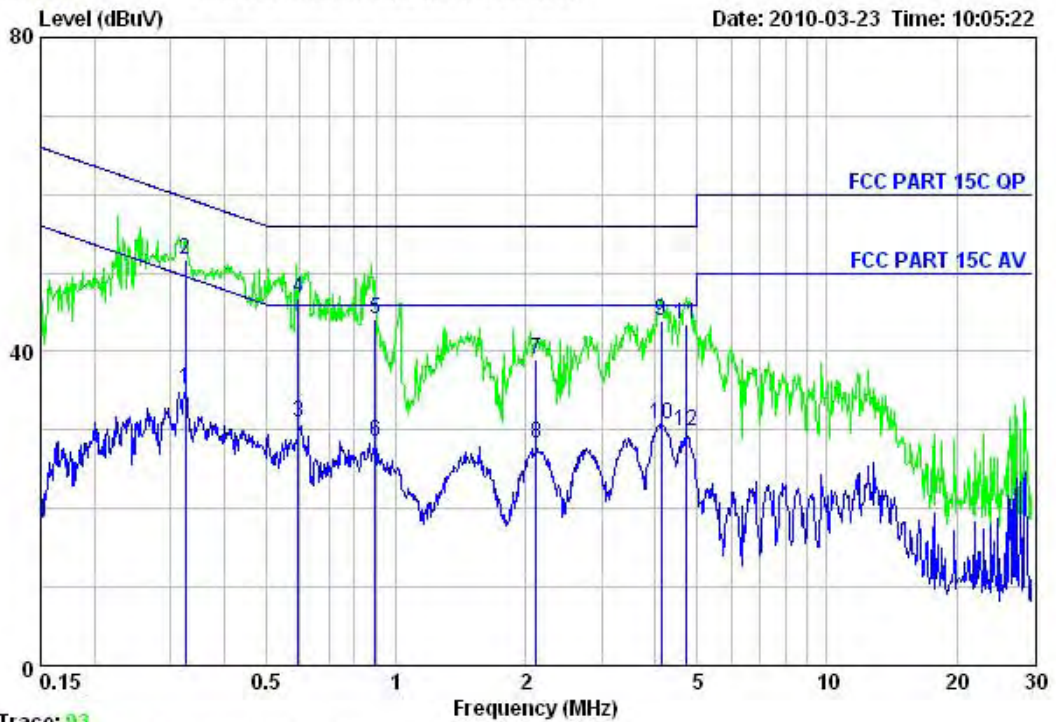

Trace: 93

Test Site : 843 Shielded Room
Limit : FCC PART 15C QP LINE Phase:LINE
EUT : Wireless Router
Power : DC 5V From Adapter Input AC 120V/60Hz
M/N : IPO494
Test Engineer: Jade
Comment : Temp:25.3'C Humi:55% Press:101.51kPa
Test Mode : TX Mode

	Freq. (MHz)	Level (dBuV)	Limits (dBuV)	Margin (dB)	Remark
1	0.33	35.21	49.57	14.36	Average
2	0.33	51.60	59.57	7.97	QP
3	0.59	31.01	46.00	14.99	Average
4	0.59	46.90	56.00	9.10	QP
5	0.89	44.20	56.00	11.80	QP
6	0.89	28.44	46.00	17.56	Average
7	2.12	39.10	56.00	16.90	QP
8	2.12	28.28	46.00	17.72	Average
9	4.14	43.90	56.00	12.10	QP
10	4.14	30.76	46.00	15.24	Average
11	4.70	43.40	56.00	12.60	QP
12	4.70	29.85	46.00	16.15	Average



6.2. Radiated Emission

6.2.1. Test limits

- 1) FCC part 15C section 15.209
- 2) FCC part 15C section 15.247(a)

6.2.2. Test procedure

The EUT was placed on a turn table which was 0.8 meter above ground. The turn table can rotate 360 degrees to determine the position of the maximum emission level. The EUT was set 3 meters away from the receiving antenna which was mounted on a antenna tower. At the frequency band of 30MHz to 1GHz, The measuring antenna moved up and down to find out the maximum emission level. It moved from 1 to 4 m for horizontal and vertical polarizations. The broadband antenna (calibrated by dipole antenna) was used as a receiving antenna. At the frequency band of 1GHz to 25GHz, The measuring antenna moved from 1 to 4 m for horizontal and vertical polarization. The horn antenna was used as a receiving antenna.

The resolution bandwidth and video bandwidth of the test receiver was 120 kHz and 300kHz for Quasi-peak detection at frequency below 1GHz.

The resolution bandwidth and video bandwidth of the test receiver was 1MHz and 1MHz for Peak detection at frequency above 1GHz.

For Average measurement at frequency above 1GHz. The resolution bandwidth of the test receiver was 1MHz ; due to the shortest pulse width T is 116us, according the video bandwidth should not smaller than 1/T, so the video bandwidth is 10Hz.

In 18GHz to 25GHz, The EUT was checked by Horn ANT . But the test result is background.

When IEEE 802.11b's data rate was 11Mbps ; IEEE 802.11g's data rate was 54Mbps, When IEEE 802.11n HT20's data rate was 130Mbps ; IEEE 802.11n HT40's data rate was 135Mbps the EUT have maximum output power and all the test was performed in this data rate set.

The EUT was tested in Chamber Site.

Note: Test uncertainty: ± 2.62 dB at a level of confidence of 95%.



6.2.3. Test Setup Diagram

5.1.3.1. Frequency range: 30MHz-1000MHz

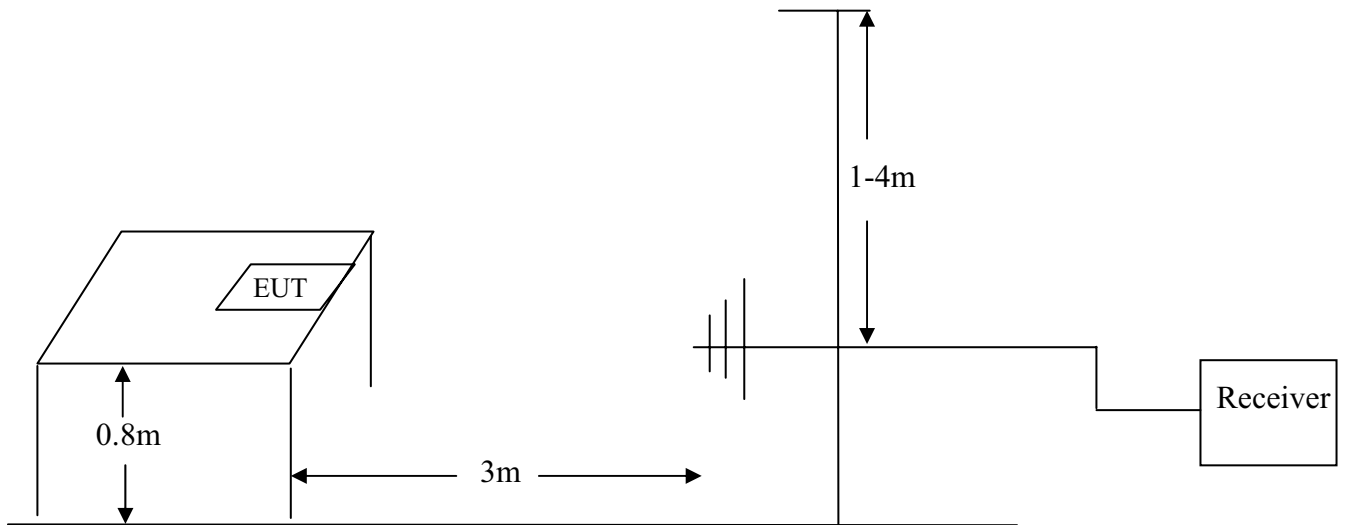

5.1.3.2. Frequency range: 1 GHz -25GHz

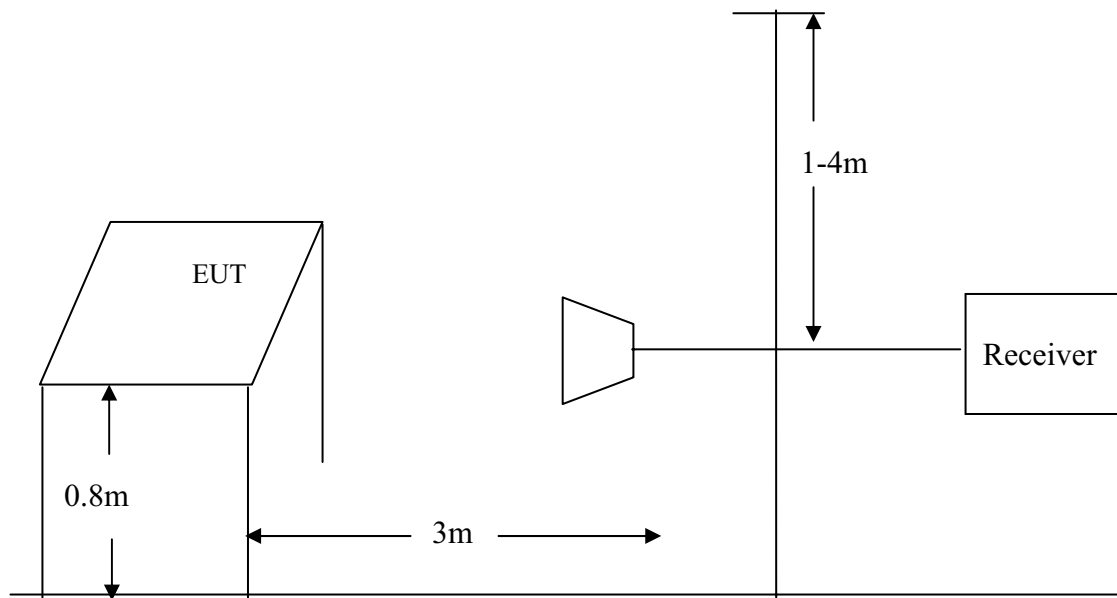

The test plots as following:

NS Technology

Chenwu Industrial Zone, Houjie Town,
Dongguan, Guangdong, China
Tel: +86-769-85935656
Fax: +86-769-85991080

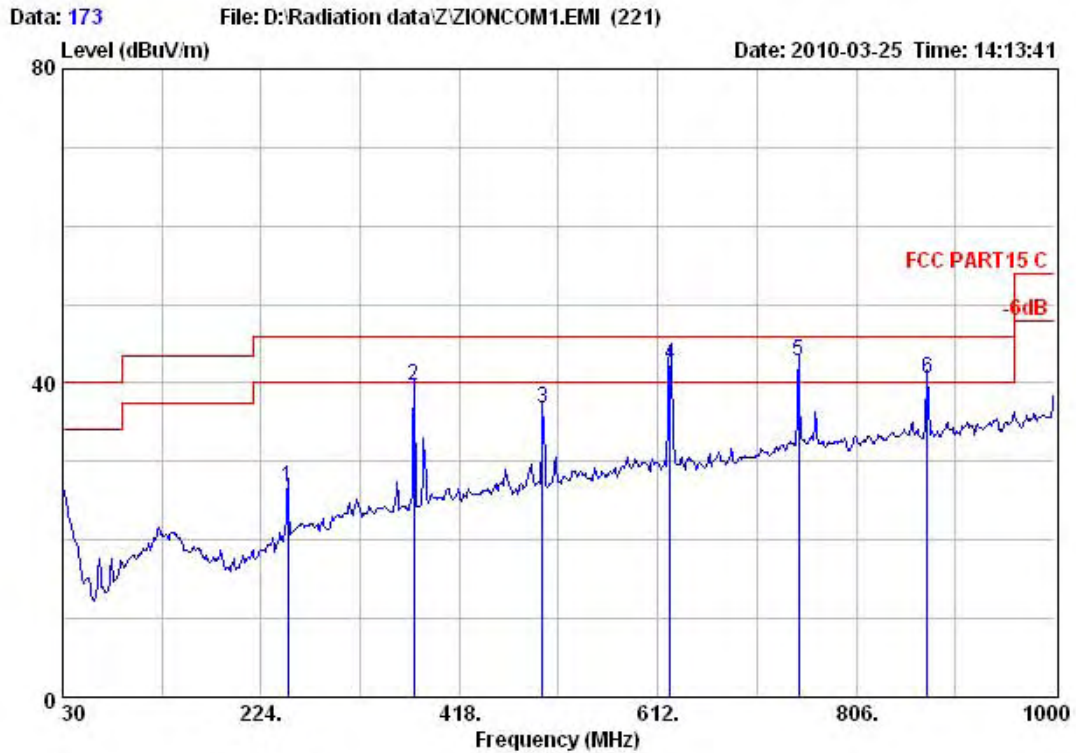

Test Site : 966 Chamber
 Limit : FCC PART15 C
 Dis. / Ant. : 3m 25757-3M Ant. Pol.: HORIZONTAL
 EUT : Wireless Router
 M/N : IP0494
 Power : DC 5V from adapter input AC 120V/60Hz
 Test Engineer : Jade
 Comment : Temp.:25.2'C Humi.:55% Press:101.35kPa
 Test Mode : TX Mode
 Ant high:2.2m; Table angle:95'

	Emission			Ant. Cable				
Freq. (MHz)	Level (dBuV/m)	Limits (dBuV/m)	Margin (dB)	Reading (dBuV)	Factor (dB/m)	Loss (dB)	Remark	
1	250.19	26.84	46.00	19.16	13.08	12.80	0.96	QP
2	373.38	39.60	46.00	6.40	22.70	15.78	1.12	QP
3	499.48	36.75	46.00	9.25	16.59	18.90	1.26	QP
4	623.64	42.32	46.00	3.68	19.99	20.94	1.39	QP
5	749.74	42.76	46.00	3.24	17.95	23.28	1.53	QP
6	875.84	40.66	46.00	5.34	15.00	23.94	1.72	QP



NS Technology

Chenwu Industrial Zone, Houjie Town,
Dongguan, Guangdong, China
Tel: +86-769-85935656
Fax: +86-769-85991080

Data: 172 File: D:\Radiation data\Z\ZIONCOM1.EMI (221)

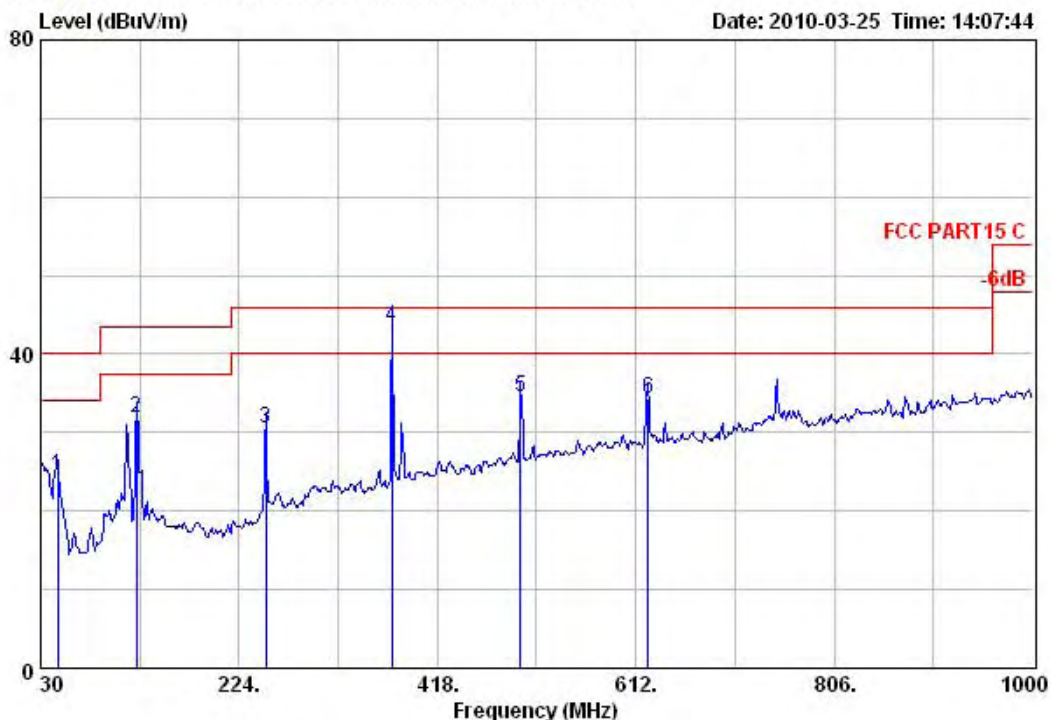

Test Site : 966 Chamber
 Limit : FCC PART15 C
 Dis. / Ant. : 3m 25757-3M Ant. Pol.: VERTICAL
 EUT : Wireless Router
 M/N : IP0494
 Power : DC 5V from adapter input AC 120V/60Hz
 Test Engineer : Jade
 Comment : Temp.:25.2'C Humi.:55% Press:101.35kPa
 Test Mode : TX Mode
 Ant high:1.1m; Table angle:88'

	Emission				Ant. Cable		Remark	
Freq. (MHz)	Level (dBuV/m)	Limits (dBuV/m)	Margin (dB)	Reading (dBuV)	Factor (dB/m)	Loss (dB)		
1	46.49	24.47	40.00	15.53	12.85	11.06	0.56	QP
2	124.09	31.90	43.50	11.60	19.63	11.53	0.74	QP
3	250.19	30.45	46.00	15.55	16.69	12.80	0.96	QP
4	373.38	43.53	46.00	2.47	26.63	15.78	1.12	QP
5	499.48	34.63	46.00	11.37	14.47	18.90	1.26	QP
6	623.64	34.26	46.00	11.74	11.93	20.94	1.39	QP



NS Technology

Chenwu Industrial Zone, Houjie Town,
Dongguan, Guangdong, China
Tel: +86-769-85935656
Fax: +86-769-85991080

Data: 174

File: D:\Radiation data\Z\ZIONCOM1.EMI (303)

Date: 2010-03-25 Time: 15:18:59

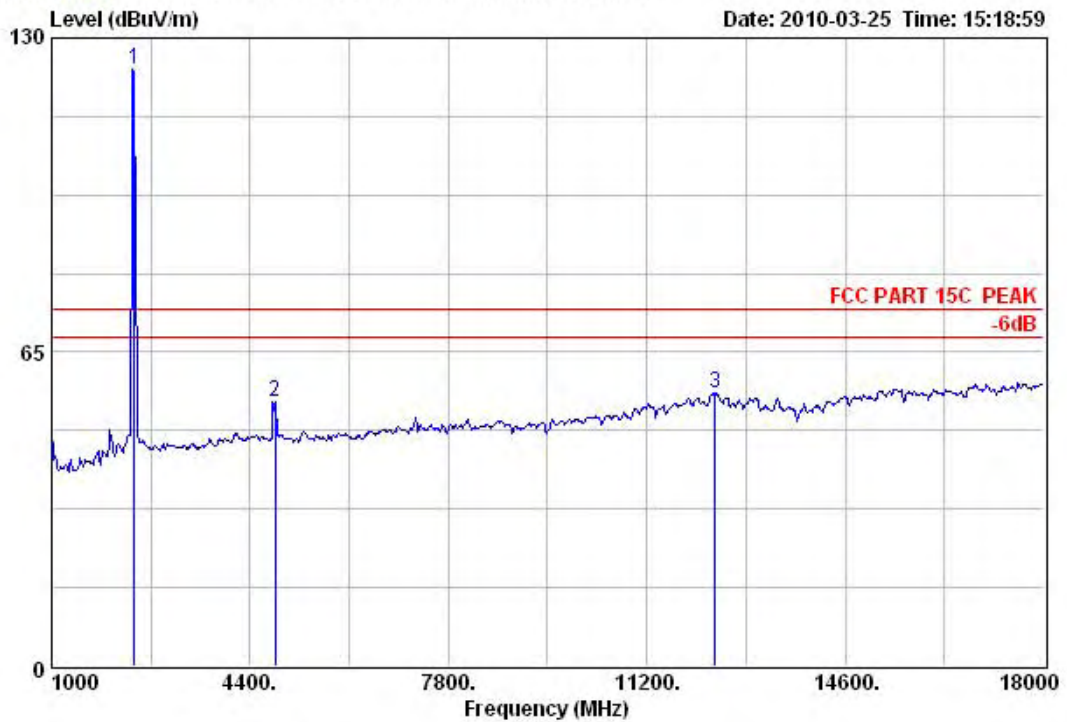

Test Site : 10m Chamber
 Limit : FCC PART 15C PEAK
 Dis. / Ant. : 3m 3117 Ant. Pol.: VERTICAL
 EUT : Wireless Router
 M/N : IP0494
 Power : DC 5V from adapter input AC 120V/60Hz
 Test Engineer : Jade
 Comment : Temp.:25.2'C Humi.:56% Press:101.51kPa
 Test Mode : TX Mode 802.11g CH1 2412MHz

Freq. (MHz)	Emission			Reading (dBuV)	Ant. Factor (dB/m)	Cable Loss (dB)	Remark
	Level (dBuV/m)	Limits (dBuV/m)	Margin (dB)				
1 2412.00	123.65	74.00	-49.65	89.92	31.50	2.23	Peak
2 4824.00	54.74	74.00	19.26	17.77	34.59	2.38	Peak
3 13237.30	56.53	74.00	17.47	13.74	39.95	2.84	Peak



NS Technology

Chenwu Industrial Zone, Houjie Town,
Dongguan, Guangdong, China
Tel: +86-769-85935656
Fax: +86-769-85991080

Data: 175

File: D:\Radiation data\Z\ZIONCOM1.EMI (303)

Date: 2010-03-25 Time: 15:21:58

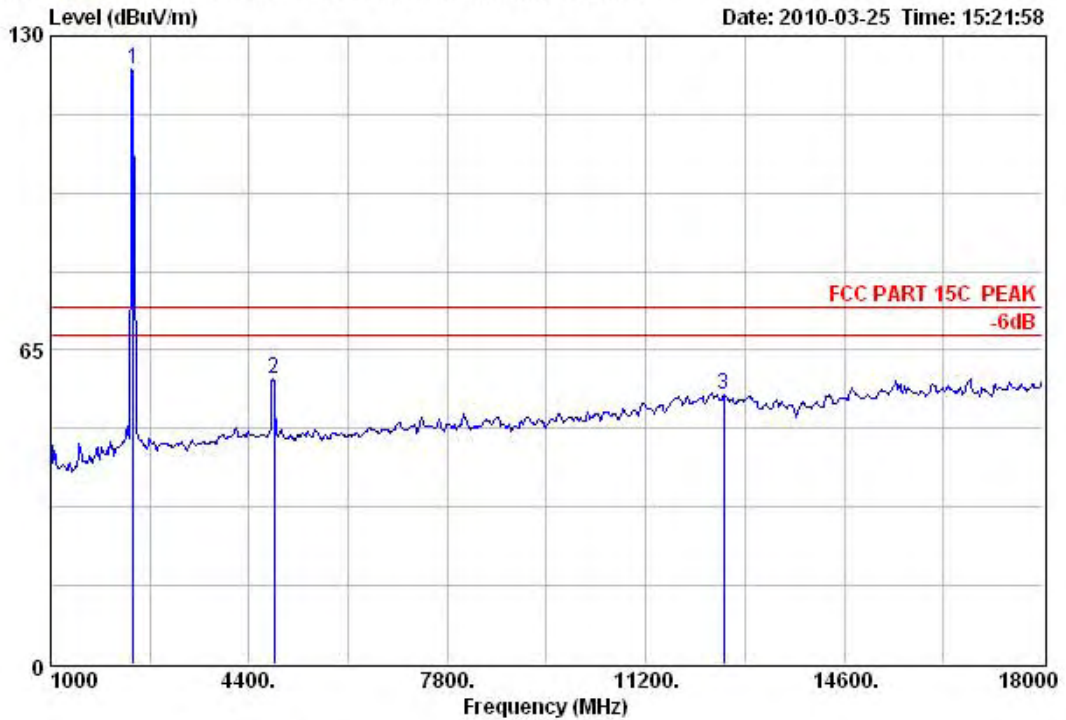

Test Site : 10m Chamber
 Limit : FCC PART 15C PEAK
 Dis. / Ant. : 3m 3117 Ant. Pol.: HORIZONTAL
 EUT : Wireless Router
 M/N : IP0494
 Power : DC 5V from adapter input AC 120V/60Hz
 Test Engineer : Jade
 Comment : Temp.:25.2'C Humi.:56% Press:101.51kPa
 Test Mode : TX Mode 802.11g CH1 2412MHz

Freq. (MHz)	Emission			Margin (dB)	Reading (dBuV)	Ant. Cable		Remark
	Level (dBuV/m)	Limits (dBuV/m)				Factor (dB/m)	Loss (dB)	
1 2412.00	123.15	74.00	-49.15	89.42	31.50	2.23	Peak	
2 4824.00	58.94	74.00	15.06	21.97	34.59	2.38	Peak	
3 12543.00	55.84	74.00	18.16	12.96	40.03	2.85	Peak	



NS Technology

Chenwu Industrial Zone, Houjie Town,
Dongguan, Guangdong, China
Tel: +86-769-85935656
Fax: +86-769-85991080

Data: 176

File: D:\Radiation data\Z\ZIONCOM1.EMI (303)

Date: 2010-03-25 Time: 15:26:05

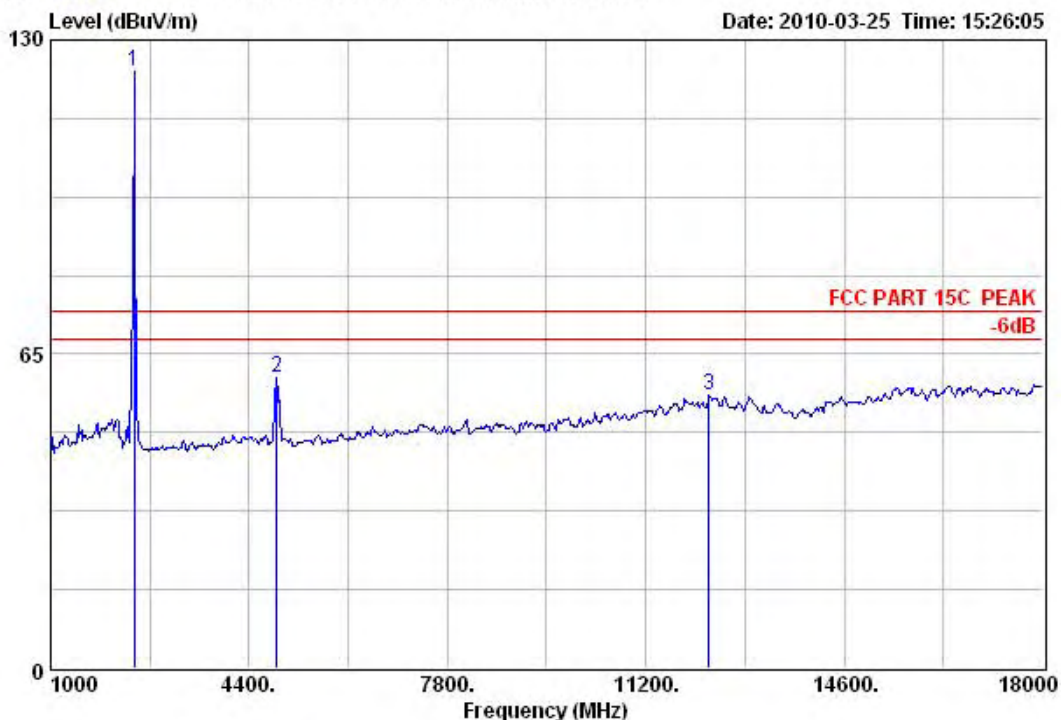

```

Test Site      : 10m Chamber
Limit         : FCC PART 15C PEAK
Dis. / Ant.   : 3m 3117           Ant. Pol.: HORIZONTAL
EUT          : Wireless Router
M/N          : IP0494
Power        : DC 5V from adapter input AC 120V/60Hz
Test Engineer: Jade
Comment      : Temp.:25.2'C Humi.:56% Press:101.51kPa
Test Mode    : TX Mode 802.11g CH6 2437MHz
    
```

Freq. (MHz)	Emission			Margin (dB)	Reading (dBuV)	Ant. Factor (dB/m)	Cable Loss (dB)	Remark
	Level (dBuV/m)	Limits (dBuV/m)						
1 2437.00	123.63	74.00	-49.63	89.86	31.54	2.23	Peak	
2 4874.00	60.03	74.00	13.97	23.03	34.62	2.38	Peak	
3 13228.00	56.41	74.00	17.59	13.65	39.92	2.84	Peak	



NS Technology

Chenwu Industrial Zone, Houjie Town,
Dongguan, Guangdong, China
Tel: +86-769-85935656
Fax: +86-769-85991080

Data: 177

File: D:\Radiation data\Z\ZIONCOM1.EMI (303)

Date: 2010-03-25 Time: 15:29:01

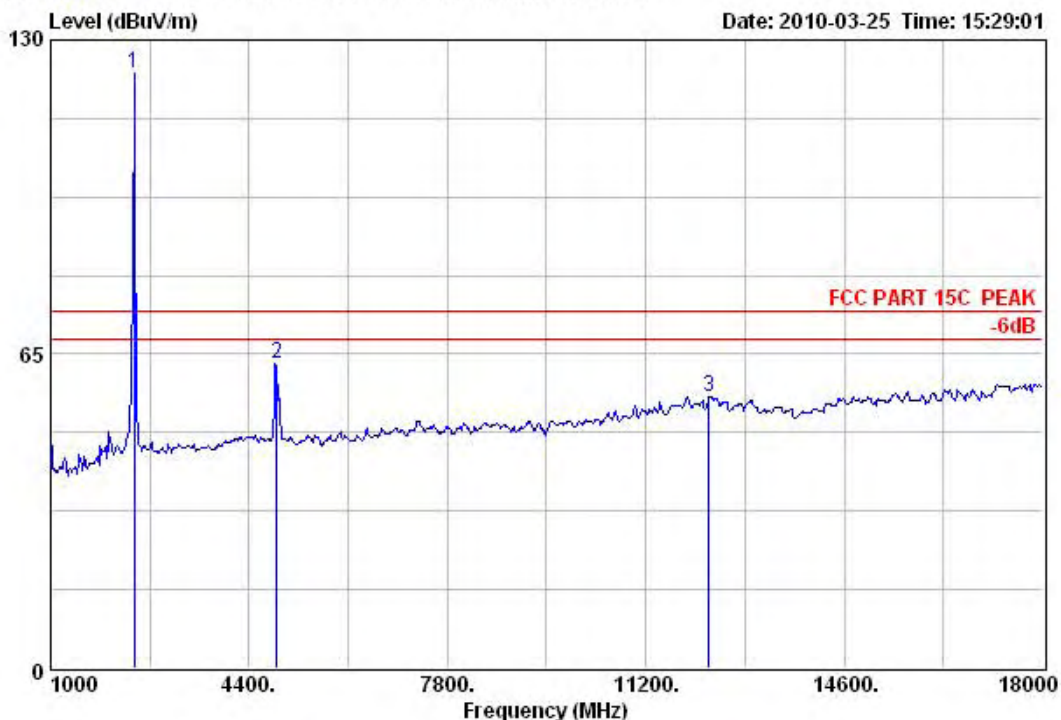

Test Site : 10m Chamber
 Limit : FCC PART 15C PEAK
 Dis. / Ant. : 3m 3117 Ant. Pol.: VERTICAL
 EUT : Wireless Router
 M/N : IP0494
 Power : DC 5V from adapter input AC 120V/60Hz
 Test Engineer : Jade
 Comment : Temp.:25.2'C Humi.:56% Press:101.51kPa
 Test Mode : TX Mode 802.11g CH6 2437MHz

Freq. (MHz)	Emission			Margin (dB)	Reading (dBuV)	Ant. Cable		Remark
	Level (dBuV/m)	Limits (dBuV/m)				Factor (dB/m)	Loss (dB)	
1 2437.00	123.20	74.00	-49.20	89.43	31.54	2.23	Peak	
2 4874.00	63.09	74.00	10.91	26.09	34.62	2.38	Peak	
3 31228.00	56.12	74.00	17.88	13.36	39.92	2.84	Peak	



NS Technology

Chenwu Industrial Zone, Houjie Town,
Dongguan, Guangdong, China
Tel: +86-769-85935656
Fax: +86-769-85991080

Data: 178

File: D:\Radiation data\Z\ZIONCOM1.EMI (303)

Date: 2010-03-25 Time: 15:33:03

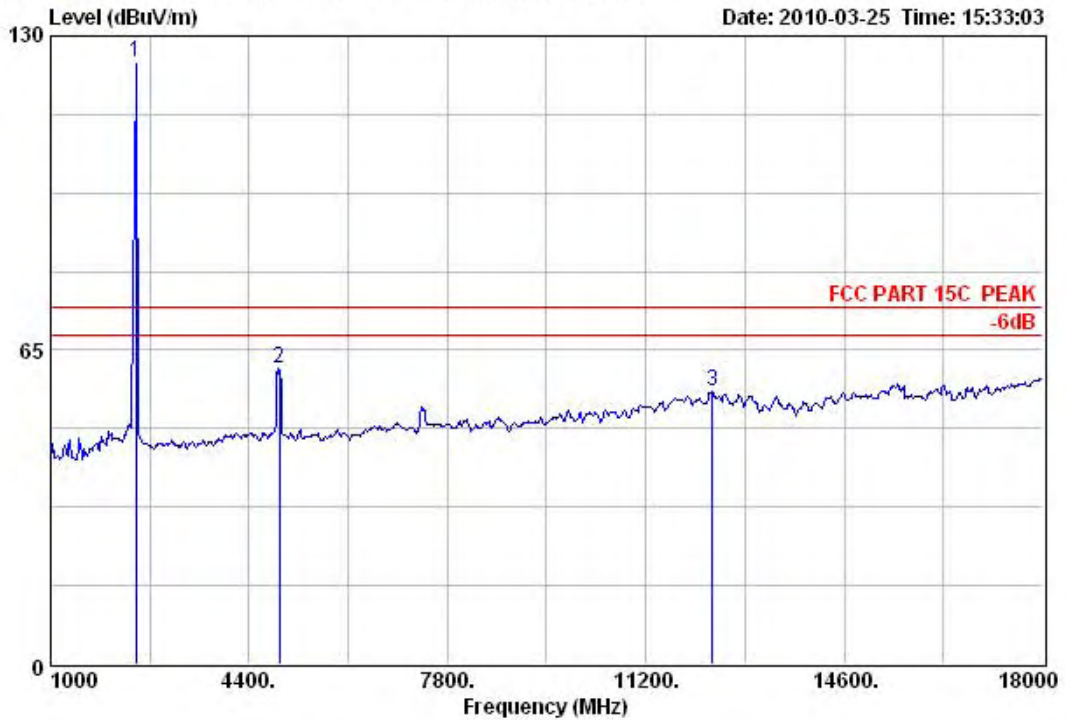

```

Test Site      : 10m Chamber
Limit         : FCC PART 15C PEAK
Dis. / Ant.   : 3m 3117           Ant. Pol.: VERTICAL
EUT          : Wireless Router
M/N          : IP0494
Power        : DC 5V from adapter input AC 120V/60Hz
Test Engineer : Jade
Comment      : Temp.:25.2'C Humi.:56% Press:101.51kPa
Test Mode    : TX Mode 802.11g CH11 2462MHz
    
```

Freq. (MHz)	Emission		Margin (dB)	Reading (dBuV)	Ant. Cable		Remark
	Level (dBuV/m)	Limits (dBuV/m)			Factor (dB/m)	Loss (dB)	
1 2462.00	124.50	74.00	-50.50	90.71	31.56	2.23	Peak
2 4924.00	61.28	74.00	12.72	24.24	34.66	2.38	Peak
3 13239.00	56.62	74.00	17.38	13.84	39.94	2.84	Peak



NS Technology

Chenwu Industrial Zone, Houjie Town,
Dongguan, Guangdong, China
Tel: +86-769-85935656
Fax: +86-769-85991080

Data: 179

File: D:\Radiation data\Z\ZIONCOM1.EMI (303)

Date: 2010-03-25 Time: 15:34:56

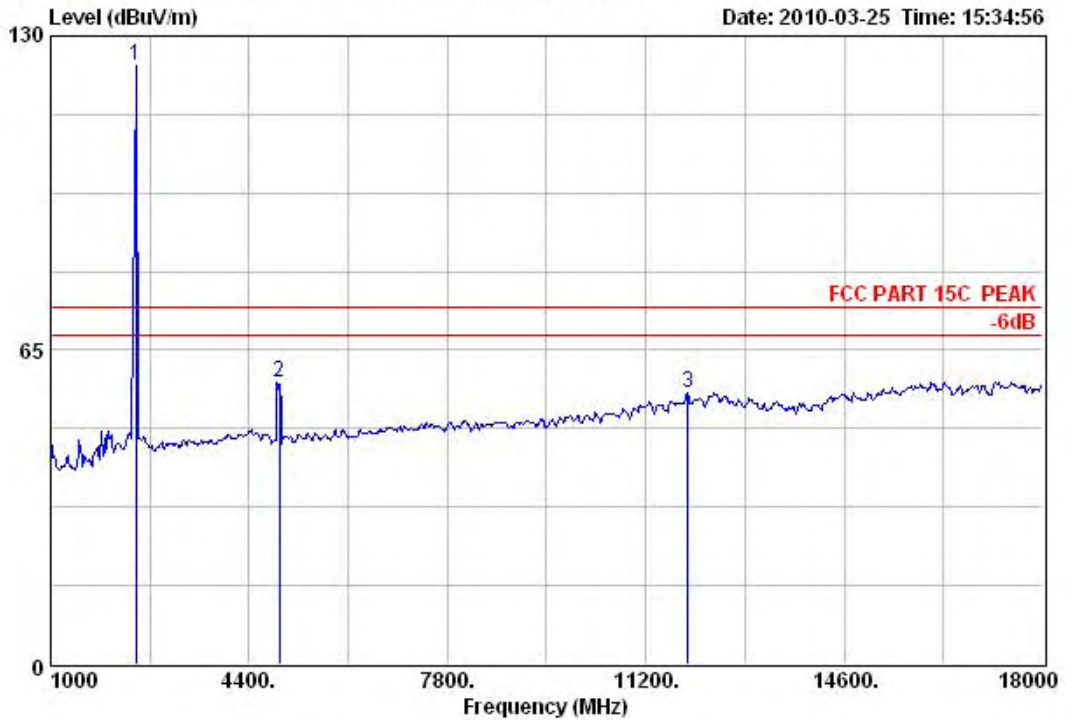

```

Test Site      : 10m Chamber
Limit         : FCC PART 15C PEAK
Dis. / Ant.   : 3m 3117           Ant. Pol.: HORIZONTAL
EUT          : Wireless Router
M/N          : IP0494
Power        : DC 5V from adapter input AC 120V/60Hz
Test Engineer: Jade
Comment      : Temp.:25.2'C Humi.:56% Press:101.51kPa
Test Mode    : TX Mode 802.11g CH11 2462MHz
    
```

Freq. (MHz)	Emission			Margin (dB)	Reading (dBuV)	Ant. Cable		Remark
	Level (dBuV/m)	Limits (dBuV/m)				Factor (dB/m)	Loss (dB)	
1 2462.00	123.67	74.00	-49.67	89.88	31.56	2.23	Peak	
2 4924.00	58.25	74.00	15.75	21.21	34.66	2.38	Peak	
3 11914.00	56.01	74.00	17.99	13.52	39.67	2.82	Peak	



NS Technology

Chenwu Industrial Zone, Houjie Town,
Dongguan, Guangdong, China
Tel: +86-769-85935656
Fax: +86-769-85991080

Data: 180

File: D:\Radiation data\Z\ZIONCOM1.EMI (303)

Date: 2010-03-25 Time: 15:37:59

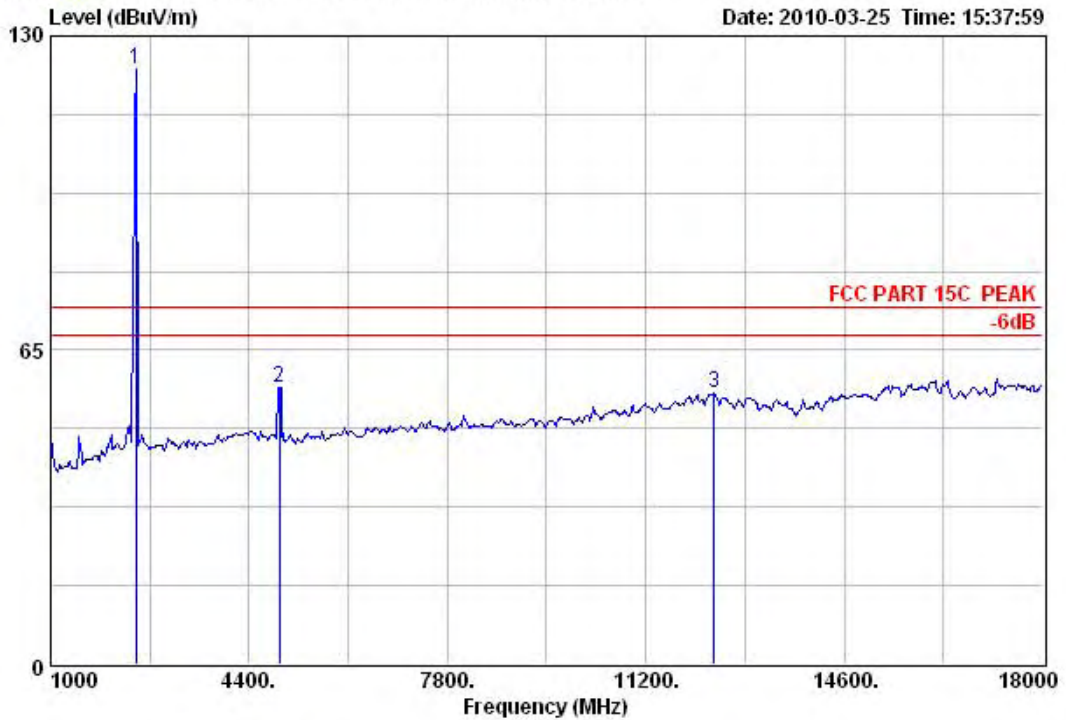

```

Test Site      : 10m Chamber
Limit         : FCC PART 15C PEAK
Dis. / Ant.   : 3m 3117           Ant. Pol.: HORIZONTAL
EUT          : Wireless Router
M/N          : IP0494
Power        : DC 5V from adapter input AC 120V/60Hz
Test Engineer: Jade
Comment      : Temp.:25.2'C Humi.:56% Press:101.51kPa
Test Mode    : TX Mode 802.11b CH11 2462MHz
    
```

Freq. (MHz)	Emission			Margin (dB)	Reading (dBuV)	Ant. Cable		Remark
	Level (dBuV/m)	Limits (dBuV/m)				Factor (dB/m)	Loss (dB)	
1 2462.00	123.00	74.00	-49.00	89.21	31.56	2.23	Peak	
2 4924.00	57.26	74.00	16.74	20.22	34.66	2.38	Peak	
3 13237.30	56.01	74.00	17.99	13.22	39.95	2.84	Peak	



NS Technology

Chenwu Industrial Zone, Houjie Town,
Dongguan, Guangdong, China
Tel: +86-769-85935656
Fax: +86-769-85991080

Data: 181

File: D:\Radiation data\Z\ZIONCOM1.EMI (303)

Date: 2010-03-25 Time: 15:43:05

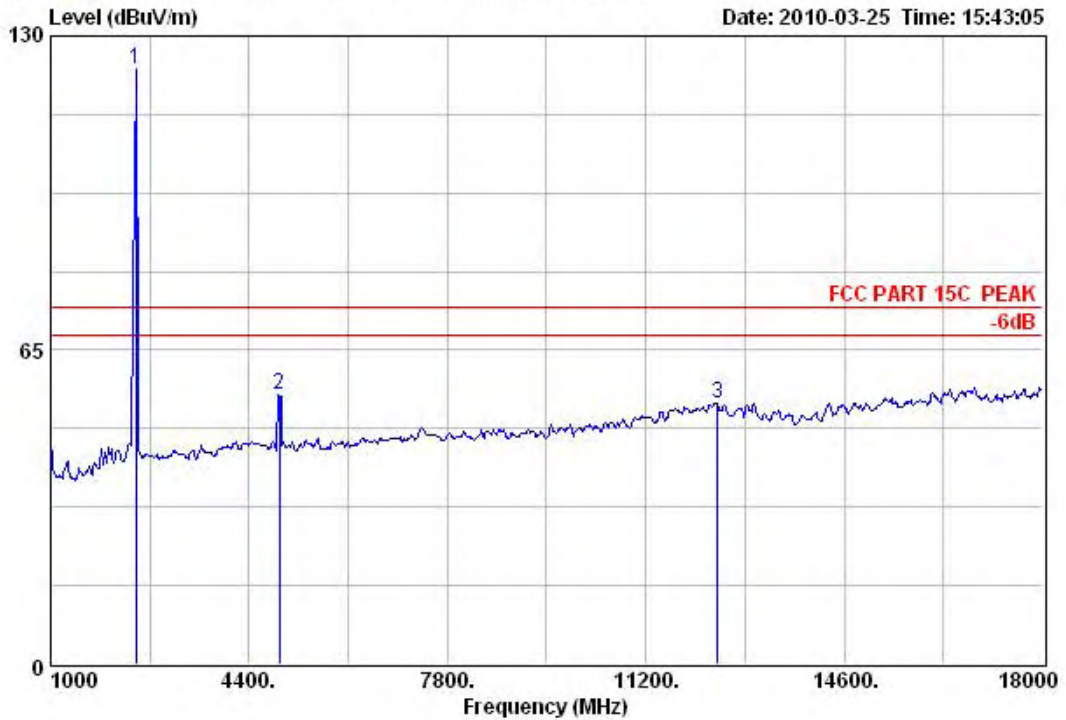

Test Site : 10m Chamber
 Limit : FCC PART 15C PEAK
 Dis. / Ant. : 3m 3117 Ant. Pol.: VERTICAL
 EUT : Wireless Router
 M/N : IP0494
 Power : DC 5V from adapter input AC 120V/60Hz
 Test Engineer : Jade
 Comment : Temp.:25.2'C Humi.:56% Press:101.51kPa
 Test Mode : TX Mode 802.11b CH11 2462MHz

Freq. (MHz)	Emission		Margin (dB)	Reading (dBuV)	Ant. Cable		Remark
	Level (dBuV/m)	Limits (dBuV/m)			Factor (dB/m)	Loss (dB)	
1 2462.00	123.02	74.00	-49.02	89.23	31.56	2.23	Peak
2 4924.00	55.83	74.00	18.17	18.79	34.66	2.38	Peak
3 12424.00	54.05	74.00	19.95	11.23	39.97	2.85	Peak



NS Technology

Chenwu Industrial Zone, Houjie Town,
Dongguan, Guangdong, China
Tel: +86-769-85935656
Fax: +86-769-85991080

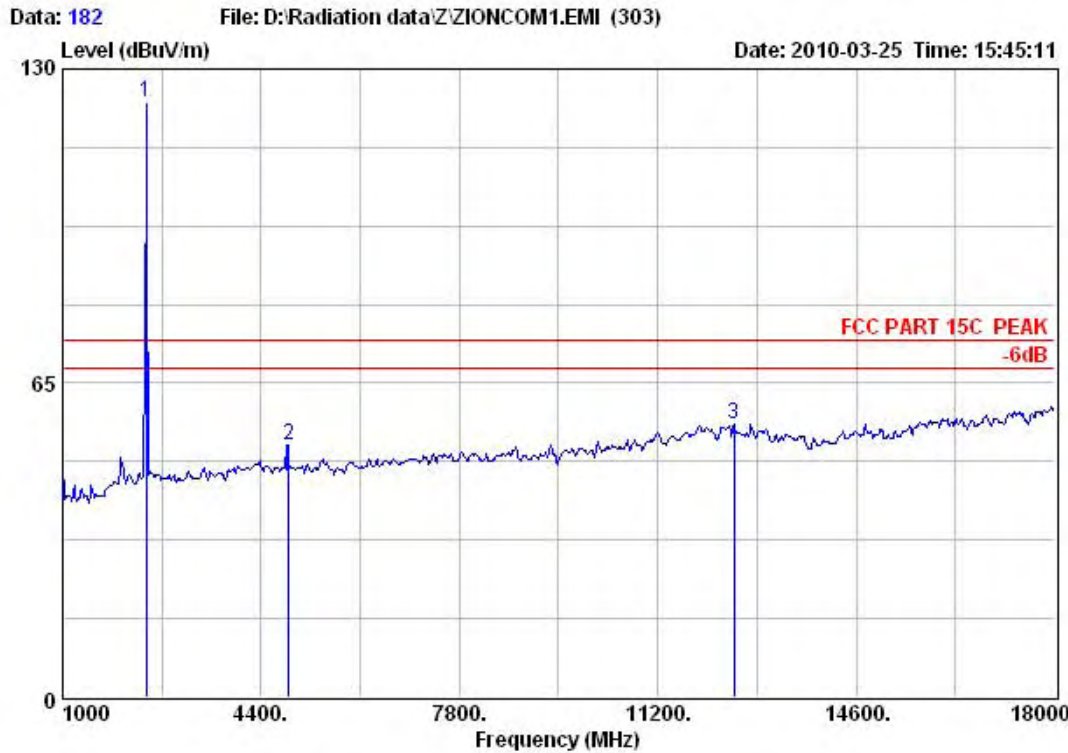

Test Site : 10m Chamber
 Limit : FCC PART 15C PEAK
 Dis. / Ant. : 3m 3117 Ant. Pol.: VERTICAL
 EUT : Wireless Router
 M/N : IP0494
 Power : DC 5V from adapter input AC 120V/60Hz
 Test Engineer : Jade
 Comment : Temp.:25.2'C Humi.:56% Press:101.51kPa
 Test Mode : TX Mode 802.11b CH6 2437MHz

Freq. (MHz)	Emission			Margin (dB)	Reading (dBuV)	Ant. Cable		Remark
	Level (dBuV/m)	Limits (dBuV/m)				Factor (dB/m)	Loss (dB)	
1 2437.00	123.06	74.00	-49.06	89.29	31.54	2.23	Peak	
2 4874.00	52.23	74.00	21.77	15.23	34.62	2.38	Peak	
3 12509.00	56.59	74.00	17.41	13.73	40.01	2.85	Peak	



NS Technology

Chenwu Industrial Zone, Houjie Town,
Dongguan, Guangdong, China
Tel: +86-769-85935656
Fax: +86-769-85991080

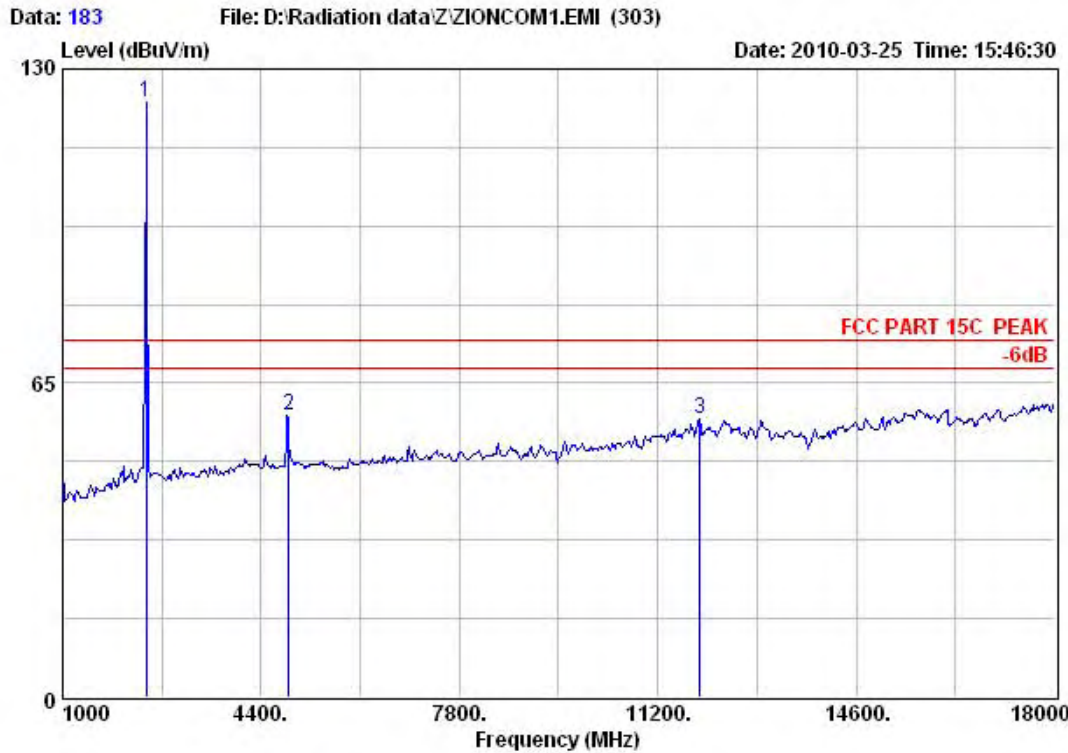

```

Test Site      : 10m Chamber
Limit         : FCC PART 15C PEAK
Dis. / Ant.   : 3m 3117           Ant. Pol.: HORIZONTAL
EUT          : Wireless Router
M/N          : IP0494
Power        : DC 5V from adapter input AC 120V/60Hz
Test Engineer : Jade
Comment      : Temp.:25.2'C Humi.:56% Press:101.51kPa
Test Mode    : TX Mode 802.11b CH6 2437MHz
    
```

Freq. (MHz)	Emission		Margin (dB)	Reading (dBuV)	Ant. Cable		Remark
	Level (dBuV/m)	Limits (dBuV/m)			Factor (dB/m)	Loss (dB)	
1 2437.00	123.22	74.00	-49.22	89.45	31.54	2.23	Peak
2 4874.00	58.25	74.00	15.75	21.25	34.62	2.38	Peak
311914.00	57.56	74.00	16.44	15.07	39.67	2.82	Peak



NS Technology

Chenwu Industrial Zone, Houjie Town,
Dongguan, Guangdong, China
Tel: +86-769-85935656
Fax: +86-769-85991080

Data: 184 File: D:\Radiation data\Z\ZIONCOM1.EMI (303)

Date: 2010-03-25 Time: 15:48:36

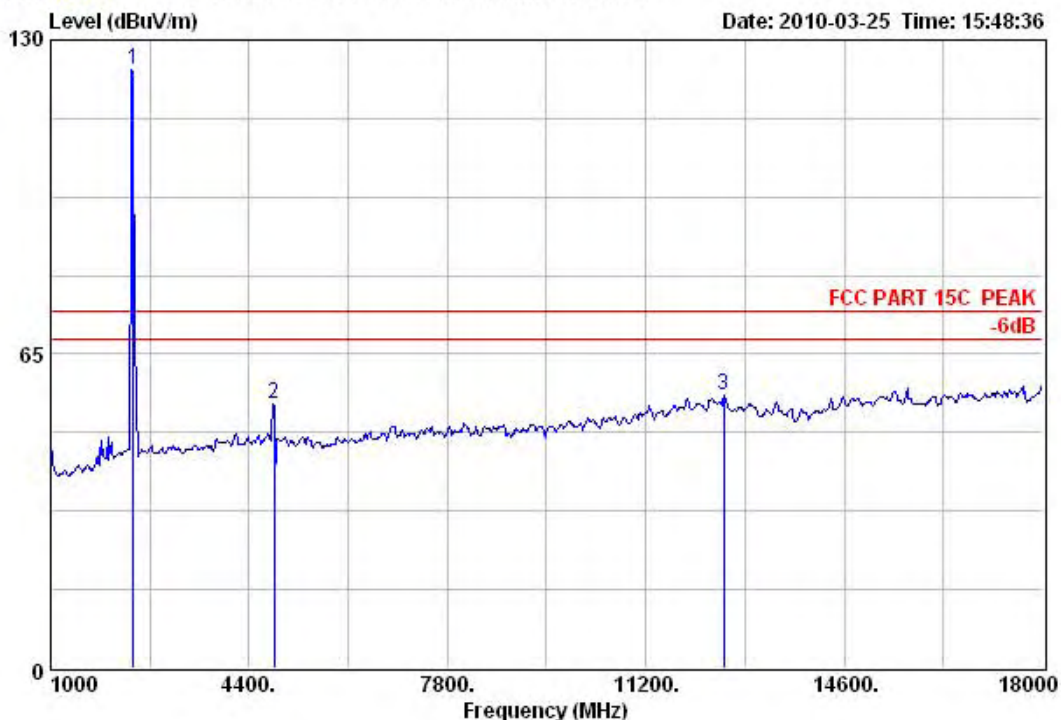

Test Site : 10m Chamber
 Limit : FCC PART 15C PEAK
 Dis. / Ant. : 3m 3117 Ant. Pol.: HORIZONTAL
 EUT : Wireless Router
 M/N : IP0494
 Power : DC 5V from adapter input AC 120V/60Hz
 Test Engineer : Jade
 Comment : Temp.:25.2'C Humi.:56% Press:101.51kPa
 Test Mode : TX Mode 802.11b CH1 2412MHz

Freq. (MHz)	Emission			Margin (dB)	Reading (dBuV)	Ant. Cable		Remark
	Level (dBuV/m)	Limits (dBuV/m)				Factor (dB/m)	Loss (dB)	
1 2412.00	123.72	74.00	-49.72	89.99	31.50	2.23	Peak	
2 4824.00	54.50	74.00	19.50	17.53	34.59	2.38	Peak	
3 132543.00	56.47	74.00	17.53	13.59	40.03	2.85	Peak	



NS Technology

Chenwu Industrial Zone, Houjie Town,
Dongguan, Guangdong, China
Tel: +86-769-85935656
Fax: +86-769-85991080

Data: 185

File: D:\Radiation data\Z\ZIONCOM1.EMI (303)

Date: 2010-03-25 Time: 15:50:00

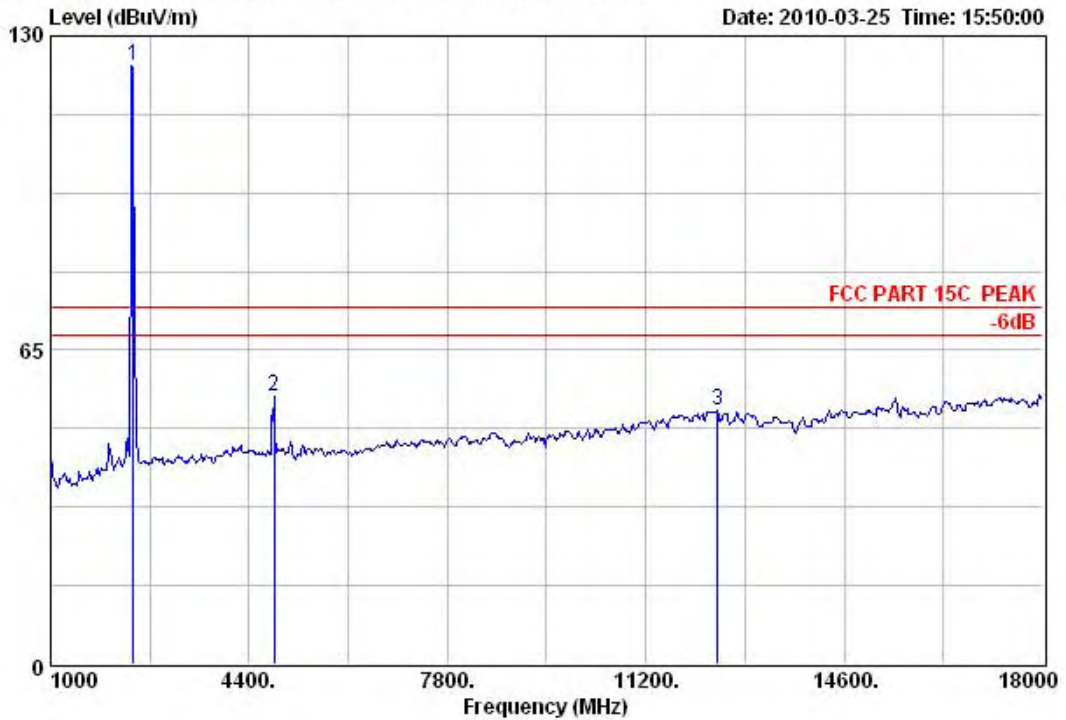

Test Site : 10m Chamber
 Limit : FCC PART 15C PEAK
 Dis. / Ant. : 3m 3117 Ant. Pol.: VERTICAL
 EUT : Wireless Router
 M/N : IP0494
 Power : DC 5V from adapter input AC 120V/60Hz
 Test Engineer : Jade
 Comment : Temp.:25.2'C Humi.:56% Press:101.51kPa
 Test Mode : TX Mode 802.11b CH1 2412MHz

Freq. (MHz)	Emission			Margin (dB)	Reading (dBuV)	Ant. Factor (dB/m)	Cable Loss (dB)	Remark
	Level (dBuV/m)	Limits (dBuV/m)						
1 2412.00	123.85	74.00	-49.85	90.12	31.50	2.23	Peak	
2 4824.00	55.25	74.00	18.75	18.28	34.59	2.38	Peak	
3 12424.00	52.43	74.00	21.57	9.61	39.97	2.85	Peak	



NS Technology

Chenwu Industrial Zone, Houjie Town,
Dongguan, Guangdong, China
Tel: +86-769-85935656
Fax: +86-769-85991080

Data: 186

File: D:\Radiation data\Z\ZIONCOM1.EMI (303)

Date: 2010-03-25 Time: 15:52:59

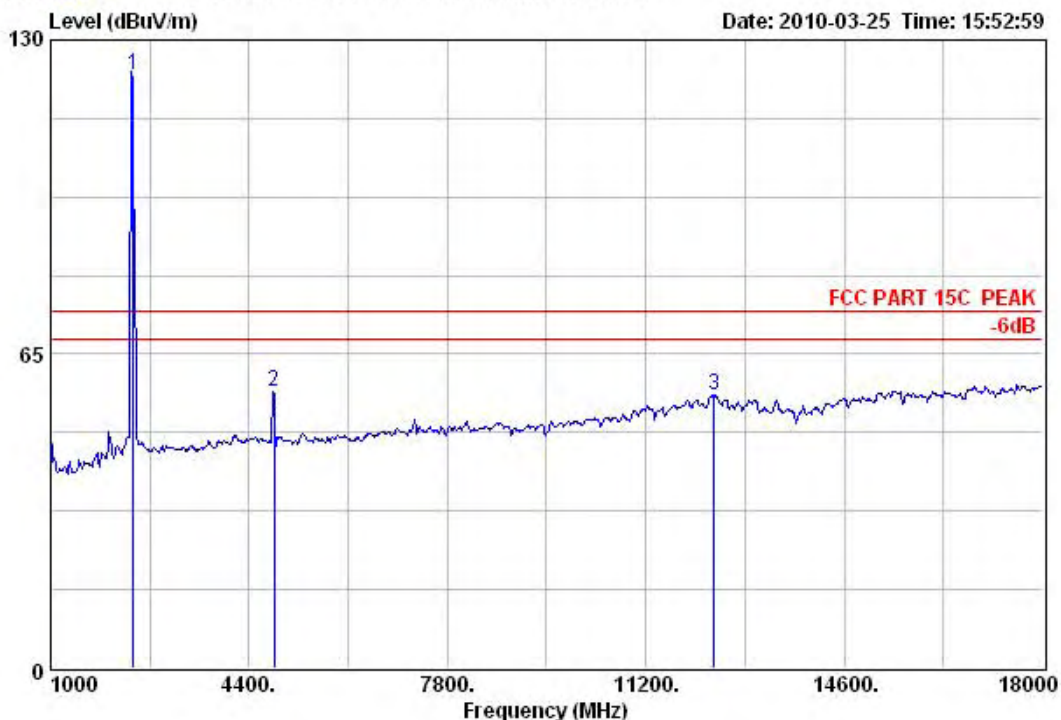

```

Test Site      : 10m Chamber
Limit         : FCC PART 15C PEAK
Dis. / Ant.   : 3m 3117           Ant. Pol.: VERTICAL
EUT          : Wireless Router
M/N          : IP0494
Power        : DC 5V from adapter input AC 120V/60Hz
Test Engineer : Jade
Comment      : Temp.:25.2'C Humi.:56% Press:101.51kPa
Test Mode    : TX Mode 802.11n HT20 CH1 2412MHz
    
```

Freq. (MHz)	Emission			Reading (dBuV)	Ant. Factor (dB/m)	Cable Loss (dB)	Remark
	Level (dBuV/m)	Limits (dBuV/m)	Margin (dB)				
1 2412.00	122.65	74.00	-48.65	88.92	31.50	2.23	Peak
2 4824.00	57.25	74.00	16.75	20.28	34.59	2.38	Peak
3 13237.30	56.53	74.00	17.47	13.74	39.95	2.84	Peak



NS Technology

Chenwu Industrial Zone, Houjie Town,
Dongguan, Guangdong, China
Tel: +86-769-85935656
Fax: +86-769-85991080

Data: 187

File: D:\Radiation data\Z\ZIONCOM1.EMI (303)

Date: 2010-03-25 Time: 15:56:58

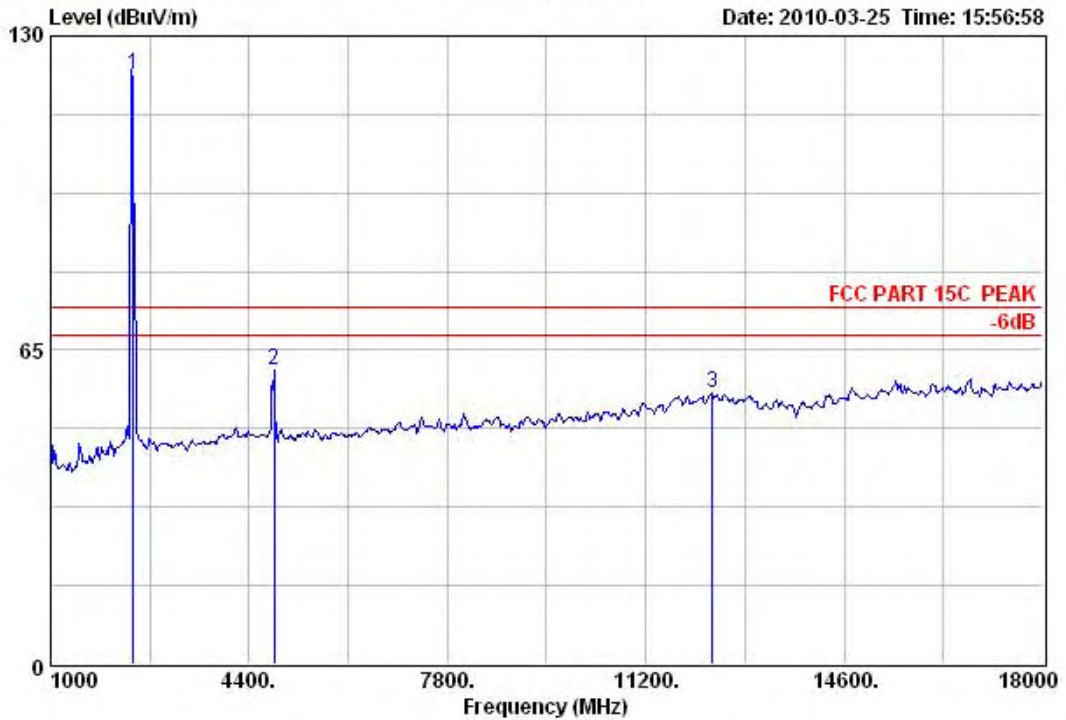

Test Site : 10m Chamber
 Limit : FCC PART 15C PEAK
 Dis. / Ant. : 3m 3117 Ant. Pol.: HORIZONTAL
 EUT : Wireless Router
 M/N : IP0494
 Power : DC 5V from adapter input AC 120V/60Hz
 Test Engineer : Jade
 Comment : Temp.:25.2'C Humi.:56% Press:101.51kPa
 Test Mode : TX Mode 802.11n HT20 CH1 2412MHz

Freq. (MHz)	Emission			Margin (dB)	Reading (dBuV)	Ant. Cable		Remark
	Level (dBuV/m)	Limits (dBuV/m)				Factor (dB/m)	Loss (dB)	
1 2412.00	122.15	74.00	-48.15	88.42	31.50	2.23	Peak	
2 4824.00	60.82	74.00	13.18	23.85	34.59	2.38	Peak	
3 12339.00	56.01	74.00	17.99	13.23	39.94	2.84	Peak	



NS Technology

Chenwu Industrial Zone, Houjie Town,
Dongguan, Guangdong, China
Tel: +86-769-85935656
Fax: +86-769-85991080

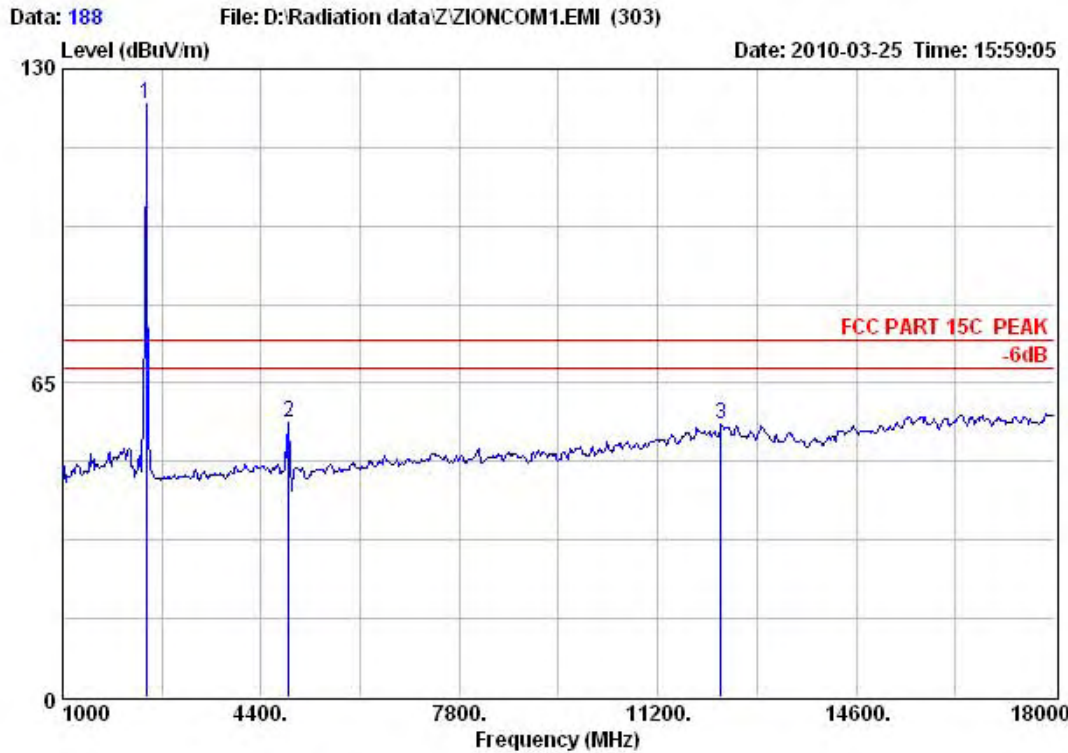

```

Test Site      : 10m Chamber
Limit         : FCC PART 15C PEAK
Dis. / Ant.   : 3m 3117           Ant. Pol.: HORIZONTAL
EUT          : Wireless Router
M/N          : IP0494
Power        : DC 5V from adapter input AC 120V/60Hz
Test Engineer: Jade
Comment      : Temp.:25.2'C Humi.:56% Press:101.51kPa
Test Mode    : TX Mode 802.11n HT20 CH6 2437MHz
    
```

Freq. (MHz)	Emission			Reading (dBuV)	Ant. Factor (dB/m)	Cable Loss (dB)	Remark
	Level (dBuV/m)	Limits (dBuV/m)	Margin (dB)				
1 2437.00	122.63	74.00	-48.63	88.86	31.54	2.23	Peak
2 4874.00	57.03	74.00	16.97	20.03	34.62	2.38	Peak
312288.00	56.41	74.00	17.59	13.65	39.92	2.84	Peak



NS Technology

Chenwu Industrial Zone, Houjie Town,
Dongguan, Guangdong, China
Tel: +86-769-85935656
Fax: +86-769-85991080

Data: 189

File: D:\Radiation data\Z\ZIONCOM1.EMI (303)

Date: 2010-03-25 Time: 16:02:01

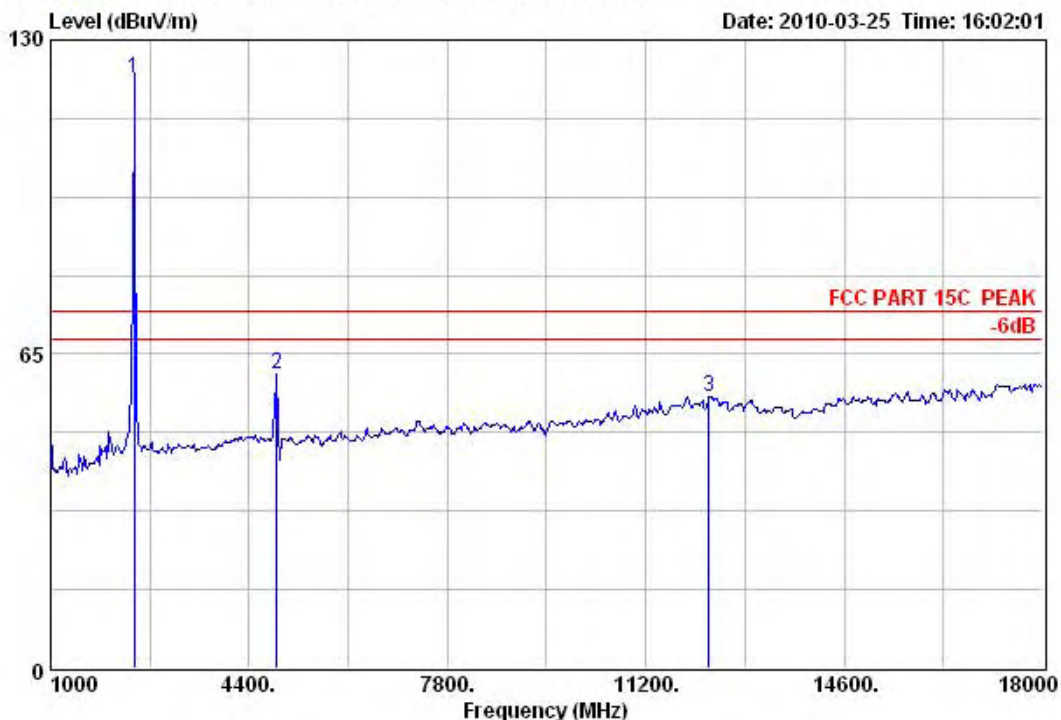

Test Site : 10m Chamber
 Limit : FCC PART 15C PEAK
 Dis. / Ant. : 3m 3117 Ant. Pol.: VERTICAL
 EUT : Wireless Router
 M/N : IP0494
 Power : DC 5V from adapter input AC 120V/60Hz
 Test Engineer : Jade
 Comment : Temp.:25.2'C Humi.:56% Press:101.51kPa
 Test Mode : TX Mode 802.11n HT20 CH6 2437MHz

Freq. (MHz)	Emission		Margin (dB)	Reading (dBuV)	Ant. Cable		Remark
	Level (dBuV/m)	Limits (dBuV/m)			Factor (dB/m)	Loss (dB)	
1 2437.00	122.20	74.00	-48.20	88.43	31.54	2.23	Peak
2 4874.00	60.66	74.00	13.34	23.66	34.62	2.38	Peak
3 31228.00	56.12	74.00	17.88	13.36	39.92	2.84	Peak



NS Technology

Chenwu Industrial Zone, Houjie Town,
Dongguan, Guangdong, China
Tel: +86-769-85935656
Fax: +86-769-85991080

Data: 190

File: D:\Radiation data\Z\ZIONCOM1.EMI (303)

Date: 2010-03-25 Time: 16:05:03

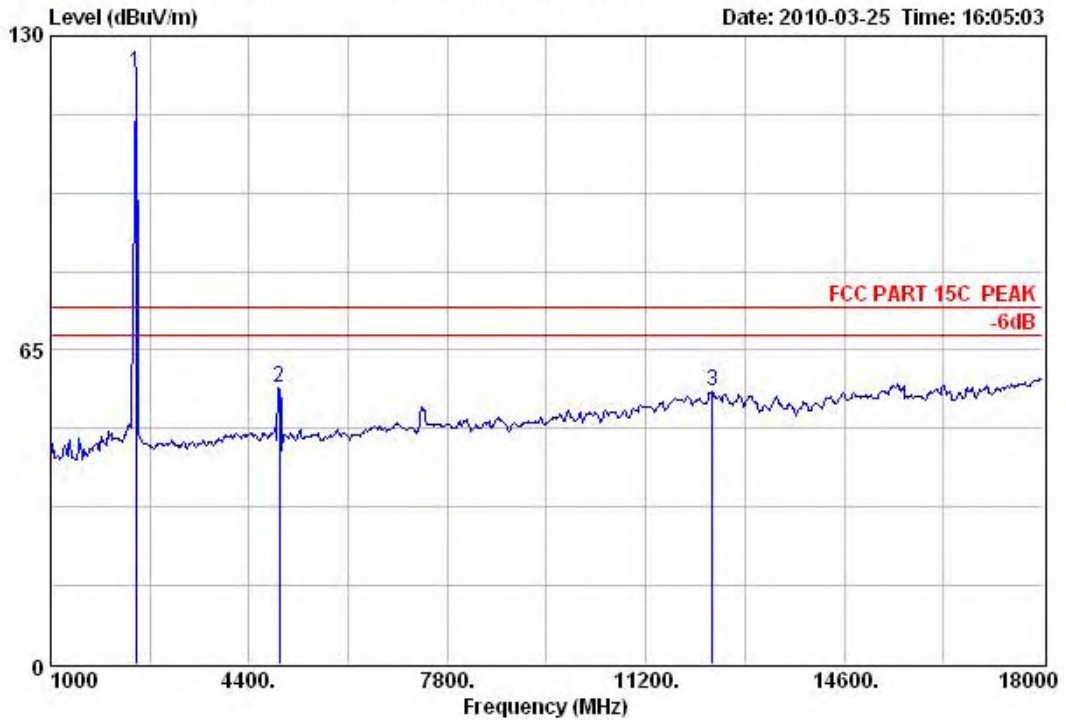

Test Site : 10m Chamber
 Limit : FCC PART 15C PEAK
 Dis. / Ant. : 3m 3117 Ant. Pol.: VERTICAL
 EUT : Wireless Router
 M/N : IP0494
 Power : DC 5V from adapter input AC 120V/60Hz
 Test Engineer : Jade
 Comment : Temp.:25.2'C Humi.:56% Press:101.51kPa
 Test Mode : TX Mode 802.11n HT20 CH11 2462MHz

Freq. (MHz)	Emission		Margin (dB)	Reading (dBuV)	Ant. Cable		Remark
	Level (dBuV/m)	Limits (dBuV/m)			Factor (dB/m)	Loss (dB)	
1 2462.00	122.50	74.00	-48.50	88.71	31.56	2.23	Peak
2 4924.00	57.28	74.00	16.72	20.24	34.66	2.38	Peak
3 13239.00	56.62	74.00	17.38	13.84	39.94	2.84	Peak



NS Technology

Chenwu Industrial Zone, Houjie Town,
Dongguan, Guangdong, China
Tel: +86-769-85935656
Fax: +86-769-85991080

Data: 191

File: D:\Radiation data\Z\ZIONCOM1.EMI (303)

Date: 2010-03-25 Time: 15:34:56

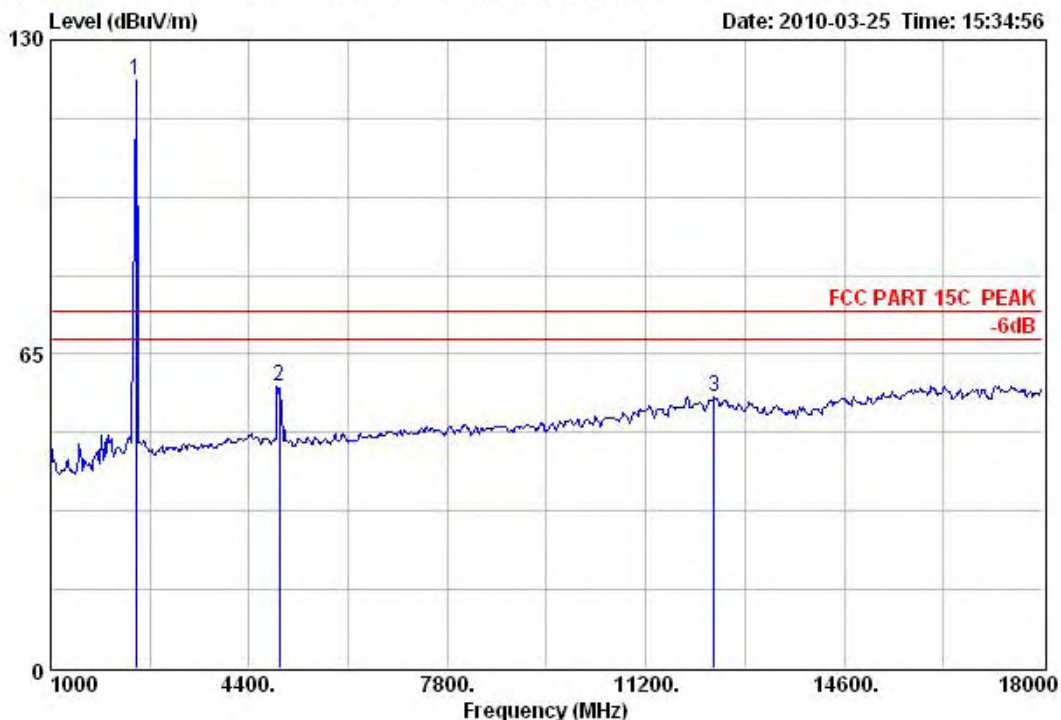

Test Site : 10m Chamber
 Limit : FCC PART 15C PEAK
 Dis. / Ant. : 3m 3117 Ant. Pol.: HORIZONTAL
 EUT : Wireless Router
 M/N : IP0494
 Power : DC 5V from adapter input AC 120V/60Hz
 Test Engineer : Jade
 Comment : Temp.:25.2'C Humi.:56% Press:101.51kPa
 Test Mode : TX Mode 802.11n HT20 CH11 2462MHz

Freq. (MHz)	Emission			Margin (dB)	Reading (dBuV)	Ant. Cable		Remark
	Level (dBuV/m)	Limits (dBuV/m)				Factor (dB/m)	Loss (dB)	
1 2462.00	121.67	74.00	-47.67	87.88	31.56	2.23	Peak	
2 4924.00	58.25	74.00	15.75	21.21	34.66	2.38	Peak	
3 13237.30	56.02	74.00	17.98	13.23	39.95	2.84	Peak	



NS Technology

Chenwu Industrial Zone, Houjie Town,
Dongguan, Guangdong, China
Tel: +86-769-85935656
Fax: +86-769-85991080

Data: 192

File: D:\Radiation data\Z\ZIONCOM1.EMI (303)

Date: 2010-03-25 Time: 16:08:59

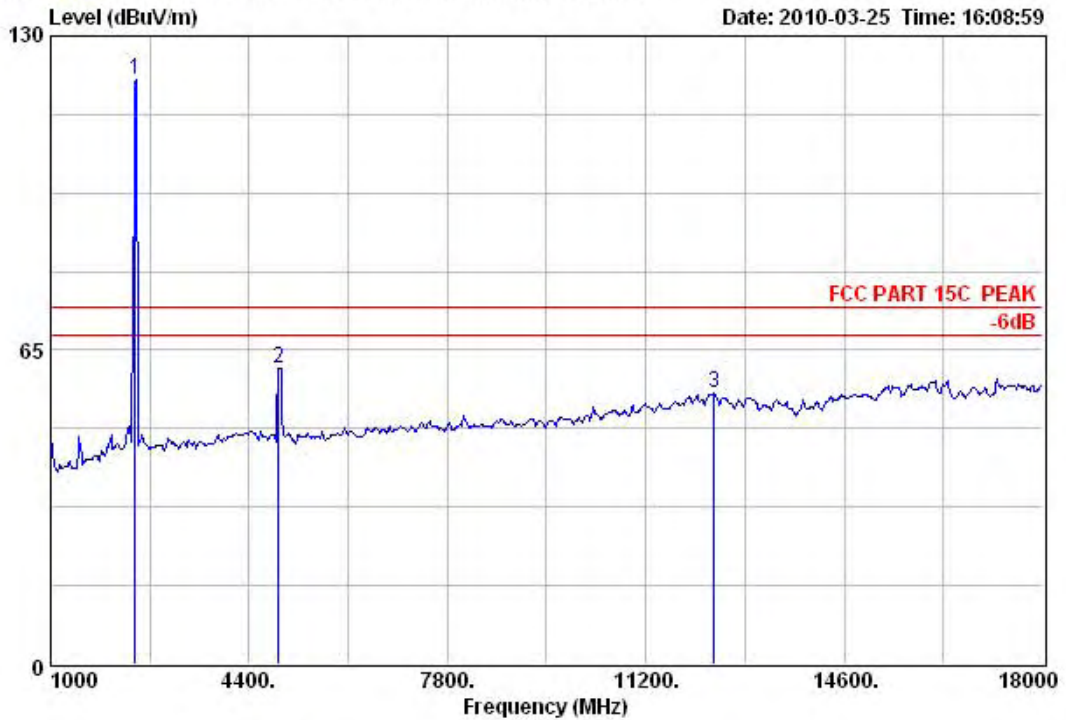

```

Test Site      : 10m Chamber
Limit         : FCC PART 15C PEAK
Dis. / Ant.   : 3m 3117           Ant. Pol.: HORIZONTAL
EUT          : Wireless Router
M/N          : IP0494
Power        : DC 5V from adapter input AC 120V/60Hz
Test Engineer : Jade
Comment      : Temp.:25.2'C Humi.:56% Press:101.51kPa
Test Mode    : TX Mode 802.11n HT40 CH7 2452MHz
    
```

Freq. (MHz)	Emission		Margin (dB)	Reading (dBuV)	Ant. Cable		Remark
	Level (dBuV/m)	Limits (dBuV/m)			Factor (dB/m)	Loss (dB)	
1 2452.00	121.00	74.00	-47.00	87.23	31.54	2.23	Peak
2 4904.00	61.26	74.00	12.74	24.25	34.63	2.38	Peak
3 13237.30	56.01	74.00	17.99	13.22	39.95	2.84	Peak



NS Technology

Chenwu Industrial Zone, Houjie Town,
Dongguan, Guangdong, China
Tel: +86-769-85935656
Fax: +86-769-85991080

Data: 193

File: D:\Radiation data\Z\ZIONCOM1.EMI (303)

Date: 2010-03-25 Time: 16:11:05

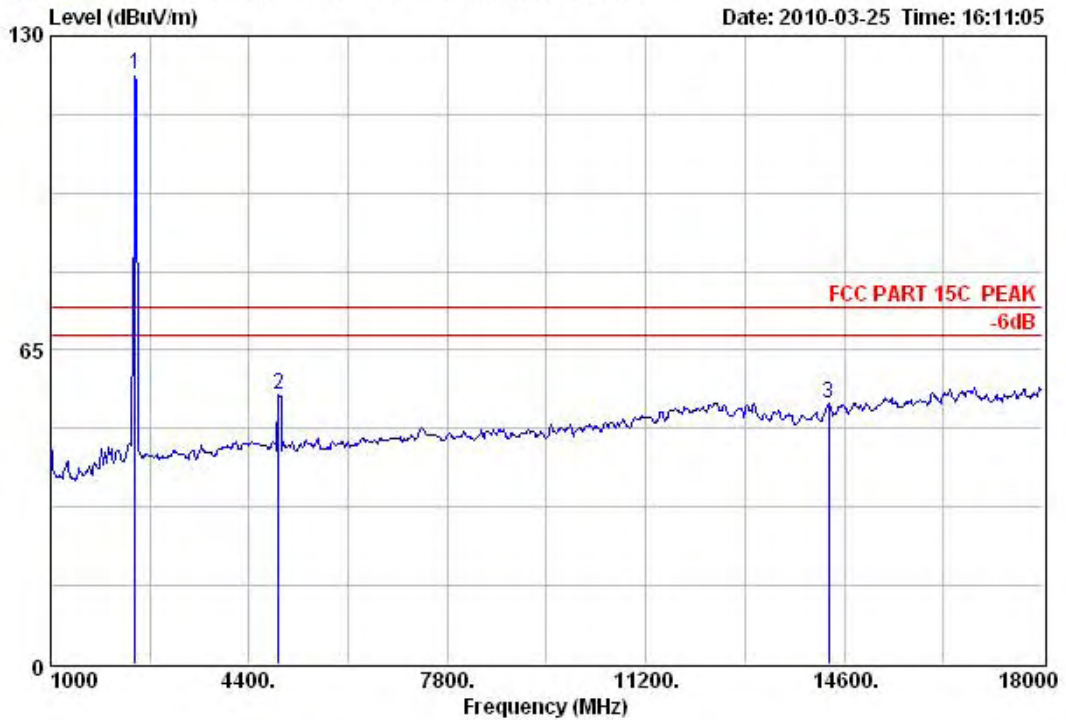

Test Site : 10m Chamber
 Limit : FCC PART 15C PEAK
 Dis. / Ant. : 3m 3117 Ant. Pol.: VERTICAL
 EUT : Wireless Router
 M/N : IP0494
 Power : DC 5V from adapter input AC 120V/60Hz
 Test Engineer : Jade
 Comment : Temp.:25.2'C Humi.:56% Press:101.51kPa
 Test Mode : TX Mode 802.11n HT40 CH7 2452MHz

Freq. (MHz)	Emission		Margin (dB)	Reading (dBuV)	Ant. Cable		Remark
	Level (dBuV/m)	Limits (dBuV/m)			Factor (dB/m)	Loss (dB)	
1 2452.00	122.02	74.00	-48.02	88.25	31.54	2.23	Peak
2 4904.00	55.83	74.00	18.17	18.82	34.63	2.38	Peak
3 14328.00	54.06	74.00	19.94	10.68	40.42	2.96	Peak



NS Technology

Chenwu Industrial Zone, Houjie Town,
Dongguan, Guangdong, China
Tel: +86-769-85935656
Fax: +86-769-85991080

Data: 194

File: D:\Radiation data\Z\ZIONCOM1.EMI (303)

Date: 2010-03-25 Time: 16:14:11

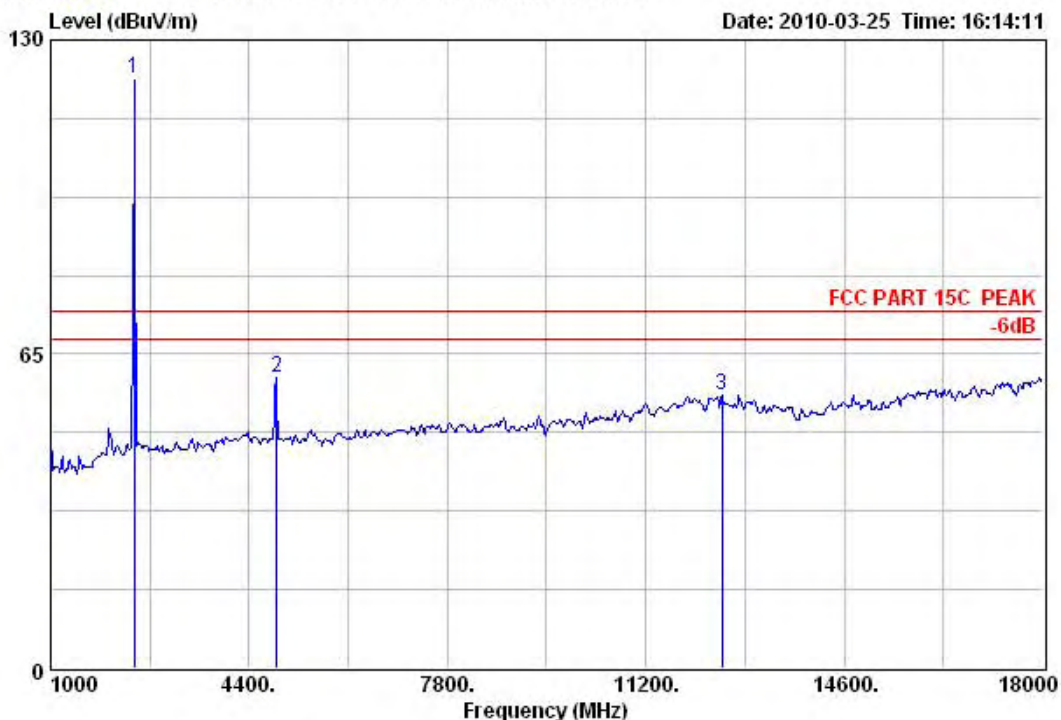

Test Site : 10m Chamber
 Limit : FCC PART 15C PEAK
 Dis. / Ant. : 3m 3117 Ant. Pol.: VERTICAL
 EUT : Wireless Router
 M/N : IP0494
 Power : DC 5V from adapter input AC 120V/60Hz
 Test Engineer : Jade
 Comment : Temp.:25.2'C Humi.:56% Press:101.51kPa
 Test Mode : TX Mode 802.11n HT40 CH4 2437MHz

Freq. (MHz)	Emission		Margin (dB)	Reading (dBuV)	Ant. Cable		Remark
	Level (dBuV/m)	Limits (dBuV/m)			Factor (dB/m)	Loss (dB)	
1 2437.00	122.06	74.00	-48.06	88.29	31.54	2.23	Peak
2 4874.00	60.07	74.00	13.93	23.07	34.62	2.38	Peak
3 13259.00	56.59	74.00	17.41	13.73	40.01	2.85	Peak



NS Technology

Chenwu Industrial Zone, Houjie Town,
Dongguan, Guangdong, China
Tel: +86-769-85935656
Fax: +86-769-85991080

Data: 195

File: D:\Radiation data\Z\ZIONCOM1.EMI (303)

Date: 2010-03-25 Time: 16:17:30

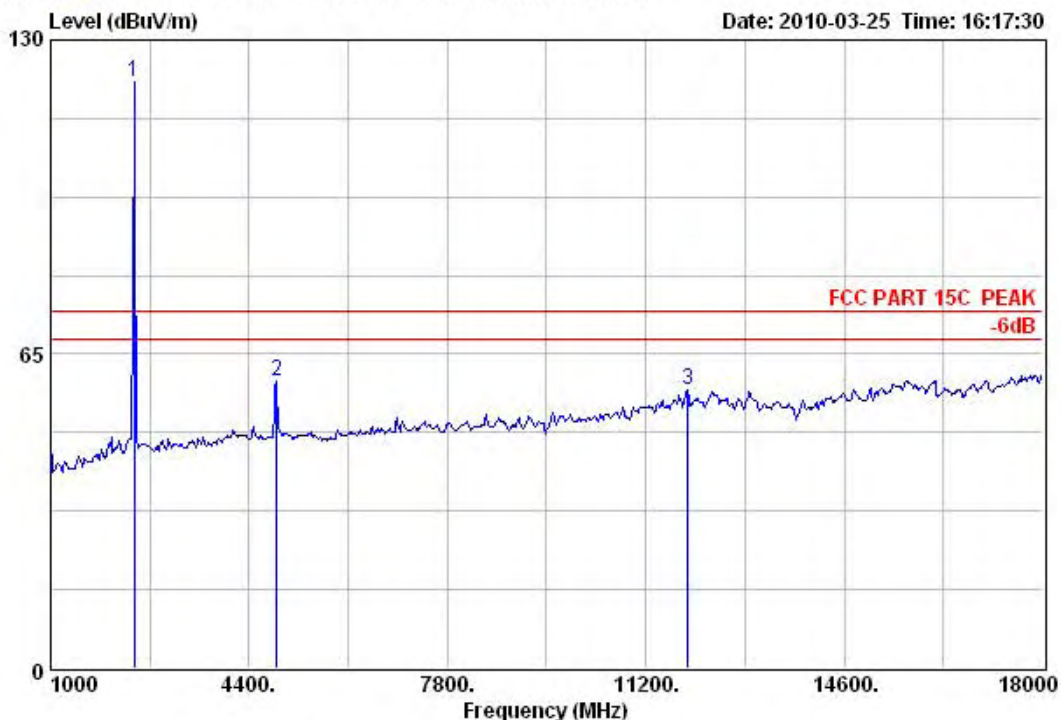

```

Test Site      : 10m Chamber
Limit         : FCC PART 15C PEAK
Dis. / Ant.   : 3m 3117           Ant. Pol.: HORIZONTAL
EUT          : Wireless Router
M/N          : IP0494
Power        : DC 5V from adapter input AC 120V/60Hz
Test Engineer : Jade
Comment      : Temp.:25.2'C Humi.:56% Press:101.51kPa
Test Mode    : TX Mode 802.11n HT40 CH4 2437MHz
    
```

Freq. (MHz)	Emission			Margin (dB)	Reading (dBuV)	Ant. Cable		Remark
	Level (dBuV/m)	Limits (dBuV/m)				Factor (dB/m)	Loss (dB)	
1 2437.00	121.22	74.00	-47.22	87.45	31.54	2.23	Peak	
2 4874.00	59.52	74.00	14.48	22.52	34.62	2.38	Peak	
3 11191.00	57.56	74.00	16.44	15.07	39.67	2.82	Peak	



NS Technology

Chenwu Industrial Zone, Houjie Town,
Dongguan, Guangdong, China
Tel: +86-769-85935656
Fax: +86-769-85991080

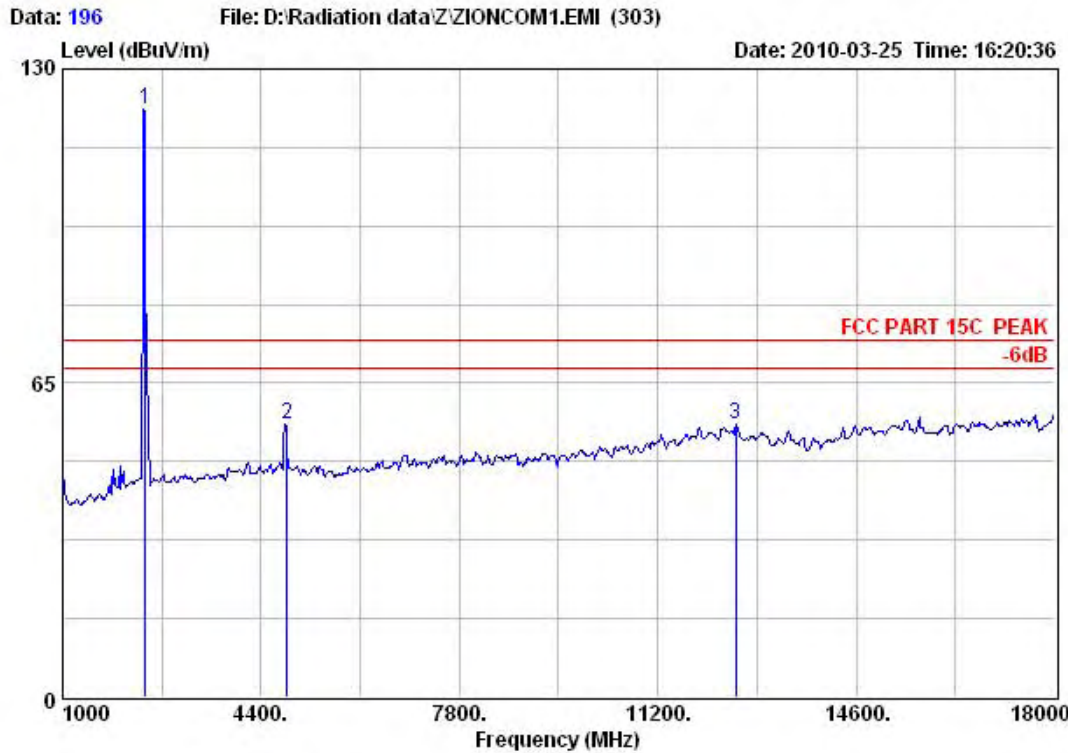

```

Test Site      : 10m Chamber
Limit         : FCC PART 15C PEAK
Dis. / Ant.   : 3m 3117           Ant. Pol.: HORIZONTAL
EUT          : Wireless Router
M/N          : IP0494
Power        : DC 5V from adapter input AC 120V/60Hz
Test Engineer : Jade
Comment      : Temp.:25.2'C Humi.:56% Press:101.51kPa
Test Mode    : TX Mode 802.11n HT40 CH1 2422MHz
    
```

Freq. (MHz)	Emission			Margin (dB)	Reading (dBuV)	Ant. Cable		Remark
	Level (dBuV/m)	Limits (dBuV/m)				Factor (dB/m)	Loss (dB)	
1 2422.00	121.72	74.00	-47.72	87.97	31.52	2.23	Peak	
2 4844.00	56.50	74.00	17.50	19.52	34.60	2.38	Peak	
3 12543.00	56.47	74.00	17.53	13.59	40.03	2.85	Peak	



NS Technology

Chenwu Industrial Zone, Houjie Town,
Dongguan, Guangdong, China
Tel: +86-769-85935656
Fax: +86-769-85991080

Data: 197

File: D:\Radiation data\Z\ZIONCOM1.EMI (303)

Date: 2010-03-25 Time: 16:23:00

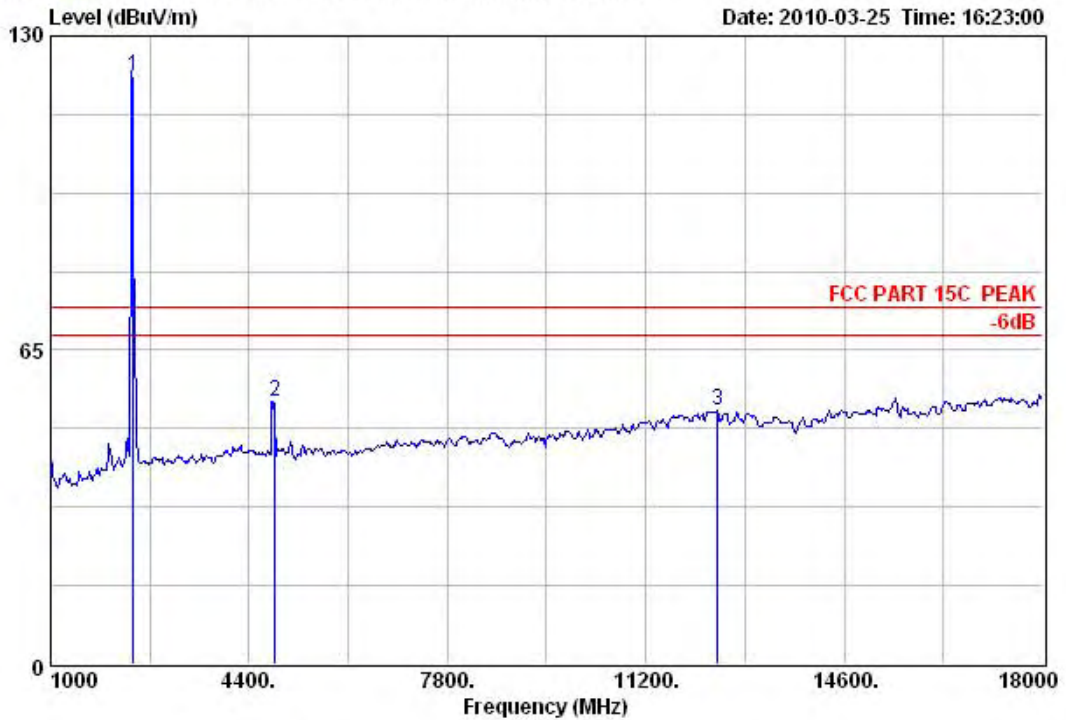

Test Site : 10m Chamber
 Limit : FCC PART 15C PEAK
 Dis. / Ant. : 3m 3117 Ant. Pol.: VERTICAL
 EUT : Wireless Router
 M/N : IP0494
 Power : DC 5V from adapter input AC 120V/60Hz
 Test Engineer : Jade
 Comment : Temp.:25.2'C Humi.:56% Press:101.51kPa
 Test Mode : TX Mode 802.11n HT40 CH1 2422MHz

Freq. (MHz)	Emission			Reading (dBuV)	Ant. Factor (dB/m)	Cable Loss (dB)	Remark
	Level (dBuV/m)	Limits (dBuV/m)	Margin (dB)				
1 2422.00	121.85	74.00	-47.85	88.10	31.52	2.23	Peak
2 4844.00	54.43	74.00	19.57	17.45	34.60	2.38	Peak
3 12424.00	52.43	74.00	21.57	9.61	39.97	2.85	Peak



NS Technology

Chenwu Industrial Zone, Houjie Town,
Dongguan, Guangdong, China
Tel: +86-769-85935656
Fax: +86-769-85991080

Data: 198

File: D:\Radiation data\Z\ZIONCOM1.EMI (303)

Date: 2010-03-25 Time: 15:18:59

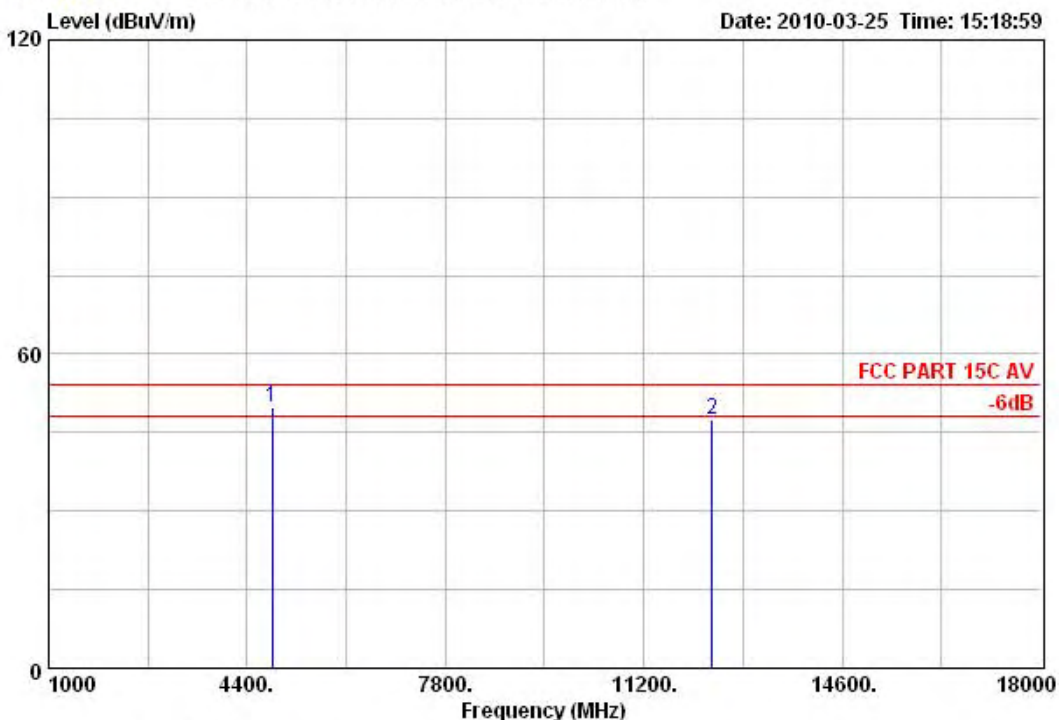

Test Site : 10m Chamber
 Limit : FCC PART 15C AV
 Dis. / Ant. : 3m 3117 Ant. Pol.: VERTICAL
 EUT : Wireless Router
 M/N : IP0494
 Power : DC 5V from adapter input AC 120V/60Hz
 Test Engineer : Jade
 Comment : Temp.:25.2'C Humi.:56% Press:101.51kPa
 Test Mode : TX Mode 802.11g CH1 2412MHz

Freq. (MHz)	Emission			Margin (dB)	Reading (dBuV)	Ant. Cable		Remark
	Level (dBuV/m)	Limits (dBuV/m)				Factor (dB/m)	Loss (dB)	
1 4824.00	49.74	54.00	4.26	12.77	34.59	2.38	Average	
212373.00	47.53	54.00	6.47	4.74	39.95	2.84	Average	



NS Technology

Chenwu Industrial Zone, Houjie Town,
Dongguan, Guangdong, China
Tel: +86-769-85935656
Fax: +86-769-85991080

Data: 199

File: D:\Radiation data\Z\ZIONCOM1.EMI (303)

Date: 2010-03-25 Time: 15:21:58

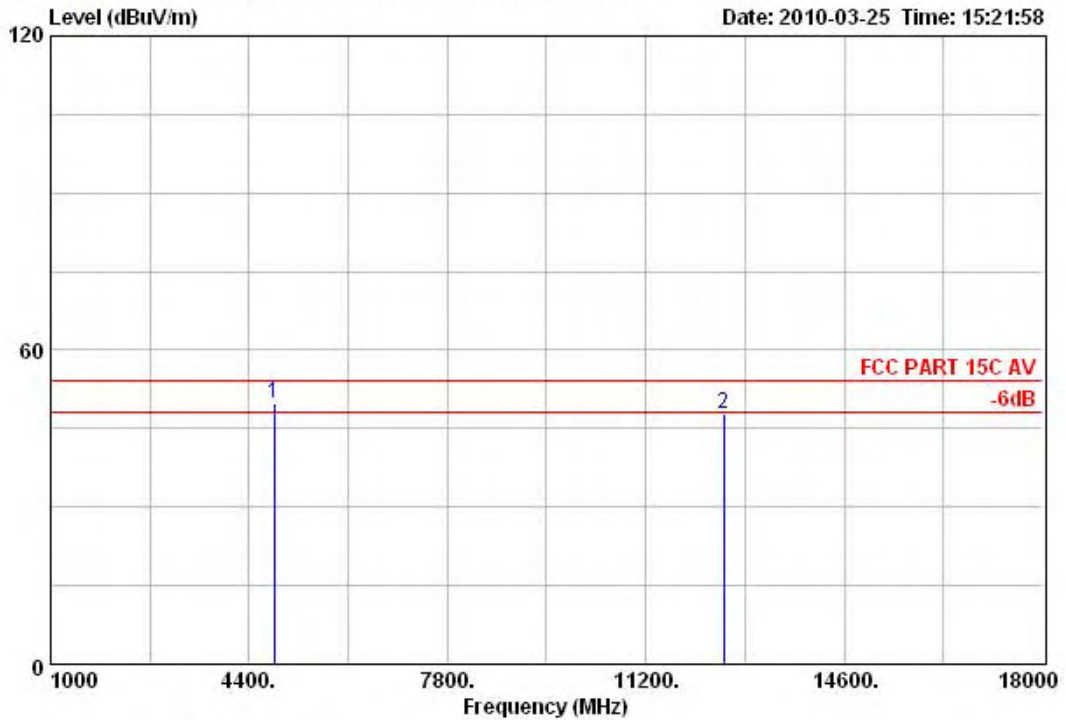

Test Site : 10m Chamber
 Limit : FCC PART 15C AV
 Dis. / Ant. : 3m 3117 Ant. Pol.: HORIZONTAL
 EUT : Wireless Router
 M/N : IP0494
 Power : DC 5V from adapter input AC 120V/60Hz
 Test Engineer : Jade
 Comment : Temp.:25.2'C Humi.:56% Press:101.51kPa
 Test Mode : TX Mode 802.11g CH1 2412MHz

Freq. (MHz)	Emission			Margin (dB)	Reading (dBuV)	Ant. Cable		Remark
	Level (dBuV/m)	Limits (dBuV/m)				Factor (dB/m)	Loss (dB)	
1 4824.00	49.94	54.00	4.06	12.97	34.59	2.38	Average	
212543.00	47.84	54.00	6.16	4.96	40.03	2.85	Average	



NS Technology

Chenwu Industrial Zone, Houjie Town,
Dongguan, Guangdong, China
Tel: +86-769-85935656
Fax: +86-769-85991080

Data: 200

File: D:\Radiation data\Z\ZIONCOM1.EMI (303)

Date: 2010-03-25 Time: 15:26:05

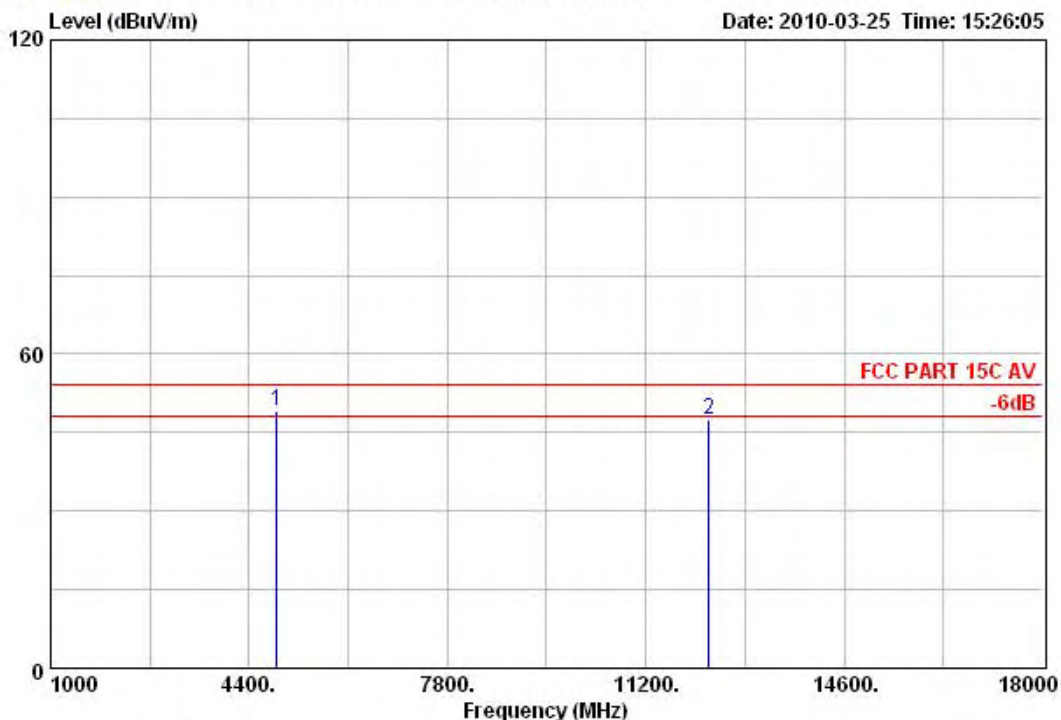

Test Site : 10m Chamber
 Limit : FCC PART 15C AV
 Dis. / Ant. : 3m 3117 Ant. Pol.: HORIZONTAL
 EUT : Wireless Router
 M/N : IP0494
 Power : DC 5V from adapter input AC 120V/60Hz
 Test Engineer : Jade
 Comment : Temp.:25.2'C Humi.:56% Press:101.51kPa
 Test Mode : TX Mode 802.11g CH6 2437MHz

Freq. (MHz)	Emission			Margin (dB)	Reading (dBuV)	Ant. Cable		Remark
	Level (dBuV/m)	Limits (dBuV/m)				Factor (dB/m)	Loss (dB)	
1 4874.00	49.03	54.00	4.97	12.03	34.62	2.38	Average	
212288.00	47.41	54.00	6.59	4.65	39.92	2.84	Average	



NS Technology

Chenwu Industrial Zone, Houjie Town,
Dongguan, Guangdong, China
Tel: +86-769-85935656
Fax: +86-769-85991080

Data: 201

File: D:\Radiation data\Z\ZIONCOM1.EMI (303)

Date: 2010-03-25 Time: 15:29:01

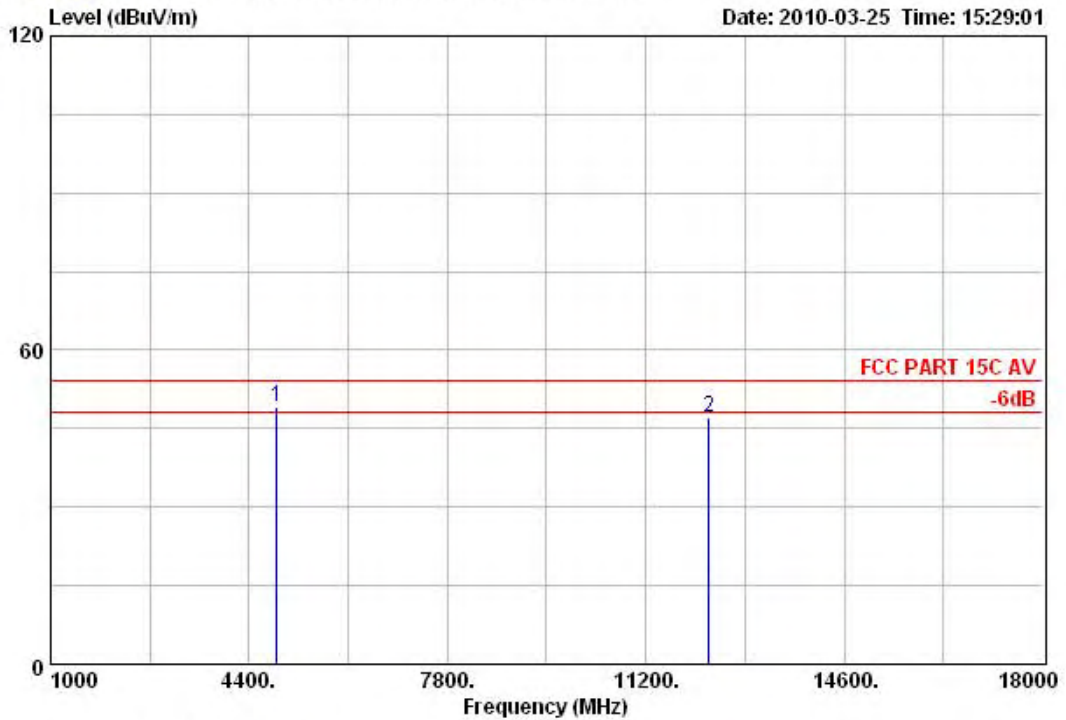

Test Site : 10m Chamber
 Limit : FCC PART 15C AV
 Dis. / Ant. : 3m 3117 Ant. Pol.: VERTICAL
 EUT : Wireless Router
 M/N : IP0494
 Power : DC 5V from adapter input AC 120V/60Hz
 Test Engineer : Jade
 Comment : Temp.:25.2'C Humi.:56% Press:101.51kPa
 Test Mode : TX Mode 802.11g CH6 2437MHz

Freq. (MHz)	Emission			Margin (dB)	Reading (dBuV)	Ant. Cable		Remark
	Level (dBuV/m)	Limits (dBuV/m)				Factor (dB/m)	Loss (dB)	
1 4874.00	49.09	54.00	4.91	12.09	34.62	2.38	Average	
212288.00	47.12	54.00	6.88	4.36	39.92	2.84	Average	



NS Technology

Chenwu Industrial Zone, Houjie Town,
Dongguan, Guangdong, China
Tel: +86-769-85935656
Fax: +86-769-85991080

Data: 202

File: D:\Radiation data\Z\ZIONCOM1.EMI (303)

Date: 2010-03-25 Time: 15:33:03

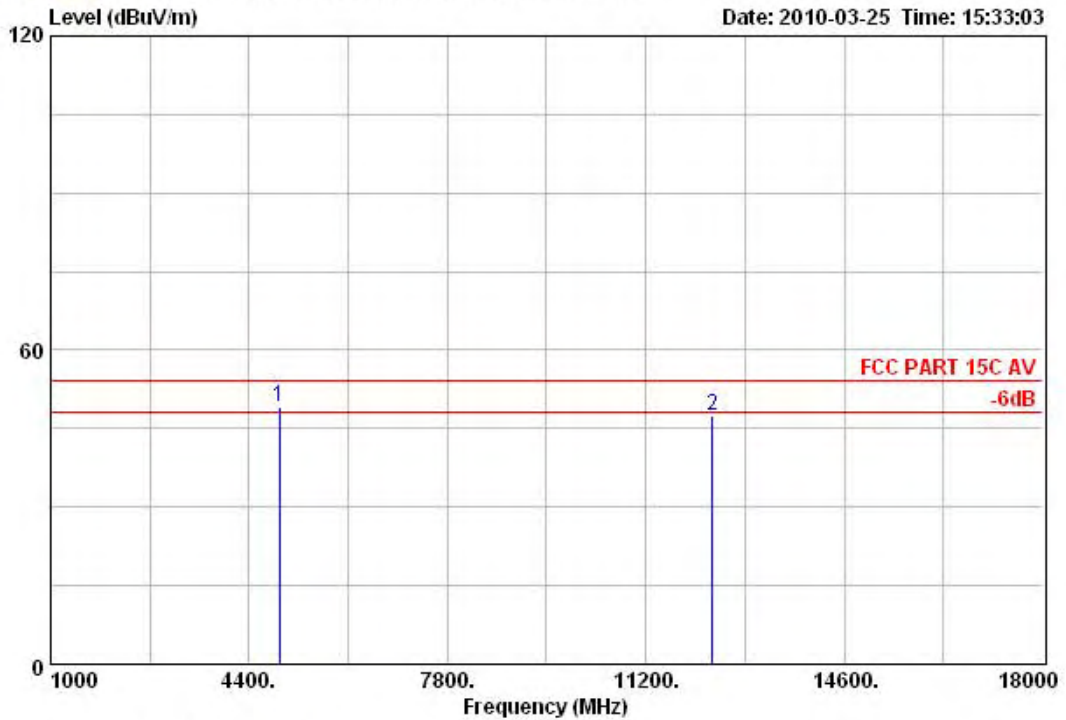

Test Site : 10m Chamber
 Limit : FCC PART 15C AV
 Dis. / Ant. : 3m 3117 Ant. Pol.: VERTICAL
 EUT : Wireless Router
 M/N : IP0494
 Power : DC 5V from adapter input AC 120V/60Hz
 Test Engineer : Jade
 Comment : Temp.:25.2'C Humi.:56% Press:101.51kPa
 Test Mode : TX Mode 802.11g CH11 2462MHz

Freq. (MHz)	Emission			Margin (dB)	Reading (dBuV)	Ant. Cable		Remark
	Level (dBuV/m)	Limits (dBuV/m)				Factor (dB/m)	Loss (dB)	
1 4924.00	49.28	54.00	4.72	12.24	34.66	2.38	Average	
212339.00	47.62	54.00	6.38	4.84	39.94	2.84	Average	



NS Technology

Chenwu Industrial Zone, Houjie Town,
Dongguan, Guangdong, China
Tel: +86-769-85935656
Fax: +86-769-85991080

Data: 203

File: D:\Radiation data\Z\ZIONCOM1.EMI (303)

Date: 2010-03-25 Time: 15:34:56

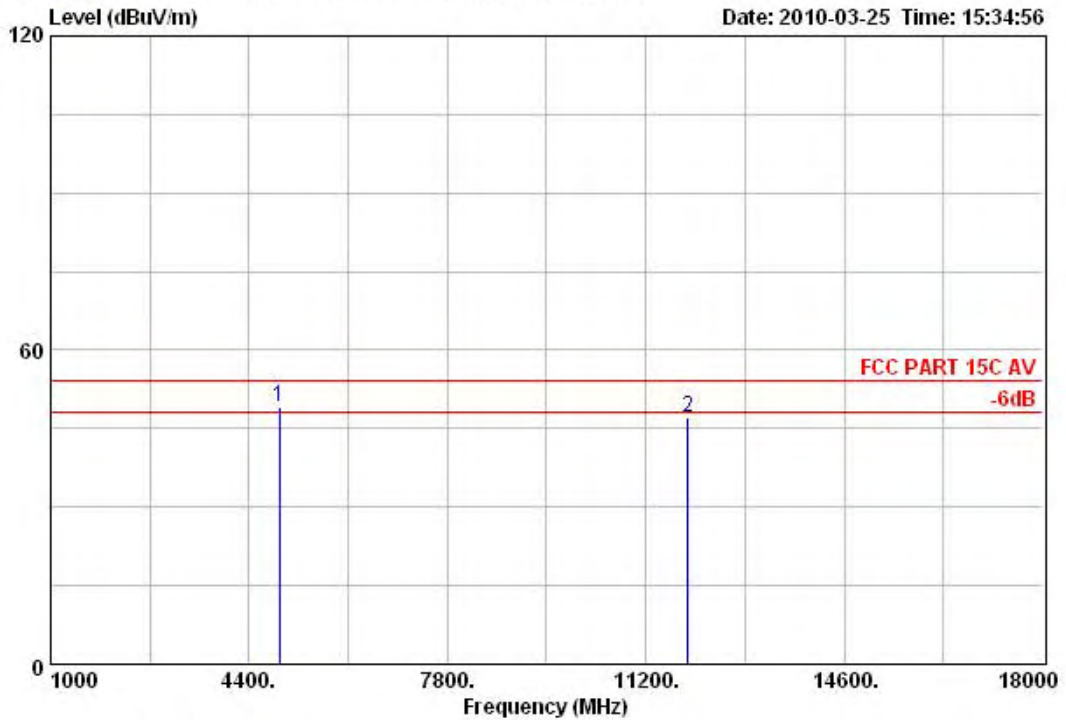

Test Site : 10m Chamber
 Limit : FCC PART 15C AV
 Dis. / Ant. : 3m 3117 Ant. Pol.: HORIZONTAL
 EUT : Wireless Router
 M/N : IP0494
 Power : DC 5V from adapter input AC 120V/60Hz
 Test Engineer : Jade
 Comment : Temp.:25.2'C Humi.:56% Press:101.51kPa
 Test Mode : TX Mode 802.11g CH11 2462MHz

Freq. (MHz)	Emission			Margin (dB)	Reading (dBuV)	Ant. Cable		Remark
	Level (dBuV/m)	Limits (dBuV/m)				Factor (dB/m)	Loss (dB)	
1 4924.00	49.25	54.00	4.75	12.21	34.66	2.38	Average	
211914.00	47.01	54.00	6.99	4.52	39.67	2.82	Average	



NS Technology

Chenwu Industrial Zone, Houjie Town,
Dongguan, Guangdong, China
Tel: +86-769-85935656
Fax: +86-769-85991080

Data: 204

File: D:\Radiation data\Z\ZIONCOM1.EMI (303)

Date: 2010-03-25 Time: 15:37:59

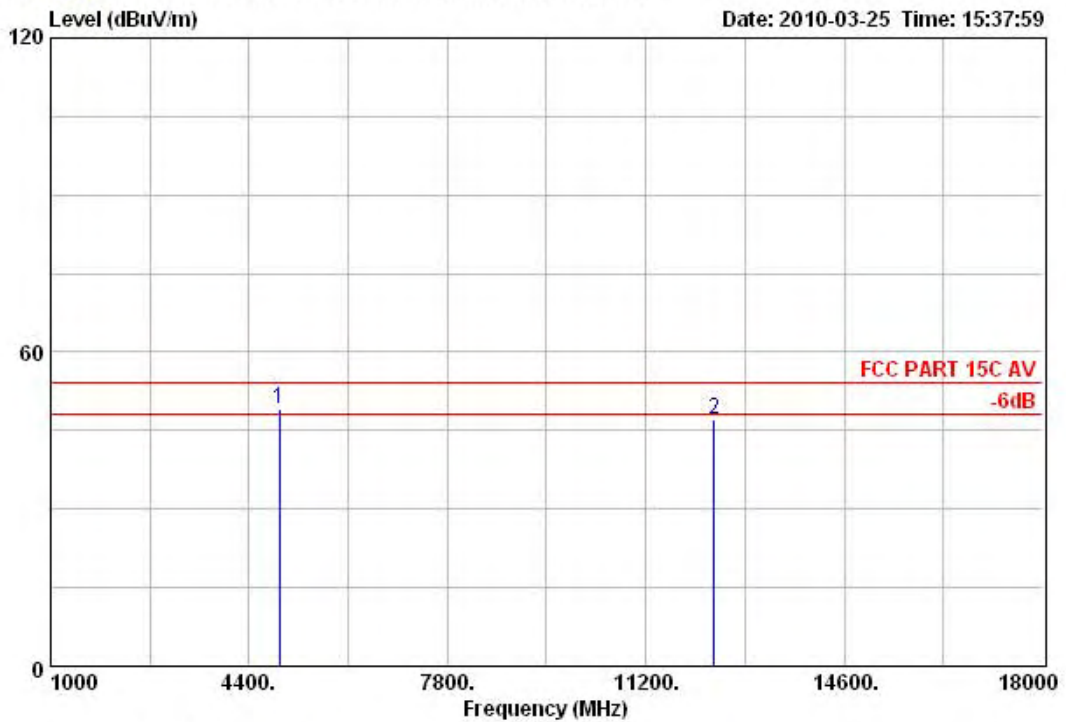

Test Site : 10m Chamber
 Limit : FCC PART 15C AV
 Dis. / Ant. : 3m 3117 Ant. Pol.: HORIZONTAL
 EUT : Wireless Router
 M/N : IP0494
 Power : DC 5V from adapter input AC 120V/60Hz
 Test Engineer : Jade
 Comment : Temp.:25.2'C Humi.:56% Press:101.51kPa
 Test Mode : TX Mode 802.11b CH11 2462MHz

Freq. (MHz)	Emission			Margin (dB)	Reading (dBuV)	Ant. Cable		Remark
	Level (dBuV/m)	Limits (dBuV/m)				Factor (dB/m)	Loss (dB)	
1 4924.00	49.26	54.00	4.74	12.22	34.66	2.38	Average	
212373.00	47.01	54.00	6.99	4.22	39.95	2.84	Average	



NS Technology

Chenwu Industrial Zone, Houjie Town,
Dongguan, Guangdong, China
Tel: +86-769-85935656
Fax: +86-769-85991080

Data: 205

File: D:\Radiation data\Z\ZIONCOM1.EMI (303)

Date: 2010-03-25 Time: 15:43:05

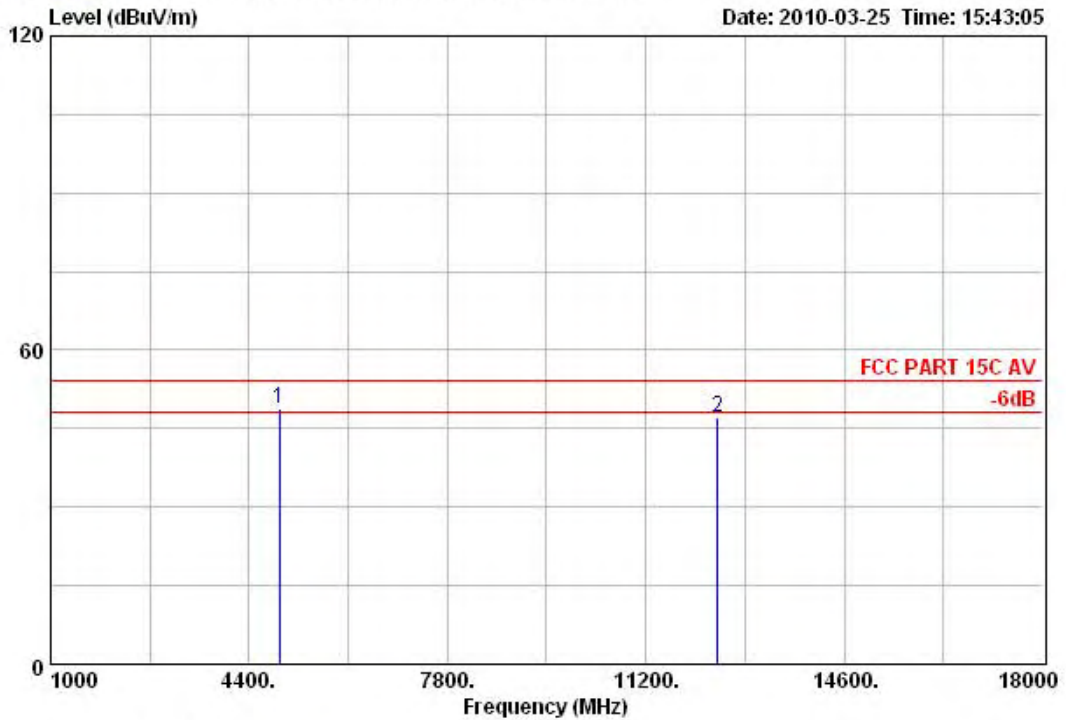

Test Site : 10m Chamber
 Limit : FCC PART 15C AV
 Dis. / Ant. : 3m 3117 Ant. Pol.: VERTICAL
 EUT : Wireless Router
 M/N : IP0494
 Power : DC 5V from adapter input AC 120V/60Hz
 Test Engineer : Jade
 Comment : Temp.:25.2'C Humi.:56% Press:101.51kPa
 Test Mode : TX Mode 802.11b CH11 2462MHz

Freq. (MHz)	Emission			Margin (dB)	Reading (dBuV)	Ant. Cable		Remark
	Level (dBuV/m)	Limits (dBuV/m)				Factor (dB/m)	Loss (dB)	
1 4924.00	48.83	54.00	5.17	11.79	34.66	2.38	Average	
212424.00	47.05	54.00	6.95	4.23	39.97	2.85	Average	



NS Technology

Chenwu Industrial Zone, Houjie Town,
Dongguan, Guangdong, China
Tel: +86-769-85935656
Fax: +86-769-85991080

Data: 206

File: D:\Radiation data\Z\ZIONCOM1.EMI (303)

Date: 2010-03-25 Time: 15:45:11

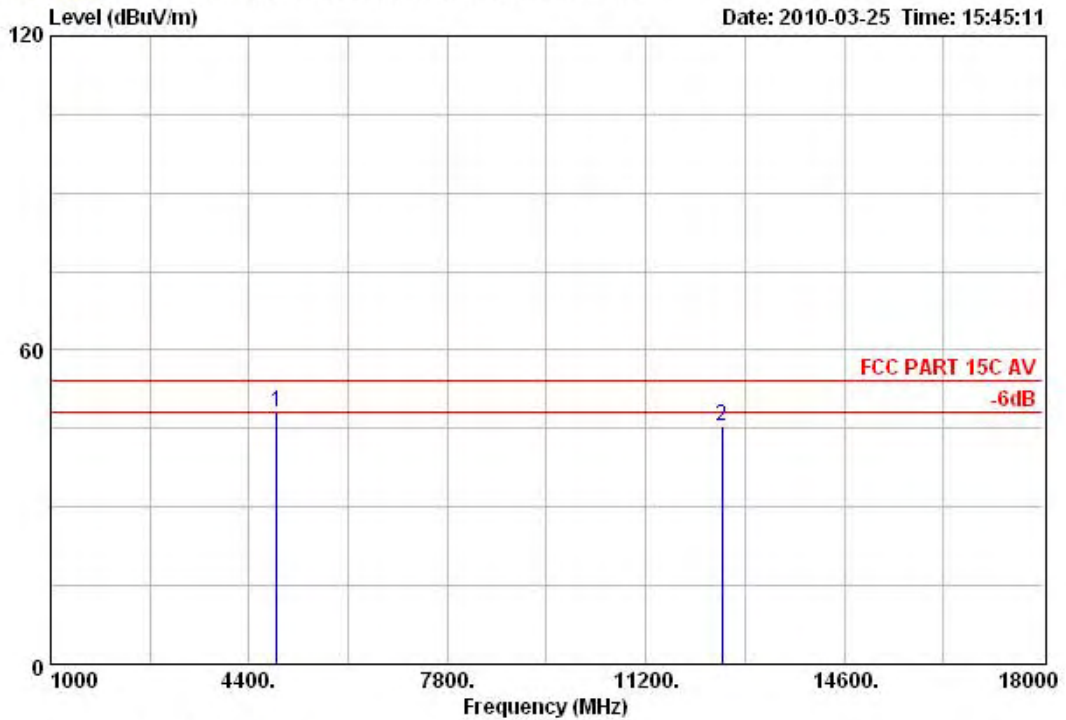

Test Site : 10m Chamber
 Limit : FCC PART 15C AV
 Dis. / Ant. : 3m 3117 Ant. Pol.: VERTICAL
 EUT : Wireless Router
 M/N : IP0494
 Power : DC 5V from adapter input AC 120V/60Hz
 Test Engineer : Jade
 Comment : Temp.:25.2'C Humi.:56% Press:101.51kPa
 Test Mode : TX Mode 802.11b CH6 2437MHz

Freq. (MHz)	Emission			Margin (dB)	Reading (dBuV)	Ant. Cable		Remark
	Level (dBuV/m)	Limits (dBuV/m)				Factor (dB/m)	Loss (dB)	
1 4874.00	48.23	54.00	5.77	11.23	34.62	2.38	Average	
212509.00	45.59	54.00	8.41	2.73	40.01	2.85	Average	



NS Technology

Chenwu Industrial Zone, Houjie Town,
Dongguan, Guangdong, China
Tel: +86-769-85935656
Fax: +86-769-85991080

Data: 207

File: D:\Radiation data\Z\ZIONCOM1.EMI (303)

Date: 2010-03-25 Time: 15:46:30

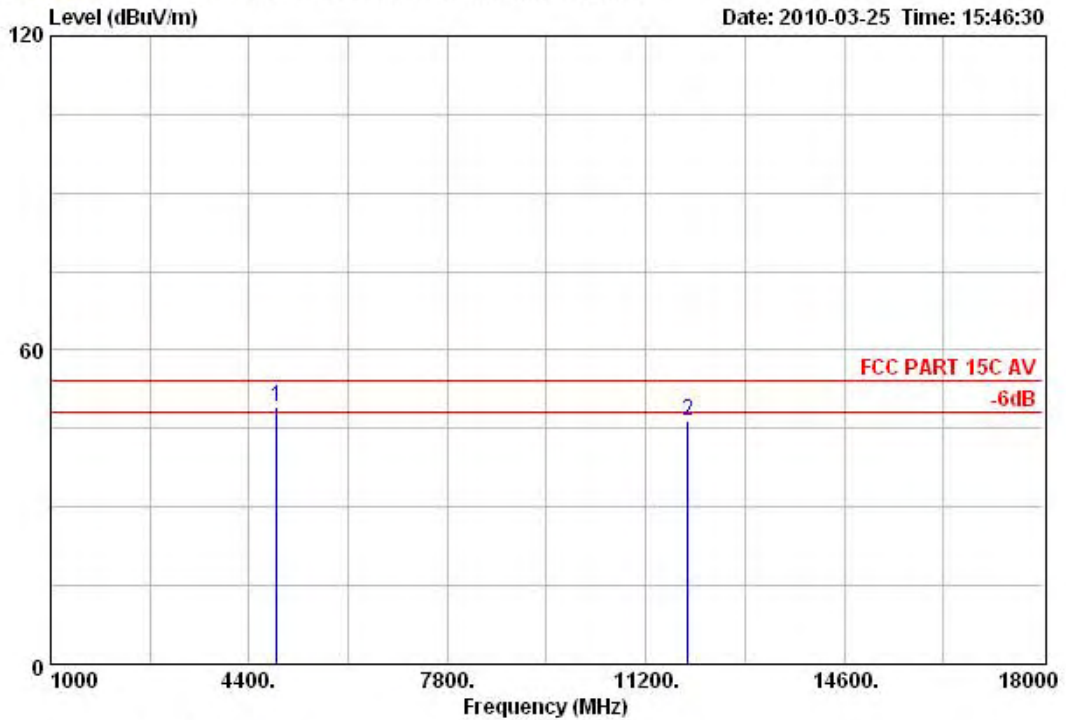

Test Site : 10m Chamber
 Limit : FCC PART 15C AV
 Dis. / Ant. : 3m 3117 Ant. Pol.: HORIZONTAL
 EUT : Wireless Router
 M/N : IP0494
 Power : DC 5V from adapter input AC 120V/60Hz
 Test Engineer : Jade
 Comment : Temp.:25.2'C Humi.:56% Press:101.51kPa
 Test Mode : TX Mode 802.11b CH6 2437MHz

Freq. (MHz)	Emission			Margin (dB)	Reading (dBuV)	Ant. Cable		Remark
	Level (dBuV/m)	Limits (dBuV/m)				Factor (dB/m)	Loss (dB)	
1 4874.00	49.25	54.00	4.75	12.25	34.62	2.38	Average	
211914.00	46.56	54.00	7.44	4.07	39.67	2.82	Average	



NS Technology

Chenwu Industrial Zone, Houjie Town,
Dongguan, Guangdong, China
Tel: +86-769-85935656
Fax: +86-769-85991080

Data: 208

File: D:\Radiation data\Z\ZIONCOM1.EMI (303)

Date: 2010-03-25 Time: 15:48:36

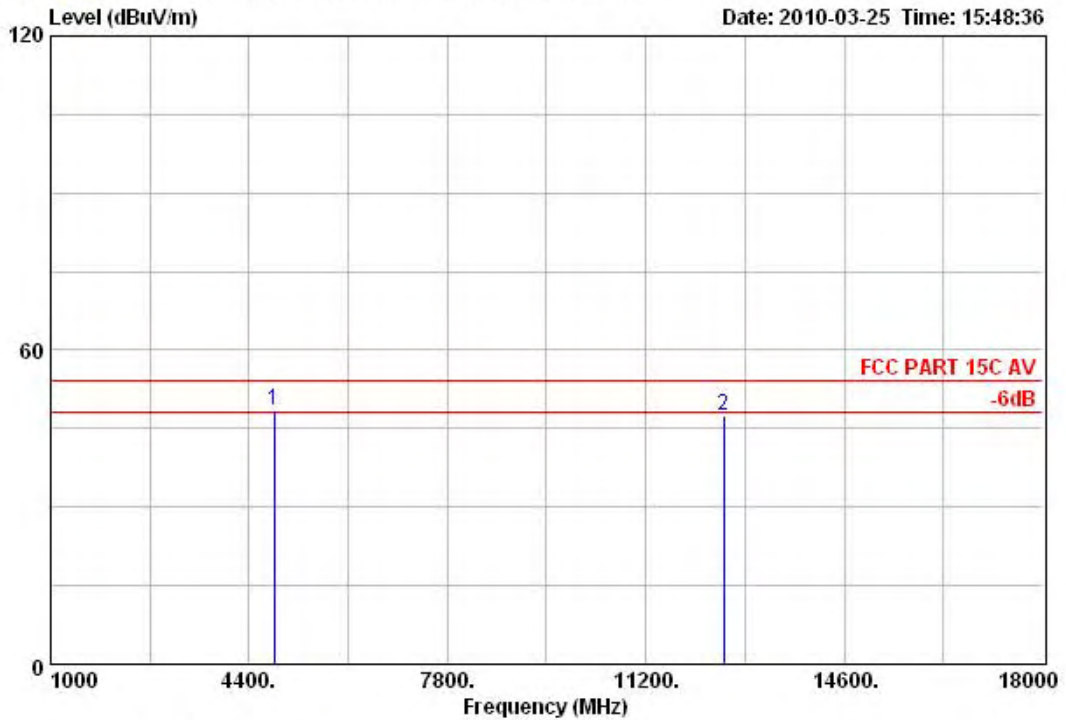

Test Site : 10m Chamber
 Limit : FCC PART 15C AV
 Dis. / Ant. : 3m 3117 Ant. Pol.: HORIZONTAL
 EUT : Wireless Router
 M/N : IP0494
 Power : DC 5V from adapter input AC 120V/60Hz
 Test Engineer : Jade
 Comment : Temp.:25.2'C Humi.:56% Press:101.51kPa
 Test Mode : TX Mode 802.11b CH1 2412MHz

Freq. (MHz)	Emission			Margin (dB)	Reading (dBuV)	Ant. Cable		Remark
	Level (dBuV/m)	Limits (dBuV/m)				Factor (dB/m)	Loss (dB)	
1 4824.00	48.50	54.00	5.50	11.53	34.59	2.38	Average	
212543.00	47.47	54.00	6.53	4.59	40.03	2.85	Average	



NS Technology

Chenwu Industrial Zone, Houjie Town,
Dongguan, Guangdong, China
Tel: +86-769-85935656
Fax: +86-769-85991080

Data: 209

File: D:\Radiation data\Z\ZIONCOM1.EMI (303)

Date: 2010-03-25 Time: 15:50:00

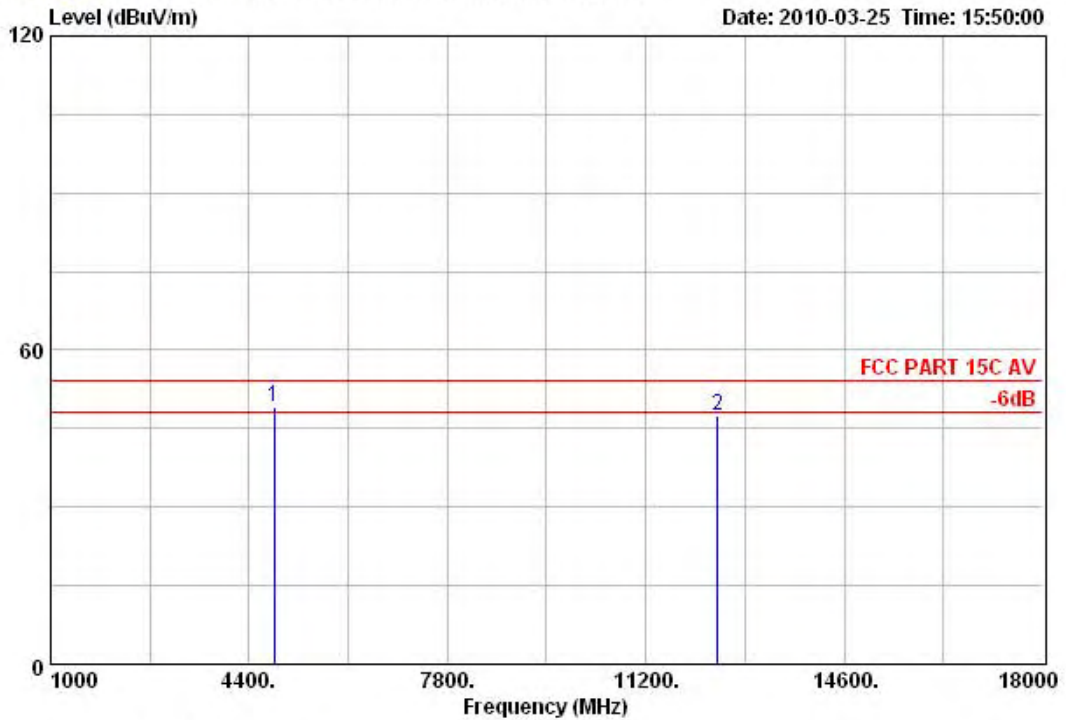

Test Site : 10m Chamber
 Limit : FCC PART 15C AV
 Dis. / Ant. : 3m 3117 Ant. Pol.: VERTICAL
 EUT : Wireless Router
 M/N : IP0494
 Power : DC 5V from adapter input AC 120V/60Hz
 Test Engineer : Jade
 Comment : Temp.:25.2'C Humi.:56% Press:101.51kPa
 Test Mode : TX Mode 802.11b CH1 2412MHz

Freq. (MHz)	Emission			Margin (dB)	Reading (dBuV)	Ant. Cable		Remark
	Level (dBuV/m)	Limits (dBuV/m)				Factor (dB/m)	Loss (dB)	
1 4824.00	49.25	54.00	4.75	12.28	34.59	2.38	Average	
212424.00	47.43	54.00	6.57	4.61	39.97	2.85	Average	



NS Technology

Chenwu Industrial Zone, Houjie Town,
Dongguan, Guangdong, China
Tel: +86-769-85935656
Fax: +86-769-85991080

Data: 210

File: D:\Radiation data\Z\ZIONCOM1.EMI (303)

Date: 2010-03-25 Time: 15:52:59

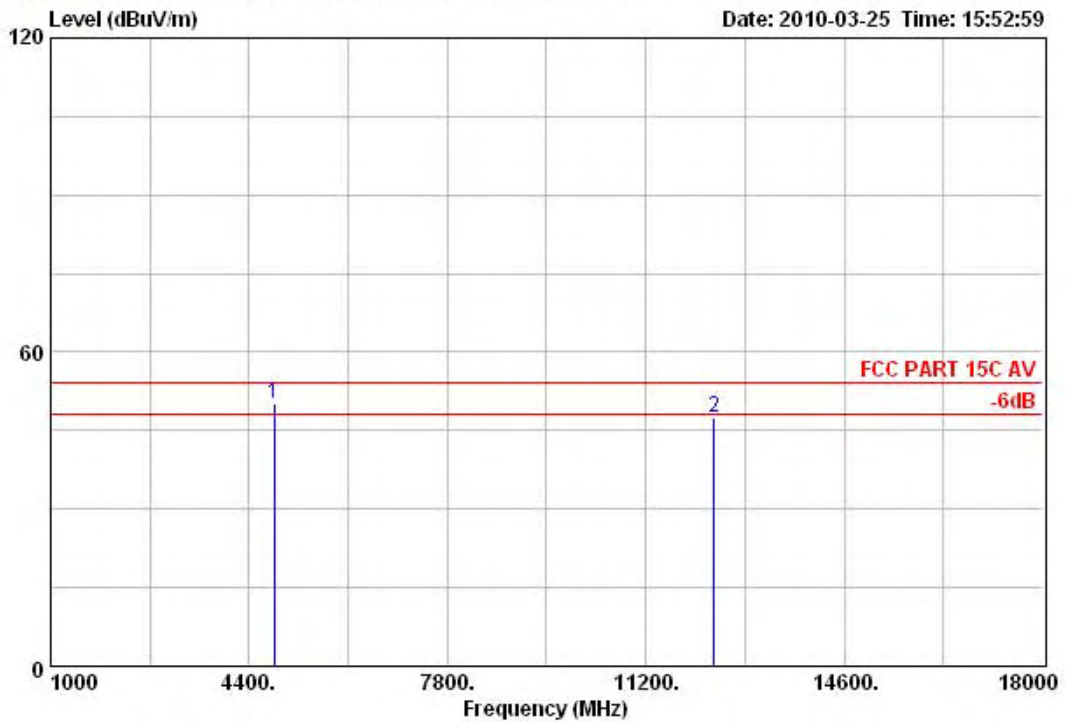

```

Test Site      : 10m Chamber
Limit         : FCC PART 15C AV
Dis. / Ant.   : 3m 3117           Ant. Pol.: VERTICAL
EUT          : Wireless Router
M/N          : IP0494
Power        : DC 5V from adapter input AC 120V/60Hz
Test Engineer : Jade
Comment      : Temp.:25.2'C Humi.:56% Press:101.51kPa
Test Mode    : TX Mode 802.11n HT20 CH1 2412MHz
    
```

Freq. (MHz)	Emission			Margin (dB)	Reading (dBuV)	Ant. Cable		Remark
	Level (dBuV/m)	Limits (dBuV/m)				Factor (dB/m)	Loss (dB)	
1 4824.00	50.25	54.00	3.75	13.28	34.59	2.38	Average	
212373.00	47.53	54.00	6.47	4.74	39.95	2.84	Average	



NS Technology

Chenwu Industrial Zone, Houjie Town,
Dongguan, Guangdong, China
Tel: +86-769-85935656
Fax: +86-769-85991080

Data: 211

File: D:\Radiation data\Z\ZIONCOM1.EMI (303)

Date: 2010-03-25 Time: 15:56:58

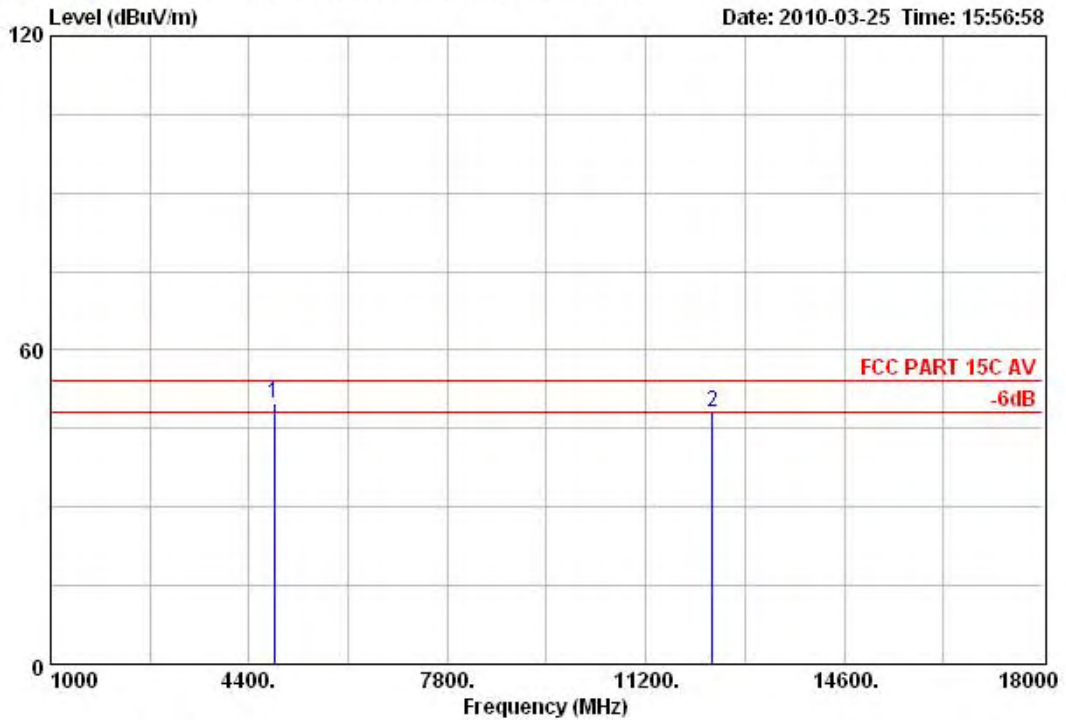

Test Site : 10m Chamber
 Limit : FCC PART 15C AV
 Dis. / Ant. : 3m 3117 Ant. Pol.: HORIZONTAL
 EUT : Wireless Router
 M/N : IP0494
 Power : DC 5V from adapter input AC 120V/60Hz
 Test Engineer : Jade
 Comment : Temp.:25.2'C Humi.:56% Press:101.51kPa
 Test Mode : TX Mode 802.11n HT20 CH1 2412MHz

Freq. (MHz)	Emission			Margin (dB)	Reading (dBuV)	Ant. Cable		Remark
	Level (dBuV/m)	Limits (dBuV/m)				Factor (dB/m)	Loss (dB)	
1 4824.00	49.82	54.00	4.18	12.85	34.59	2.38	Average	
212339.00	48.01	54.00	5.99	5.23	39.94	2.84	Average	



NS Technology

Chenwu Industrial Zone, Houjie Town,
Dongguan, Guangdong, China
Tel: +86-769-85935656
Fax: +86-769-85991080

Data: 212

File: D:\Radiation data\Z\ZIONCOM1.EMI (303)

Date: 2010-03-25 Time: 15:59:05

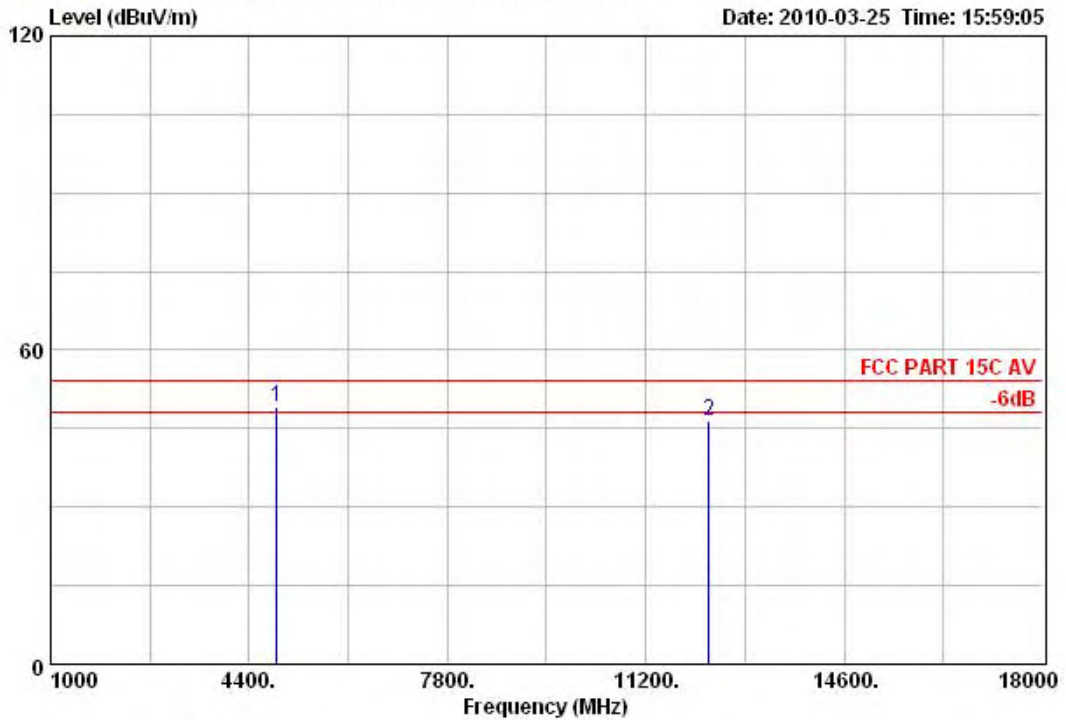

Test Site : 10m Chamber
 Limit : FCC PART 15C AV
 Dis. / Ant. : 3m 3117 Ant. Pol.: HORIZONTAL
 EUT : Wireless Router
 M/N : IP0494
 Power : DC 5V from adapter input AC 120V/60Hz
 Test Engineer : Jade
 Comment : Temp.:25.2'C Humi.:56% Press:101.51kPa
 Test Mode : TX Mode 802.11n HT20 CH6 2437MHz

Freq. (MHz)	Emission			Margin (dB)	Reading (dBuV)	Ant. Cable		Remark
	Level (dBuV/m)	Limits (dBuV/m)				Factor (dB/m)	Loss (dB)	
1 4874.00	49.03	54.00	4.97	12.03	34.62	2.38	Average	
212288.00	46.41	54.00	7.59	3.65	39.92	2.84	Average	



NS Technology

Chenwu Industrial Zone, Houjie Town,
Dongguan, Guangdong, China
Tel: +86-769-85935656
Fax: +86-769-85991080

Data: 213

File: D:\Radiation data\Z\ZIONCOM1.EMI (303)

Date: 2010-03-25 Time: 16:02:01

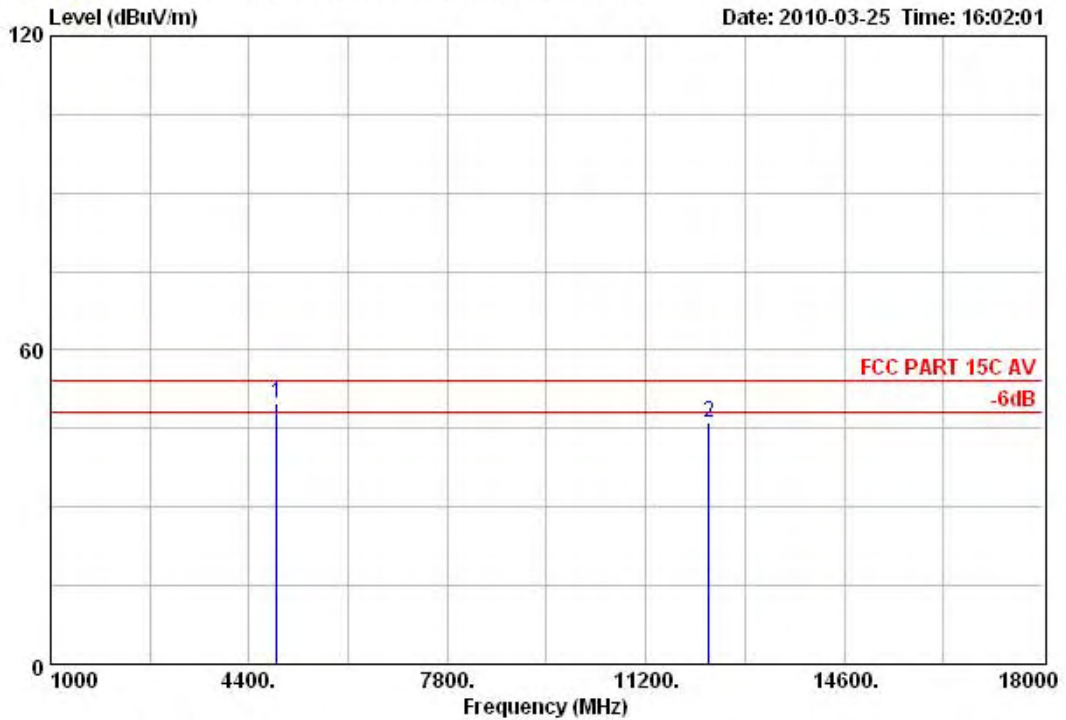

Test Site : 10m Chamber
 Limit : FCC PART 15C AV
 Dis. / Ant. : 3m 3117 Ant. Pol.: VERTICAL
 EUT : Wireless Router
 M/N : IP0494
 Power : DC 5V from adapter input AC 120V/60Hz
 Test Engineer : Jade
 Comment : Temp.:25.2'C Humi.:56% Press:101.51kPa
 Test Mode : TX Mode 802.11n HT20 CH6 2437MHz

Freq. (MHz)	Emission			Margin (dB)	Reading (dBuV)	Ant. Cable		Remark
	Level (dBuV/m)	Limits (dBuV/m)				Factor (dB/m)	Loss (dB)	
1 4874.00	49.66	54.00	4.34	12.66	34.62	2.38	Average	
21228.00	46.12	54.00	7.88	3.36	39.92	2.84	Average	



NS Technology

Chenwu Industrial Zone, Houjie Town,
Dongguan, Guangdong, China
Tel: +86-769-85935656
Fax: +86-769-85991080

Data: 214

File: D:\Radiation data\Z\ZIONCOM1.EMI (303)

Date: 2010-03-25 Time: 16:05:03

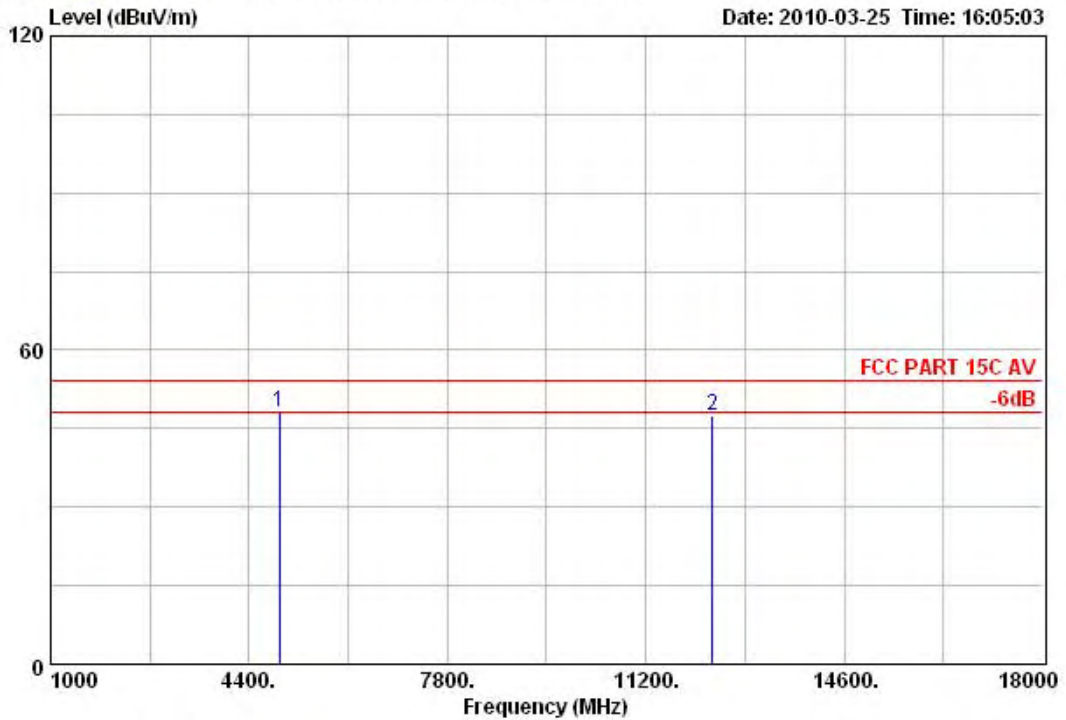

Test Site : 10m Chamber
 Limit : FCC PART 15C AV
 Dis. / Ant. : 3m 3117 Ant. Pol.: VERTICAL
 EUT : Wireless Router
 M/N : IP0494
 Power : DC 5V from adapter input AC 120V/60Hz
 Test Engineer : Jade
 Comment : Temp.:25.2'C Humi.:56% Press:101.51kPa
 Test Mode : TX Mode 802.11n HT20 CH11 2462MHz

Freq. (MHz)	Emission			Margin (dB)	Reading (dBuV)	Ant. Cable		Remark
	Level (dBuV/m)	Limits (dBuV/m)				Factor (dB/m)	Loss (dB)	
1 4924.00	48.28	54.00	5.72	11.24	34.66	2.38	Average	
212339.00	47.62	54.00	6.38	4.84	39.94	2.84	Average	



NS Technology

Chenwu Industrial Zone, Houjie Town,
Dongguan, Guangdong, China
Tel: +86-769-85935656
Fax: +86-769-85991080

Data: 215

File: D:\Radiation data\Z\ZIONCOM1.EMI (303)

Date: 2010-03-25 Time: 15:34:56

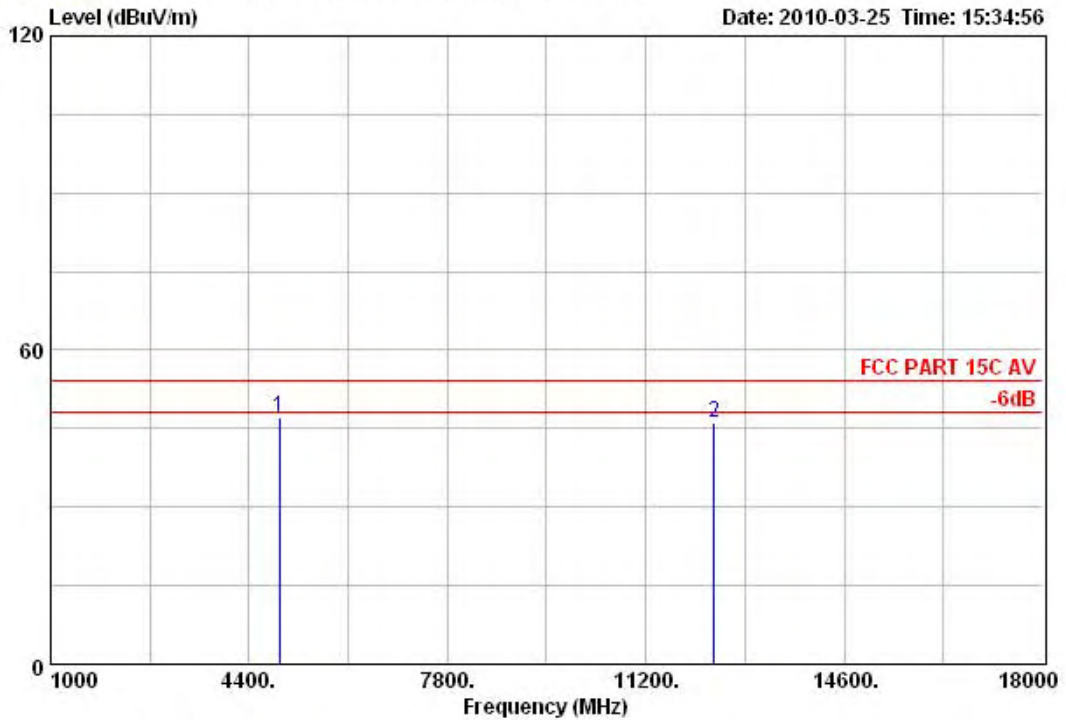

Test Site : 10m Chamber
 Limit : FCC PART 15C AV
 Dis. / Ant. : 3m 3117 Ant. Pol.: HORIZONTAL
 EUT : Wireless Router
 M/N : IP0494
 Power : DC 5V from adapter input AC 120V/60Hz
 Test Engineer : Jade
 Comment : Temp.:25.2'C Humi.:56% Press:101.51kPa
 Test Mode : TX Mode 802.11n HT20 CH11 2462MHz

Freq. (MHz)	Emission			Margin (dB)	Reading (dBuV)	Ant. Cable		Remark
	Level (dBuV/m)	Limits (dBuV/m)				Factor (dB/m)	Loss (dB)	
1 4924.00	47.25	54.00	6.75	10.21	34.66	2.38	Average	
212373.00	46.02	54.00	7.98	3.23	39.95	2.84	Average	



NS Technology

Chenwu Industrial Zone, Houjie Town,
Dongguan, Guangdong, China
Tel: +86-769-85935656
Fax: +86-769-85991080

Data: 216

File: D:\Radiation data\Z\ZIONCOM1.EMI (303)

Date: 2010-03-25 Time: 16:08:59

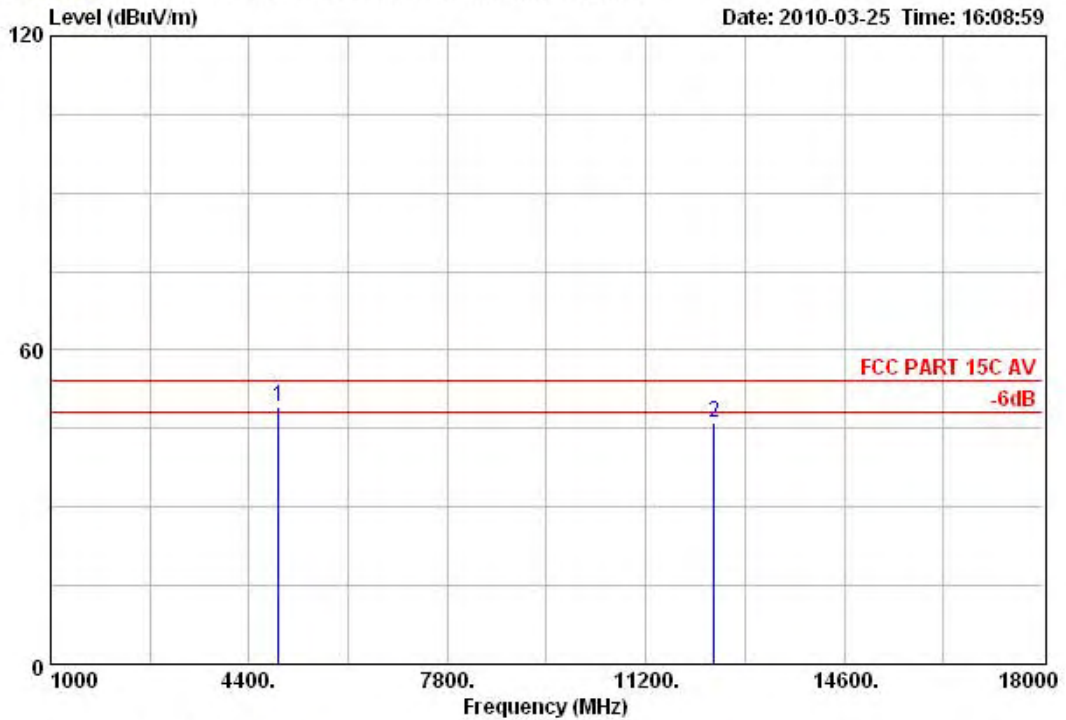

Test Site : 10m Chamber
 Limit : FCC PART 15C AV
 Dis. / Ant. : 3m 3117 Ant. Pol.: HORIZONTAL
 EUT : Wireless Router
 M/N : IP0494
 Power : DC 5V from adapter input AC 120V/60Hz
 Test Engineer : Jade
 Comment : Temp.:25.2'C Humi.:56% Press:101.51kPa
 Test Mode : TX Mode 802.11n HT40 CH7 2452MHz

Freq. (MHz)	Emission			Margin (dB)	Reading (dBuV)	Ant. Cable		Remark
	Level (dBuV/m)	Limits (dBuV/m)				Factor (dB/m)	Loss (dB)	
1 4904.00	49.26	54.00	4.74	12.25	34.63	2.38	Average	
212373.00	46.01	54.00	7.99	3.22	39.95	2.84	Average	



NS Technology

Chenwu Industrial Zone, Houjie Town,
Dongguan, Guangdong, China
Tel: +86-769-85935656
Fax: +86-769-85991080

Data: 217

File: D:\Radiation data\ZIONCOM1.EMI (303)

Date: 2010-03-25 Time: 16:11:05

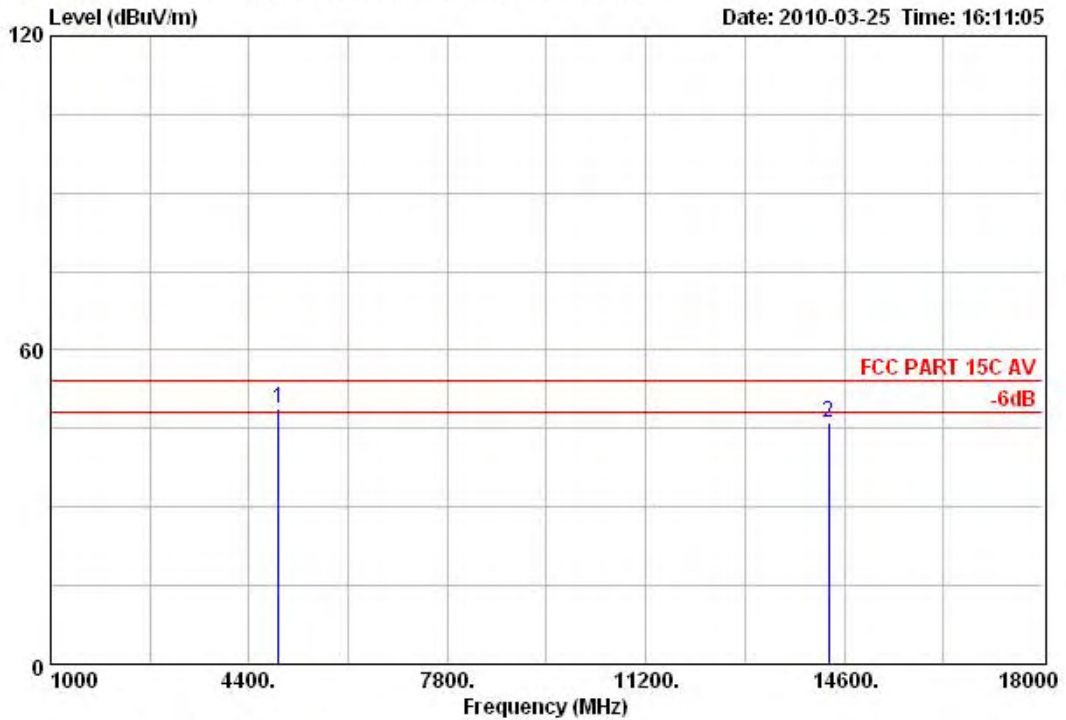

Test Site : 10m Chamber
 Limit : FCC PART 15C AV
 Dis. / Ant. : 3m 3117 Ant. Pol.: VERTICAL
 EUT : Wireless Router
 M/N : IP0494
 Power : DC 5V from adapter input AC 120V/60Hz
 Test Engineer : Jade
 Comment : Temp.:25.2'C Humi.:56% Press:101.51kPa
 Test Mode : TX Mode 802.11n HT40 CH7 2452MHz

Freq. (MHz)	Emission			Margin (dB)	Reading (dBuV)	Ant. Cable		Remark
	Level (dBuV/m)	Limits (dBuV/m)				Factor (dB/m)	Loss (dB)	
1 4904.00	48.83	54.00	5.17	11.82	34.63	2.38	Average	
21432.80	46.06	54.00	7.94	2.68	40.42	2.96	Average	



NS Technology

Chenwu Industrial Zone, Houjie Town,
Dongguan, Guangdong, China
Tel: +86-769-85935656
Fax: +86-769-85991080

Data: 218

File: D:\Radiation data\ZIONCOM1.EMI (303)

Date: 2010-03-25 Time: 16:14:11

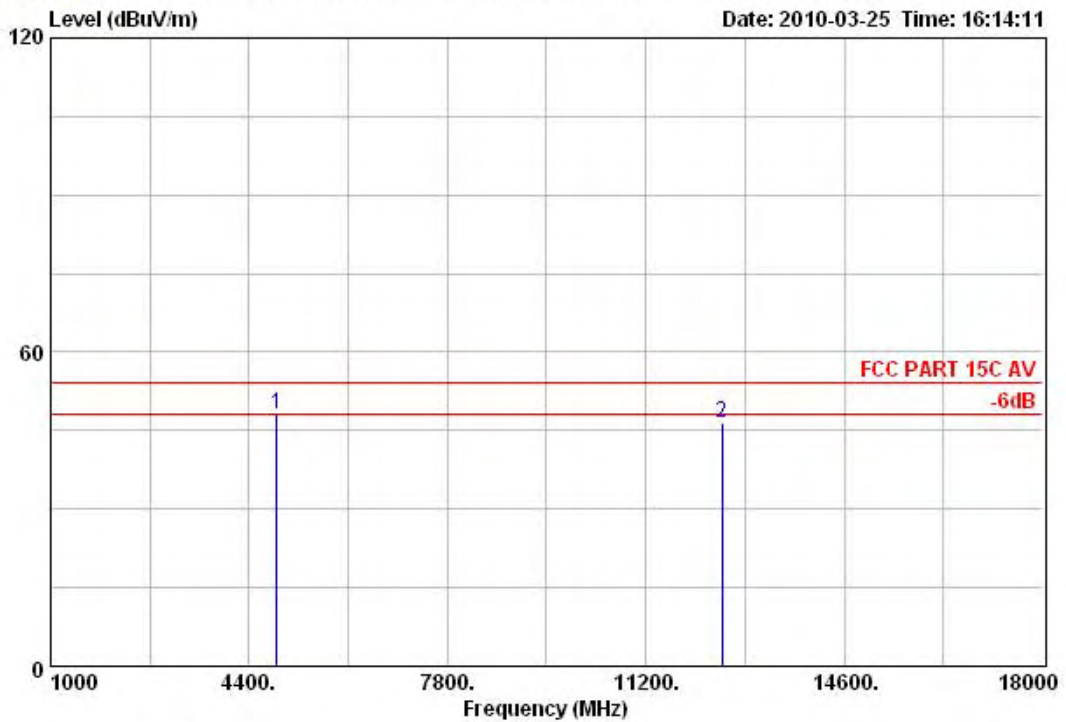

Test Site : 10m Chamber
 Limit : FCC PART 15C AV
 Dis. / Ant. : 3m 3117 Ant. Pol.: VERTICAL
 EUT : Wireless Router
 M/N : IP0494
 Power : DC 5V from adapter input AC 120V/60Hz
 Test Engineer : Jade
 Comment : Temp.:25.2'C Humi.:56% Press:101.51kPa
 Test Mode : TX Mode 802.11n HT40 CH4 2437MHz

Freq. (MHz)	Emission			Margin (dB)	Reading (dBuV)	Ant. Cable		Remark
	Level (dBuV/m)	Limits (dBuV/m)				Factor (dB/m)	Loss (dB)	
1 4874.00	48.07	54.00	5.93	11.07	34.62	2.38	Average	
212509.00	46.59	54.00	7.41	3.73	40.01	2.85	Average	



NS Technology

Chenwu Industrial Zone, Houjie Town,
Dongguan, Guangdong, China
Tel: +86-769-85935656
Fax: +86-769-85991080

Data: 219

File: D:\Radiation data\Z\ZIONCOM1.EMI (303)

Date: 2010-03-25 Time: 16:17:30

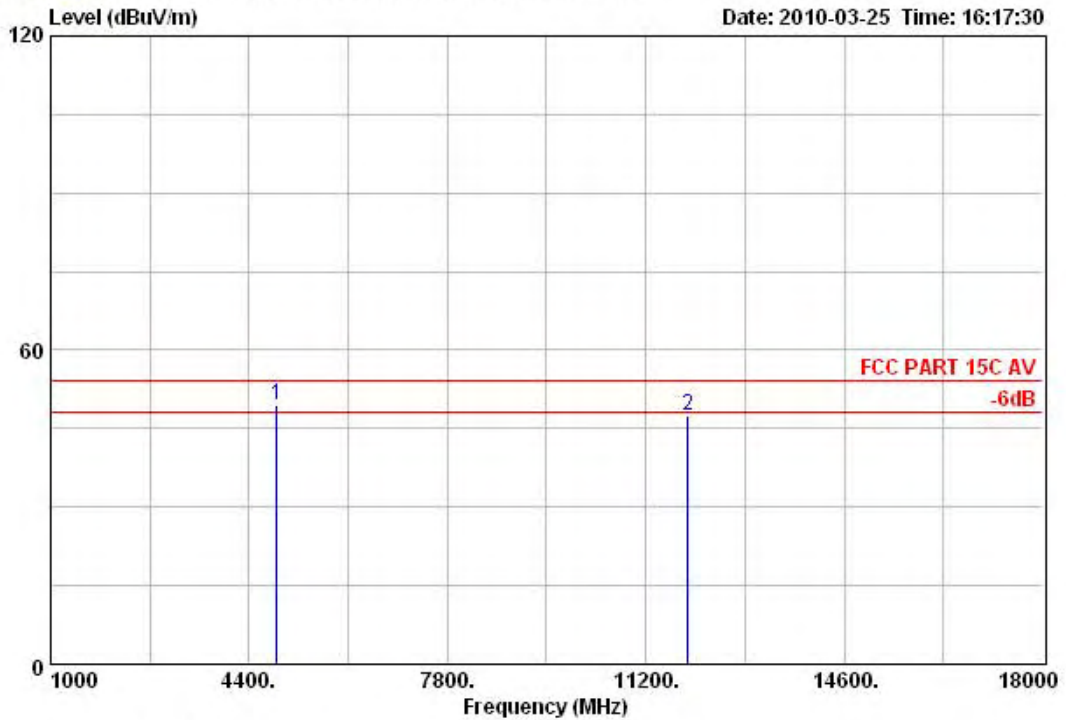

Test Site : 10m Chamber
 Limit : FCC PART 15C AV
 Dis. / Ant. : 3m 3117 Ant. Pol.: HORIZONTAL
 EUT : Wireless Router
 M/N : IP0494
 Power : DC 5V from adapter input AC 120V/60Hz
 Test Engineer : Jade
 Comment : Temp.:25.2'C Humi.:56% Press:101.51kPa
 Test Mode : TX Mode 802.11n HT40 CH4 2437MHz

Freq. (MHz)	Emission			Margin (dB)	Reading (dBuV)	Ant. Cable		Remark
	Level (dBuV/m)	Limits (dBuV/m)				Factor (dB/m)	Loss (dB)	
1 4874.00	49.52	54.00	4.48	12.52	34.62	2.38	Average	
211914.00	47.56	54.00	6.44	5.07	39.67	2.82	Average	



NS Technology

Chenwu Industrial Zone, Houjie Town,
Dongguan, Guangdong, China
Tel: +86-769-85935656
Fax: +86-769-85991080

Data: 220

File: D:\Radiation data\Z\ZIONCOM1.EMI (303)

Date: 2010-03-25 Time: 16:20:36

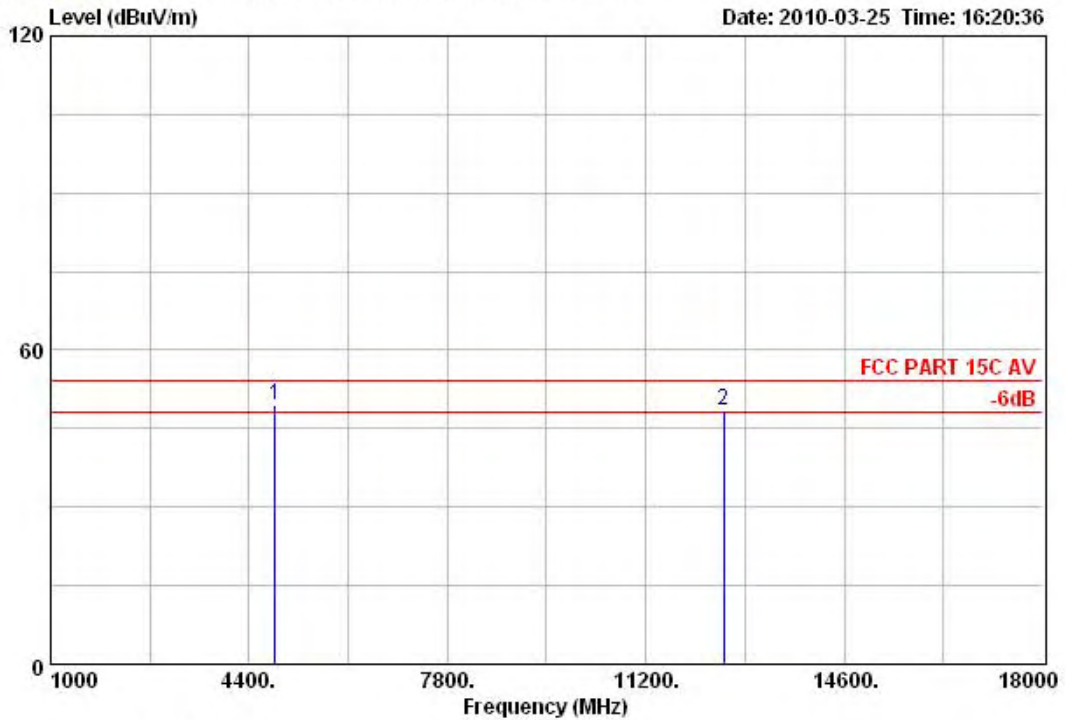

Test Site : 10m Chamber
 Limit : FCC PART 15C AV
 Dis. / Ant. : 3m 3117 Ant. Pol.: HORIZONTAL
 EUT : Wireless Router
 M/N : IP0494
 Power : DC 5V from adapter input AC 120V/60Hz
 Test Engineer : Jade
 Comment : Temp.:25.2'C Humi.:56% Press:101.51kPa
 Test Mode : TX Mode 802.11n HT40 CH1 2422MHz

Freq. (MHz)	Emission			Margin (dB)	Reading (dBuV)	Ant. Cable		Remark
	Level (dBuV/m)	Limits (dBuV/m)				Factor (dB/m)	Loss (dB)	
1 4844.00	49.50	54.00	4.50	12.52	34.60	2.38	Average	
212543.00	48.47	54.00	5.53	5.59	40.03	2.85	Average	



NS Technology

Chenwu Industrial Zone, Houjie Town,
Dongguan, Guangdong, China
Tel: +86-769-85935656
Fax: +86-769-85991080

Data: 221

File: D:\Radiation data\Z\ZIONCOM1.EMI (303)

Date: 2010-03-25 Time: 16:23:00

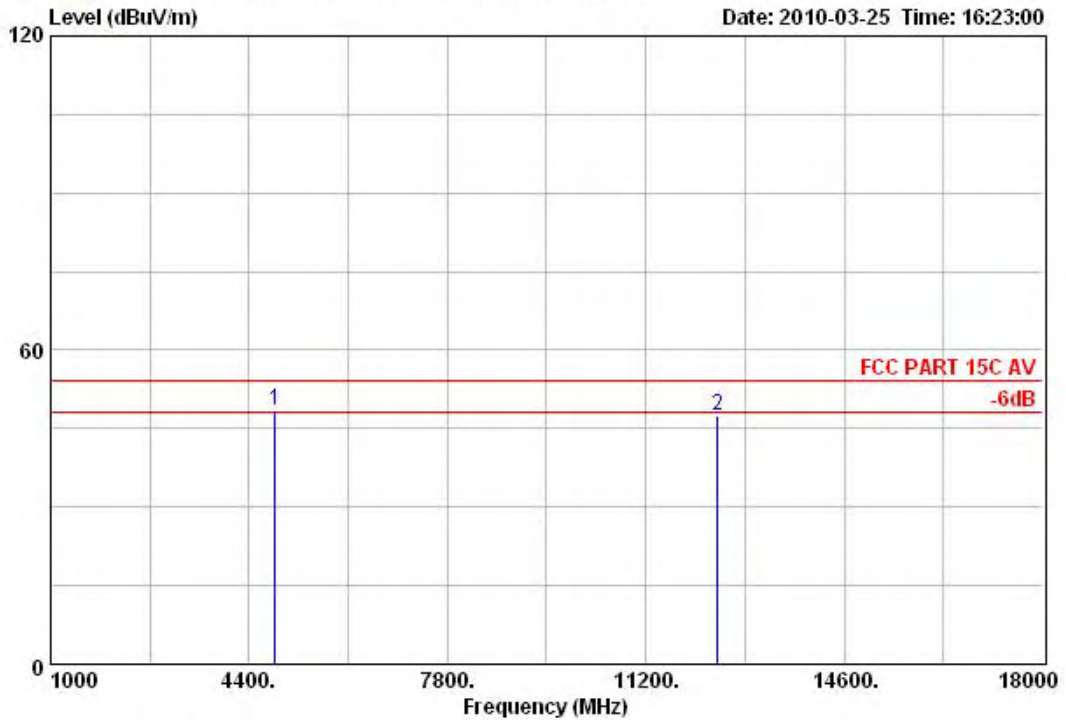

Test Site : 10m Chamber
 Limit : FCC PART 15C AV
 Dis. / Ant. : 3m 3117 Ant. Pol.: VERTICAL
 EUT : Wireless Router
 M/N : IP0494
 Power : DC 5V from adapter input AC 120V/60Hz
 Test Engineer : Jade
 Comment : Temp.:25.2'C Humi.:56% Press:101.51kPa
 Test Mode : TX Mode 802.11n HT40 CH1 2422MHz

Freq. (MHz)	Emission			Margin (dB)	Reading (dBuV)	Ant. Cable		Remark
	Level (dBuV/m)	Limits (dBuV/m)				Factor (dB/m)	Loss (dB)	
1 4844.00	48.43	54.00	5.57	11.45	34.60	2.38	Average	
212424.00	47.43	54.00	6.57	4.61	39.97	2.85	Average	



Conducted emission test data

802.11b CH1 2412MHz

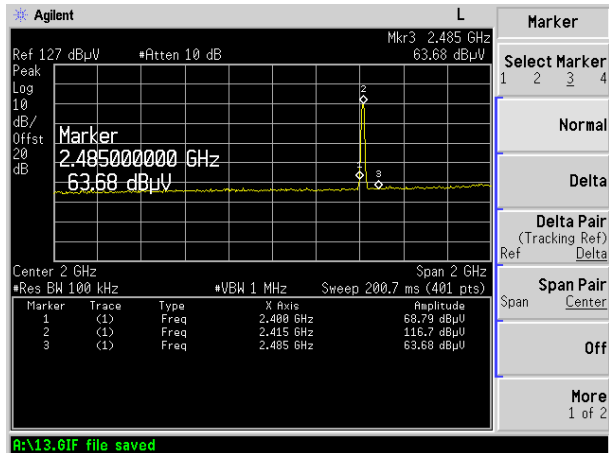
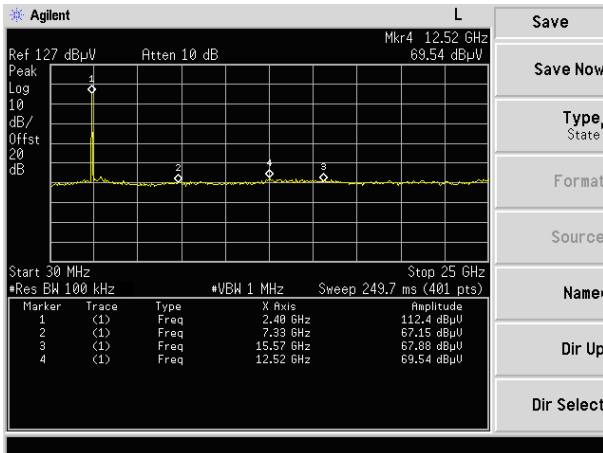

802.11b CH6 2437MHz

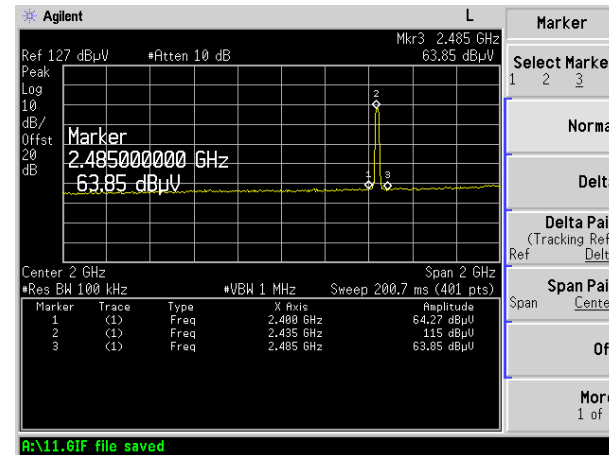
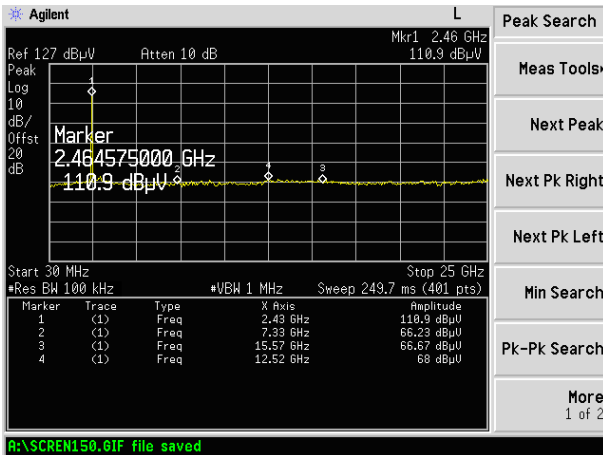

802.11b CH11 2462MHz

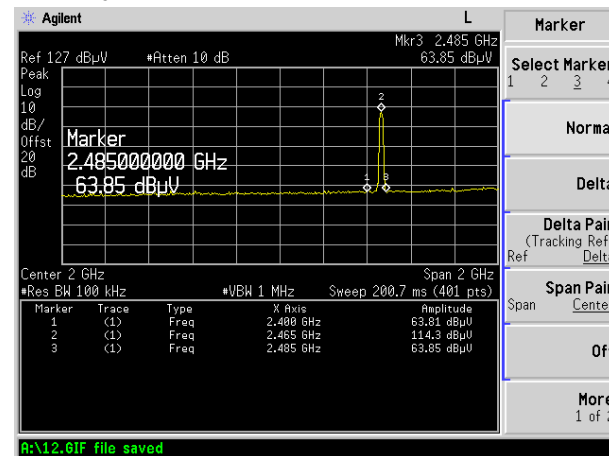
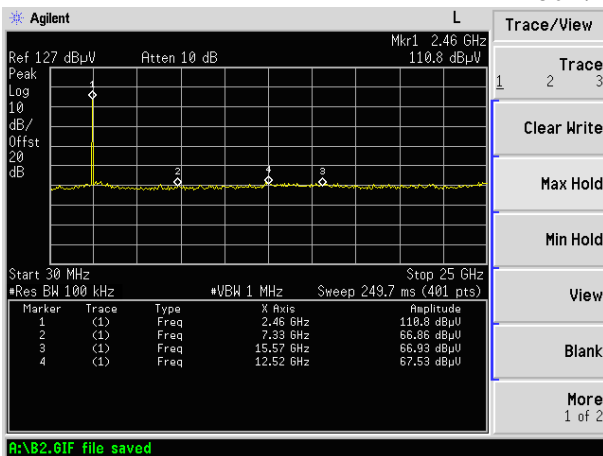

802.11g CH1 2412MHz

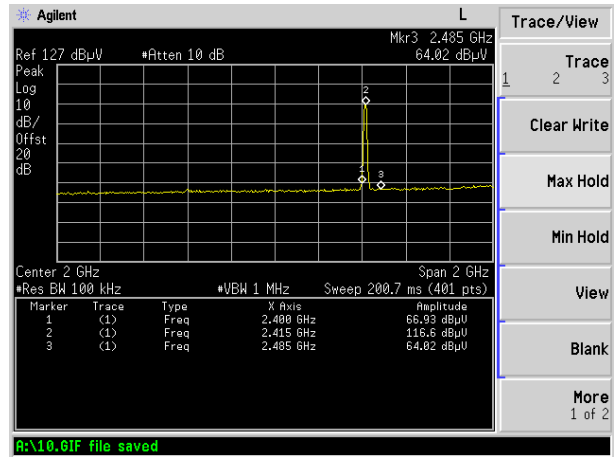
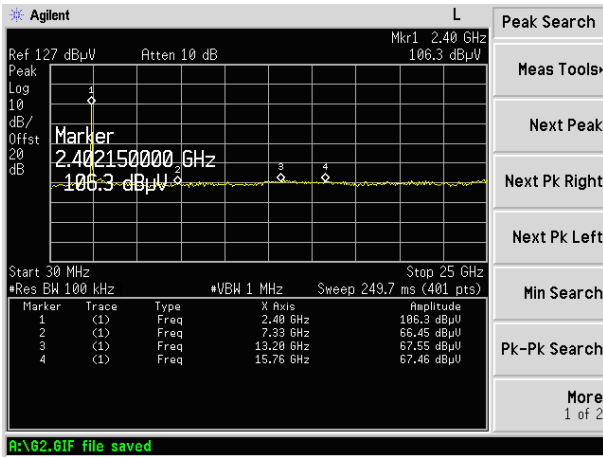

802.11g CH6 2437MHz

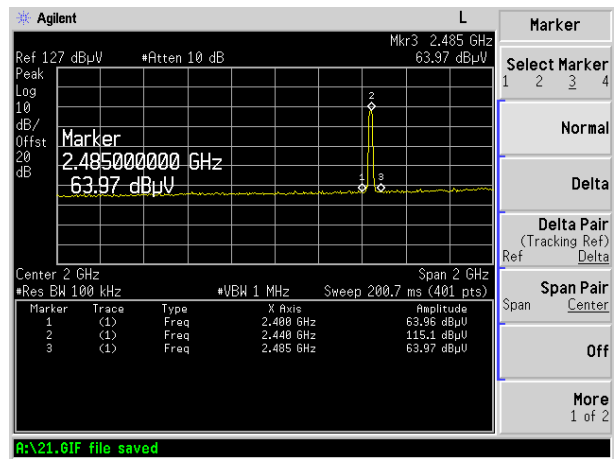
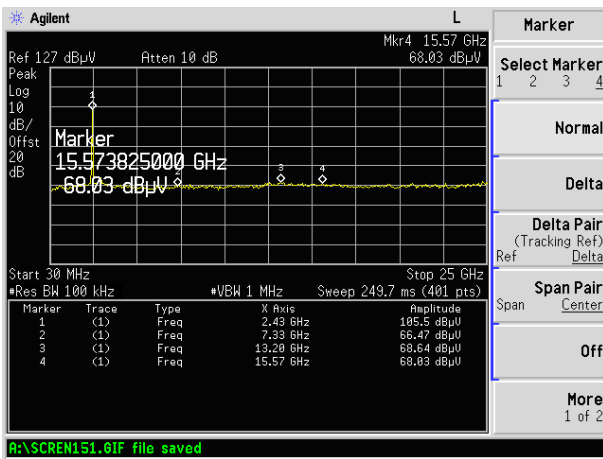

802.11g CH11 2462MHz

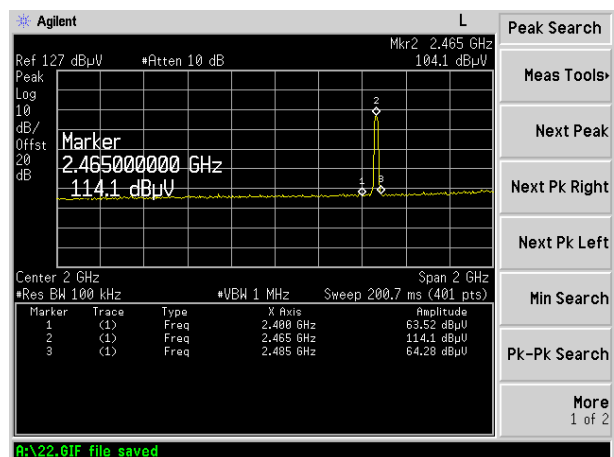
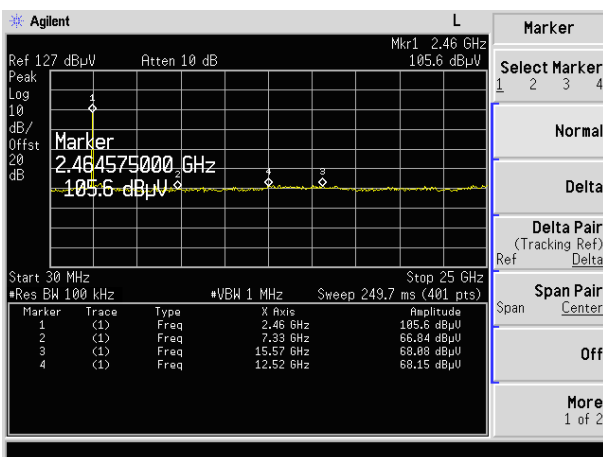

802.11n HT20 CH1 2412MHz

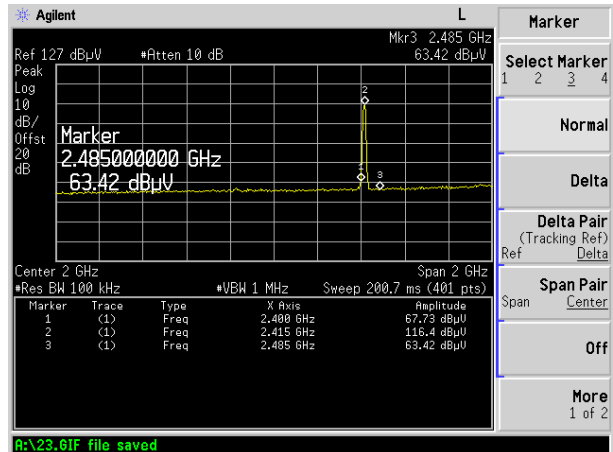
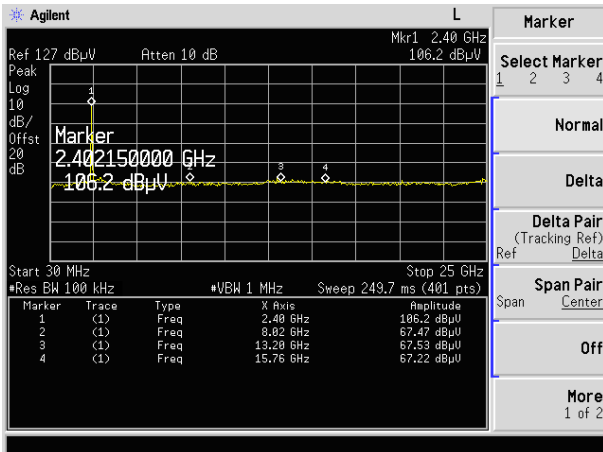

802.11n HT20 CH6 2437MHz

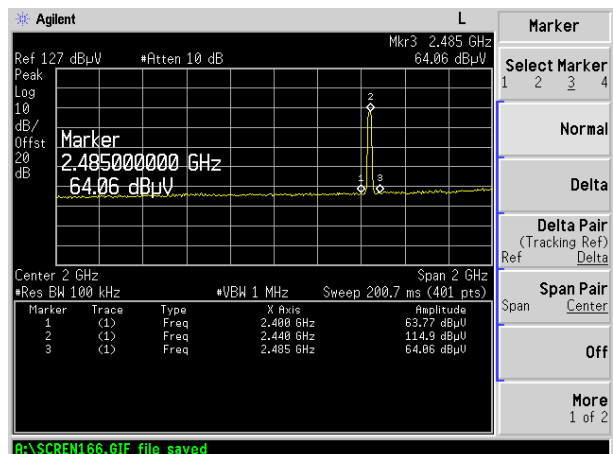
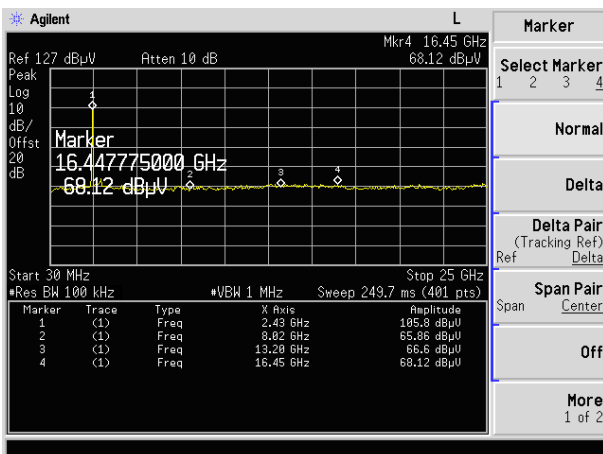

802.11n HT20 CH11 2462MHz

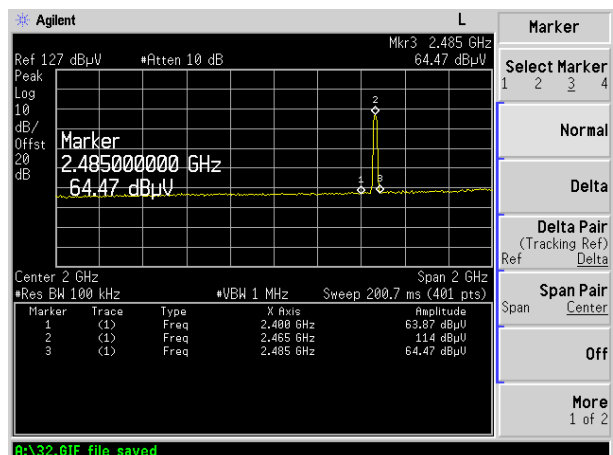
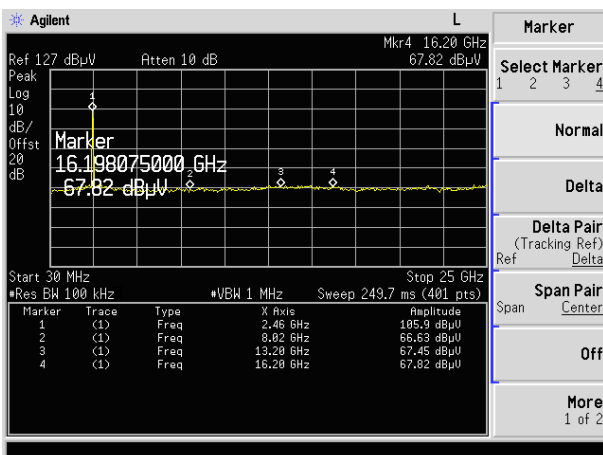

802.11n HT40 CH1 2422MHz

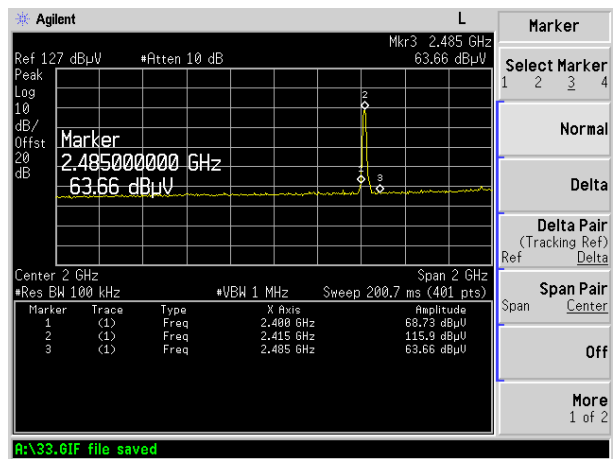
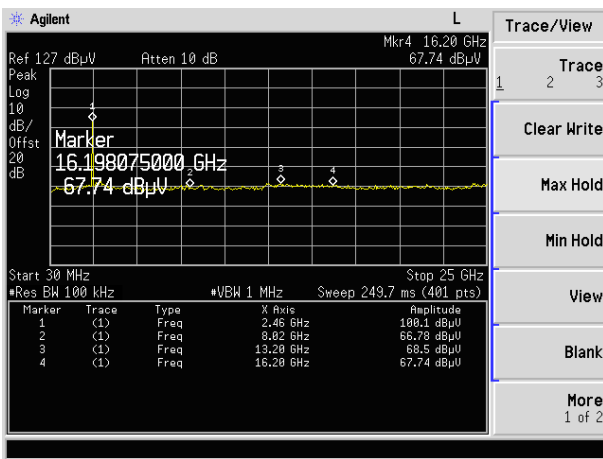

802.11n HT40 CH4 2437MHz

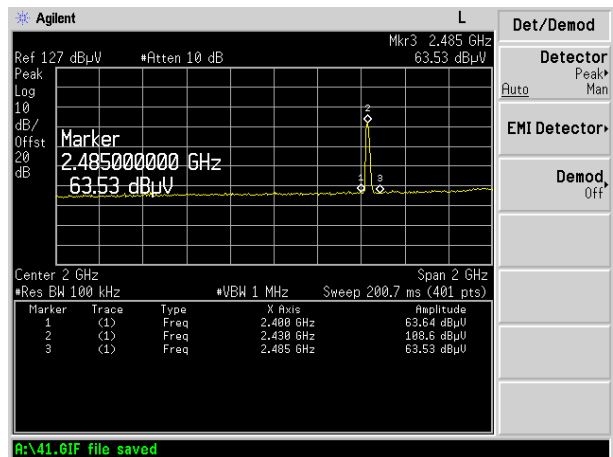
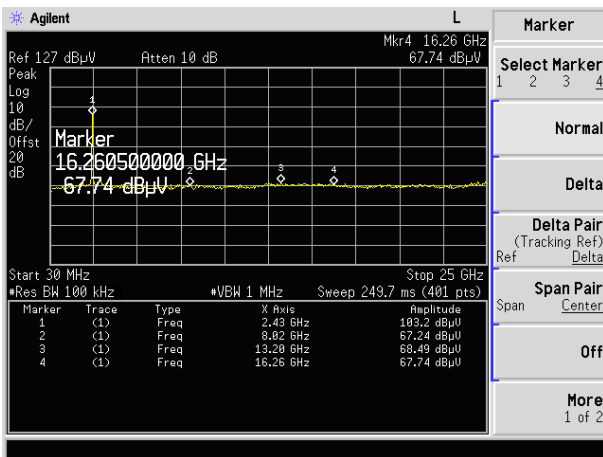

802.11n HT40 CH7 2452MHz

