



# FCC Radio Test Report

## FCC ID: X7D-WL0159

This report concerns (check one) :  Original Grant  Class II Change

**Issued Date** : Mar. 17, 2010  
**Project No.** : 1002C114  
**Equipment** : WIFI MODULE  
**Model Name** : WL0159  
**Applicant** : ZIONCOM TECHNOLOGY LIMITED  
**Address** : Building A1~A2, Iantian Science and Technology Park, Xinyu Road Xinqiao Henggang Block Shajing Street, Baoan District, Shenzhen city

**Tested by:**  
Neutron Engineering Inc. EMC Laboratory  
**Date of Test:**  
Feb. 25, 2010 ~ Mar. 16, 2010

Testing Engineer : Jeff Yang  
(Jeff Yang)

Technical Manager : Vic Chiu  
(Vic Chiu)

Authorized Signatory : Steven Lu  
(Steven Lu)

### NEUTRON ENGINEERING INC.

B1, No. 37, Lane 365, Yang Guang St., NeiHu District 114., Taipei, Taiwan  
TEL : (02) 2657-3299 FAX : (02) 2657-3331



### **Declaration**

**Neutron** represents to the client that testing is done in accordance with standard procedures as applicable and that test instruments used has been calibrated with the standards traceable to National Measurement Laboratory (**NML**) of **R.O.C.**, or National Institute of Standards and Technology (**NIST**) of **U.S.A.**

**Neutron's** reports apply only to the specific samples tested under conditions. It is manufacture's responsibility to ensure that additional production units of this model are manufactured with the identical electrical and mechanical components. **Neutron** shall have no liability for any declarations, inferences or generalizations drawn by the client or others from **Neutron** issued reports.

**Neutron's** reports must not be used by the client to claim product endorsement by the authorities or any agency of the Government.

This report is the confidential property of the client. As a mutual protection to the clients, the public and **Neutron-self**, extracts from the test report shall not be reproduced except in full with **Neutron's** authorized written approval.

**Neutron's** laboratory quality assurance procedures are in compliance with the **ISO Guide 17025** requirements, and accredited by the conformity assessment authorities listed in this test report.

### **Limitation**

For the use of the authority's logo is limited unless the Test Standard(s)/Scope(s)/Item(s) mentioned in this test report is (are) included in the conformity assessment authorities acceptance respective.



<b>Table of Contents</b>	<b>Page</b>
<b>1 . CERTIFICATION</b>	<b>5</b>
<b>2 . SUMMARY OF TEST RESULTS</b>	<b>6</b>
2.1 TEST FACILITY	7
2.2 MEASUREMENT UNCERTAINTY	7
<b>3 . GENERAL INFORMATION</b>	<b>8</b>
3.1 GENERAL DESCRIPTION OF EUT	8
3.2 DESCRIPTION OF TEST MODES	10
3.3 TABLE OF PARAMETERS OF TEXT SOFTWARE SETTING	11
3.4 BLOCK DIGRAM SHOWING THE CONFIGURATION OF SYSTEM TESTED	11
3.5 DESCRIPTION OF SUPPORT UNITS	12
<b>4 . EMC EMISSION TEST</b>	<b>13</b>
4.1 CONDUCTED EMISSION MEASUREMENT	13
4.1.1 POWER LINE CONDUCTED EMISSION LIMITS	13
4.1.2 MEASUREMENT INSTRUMENTS LIST AND SETTING	13
4.1.3 TEST PROCEDURE	14
4.1.4 DEVIATION FROM TEST STANDARD	14
4.1.5 TEST SETUP	14
4.1.6 EUT OPERATING CONDITIONS	14
4.1.7 TEST RESULTS	15
4.2 RADIATED EMISSION MEASUREMENT	17
4.2.1 RADIATED EMISSION LIMITS	17
4.2.2 MEASUREMENT INSTRUMENTS LIST ANS SETTING	18
4.2.3 TEST PROCEDURE	19
4.2.4 DEVIATION FROM TEST STANDARD	19
4.2.5 TEST SETUP	20
4.2.6 EUT OPERATING CONDITIONS	20
4.2.7 TEST RESULTS (BETWEEN30 – 1000 MHZ)	21
4.2.8 TEST RESULTS (ABOVE 1000 MHZ)	23
4.2.9 TEST RESULTS (RESTRICTED BANDS REQUIREMENTS)	47
<b>5 . BANDWIDTH TEST</b>	<b>55</b>
5.1 APPLIED PROCEDURES / LIMIT	55
5.1.1 MEASUREMENT INSTRUMENTS LIST	55
5.1.2 TEST PROCEDURE	55
5.1.3 DEVIATION FROM STANDARD	55
5.1.4 TEST SETUP	56
5.1.5 EUT OPERATION CONDITIONS	56



<b>Table of Contents</b>	<b>Page</b>
5.1.6 TEST RESULTS	57
<b>6 . PEAK OUTPUT POWER TEST</b>	<b>61</b>
6.1 APPLIED PROCEDURES / LIMIT	61
6.1.1 MEASUREMENT INSTRUMENTS LIST	61
6.1.2 TEST PROCEDURE	61
6.1.3 DEVIATION FROM STANDARD	61
6.1.4 TEST SETUP	61
6.1.5 EUT OPERATION CONDITIONS	61
6.1.6 TEST RESULTS	62
<b>7 . ANTENNA CONDUCTED SPURIOUS EMISSION</b>	<b>63</b>
7.1 APPLIED PROCEDURES / LIMIT	63
7.1.1 MEASUREMENT INSTRUMENTS LIST	63
7.1.2 TEST PROCEDURE	63
7.1.3 DEVIATION FROM STANDARD	63
7.1.4 TEST SETUP	63
7.1.5 EUT OPERATION CONDITIONS	64
7.1.6 TEST RESULTS	65
<b>8 . POWER SPECTRAL DENSITY TEST</b>	<b>69</b>
8.1 APPLIED PROCEDURES / LIMIT	69
8.1.1 MEASUREMENT INSTRUMENTS LIST	69
8.1.2 TEST PROCEDURE	69
8.1.3 DEVIATION FROM STANDARD	69
8.1.4 TEST SETUP	69
8.1.5 EUT OPERATION CONDITIONS	69
8.1.6 TEST RESULTS	70
<b>9 . RF EXPOSURE TEST</b>	<b>74</b>
9.1 APPLIED PROCEDURES / LIMIT	74
9.1.1 MPE CALCULATION METHOD	74
9.1.2 DEVIATION FROM STANDARD	74
9.1.3 EUT OPERATION CONDITIONS	74
9.1.4 TEST RESULTS	75
<b>10 . EUT TEST PHOTO</b>	<b>76</b>



## 1. CERTIFICATION

Equipment: WIFI MODULE  
Brand Name : N/A  
Model Name : WL0159  
Applicant: ZIONCOM TECHNOLOGY LIMITED  
Date of Test: Feb. 25, 2010 ~ Mar. 16, 2010  
Test Item: ENGINEERING SAMPLE  
Standards: FCC Part15, Subpart C(15.247) / ANCI C63.4 : 2003

The above equipment has been tested and found compliance with the requirement of the relative standards by Neutron Engineering Inc. EMC Laboratory.

The test data, data evaluation, and equipment configuration contained in our test report (Ref No. NEI-FCCP-1-1002C114) were obtained utilizing the test procedures, test instruments, test sites that has been accredited by the Authority of NVLAP and TAF according to the ISO-17025 quality assessment standard and technical standard(s).



**2. SUMMARY OF TEST RESULTS**

Test procedures according to the technical standards:

<b>FCC Part15 (15.247) , Subpart C</b>				
Standard	Section	Test Item	Judgment	Remark
	15.207	Conducted Emission	PASS	
	15.247 (c)	Antenna conducted Spurious Emission	PASS	
	15.247 (a)(2)	6dB Bandwidth	PASS	
	15.247 (b)	Peak Output Power	PASS	
	15.247 (c)	Radiated Spurious Emission	PASS	
	15.247 (d)	Power Spectral Density	PASS	
	15.203	Antenna Requirement	PASS	
	1.1307 1.1310 2.1091 2.1093	RF Exposure Compliance	PASS	

**NOTE:**

(1) "N/A" denotes test is not applicable in this Test Report



**2.1 TEST FACILITY**

The test facilities used to collect the test data in this report is **CB03/DG-C03** at the location of No.3,Jinshagang 1st Road, ShiXia, Dalang Town, Dong Guan, China.523792

Neutron's test firm number is 319330

**2.2 MEASUREMENT UNCERTAINTY**

The reported uncertainty of measurement  $y \pm U$ , where expanded uncertainty **U** is based on a standard uncertainty multiplied by a coverage factor of **k=2**, providing a level of confidence of approximately **95 %**.

A. Conducted Measurement :

Test Site	Method	Measurement Frequency Range	U , (dB)	NOTE
DG-CO3	ANSI	150 KHz ~ 30MHz	1.94	

B. Radiated Measurement :

Test Site	Method	Measurement Frequency Range	Ant. H / V	U , (dB)	NOTE
CB03	ANSI	30MHz ~ 200MHz	V	3.82	
		30MHz ~ 200MHz	H	3.60	
		200MHz ~ 1,000MHz	V	3.86	
		200MHz ~ 1,000MHz	H	3.94	



**3. GENERAL INFORMATION**

**3.1 GENERAL DESCRIPTION OF EUT**

Equipment	WIFI MODULE	
Brand Name	N/A	
Model Name	WL0159	
OEM Brand/Model Name	N/A	
Model Difference	N/A	
Product Description	The EUT is a WIFI MODULE.	
	Operation Frequency:	2412~2462 MHz
	Modulation Type:	802.11b:CCK, DQPSK, DBPSK 802.11g:OFDM
	Bit Rate of Transmitter	802.11b:11/5.5/2/1 Mbps 802.11g:54/48/36/24/18/12/9/6 Mbps
	Number Of Channel	11 CH, Please see Note 2. (please see page 9)
	Antenna Designation:	Please see Note 3.
	Antenna Gain(Peak)	(please see page 9)
	Output Power:	802.11b:13.19 dBm 802.11g:13.41 dBm
	Based on the application, features, or specification exhibited in User's Manual, the EUT is considered as an ITE/Computing Device. More details of EUT technical specification, please refer to the User's Manual.	
Channel List	Please refer to the Note 2.	
Power Source	DC Voltage supplied from Host System	
Power Rating	I/P AC 120V/60Hz , O/P DC 5V	
Connecting I/O Port(s)	Please refer to the User's Manual	
Products Covered	N/A	
EUT Modification(s)	N/A	

**Note**

:

1. For a more detailed features description, please refer to the manufacturer's specifications or the User's Manual.





2 CH 01 – CH 11 for 802.11b, 802.11g

Channel List							
Channel	Frequency (MHz)	Channel	Frequency (MHz)	Channel	Frequency (MHz)	Channel	Frequency (MHz)
01	2412	04	2427	07	2442	10	2457
02	2417	05	2432	08	2447	11	2462
03	2422	06	2437	09	2452		

3

. Table for Filed Antenna

Ant.	Brand	Model Name	Antenna Type	Connector	Gain (dBi)
1	OMEGA TECH.	DK-2.45P-CP1	Patch ANT	N/A	2.0



**3.2 DESCRIPTION OF TEST MODES**

To investigate the maximum EMI emission characteristics generates from EUT, the test system was pre-scanning tested base on the consideration of following EUT operation mode or test configuration mode which possible have effect on EMI emission level. Each of these EUT operation mode(s) or test configuration mode(s) mentioned above was evaluated respectively.

Pretest Mode	Description
Mode 1	TX B MODE CHANNEL 01//06/11
Mode 2	TX G MODE CHANNEL 01/06/11
Mode 3	NORMAL LINK

For Conducted Test	
Final Test Mode	Description
Mode 3	NORMAL LINK

For Radiated Test	
Final Test Mode	Description
Mode 1	TX B MODE CHANNEL 01//06/11
Mode 2	TX G MODE CHANNEL 01/06/11

Note:

(1) The measurements are performed at the highest, middle, lowest available channels.

### 3.3 TABLE OF PARAMETERS OF TEXT SOFTWARE SETTING

During testing channel & power controlling software provided by the customer was used to control the operating channel as well as the output power level. The RF output power selection is for the setting of RF output power expected by the customer and is going to be fixed on the firmware of the final end product power parameters of WLAN

Test software Version	Test Program: QAU2571W		
Frequency	2412 MHz	2437 MHz	2462 MHz
IEEE 802.11b DSSS	0F	0B	0E
IEEE 802.11g OFDM	0A	0E	0A

### 3.4 BLOCK DIGRAM SHOWING THE CONFIGURATION OF SYSTEM TESTED

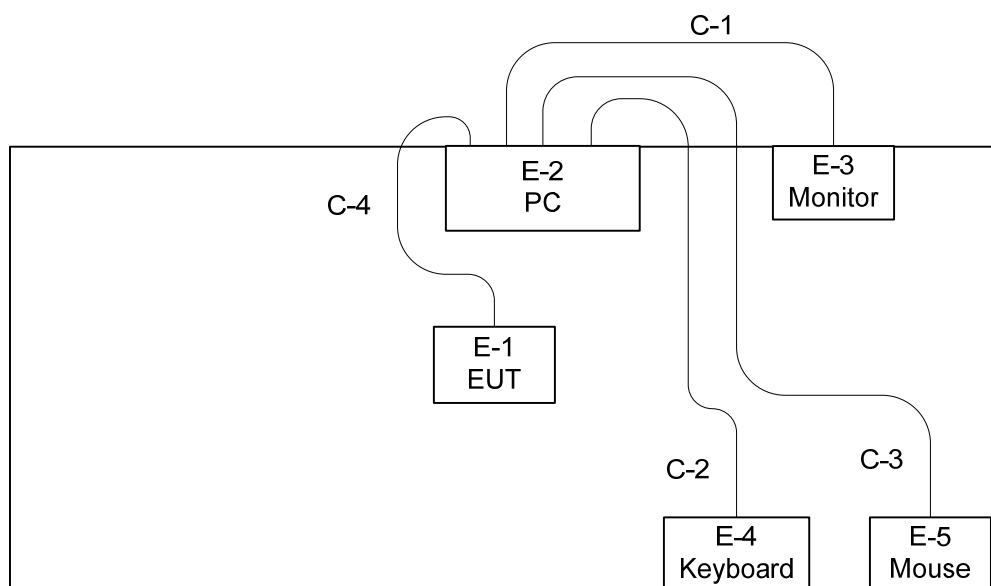

C-1: D-Sub Cable  
 C-2: USB Cable  
 C-3 :USB Cable  
 C-4 :USB Cable



**3.5 DESCRIPTION OF SUPPORT UNITS**

The EUT has been tested as an independent unit together with other necessary accessories or support units. The following support units or accessories were used to form a representative test configuration during the tests.

Item	Equipment	Mfr/Brand	Model/Type No.	FCC ID	Series No.	Note
E-1	WIFI MODULE	N/A	WL0159	X7D-WL0159	N/A	EUT
E-2	PC	HP	Dx7400	DOC	CNG7430PWL	
E-3	LCD monitor	Dell	E177FPc	DOC	CNOFJ179-6418 0-6AG-1WNS	
E-4	USB Keyboard	Dell	L100	DOC	CNORH6596589 085C00U7	
E-5	USB Mouse	Lenovo	MO28UOL	DOC	23-122591	

Item	Shielded Type	Ferrite Core	Length	Note
C-1	YES	YES	1.5M	
C-2	YES	YES	2.0M	
C-3	YES	YES	2.0M	
C-4	YES	NO	0.6M	

Note:

- (1) The support equipment was authorized by Declaration of Confirmation.
- (2) For detachable type I/O cable should be specified the length in cm in 『Length』 column.



**4. EMC EMISSION TEST**

**4.1 CONDUCTED EMISSION MEASUREMENT**

**4.1.1 POWER LINE CONDUCTED EMISSION Limits (Frequency Range 150KHz-30MHz)**

FREQUENCY (MHz)	Class A (dBuV)		Class B (dBuV)		Standard
	Quasi-peak	Average	Quasi-peak	Average	
0.15 -0.5	79.00	66.00	66 - 56 *	56 - 46 *	CISPR
0.50 -5.0	73.00	60.00	56.00	46.00	CISPR
5.0 -30.0	73.00	60.00	60.00	50.00	CISPR

0.15 -0.5	79.00	66.00	66 - 56 *	56 - 46 *	FCC
0.50 -5.0	73.00	60.00	56.00	46.00	FCC
5.0 -30.0	73.00	60.00	60.00	50.00	FCC

Note:

- (1) The tighter limit applies at the band edges.
- (2) The limit of " \* " marked band means the limitation decreases linearly with the logarithm of the frequency in the range.

**4.1.2 MEASUREMENT INSTRUMENTS LIST AND SETTING**

Item	Kind of Equipment	Manufacturer	Type No.	Serial No.	Calibrated until
1	LISN	EMCO	3816/2	00052765	Jun.01.2010
2	LISN	Rolf Heine	NNB-2-16Z	99044	Jun.01.2010
3	50Ω Terminator	SHX	TF2-3G-A	08122901	Jun.01.2010
4	Transient Limiter	Agilent	11947A	3107A03668	Jun.01.2010
5	Test Cable	N/A	C-06_C03	N/A	Nov.16.2010
6	Test Receiver	R&S	ESCI	100382	Jun.02.2010

Remark: " N/A" denotes No Model Name. , Serial No. or No Calibration specified.

The following table is the setting of the receiver

Receiver Parameters	Setting
Attenuation	10 dB
Start Frequency	0.15 MHz
Stop Frequency	30 MHz
IF Bandwidth	9 kHz

#### 4.1.3 TEST PROCEDURE

- The EUT was placed 0.4 meters from the horizontal ground plane with EUT being connected to the power mains through a line impedance stabilization network (LISN). All other support equipments powered from additional LISN(s). The LISN provide 50 Ohm/ 50uH of coupling impedance for the measuring instrument.
- Interconnecting cables that hang closer than 40 cm to the ground plane shall be folded back and forth in the center forming a bundle 30 to 40 cm long.
- I/O cables that are not connected to a peripheral shall be bundled in the center. The end of the cable may be terminated, if required, using the correct terminating impedance. The overall length shall not exceed 1 m.
- LISN at least 80 cm from nearest part of EUT chassis.
- For the actual test configuration, please refer to the related Item –EUT Test Photos.

#### 4.1.4 DEVIATION FROM TEST STANDARD

No deviation

#### 4.1.5 TEST SETUP

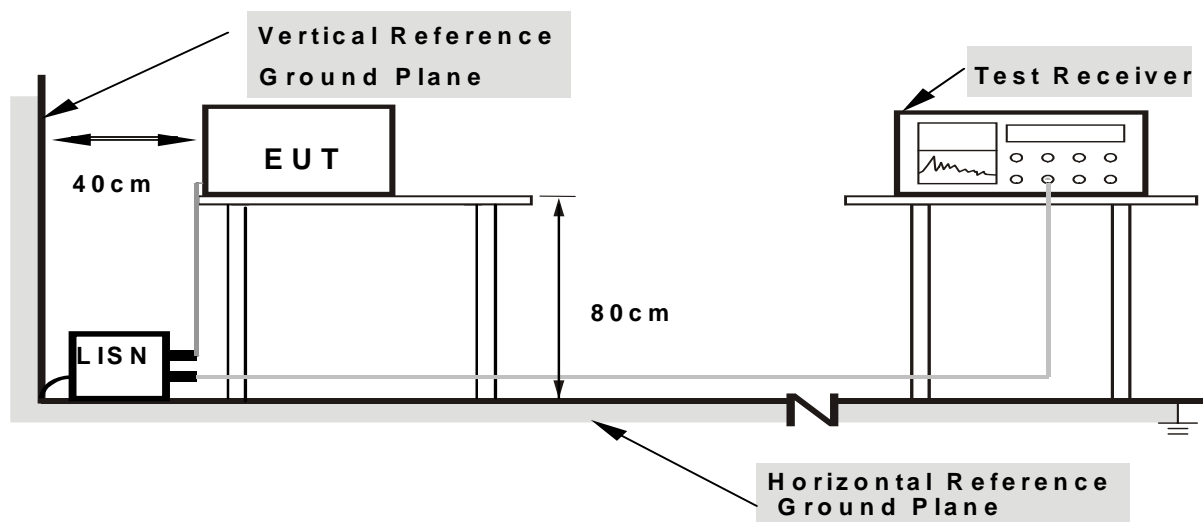

**Note: 1. Support units were connected to second LISN.**

**2. Both of LISNs (AMN) are 80 cm from EUT and at least 80 from other units and other metal planes**

#### 4.1.6 EUT OPERATING CONDITIONS

The EUT was configured for testing in a typical fashion (as a customer would normally use it). The EUT has been programmed to continuously transmit during test. This operating condition was tested and used to collect the included data.



**4.1.7 TEST RESULTS**

EUT :	WIFI MODULE	Model Name :	WL0159
Temperature :	23 °C	Relative Humidity :	51 %
Pressure :	1010hPa	Test Power :	AC 120V/60Hz
Test Mode :	Normal Link		

Freq. (MHz)	Terminal L/N	Measured(dBuV)		Limits(dBuV)		Margin (dB)	Note
		QP-Mode	AV-Mode	QP-Mode	AV-Mode		
0.20	Line	44.61	*	63.81	53.81	-19.20	(QP)
0.26	Line	37.07	*	61.46	51.46	-24.39	(QP)
0.33	Line	33.99	*	59.54	49.54	-25.55	(QP)
0.39	Line	30.31	*	58.04	48.04	-27.73	(QP)
0.70	Line	31.66	*	56.00	46.00	-24.34	(QP)
17.56	Line	31.65	*	60.00	50.00	-28.35	(QP)

**Remark**

- (1) All readings are QP Mode value unless otherwise stated AVG in column of 'Note'. If the QP Mode Measured value compliance with the QP Limits and lower than AVG Limits, the EUT shall be deemed to meet both QP & AVG Limits and then only QP Mode was measured, but AVG Mode didn't perform. In this case, a "\*" marked in AVG Mode column of Interference Voltage Measured.
- (2) Measuring frequency range from 150KHz to 30MHz.

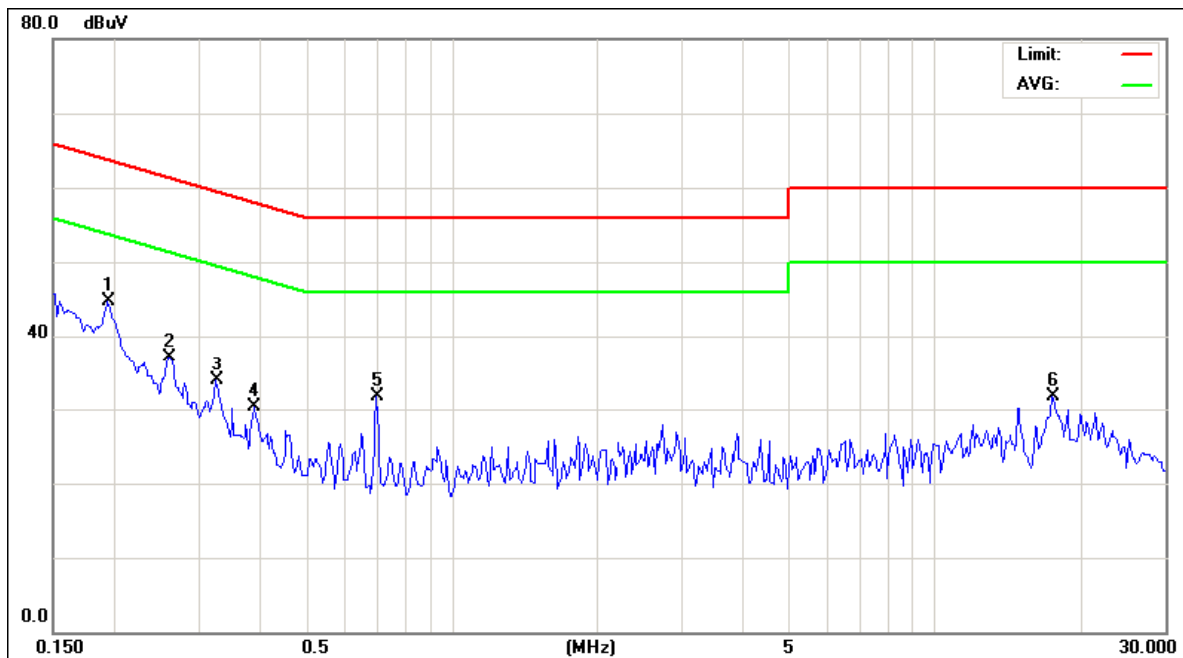



EUT :	WIFI MODULE	Model Name :	WL0159
Temperature :	23 °C	Relative Humidity :	51 %
Pressure :	1010hPa	Test Power :	AC 120V/60Hz
Test Mode :	Normal Link		

Freq. (MHz)	Terminal L/N	Measured(dBuV)		Limits(dBuV)		Margin (dB)	Note
		QP-Mode	AV-Mode	QP-Mode	AV-Mode		
0.20	Neutral	44.57	*	63.81	53.81	-19.24	(QP)
0.26	Neutral	37.41	*	61.49	51.49	-24.08	(QP)
0.33	Neutral	34.69	*	59.54	49.54	-24.85	(QP)
0.70	Neutral	30.05	*	56.00	46.00	-25.95	(QP)
2.41	Neutral	30.95	*	56.00	46.00	-25.05	(QP)
21.52	Neutral	31.36	*	60.00	50.00	-28.64	(QP)

**Remark**

- (1) All readings are QP Mode value unless otherwise stated AVG in column of 'Note'. If the QP Mode Measured value compliance with the QP Limits and lower than AVG Limits, the EUT shall be deemed to meet both QP & AVG Limits and then only QP Mode was measured, but AVG Mode didn't perform. In this case, a "\*" marked in AVG Mode column of Interference Voltage Measured.
- (2) Measuring frequency range from 150KHz to 30MHz.

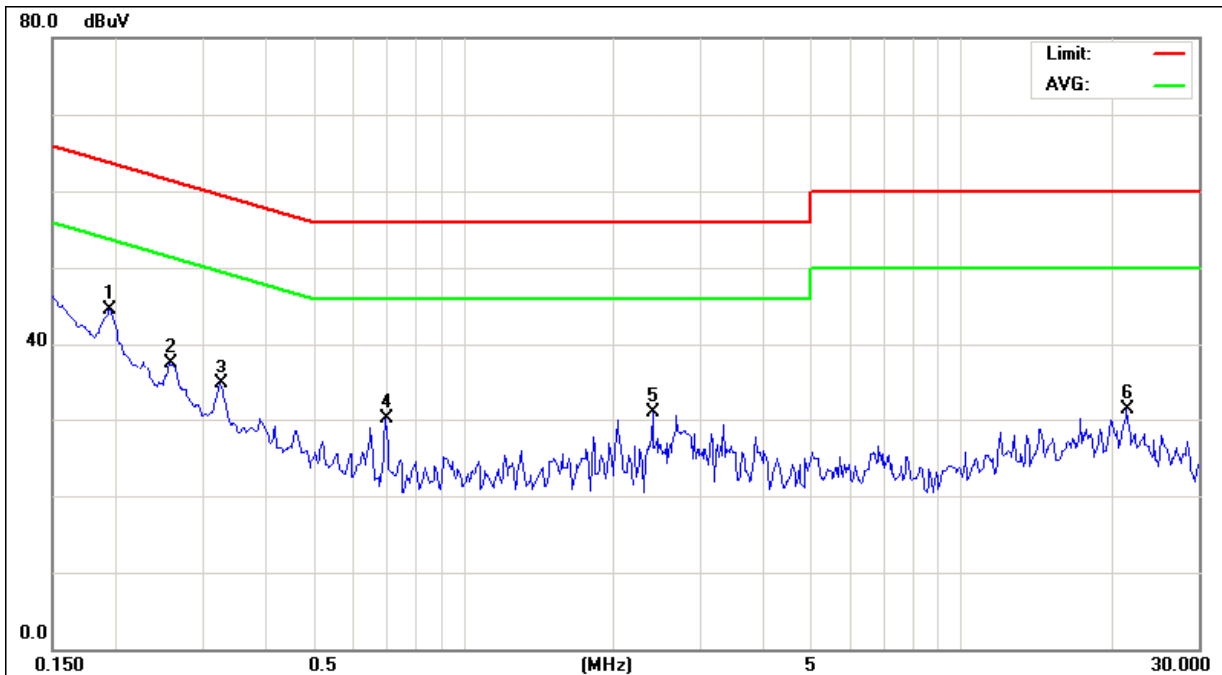





**4.2 RADIATED EMISSION MEASUREMENT**

**4.2.1 RADIATED EMISSION LIMITS (Frequency Range 9KHz-1000MHz)**

20dBc in any 100 kHz bandwidth outside the operating frequency band. In case the emission fall within the restricted band specified on 15.205(a), then the 15.209(a) limit in the table below has to be followed.

Frequencies (MHz)	Field Strength (micorvolts/meter)	Measurement Distance (meters)
0.009~0.490	2400/F(KHz)	300
0.490~1.705	24000/F(KHz)	30
1.705~30.0	30	30
30~88	100	3
88~216	150	3
216~960	200	3
Above 960	500	3

**LIMITS OF RADIATED EMISSION MEASUREMENT (Above 1000MHz)**

FREQUENCY (MHz)	Class A (dBuV/m) (at 3m)		Class B (dBuV/m) (at 3m)	
	PEAK	AVERAGE	PEAK	AVERAGE
Above 1000	80	60	74	54

Notes:

- (1) The limit for radiated test was performed according to FCC PART 15C.
- (2) The tighter limit applies at the band edges.
- (3) Emission level (dBuV/m)=20log Emission level (uV/m).

**FREQUENCY RANGE OF RADIATED MEASUREMENT (For unintentional radiators)**

Highest frequency generated or Upper frequency of measurement used in the device or on which the device operates or tunes (MHz)	Range (MHz)
Below 1.705	30
1.705 – 108	1000
108 – 500	2000
500 – 1000	5000
Above 1000	5 <sup>th</sup> harmonic of the highest frequency or 40 GHz, whichever is lower



**4.2.2 MEASUREMENT INSTRUMENTS LIST AND SETTING**

Item	Kind of Equipment	Manufacturer	Type No.	Serial No.	Calibrated until
1	Antenna	ETS	3115	00075789	May.13.2010
2	Amplifier	Agilent	8449B	3008A02274	Jun.01.2010
3	Spectrum	Agilent	E4408B	US39240143	Nov.16.2010
4	Test Cable	HUBER+SUHNER	CB03 High Fre	N/A	May.04.2010
5	Antenna	Schwarbeck	VULB9160	9160-3232	Jun.01.2010
6	Amplifier	HP	8447D	2944A09673	Jun.01.2010
7	Test Receiver	R&S	ESCI	100895	Jun.02.2010
8	Test Cable	N/A	C-01_CB03	N/A	Jul.06.2010

Remark: " N/A" denotes No Model Name / Serial No. and No Calibration specified.

Spectrum Parameter	Setting
Attenuation	Auto
Start Frequency	1000 MHz
Stop Frequency	10th carrier harmonic
RB / VB (Emission in restricted band)	1MHz / 1MHz for Peak, 1 MHz / 10Hz for Average

Receiver Parameter	Setting
Attenuation	Auto
Start ~ Stop Frequency	9kHz~150kHz / RB 200Hz for QP
Start ~ Stop Frequency	150kHz~30MHz / RB 9kHz for QP
Start ~ Stop Frequency	30MHz~1000MHz / RB 120kHz for QP



#### **4.2.3 TEST PROCEDURE**

- a. The measuring distance of at 3 m shall be used for measurements at frequency up to 1GHz. For frequencies above 1GHz, any suitable measuring distance may be used.
- b. The EUT was placed on the top of a rotating table 0.8 meters above the ground at a 3 meter semi-anechoic chamber. The table was rotated 360 degrees to determine the position of the highest radiation.
- c. The height of the equipment or of the substitution antenna shall be 0.8 m; the height of the test antenna shall vary between 1 m to 4 m. Both horizontal and vertical polarizations of the antenna are set to make the measurement.
- d. The initial step in collecting conducted emission data is a spectrum analyzer peak detector mode pre-scanning the measurement frequency range. Significant peaks are then marked and then Quasi Peak detector mode re-measured.
- e. If the Peak Mode measured value compliance with and lower than Quasi Peak Mode Limit, the EUT shall be deemed to meet QP Limits and then no additional QP Mode measurement performed.
- f. For the actual test configuration, please refer to the related Item –EUT Test Photos.

#### **4.2.4 DEVIATION FROM TEST STANDARD**

No deviation

#### 4.2.5 TEST SETUP

(A) Radiated Emission Test Set-Up, Frequency Below 1000MHz

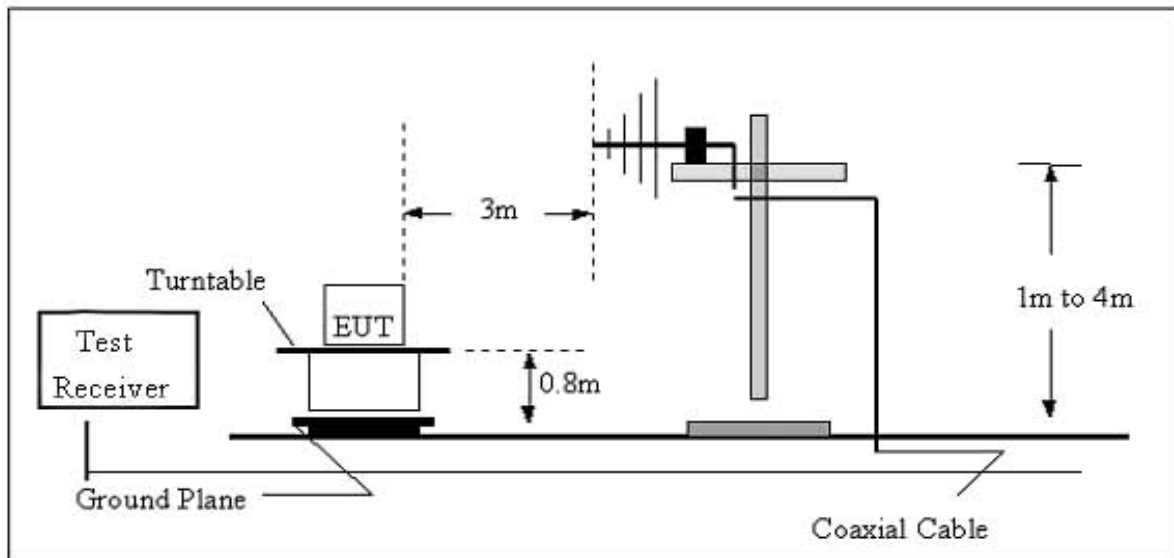

(B) Radiated Emission Test Set-UP Frequency Above 1 GHz

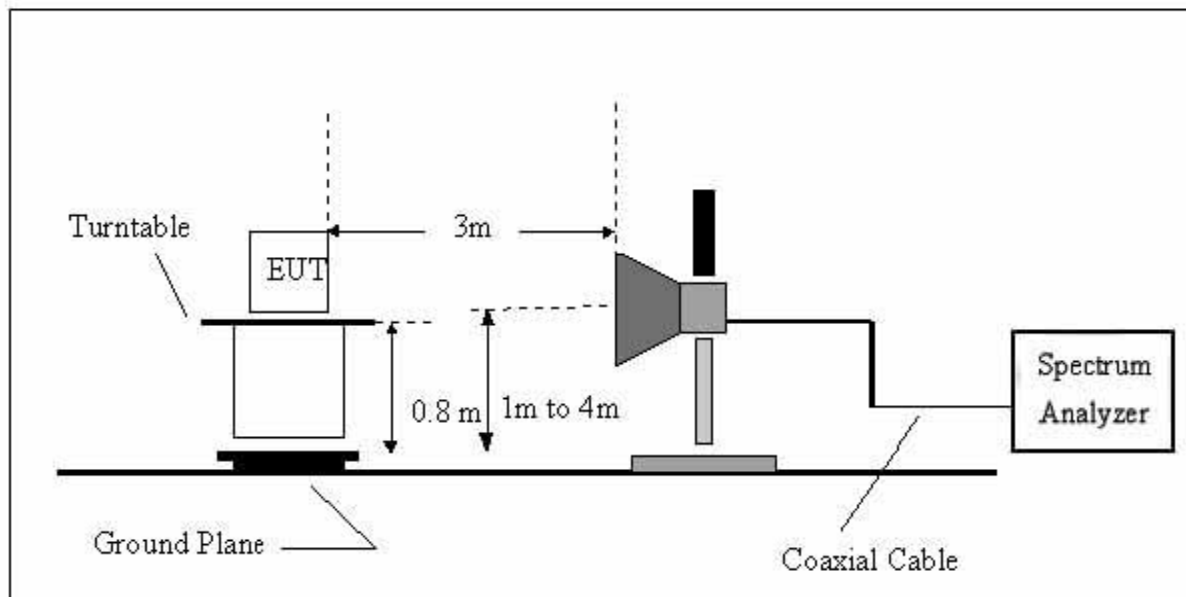

#### 4.2.6 EUT OPERATING CONDITIONS

The EUT tested system was configured as the statements of 4.1.6 Unless otherwise a special operating condition is specified in the follows during the testing.



**4.2.7 TEST RESULTS (BETWEEN 30 – 1000 MHZ)**

EUT :	WIFI MODULE	Model Name :	WL0159
Temperature :	22 °C	Relative Humidity :	45 %
Pressure :	1010 hPa	Test Voltage :	AC 120V/60Hz
Test Mode :	TX B MODE 2412MHz		

Freq. (MHz)	Ant. H/V	Reading(RA) (dBuV)	Corr.Factor(CF) (dB)	Measured(FS) (dBuV/m)	Limits(QP) (dBuV/m)	Margin (dB)	Note
82.40	V	51.34	-19.10	32.24	40.00	- 7.76	
166.54	V	51.17	-17.42	33.75	43.50	- 9.75	
400.28	V	46.26	-9.02	37.24	46.00	- 8.76	
600.54	V	40.19	-4.26	35.93	46.00	- 10.07	
660.24	V	39.62	-3.30	36.32	46.00	- 9.68	
725.48	V	40.17	-2.87	37.30	46.00	- 8.70	

**Remark :**

- (1) Reading in which marked as QP or Peak means measurements by using are Quasi-Peak Mode or Peak Mode with Detector BW=120KHz ; SPA setting in RBW=120KHz, VBW =120KHz, Swp. Time = 0.3 sec./MHz ◦
- (2) All readings are Peak unless otherwise stated QP in column of 『Note』 . Peak denotes that the Peak reading compliance with the QP Limits and then QP Mode measurement didn't perform ◦
- (3) Measuring frequency range from 30MHz to 1000MHz ◦
- (4) If the peak scan value lower limit more than 20dB, then this signal data does not show in table ◦

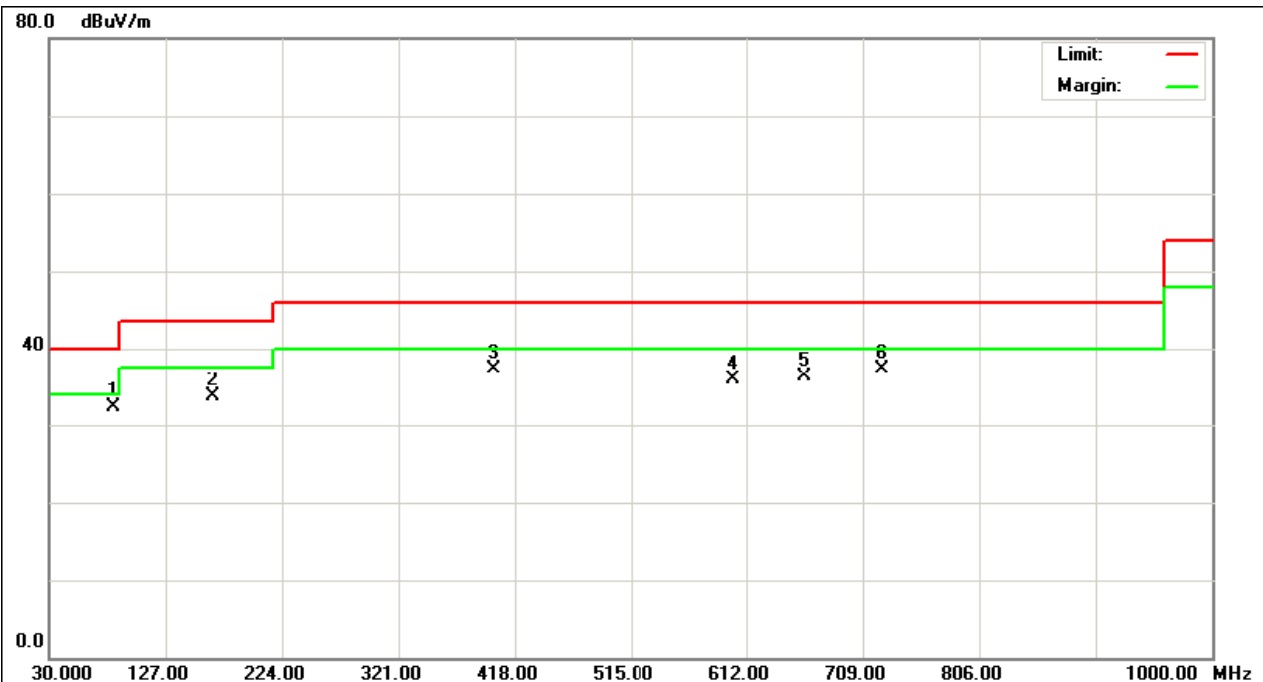



EUT :	WIFI MODULE	Model Name :	WL0159
Temperature :	22 °C	Relative Humidity :	45 %
Pressure :	1010 hPa	Test Voltage :	AC 120V/60Hz
Test Mode :	TX B MODE 2412MHz		

Freq. (MHz)	Ant. H/V	Reading(RA) (dBuV)	Corr.Factor(CF) (dB)	Measured(FS) (dBuV/m)	Limits(QP) (dBuV/m)	Margin (dB)	Note
81.57	H	48.25	-19.08	29.17	40.00	- 10.83	
166.47	H	49.16	-17.43	31.73	43.50	- 11.77	
395.47	H	46.15	-9.18	36.97	46.00	- 9.03	
660.24	H	41.21	-3.30	37.91	46.00	- 8.09	
725.48	H	39.17	-2.87	36.30	46.00	- 9.70	
850.47	H	38.24	-0.86	37.38	46.00	- 8.62	

**Remark :**

- (1) Reading in which marked as QP or Peak means measurements by using are Quasi-Peak Mode or Peak Mode with Detector BW=120KHz ; SPA setting in RBW=120KHz, VBW =120KHz, Swp. Time = 0.3 sec./MHz ◦
- (2) All readings are Peak unless otherwise stated QP in column of 『Note』 . Peak denotes that the Peak reading compliance with the QP Limits and then QP Mode measurement didn't perform ◦
- (3) Measuring frequency range from 30MHz to 1000MHz ◦
- (4) If the peak scan value lower limit more than 20dB, then this signal data does not show in table ◦

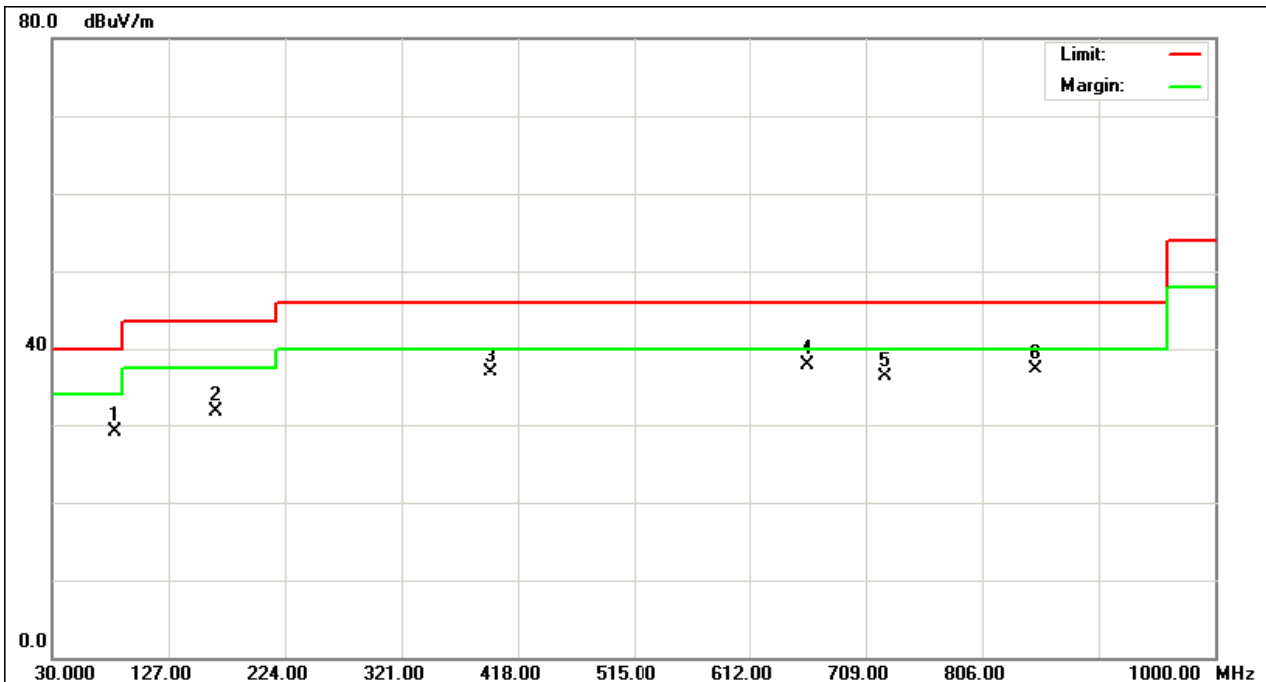



**4.2.8 TEST RESULTS (ABOVE 1000 MHZ)**

EUT :	WIFI MODULE	Model Name :	WL0159
Temperature :	20 °C	Relative Humidity :	51 %
Pressure :	1010 hPa	Test Voltage :	AC 120V/60Hz
Test Mode :	TX B MODE 2412MHz		

Freq. (MHz)	Ant.Pol. H/V	Reading		Ant./CF CF(dB)	Act.		Limit		Note
		Peak (dBuV)	AV (dBuV)		Peak (dBuV/m)	AV (dBuV/m)	Peak (dBuV/m)	AV (dBuV/m)	
2390.00	V	21.54	12.71	31.54	53.08	44.25	74.00	54.00	X/E
<b>2409.30</b>	<b>V</b>	<b>68.92</b>	<b>65.68</b>	<b>31.57</b>	<b>100.49</b>	<b>97.25</b>			<b>X/F</b>
4823.80	V	48.12	45.69	6.86	54.98	52.55	74.00	54.00	X/H

**Remark :**

- (1) All readings are Peak unless otherwise stated QP in column of 『Note』 . Peak denotes that the Peak reading compliance with the QP Limits and then QP Mode measurement didn't perform ◦
- (2) Measuring frequency range from 30MHz to 1000MHz or the 10th harmonic of highest fundamental frequency ◦“F” denotes fundamental frequency; “H” denotes spurious frequency. “E” denotes band edge frequency. (This judgment method includes the Band Edge Requirement.)
- (3) Radiated emissions measured in frequency range above 1000MHz were made with an instrument using Peak detector mode and AV detector mode of the emission ◦
- (4) Data of measurement within this frequency range shown “ \* ” in the table above means the reading of emissions are attenuated more than 20dB below the permissible limits or the field strength is too small to be measured.
- (5) A preamp and high pass filter were used for this test in order to provide sufficient measurement sensitivity.
- (6) EUT Orthogonal Axis :  
“X” - denotes Laid on Table ; ”Y” - denotes Vertical Stand ; ”Z” - denotes Side Stand
- (7) During the measurements above 1 GHz it is taken care of that the EUT is always within the 3 dB cone of radiation BW of the used antenna



TX CH01 (Above 1000 MHz, Vertical)

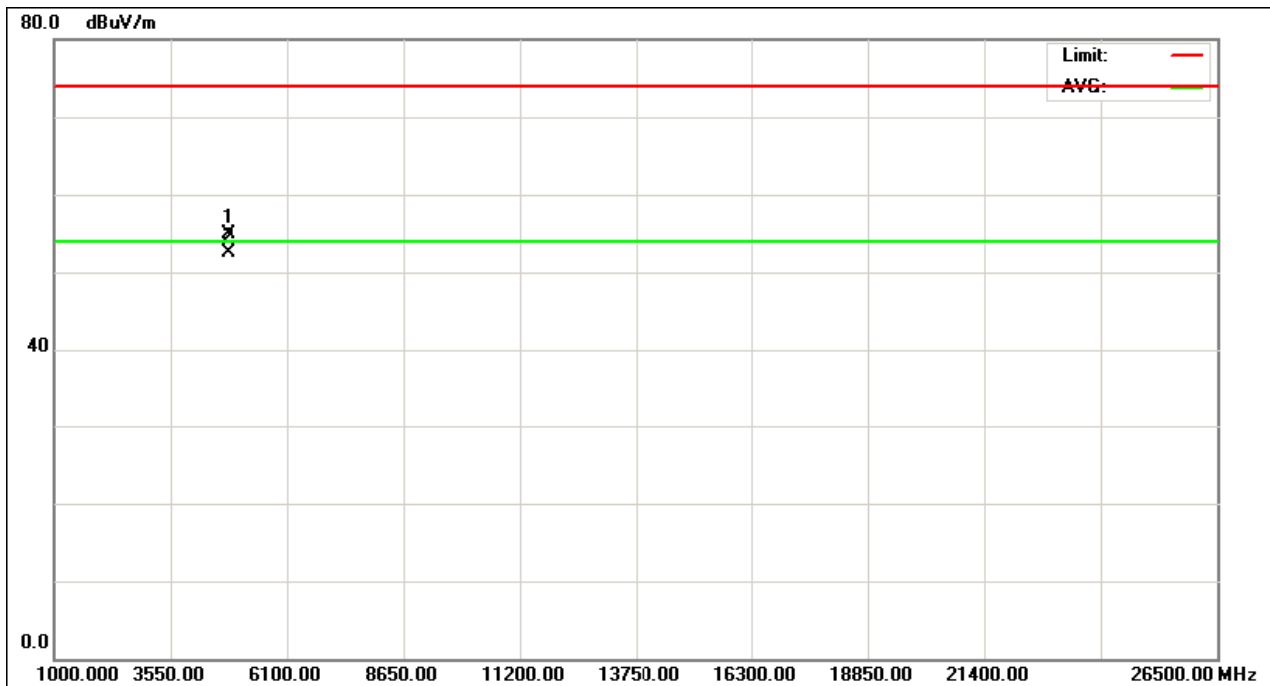
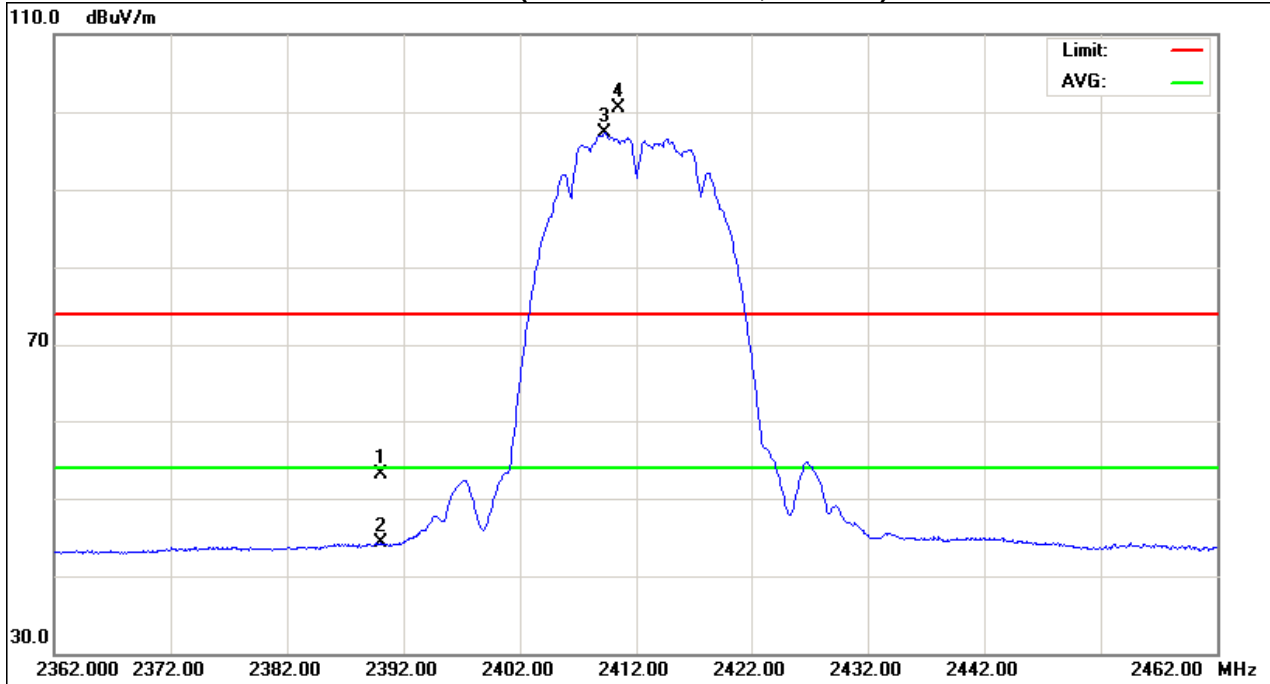





EUT :	WIFI MODULE	Model Name :	WL0159
Temperature :	20 °C	Relative Humidity :	51 %
Pressure :	1010 hPa	Test Voltage :	AC 120V/60Hz
Test Mode :	TX B MODE 2412MHz		

Freq. (MHz)	Ant.Pol. H/V	Reading		Ant./CF CF(dB)	Act.		Limit		Note
		Peak (dBuV)	AV (dBuV)		Peak (dBuV/m)	AV (dBuV/m)	Peak (dBuV/m)	AV (dBuV/m)	
2390.00	H	25.21	13.43	31.54	56.75	44.97	74.00	54.00	X/E
<b>2409.30</b>	<b>H</b>	<b>71.88</b>	<b>68.46</b>	<b>31.57</b>	<b>103.45</b>	<b>100.03</b>			<b>X/F</b>
4823.84	H	48.83	45.69	6.86	55.69	52.55	74.00	54.00	X/H

**Remark :**

- (1) All readings are Peak unless otherwise stated QP in column of 『Note』 . Peak denotes that the Peak reading compliance with the QP Limits and then QP Mode measurement didn't perform ◦
- (2) Measuring frequency range from 30MHz to 1000MHz or the 10th harmonic of highest fundamental frequency ◦ “F” denotes fundamental frequency; “H” denotes spurious frequency. “E” denotes band edge frequency. (This judgment method includes the Band Edge Requirement.)
- (3) Radiated emissions measured in frequency range above 1000MHz were made with an instrument using Peak detector mode and AV detector mode of the emission ◦
- (4) Data of measurement within this frequency range shown “ \* ” in the table above means the reading of emissions are attenuated more than 20dB below the permissible limits or the field strength is too small to be measured.
- (5) A preamp and high pass filter were used for this test in order to provide sufficient measurement sensitivity.
- (6) EUT Orthogonal Axis :  
“X” - denotes Laid on Table ; ”Y” - denotes Vertical Stand ; ”Z” - denotes Side Stand
- (7) During the measurements above 1 GHz it is taken care of that the EUT is always within the 3 dB cone of radiation BW of the used antenna



TX CH01 (Above 1000 MHz, Horizontal)

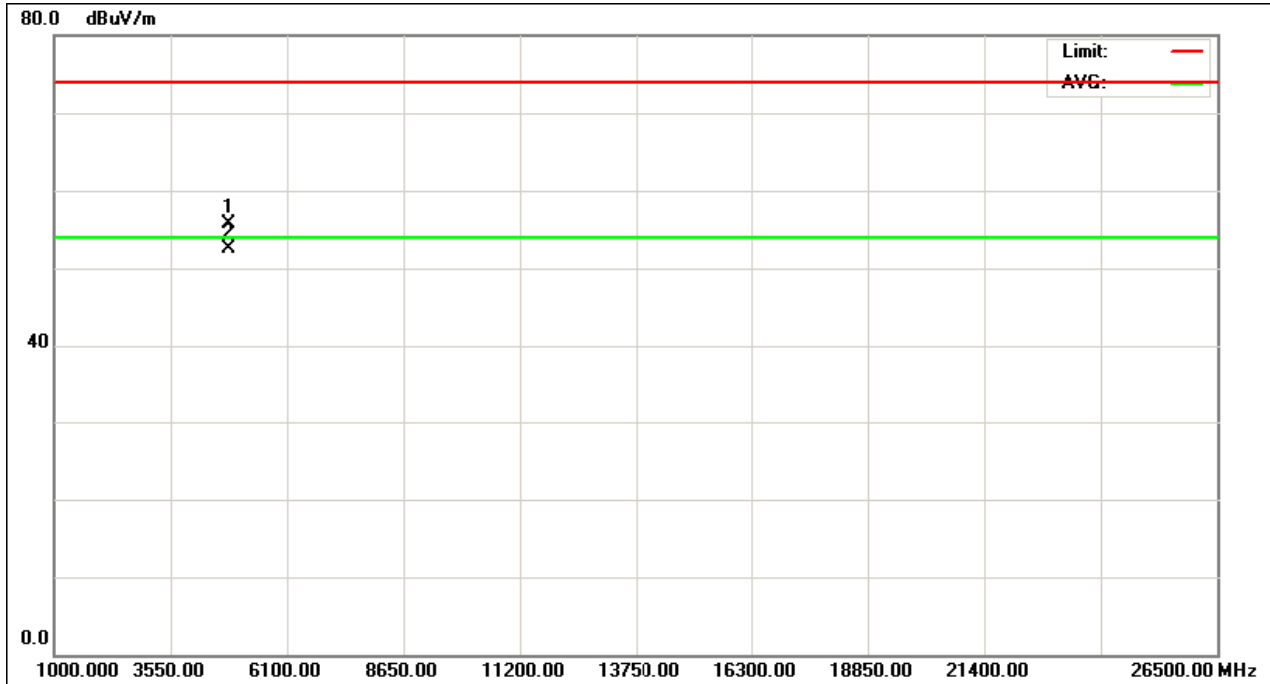
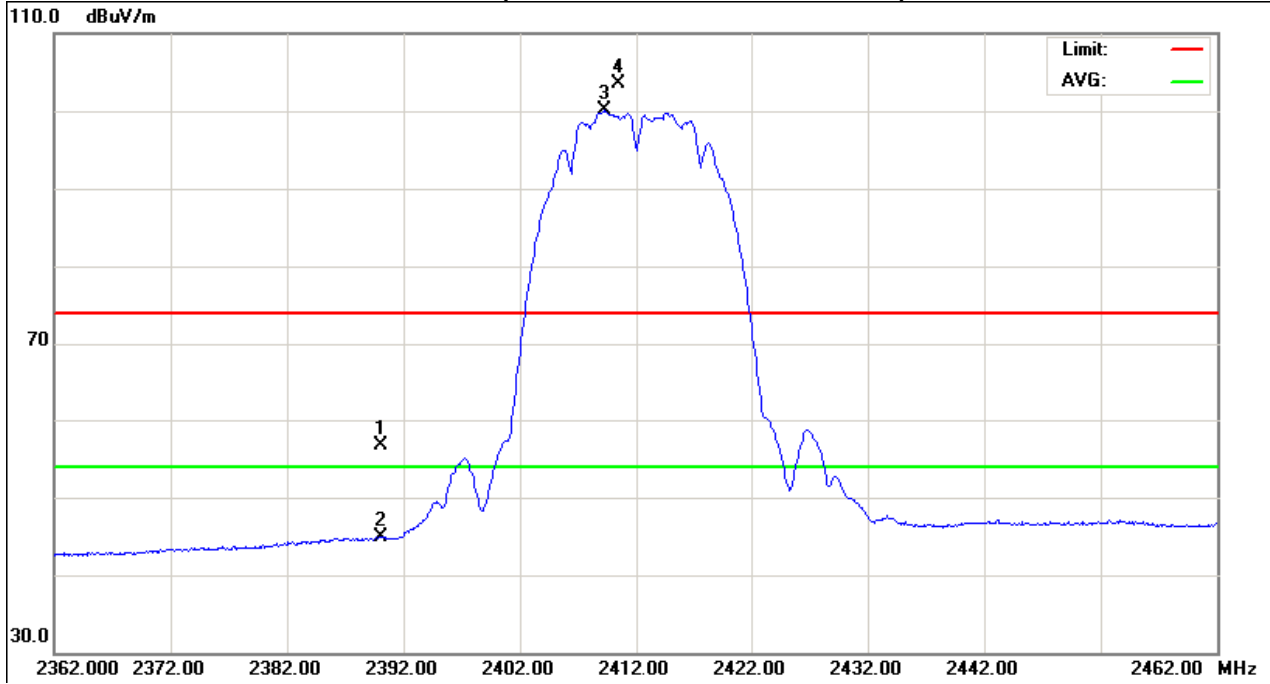



EUT :	WIFI MODULE	Model Name :	WL0159
Temperature :	20 °C	Relative Humidity :	51 %
Pressure :	1010 hPa	Test Voltage :	AC 120V/60Hz
Test Mode :	TX B MODE 2437MHz		

Freq. (MHz)	Ant.Pol. H/V	Reading		Ant./CF CF(dB)	Act.		Limit		Note
		Peak (dBuV)	AV (dBuV)		Peak (dBuV/m)	AV (dBuV/m)	Peak (dBuV/m)	AV (dBuV/m)	
<b>2439.80</b>	<b>V</b>	<b>67.07</b>	<b>64.05</b>	<b>31.62</b>	<b>98.69</b>	<b>95.67</b>			<b>X/F</b>
4873.98	V	47.94	45.10	7.10	55.04	52.20	74.00	54.00	X/H

Remark :

- (1) All readings are Peak unless otherwise stated QP in column of 『Note』 . Peak denotes that the Peak reading compliance with the QP Limits and then QP Mode measurement didn't perform ◦
- (2) Measuring frequency range from 30MHz to 1000MHz or the 10th harmonic of highest fundamental frequency ◦ "F" denotes fundamental frequency; "H" denotes spurious frequency. "E" denotes band edge frequency. (This judgment method includes the Band Edge Requirement.)
- (3) Radiated emissions measured in frequency range above 1000MHz were made with an instrument using Peak detector mode and AV detector mode of the emission ◦
- (4) Data of measurement within this frequency range shown " \* " in the table above means the reading of emissions are attenuated more than 20dB below the permissible limits or the field strength is too small to be measured.
- (5) A preamp and high pass filter were used for this test in order to provide sufficient measurement sensitivity.
- (6) EUT Orthogonal Axis :  
"X" - denotes Laid on Table ; "Y" - denotes Vertical Stand ; "Z" - denotes Side Stand
- (7) During the measurements above 1 GHz it is taken care of that the EUT is always within the 3 dB cone of radiation BW of the used antenna



TX CH06 (Above 1000 MHz, Vertical)

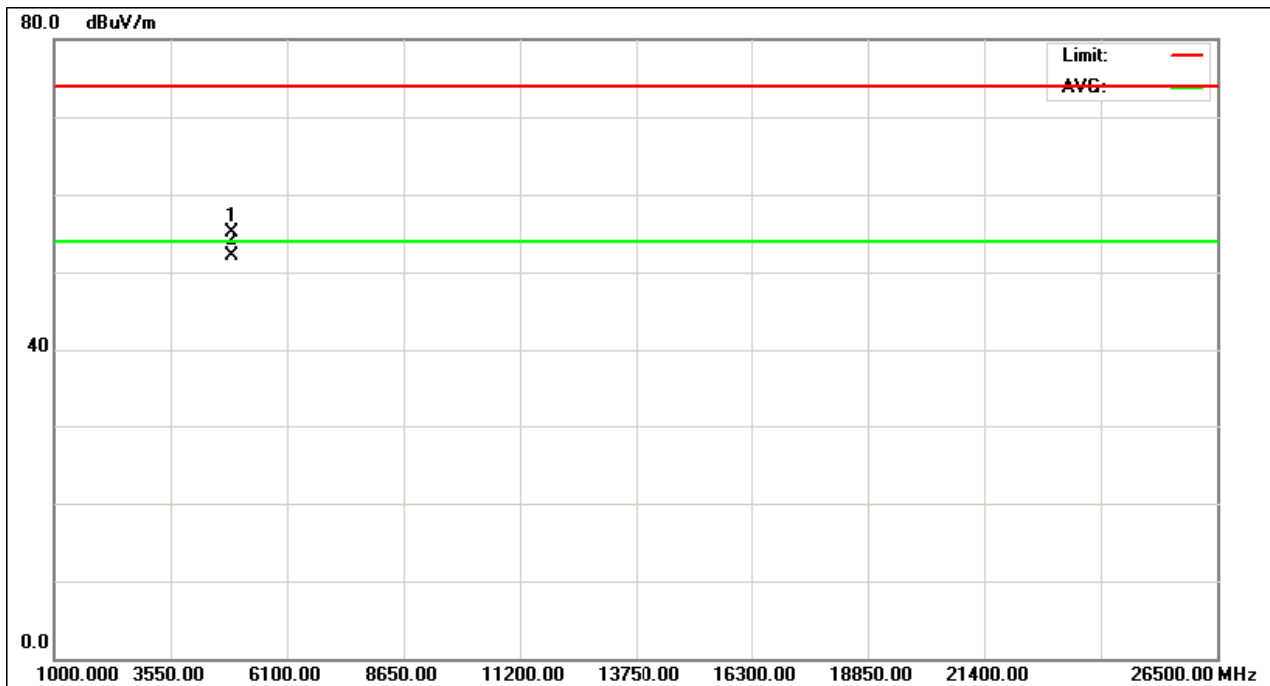
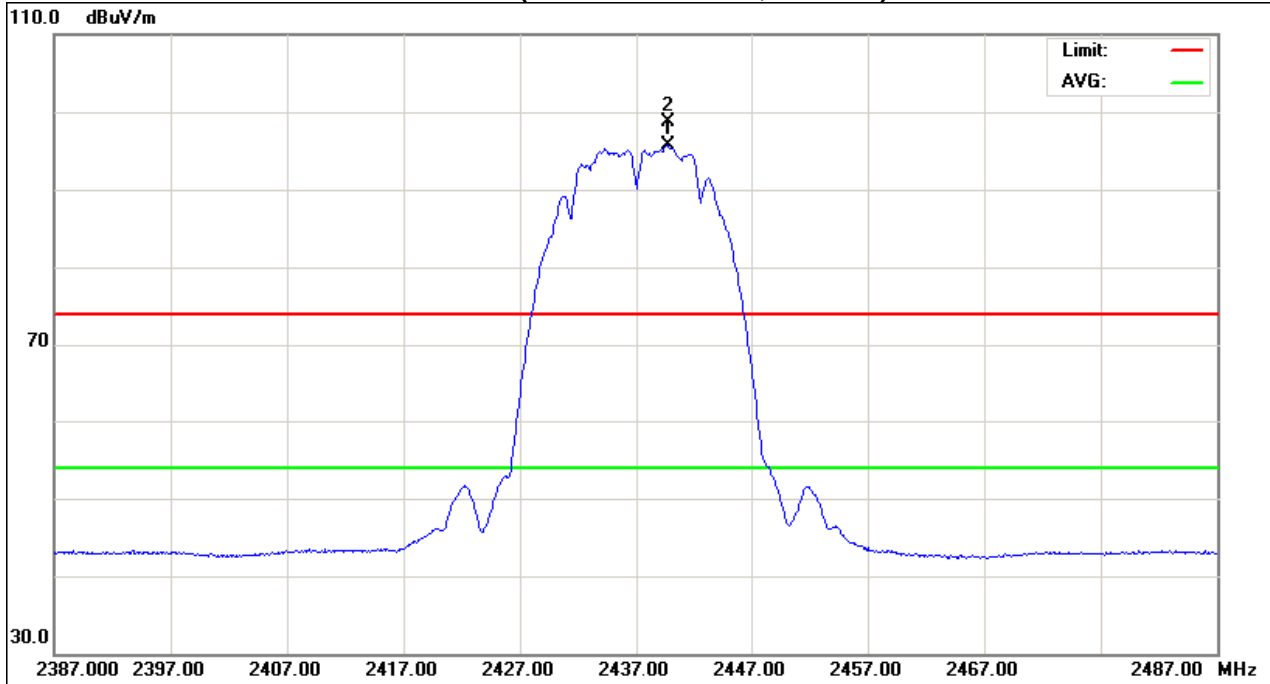



EUT :	WIFI MODULE	Model Name :	WL0159
Temperature :	20 °C	Relative Humidity :	51 %
Pressure :	1010 hPa	Test Voltage :	AC 120V/60Hz
Test Mode :	TX B MODE 2437MHz		

Freq.	Ant.Pol.	Reading		Ant./CF	Act.		Limit		Note
		Peak	AV		Peak	AV	Peak	AV	
(MHz)	H/V	(dBuV)	(dBuV)	CF(dB)	(dBuV/m)	(dBuV/m)	(dBuV/m)	(dBuV/m)	
<b>2439.80</b>	<b>H</b>	<b>70.55</b>	<b>67.96</b>	<b>31.62</b>	<b>102.17</b>	<b>99.58</b>			<b>X/F</b>
4873.98	H	46.42	43.58	7.10	53.52	50.68	74.00	54.00	X/H

Remark :

- (1) All readings are Peak unless otherwise stated QP in column of 『Note』 . Peak denotes that the Peak reading compliance with the QP Limits and then QP Mode measurement didn't perform ◦
- (2) Measuring frequency range from 30MHz to 1000MHz or the 10th harmonic of highest fundamental frequency ◦ "F" denotes fundamental frequency; "H" denotes spurious frequency. "E" denotes band edge frequency. (This judgment method includes the Band Edge Requirement.)
- (3) Radiated emissions measured in frequency range above 1000MHz were made with an instrument using Peak detector mode and AV detector mode of the emission ◦
- (4) Data of measurement within this frequency range shown " \* " in the table above means the reading of emissions are attenuated more than 20dB below the permissible limits or the field strength is too small to be measured.
- (5) A preamp and high pass filter were used for this test in order to provide sufficient measurement sensitivity.
- (6) EUT Orthogonal Axis :  
 "X" - denotes Laid on Table ; "Y" - denotes Vertical Stand ; "Z" - denotes Side Stand
- (7) During the measurements above 1 GHz it is taken care of that the EUT is always within the 3 dB cone of radiation BW of the used antenna



TX CH06 (Above 1000 MHz, Horizontal)

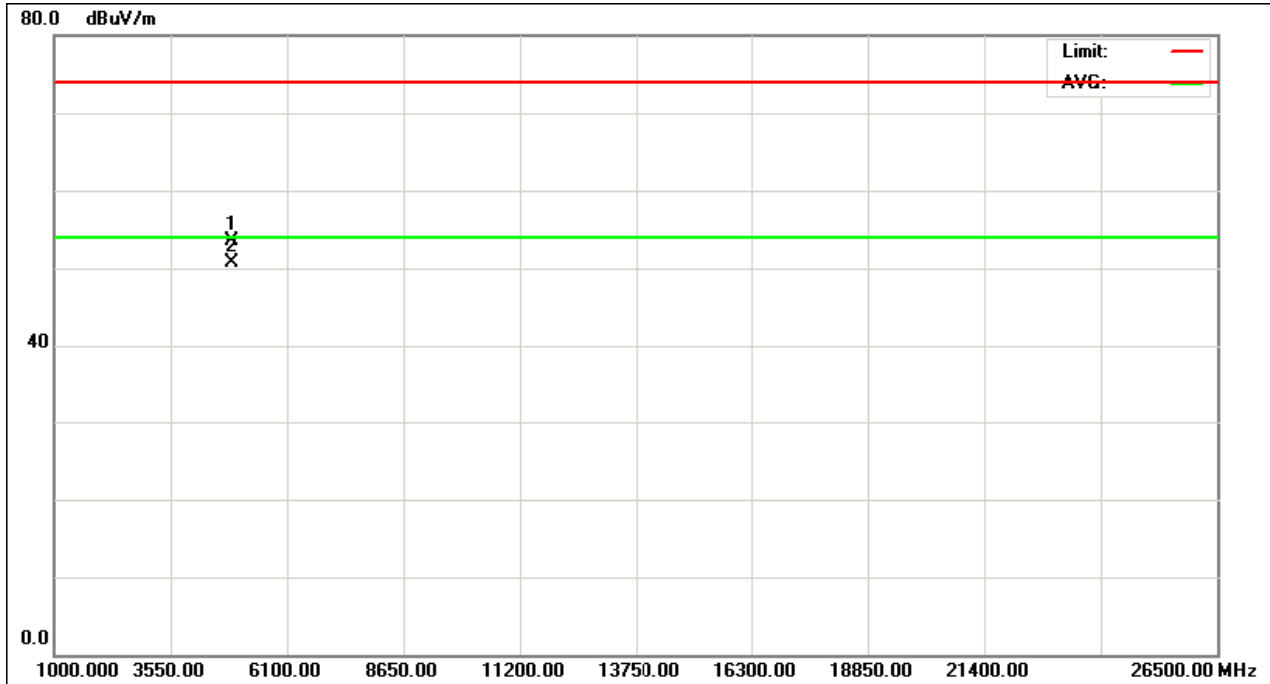
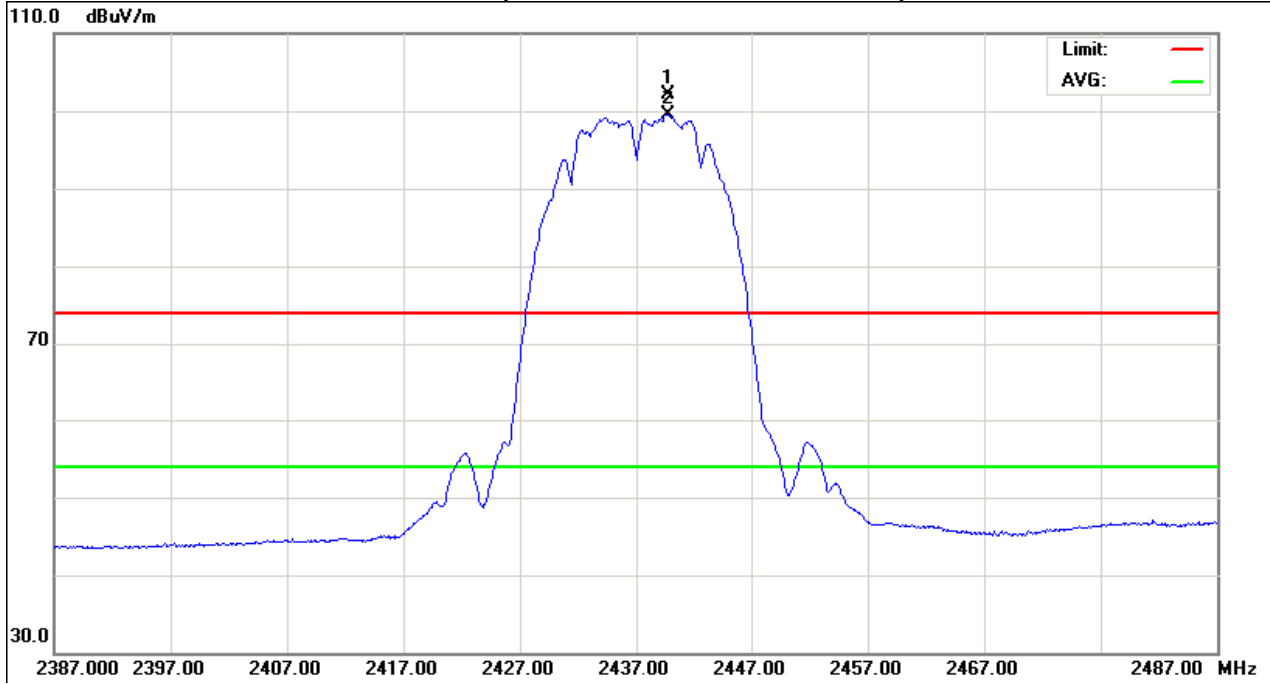



EUT :	WIFI MODULE	Model Name :	WL0159
Temperature :	20 °C	Relative Humidity :	51 %
Pressure :	1010 hPa	Test Voltage :	AC 120V/60Hz
Test Mode :	TX B MODE 2462MHz		

Freq.	Ant.Pol.	Reading		Ant./CF	Act.		Limit		Note
		Peak	AV		Peak	AV	Peak	AV	
(MHz)	H/V	(dBuV)	(dBuV)	CF(dB)	(dBuV/m)	(dBuV/m)	(dBuV/m)	(dBuV/m)	
<b>2463.00</b>	<b>V</b>	<b>65.70</b>	<b>62.03</b>	<b>31.66</b>	<b>97.36</b>	<b>93.69</b>			<b>X/F</b>
2483.50	V	18.78	11.12	31.70	50.48	42.82	74.00	54.00	X/E
4924.04	V	47.10	44.69	7.35	54.45	52.04	74.00	54.00	X/H

**Remark :**

- (1) All readings are Peak unless otherwise stated QP in column of 『Note』 . Peak denotes that the Peak reading compliance with the QP Limits and then QP Mode measurement didn't perform ◦
- (2) Measuring frequency range from 30MHz to 1000MHz or the 10th harmonic of highest fundamental frequency ◦ "F" denotes fundamental frequency; "H" denotes spurious frequency. "E" denotes band edge frequency. (This judgment method includes the Band Edge Requirement.)
- (3) Radiated emissions measured in frequency range above 1000MHz were made with an instrument using Peak detector mode and AV detector mode of the emission ◦
- (4) Data of measurement within this frequency range shown " \* " in the table above means the reading of emissions are attenuated more than 20dB below the permissible limits or the field strength is too small to be measured.
- (5) A preamp and high pass filter were used for this test in order to provide sufficient measurement sensitivity.
- (6) EUT Orthogonal Axis :  
 "X" - denotes Laid on Table ; "Y" - denotes Vertical Stand ; "Z" - denotes Side Stand
- (7) During the measurements above 1 GHz it is taken care of that the EUT is always within the 3 dB cone of radiation BW of the used antenna



TX CH11 (Above 1000 MHz, Vertical)

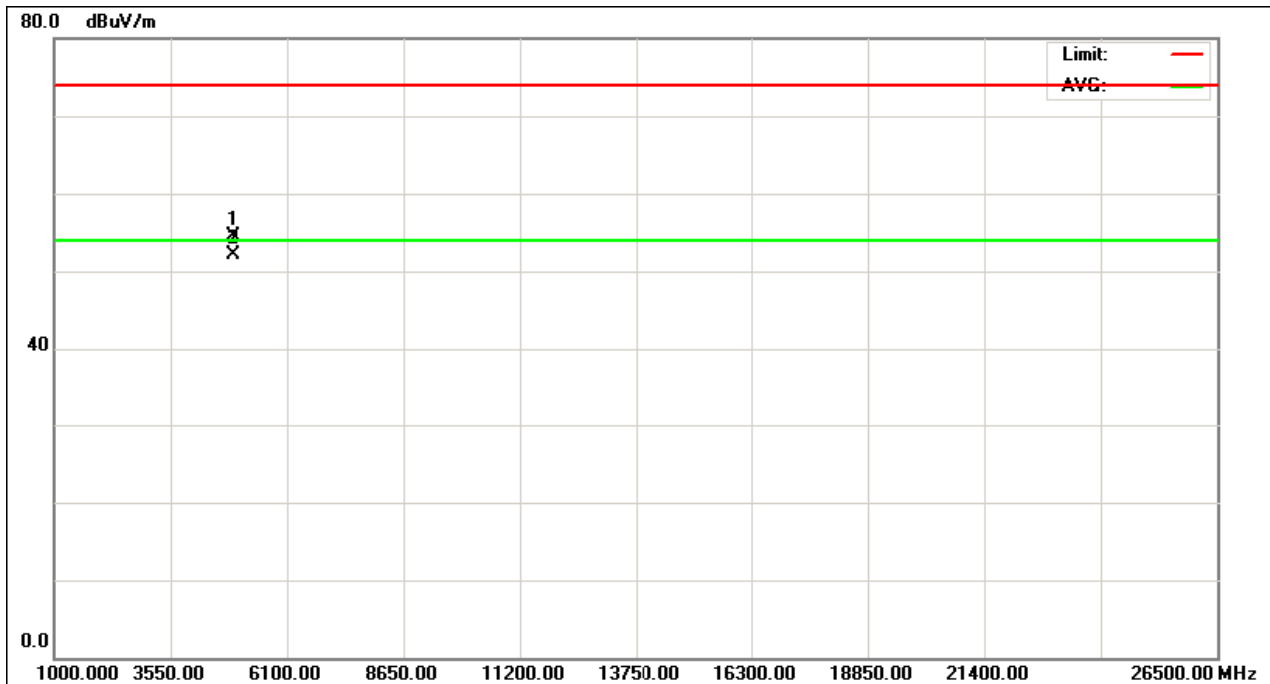
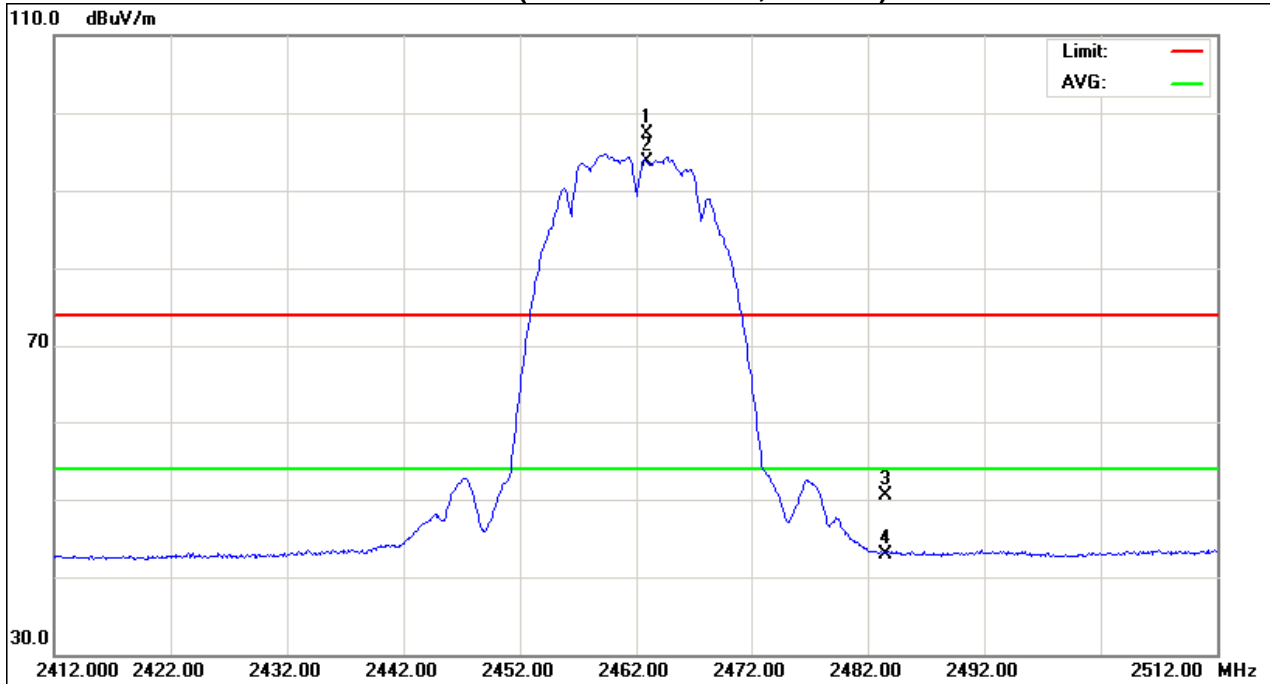





EUT :	WIFI MODULE	Model Name :	WL0159
Temperature :	20 °C	Relative Humidity :	51 %
Pressure :	1010 hPa	Test Voltage :	AC 120V/60Hz
Test Mode :	TX B MODE 2462MHz		

Freq.	Ant.Pol.	Reading		Ant./CF	Act.		Limit		Note
		Peak	AV		Peak	AV	Peak	AV	
(MHz)	H/V	(dBuV)	(dBuV)	CF(dB)	(dBuV/m)	(dBuV/m)	(dBuV/m)	(dBuV/m)	
<b>2463.00</b>	<b>H</b>	<b>72.05</b>	<b>68.65</b>	<b>31.66</b>	<b>103.71</b>	<b>100.31</b>			<b>X/F</b>
2483.50	H	26.12	16.19	31.70	57.82	47.89	74.00	54.00	X/E
4924.04	H	47.10	44.89	7.35	54.45	52.24	74.00	54.00	X/H

**Remark :**

- (1) All readings are Peak unless otherwise stated QP in column of 『Note』 . Peak denotes that the Peak reading compliance with the QP Limits and then QP Mode measurement didn't perform ◦
- (2) Measuring frequency range from 30MHz to 1000MHz or the 10th harmonic of highest fundamental frequency ◦ "F" denotes fundamental frequency; "H" denotes spurious frequency. "E" denotes band edge frequency. (This judgment method includes the Band Edge Requirement.)
- (3) Radiated emissions measured in frequency range above 1000MHz were made with an instrument using Peak detector mode and AV detector mode of the emission ◦
- (4) Data of measurement within this frequency range shown " \* " in the table above means the reading of emissions are attenuated more than 20dB below the permissible limits or the field strength is too small to be measured.
- (5) A preamp and high pass filter were used for this test in order to provide sufficient measurement sensitivity.
- (6) EUT Orthogonal Axis :  
 "X" - denotes Laid on Table ; "Y" - denotes Vertical Stand ; "Z" - denotes Side Stand
- (7) During the measurements above 1 GHz it is taken care of that the EUT is always within the 3 dB cone of radiation BW of the used antenna



TX CH11 (Above 1000 MHz, Horizontal)

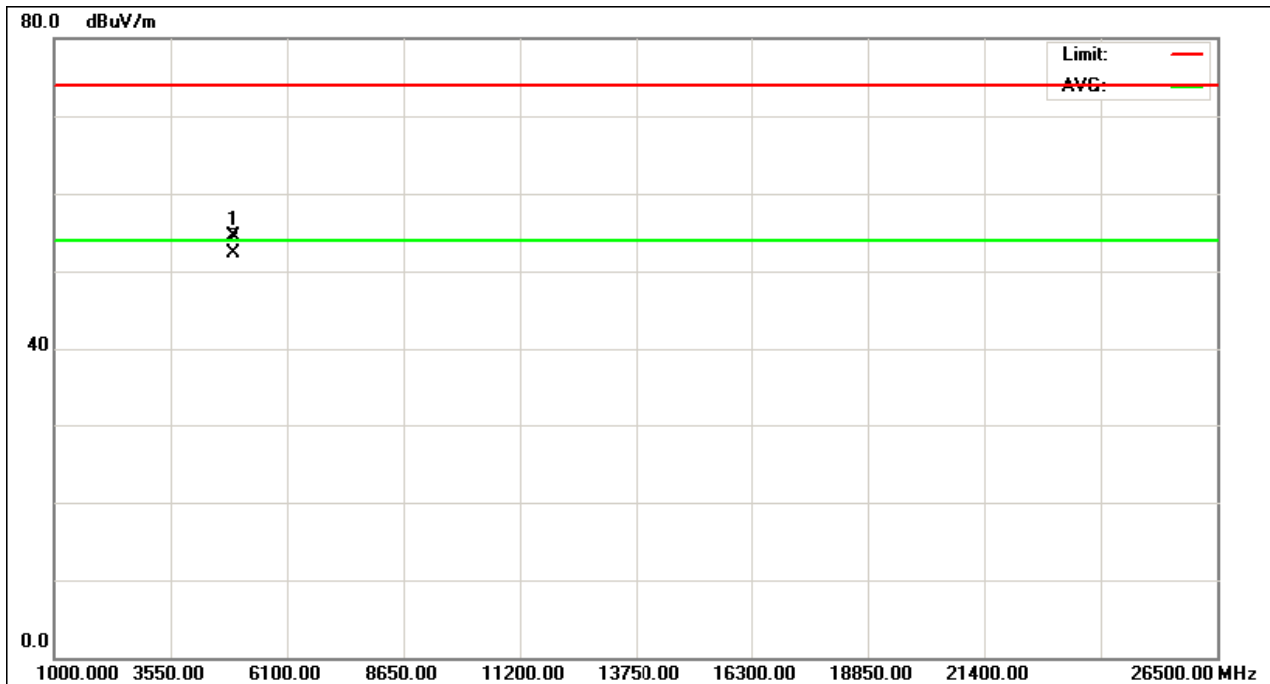
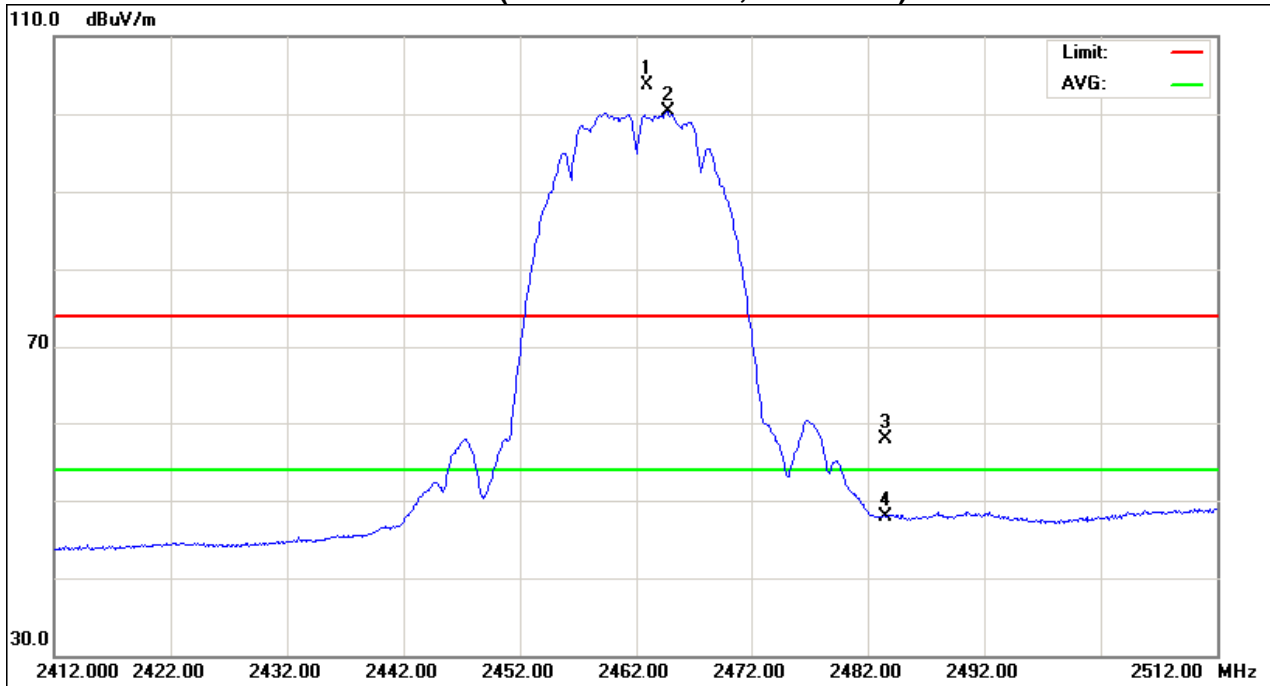



EUT :	WIFI MODULE	Model Name :	WL0159
Temperature :	20 °C	Relative Humidity :	51 %
Pressure :	1010 hPa	Test Voltage :	AC 120V/60Hz
Test Mode :	TX G MODE 2412MHz		

Freq. (MHz)	Ant.Pol. H/V	Reading		Ant./CF CF(dB)	Act.		Limit		Note
		Peak (dBuV)	AV (dBuV)		Peak (dBuV/m)	AV (dBuV/m)	Peak (dBuV/m)	AV (dBuV/m)	
2390.00	V	24.01	13.24	31.54	55.55	44.78	74.00	54.00	X/E
<b>2408.60</b>	<b>V</b>	<b>71.07</b>	<b>62.29</b>	<b>31.57</b>	<b>102.64</b>	<b>93.86</b>			<b>X/F</b>
4823.85	V	55.96	42.72	6.01	61.97	48.73	74.00	54.00	X/H

Remark :

- (1) All readings are Peak unless otherwise stated QP in column of 『Note』 . Peak denotes that the Peak reading compliance with the QP Limits and then QP Mode measurement didn't perform ◦
- (2) Measuring frequency range from 30MHz to 1000MHz or the 10th harmonic of highest fundamental frequency ◦ "F" denotes fundamental frequency; "H" denotes spurious frequency. "E" denotes band edge frequency. (This judgment method includes the Band Edge Requirement.)
- (3) Radiated emissions measured in frequency range above 1000MHz were made with an instrument using Peak detector mode and AV detector mode of the emission ◦
- (4) Data of measurement within this frequency range shown " \* " in the table above means the reading of emissions are attenuated more than 20dB below the permissible limits or the field strength is too small to be measured.
- (5) A preamp and high pass filter were used for this test in order to provide sufficient measurement sensitivity.
- (6) EUT Orthogonal Axis :  
"X" - denotes Laid on Table ; "Y" - denotes Vertical Stand ; "Z" - denotes Side Stand
- (7) During the measurements above 1 GHz it is taken care of that the EUT is always within the 3 dB cone of radiation BW of the used antenna



TX CH01 (Above 1000 MHz, Vertical)

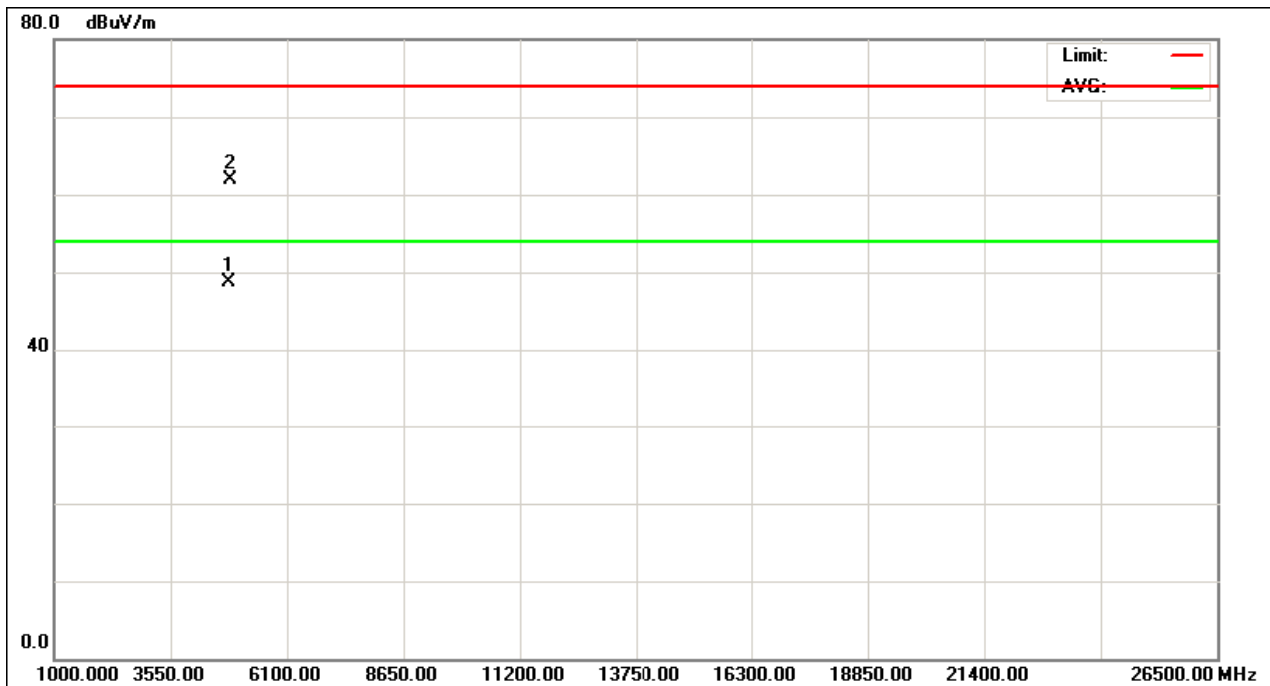
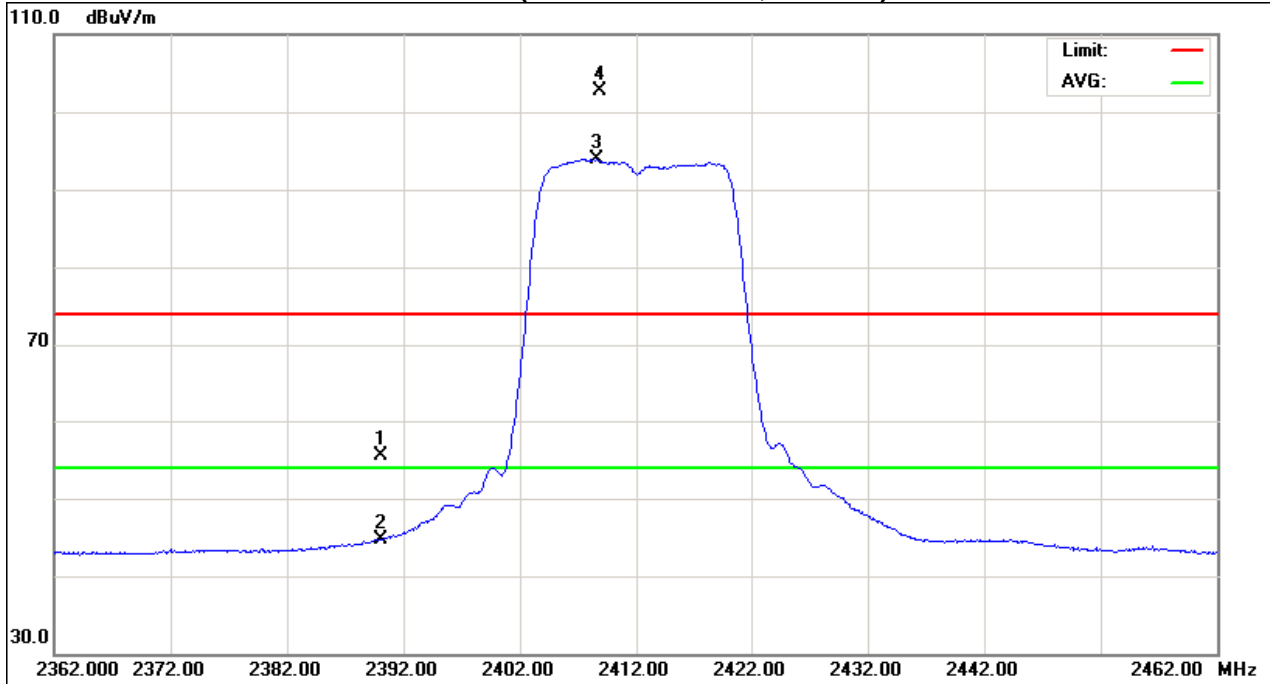



EUT :	WIFI MODULE	Model Name :	WL0159
Temperature :	20 °C	Relative Humidity :	51 %
Pressure :	1010 hPa	Test Voltage :	AC 120V/60Hz
Test Mode :	TX G MODE 2412MHz		

Freq. (MHz)	Ant.Pol. H/V	Reading		Ant./CF CF(dB)	Act.		Limit		Note
		Peak (dBuV)	AV (dBuV)		Peak (dBuV/m)	AV (dBuV/m)	Peak (dBuV/m)	AV (dBuV/m)	
2390.00	H	23.50	13.65	31.54	55.04	45.19	74.00	54.00	X/E
<b>2418.40</b>	<b>H</b>	<b>73.86</b>	<b>66.19</b>	<b>31.58</b>	<b>105.44</b>	<b>97.77</b>			<b>X/F</b>
4824.15	H	53.66	40.85	6.00	59.67	46.85	74.00	54.00	X/H

Remark :

- (1) All readings are Peak unless otherwise stated QP in column of 『Note』 . Peak denotes that the Peak reading compliance with the QP Limits and then QP Mode measurement didn't perform ◦
- (2) Measuring frequency range from 30MHz to 1000MHz or the 10th harmonic of highest fundamental frequency ◦ "F" denotes fundamental frequency; "H" denotes spurious frequency. "E" denotes band edge frequency. (This judgment method includes the Band Edge Requirement.)
- (3) Radiated emissions measured in frequency range above 1000MHz were made with an instrument using Peak detector mode and AV detector mode of the emission ◦
- (4) Data of measurement within this frequency range shown " \* " in the table above means the reading of emissions are attenuated more than 20dB below the permissible limits or the field strength is too small to be measured.
- (5) A preamp and high pass filter were used for this test in order to provide sufficient measurement sensitivity.
- (6) EUT Orthogonal Axis :  
"X" - denotes Laid on Table ; "Y" - denotes Vertical Stand ; "Z" - denotes Side Stand
- (7) During the measurements above 1 GHz it is taken care of that the EUT is always within the 3 dB cone of radiation BW of the used antenna



TX CH01 (Above 1000 MHz, Horizontal)

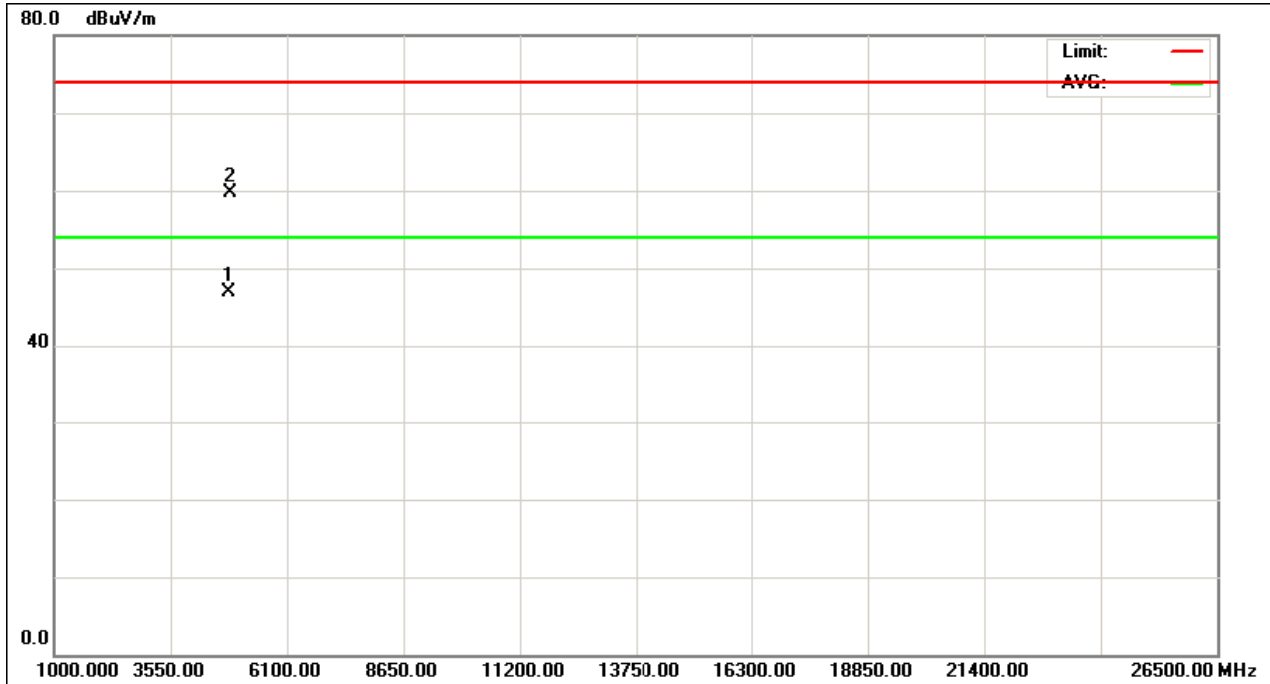
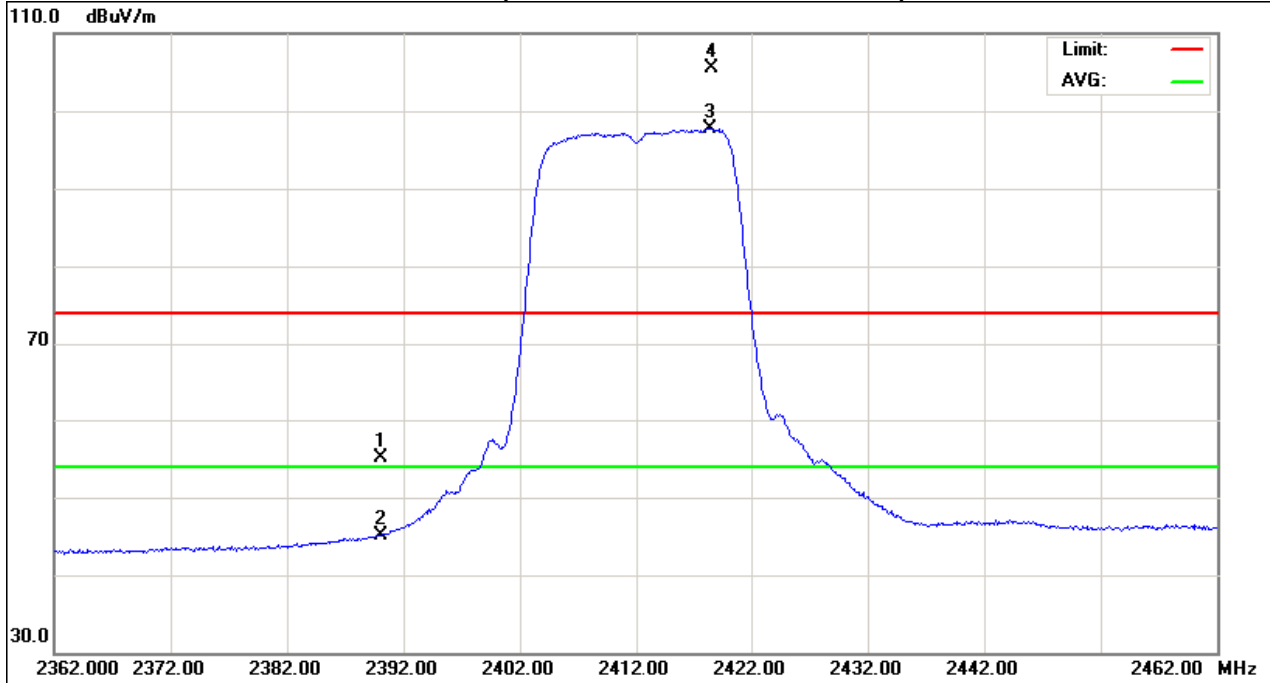



EUT :	WIFI MODULE	Model Name :	WL0159
Temperature :	20 °C	Relative Humidity :	51 %
Pressure :	1010 hPa	Test Voltage :	AC 120V/60Hz
Test Mode :	TX G MODE 2437MHz		

Freq. (MHz)	Ant.Pol. H/V	Reading		Ant./CF CF(dB)	Act.		Limit		Note
		Peak (dBuV)	AV (dBuV)		Peak (dBuV/m)	AV (dBuV/m)	Peak (dBuV/m)	AV (dBuV/m)	
<b>2443.50</b>	<b>V</b>	<b>71.45</b>	<b>62.51</b>	<b>31.63</b>	<b>103.08</b>	<b>94.14</b>			<b>X/F</b>
4876.10	V	57.43	44.19	6.15	63.58	50.34	74.00	54.00	X/H

Remark :

- (1) All readings are Peak unless otherwise stated QP in column of 『Note』 . Peak denotes that the Peak reading compliance with the QP Limits and then QP Mode measurement didn't perform ◦
- (2) Measuring frequency range from 30MHz to 1000MHz or the 10th harmonic of highest fundamental frequency ◦ "F" denotes fundamental frequency; "H" denotes spurious frequency. "E" denotes band edge frequency. (This judgment method includes the Band Edge Requirement.)
- (3) Radiated emissions measured in frequency range above 1000MHz were made with an instrument using Peak detector mode and AV detector mode of the emission ◦
- (4) Data of measurement within this frequency range shown " \* " in the table above means the reading of emissions are attenuated more than 20dB below the permissible limits or the field strength is too small to be measured.
- (5) A preamp and high pass filter were used for this test in order to provide sufficient measurement sensitivity.
- (6) EUT Orthogonal Axis :  
"X" - denotes Laid on Table ; "Y" - denotes Vertical Stand ; "Z" - denotes Side Stand
- (7) During the measurements above 1 GHz it is taken care of that the EUT is always within the 3 dB cone of radiation BW of the used antenna



TX CH06 (Above 1000 MHz, Vertical)

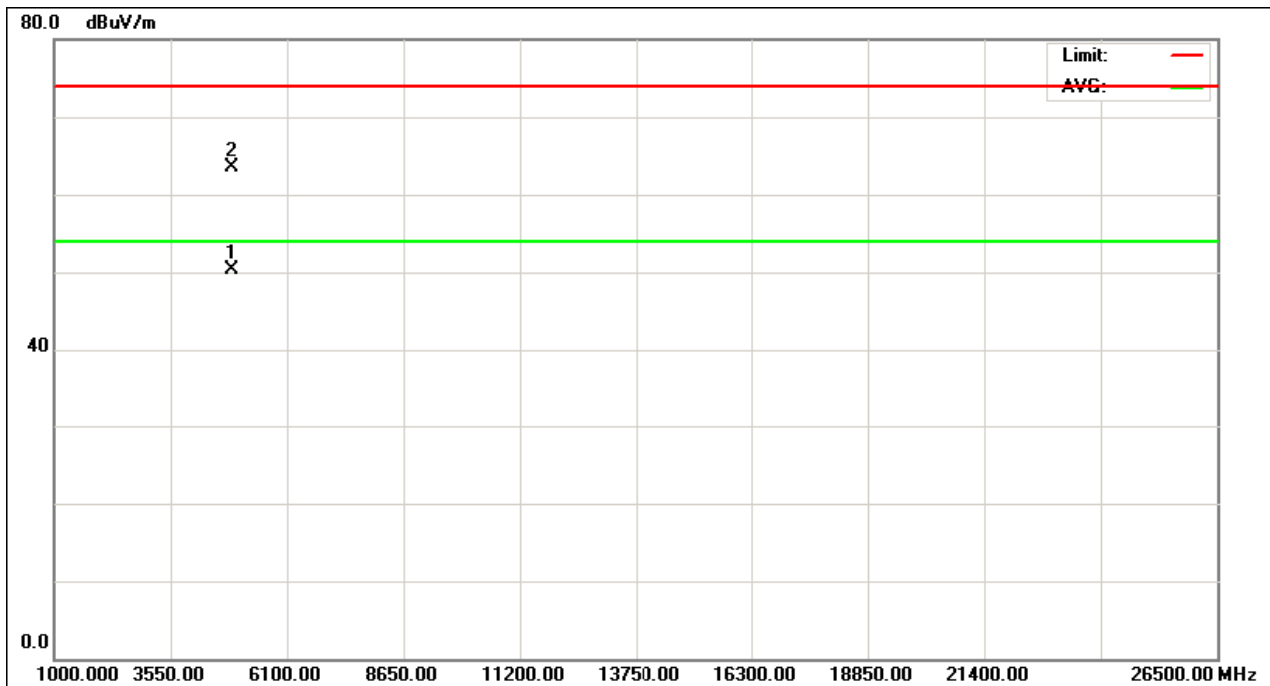
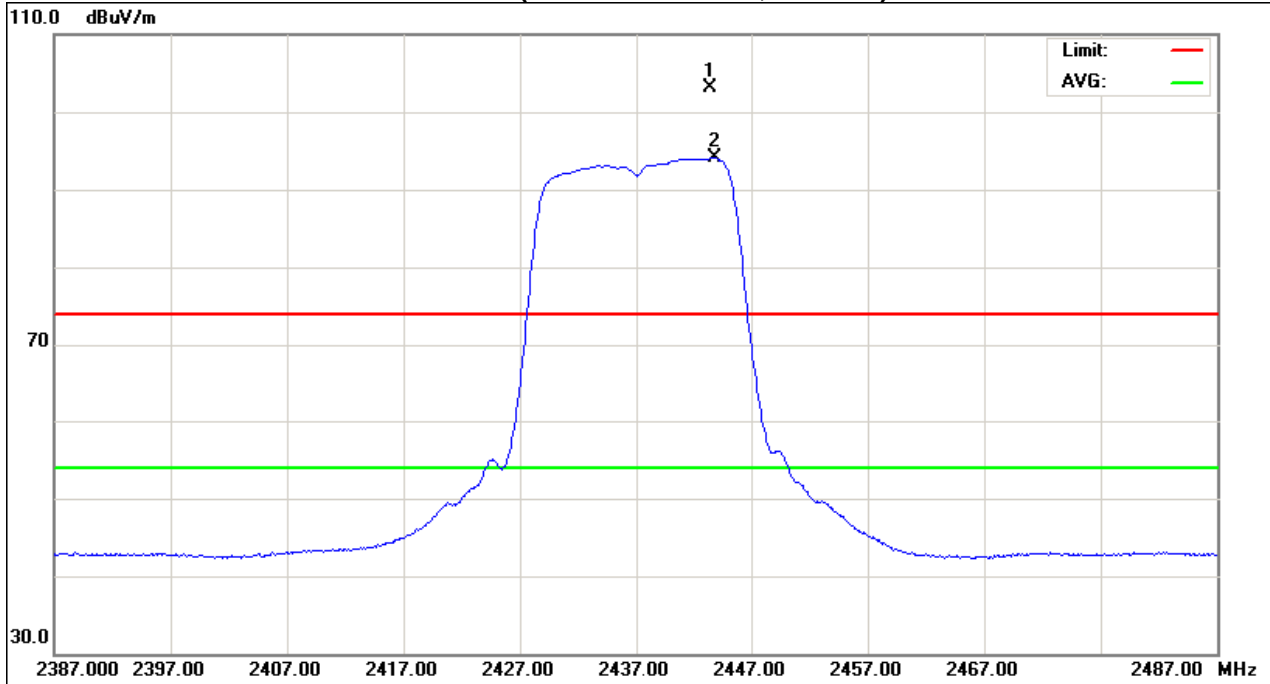





EUT :	WIFI MODULE	Model Name :	WL0159
Temperature :	20 °C	Relative Humidity :	51 %
Pressure :	1010 hPa	Test Voltage :	AC 120V/60Hz
Test Mode :	TX G MODE 2437MHz		

Freq.	Ant.Pol.	Reading		Ant./CF	Act.		Limit		Note
		Peak	AV		Peak	AV	Peak	AV	
(MHz)	H/V	(dBuV)	(dBuV)	CF(dB)	(dBuV/m)	(dBuV/m)	(dBuV/m)	(dBuV/m)	
<b>2443.80</b>	<b>H</b>	<b>75.54</b>	<b>67.56</b>	<b>31.63</b>	<b>107.17</b>	<b>99.19</b>			<b>X/F</b>
4874.10	H	53.27	40.39	6.15	59.42	46.54	74.00	54.00	X/H

Remark :

- (1) All readings are Peak unless otherwise stated QP in column of 『Note』 . Peak denotes that the Peak reading compliance with the QP Limits and then QP Mode measurement didn't perform ◦
- (2) Measuring frequency range from 30MHz to 1000MHz or the 10th harmonic of highest fundamental frequency ◦ "F" denotes fundamental frequency; "H" denotes spurious frequency. "E" denotes band edge frequency. (This judgment method includes the Band Edge Requirement.)
- (3) Radiated emissions measured in frequency range above 1000MHz were made with an instrument using Peak detector mode and AV detector mode of the emission ◦
- (4) Data of measurement within this frequency range shown " \* " in the table above means the reading of emissions are attenuated more than 20dB below the permissible limits or the field strength is too small to be measured.
- (5) A preamp and high pass filter were used for this test in order to provide sufficient measurement sensitivity.
- (6) EUT Orthogonal Axis :  
 "X" - denotes Laid on Table ; "Y" - denotes Vertical Stand ; "Z" - denotes Side Stand
- (7) During the measurements above 1 GHz it is taken care of that the EUT is always within the 3 dB cone of radiation BW of the used antenna



TX CH06 (Above 1000 MHz, Horizontal)

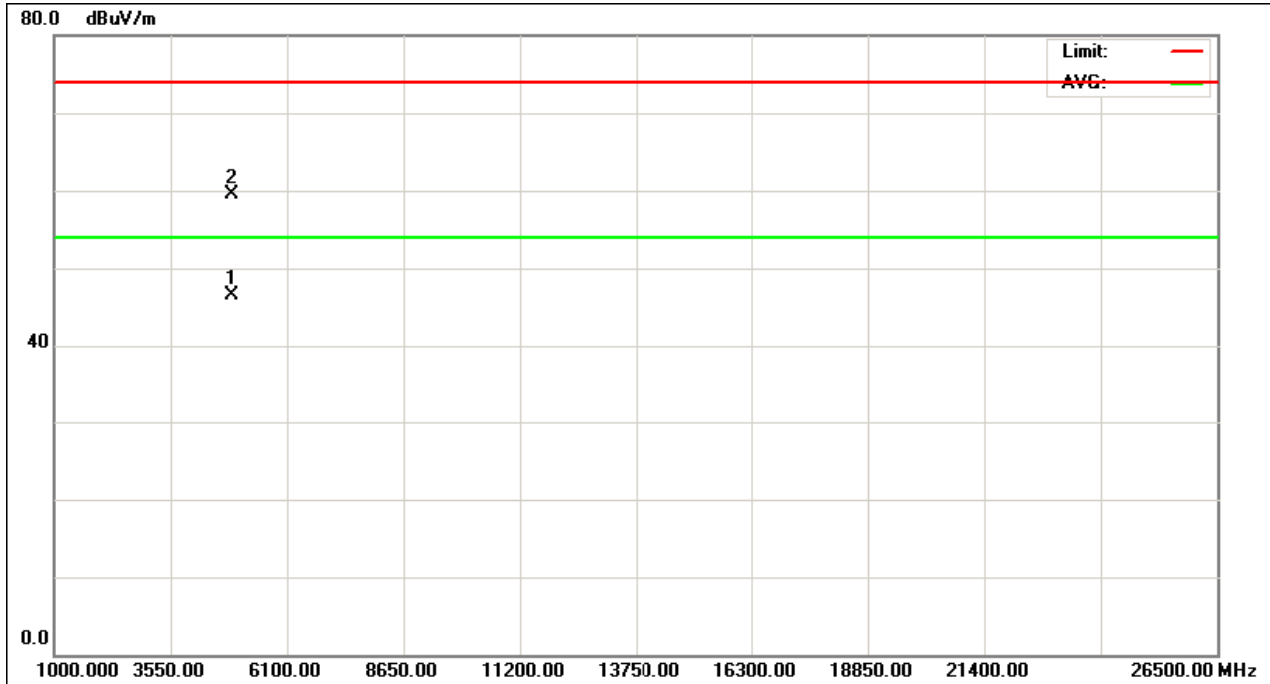
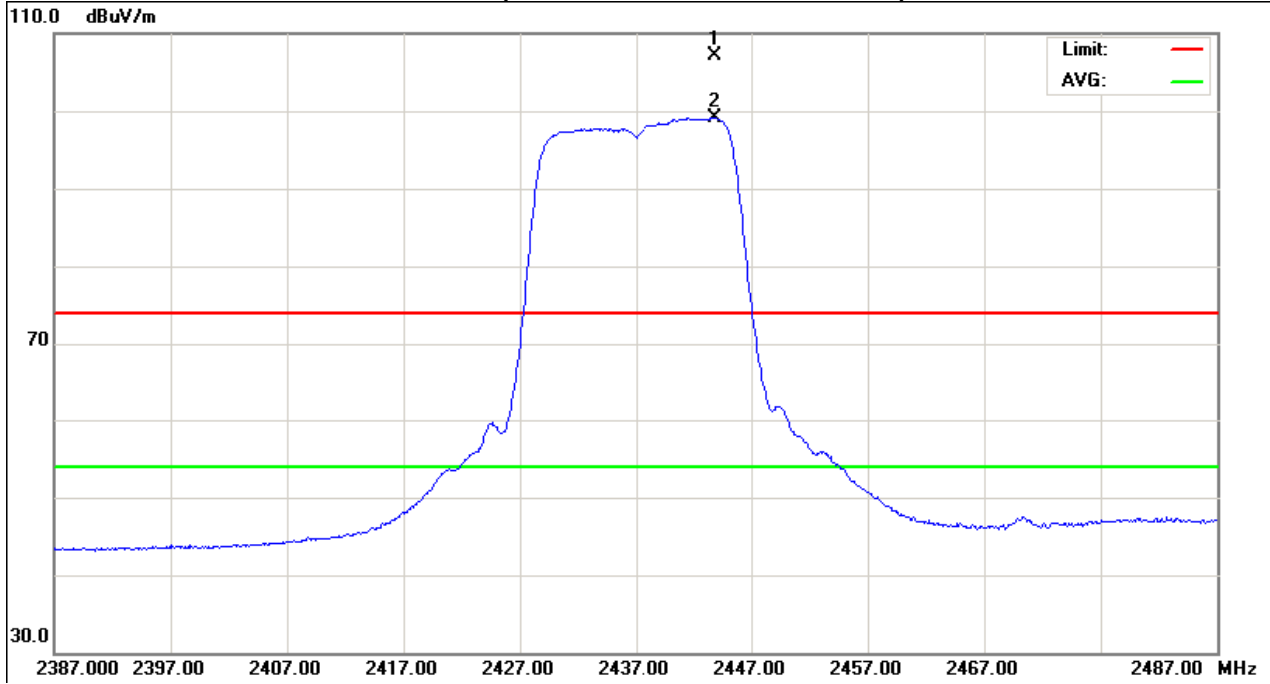



EUT :	WIFI MODULE	Model Name :	WL0159
Temperature :	20 °C	Relative Humidity :	51 %
Pressure :	1010 hPa	Test Voltage :	AC 120V/60Hz
Test Mode :	TX G MODE 2462MHz		

Freq.	Ant.Pol.	Reading		Ant./CF	Act.		Limit		Note
		Peak	AV		Peak	AV	Peak	AV	
(MHz)	H/V	(dBuV)	(dBuV)	CF(dB)	(dBuV/m)	(dBuV/m)	(dBuV/m)	(dBuV/m)	
<b>2463.00</b>	<b>V</b>	<b>68.76</b>	<b>59.53</b>	<b>31.66</b>	<b>100.41</b>	<b>91.19</b>			<b>X/F</b>
2483.50	V	19.35	12.12	31.70	51.05	43.82	74.00	54.00	X/E
4924.25	V	56.49	42.17	6.30	62.79	48.47	74.00	54.00	X/H

Remark :

- (1) All readings are Peak unless otherwise stated QP in column of 『Note』 . Peak denotes that the Peak reading compliance with the QP Limits and then QP Mode measurement didn't perform ◦
- (2) Measuring frequency range from 30MHz to 1000MHz or the 10th harmonic of highest fundamental frequency ◦ "F" denotes fundamental frequency; "H" denotes spurious frequency. "E" denotes band edge frequency. (This judgment method includes the Band Edge Requirement.)
- (3) Radiated emissions measured in frequency range above 1000MHz were made with an instrument using Peak detector mode and AV detector mode of the emission ◦
- (4) Data of measurement within this frequency range shown " \* " in the table above means the reading of emissions are attenuated more than 20dB below the permissible limits or the field strength is too small to be measured.
- (5) A preamp and high pass filter were used for this test in order to provide sufficient measurement sensitivity.
- (6) EUT Orthogonal Axis :  
 "X" - denotes Laid on Table ; "Y" - denotes Vertical Stand ; "Z" - denotes Side Stand
- (7) During the measurements above 1 GHz it is taken care of that the EUT is always within the 3 dB cone of radiation BW of the used antenna



TX CH11 (Above 1000 MHz, Vertical)

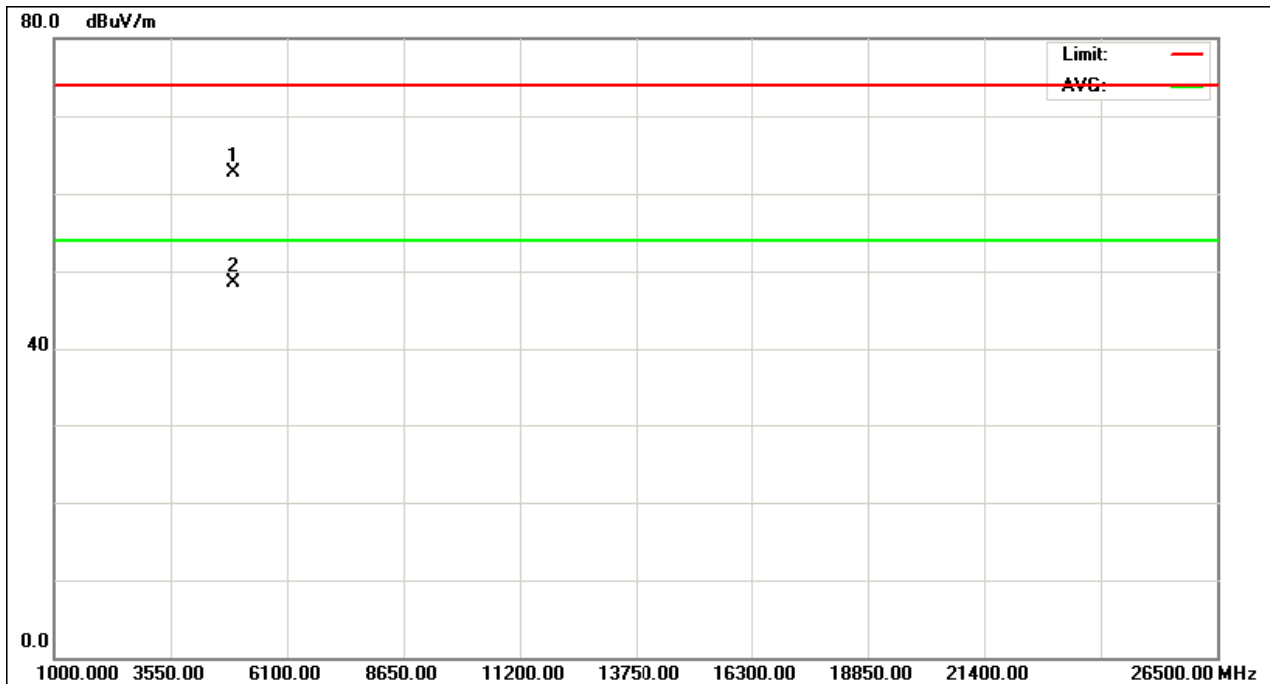
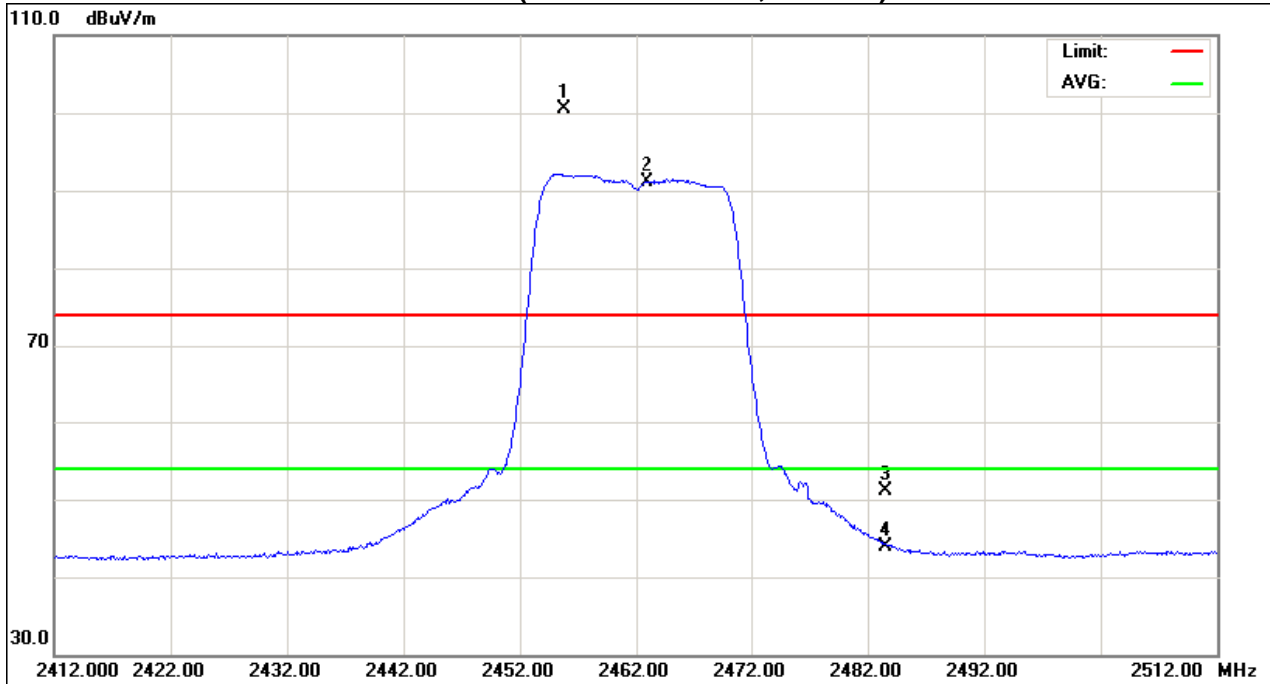



EUT :	WIFI MODULE	Model Name :	WL0159
Temperature :	20 °C	Relative Humidity :	51 %
Pressure :	1010 hPa	Test Voltage :	AC 120V/60Hz
Test Mode :	TX G MODE 2462MHz		

Freq.	Ant.Pol.	Reading		Ant./CF	Act.		Limit		Note
		Peak	AV		Peak	AV	Peak	AV	
(MHz)	H/V	(dBuV)	(dBuV)	CF(dB)	(dBuV/m)	(dBuV/m)	(dBuV/m)	(dBuV/m)	
<b>2465.40</b>	<b>H</b>	<b>73.91</b>	<b>65.33</b>	<b>31.66</b>	<b>105.57</b>	<b>96.99</b>			<b>X/F</b>
2483.50	H	28.44	18.55	31.70	60.14	50.25	74.00	54.00	X/E
4924.00	H	52.19	39.79	6.30	58.49	46.09	74.00	54.00	X/H

Remark :

- (1) All readings are Peak unless otherwise stated QP in column of 『Note』 . Peak denotes that the Peak reading compliance with the QP Limits and then QP Mode measurement didn't perform ◦
- (2) Measuring frequency range from 30MHz to 1000MHz or the 10th harmonic of highest fundamental frequency ◦ "F" denotes fundamental frequency; "H" denotes spurious frequency. "E" denotes band edge frequency. (This judgment method includes the Band Edge Requirement.)
- (3) Radiated emissions measured in frequency range above 1000MHz were made with an instrument using Peak detector mode and AV detector mode of the emission ◦
- (4) Data of measurement within this frequency range shown " \* " in the table above means the reading of emissions are attenuated more than 20dB below the permissible limits or the field strength is too small to be measured.
- (5) A preamp and high pass filter were used for this test in order to provide sufficient measurement sensitivity.
- (6) EUT Orthogonal Axis :  
 "X" - denotes Laid on Table ; "Y" - denotes Vertical Stand ; "Z" - denotes Side Stand
- (7) During the measurements above 1 GHz it is taken care of that the EUT is always within the 3 dB cone of radiation BW of the used antenna



TX CH11 (Above 1000 MHz, Horizontal)

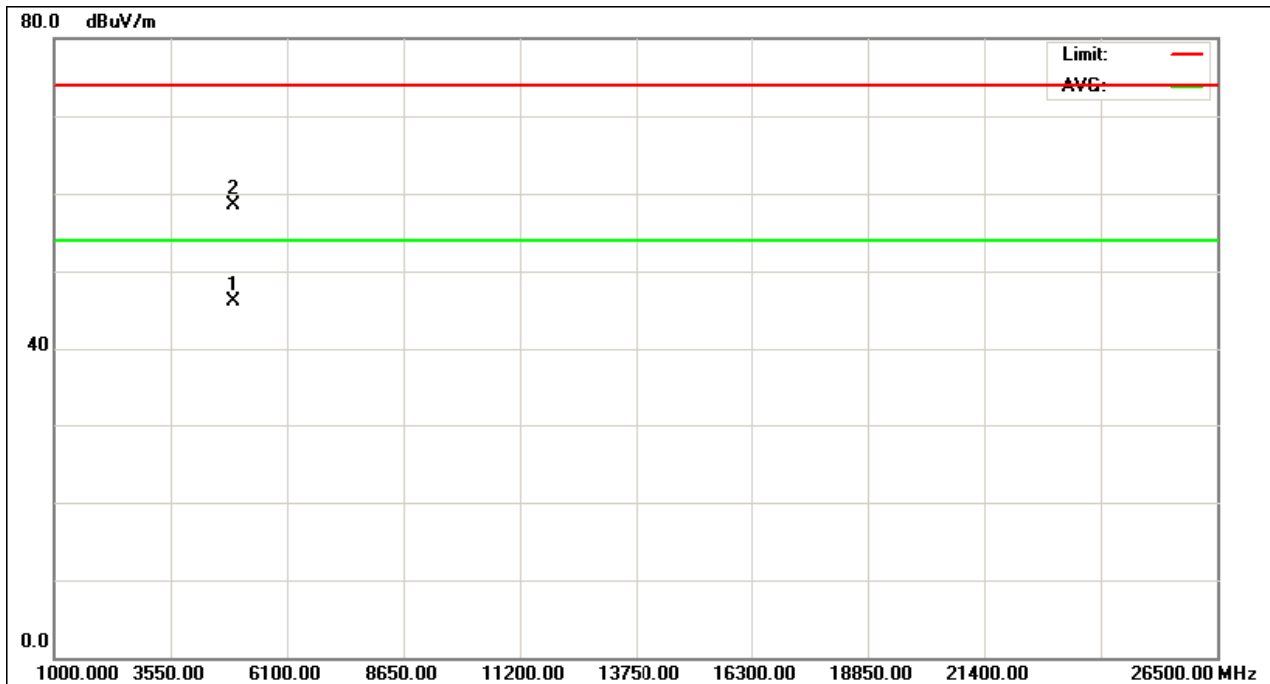
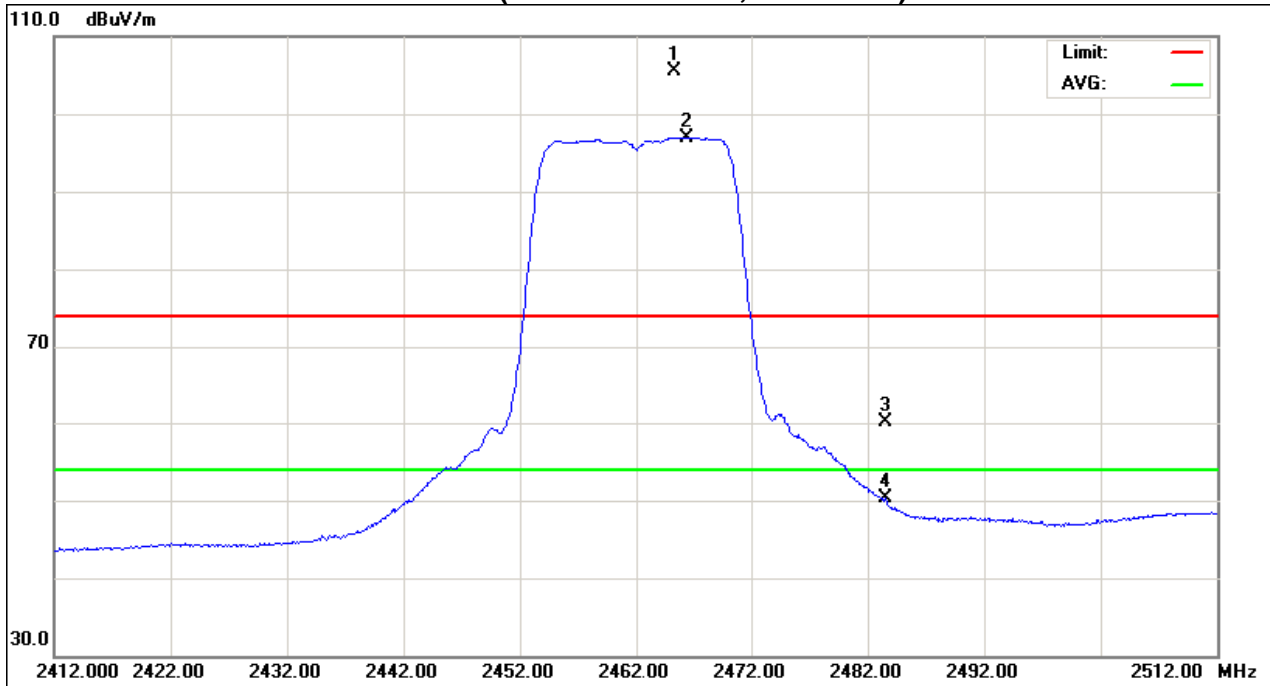



**4.2.9 TEST RESULTS (RESTRICTED BANDS REQUIREMENTS)**

EUT :	WIFI MODULE	Model Name :	WL0159
Temperature :	20 °C	Relative Humidity :	51 %
Pressure :	1010 hPa	Test Voltage :	AC 120V/60Hz
Test Mode :	TX B MODE 2412MHz/2462MHz (Vertical)		
Note :	1. The transmitter was setup to transmit at the lowest channel (CH01). Then the field strength was measured at 2310-2390 MHz. 2. The transmitter was setup to transmit at the highest channel (CH11). Then the field strength was measured at 2483.5-2500 MHz.		

Freq.	Ant.Pol.	Reading		Ant./CF	Act.		Limit		Note
		Peak	AV		Peak	AV	Peak	AV	
(MHz)	H/V	(dBuV)	(dBuV)	CF(dB)	(dBuV/m)	(dBuV/m)	(dBuV/m)	(dBuV/m)	
2390.00	V	21.54	12.71	31.54	53.08	44.25	74.00	54.00	CH01
2483.50	V	18.78	11.12	31.70	50.48	42.82	74.00	54.00	CH11

**Remark :**

- (1) Radiated emissions measured in frequency range above 1000MHz were made with an instrument using Peak detector mode and AV detector mode of the emission ◦
- (2) EUT Orthogonal Axis :  
 "X" - denotes Laid on Table ; "Y" - denotes Vertical Stand ; "Z" - denotes Side Stand
- (3) During the measurements above 1 GHz it is taken care of that the EUT is always within the 3 dB cone of radiation BW of the used antenna



### Restricted Bands Requirements, Vertical CH01

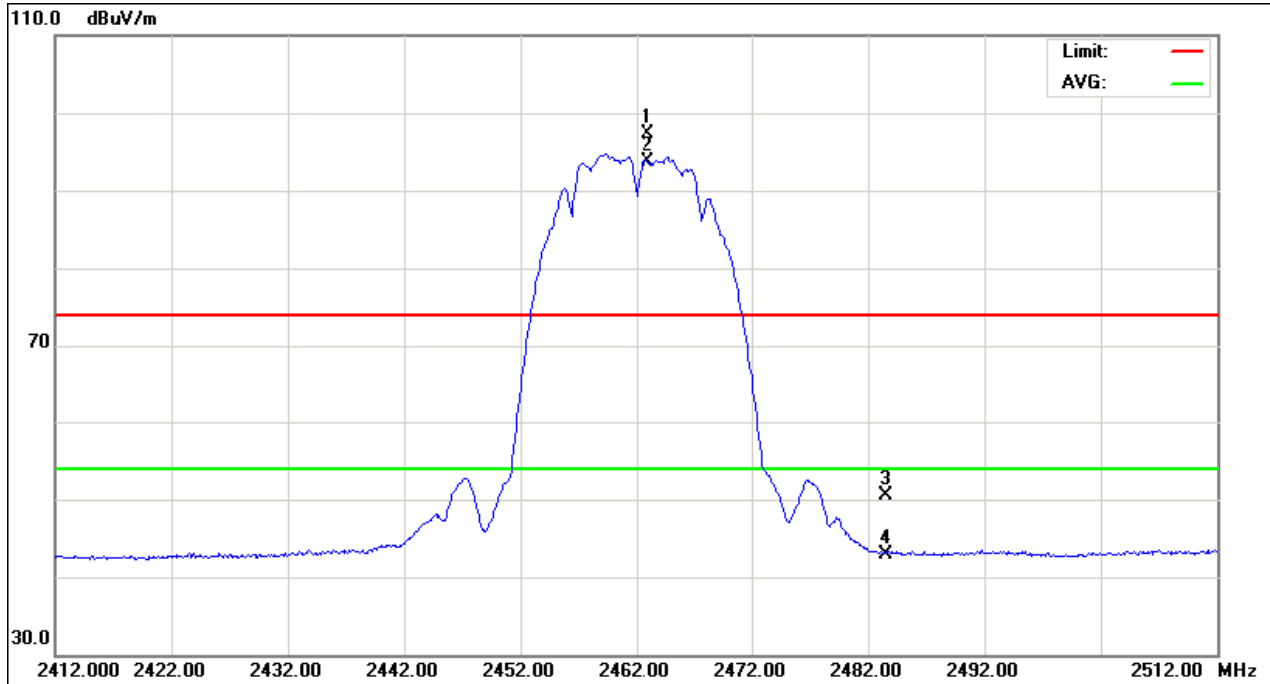
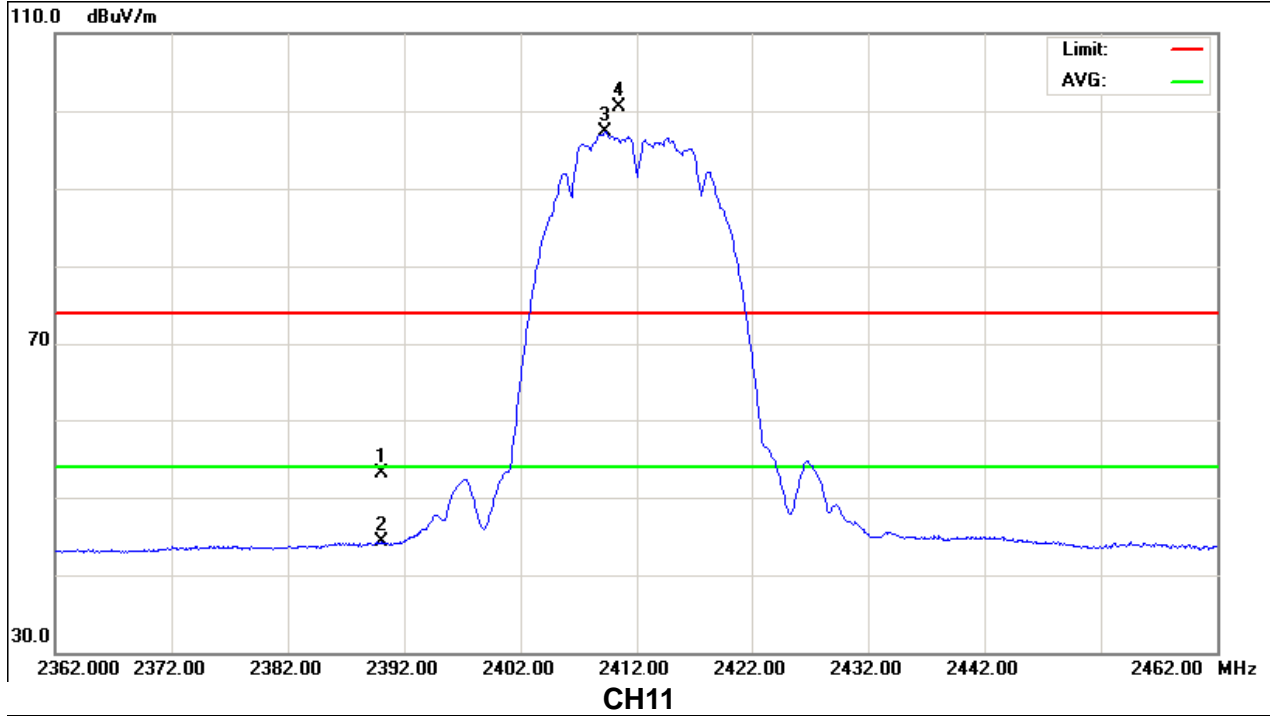





EUT :	WIFI MODULE	Model Name :	WL0159
Temperature :	20 °C	Relative Humidity :	51 %
Pressure :	1010 hPa	Test Voltage :	AC 120V/60Hz
Test Mode :	TX B MODE 2412MHz/2462MHz (Horizontal)		
Note :	1. The transmitter was setup to transmit at the lowest channel (CH01). Then the field strength was measured at 2310-2390 MHz. 2. The transmitter was setup to transmit at the highest channel (CH11). Then the field strength was measured at 2483.5-2500 MHz.		

Freq.	Ant.Pol.	Reading		Ant./CF	Act.		Limit		Note
		Peak	AV		Peak	AV	Peak	AV	
(MHz)	H/V	(dBuV)	(dBuV)	CF(dB)	(dBuV/m)	(dBuV/m)	(dBuV/m)	(dBuV/m)	
2390.00	H	25.21	13.43	31.54	56.75	44.97	74.00	54.00	CH01
2483.50	H	26.12	16.19	31.70	57.82	47.89	74.00	54.00	CH11

**Remark :**

- (1) Radiated emissions measured in frequency range above 1000MHz were made with an instrument using Peak detector mode and AV detector mode of the emission ◦
- (2) EUT Orthogonal Axis :  
 "X" - denotes Laid on Table ; "Y" - denotes Vertical Stand ; "Z" - denotes Side Stand
- (3) During the measurements above 1 GHz it is taken care of that the EUT is always within the 3 dB cone of radiation BW of the used antenna



### Restricted Bands Requirements, Horizontal CH01

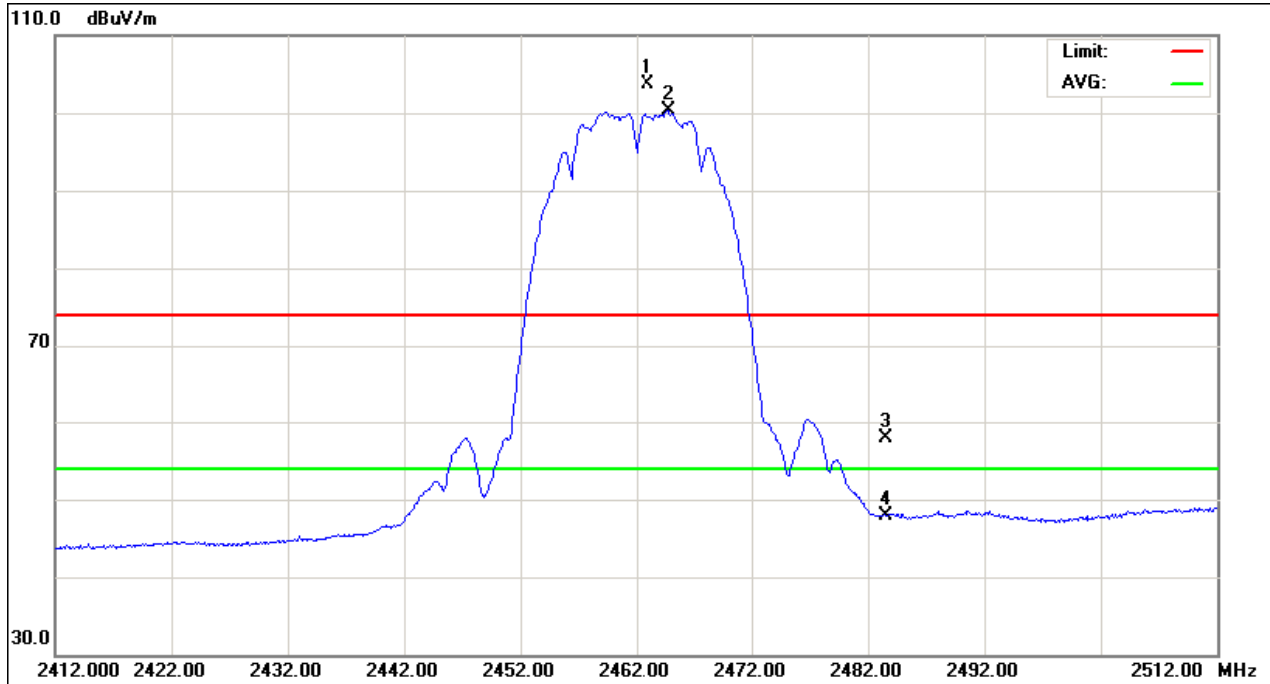
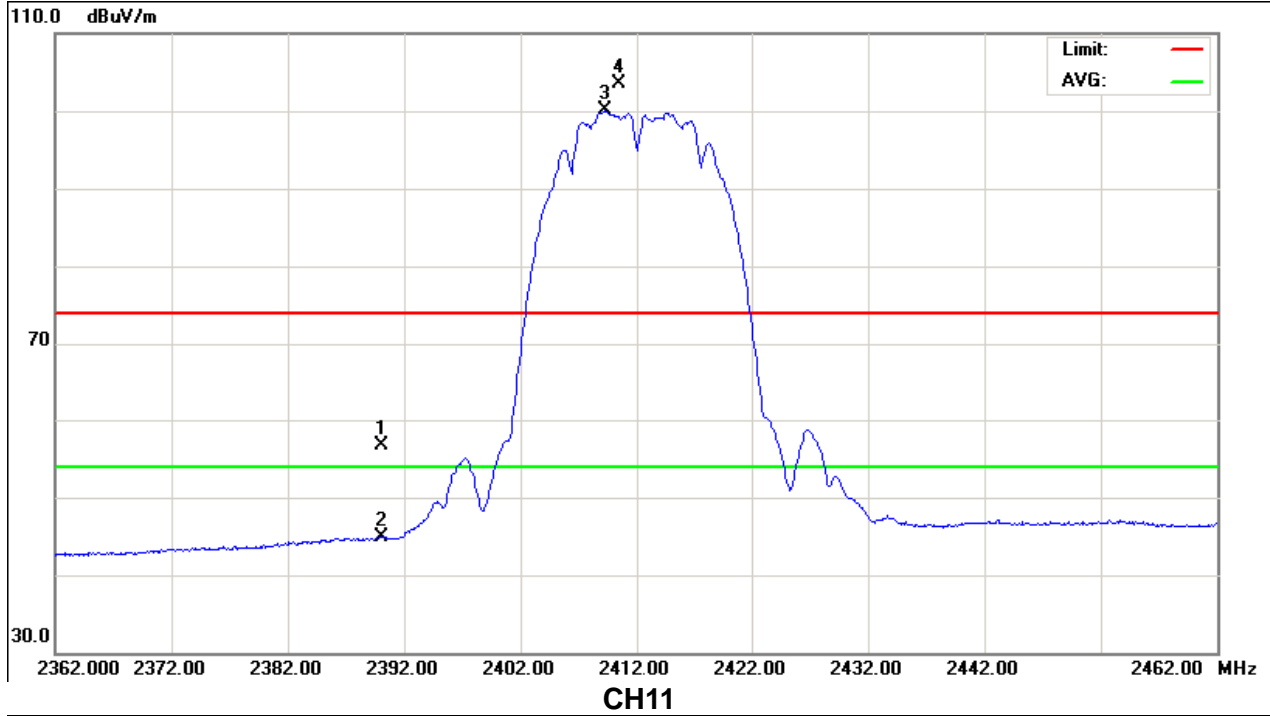



EUT :	WIFI MODULE	Model Name :	WL0159
Temperature :	20 °C	Relative Humidity :	51 %
Pressure :	1010 hPa	Test Voltage :	AC 120V/60Hz
Test Mode :	TX G MODE 2412MHz/2462MHz (Vertical)		
Note :	1. The transmitter was setup to transmit at the lowest channel (CH01). Then the field strength was measured at 2310-2390 MHz. 2. The transmitter was setup to transmit at the highest channel (CH11). Then the field strength was measured at 2483.5-2500 MHz.		

Freq.	Ant.Pol.	Reading		Ant./CF	Act.		Limit		Note
		Peak	AV		Peak	AV	Peak	AV	
(MHz)	H/V	(dBuV)	(dBuV)	CF(dB)	(dBuV/m)	(dBuV/m)	(dBuV/m)	(dBuV/m)	
2390.00	V	24.01	13.24	31.54	55.55	44.78	74.00	54.00	CH01
2483.50	V	19.35	12.12	31.70	51.05	43.82	74.00	54.00	CH11

**Remark :**

- (1) Radiated emissions measured in frequency range above 1000MHz were made with an instrument using Peak detector mode and AV detector mode of the emission .
- (2) EUT Orthogonal Axis :  
 "X" - denotes Laid on Table ; "Y" - denotes Vertical Stand ; "Z" - denotes Side Stand
- (3) During the measurements above 1 GHz it is taken care of that the EUT is always within the 3 dB cone of radiation BW of the used antenna



Restricted Bands Requirements, Vertical  
CH01

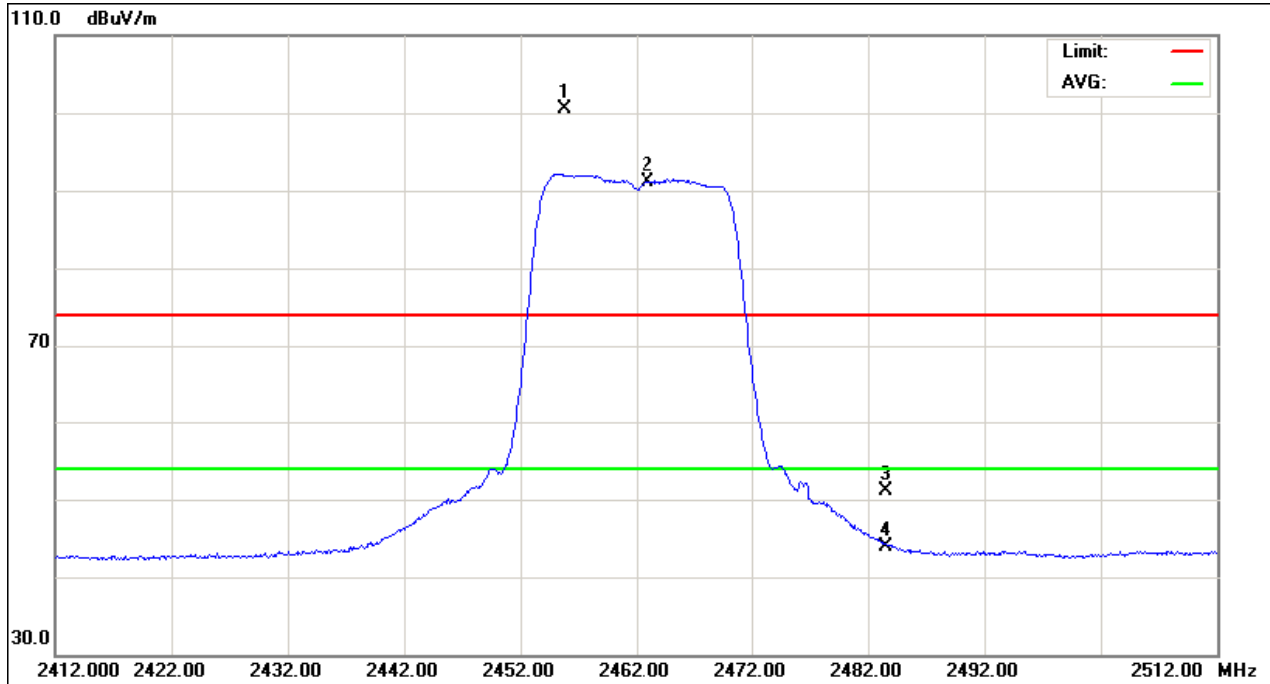
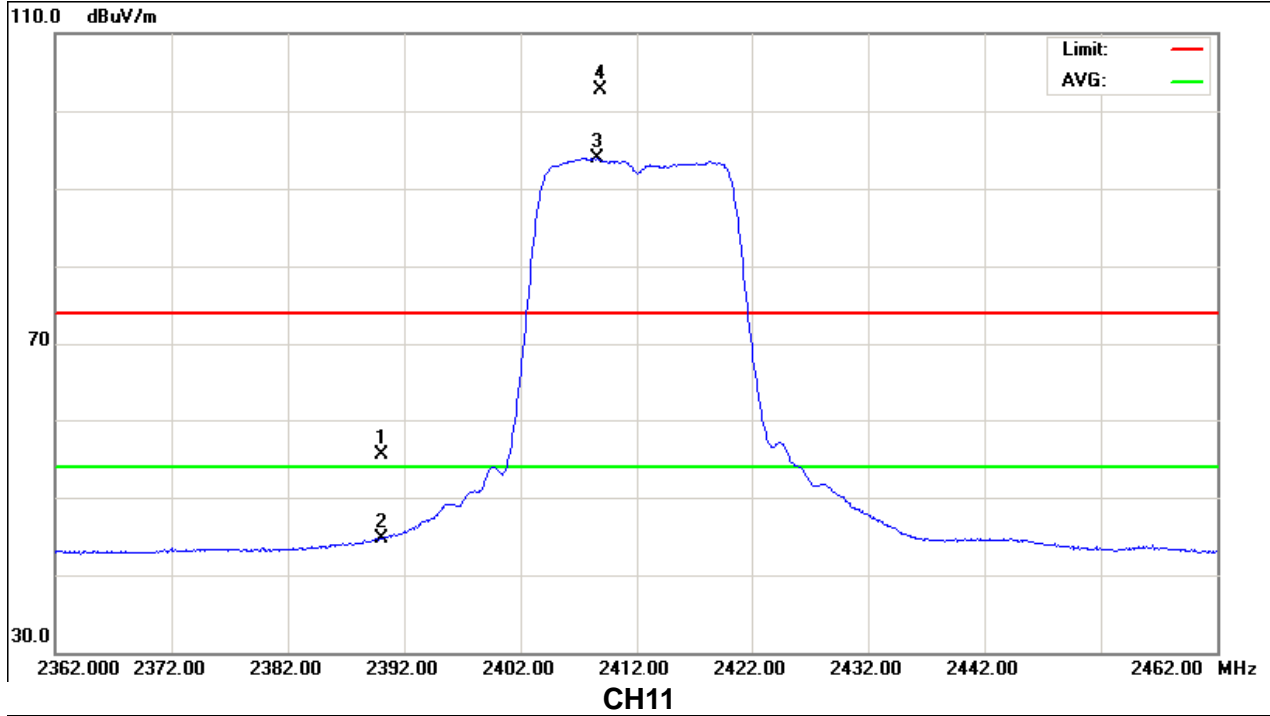



EUT :	WIFI MODULE	Model Name :	WL0159
Temperature :	20 °C	Relative Humidity :	51 %
Pressure :	1010 hPa	Test Voltage :	AC 120V/60Hz
Test Mode :	TX G MODE 2412MHz/2462MHz (Horizontal)		
Note :	1. The transmitter was setup to transmit at the lowest channel (CH01). Then the field strength was measured at 2310-2390 MHz. 2. The transmitter was setup to transmit at the highest channel (CH11). Then the field strength was measured at 2483.5-2500 MHz.		

Freq.	Ant.Pol.	Reading		Ant./CF	Act.		Limit		Note
		Peak	AV		Peak	AV	Peak	AV	
(MHz)	H/V	(dBuV)	(dBuV)	CF(dB)	(dBuV/m)	(dBuV/m)	(dBuV/m)	(dBuV/m)	
2390.00	H	23.50	13.65	31.54	55.04	45.19	74.00	54.00	CH01
2483.50	H	28.44	18.55	31.70	60.14	50.25	74.00	54.00	CH11

**Remark :**

- (1) Radiated emissions measured in frequency range above 1000MHz were made with an instrument using Peak detector mode and AV detector mode of the emission ◦
- (2) EUT Orthogonal Axis :  
 "X" - denotes Laid on Table ; "Y" - denotes Vertical Stand ; "Z" - denotes Side Stand
- (3) During the measurements above 1 GHz it is taken care of that the EUT is always within the 3 dB cone of radiation BW of the used antenna



Restricted Bands Requirements, Horizontal  
CH01

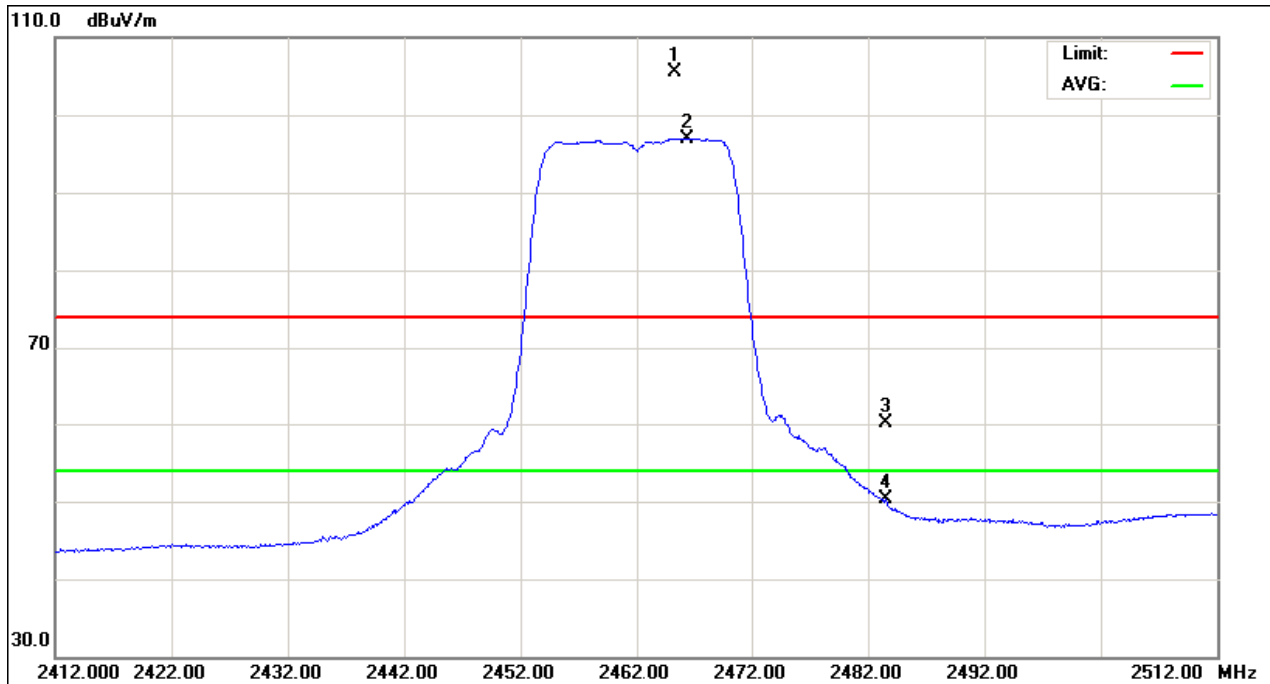
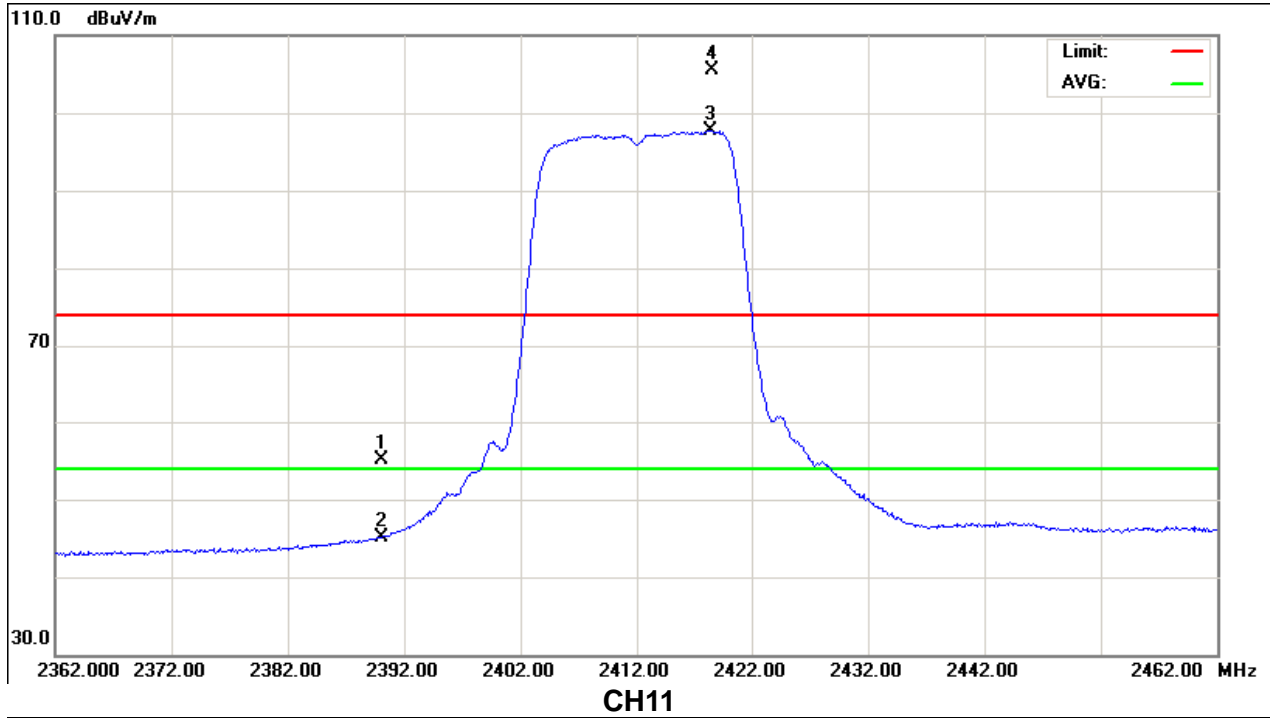



**5. BANDWIDTH TEST**

**5.1 Applied procedures / limit**

FCC Part15 (15.247) , Subpart C				
Section	Test Item	Limit	Frequency Range (MHz)	Result
15.247 (a)(2)	Bandwidth	$\geq 500\text{KHz}$ (6dB bandwidth)	2400-2483.5	PASS

**5.1.1 MEASUREMENT INSTRUMENTS LIST**

Item	Kind of Equipment	Manufacturer	Type No.	Serial No.	Calibrated until
1	Spectrum Analyzer	R&S	FSP_40	100129	Jan. 05, 2011

Remark: " N/A" denotes No Model Name. , Serial No. or No Calibration specified.

**5.1.2 TEST PROCEDURE**

- a. The EUT was directly connected to the spectrum analyzer and antenna output port as show in the block diagram below,
- b. Spectrum Setting : RBW= 100KHz, VBW=100KHz, Sweep time = 20 ms.

**5.1.3 DEVIATION FROM STANDARD**

No deviation.



**5.1.4 TEST SETUP**

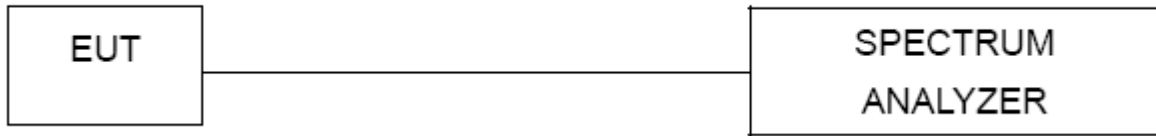

**5.1.5 EUT OPERATION CONDITIONS**

The EUT tested system was configured as the statements of 4.1.6 Unless otherwise a special operating condition is specified in the follows during the testing.





**5.1.6 TEST RESULTS**

EUT :	WIFI MODULE	Model Name :	WL0159
Temperature :	24 °C	Relative Humidity :	60 %
Pressure :	1016 hPa	Test Voltage :	AC 120V/60Hz
Test Mode :	TX B MODE /CH01, CH06, CH11		

Test Channel	Frequency (MHz)	Bandwidth (MHz)	99% Occupied BW (MHz)	LIMIT (MHz)
CH01	2412	12.32	15.32	>=500KHz
CH06	2437	12.60	15.32	>=500KHz
CH11	2462	12.24	15.28	>=500KHz

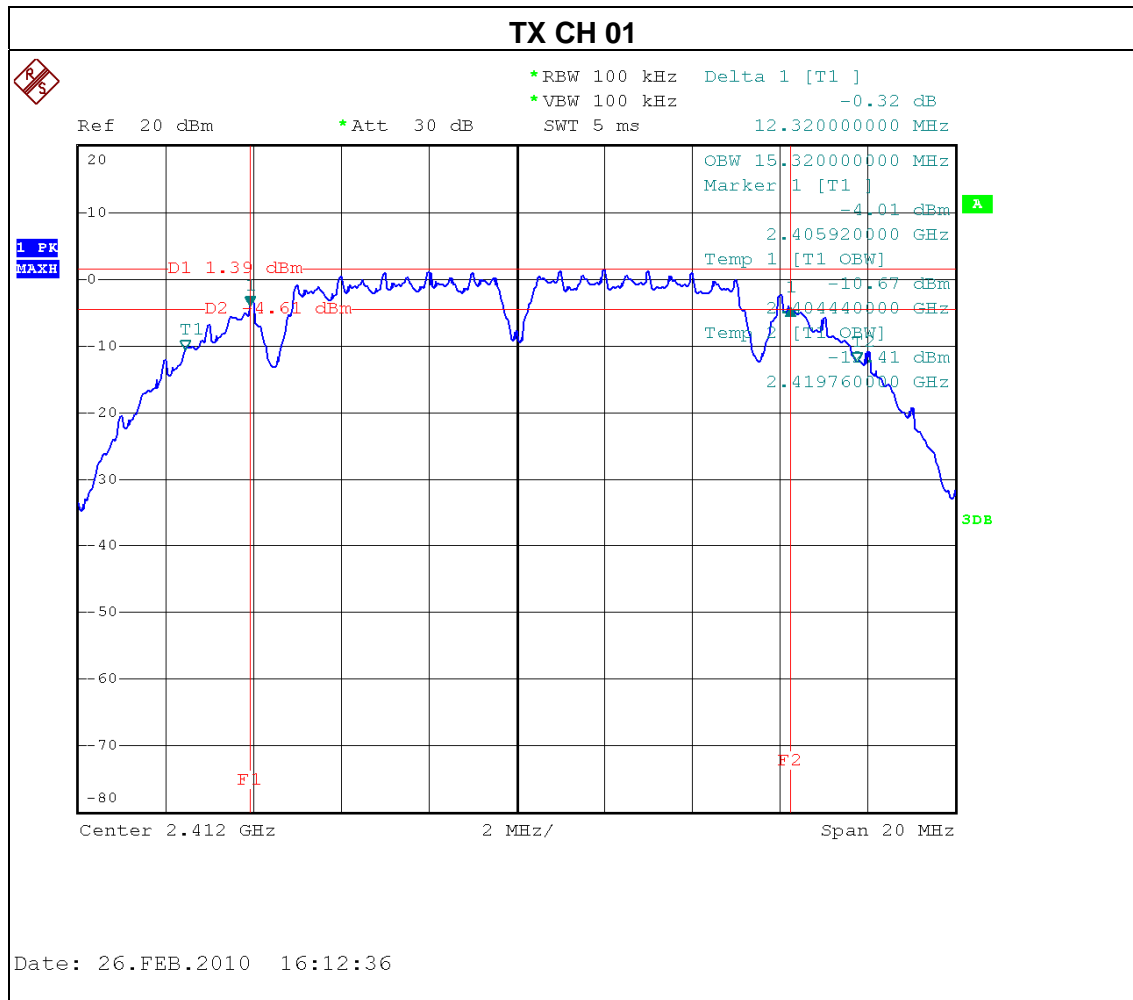

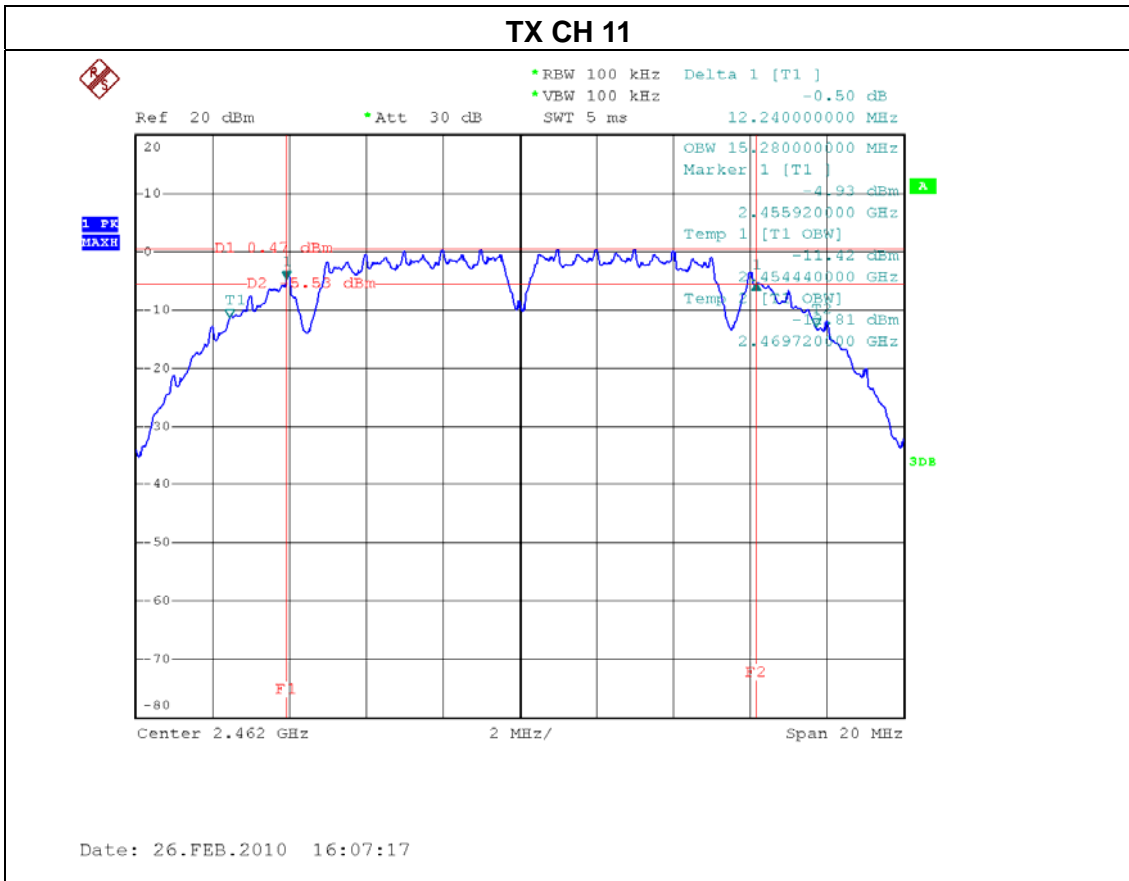
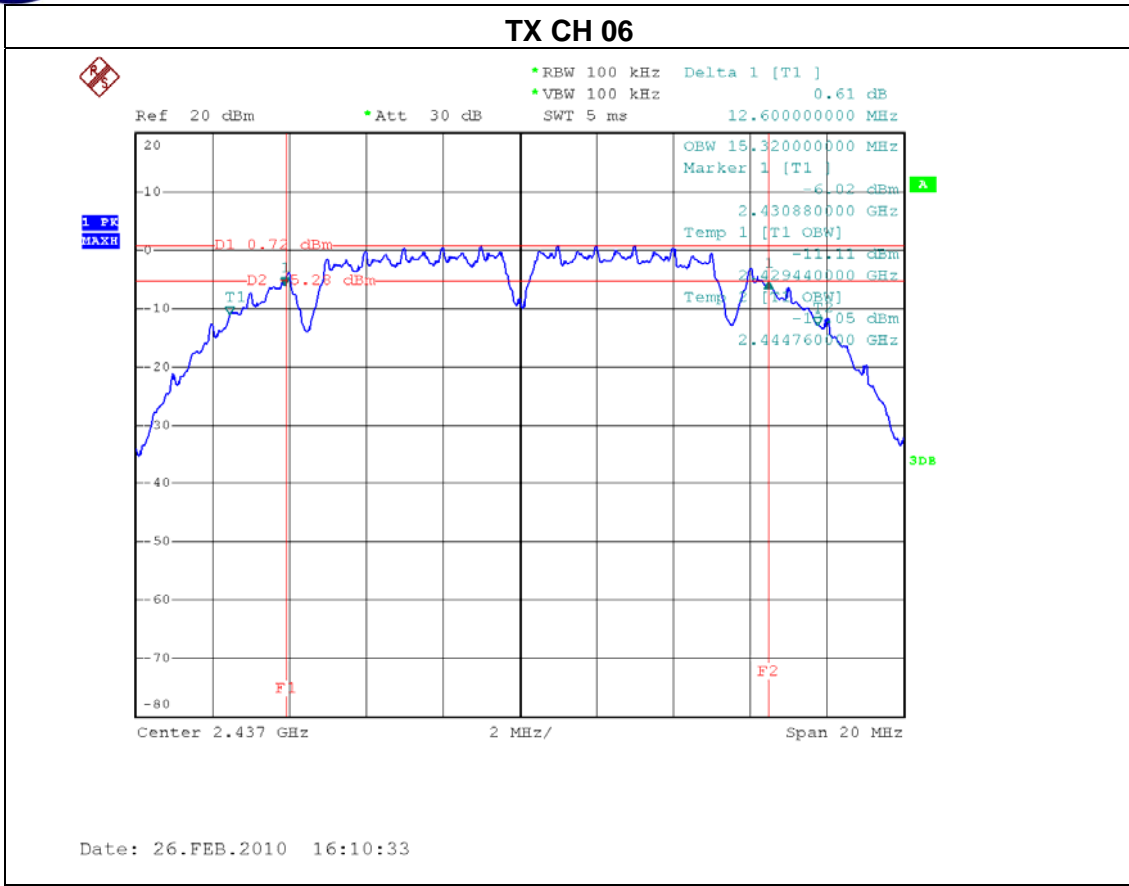



EUT :	WIFI MODULE	Model Name :	WL0159
Temperature :	24 °C	Relative Humidity :	60 %
Pressure :	1016 hPa	Test Voltage :	AC 120V/60Hz
Test Mode :	TX G MODE /CH01, CH06, CH11		

Test Channel	Frequency (MHz)	Bandwidth (MHz)	99% Occupied BW (MHz)	LIMIT (MHz)
CH01	2412	16.60	16.48	>=500KHz
CH06	2437	16.52	16.48	>=500KHz
CH11	2462	16.56	16.48	>=500KHz

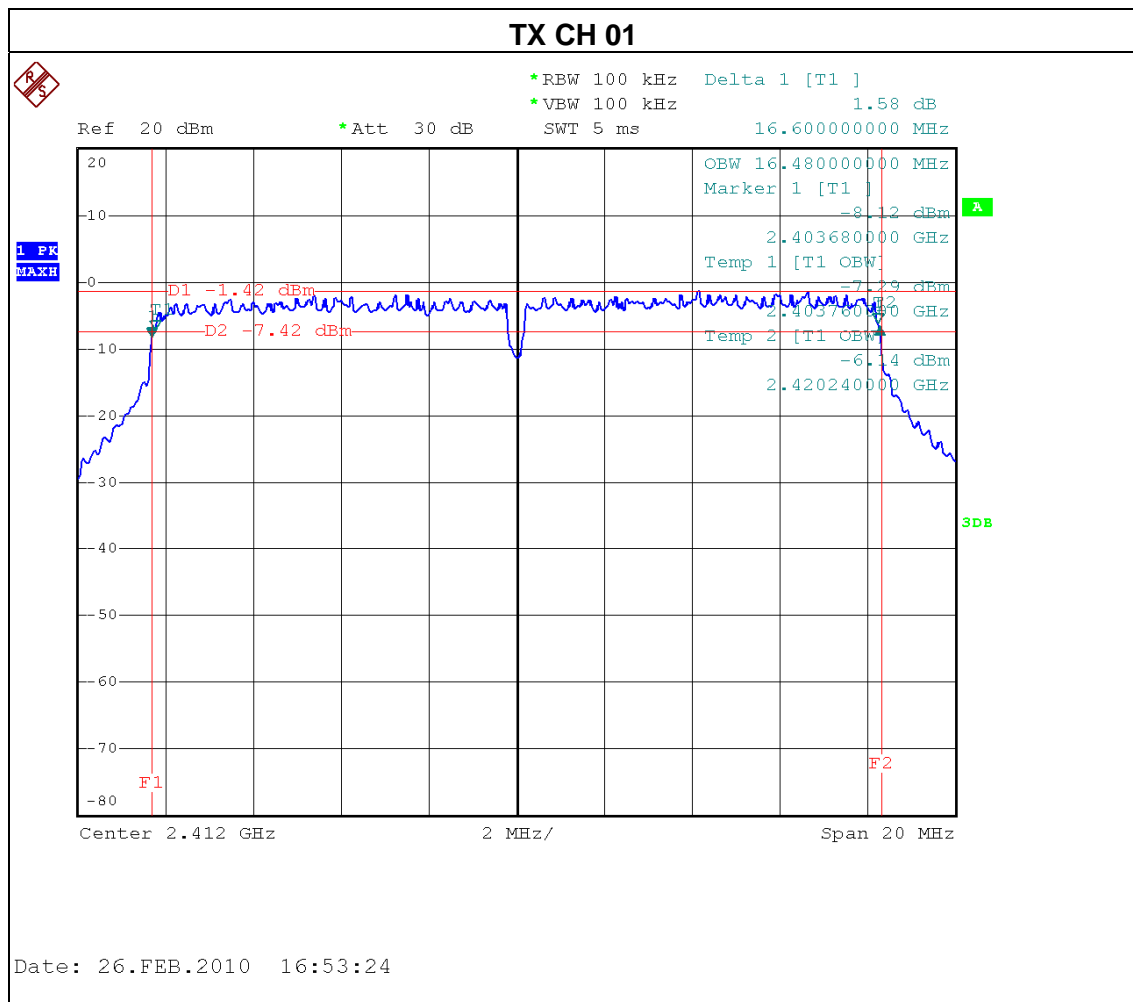

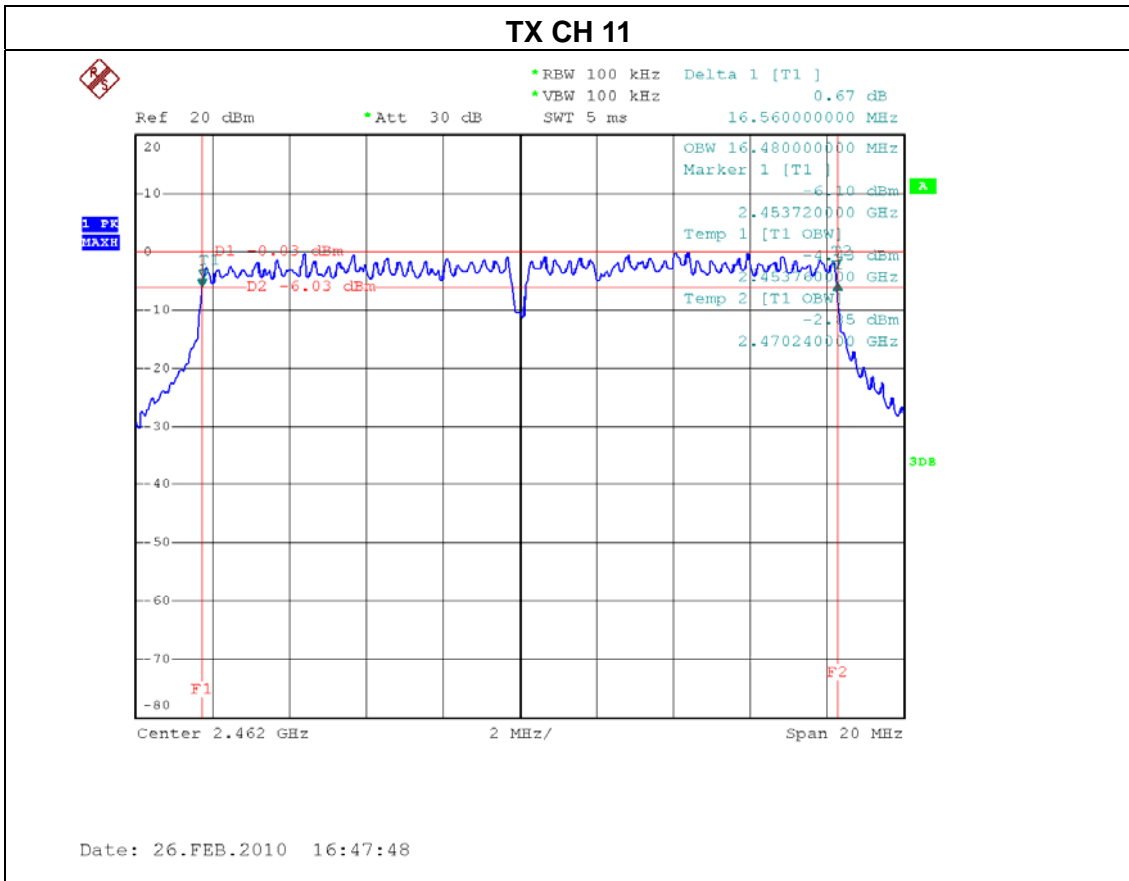
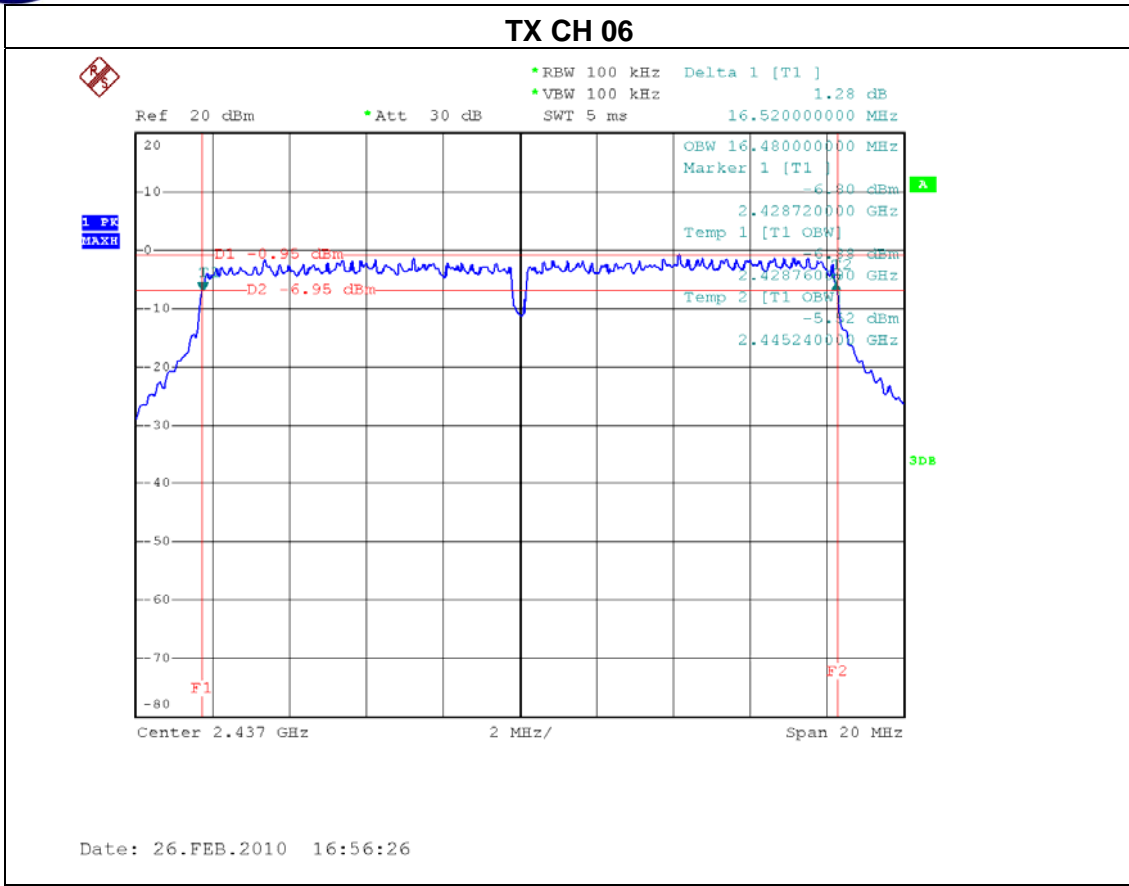



**6. PEAK OUTPUT POWER TEST**

**6.1 Applied procedures / limit**

FCC Part15 (15.247) , Subpart C				
Section	Test Item	Limit	Frequency Range (MHz)	Result
15.247 (b)(1)	Peak Output Power	1 watt or 30dBm	2400-2483.5	PASS

**6.1.1 MEASUREMENT INSTRUMENTS LIST**

Item	Kind of Equipment	Manufacturer	Type No.	Serial No.	Calibrated until
1	Power Meter	Anritsu	ML2487A	6K00004714	Feb. 10, 2011
2	Power Meter Sensor	Anritsu	MA2491A	34138	Feb. 10, 2011

Remark: " N/A" denotes No Model Name. , Serial No. or No Calibration specified.

**6.1.2 TEST PROCEDURE**

- a. The EUT was directly connected to the power metter and antenna output port as show in the block diagram below,

**6.1.3 DEVIATION FROM STANDARD**

No deviation.

**6.1.4 TEST SETUP**



**6.1.5 EUT OPERATION CONDITIONS**

The EUT tested system was configured as the statements of 4.1.6 Unless otherwise a special operating condition is specified in the follows during the testing.



**6.1.6 TEST RESULTS**

EUT :	WIFI MODULE	Model Name :	WL0159
Temperature :	24 °C	Relative Humidity :	60 %
Pressure :	1016 hPa	Test Voltage :	AC 120V/60Hz
Test Mode :	TX B MODE /CH01, CH06, CH11		

Test Channel	Frequency (MHz)	Peak Output Power (dBm)	LIMIT (dBm)	LIMIT (W)
CH01	2412 MHz	12.78	30	1
CH06	2437 MHz	13.19	30	1
CH11	2462 MHz	13.12	30	1

EUT :	WIFI MODULE	Model Name :	WL0159
Temperature :	24 °C	Relative Humidity :	60 %
Pressure :	1016 hPa	Test Voltage :	AC 120V/60Hz
Test Mode :	TX G MODE /CH01, CH06, CH11		

Test Channel	Frequency (MHz)	Peak Output Power (dBm)	LIMIT (dBm)	LIMIT (W)
CH01	2412 MHz	13.32	30	1
CH06	2437 MHz	13.41	30	1
CH11	2462 MHz	13.02	30	1



**7. ANTENNA CONDUCTED SPURIOUS EMISSION**

**7.1 Applied procedures / limit**

20dBc in any 100 kHz bandwidth outside the operating frequency band. In case the emission fall within the restricted band specified on 15.205(a), then the 15.209(a) limit in the table below has to be followed.

Frequencies (MHz)	Field Strength (micровolts/meter)	Measurement Distance (meters)
0.009~0.490	2400/F(KHz)	300
0.490~1.705	24000/F(KHz)	30
1.705~30.0	30	30
30~88	100	3
88~216	150	3
216~960	200	3
Above 960	500	3

**7.1.1 MEASUREMENT INSTRUMENTS LIST**

Item	Kind of Equipment	Manufacturer	Type No.	Serial No.	Calibrated until
1	Spectrum Analyzer	R&S	FSP_40	100129	Jan. 05, 2011

Remark: " N/A" denotes No Model Name. , Serial No. or No Calibration specified.

The following table is the setting of the spectrum analyzer.

Spectrum Parameter	Setting
Attenuation	Auto
Span Frequency	100 MHz
RB / VB (emission in restricted band)	1MHz / 1MHz for Peak, 1 MHz / 10Hz for Average
RB / VB (other emission)	100 KHz /100 KHz for Peak

**7.1.2 TEST PROCEDURE**

- a. The EUT was directly connected to the spectrum analyzer and antenna output port as show in the block diagram below,
- b. Spectrum Setting : RBW= 100KHz, VBW=100KHz, Sweep time = 10 ms.

**7.1.3 DEVIATION FROM STANDARD**

No deviation.

**7.1.4 TEST SETUP**





### **7.1.5 EUT OPERATION CONDITIONS**

The EUT tested system was configured as the statements of 4.1.6 Unless otherwise a special operating condition is specified in the follows during the testing.





**7.1.6 TEST RESULTS**

EUT :	WIFI MODULE	Model Name :	WL0159
Temperature :	24 °C	Relative Humidity :	60 %
Pressure :	1016 hPa	Test Voltage :	AC 120V/60Hz
Test Mode :	TX B MODE /CH01, CH11		

Channel of Worst Data: CH11			
The max. radio frequency power in any 100kHz bandwidth outside the frequency band		The max. radio frequency power in any 100 kHz bandwidth within the frequency band.	
FREQUENCY(MHz)	POWER(dBm)	FREQUENCY(MHz)	POWER(dBm)
2347.20	-46.30	2491.56	-46.25
Result			
In any 100kHz bandwidth outside the frequency band, the radio frequency power is at least 20dB below that in the 100kHz bandwidth within the band that contains the highest level of the desired power.			

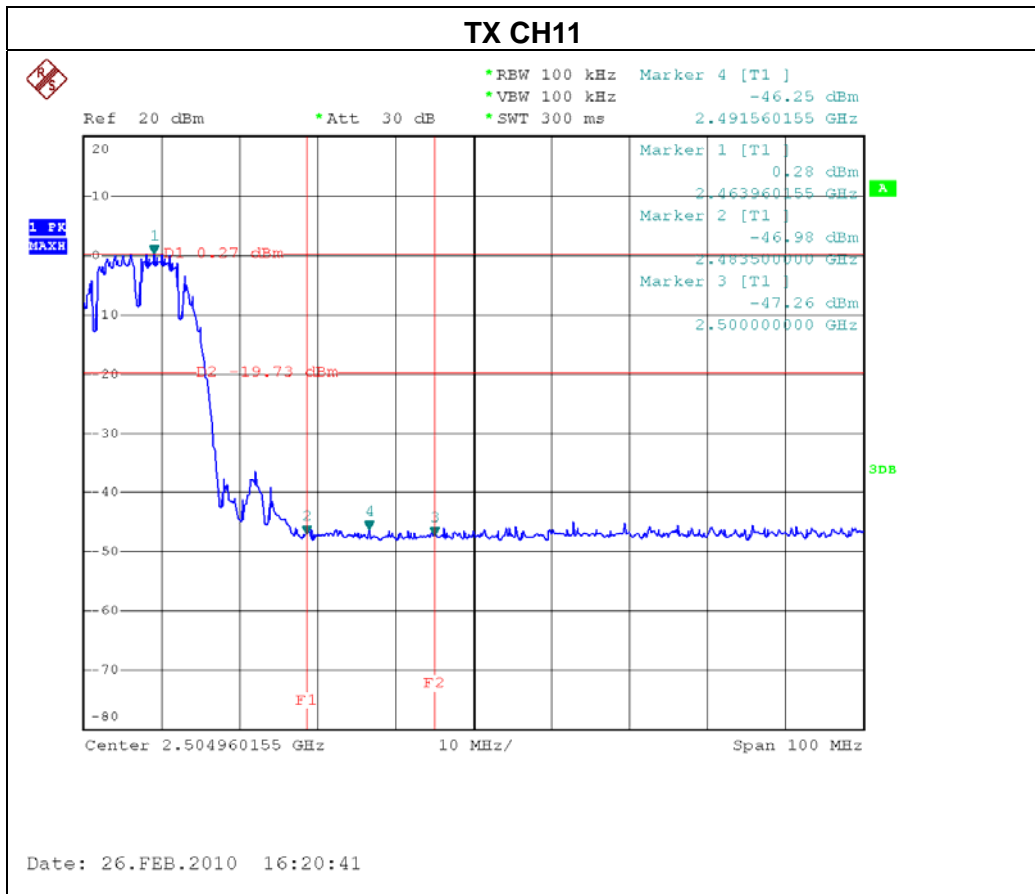
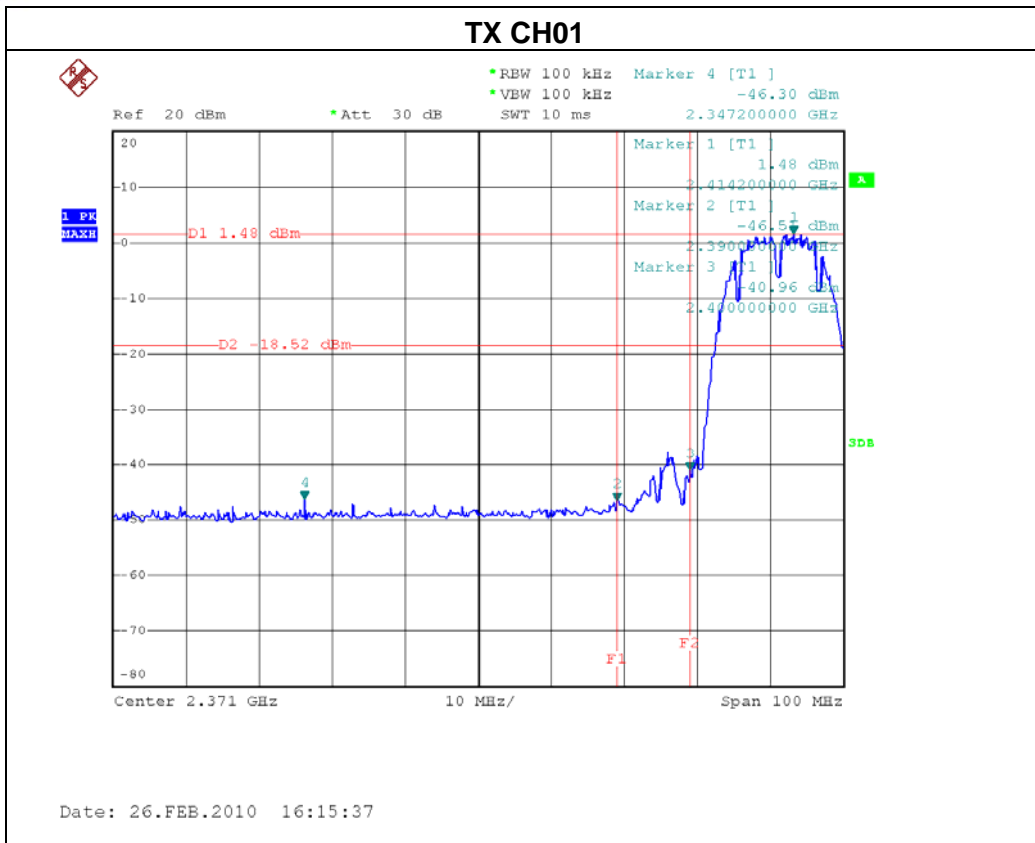



EUT :	WIFI MODULE	Model Name :	WL0159
Temperature :	24 °C	Relative Humidity :	60 %
Pressure :	1016 hPa	Test Voltage :	AC 120V/60Hz
Test Mode :	TX G MODE /CH01, CH11		

Channel of Worst Data: CH11			
The max. radio frequency power in any 100kHz bandwidth outside the frequency band		The max. radio frequency power in any 100 kHz bandwidth within the frequency band.	
FREQUENCY(MHz)	POWER(dBm)	FREQUENCY(MHz)	POWER(dBm)
2390.00	-47.66	2483.50	-44.74
Result			
In any 100kHz bandwidth outside the frequency band, the radio frequency power is at least 20dB below that in the 100kHz bandwidth within the band that contains the highest level of the desired power.			

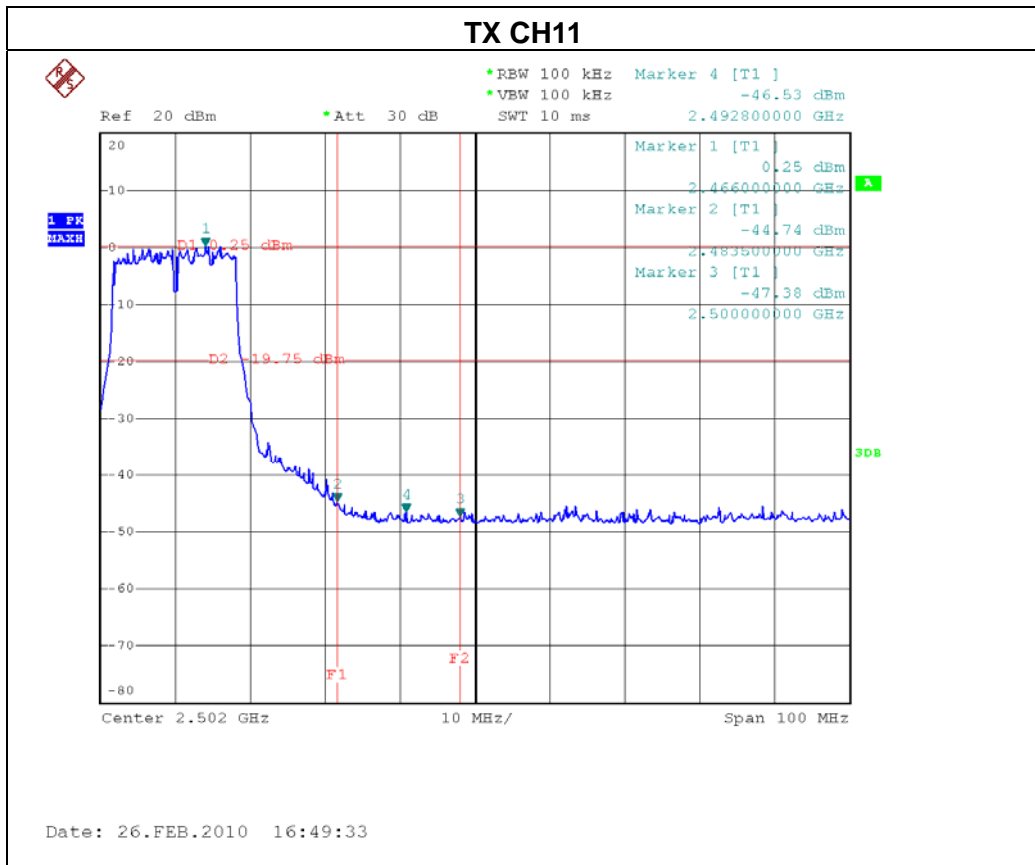
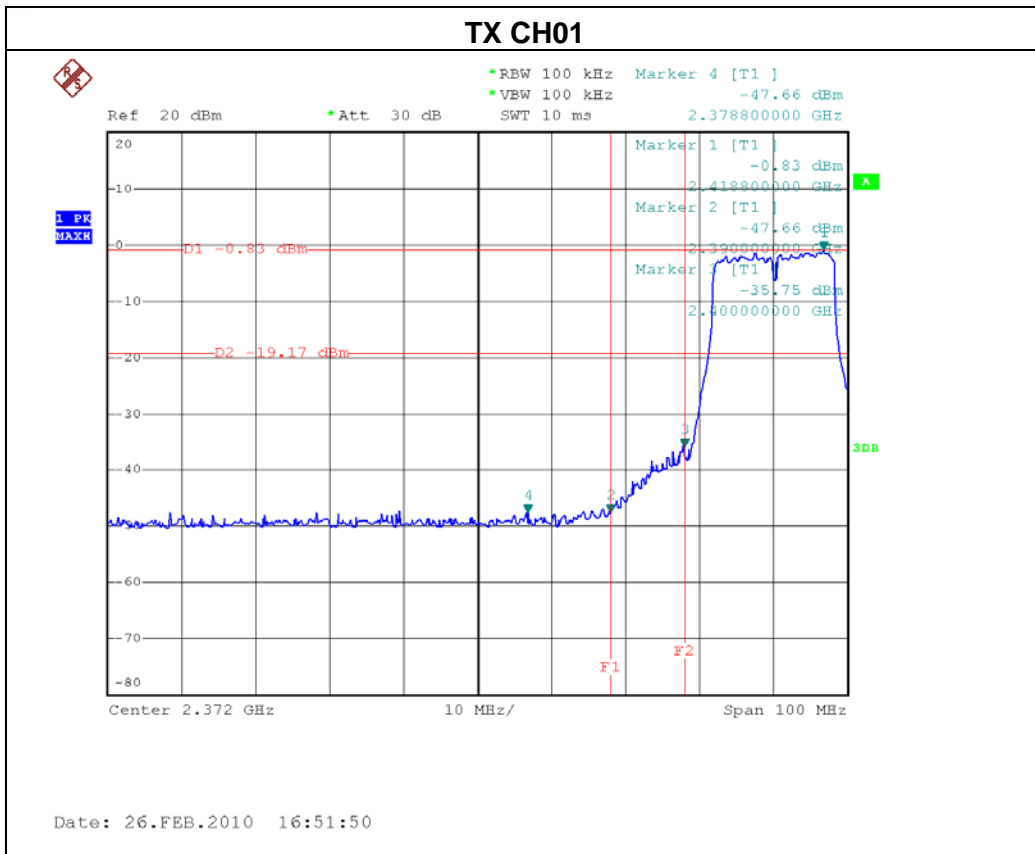



**8. POWER SPECTRAL DENSITY TEST**

**8.1 Applied procedures / limit**

FCC Part15 (15.247) , Subpart C				
Section	Test Item	Limit	Frequency Range (MHz)	Result
15.247 (d)	Power Spectral Density	8 dBm (in any 3KHz)	2400-2483.5	PASS

**8.1.1 MEASUREMENT INSTRUMENTS LIST**

Item	Kind of Equipment	Manufacturer	Type No.	Serial No.	Calibrated until
1	Spectrum Analyzer	R&S	FSP_40	100129	Jan. 05, 2011

Remark: " N/A" denotes No Model Name. , Serial No. or No Calibration specified.

**8.1.2 TEST PROCEDURE**

- a. The EUT was directly connected to the spectrum analyzer and antenna output port as show in the block diagram below,
- b. Spectrum Setting : RBW=3KHz, VBW=30 KHz, Sweep time = 500s.

**8.1.3 DEVIATION FROM STANDARD**

No deviation.

**8.1.4 TEST SETUP**



**8.1.5 EUT OPERATION CONDITIONS**

The EUT tested system was configured as the statements of 4.1.6 Unless otherwise a special operating condition is specified in the follows during the testing.



**8.1.6 TEST RESULTS**

EUT :	WIFI MODULE	Model Name :	WL0159
Temperature :	24 °C	Relative Humidity :	60 %
Pressure :	1016 hPa	Test Voltage :	AC 120V/60Hz
Test Mode :	TX B MODE /CH01, CH06, CH11		

Test Channel	Frequency (MHz)	Power Density (dBm)	LIMIT (dBm)
CH01	2412 MHz	-16.86	8
CH06	2437 MHz	-17.32	8
CH11	2462 MHz	-17.49	8

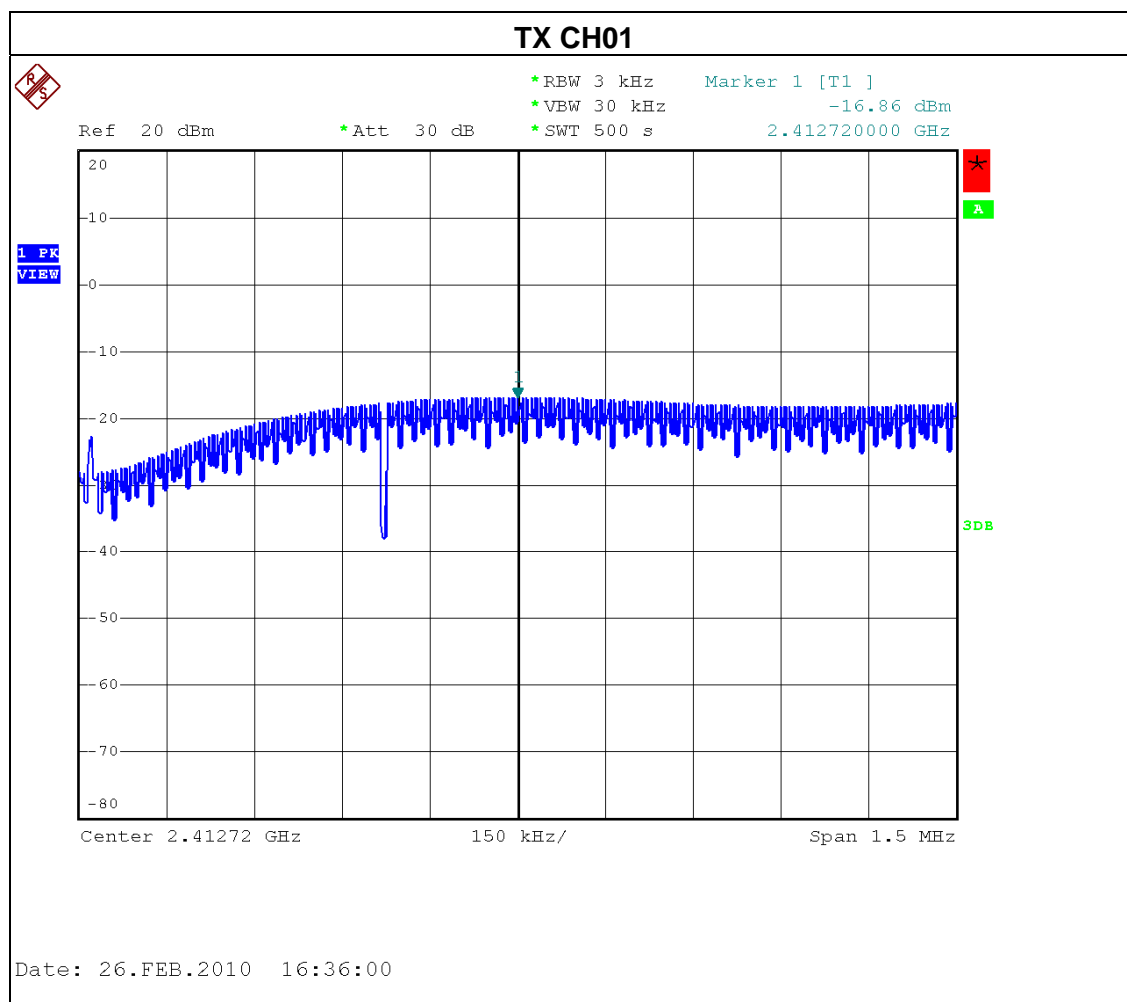

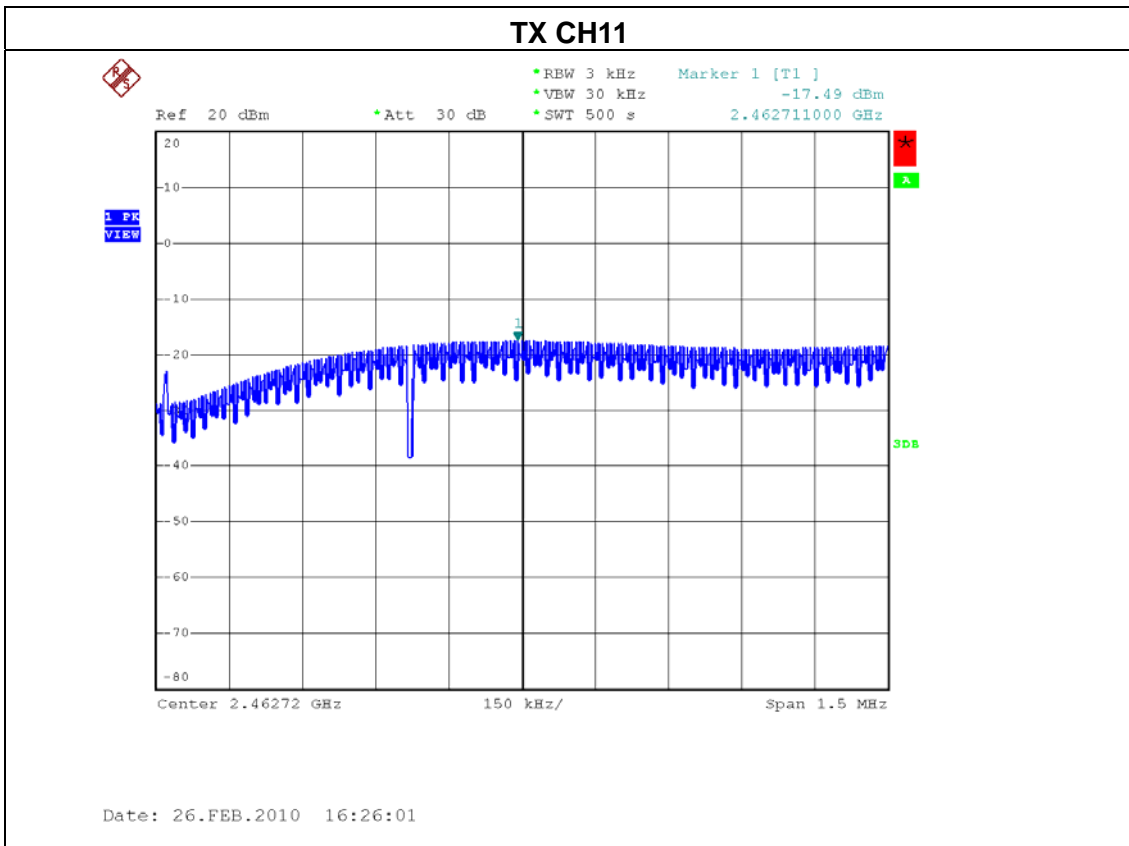
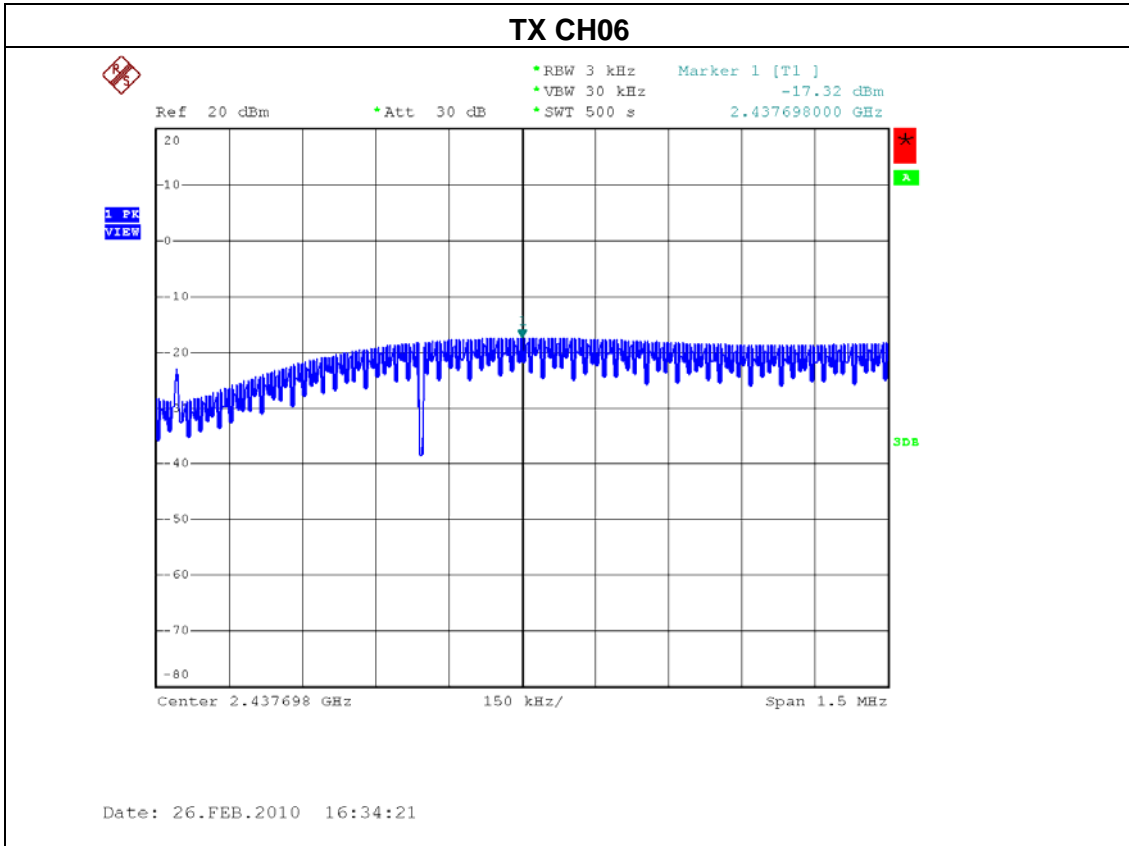



# Neutron Engineering Inc.

EUT :	WIFI MODULE	Model Name :	WL0159
Temperature :	24 °C	Relative Humidity :	60 %
Pressure :	1016 hPa	Test Voltage :	AC 120V/60Hz
Test Mode :	TX G MODE /CH01, CH06, CH11		

Test Channel	Frequency (MHz)	Power Density (dBm)	LIMIT (dBm)
CH01	2412 MHz	-15.98	8
CH06	2437 MHz	-14.57	8
CH11	2462 MHz	-13.53	8

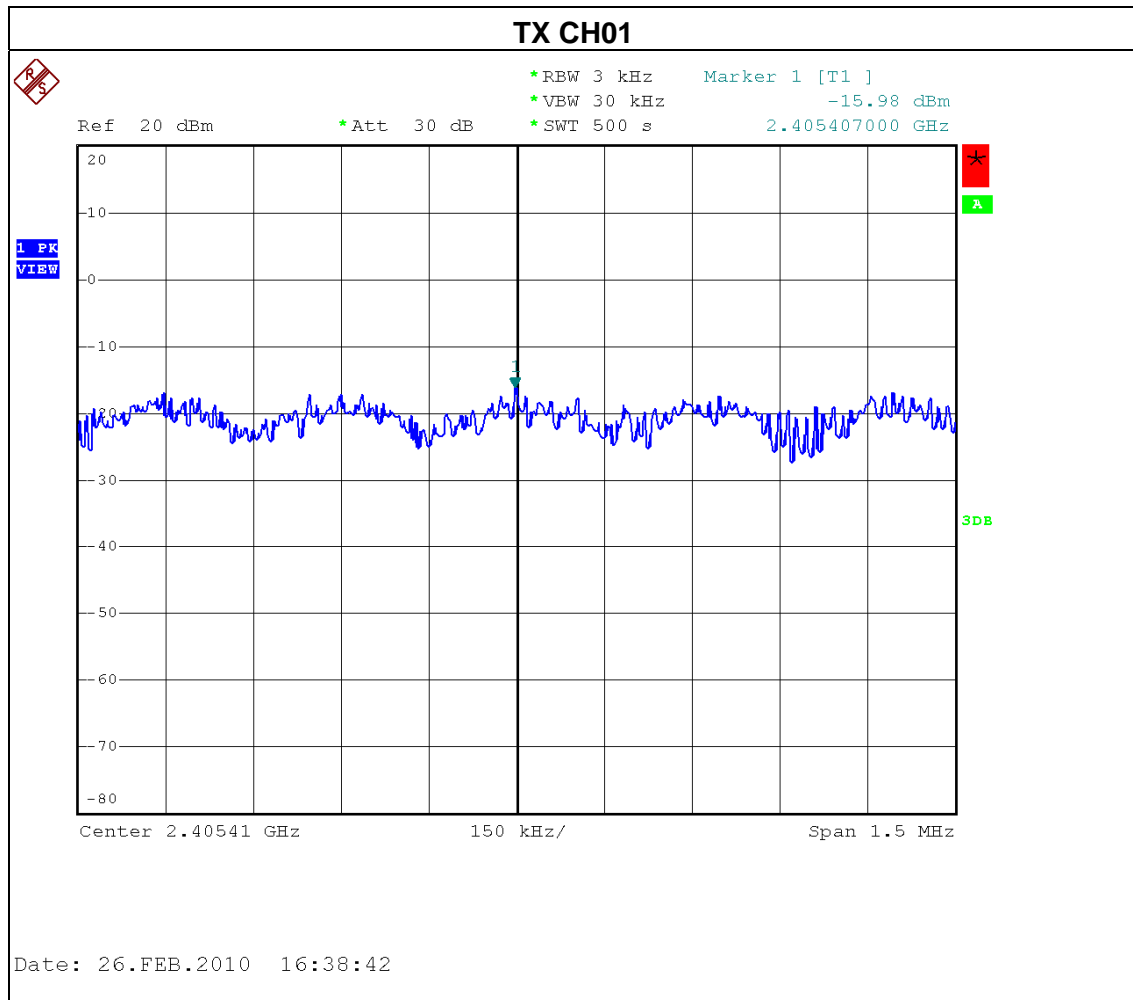



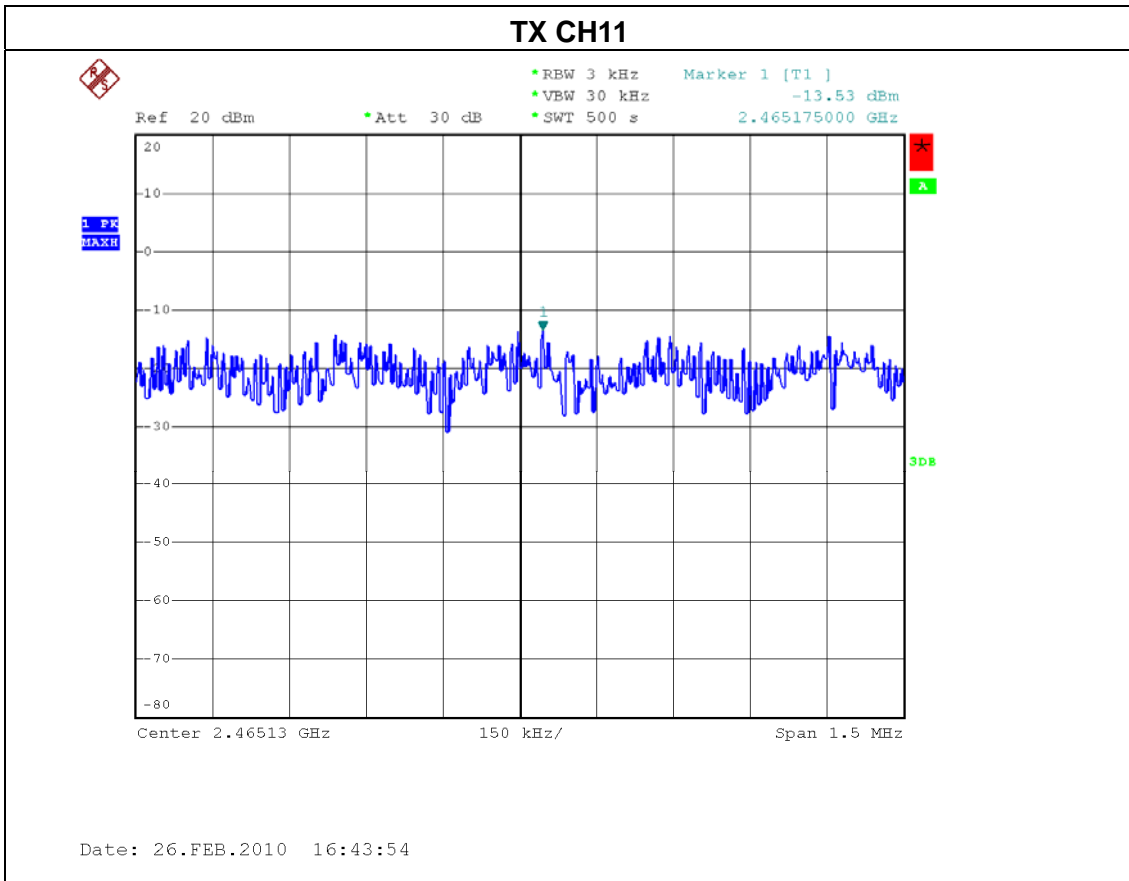
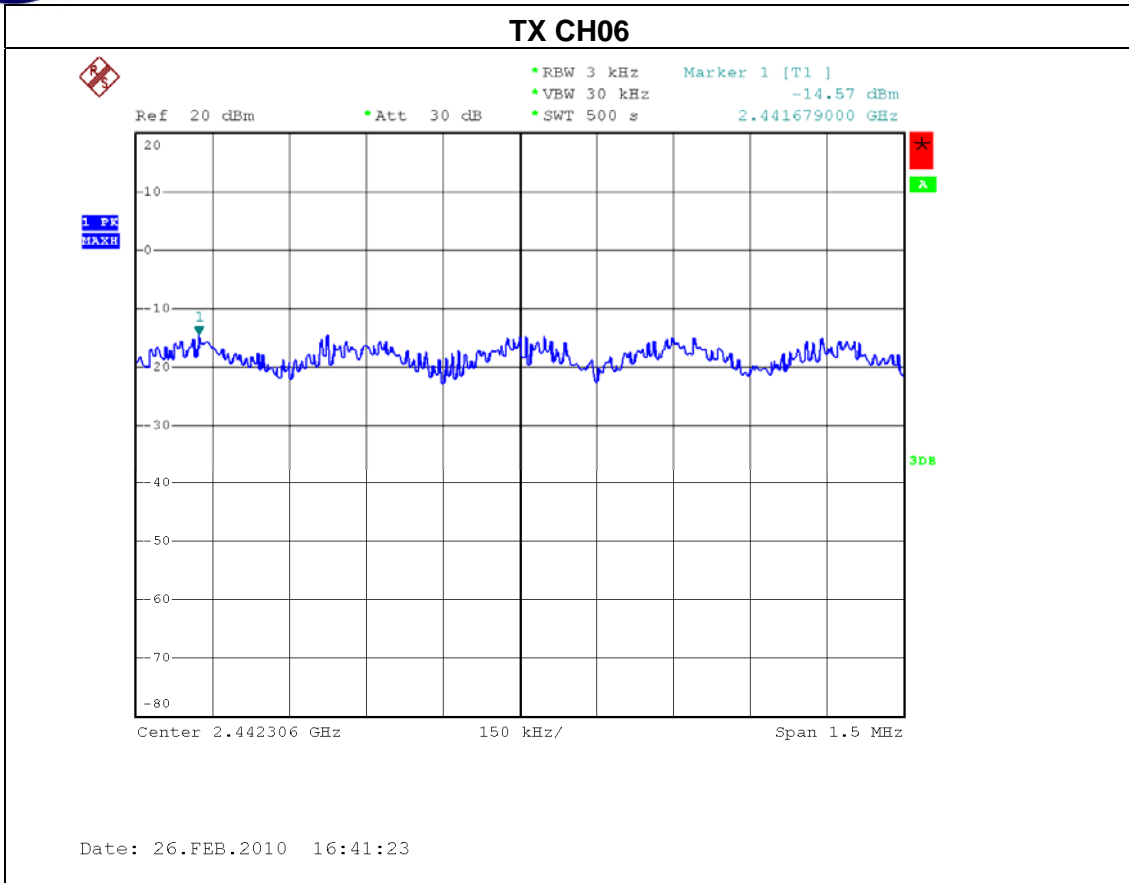



**9. RF EXPOSURE TEST**

**9.1 APPLIED PROCEDURES / LIMIT**

Systems operating under the provisions of this section shall be operated in a manner that ensures that the public is not exposed to radio frequency energy levels in excess limit for maximum permissible exposure. In accordance with 47 CFR FCC Part 2 Subpart J, section 2.1091 this device has been defined as a mobile device whereby a distance of 0.2 m normally can be maintained between the user and the device.

(A) Limits for Occupational / Controlled Exposure

Frequency Range (MHz)	Electric Field Strength (E) (V/m)	Magnetic Field Strength (H) (A/m)	Power Density (S) (mW/ cm <sup>2</sup> )	Averaging Time  E  <sup>2</sup> , H  <sup>2</sup> or S (minutes)
0.3-3.0	614	1.63	(100)*	6
3.0-30	1842 / f	4.89 / f	(900 / f)*	6
30-300	61.4	0.163	1.0	6
300-1500			F/300	6
1500-100,000			5	6

(B) Limits for General Population / Uncontrolled Exposure

Frequency Range (MHz)	Electric Field Strength (E) (V/m)	Magnetic Field Strength (H) (A/m)	Power Density (S) (mW/ cm <sup>2</sup> )	Averaging Time  E  <sup>2</sup> , H  <sup>2</sup> or S (minutes)
0.3-1.34	614	1.63	(100)*	30
1.34-30	824/f	2.19/f	(180/f)*	30
30-300	27.5	0.073	0.2	30
300-1500			F/1500	30
1500-100,000			1.0	30

Note: f = frequency in MHz ; \*Plane-wave equivalent power density

**9.1.1 MPE CALCULATION METHOD**

$$E \text{ (V/m)} = \frac{\sqrt{30 \times P \times G}}{d} \qquad \text{Power Density: } Pd \text{ (W/m}^2\text{)} = \frac{E^2}{377}$$

- E** = Electric field (V/m)
- P** = Peak RF output power (W)
- G** = EUT Antenna numeric gain (numeric)
- d** = Separation distance between radiator and human body (m)

The formula can be changed to

$$Pd = \frac{30 \times P \times G}{377 \times d^2}$$

From the peak EUT RF output power, the minimum mobile separation distance, d=0.2m, as well as the gain of the used antenna, the RF power density can be obtained

**9.1.2 DEVIATION FROM STANDARD**

No deviation.

**9.1.3 EUT OPERATION CONDITIONS**

The EUT tested system was configured as the statements of 4.1.6 Unless otherwise a special operating condition is specified in the follows during the testing.



**9.1.4 TEST RESULTS**

EUT :	WIFI MODULE	Model Name :	WL0159
Temperature :	24 °C	Relative Humidity :	60 %
Pressure :	1016 hPa	Test Voltage :	AC 120V/60Hz
Test Mode :	<b>TX B MODE CH01, CH06, CH11</b>		

Antenna Gain (dBi)	Antenna Gain (numeric)	Peak Output Power (dBm)	Peak Output Power (mW)	Power Density (S) (mW/cm <sup>2</sup> )	Limit of Power Density (S) (mW/cm <sup>2</sup> )	Test Result
2.0	1.5849	12.78	18.9671	0.00598343	1	Complies
<b>2.0</b>	<b>1.5849</b>	<b>13.19</b>	<b>20.8449</b>	<b>0.00657583</b>	<b>1</b>	<b>Complies</b>
2.0	1.5849	13.12	20.5116	0.00647069	1	Complies

EUT :	WIFI MODULE	Model Name :	WL0159
Temperature :	24 °C	Relative Humidity :	60 %
Pressure :	1016 hPa	Test Voltage :	AC 120V/60Hz
Test Mode :	<b>TX G MODE CH01, CH06, CH11</b>		

Antenna Gain (dBi)	Antenna Gain (numeric)	Peak Output Power (dBm)	Peak Output Power (mW)	Power Density (S) (mW/cm <sup>2</sup> )	Limit of Power Density (S) (mW/cm <sup>2</sup> )	Test Result
2.0	1.5849	13.32	21.4783	0.00677564	1	Complies
<b>2.0</b>	<b>1.5849</b>	<b>13.41</b>	<b>21.9280</b>	<b>0.00691752</b>	<b>1</b>	<b>Complies</b>
2.0	1.5849	13.02	20.0447	0.00632340	1	Complies



**10. EUT TEST PHOTO**

**Conducted Measurement Photos**



**Radiated Measurement Photos**

