

**ELECTROMAGNETIC EMISSIONS COMPLIANCE REPORT
INTENTIONAL RADIATOR CERTIFICATION TO
FCC PART 15 SUBPART C
REQUIREMENTS**

OF

150Mbps Wireless N Portable AP

MODEL No.: IPuppy III, IP04223

FCC ID: X7D-IP04223

Trade Mark: TOTOLINK

REPORT NO.: ES141023301E

ISSUE DATE: November 5, 2014

Prepared for

ZIONCOM ELECTRONICS (SHENZHEN) LTD.

Building A1~A2, Lantian Science and Technology Park, Xinyu Road, Xinqiao
Henggang Block Shajing Street, Baoan District, Shenzhen, China

Prepared by

SHENZHEN EMTEK CO., LTD

Bldg 69, Majialong Industry Zone, Nanshan District,
Shenzhen, Guangdong, China
TEL: 86-755-26954280
FAX: 86-755-26954282

VERIFICATION OF COMPLIANCE

Applicant:	ZIONCOM ELECTRONICS (SHENZHEN) LTD. Building A1~A2, Lantian Science and Technology Park, Xinyu Road, Xinqiao Henggang Block Shajing Street, Baoan District, Shenzhen, China
Manufacturer:	ZIONCOM ELECTRONICS (SHENZHEN) LTD. Building A1~A2, Lantian Science and Technology Park, Xinyu Road, Xinqiao Henggang Block Shajing Street, Baoan District, Shenzhen, China
Product Description:	150Mbps Wireless N Portable AP
Model Number:	IPuppy III , IP04223
File Number:	ES141023301E
Date of Test:	October 23, 2014 to November 5, 2014

We hereby certify that:

The above equipment was tested by SHENZHEN EMTEK CO., LTD.

The test data, data evaluation, test procedures, and equipment configurations shown in this report were made in accordance with the procedures given in ANSI C63.4 (2009) and the energy emitted by the sample EUT tested as described in this report is in compliance with conducted and radiated emission limits of FCC Rules Part 15.247

The test results of this report relate only to the tested sample identified in this report.

Date of Test : October 23, 2014 to November 5, 2014

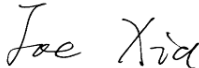
Prepared by : 
Joe Xia /Editor

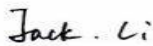
Reviewer : 
Jack Li /Supervisor

Approve & Authorized Signer : 
Lisa Wang/Manager

Table of Contents

1. GENERAL INFORMATION	5
1.1 Product Description	5
1.2 Related Submittal(S) / Grant(S)	5
1.3 Test Methodology	5
1.4 Special Accessories	5
1.5 Equipment Modifications	5
1.6 Test Facility	6
2. SYSTEM TEST CONFIGURATION	7
2.1 Eut Configuration	7
2.2 Eut Exercise	7
2.3 Test Procedure	7
2.4 Configuration Of Tested System	8
3. DESCRIPTION OF TEST MODES.....	9
4. SUMMARY OF TEST RESULTS.....	10
5. CONDUCTED EMISSIONS TEST	11
5.1 Measurement Procedure.....	11
5.2 Test Set-Up (Block Diagram Of Configuration)	11
5.3 Measurement Equipment Used	11
5.4 Conducted Emission Limit	11
5.5 Measurement Result	12
6. RADIATED EMISSION TEST.....	14
6.1 Measurement Procedure.....	14
6.2 Test Set-Up (Block Diagram Of Configuration)	15
6.3 Measurement Equipment Used	16
6.4 Radiated Emission Limit.....	16
6.5 Measurement Result	18
7. 6DB BANDWIDTH TEST	27
7.1 Measurement Procedure.....	27
7.2 Test Set-Up (Block Diagram Of Configuration)	27
7.3 Measurement Equipment Used	27
7.4 Measurement Results	27
8. MAXIMUM PEAK OUTPUT POWER TEST	36
8.1 Measurement Procedure.....	36
8.2 Test Set-Up (Block Diagram Of Configuration)	36
8.3 Measurement Equipment Used	36
8.4 Peak Power Output Limit	36
8.5 Measurement Results	36
9. BAND EDGE TEST	38
9.1 Measurement Procedure.....	38
9.2 Test Set-Up (Block Diagram Of Configuration)	38
9.3 Measurement Equipment Used	38
9.4 Measurement Results	38
10. POWER DENSITY	43
10.1 Test Equipment	43
10.2 Measuring Instruments And Setting	43
10.3 Test Procedures	43
10.4 Block Diagram Of Test Setup	43
10.5 Limit.....	43
10.6 Test Result	43

11. ANTENNA PORT EMISSION.....	52
11.1 Test Equipment	52
11.2 Measuring Instruments And Setting	52
11.3 Test Procedures	52
11.4 Block Diagram Of Test Setup.....	52
11.5 Test Result	52
12. ANTENNA APPLICATION	56
12.1 Antenna Requirement	56
12.2 Result	56
13. UNCERTAINTY	57

1. General Information

1.1 Product Description

A major technical descriptions of EUT is described as following:

- A). Operation Frequency:
2.4G 802.11b/g/n(HT20):2412MHz-2462MHz; 802.11n(HT40): 2422MHz-2452MHz
- B). Modulation: OFDM with BPSK/QPSK/16QAM/64QAM for 802.11g/n,
DSSS with DBPSK/DQPSK/CCK for 802.11b;
- C). Number of Channel: 2.4G 802.11b/g/n(HT20): 11channels; 802.11n(HT40): 7channels
- D). Max Peak Conducted Power: 2.4G wifi 20.46dBm
- E). Antenna Gain: 2.0dBi for 2.4G WIFI
- F). Antenna Type: PiFa antenna
- G). Power Supply: DC 5V from USB

Channel	Frequency (MHz)	Channel	Frequency (MHz)	Channel	Frequency (MHz)
1	2412	5	2432	9	2452
2	2417	6	2437	10	2457
3	2422	7	2442	11	2462
4	2427	8	2447		

Note:

1. This device is included 802.11b, 802.11g, 802.11n 2.4GHz transceiver function.
2. Test of channel was included the lowest middle and highest frequency in lowest data rate and to perform the test, then record on this report.

1.2 Related Submittal(s) / Grant(s)

This submittal(s) (test report) is intended for FCC ID: X7D-IP04223 filing to comply with Section 15.247 of the FCC Part 15, Subpart C Rules.

The composite system is compliance with Subpart B is authorized under a DOC procedure.

1.3 Test Methodology

All the test program has follow FCC new test procedure KDB558074 D01 v03r02, Both conducted and radiated testing was performed according to the procedures in ANSI C63.10 (2009). Radiated testing was performed at an antenna to EUT distance 3 meters.

1.4 Special Accessories

Not available for this EUT intended for grant.

1.5 Equipment Modifications

Not available for this EUT intended for grant.

1.6 Test Facility

Site Description

EMC Lab.

- : Accredited by CNAS, 2013.10.29
The certificate is valid until 2016.10.28
The Laboratory has been assessed and proved to be in compliance with
CNAS/CL01: 2006(identical to ISO/IEC17025: 2005)
The Certificate Registration Number is L2291

- Accredited by TUV Rheinland Shenzhen 2010.5.25
The Laboratory has been assessed according to the requirements ISO/IEC
17025

- Accredited by FCC, April 17, 2013
The Certificate Registration Number is 406365.

- Accredited by Industry Canada, March 05, 2010
The Certificate Registration Number is 4480A-2.

Name of Firm

: SHENZHEN EMTEK CO., LTD.

Site Location

: Bldg 69, Majialong Industry Zone,
Nanshan District, Shenzhen, Guangdong, China

2. System Test Configuration

2.1 EUT Configuration

The EUT configuration for testing is installed on RF field strength measurement to meet the Commissions requirement and operating in a manner which intends to maximize its emission characteristics in a continuous normal application.

2.2 EUT Exercise

The Transmitter was operated in the normal operating mode. The TX frequency was fixed which was for the purpose of the measurements.

2.3 Test Procedure

2.3.1 Conducted Emissions

The EUT is placed on a turn table which is 0.8 m above ground plane. According to the requirements in Section 13.1.4.1 of ANSI C63.4-2009 Conducted emissions from the EUT measured in the frequency range between 0.15 MHz and 30 MHz using CISPR Quasi-Peak and average detector mode.

2.3.2 Radiated Emissions

The EUT is placed on a turn table which is 0.8 m above ground plane. The turn table shall rotate 360 degrees to determine the position of maximum emission level. EUT is set 3m away from the receiving antenna which varied from 1m to 4m to find out the highest emission. And also, each emission was to be maximized by changing the polarization of receiving antenna both horizontal and vertical. In order to find out the max. Emission, the relative positions of this hand-held transmitter (EUT) was rotated through three orthogonal axes according to the requirements in Section 13.1.4.1 of ANSI C63.4-2009.

2.4 Configuration of Tested System

Fig. 2-1 Configuration of Tested System

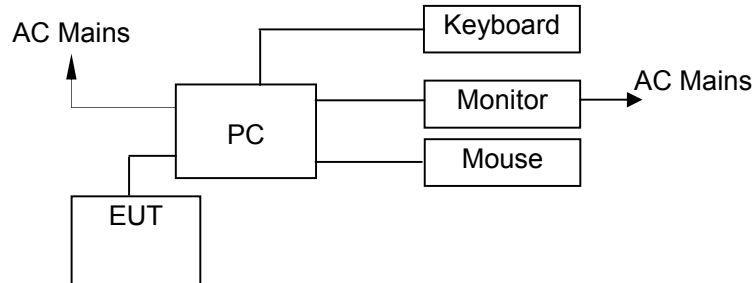

Table 2-1 Equipment Used in Tested System

Item	Equipment	Mfr/Brand	Model/Type No.	FCC ID	Series No.	Note
1.	150Mbps Wireless N Portable AP	TOTOLINK	IP04223	X7D-IP04223	N/A	EUT
2.	PC	Lenovo	ThinkCentre 8701	N/A	N/A	
3.	LCD Monitor	Lenovo	9227-AE6	N/A	N/A	
4.	Keyboard	Lenovo	KU-0225	N/A	N/A	
5.	Mouse	Lenovo	MO28UOL	N/A	N/A	

Note:

- (1) Unless otherwise denoted as EUT in 「Remark」 column, device(s) used in tested system is a support equipment.

3. Description of Test Modes

The Transmitter of EUT is an 150Mbps Wireless N Portable AP and powered by host equipment; these is Digital Transmission system (DTS) and have modulation OFDM, DSSS, DBPSK, DQPSK, CCK, 16QAM, 64QAM. According exploratory test, EUT will have maximum output power in those data rate (802.11b: 1 Mbps; 802.11g: 6 Mbps; 802.11n: MCS0), so those data rate were used for all test.

The equipment enables high-speed access without wires to network assets. This adapter uses the IEEE 802.11 protocol to enable wireless communications between the host and Wireless router.

For 802.11b/g/n(HT20):

1. For lowest channel : 2412MHz (Channel 1)
2. For middle channel : 2437MHz (Channel 6)
3. For highest channel : 2462MHz (Channel 11)

For 802.11b/g/n(HT40)

4. For lowest channel : 2422MHz (Channel 3)
5. For middle channel : 2437MHz (Channel 6)
6. For highest channel : 2452MHz (Channel 9)

4. Summary of Test Results

FCC Rules	Description Of Test	Result
§15.247(a)(2)	6dB bandwidth	Pass
§15.247(b)(3)	Max Peak output Power test	Pass
§15.247(e)	Power density	Pass
§15.247(d)	Band edge test	Pass
§15.207	AC Power Conducted Emission	Pass
§15.247(d), §15.209	Radiated Emission	Pass
§15.247(d)	Antenna Port Emission	Pass
§15.247(b)&§15.203	Antenna Application	Pass

5. Conducted Emissions Test

5.1 Measurement Procedure

1. The EUT was placed on a table which is 0.8m above ground plane.
2. Maximum procedure was performed on the six highest emissions to ensure EUT compliance.
3. Repeat above procedures until all frequency measured were complete.

5.2 Test SET-UP (Block Diagram of Configuration)

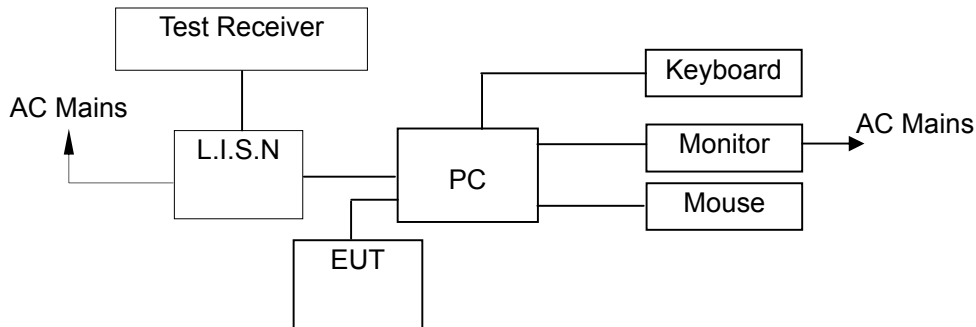

5.3 Measurement Equipment Used

Conducted Emission Test Site					
EQUIPMENT TYPE	MFR	MODEL NUMBER	SERIAL NUMBER	LAST CAL.	CAL DUE.
Test Receiver	Rohde & Schwarz	ESCS30	828985/018	05/17/2014	05/16/2015
L.I.S.N.	Schwarzbeck	NNLK8129	8129203	05/17/2014	05/16/2015
50Ω Coaxial Switch	Anritsu	MP59B	M20531	N/A	N/A
Pulse Limiter	Rohde & Schwarz	ESH3-Z2	100006	05/17/2014	05/16/2015
Voltage Probe	Rohde & Schwarz	TK9416	N/A	05/17/2014	05/16/2015
I.S.N	Rohde & Schwarz	ENY22	1109.9508.02	05/17/2014	05/16/2015

5.4 Conducted Emission Limit

Conducted Emission

Frequency(MHz)	Quasi-peak	Average
0.15-0.5	66-56	56-46
0.5-5.0	56	46
5.0-30.0	60	50

Note: 1. The lower limit shall apply at the transition frequencies

2. The limit decreases in line with the logarithm of the frequency in the range of 0.15 to 0.50MHz.

5.5 Measurement Result

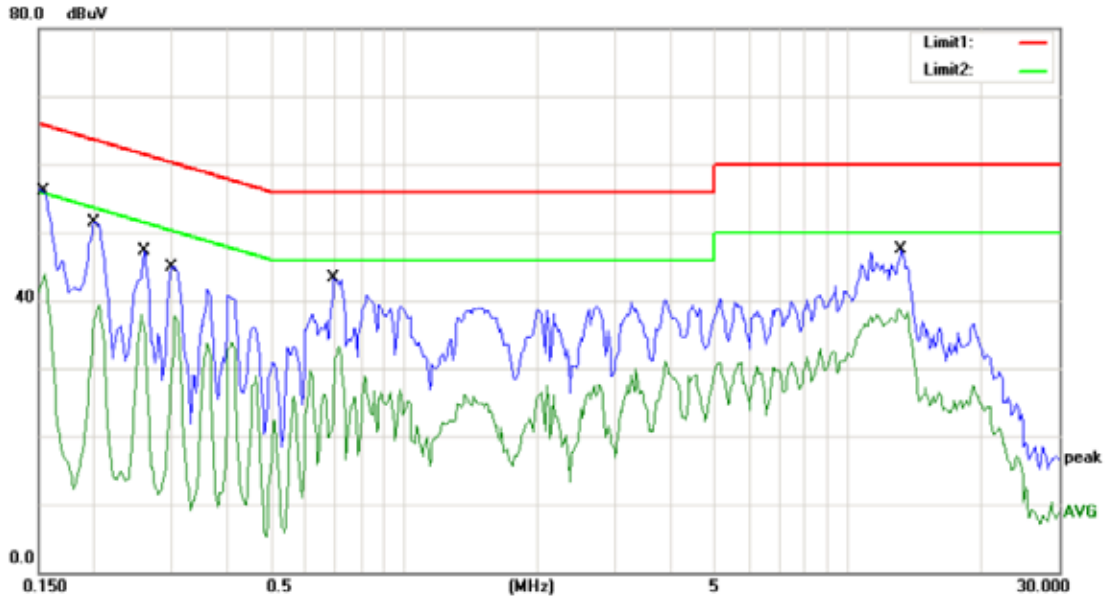

Site Conduction #1
 Limit: (CE)FCC PART 15 class B_QP
 EUT: 150Mbps Wireless N Portable AP
 M/N: IP04223
 Mode: ON
 Note:

Phase: **L1** Temperature: 24
 Power: AC 120V/60Hz Humidity: 53 %

No.	Mk.	Freq. MHz	Reading Level dBuV	Correct Factor dB	Measure- ment dBuV	Limit dBuV	Over dB	Detector	Comment
1	*	0.1556	55.28	0.00	55.28	65.70	-10.42	QP	
2		0.1556	43.84	0.00	43.84	55.70	-11.86	AVG	
3		0.2000	51.59	0.00	51.59	63.61	-12.02	QP	
4		0.2000	39.23	0.00	39.23	53.61	-14.38	AVG	
5		0.2600	47.37	0.00	47.37	61.43	-14.06	QP	
6		0.2600	37.84	0.00	37.84	51.43	-13.59	AVG	
7		0.3000	44.94	0.00	44.94	60.24	-15.30	QP	
8		0.3000	37.80	0.00	37.80	50.24	-12.44	AVG	
9		0.6950	43.26	0.00	43.26	56.00	-12.74	QP	
10		0.6950	33.33	0.00	33.33	46.00	-12.67	AVG	
11		13.2250	47.58	0.00	47.58	60.00	-12.42	QP	
12		13.2250	38.77	0.00	38.77	50.00	-11.23	AVG	

*:Maximum data x:Over limit l:over margin Comment: Factor build in receiver. Operator: csl

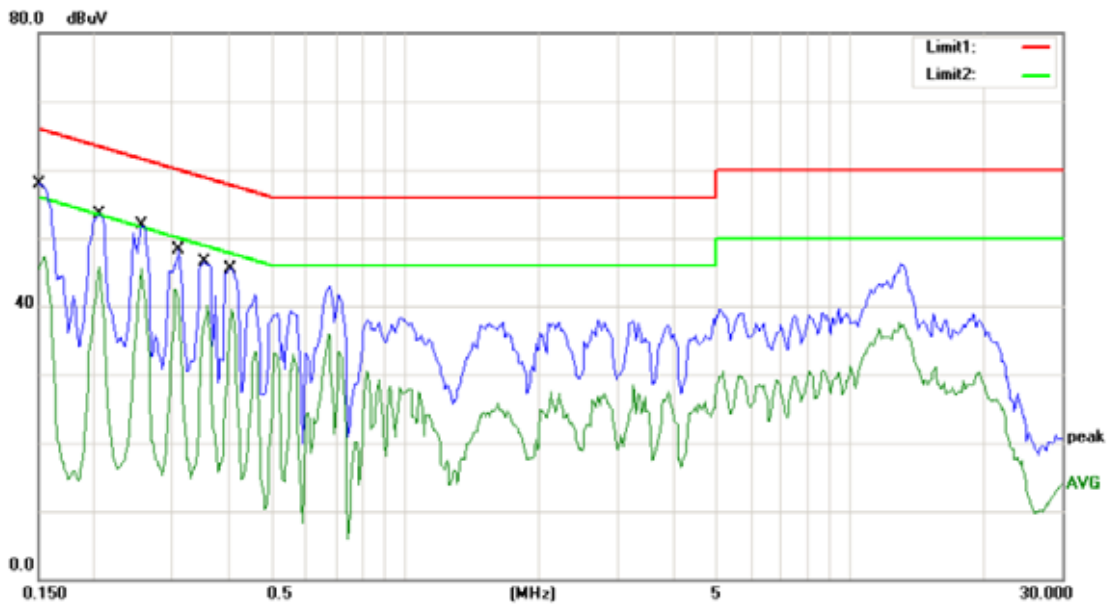

Site Conduction #1
 Limit: (CE)FCC PART 15 class B_QP
 EUT: 150Mbps Wireless N Portable AP
 M/N: IP04223
 Mode: ON
 Note:

Phase: **N** Temperature: 24
 Power: AC 120V/60Hz Humidity: 53 %

No.	Mk.	Freq. MHz	Reading Level dBuV	Correct Factor dB	Measure- ment dBuV	Limit dBuV	Over dB	Detector	Comment
1		0.1524	57.80	0.00	57.80	65.87	-8.07	QP	
2		0.1524	47.34	0.00	47.34	55.87	-8.53	AVG	
3		0.2050	53.50	0.00	53.50	63.41	-9.91	QP	
4		0.2050	45.65	0.00	45.65	53.41	-7.76	AVG	
5		0.2550	51.93	0.00	51.93	61.59	-9.66	QP	
6	*	0.2550	45.52	0.00	45.52	51.59	-6.07	AVG	
7		0.3100	48.32	0.00	48.32	59.97	-11.65	QP	
8		0.3100	42.59	0.00	42.59	49.97	-7.38	AVG	
9		0.3550	46.43	0.00	46.43	58.84	-12.41	QP	
10		0.3550	40.11	0.00	40.11	48.84	-8.73	AVG	
11		0.4050	45.56	0.00	45.56	57.75	-12.19	QP	
12		0.4050	39.55	0.00	39.55	47.75	-8.20	AVG	

*:Maximum data x:Over limit !:over margin Comment: Factor build in receiver. Operator: csl

6. Radiated Emission Test

6.1 Measurement Procedure

1. The EUT was placed on a turn table which is 0.8m above ground plane.
2. Maximum procedure was performed on the six highest emissions to ensure EUT compliance.
3. And also, each emission was to be maximized by changing the polarization of receiving antenna both horizontal and vertical.
4. Repeat above procedures until all frequency measured was complete.

When spectrum scanned from 30 MHz to 1GHz setting resolution bandwidth 120 kHz and video bandwidth 300kHz.

EMI Test Receiver	Setting
Attenuation	Auto
RB	120kHz
VB	300kHz
Detector	QP
Trace	Max hold

When spectrum scanned above 1GHz setting resolution bandwidth 1MHz, video bandwidth 3MHz.

EMI Test Receiver	Setting
Attenuation	Auto
RB	1MHz
VB	3MHz
Detector	Peak
Trace	Max hold

When spectrum scanned above 1GHz setting resolution bandwidth 1MHz, video bandwidth 10Hz.

EMI Test Receiver	Setting
Attenuation	Auto
RB	1MHz
VB	10Hz
Detector	Peak
Trace	Max hold

6.2 Test SET-UP (Block Diagram of Configuration)

(A) Radiated Emission Test Set-Up, Frequency Below 30MHz

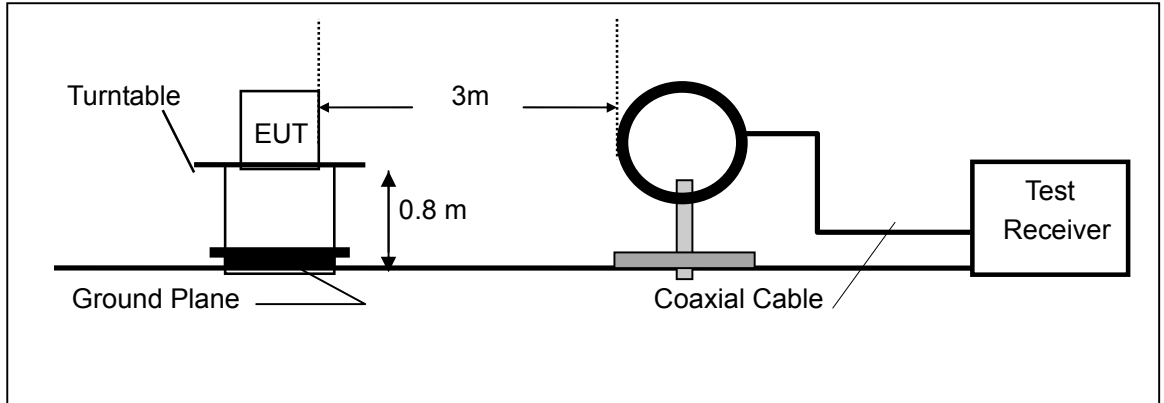

(B) Radiated Emission Test Set-Up, Frequency Below 1000MHz

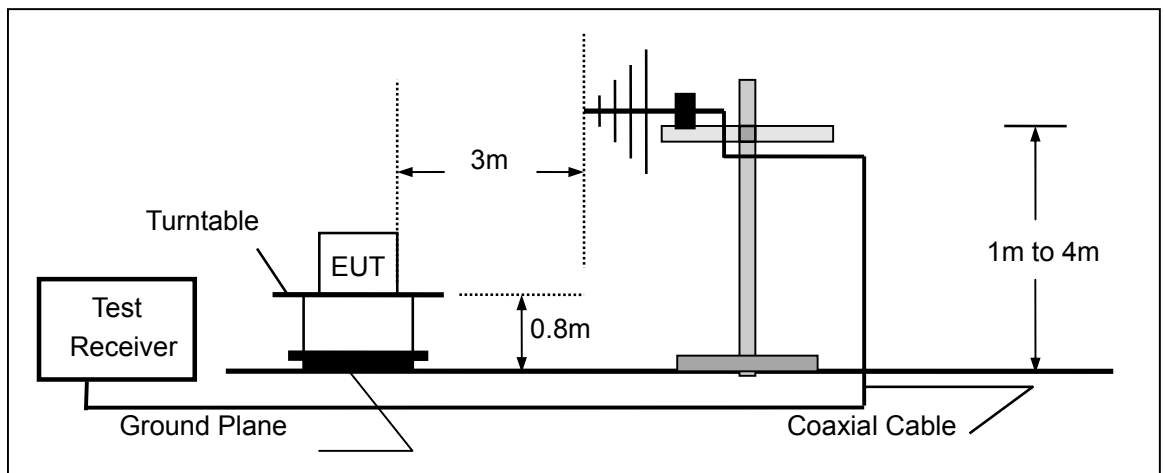

(C) Radiated Emission Test Set-Up, Frequency above 1000MHz

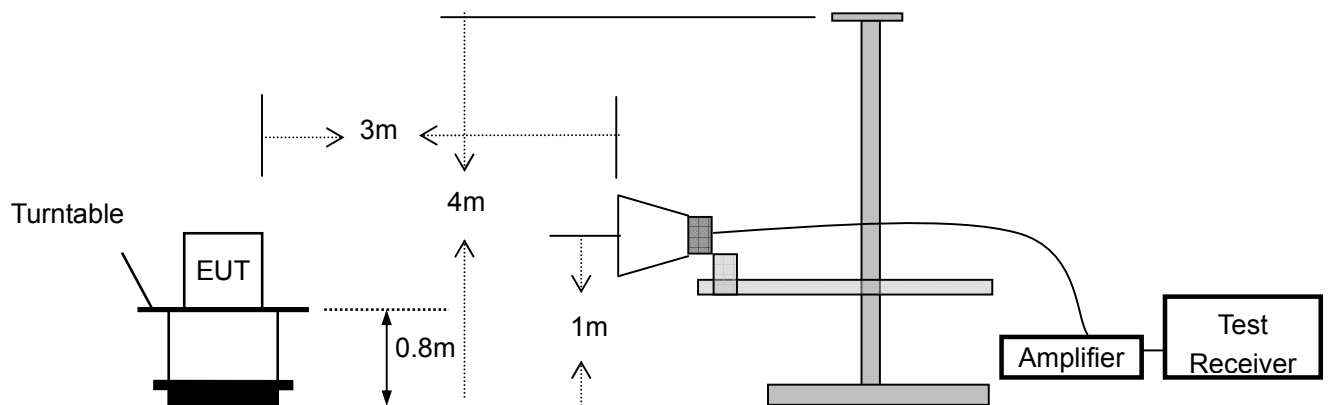

6.3 Measurement Equipment Used

EQUIPMENT TYPE	MFR	MODEL NUMBER	SERIAL NUMBER	LAST CAL.	CAL DUE.
EMI Test Receiver	Rohde & Schwarz	ESU	1302.6005.26	05/17/2014	05/16/2015
Pre-Amplifier	HP	8447D	2944A07999	05/17/2014	05/16/2015
Bilog Antenna	Schwarzbeck	VULB9163	142	05/17/2014	05/16/2015
Loop Antenna	ARA	PLA-1030/B	1029	05/17/2014	05/16/2015
Horn Antenna	Schwarzbeck	BBHA 9170	BBHA9170399	05/17/2014	05/16/2015
Horn Antenna	Schwarzbeck	BBHA 9120	D143	05/17/2014	05/16/2015
Cable	Schwarzbeck	AK9513	ACRX1	05/17/2014	05/16/2015
Cable	Rosenberger	N/A	FP2RX2	05/17/2014	05/16/2015
Cable	Schwarzbeck	AK9513	CRPX1	05/17/2014	05/16/2015
Cable	Schwarzbeck	AK9513	CRRX2	05/17/2014	05/16/2015

6.4 Radiated Emission Limit

The emissions from an intentional radiator shall not exceed the field strength levels specified in the following table 15.209(a):

Frequencies (MHz)	Field Strength (micorvolts/meter)	Measurement Distance (meters)
0.009~0.490	2400/F(KHz)	300
0.490~1.705	24000/F(KHz)	30
1.705~30.0	30	30
30~88	100	3
88~216	150	3
216~960	200	3
Above 960	500	3

15.205 Restricted bands of operation

MHz	MHz	MHz	GHz
0.090 - 0.110	16.42 - 16.423	399.9 - 410	4.5 - 5.15
¹ 0.495 - 0.505	16.69475 - 16.69525	608 - 614	5.35 - 5.46
2.1735 - 2.1905	16.80425 - 16.80475	960 - 1240	7.25 - 7.75
4.125 - 4.128	25.5 - 25.67	1300 - 1427	8.025 - 8.5
4.17725 - 4.17775	37.5 - 38.25	1435 - 1626.5	9.0 - 9.2
4.20725 - 4.20775	73 - 74.6	1645.5 - 1646.5	9.3 - 9.5
6.215 - 6.218	74.8 - 75.2	1660 - 1710	10.6 - 12.7
6.26775 - 6.26825	108 - 121.94	1718.8 - 1722.2	13.25 - 13.4
6.31175 - 6.31225	123 - 138	2200 - 2300	14.47 - 14.5
8.291 - 8.294	149.9 - 150.05	2310 - 2390	15.35 - 16.2
8.362 - 8.366	156.52475 - 156.52525	2483.5 - 2500	17.7 - 21.4
8.37625 - 8.38675	156.7 - 156.9	2690 - 2900	22.01 - 23.12
8.41425 - 8.41475	162.0125 - 167.17	3260 - 3267	23.6 - 24.0
12.29 - 12.293	167.72 - 173.2	3332 - 3339	31.2 - 31.8
12.51975 - 12.52025	240 - 285	3345.8 - 3358	36.43 - 36.5
12.57675 - 12.57725	322 - 335.4	3600 - 4400	(²)

- Remark:
1. Emission level in dBuV/m=20 log (uV/m)
 2. Measurement was performed at an antenna to the closed point of EUT distance of meters.
 3. Only spurious frequency is permitted to locate within the Restricted Bands specified in provision of § 15.205, and the emissions located in restricted bands also comply with 15.209 limit.

6.5 Measurement Result

All modes 2.4G 802.11b/g/n have been tested, and the worst result 802.11b recorded as below:

Operation Mode: TX Mode Test Date : October 30, 2014
Frequency Range: 9KHz~30MHz Temperature : 24
Test Result: PASS Humidity : 63 %
Measured Distance: 3m Test By: RU
Note:

Freq. (MHz)	Ant.Pol. H/V	Emission Level (dBuV/m)	Limit 3m (dBuV/m)	Over (dB)
--	--	--	--	--

Note: the amplitude of spurious emission that is attenuated by more than 20dB below the permissible limit has no need to be reported.

Distance extrapolation factor = $40 \log(\text{Specific distance} / \text{test distance})$ (dB);

Limit line = Specific limits (dBuV) + distance extrapolation factor.

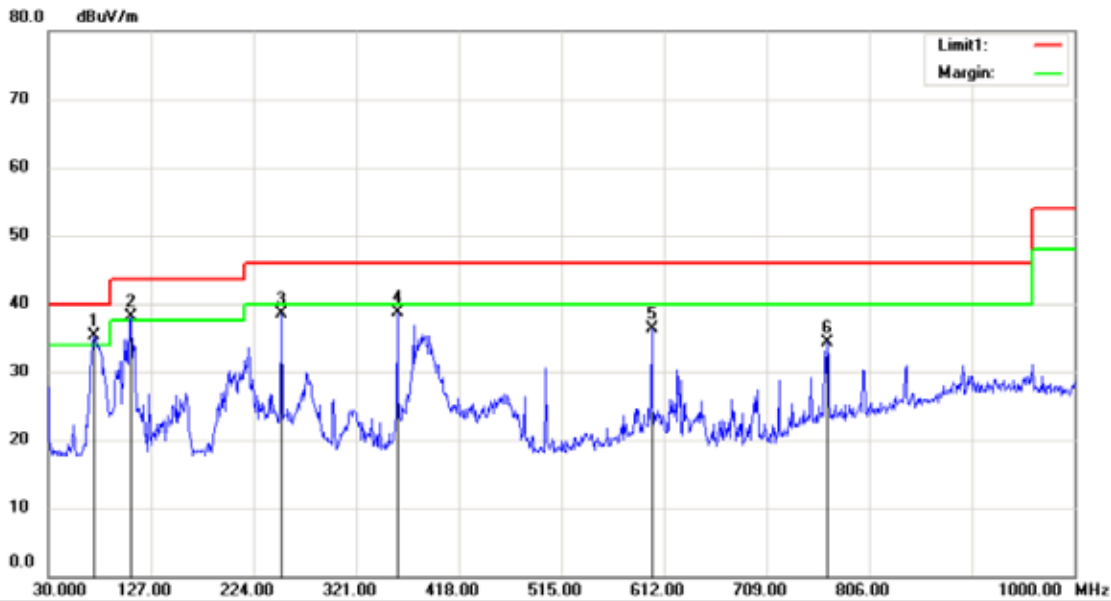

Site 3m Chamber #2 Polarization: **Horizontal** Temperature: 24 C
 Limit: (RE)FCC PART 15 CLASS B Power: AC 120V/60Hz Humidity: 53 %
 EUT: 150Mbps Wireless N portable AP
 M/N: IP04223
 Mode:2412
 Note:

No.	Mk.	Freq. MHz	Reading Level dBuV	Correct Factor dB	Measure- ment dBuV/m	Limit dBuV/m	Over dB	Antenna Height cm	Table Degree degree	Comment
1	*	73.6500	54.96	-19.75	35.21	40.00	-4.79	QP		
2	!	108.5700	52.58	-14.53	38.05	43.50	-5.45	QP		
3		250.1900	51.72	-13.25	38.47	46.00	-7.53	QP		
4		359.8000	48.90	-10.20	38.70	46.00	-7.30	QP		
5		600.3600	42.08	-5.71	36.37	46.00	-9.63	QP		
6		766.2300	36.59	-2.26	34.33	46.00	-11.67	QP		

*:Maximum data x:Over limit !:over margin

Operator: Wang

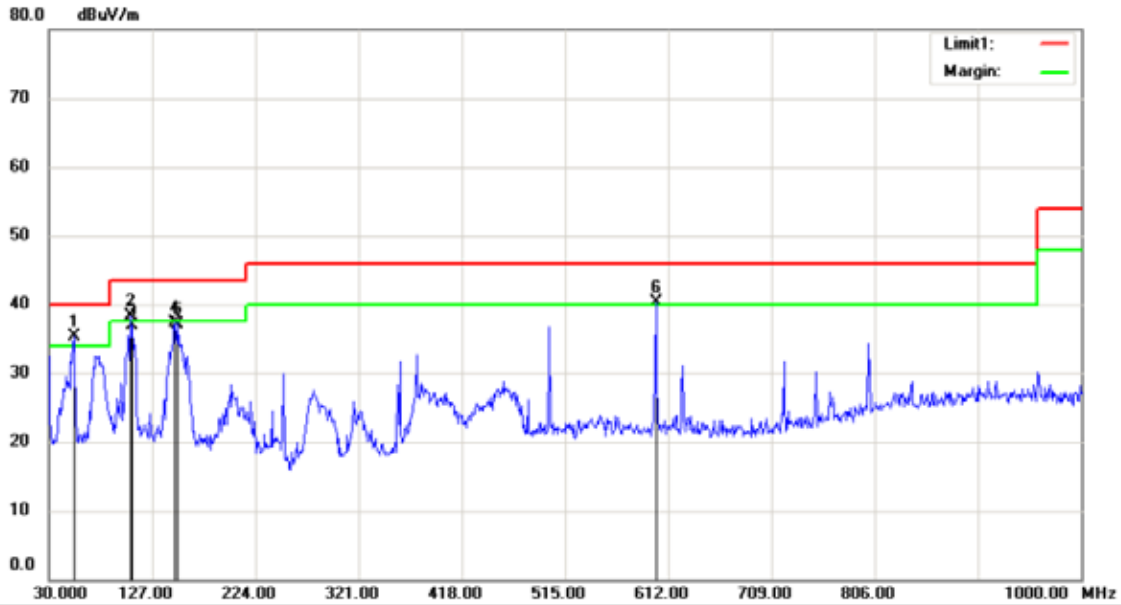

Site 3m Chamber #2 Polarization: **Vertical** Temperature: 24 C
 Limit: (RE)FCC PART 15 CLASS B Power: AC 120V/60Hz Humidity: 53 %
 EUT: 150Mbps Wireless N portable AP
 M/N: IP04223
 Mode:2412
 Note:

No.	Mk.	Freq.	Reading Level	Correct Factor	Measurement	Limit	Over	Antenna Height	Table Degree	
		MHz	dBuV	dB	dBuV/m	dBuV/m	dB	cm	degree	Comment
1	*	53.2800	53.16	-17.95	35.21	40.00	-4.79	QP		
2	l	106.6300	52.82	-14.48	38.34	43.50	-5.16	QP		
3		108.5700	51.35	-14.53	36.82	43.50	-6.68	QP		
4		148.3400	55.74	-18.37	37.37	43.50	-6.13	QP		
5		151.2500	55.66	-18.46	37.20	43.50	-6.30	QP		
6	l	600.3600	46.04	-5.71	40.33	46.00	-5.67	QP		

*:Maximum data x:Over limit l:over margin

Operator: Wang

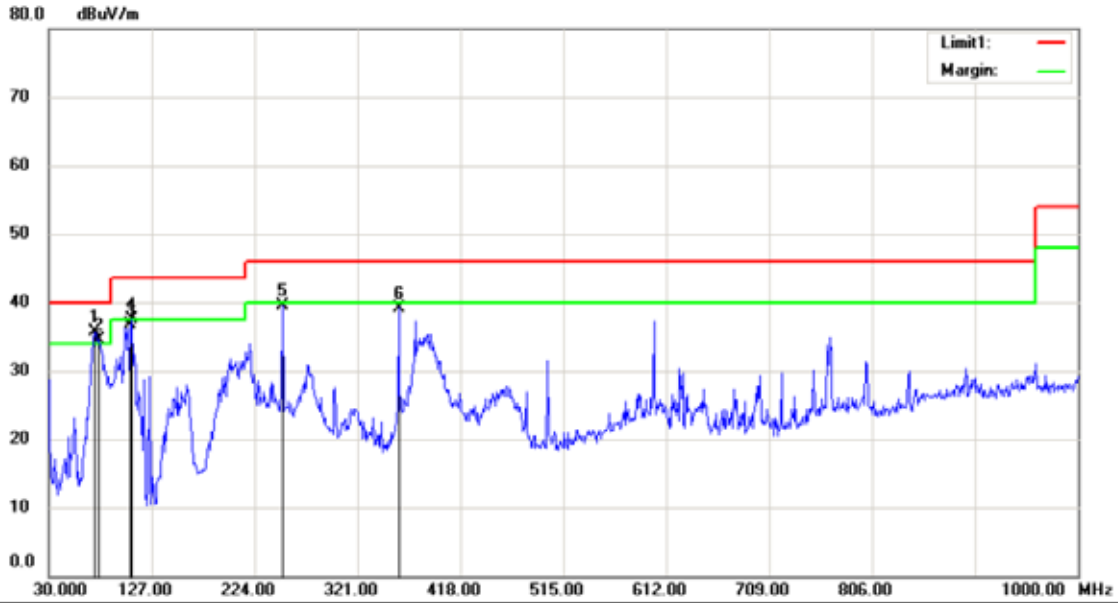

Site 3m Chamber #2 Polarization: *Horizontal* Temperature: 24 C
 Limit: (RE)FCC PART 15 CLASS B Power: AC 120V/60Hz Humidity: 53 %
 EUT: 150Mbps Wireless N portable AP
 M/N: IP04223
 Mode:2437
 Note:

No.	Mk.	Freq.	Reading Level	Correct Factor	Measurement	Limit	Over	Antenna Height	Table Degree	
		MHz	dBuV	dB	dBuV/m	dBuV/m	dB	cm	degree	Comment
1	*	73.6500	55.46	-19.75	35.71	40.00	-4.29	QP		
2	!	77.5300	54.39	-19.97	34.42	40.00	-5.58	QP		
3		106.6300	51.27	-14.48	36.79	43.50	-6.71	QP		
4	!	108.5700	52.08	-14.53	37.55	43.50	-5.95	QP		
5		250.1900	52.72	-13.25	39.47	46.00	-6.53	QP		
6		359.8000	49.40	-10.20	39.20	46.00	-6.80	QP		

*:Maximum data x:Over limit !:over margin

Operator: Wang

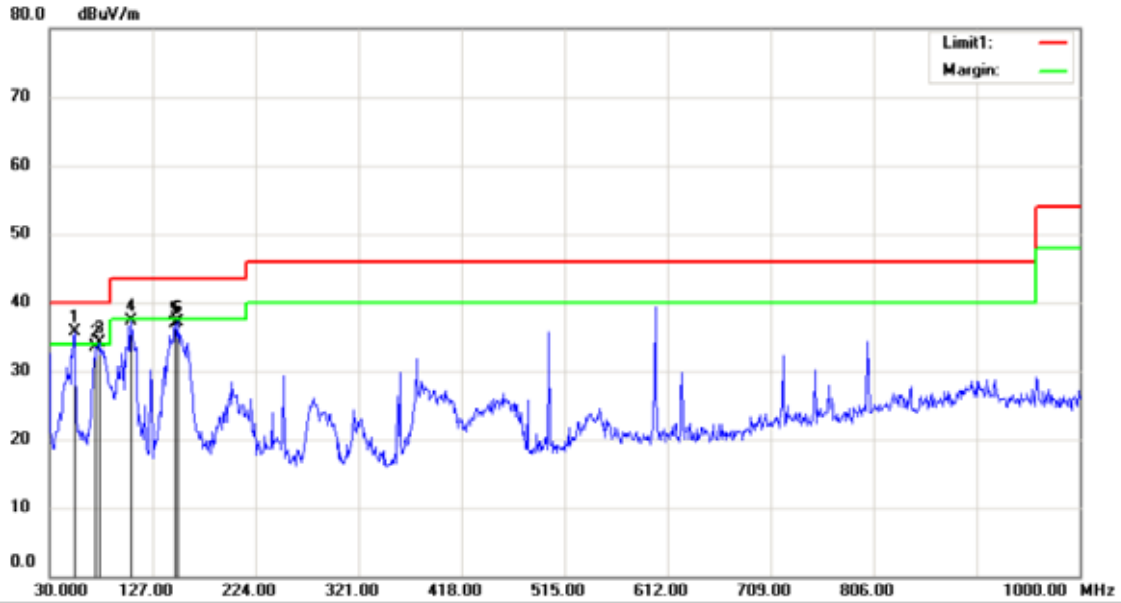

Site 3m Chamber #2 Polarization: **Vertical** Temperature: 24 C
 Limit: (RE)FCC PART 15 CLASS B Power: AC 120V/60Hz Humidity: 53 %
 EUT: 150Mbps Wireless N portable AP
 M/N: IP04223
 Mode:2437
 Note:

No.	Mk.	Freq.	Reading Level	Correct Factor	Measurement	Limit	Over	Antenna Height	Table Degree	
		MHz	dBuV	dB	dBuV/m	dBuV/m	dB	cm	degree	Comment
1	*	53.2800	53.66	-17.95	35.71	40.00	-4.29			QP
2		73.6500	53.16	-19.75	33.41	40.00	-6.59			QP
3	!	76.5600	54.01	-19.99	34.02	40.00	-5.98			QP
4		106.6300	51.82	-14.48	37.34	43.50	-6.16			QP
5		148.3400	55.24	-18.37	36.87	43.50	-6.63			QP
6		151.2500	55.66	-18.46	37.20	43.50	-6.30			QP

*:Maximum data x:Over limit !:over margin

Operator: Wang

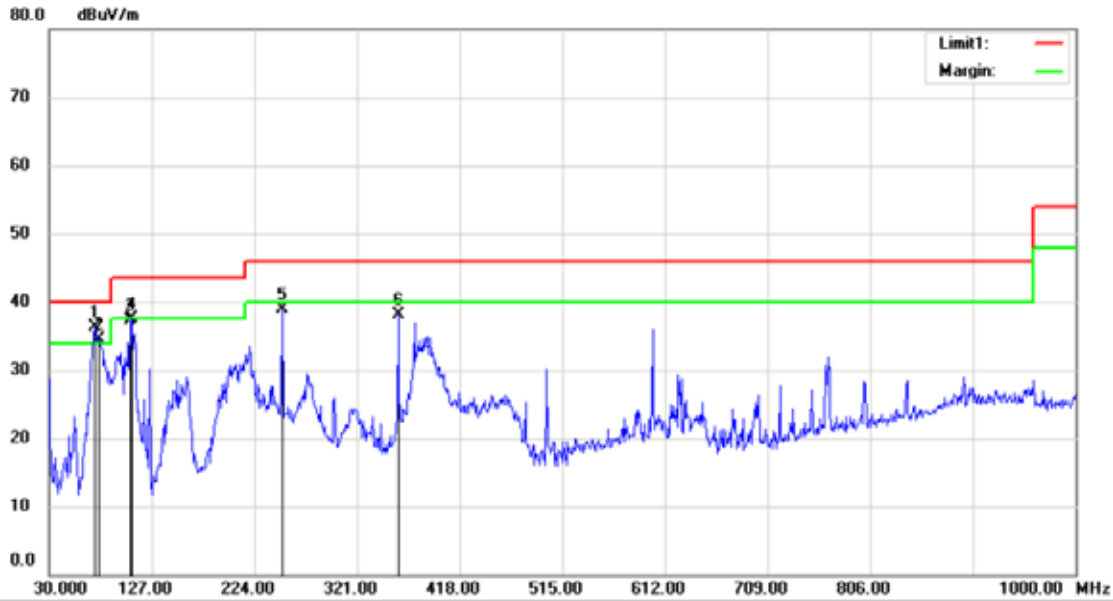

Site: 3m Chamber #2 Polarization: *Horizontal* Temperature: 24 C
 Limit: (RE)FCC PART 15 CLASS B Power: AC 120V/60Hz Humidity: 53 %
 EUT: 150Mbps Wireless N portable AP
 M/N: IP04223
 Mode:2462
 Note:

No.	Mk.	Freq. MHz	Reading Level dBuV	Correct Factor dB	Measure- ment dBuV/m	Limit dBuV/m	Over dB	Antenna Height cm	Table Degree degree	Comment
1	*	73.6500	55.96	-19.75	36.21	40.00	-3.79	QP		
2	!	77.5300	54.39	-19.97	34.42	40.00	-5.58	QP		
3		106.6300	51.77	-14.48	37.29	43.50	-6.21	QP		
4	!	108.5700	52.08	-14.53	37.55	43.50	-5.95	QP		
5		250.1900	52.22	-13.25	38.97	46.00	-7.03	QP		
6		359.8000	48.40	-10.20	38.20	46.00	-7.80	QP		

*:Maximum data x:Over limit !:over margin

Operator: Wang

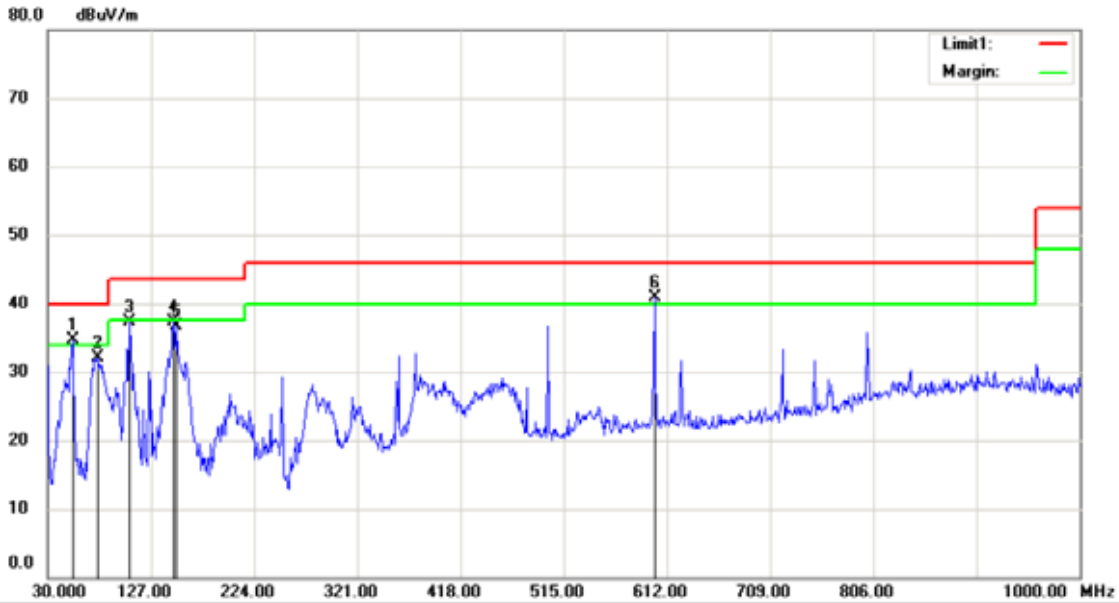

Site 3m Chamber #2 Polarization: **Vertical** Temperature: 24 C
 Limit: (RE)FCC PART 15 CLASS B Power: AC 120V/60Hz Humidity: 53 %
 EUT: 150Mbps Wireless N portable AP
 M/N: IP04223
 Mode:2462
 Note:

No.	Mk.	Freq.	Reading Level	Correct Factor	Measurement	Limit	Over	Antenna Height	Table Degree	
		MHz	dBuV	dB	dBuV/m	dBuV/m	dB	cm	degree	Comment
1	I	53.2800	52.66	-17.95	34.71	40.00	-5.29	QP		
2		76.5600	52.01	-19.99	32.02	40.00	-7.98	QP		
3		106.6300	51.82	-14.48	37.34	43.50	-6.16	QP		
4		148.3400	55.74	-18.37	37.37	43.50	-6.13	QP		
5		151.2500	55.16	-18.46	36.70	43.50	-6.80	QP		
6	*	600.3600	46.54	-5.71	40.83	46.00	-5.17	QP		

*:Maximum data x:Over limit I:over margin

Operator: Wang

Operation Mode: 802.11b TX Channel 1 Test Date : October 30, 2014
 Frequency Range: Above 1GHz Temperature : 24
 Test Result: PASS Humidity : 63 %
 Measured Distance: 3m Test By: RU

Freq. (MHz)	Ant.Pol. H/V	Emission Level(dBuV/m)		Limit 3m(dBuV/m)		Over(dB)	
		PK	AV	PK	AV	PK	AV
4811.93	V	48.92	33.91	74.00	54.00	-25.08	-20.09
7235.66	V	54.68	35.71	74.00	54.00	-19.32	-18.29
9602.02	V	53.00	33.97	74.00	54.00	-21.00	-20.03
4814.41	H	49.66	31.33	74.00	54.00	-24.34	-22.67
7237.94	H	52.06	33.57	74.00	54.00	-21.94	-20.43
9609.55	H	53.35	34.44	74.00	54.00	-20.65	-19.56

All emissions not reported were more than 20dB below the specified limit or in the noise floor.

- Note:** (1) All Readings are Peak Value and AV.
 (2) Emission Level= Reading Level+Probe Factor +Cable Loss.
 (3) Data of measurement within this frequency range shown "--" in the table above means the reading of emissions are attenuated more than 20dB below the permissible limits or the field strength is too small to be measured.

Operation Mode: 802.11b TX Channel 6 Test Date : October 30, 2014
 Frequency Range: Above 1GHz Temperature : 24
 Test Result: PASS Humidity : 63 %
 Measured Distance: 3m Test By: RU

Freq. (MHz)	Ant.Pol. H/V	Emission Level(dBuV/m)		Limit 3m(dBuV/m)		Over(dB)	
		PK	AV	PK	AV	PK	AV
4861.32	V	49.78	32.19	74.00	54.00	-24.22	-21.81
7310.81	V	53.58	35.54	74.00	54.00	-20.42	-18.46
9699.06	V	51.47	33.10	74.00	54.00	-22.53	-20.90
4860.06	H	50.26	32.33	74.00	54.00	-23.74	-21.67
7317.59	H	52.39	33.72	74.00	54.00	-21.61	-20.28
9707.24	H	51.02	33.47	74.00	54.00	-22.98	-20.53

All emissions not reported were more than 20dB below the specified limit or in the noise floor.

- Note:** (1) All Readings are Peak Value and AV.
 (2) Emission Level= Reading Level+Probe Factor +Cable Loss.
 (3) Data of measurement within this frequency range shown "--" in the table above means the reading of emissions are attenuated more than 20dB below the permissible limits or the field strength is too small to be measured.

Operation Mode: 802.11b TX Channel 11 Test Date : October 30, 2014
 Frequency Range: Above 1GHz Temperature : 24
 Test Result: PASS Humidity : 63 %
 Measured Distance: 3m Test By: RU

Freq. (MHz)	Ant.Pol. H/V	Emission Level(dBuV/m)		Limit 3m(dBuV/m)		Over(dB)	
		PK	AV	PK	AV	PK	AV
4912.83	V	48.83	31.03	74.00	54.00	-25.17	-22.97
7379.55	V	52.27	34.18	74.00	54.00	-21.73	-19.82
9802.13	V	53.09	34.75	74.00	54.00	-20.91	-19.25
4913.30	H	51.60	33.22	74.00	54.00	-22.40	-20.78
7386.31	H	53.08	36.14	74.00	54.00	-20.92	-17.86
9812.38	H	50.63	34.25	74.00	54.00	-23.37	-19.75

No others harmonics emissions are higher than 20dB below the limits of 47 CFR Part 15.247.

- Note:**
- (1) All Readings are Peak Value and AV.
 - (2) Emission Level= Reading Level+Probe Factor +Cable Loss.
 - (3) Data of measurement within this frequency range shown "--" in the table above means the reading of emissions are attenuated more than 20dB below the permissible limits or the field strength is too small to be measured.

7. 6dB Bandwidth Test

7.1 Measurement Procedure

The EUT was operating in IEEE 802.11b/g/n mode or could be controlled its channel. Printed out the test result from the spectrum by hard copy function.

1. The testing follows FCC KDB Publication No. 558074 DTS 001 Meas. Guidance v03r02
2. The RF output of EUT was connected to the spectrum analyzer by RF cable and attenuator. The path loss was compensated to the results for each measurement.
3. Set to the maximum power setting and enable the EUT transmit continuously
4. Make the measurement with the spectrum analyzer 's resolution bandwidth (RBW) = 100 kHz. Set the Video bandwidth (VBW) = 300 kHz. In order to make an accurate measurement The 6dB bandwidth must be greater than 500 kHz
5. Measure and record the results in the test report.

7.2 Test SET-UP (Block Diagram of Configuration)

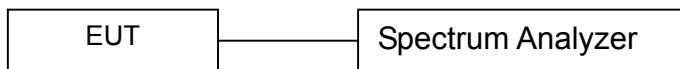

7.3 Measurement Equipment Used

EQUIPMENT TYPE	MFR	MODEL NUMBER	SERIAL NUMBER	LAST CAL.	CAL DUE.
Spectrum Analyzer	Agilent	E4407B	88156318	05/17/2014	05/16/2015

7.4 Measurement Results

6db Bandwidth Test Data Chart:
Refer to attached data chart.

Spectrum Detector:	PK	Test Date:	September 25, 2014
Test By:	KK	Temperature:	24
Test Result:	PASS	Humidity:	53 %
Operation Mode:	802.11b	Antenna:	A

Channel number	Channel frequency (MHz)	Measurement level (MHz)	6db Bandwidth Limit(MHz)
1	2412	12.104	>0.5
6	2437	12.176	>0.5
11	2462	12.184	>0.5

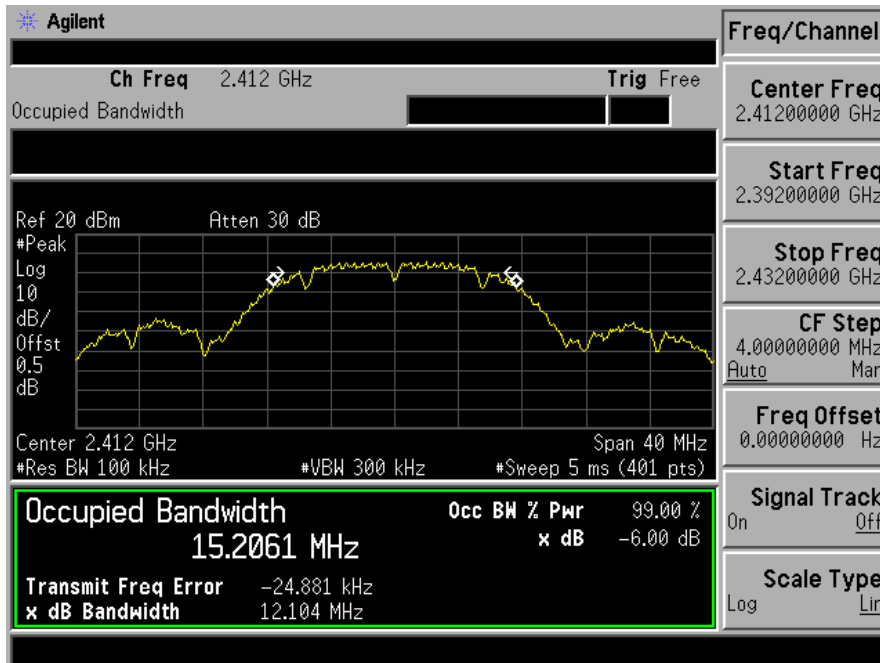

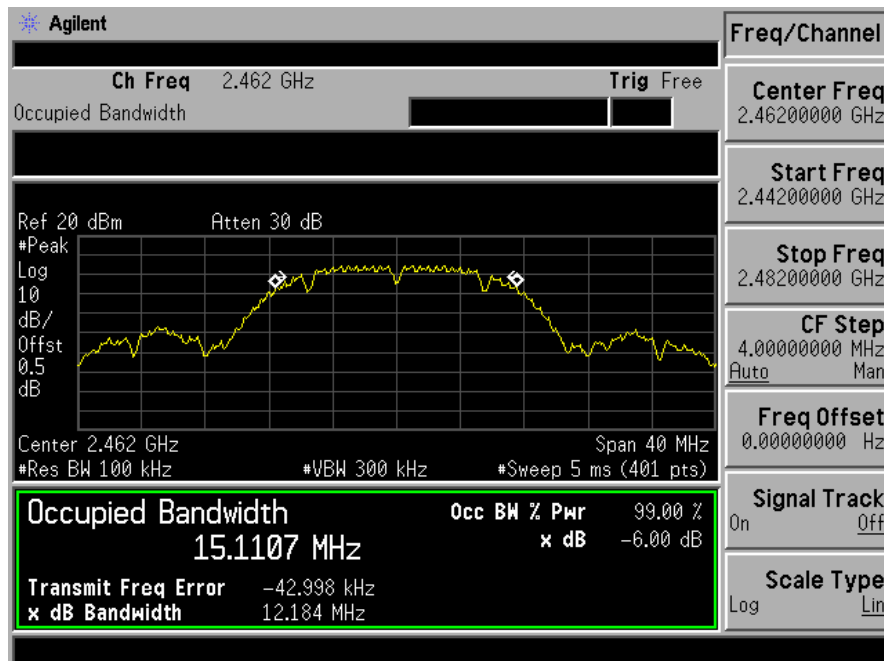
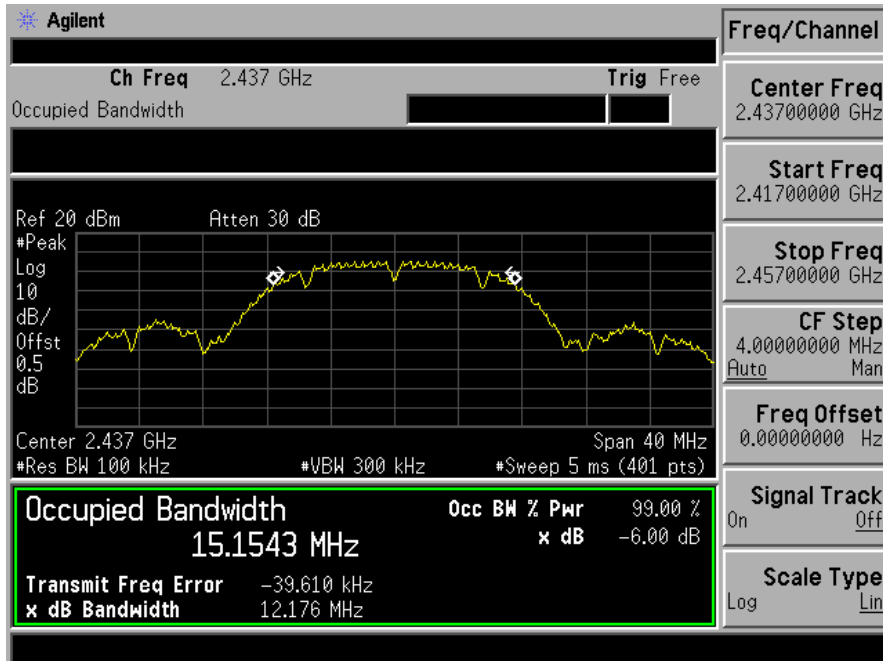

Spectrum Detector:	PK	Test Date:	September 25, 2014
Test By:	KK	Temperature:	24
Test Result:	PASS	Humidity:	53 %
Operation Mode:	802.11g	Antenna:	A

Channel number	Channel frequency (MHz)	Measurement level (MHz)	6db Bandwidth Limit(MHz)
1	2412	15.570	>0.5
6	2437	16.448	>0.5
11	2462	16.449	>0.5

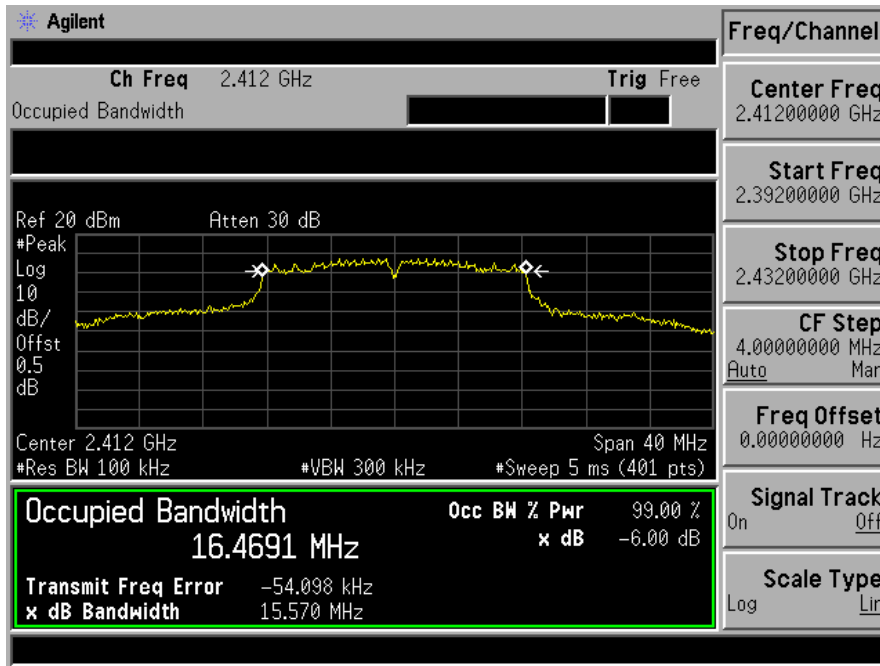

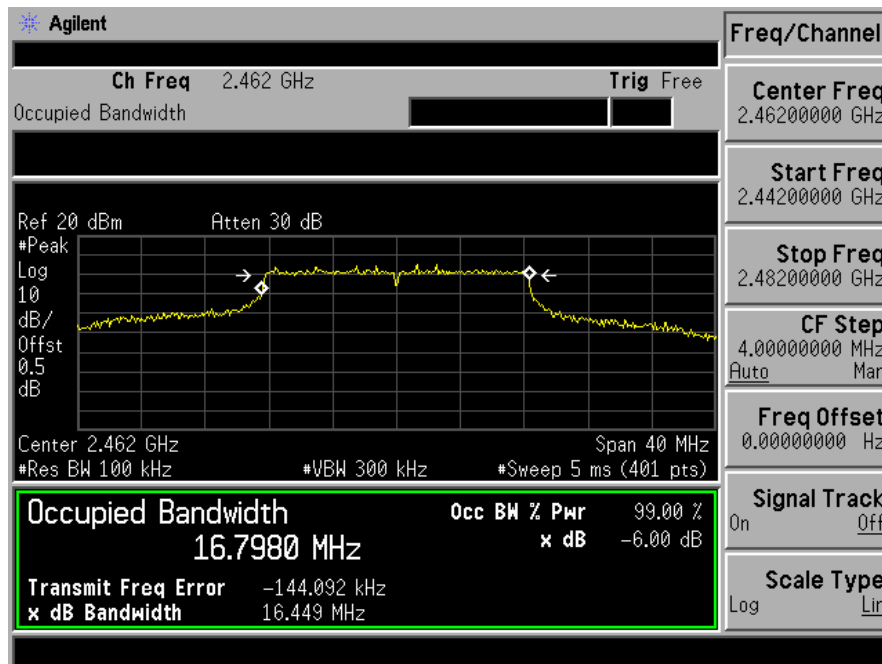
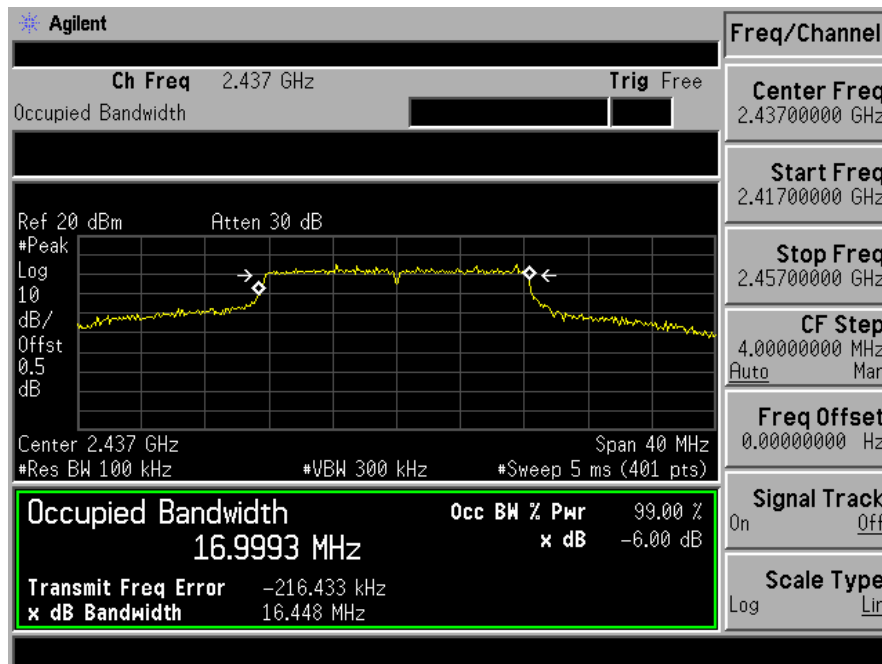

Spectrum Detector:	PK	Test Date:	September 25, 2014
Test By:	KK	Temperature:	24
Test Result:	PASS	Humidity:	53 %
Operation Mode:	802.11n (HT20)	Antenna:	A

Channel number	Channel frequency (MHz)	Measurement level (MHz)	6db Bandwidth Limit(MHz)
1	2412	17.169	>0.5
6	2437	17.124	>0.5
11	2462	17.277	>0.5

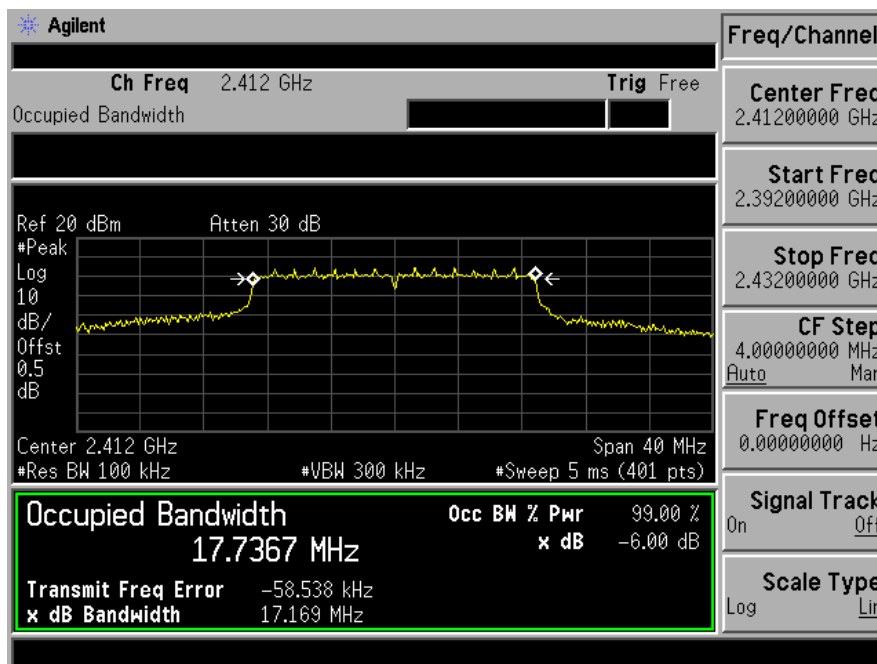

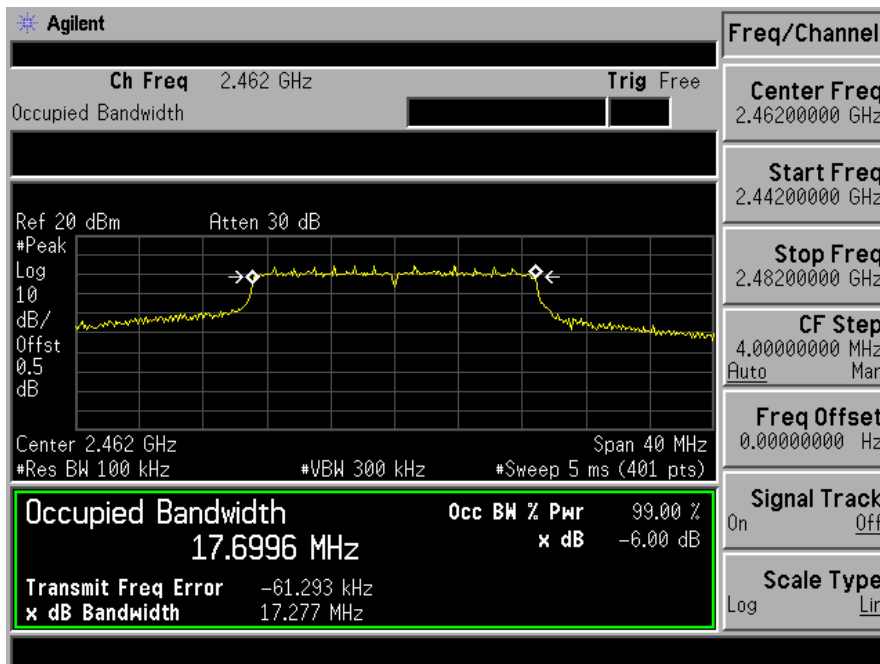
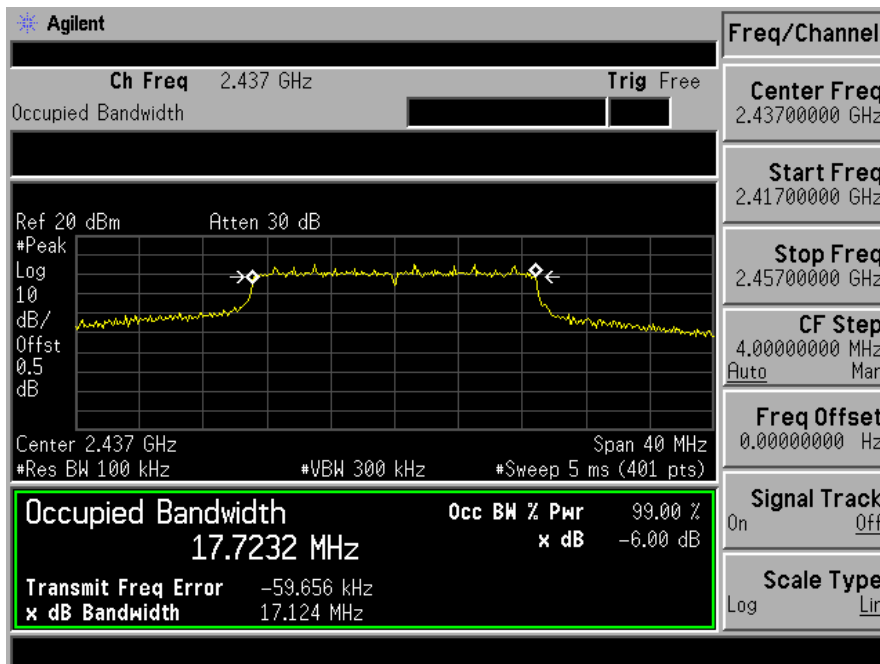

Spectrum Detector:	PK	Test Date:	September 25, 2014
Test By:	KK	Temperature:	24
Test Result:	PASS	Humidity:	53 %
Operation Mode:	802.11n (HT40)	Antenna:	A

Channel number	Channel frequency (MHz)	Measurement level (MHz)	6db Bandwidth Limit(MHz)
3	2422	35.807	>0.5
6	2437	35.660	>0.5
9	2452	35.711	>0.5

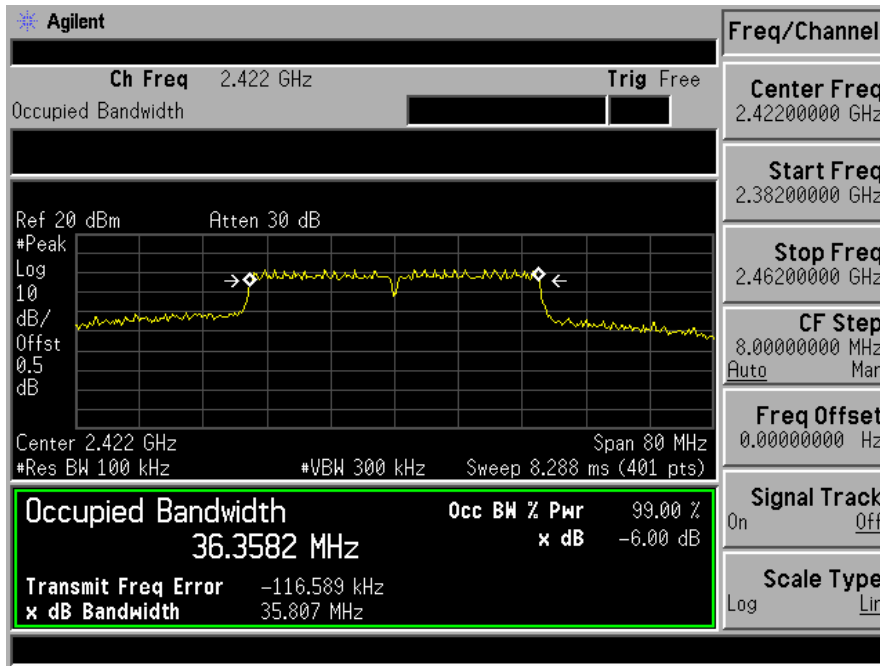

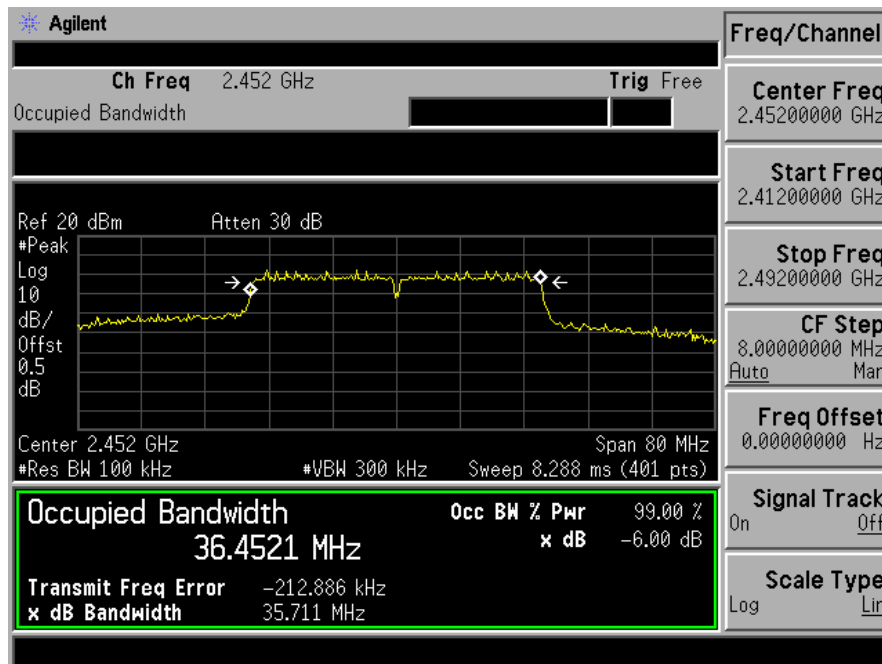
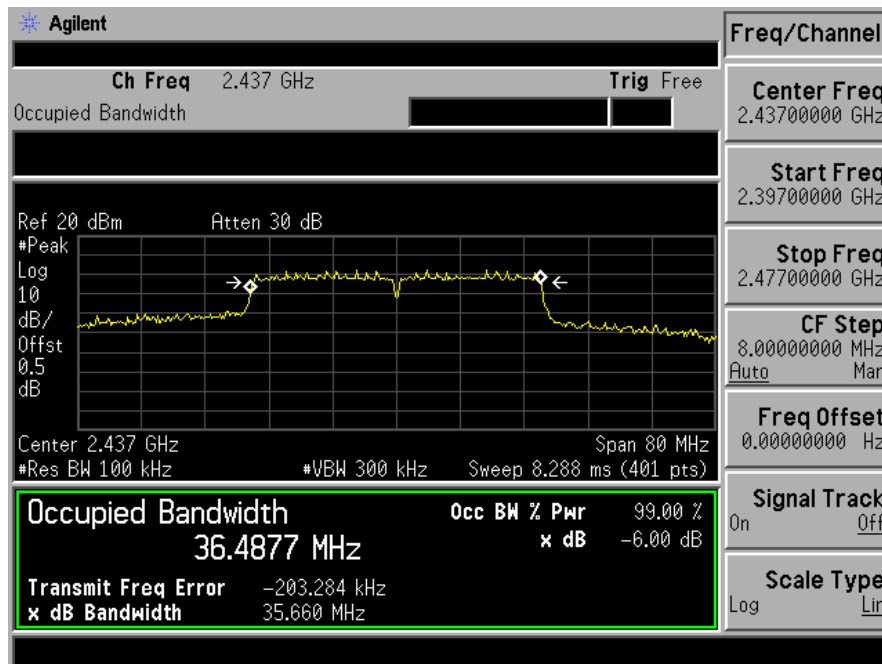

8. Maximum Peak Output Power Test

8.1 Measurement Procedure

- The testing follows FCC public Notice DA 00-705 Measurement Guidelines.
- The RF output of EUT was connected to the power meter by RF cable and attenuator. The path loss was compensated to the results for each measurement.
- Set to the maximum output power setting and enable the EUT transmit continuously.
- Measure the conducted output power with cable loss and record the results in the test report.
- Measure and record the results in the report.

8.2 Test SET-UP (Block Diagram of Configuration)



8.3 Measurement Equipment Used

EQUIPMENT TYPE	MODEL NUMBER	SERIAL NUMBER	LAST CAL.	CAL DUE.
Power meter	ML2495A	0824006	05/17/2014	05/16/2015
Power sensor	MA2411B	0738172	05/17/2014	05/16/2015

8.4 Peak Power output limit

The maximum peak power shall be less 1Watt.

8.5 Measurement Results

Spectrum Detector: PK Test Date: September 25, 2014
 Test By: KK Temperature: 24
 Test Result: PASS Humidity: 53 %
 Operation Mode: 802.11b Antenna: A

Channel number	Channel Frequency(MHz)	Peak Power output(dBm)	Peak Power Limit(W)	Pass/Fail
1	2412	12.53	1W(30dBm)	PASS
6	2437	12.05	1W(30dBm)	PASS
11	2462	12.42	1W(30dBm)	PASS

Spectrum Detector: PK Test Date: September 25, 2014
 Test By: KK Temperature: 24
 Test Result: PASS Humidity: 53 %
 Operation Mode: 802.11g Antenna: A

Channel number	Channel Frequency (MHz)	Peak Power output(dBm)	Peak Power Limit(W)	Pass/Fail
1	2412.00	9.04	1W(30dBm)	PASS
6	2437.00	9.26	1W(30dBm)	PASS
11	2462.00	9.43	1W(30dBm)	PASS

Spectrum Detector: PK Test Date: September 25, 2014
 Test By: KK Temperature: 24
 Test Result: PASS Humidity: 53 %
 Operation Mode: 802.11n H20 Antenna: A

Channel number	Channel Frequency (MHz)	Peak Power output(dBm)	Peak Power Limit(W)	Pass/Fail
1	2412.00	8.91	1W(30dBm)	PASS
6	2437.00	9.16	1W(30dBm)	PASS
11	2462.00	9.37	1W(30dBm)	PASS

Spectrum Detector: PK Test Date: September 25, 2014
 Test By: KK Temperature: 24
 Test Result: PASS Humidity: 53 %
 Operation Mode: 802.11n H40 Antenna: A

Channel number	Channel Frequency (MHz)	Peak Power output(dBm)	Peak Power Limit(W)	Pass/Fail
3	2422.00	8.79	1W(30dBm)	PASS
6	2437.00	9.16	1W(30dBm)	PASS
9	2452.00	9.43	1W(30dBm)	PASS

9. Band Edge Test

9.1 Measurement Procedure

1. The testing follows FCC KDB Publication No. 558074 D01 DTS Meas. Guidance v03r02.
2. The EUT was arranged to its worst case and then tune the antenna tower (from 1 m to 4 m) and turntable (from 0 degree to 360 degrees) to find the maximum reading. A pre-amp and a high pass filter are used for the test in order to get better signal level.
3. The EUT was placed on a turntable with 0.8 meter above ground.
4. The EUT was set 3 meters from the interference receiving antenna, which was mounted on the top of a variable height antenna tower.
5. For measurement below 1GHz, If the emission level of the EUT measured by the peak detector is 3 dB lower than the applicable limit, the peak emission level will be reported. Otherwise, the emission measurement will be repeated using the quasi-peak detector and reported.
6. Use the following spectrum analyzer settings:
 - (1) Span shall wide enough to fully capture the emission being measured;
 - (2) Set RBW=100 kHz for $f < 1$ GHz; VBW = RBW; Sweep = auto; Detector function = peak; Trace = max hold;
 - (3) Set RBW = 1 MHz, VBW= 3MHz for $f \geq 1$ GHz for peak measurement.For average measurement:
VBW = 10 Hz, when duty cycle is no less than 98 percent.
VBW = $1/T$, when duty cycle is less than 98 percent where T is the minimum transmission duration over which the transmitter is on and is transmitting at its maximum power control level for the tested mode of operation.

9.2 Test SET-UP (Block Diagram of Configuration)

As 6.2 Test set up (B) and (C)

9.3 Measurement Equipment Used

Same as 6.3 Radiated Emission Measurement.

9.4 Measurement Results

All modes 2.4G 802.11b/g/n have been tested, and the worst result 802.11b recorded as below

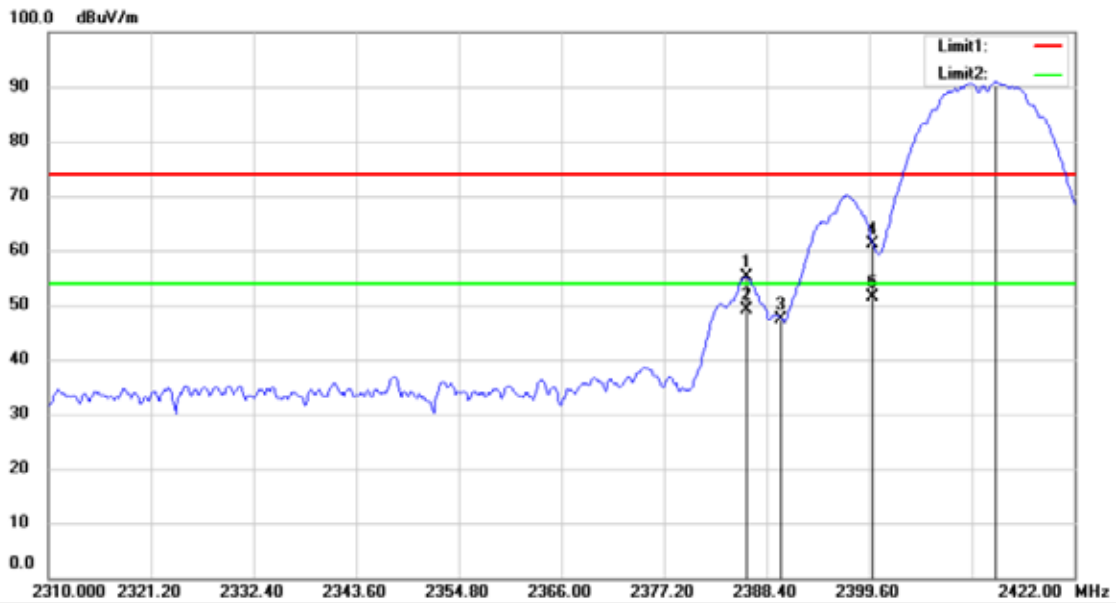

Site 3m Chamber #3 Polarization: **Horizontal** Temperature: 24 C
 Limit: (RE)FCC PART 15 CLASS B Power: Humidity: 53 %
 EUT:150Mbps Wireless N portable AP
 M/N: 4223
 Mode:11B 2462
 Note:

No.	Mk.	Freq.	Reading Level	Correct Factor	Measurement	Limit	Over	Antenna Height	Table Degree	
		MHz	dBuV	dB	dBuV/m	dBuV/m	dB	cm	degree	Comment
1		2386.160	78.31	-23.13	55.18	74.00	-18.82			peak
2		2386.160	72.15	-23.13	49.02	54.00	-4.98			AVG
3		2390.000	70.59	-23.11	47.48	74.00	-26.52			peak
4		2400.000	84.24	-23.06	61.18	74.00	-12.82			peak
5		2400.000	74.45	-23.06	51.39	54.00	-2.61			AVG
6	*	2413.376	113.77	-22.98	90.79	74.00	16.79			peak

*:Maximum data x:Over limit !:over margin

Operator: KK

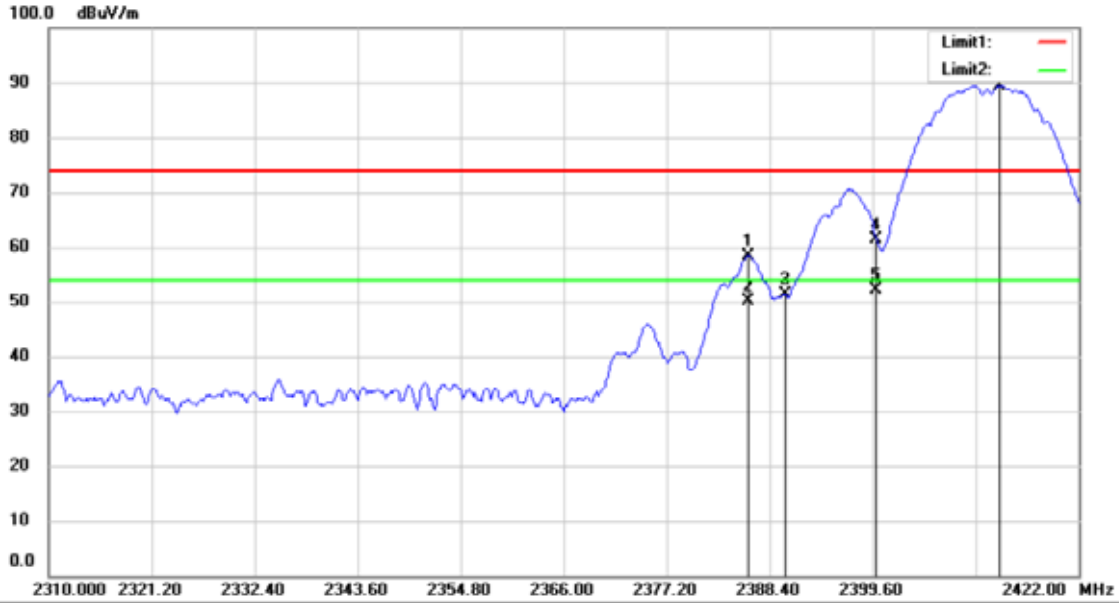

Site: 3m Chamber #3 Polarization: **Vertical** Temperature: 24 C
 Limit: (RE)FCC PART 15 CLASS B Power: Humidity: 53 %
 EUT:150Mbps Wireless N portable AP
 M/N: 4223
 Mode:11B 2412
 Note:

No.	Mk.	Freq. MHz	Reading Level dBuV	Correct Factor dB	Measure- ment dBuV/m	Limit dBuV/m	Over dB	Antenna Height cm	Table Degree	Comment
1		2386.048	81.45	-23.13	58.32	74.00	-15.68	peak		
2		2386.048	73.26	-23.13	50.13	54.00	-3.87	AVG		
3		2390.000	74.53	-23.11	51.42	74.00	-22.58	peak		
4		2400.000	84.45	-23.06	61.39	74.00	-12.61	peak		
5		2400.000	75.12	-23.06	52.06	54.00	-1.94	AVG		
6	*	2413.376	112.41	-22.98	89.43	74.00	15.43	peak		

*:Maximum data x:Over limit l:over margin

Operator: KK



Site 3m Chamber #3 Polarization: **Horizontal** Temperature: 24 C
 Limit: (RE)FCC PART 15 CLASS B Power: Humidity: 53 %
 EUT:150Mbps Wireless N portable AP
 M/N: 4223
 Mode:11B 2462
 Note:

No.	Mk.	Freq.	Reading	Correct	Measure-	Limit	Over	Antenna	Table	
		MHz	Level	Factor	ment			Height	Degree	Comment
			dBuV	dB	dBuV/m	dBuV/m	dB	cm	degree	
1	*	2463.300	115.40	-22.72	92.68	74.00	18.68	peak		
2		2483.500	76.67	-22.62	54.05	74.00	-19.95	peak		
3		2483.500	69.98	-22.62	47.36	54.00	-6.64	AVG		
4		2488.100	80.26	-22.59	57.67	74.00	-16.33	peak		
5		2488.100	73.62	-22.59	51.03	54.00	-2.97	AVG		

*:Maximum data x:Over limit l:over margin

Operator: KK

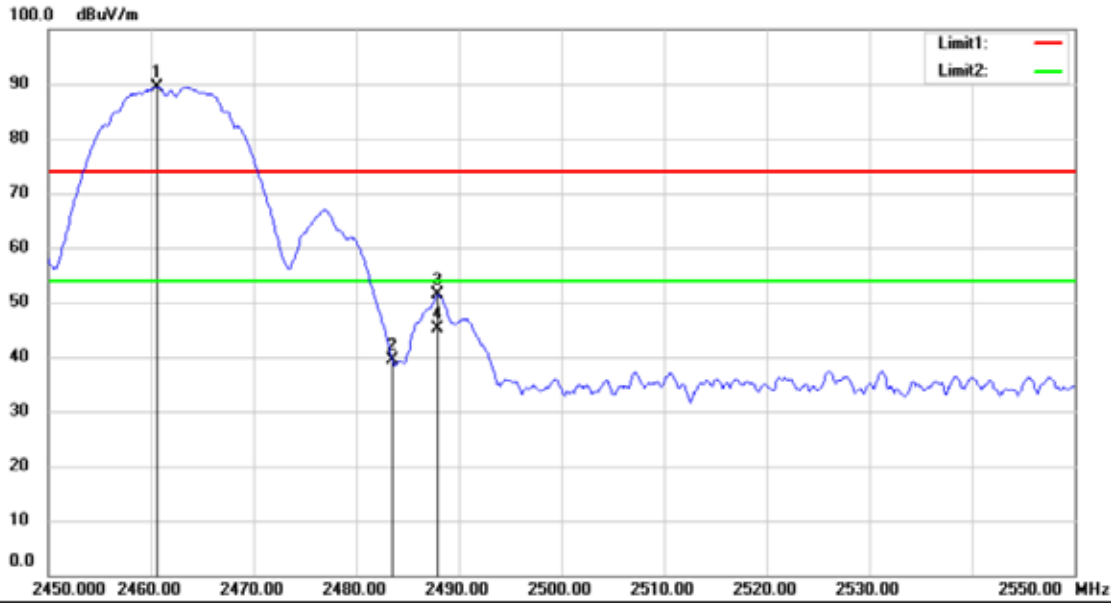

Site 3m Chamber #3 Polarization: **Vertical** Temperature: 24 C
 Limit: (RE)FCC PART 15 CLASS B Power: Humidity: 53 %
 EUT:150Mbps Wireless N portable AP
 M/N: 4223
 Mode:11B 2462
 Note:

No.	Mk.	Freq.	Reading	Correct	Measure-	Limit	Over	Antenna	Table	
		MHz	Level	Factor	ment			Height	Degree	Comment
			dBuV	dB	dBuV/m	dBuV/m	dB	PK/AV	cm	degree
1	*	2460.600	112.03	-22.73	89.30	74.00	15.30	peak		
2		2483.500	62.00	-22.62	39.38	74.00	-34.62	peak		
3		2487.900	73.86	-22.59	51.27	74.00	-22.73	peak		
4		2487.900	67.62	-22.59	45.03	54.00	-8.97	AVG		

*:Maximum data x:Over limit l:over margin

Operator: KK

10. Power Density

10.1 Test Equipment

EQUIPMENT TYPE	MFR	MODEL NUMBER	SERIAL NUMBER	LAST CAL.	CAL DUE.
Signal Analyzer	Agilent	N9010A	My53470879	05/17/2014	05/16/2015

10.2 Measuring Instruments and Setting

The following table is the setting of spectrum analyzer.

Spectrum analyzer	Setting
Attenuation	Auto
Span Frequency	Set the span to 1.5 times the DTS bandwidth.
RB	3kHz ≤RBW ≤100KHz
VB	3 x RBW
Detector	Peak
Trace	Max hold
Sweep Time	Automatic

10.3 Test Procedures

- a. The transmitter output (antenna port) was connected to the spectrum analyzer.
- b. Set analyzer center frequency to DTS channel center frequency.
- c. Set the analyzer span to a minimum of 1.5 times the DTS bandwidth.
- d. Set the RBW ≥ 3 kHz. Set the VBW ≥ 3 x RBW.
- e. Detector = peak.
- f. Sweep time = auto couple.
- g. Trace mode = max hold.
- h. Allow trace to fully stabilize.
- i. Use the peak marker function to determine the maximum amplitude level within the RBW.

10.4 Block Diagram of Test Setup

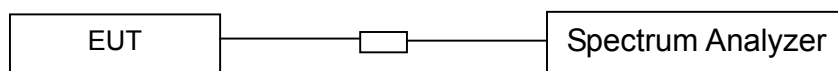

10.5 Limit

The transmitted power density averaged over any 1 second interval shall not be greater +8dBm in any 3 kHz bandwidth.

10.6 Test Result

Spectrum Detector:	PK	Test Date :	September 25, 2014
Test By:	KK	Temperature :	24
Test Result:	PASS	Humidity :	53 %
Operation Mode:	802.11b	Antenna:	A

Channel	Measurement Level (dBm)	Required Limit (dBm)	Result
1	-17.314	<8dBm	PASS
6	-18.616	<8dBm	PASS
11	-19.567	<8dBm	PASS





Spectrum Detector:	PK	Test Date :	September 25, 2014
Test By:	KK	Temperature :	24
Test Result:	PASS	Humidity :	53 %
Operation Mode:	802.11g	Antenna	A

Channel	Measurement Level (dBm)	Required Limit (dBm)	Result
1	-23.492	<8dBm	PASS
6	-24.116	<8dBm	PASS
11	-22.552	<8dBm	PASS



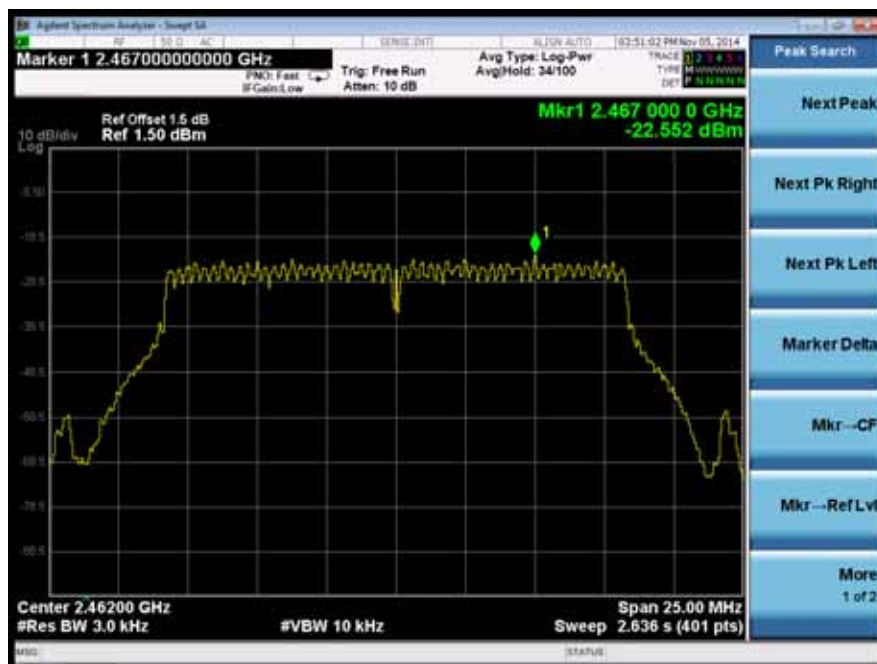
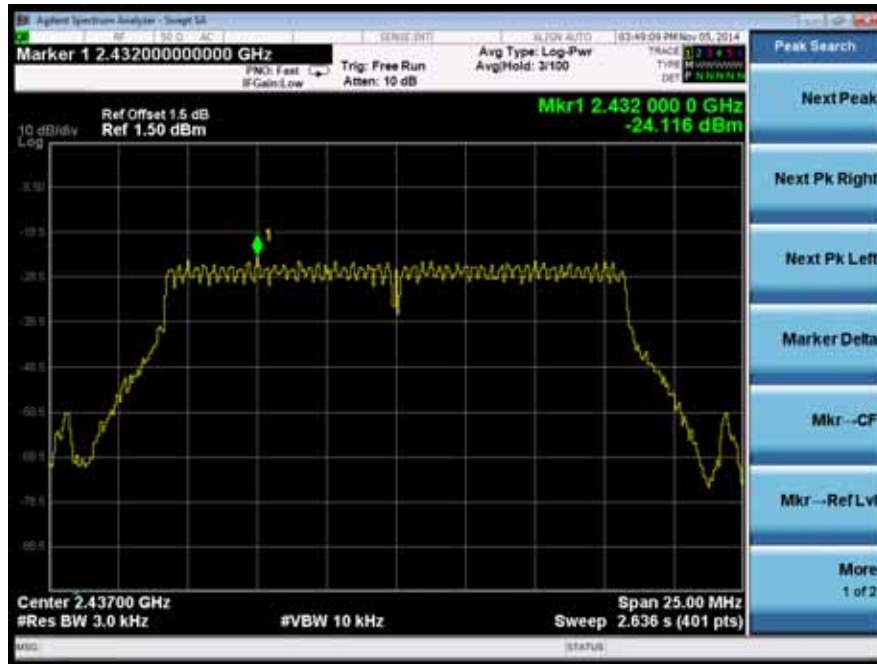

Spectrum Detector:	PK	Test Date :	September 25, 2014
Test By:	KK	Temperature :	24
Test Result:	PASS	Humidity :	53 %
Operation Mode:	802.11n HT20	Antenna	A

Channel	Measurement Level (dBm)	Required Limit (dBm)	Result
1	-22.880	<8dBm	PASS
6	-24.462	<8dBm	PASS
11	-24.931	<8dBm	PASS



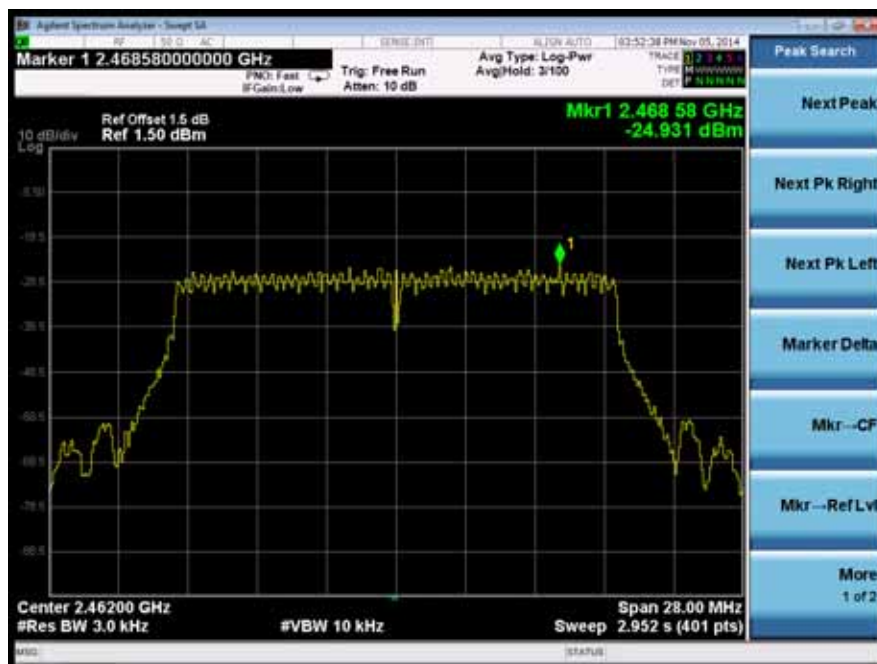

Spectrum Detector:	PK	Test Date :	September 25, 2014
Test By:	KK	Temperature :	24
Test Result:	PASS	Humidity :	53 %
Operation Mode:	802.11n HT40	Antenna:	A

Channel	Measurement Level (dBm)	Required Limit (dBm)	Result
3	-26.265	<8dBm	PASS
6	-26.520	<8dBm	PASS
9	-26.069	<8dBm	PASS





11. Antenna Port Emission

11.1 Test Equipment

EQUIPMENT TYPE	MFR	MODEL NUMBER	SERIAL NUMBER	LAST CAL.	CAL DUE.
Spectrum Analyzer	Agilent	E4407B	88156318	05/17/2014	05/16/2015

11.2 Measuring Instruments and Setting

The following table is the setting of spectrum analyzer.

Spectrum analyzer	Setting
Attenuation	Auto
RB	100kHz
VB	300KHz
Detector	Peak
Trace	Max hold

11.3 Test Procedures

The conducted spurious emissions were measured conducted using a spectrum analyzer at low, Middle, and high channels, the limit was determined by attenuation 20dB of the RF peak power output.

11.4 Block Diagram of Test setup

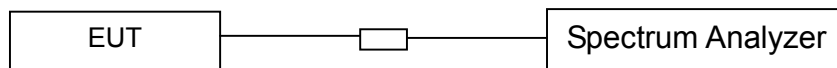

11.5 Test Result

PASS.

All modes 2.4G 802.11b/g/n have been tested, and the worst result 802.11b recorded as below

802.11b Low Channel 1

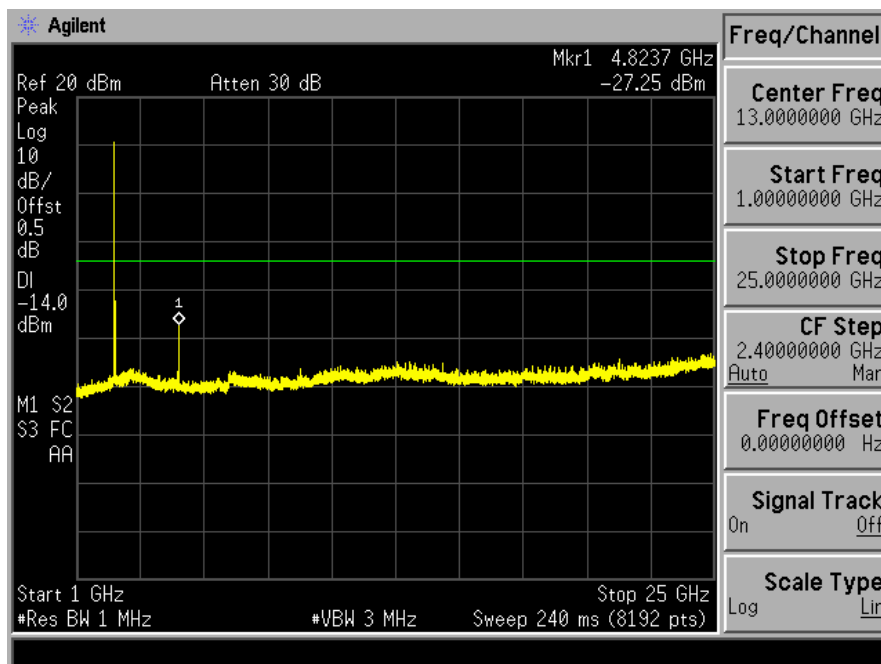
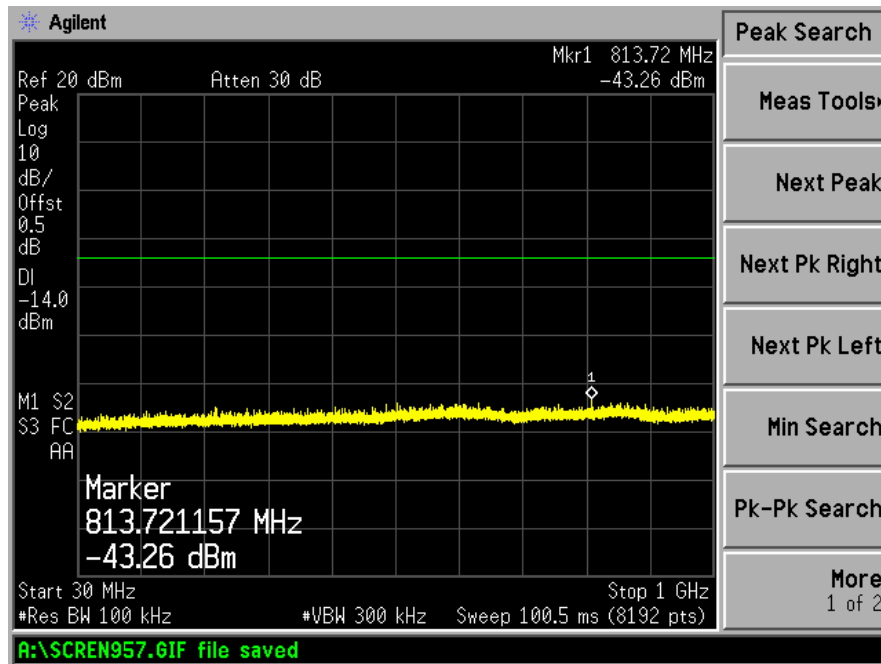

802.11b Mid Channel 6

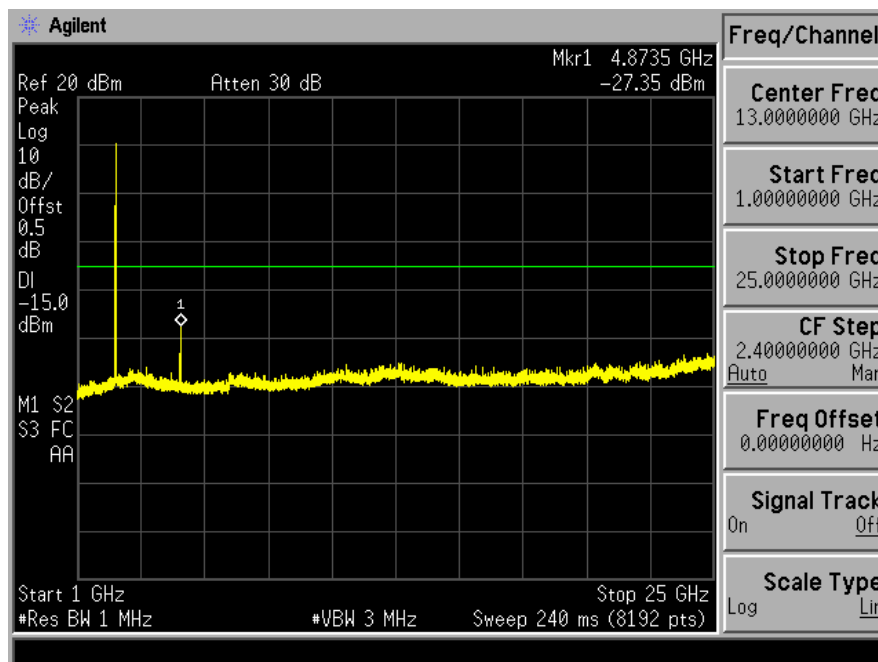
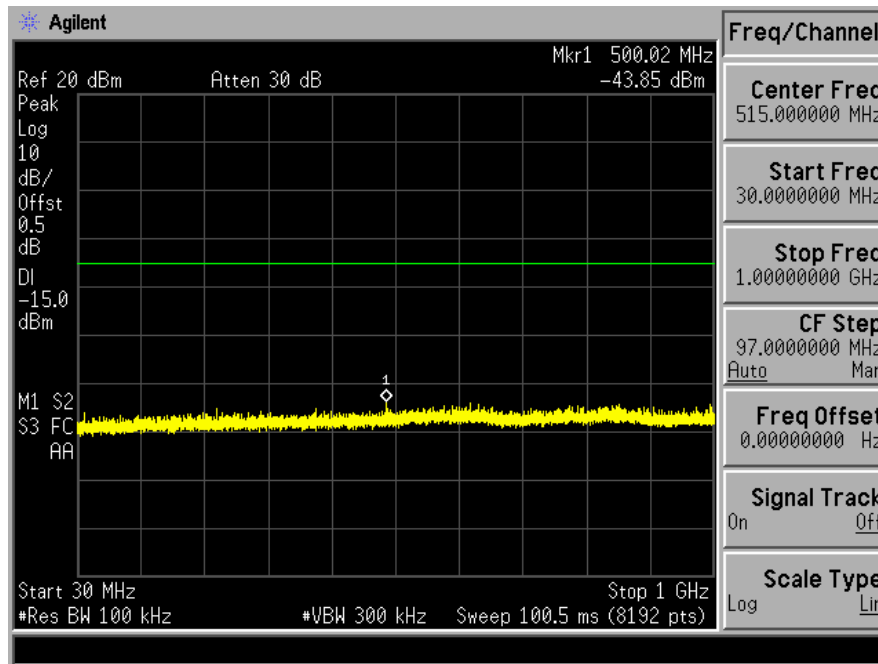

802.11b High Channel 11

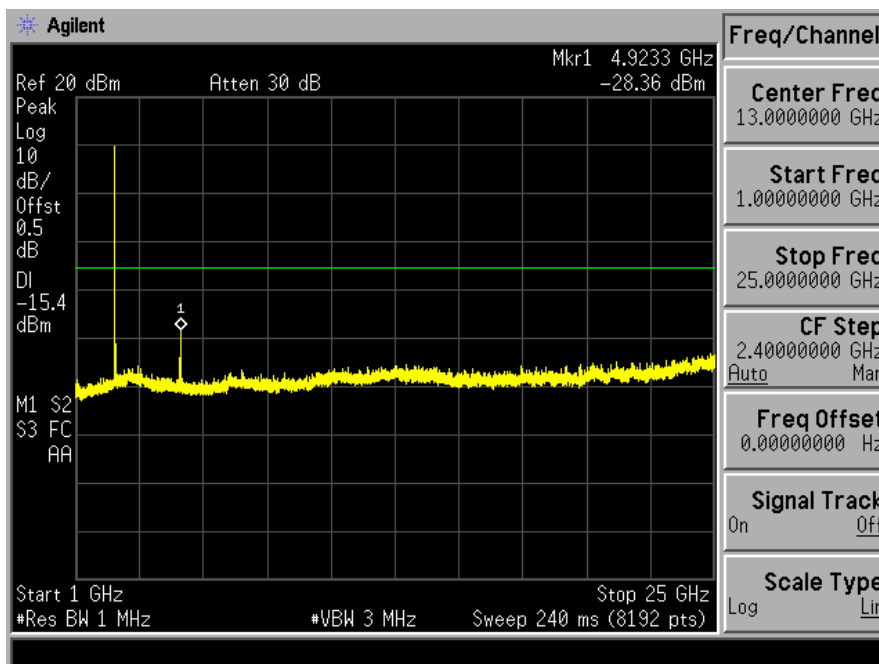
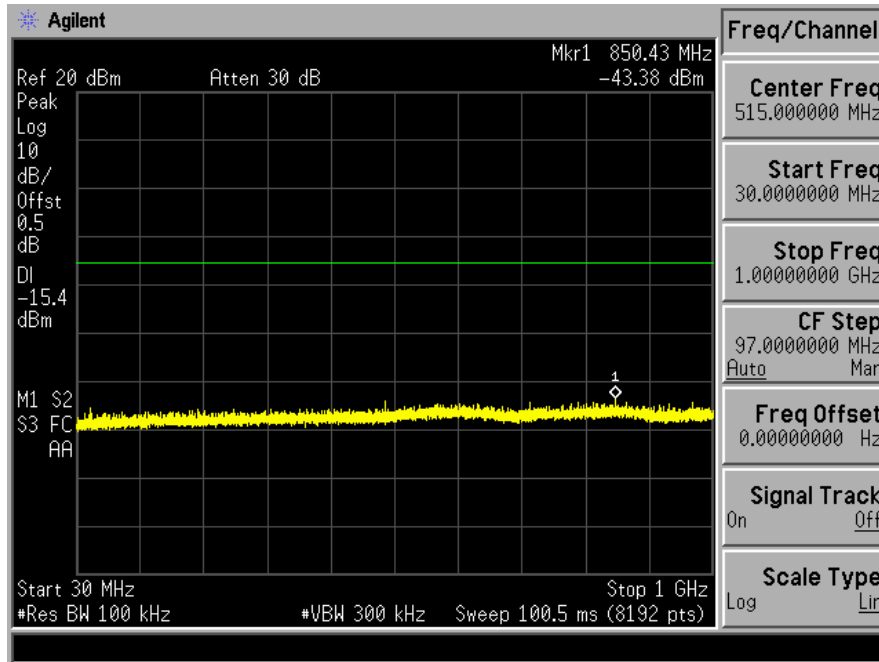

12. Antenna Application

12.1 Antenna Requirement

Standard	Requirement
FCC CRF Part 15.203	An intentional radiator shall be designed to ensure that no antenna other than that furnished by the responsible party shall be used with the device. The use of a permanently attached antenna or of an antenna that uses a unique coupling to the intentional radiator shall be considered sufficient to comply with the provisions of this section. The manufacturer may design the unit so that a broken antenna can be replaced by the user, but the use of a standard antenna jack or electrical connector is prohibited. This requirement does not apply to carrier current devices or to devices operated under the provisions of §15.211, §15.213, §15.217, §15.219, or §15.221. Further, this requirement does not apply to intentional radiators that must be professionally installed, such as perimeter protection systems and some field disturbance sensors, or to other intentional radiators which, in accordance with §15.31(d), must be measured at the installation site. However, the installer shall be responsible for ensuring that the proper antenna is employed so that the limits in this part are not exceeded.

For intentional device, according to FCC 47 CFR Section 15.203, an intentional radiator shall be designed to ensure that no antenna other than that furnished by the responsible party shall be used with the device. And according to FCC 47 CFR Section 15.247 (b), if transmitting antennas of directional gain greater than 6dBi are used, the power shall be reduced by the amount in dB that the directional gain of the antenna exceeds 6dBi.

The EUT has 1 antenna: PiFa antenna for 2.4G WIFI, the gain is 2 dBi;
Note: Antenna use a permanently attached antenna which is not replaceable.
which in accordance to section 15.203, please refer to the internal photos.

12.2 Result

PASS.

13. Uncertainty

Measurement Uncertainty for a level of Confidence of 95%

Parameter	Uncertainty
Radio Frequency	$\pm 1 \times 10^{-5}$
Maximum Peak Output Power Test	$\pm 1.0\text{dB}$
Conducted Emissions Test	$\pm 2.0\text{dB}$
Radiated Emission Test	$\pm 2.0\text{dB}$
Power Density	$\pm 2.0\text{dB}$
Occupied Bandwidth Test	$\pm 1.0\text{dB}$
Band Edge Test	$\pm 3\text{dB}$
All emission, radiated	$\pm 3\text{dB}$
Antenna Port Emission	$\pm 3\text{dB}$
Temperature	± 0.5
Humidity	$\pm 3\%$