

FCC 47 CFR PART 15 SUBPART C

CERTIFICATION TEST REPORT

For

300Mbps Wireless N Router

MODEL No.: N302R Plus, IP04213

FCC ID:X7D-IP04213

Trade Mark: TOTOLINK

REPORT NO.: ES141023303E

ISSUE DATE: November 12, 2014

Prepared for

ZIONCOM ELECTRONICS (SHENZHEN) LTD.

**Building A1~A2, Lantian Science and Technology Park, Xinyu Road,
Xinqiao Henggang Block Shajing Street, Baoan District, Shenzhen,
China**

Prepared by

SHENZHEN EMTEK CO., LTD

**Bldg 69, Majialong Industry Zone, Nanshan District,
Shenzhen, Guangdong, China**

TEL: 86-755-26954280

FAX: 86-755-26954282

TABLE OF CONTENTS

1	TEST RESULT CERTIFICATION	3
2	EUT TECHNICAL DESCRIPTION	4
3	SUMMARY OF TEST RESULT	6
4	TEST METHODOLOGY	7
4.1	GENERAL DESCRIPTION OF APPLIED STANDARDS	7
4.2	MEASUREMENT EQUIPMENT USED.....	7
4.3	DESCRIPTION OF TEST MODES	8
5	FACILITIES AND ACCREDITATIONS	9
5.1	FACILITIES	9
5.2	LABORATORY ACCREDITATIONS AND LISTINGS.....	9
6	TEST SYSTEM UNCERTAINTY	10
7	SETUP OF EQUIPMENT UNDER TEST	11
7.1	RADIO FREQUENCY TEST SETUP 1	11
7.2	RADIO FREQUENCY TEST SETUP 2	11
7.3	CONDUCTED EMISSION TEST SETUP	12
7.4	BLOCK DIAGRAM CONFIGURATION OF TEST SYSTEM	12
7.5	SUPPORT EQUIPMENT	12
8	TEST REQUIREMENTS	13
8.1	DTS (6DB) BANDWIDTH.....	13
8.2	MAXIMUM PEAK CONDUCTED OUTPUT POWER.....	26
8.3	MAXIMUM POWER SPECTRAL DENSITY	27
8.4	UNWANTED EMISSIONS IN NON-RESTRICTED FREQUENCY BANDS	40
8.5	RADIATED SPURIOUS EMISSION.....	49
8.6	CONDUCTED EMISSIONS TEST	66
8.7	ANTENNA APPLICATION	69

1 TEST RESULT CERTIFICATION

Applicant: ZIONCOM ELECTRONICS (SHENZHEN) LTD.
Building A1~A2, Lantian Science and Technology Park, Xinyu Road, Xinqiao
Henggang Block Shajing Street, Baoan District, Shenzhen, China

Manufacturer: ZIONCOM ELECTRONICS (SHENZHEN) LTD.
Building A1~A2, Lantian Science and Technology Park, Xinyu Road, Xinqiao
Henggang Block Shajing Street, Baoan District, Shenzhen, China

EUT Description: 300Mbps Wireless N Router

Model Number: N302R Plus, IP04213

File Number: ES141023303E

Date of Test: November 1, 2014 to November 12, 2014

Measurement Procedure Used:

APPLICABLE STANDARDS	
STANDARD	TEST RESULT
FCC 47 CFR Part 2, Subpart J FCC 47 CFR Part 15, Subpart C	PASS

The above equipment was tested by SHENZHEN EMTEK CO., LTD. The test data, data evaluation, test procedures, and equipment configurations shown in this report were made in accordance with the procedures given in ANSI C63.4 (2009) and the energy emitted by the sample EUT tested as described in this report is in compliance with the requirements of FCC Rules Part 2 and Part 15.247

The test results of this report relate only to the tested sample identified in this report.

Date of Test : November 1, 2014 to November 12, 2014

Prepared by : Joe Xia
Joe Xia/Editor

Reviewer : Jack Li
Jack Li/Supervisor

Approve & Authorized Signer : Lisa Wang
Lisa Wang/Manager

2 EUT TECHNICAL DESCRIPTION

Characteristics	Description
IEEE 802.11 WLAN Mode Supported	<input checked="" type="checkbox"/> 802.11b(20MHz channel bandwidth) <input checked="" type="checkbox"/> 802.11g(20MHz channel bandwidth) <input checked="" type="checkbox"/> 802.11n(20MHz channel bandwidth) <input checked="" type="checkbox"/> 802.11n(40MHz channel bandwidth)
Data Rate	802.11 b:1,2,5.5,11Mbps; 802.11 g:6,9,12,18,24,36,48,54Mbps; 802.11n(HT20):MCS0-MCS7; 802.11n(HT40):MCS0-MCS7; 802.11n(HT40):MCS8-MCS15;
MIMO Mode	802.11n(HT40)
Modulation	DSSS with DBPSK/DQPSK/CCK for 802.11b; OFDM with BPSK/QPSK/16QAM/64QAM for 802.11g/n;
Operating Frequency Range	2412-2462MHz for 802.11b/g; 2412-2462MHz for 802.11n(HT20); 2422-2452MHz for 802.11n(HT40);
Number of Channels	11 channels for 802.11b/g; 11 channels for 802.11n(HT20); 7 channels for 802.11n(HT40);
Transmit Power Max	10.17dBm for 802.11b; 12.71dBm for 802.11g; 11.93dBm for 802.11n(HT20); 15.98dBm for 802.11n(HT40);
Antenna Type	2TX2RX
Antenna Port	<input checked="" type="checkbox"/> Ant1; <input checked="" type="checkbox"/> Ant2; <input checked="" type="checkbox"/> Ant3;
Smart system	<input checked="" type="checkbox"/> SISO for 802.11b/g/n <input checked="" type="checkbox"/> MIMO for 802.11n
Antenna Gain	5.0dBi (for per antenna port Max)
Power supply	<input type="checkbox"/> DC supply: N/A
	<input checked="" type="checkbox"/> Adapter supply: Model: HB12-090080SPA Input: AC 100-240V, 50/60Hz, 0.4A Output: DC 9.0V, 0.8A
Temperature Range	-20°C ~ +55°C

Note: 1.for more details, please refer to the User's manual of the EUT.

2. TX Mode Table:

Mode Modulation	1TX	2TX
802.11b	Antenna 2	Antenna 1+2
802.11g	Antenna 2	Antenna 1+2
802.11n HT20	Antenna 2	Antenna 1+2
802.11n HT40	Antenna 2	Antenna 1+2

3. Antenna Gain Table:

Mode Gain Modulation	SISO	MIMO
802.11b	5dBi	N/A
802.11g	5dBi	N/A
802.11n HT20	5dBi	N/A
802.11n HT40	5dBi	8 dBi

Note: For MIMO Antenna Gain calculate

- (i) If *any* transmit signals are *correlated* with each other, Directional gain = $G_{ANT} + 10 \log(N_{ANT})$ dBi
- (ii) If *all* transmit signals are *completely uncorrelated* with each other, Directional gain = G_{ANT}

3 SUMMARY OF TEST RESULT

FCC Part Clause	Test Parameter	Verdict	Remark
15.247(a)(2)	DTS (6dB) Bandwidth	PASS	
15.247(b)(3)	Maximum Peak Conducted Output Power	PASS	
15.247(e)	Maximum Power Spectral Density Level	PASS	
15.247(d)	Unwanted Emission Into Non-Restricted Frequency Bands	PASS	
15.247(d) 15.209	Unwanted Emission Into Restricted Frequency Bands (conducted)	PASS	
15.247(d) 15.209	Radiated Spurious Emission	PASS	
15.207	Conducted Emission Test	PASS	
15.247(b)	Antenna Application	PASS	
NOTE1: N/A (Not Applicable)			
NOTE2: According to FCC OET KDB 558074, the report use radiated measurements in the restricted frequency bands. In addition, the radiated test is also performed to ensure the emissions emanating from the device cabinet also comply with the applicable limits.			

RELATED SUBMITTAL(S) / GRANT(S):

This submittal(s) (test report) is intended for FCC ID: X7D-IP04213 filing to comply with Section 15.247 of the FCC Part 15, Subpart C Rules.

The system is compliance with Subpart B is authorized under a DOC procedure

4 TEST METHODOLOGY

4.1 GENERAL DESCRIPTION OF APPLIED STANDARDS

According to its specifications, the EUT must comply with the requirements of the following standards:

FCC 47 CFR Part 2, Subpart J

FCC 47 CFR Part 15, Subpart C

FCC KDB 558074 D01 DTS Meas Guidance v03r02

FCC KDB 662911 D01 Multiple Transmitter Output v01

FCC KDB 662911 D02 MIMO With Cross Polarized Antenna V01

4.2 MEASUREMENT EQUIPMENT USED

4.2.1 Conducted Emission Test Equipment

EQUIPMENT TYPE	MFR	MODEL NUMBER	SERIAL NUMBER	LAST CAL.
Test Receiver	Rohde & Schwarz	ESCS30	828985/018	05/17/2014
L.I.S.N.	Schwarzbeck	NNLK8129	8129203	05/17/2014
50Ω Coaxial Switch	Anritsu	MP59B	M20531	N/A
Pulse Limiter	Rohde & Schwarz	ESH3-Z2	100006	05/17/2014
Voltage Probe	Rohde & Schwarz	TK9416	N/A	05/17/2014
I.S.N	Rohde & Schwarz	ENY22	1109.9508.02	05/17/2014

4.2.2 Radiated Emission Test Equipment

EQUIPMENT TYPE	MFR	MODEL NUMBER	SERIAL NUMBER	LAST CAL.
EMI Test Receiver	Rohde & Schwarz	ESU	1302.6005.26	05/17/2014
Pre-Amplifier	HP	8447D	2944A07999	05/17/2014
Bilog Antenna	Schwarzbeck	VULB9163	142	05/17/2014
Loop Antenna	ARA	PLA-1030/B	1029	05/17/2014
Horn Antenna	Schwarzbeck	BBHA 9170	BBHA9170399	05/17/2014
Horn Antenna	Schwarzbeck	BBHA 9120	D143	05/17/2014
Cable	Schwarzbeck	AK9513	ACRX1	05/17/2014
Cable	Rosenberger	N/A	FP2RX2	05/17/2014
Cable	Schwarzbeck	AK9513	CRPX1	05/17/2014
Cable	Schwarzbeck	AK9513	CRRX2	05/17/2014

4.2.3 Radio Frequency Test Equipment

EQUIPMENT TYPE	MFR	MODEL NUMBER	SERIAL NUMBER	LAST CAL.
Spectrum Analyzer	Agilent	E4407B	88156318	05/17/2014
Signal Analyzer	Agilent	N9010A	My53470879	05/17/2014
Power meter	Anritsu	ML2495A	0824006	05/17/2014
Power sensor	Anritsu	MA2411B	0738172	05/17/2014

Remark: Each piece of equipment is scheduled for calibration once a year.

4.3 DESCRIPTION OF TEST MODES

The EUT has been tested under its typical operating condition.

The EUT configuration for testing is installed on RF field strength measurement to meet the Commissions requirement and operating in a manner which intends to maximize its emission characteristics in a continuous normal application.

The Transmitter was operated in the normal operating mode. The TX frequency was fixed which was for the purpose of the measurements.

Test of channel included the lowest and middle and highest frequency to perform the test, then record on this report.

Those data rates (802.11b: 1 Mbps; 802.11g: 6 Mbps; 802.11n (HT20): MCS0; 802.11n (HT40): MCS8) were used for all test.

Pre-defined engineering program for regulatory testing used to control the EUT for staying in continuous transmitting and receiving mode is programmed.

Frequency and Channel list for 802.11 b/g/n (HT20):

Channel	Frequency (MHz)	Channel	Frequency (MHz)	Channel	Frequency (MHz)
1	2412	5	2432	9	2452
2	2417	6	2437	10	2457
3	2422	7	2442	11	2462
4	2427	8	2447		

Frequency and Channel list for 802.11 n (HT40):

Channel	Frequency (MHz)	Channel	Frequency (MHz)	Channel	Frequency (MHz)
3	2422	5	2432	8	2447
4	2427	6	2437	9	2452
		7	2442		

Test Frequency and Channel for 802.11 b/g/n (HT20):

Lowest Frequency		Middle Frequency		Highest Frequency	
Channel	Frequency (MHz)	Channel	Frequency (MHz)	Channel	Frequency (MHz)
1	2412	6	2437	11	2462

Test Frequency and channel for 802.11 n (HT40):

Lowest Frequency		Middle Frequency		Highest Frequency	
Channel	Frequency (MHz)	Channel	Frequency (MHz)	Channel	Frequency (MHz)
3	2422	6	2437	9	2452

5 FACILITIES AND ACCREDITATIONS

5.1 FACILITIES

All measurement facilities used to collect the measurement data are located at

Bldg 69, Majialong Industry Zone District, Nanshan District, Shenzhen, China

The sites are constructed in conformance with the requirements of ANSI C63.7, ANSI C63.4 and CISPR Publication 22.

5.2 LABORATORY ACCREDITATIONS AND LISTINGS

Site Description

EMC Lab.

- : Accredited by CNAS, 2013.10.28
The certificate is valid until 2016.10.29
The Laboratory has been assessed and proved to be in compliance with CNAS-CL01: 2006(identical to ISO/IEC17025: 2005)
The Certificate Registration Number is L229

- : Accredited by TUV Rheinland Shenzhen, 2010.5.25
The Laboratory has been assessed according to the requirements ISO/IEC 17025.

- : Accredited by FCC, April 17, 2014
The Certificate Registration Number is 406365.

- : Accredited by FCC, February 28, 2013
The Certificate Registration Number is 709623.

- : Accredited by Industry Canada, May 24, 2008
The Certificate Registration Number is 4480A.

6 TEST SYSTEM UNCERTAINTY

The following measurement uncertainty levels have been estimated for tests performed on the apparatus:

Parameter	Uncertainty
Radio Frequency	$\pm 1 \times 10^{-5}$
Maximum Peak Output Power Test	$\pm 1.0\text{dB}$
Conducted Emissions Test	$\pm 2.0\text{dB}$
Radiated Emission Test	$\pm 2.0\text{dB}$
Power Density	$\pm 2.0\text{dB}$
Occupied Bandwidth Test	$\pm 1.0\text{dB}$
Band Edge Test	$\pm 3\text{dB}$
All emission, radiated	$\pm 3\text{dB}$
Antenna Port Emission	$\pm 3\text{dB}$
Temperature	$\pm 0.5^{\circ}\text{C}$
Humidity	$\pm 3\%$

Measurement Uncertainty for a level of Confidence of 95%

7 SETUP OF EQUIPMENT UNDER TEST

7.1 RADIO FREQUENCY TEST SETUP 1

The WLAN component's antenna ports(s) of the EUT are connected to the measurement instrument per an appropriate attenuator. The EUT is controlled by PC/software to emit the specified signals for the purpose of measurements.

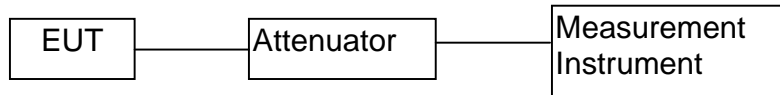

7.2 RADIO FREQUENCY TEST SETUP 2

The test site semi-anechoic chamber has met the requirement of NSA tolerance 4 dB according to the standards: ANSI C63.4. The test distance is 3m. The setup is according to the requirements in Section 13.1.4.1 of ANSI C63.4-2009 and CAN/CSA-CEI/IEC CISPR 22.

The maximal emission value is acquired by adjusting the antenna height, polarisation and turntable azimuth. Normally, the height range of antenna is 1 m to 4 m, the azimuth range of turntable is 0° to 360°, and the receive antenna has two polarizations Vertical (V) and Horizontal (H).

(a) Radiated Emission Test Set-Up, Frequency Below 1000MHz

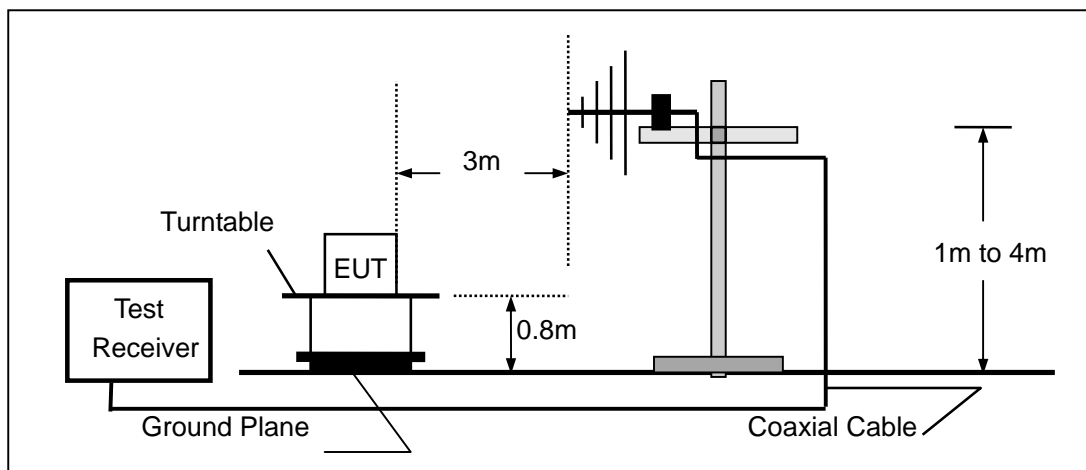

(b) Radiated Emission Test Set-Up, Frequency above 1000MHz

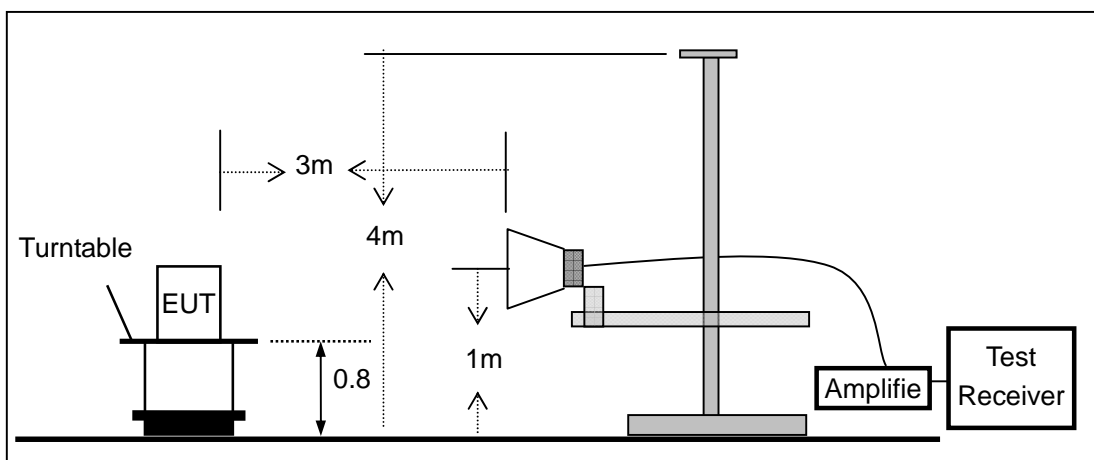

7.3 CONDUCTED EMISSION TEST SETUP

The mains cable of the EUT (maybe per AC/DC Adapter) must be connected to LISN. The LISN shall be placed 0.8 m from the boundary of EUT and bonded to a ground reference plane for LISN mounted on top of the ground reference plane. This distance is between the closest points of the LISN and the EUT. All other units of the EUT and associated equipment shall be at least 0.8m from the LISN.

Ground connections, where required for safety purposes, shall be connected to the reference ground point of the LISN and, where not otherwise provided or specified by the manufacturer, shall be of same length as the mains cable and run parallel to the mains connection at a separation distance of not more than 0.1 m.

According to the requirements in Section 13.1.4.1 of ANSI C63.4-2009 Conducted emissions from the EUT measured in the frequency range between 0.15 MHz and 30 MHz using CISPR Quasi-Peak and average detector mode.

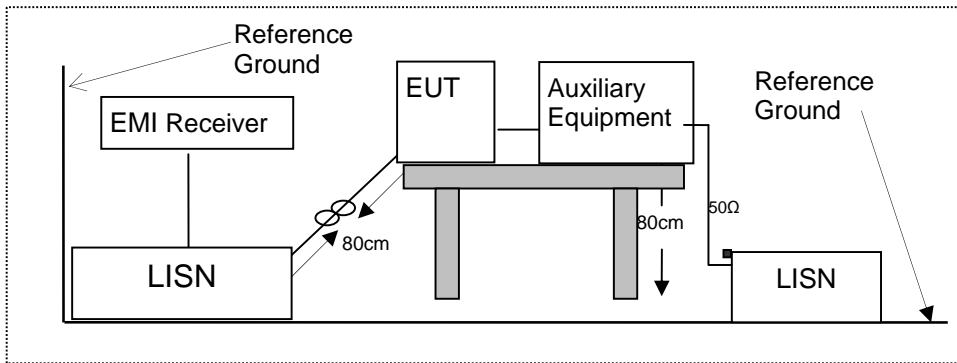

7.4 BLOCK DIAGRAM CONFIGURATION OF TEST SYSTEM

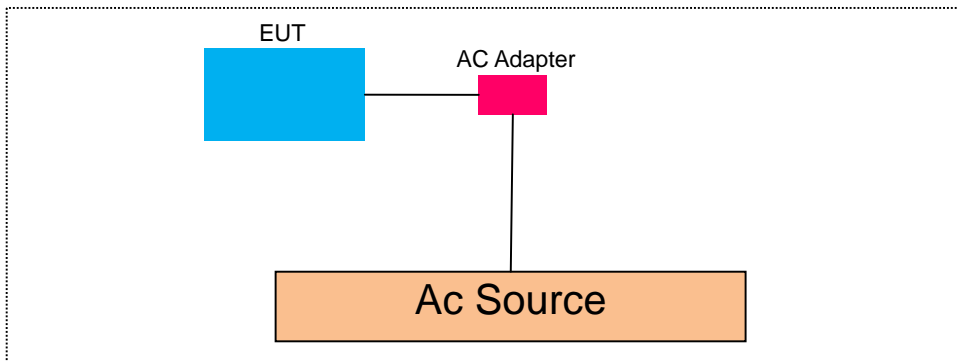

7.5 SUPPORT EQUIPMENT

Item	Equipment	Mfr/Brand	Model/Type No.	FCC ID	Series No.	Note
1.	N/A	N/A	N/A	N/A	N/A	

Notes:

1. All the equipment/cables were placed in the worst-case configuration to maximize the emission during the test.
2. Grounding was established in accordance with the manufacturer's requirements and conditions for the intended use.

8 TEST REQUIREMENTS

8.1 DTS (6DB) BANDWIDTH

8.1.1 Applicable Standard

According to FCC Part 15.247(a)(2) and KDB 558074 DTS 01 Meas. Guidance v03r02

8.1.2 Conformance Limit

The minimum -6 dB bandwidth shall be at least 500 kHz.

8.1.3 Test Configuration

Test according to clause 7.1 radio frequency test setup 1

8.1.4 Test Procedure

The EUT was operating in IEEE 802.11b/g/n mode and controlled its channel. Printed out the test result from the spectrum by hard copy function.

The RF output of EUT was connected to the spectrum analyzer by RF cable and attenuator. The path loss was compensated to the results for each measurement.

Set to the maximum power setting and enable the EUT transmit continuously

Set RBW = 100 kHz.

Set the video bandwidth (VBW) =300 kHz.

Set Span=2 times OBW

Set Detector = Peak.

Set Trace mode = max hold.

Set Sweep = auto couple.

Allow the trace to stabilize.

Measure the maximum width of the emission that is constrained by the frequencies associated with the two outermost amplitude points (upper and lower frequencies) that are attenuated by 6 dB relative to the maximum level measured in the fundamental emission.

Measure and record the results in the test report.

8.1.5 Test Results

Temperature : 28°C Test Date : Nov. 5, 2014
 Humidity : 65 % Test By: King Kong

Operation Mode	Channel Number	Channel Frequency (MHz)	Measurement Bandwidth (MHz)		Limit (kHz)	Verdict
			Ant1	Ant2		
802.11b	1	2412	8.111	8.126	500	PASS
	6	2437	8.120	8.120	500	PASS
	11	2462	8.121	8.116	500	PASS
802.11g	1	2412	15.12	15.14	500	PASS
	6	2437	15.12	15.13	500	PASS
	11	2462	15.11	15.12	500	PASS
802.11n (HT20)	1	2412	15.12	15.15	500	PASS
	6	2437	15.14	15.13	500	PASS
	11	2462	15.11	15.13	500	PASS
802.11n (HT40)	3	2422	32.97	35.22	500	PASS
	6	2437	32.98	35.21	500	PASS
	9	2452	32.64	35.21	500	PASS

Test Model	DTS (6dB) Bandwidth 802.11b	Ant1
	Channel 1: 2412MHz	

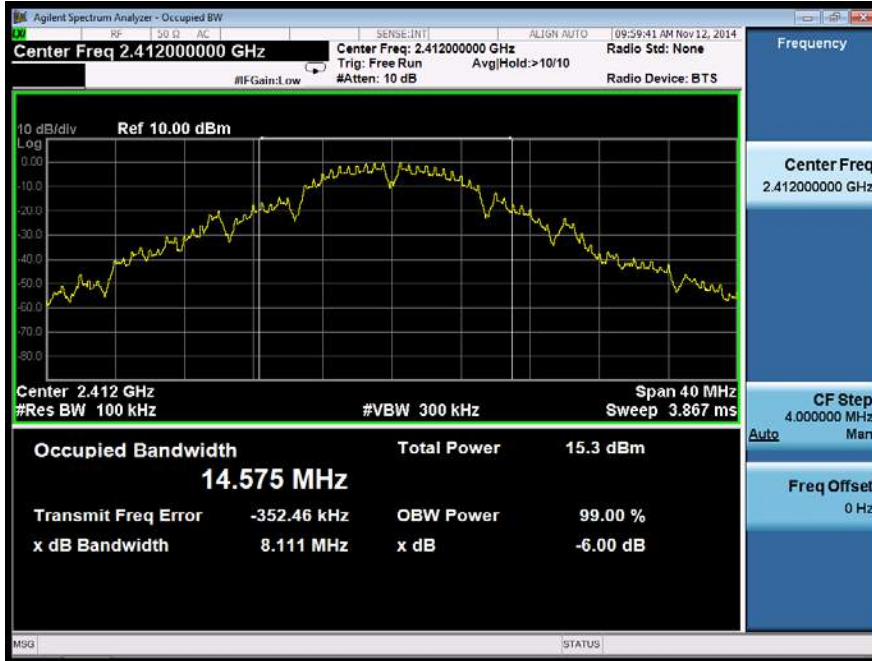

Test Model	DTS (6dB) Bandwidth 802.11b	Ant1
	Channel 6: 2437MHz	



Test Model	DTS (6dB) Bandwidth 802.11b	Ant1
	Channel 11: 2462MHz	



Test Model	DTS (6dB) Bandwidth 802.11g	Ant1
	Channel 1: 2412MHz	



Test Model	DTS (6dB) Bandwidth 802.11g Channel 6: 2437MHz	Ant1
------------	--	------



Test Model	DTS (6dB) Bandwidth 802.11g Channel 11: 2462MHz	Ant1
------------	---	------



Test Model	DTS (6dB) Bandwidth 802.11n (HT20) Channel 1: 2412MHz	Ant1
------------	---	------



Test Model	DTS (6dB) Bandwidth 802.11n (HT20) Channel 6: 2437MHz	Ant1
------------	---	------



Test Model	DTS (6dB) Bandwidth 802.11n (HT20) Channel 11: 2462MHz	Ant1
------------	--	------



Test Model	DTS (6dB) Bandwidth 802.11n (HT40) Channel 3: 2422MHz	Ant1
------------	---	------



Test Model	DTS (6dB) Bandwidth 802.11n (HT40) Channel 6: 2437MHz	Ant1
------------	---	------



Test Model	DTS (6dB) Bandwidth 802.11n (HT40) Channel 9: 2452MHz	Ant1
------------	---	------

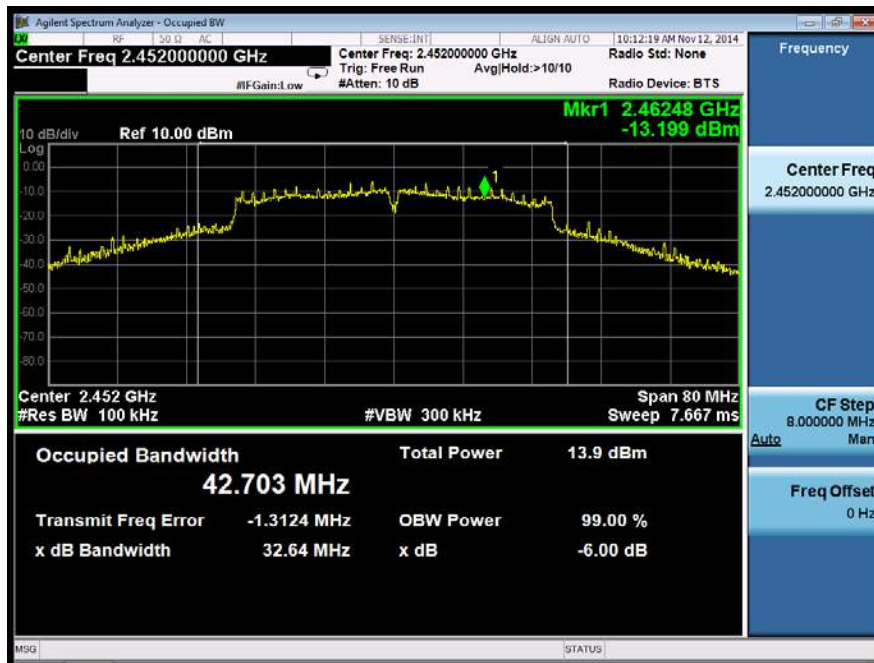

Test Model	DTS (6dB) Bandwidth 802.11b Channel 1: 2412MHz	Ant2
------------	--	------



Test Model	DTS (6dB) Bandwidth 802.11b Channel 6: 2437MHz	Ant2
------------	--	------

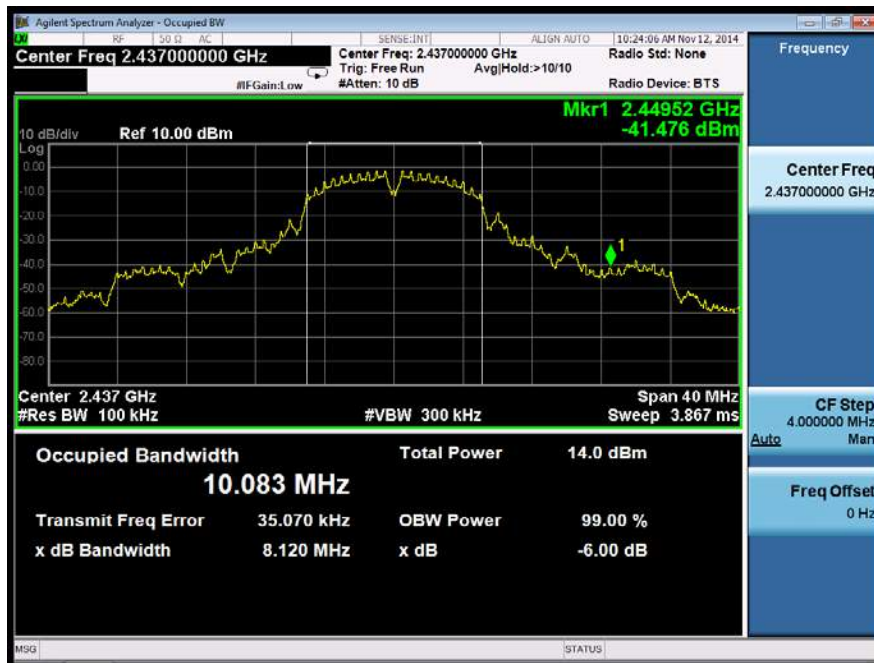

Test Model	DTS (6dB) Bandwidth 802.11b	Ant2
	Channel 11: 2462MHz	



Test Model	DTS (6dB) Bandwidth 802.11g	Ant2
	Channel 1: 2412MHz	

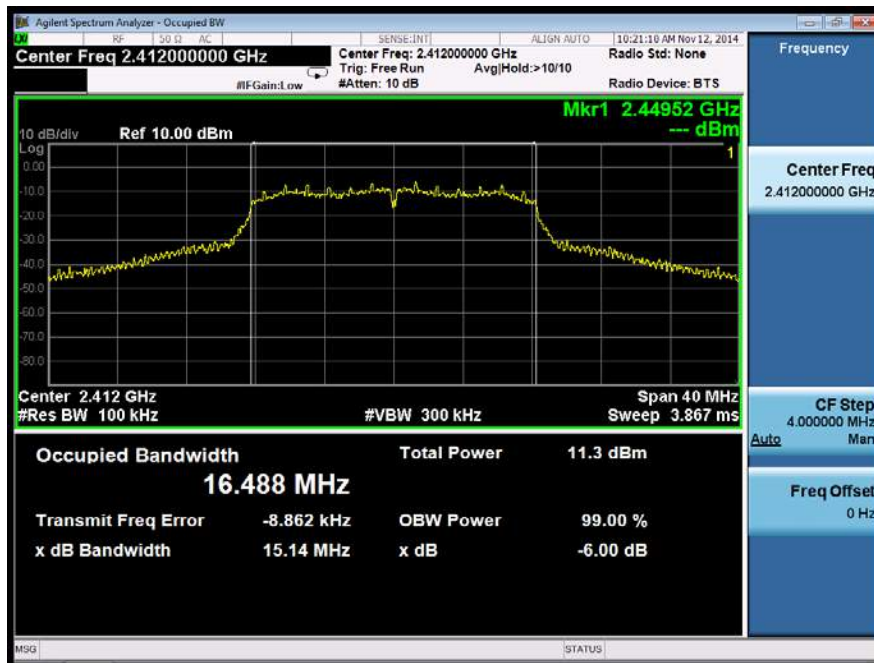

Test Model	DTS (6dB) Bandwidth 802.11g Channel 6: 2437MHz	Ant2
------------	--	------



Test Model	DTS (6dB) Bandwidth 802.11g Channel 11: 2462MHz	Ant2
------------	---	------



Test Model	DTS (6dB) Bandwidth 802.11n (HT20) Channel 1: 2412MHz	Ant2
------------	---	------



Test Model	DTS (6dB) Bandwidth 802.11n (HT20) Channel 6: 2437MHz	Ant2
------------	---	------



Test Model	DTS (6dB) Bandwidth 802.11n (HT20) Channel 11: 2462MHz	Ant2
------------	--	------



Test Model	DTS (6dB) Bandwidth 802.11n (HT40) Channel 3: 2422MHz	Ant2
------------	---	------

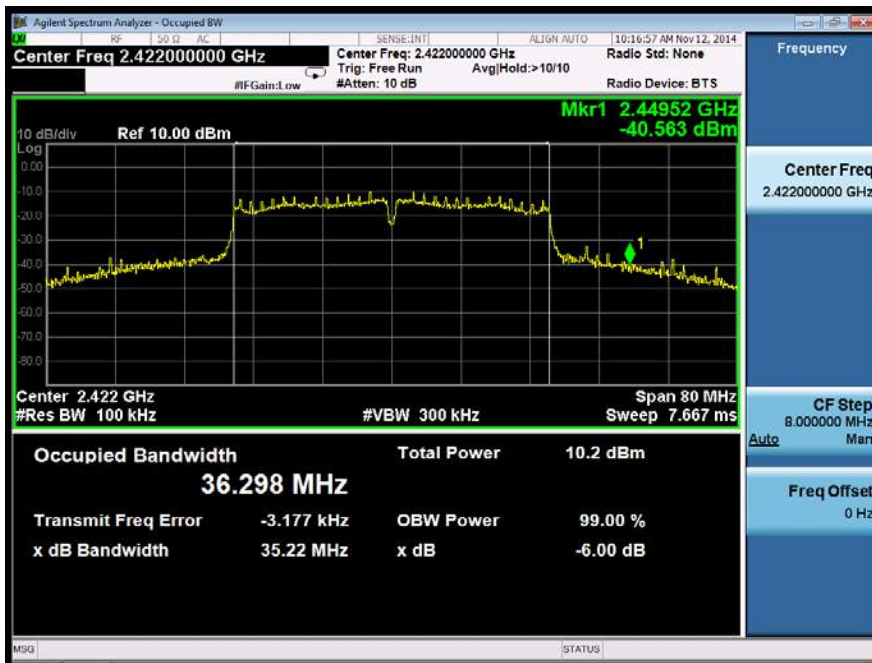

Test Model	DTS (6dB) Bandwidth 802.11n (HT40) Channel 6: 2437MHz	Ant2
------------	---	------



Test Model	DTS (6dB) Bandwidth 802.11n (HT40) Channel 9: 2452MHz	Ant2
------------	---	------

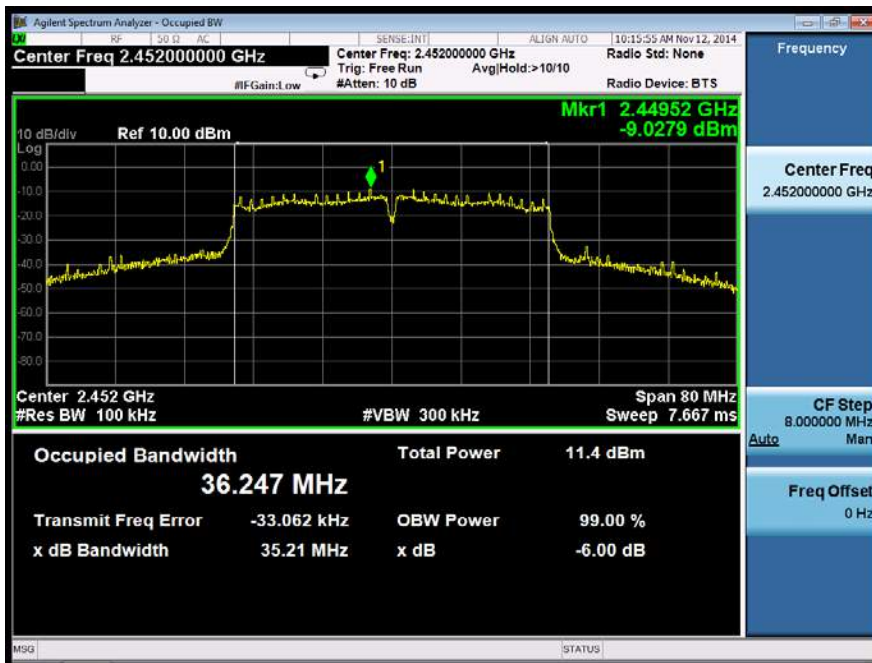

8.2 MAXIMUM PEAK CONDUCTED OUTPUT POWER

8.2.1 Applicable Standard

According to FCC Part 15.247(b)(3) and KDB 558074 DTS 01 Meas. Guidance v03r02

8.2.2 Conformance Limit

The maximum peak conducted output power of the intentional radiator for systems using digital modulation in the 2400 - 2483.5 MHz bands shall not exceed: 1 Watt (30dBm).

8.2.3 Test Configuration

Test according to clause 7.1 radio frequency test setup 1

8.2.4 Test Procedure

■ According to FCC Part15.247(b)(3)

The maximum peak conducted output power may be measured using a broadband peak RF power meter. The power meter shall have a video bandwidth that is greater than or equal to the DTS bandwidth and shall utilize a fast-responding diode detector.

The testing follows FCC public Notice DA 00-705 Measurement Guidelines.

The RF output of EUT was connected to the power meter by RF cable and attenuator. The path loss was compensated to the results for each measurement.

Set to the maximum output power setting and enable the EUT transmit continuously.

Measure the conducted output power with cable loss and record the results in the test report.

Measure and record the results in the report.

■ According to FCC Part 15.247(b)(4):

Conducted output power limit specified in paragraph (b) of this section is based on the use of antennas with directional gains that do not exceed 6 dBi. If transmitting antennas of directional gain greater than 6 dBi are used, the conducted output power from the intentional radiator shall be reduced below the stated values in paragraphs (b)(3) of this section, as appropriate, by the amount in dB that the directional gain of the antenna exceeds 6 dBi.

Note: If antenna Gain exceeds 6 dBi, then Output power Limit=30-(Gain - 6)

8.2.5 Test Results

Temperature : 28°C Test Date : Nov. 5, 2014
 Humidity : 65 % Test By: King Kong

Operation Mode	Channel Number	Channel Frequency (MHz)	Measurement Level (dBm)			Limit (dBm)	Verdict
			Ant1	Ant2	Sum		
802.11b	1	2412	10.17	9.29	--	30	PASS
	6	2437	9.80	9.07	--	30	PASS
	11	2462	9.38	9.67	--	30	PASS
802.11g	1	2412	12.71	11.87	--	30	PASS
	6	2437	11.70	12.28	--	30	PASS
	11	2462	11.39	11.86	--	30	PASS
802.11n (HT20)	1	2412	10.43	11.63	--	30	PASS
	6	2437	10.37	11.40	--	30	PASS
	11	2462	9.63	11.93	--	30	PASS
802.11n (HT40)	3	2422	12.60	11.51	15.10	28	PASS
	6	2437	12.70	11.45	15.13	28	PASS
	9	2452	13.89	11.80	15.98	28	PASS

Note: For smart antenna systems, Maximum Conducted Output Power is summed at the total transmit power delivered to all antennas.

8.3 MAXIMUM POWER SPECTRAL DENSITY

8.3.1 Applicable Standard

According to FCC Part 15.247(e) and KDB 558074 DTS 01 Meas. Guidance v03r02

8.3.2 Conformance Limit

The transmitter power spectral density conducted from the transmitter to the antenna shall not be greater than 8 dBm in any 3 kHz band during any time interval of continuous transmission.

8.3.3 Test Configuration

Test according to clause 7.1 radio frequency test setup 1

8.3.4 Test Procedure

This procedure shall be used if maximum peak conducted output power was used to demonstrate compliance

The transmitter output (antenna port) was connected to the spectrum analyzer

Set analyzer center frequency to DTS channel center frequency.

Set the span to 1.5 times the DTS bandwidth.

Set the RBW to: 3 kHz

Set the VBW to: 10 kHz.

Set Detector = peak.

Set Sweep time = auto couple.

Set Trace mode = max hold.

Allow trace to fully stabilize.

Use the peak marker function to determine the maximum amplitude level within the RBW.

Note: If antenna Gain exceeds 6 dBi, then PSD Limit=8-(Gain - 6)

8.3.5 Test Results

Temperature : 28°C Test Date : Nov. 5, 2014
 Humidity : 65 % Test By: King Kong

Operation Mode	Channel Number	Channel Frequency (MHz)	Measurement Level (dBm/3kHz)			Limit (dBm/3kHz)	Verdict
			Ant1	Ant2	Sum		
802.11b	1	2412	-12.713	-15.521	--	8	PASS
	6	2437	-14.985	-14.410	--	8	PASS
	11	2462	-15.095	-16.200	--	8	PASS
802.11g	1	2412	-18.594	-20.088	--	8	PASS
	6	2437	-20.431	-20.944	--	8	PASS
	11	2462	-20.004	-20.641	--	8	PASS
802.11n (HT20)	1	2412	-21.953	-21.315	--	8	PASS
	6	2437	-22.418	-21.730	--	8	PASS
	11	2462	-20.867	-20.415	--	8	PASS
802.11n (HT40)	3	2422	-22.065	-24.701	-20.18	6	PASS
	6	2437	-22.988	-24.587	-20.70	6	PASS
	9	2452	-23.872	-23.917	-20.88	6	PASS

Note: For smart antenna systems, Maximum Conducted Output Power is summed at the total transmit power delivered to all antennas.

Test Model	Power Spectral Density	
	802.11b	
	Channel 1: 2412MHz	Ant1



Test Model	Power Spectral Density	
	802.11b	
	Channel 6: 2437MHz	Ant1



Test Model	Power Spectral Density 802.11b Channel 11: 2462MHz	Ant1
------------	--	------



Test Model	Power Spectral Density 802.11g Channel 1: 2412MHz	Ant1
------------	---	------

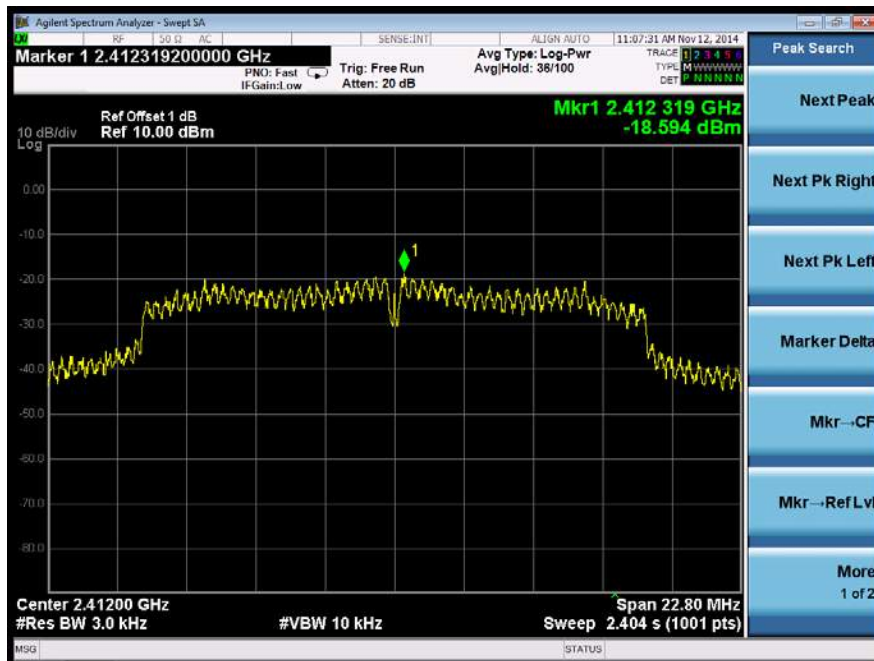

Test Model	Power Spectral Density 802.11g Channel 6: 2437MHz	Ant1
------------	---	------

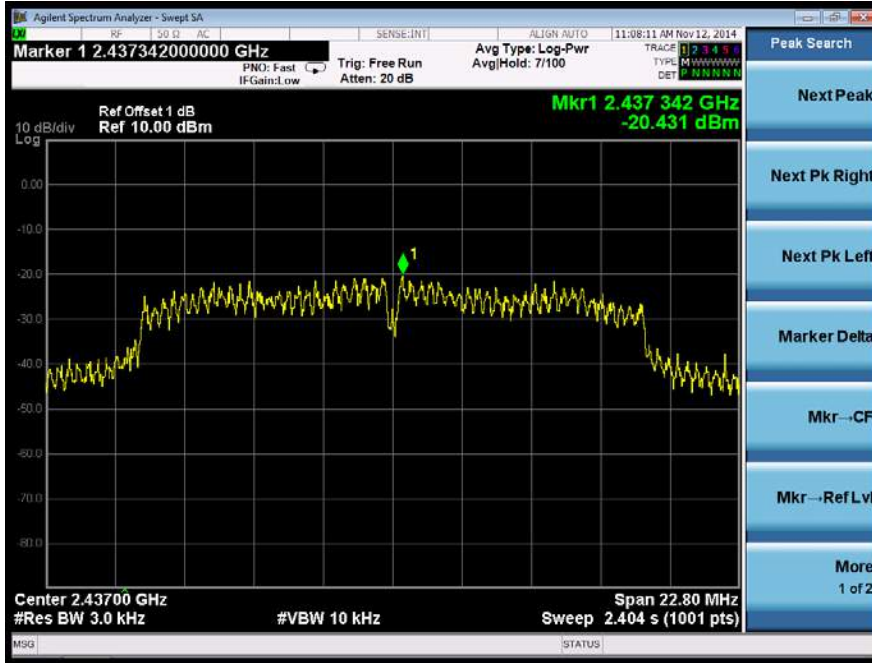

Test Model	Power Spectral Density 802.11g Channel 11: 2462MHz	Ant1
------------	--	------

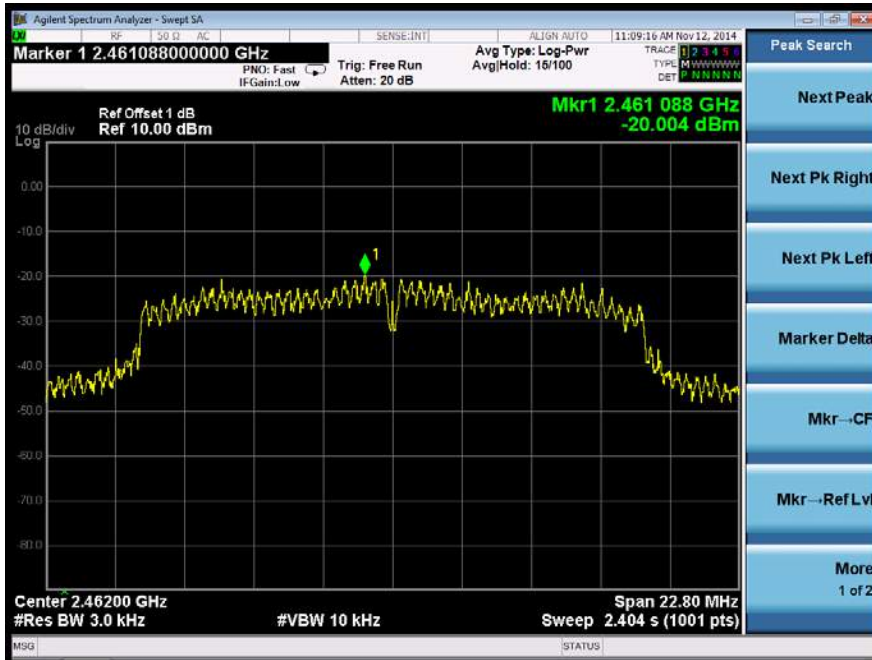

Test Model	Power Spectral Density 802.11n (HT20) Channel 1: 2412MHz	Ant1
------------	--	------

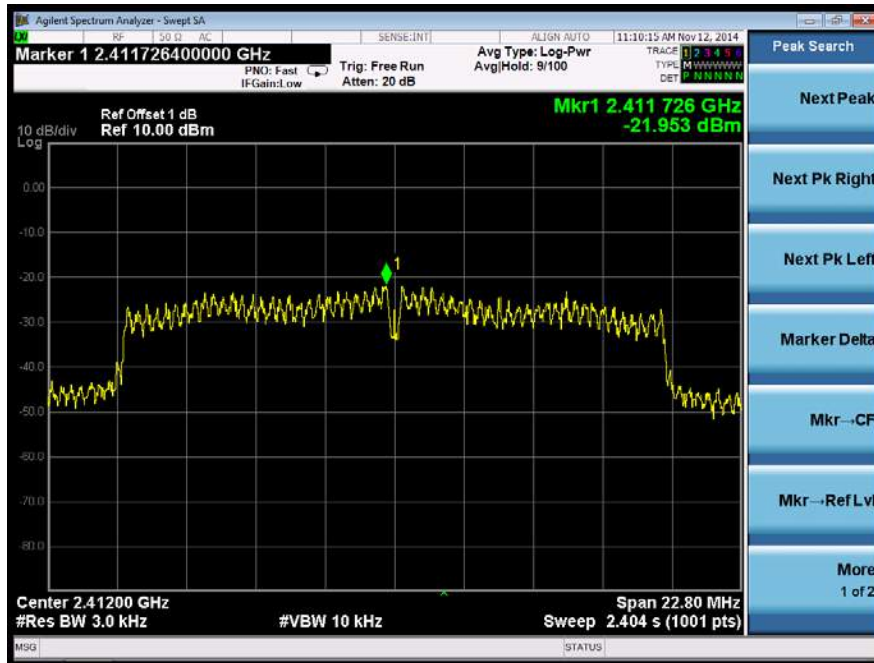

Test Model	Power Spectral Density 802.11n (HT20) Channel 6: 2437MHz	Ant1
------------	--	------

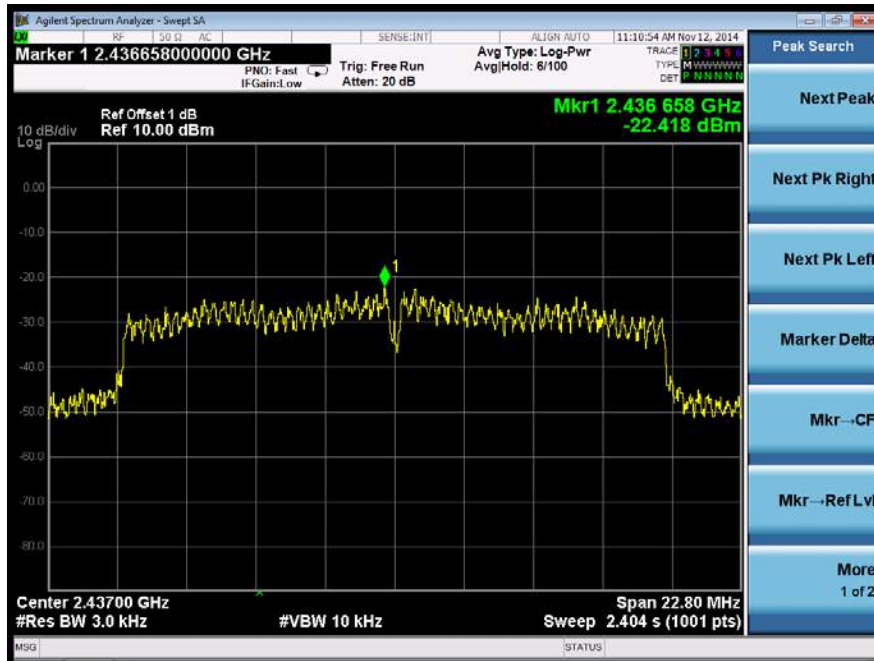

Test Model	Power Spectral Density 802.11n (HT20) Channel 11: 2462MHz	Ant1
------------	---	------



Test Model	Power Spectral Density 802.11n (HT40) Channel 3: 2422MHz	Ant1
------------	--	------

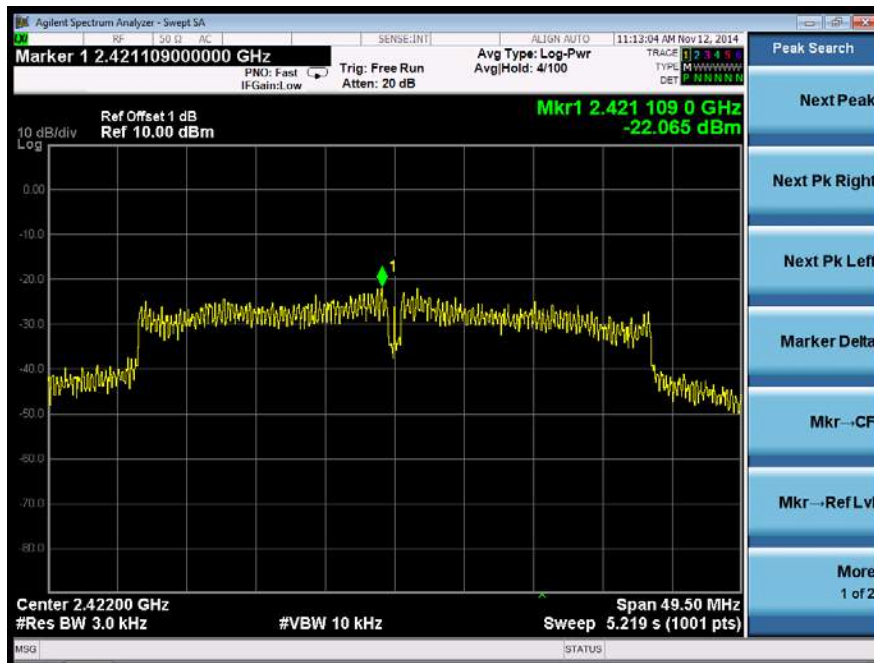

Test Model	Power Spectral Density 802.11n (HT40) Channel 6: 2437MHz	Ant1
------------	--	------

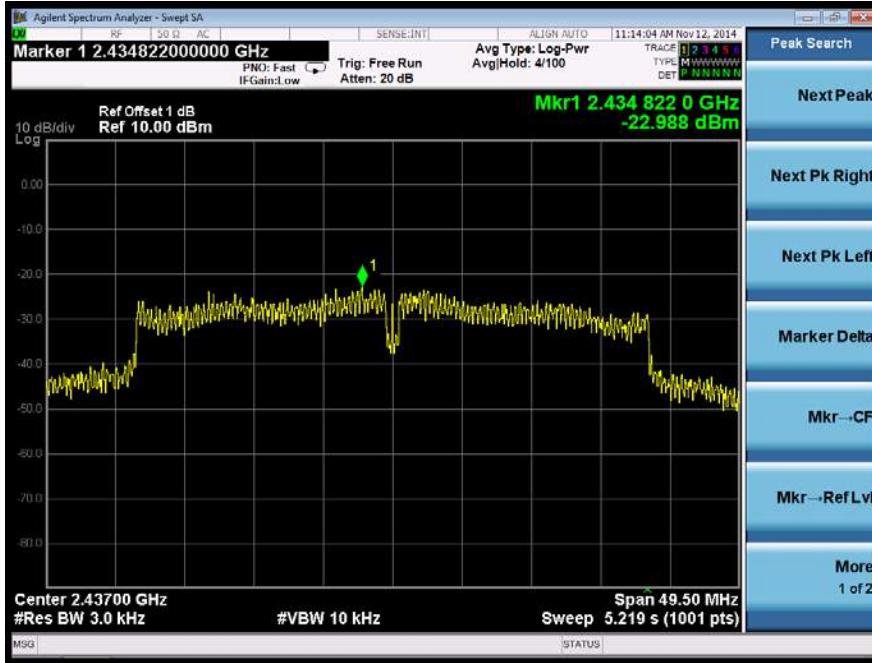

Test Model	Power Spectral Density 802.11n (HT40) Channel 9: 2452MHz	Ant1
------------	--	------

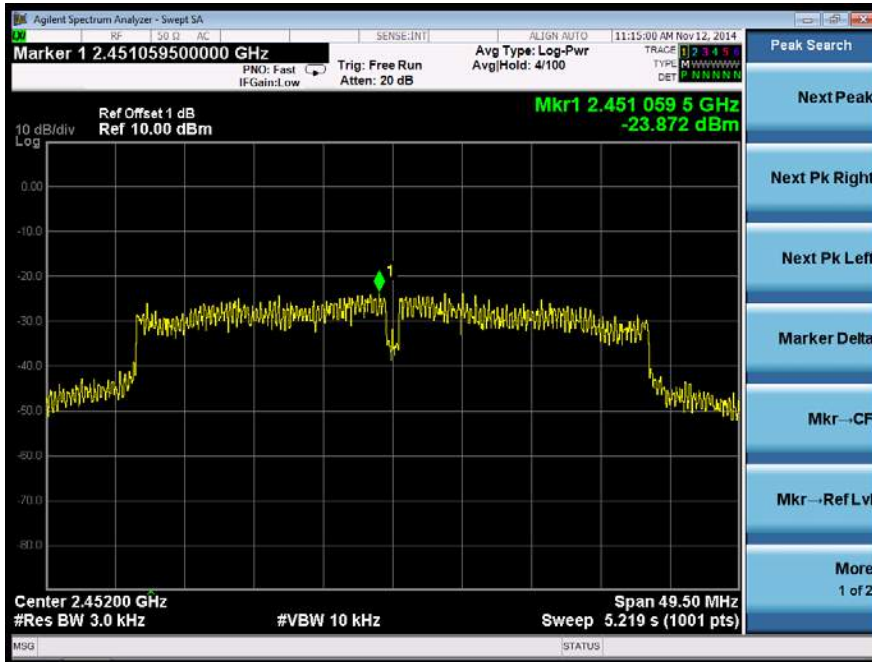

Test Model	Power Spectral Density	
	802.11b	
	Channel 1: 2412MHz	Ant2



Test Model	Power Spectral Density	
	802.11b	
	Channel 6: 2437MHz	Ant2



Test Model	Power Spectral Density	Ant2
	802.11b Channel 11: 2462MHz	



Test Model	Power Spectral Density	Ant2
	802.11g Channel 1: 2412MHz	

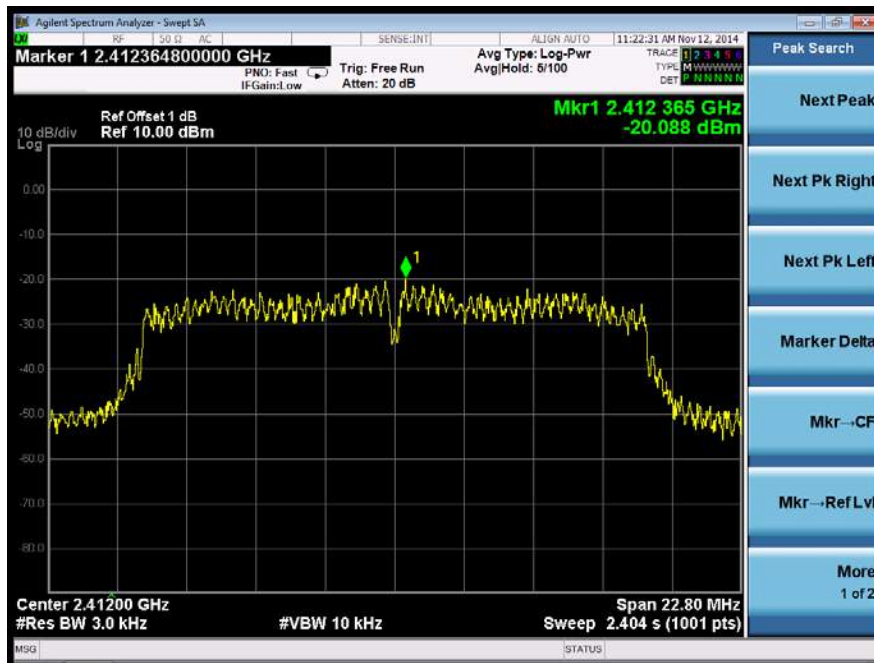

Test Model	Power Spectral Density	
	802.11g	
	Channel 6: 2437MHz	Ant2



Test Model	Power Spectral Density	
	802.11g	
	Channel 11: 2462MHz	Ant2

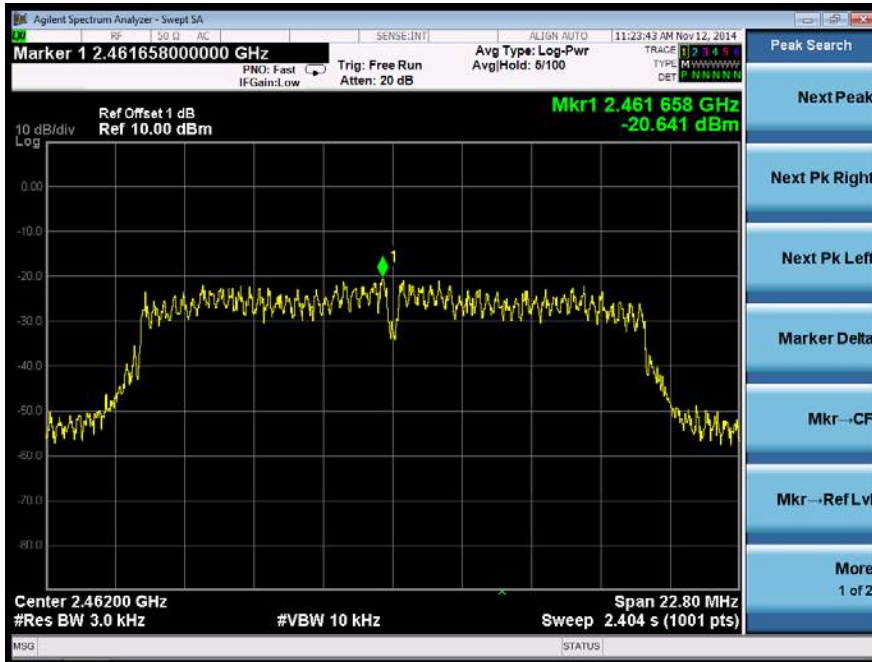

Test Model	Power Spectral Density	
	802.11n (HT20)	
	Channel 1: 2412MHz	Ant2



Test Model	Power Spectral Density	
	802.11n (HT20)	
	Channel 6: 2437MHz	Ant2

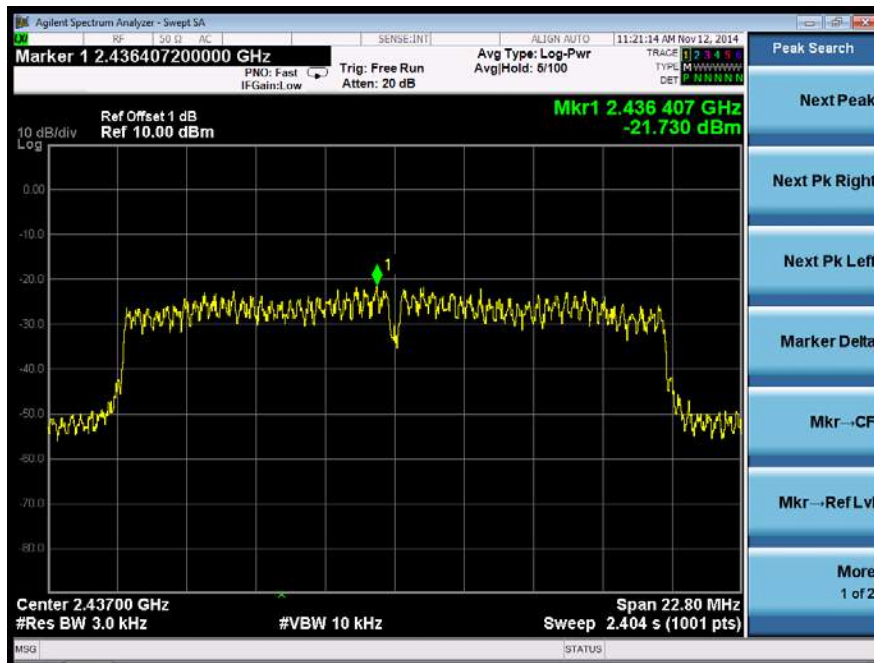

Test Model	Power Spectral Density 802.11n (HT20) Channel 11: 2462MHz	Ant2
------------	---	------

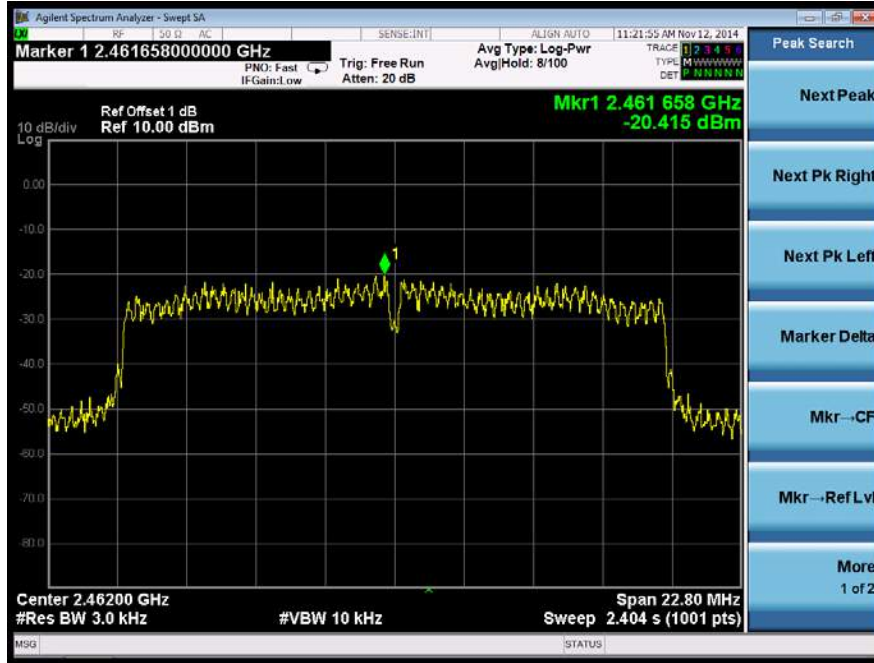

Test Model	Power Spectral Density 802.11n (HT40) Channel 3: 2422MHz	Ant2
------------	--	------

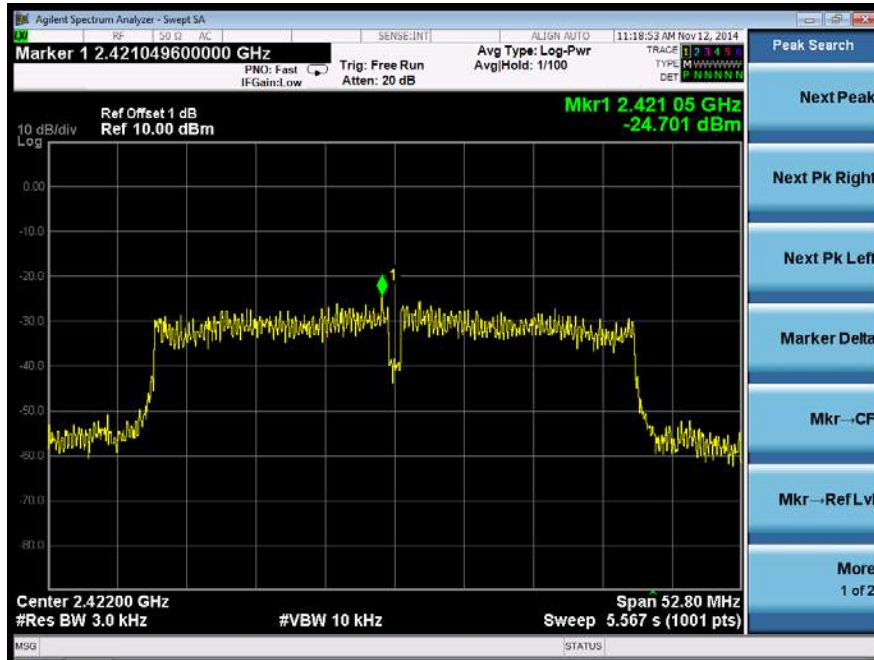

Test Model	Power Spectral Density 802.11n (HT40) Channel 6: 2437MHz	Ant2
------------	--	------

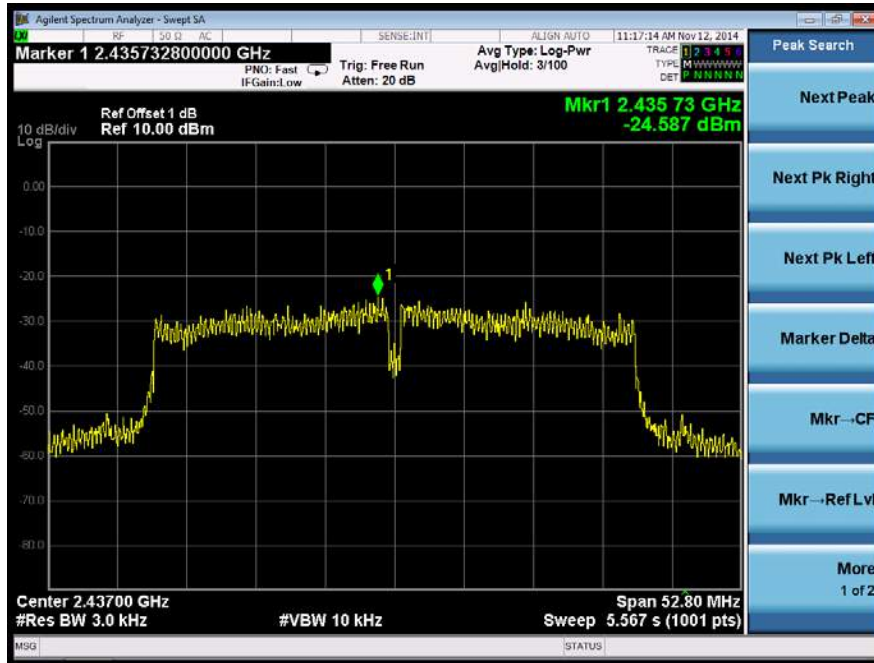

Test Model	Power Spectral Density 802.11n (HT40) Channel 9: 2452MHz	Ant2
------------	--	------

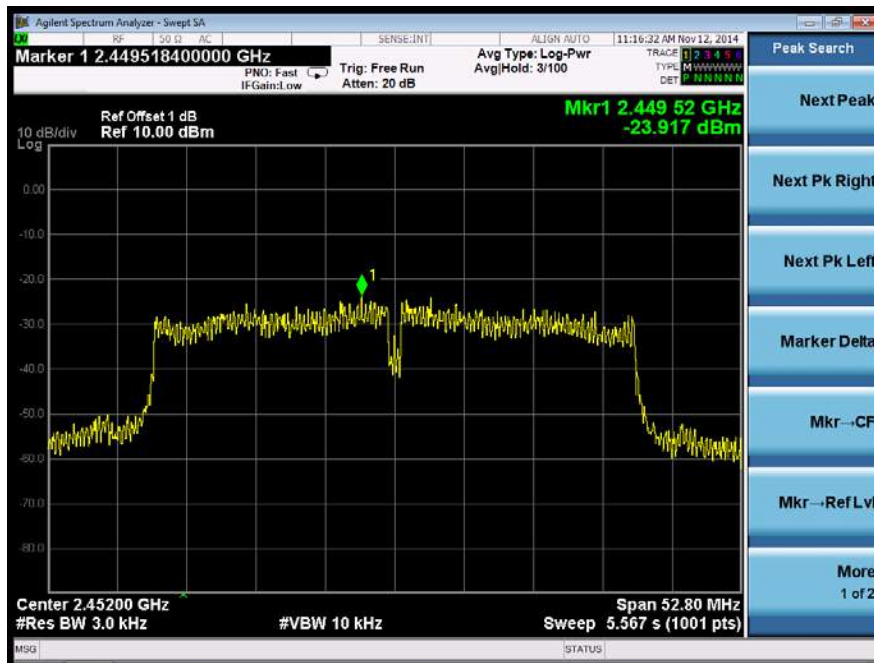

8.4 UNWANTED EMISSIONS IN NON-RESTRICTED FREQUENCY BANDS

8.4.1 Applicable Standard

According to FCC Part 15.247(d) and KDB 558074 DTS 01 Meas. Guidance v03r02

8.4.2 Conformance Limit

According to FCC Part 15.247(d):

In any 100 kHz bandwidth outside the frequency band in which the spread spectrum or digitally modulated intentional radiator is operating, the radio frequency power that is produced by the intentional radiator shall be at least 20 dB below that in the 100 kHz bandwidth within the band that contains the highest level of the desired power, based on either an RF conducted or a radiated measurement, provided the transmitter demonstrates compliance with the peak conducted power limits. If the transmitter complies with the conducted power limits based on the use of RMS averaging over a time interval, as permitted under paragraph (b)(3) of this section, the attenuation required under this paragraph shall be 30 dB instead of 20 dB.

8.4.3 Test Configuration

Test according to clause 7.1 radio frequency test setup 1

8.4.4 Test Procedure

The transmitter output (antenna port) was connected to the spectrum analyzer

■ Reference level measurement

Establish a reference level by using the following procedure:

Set instrument center frequency to DTS channel center frequency.

Set the span to ≥ 1.5 times the DTS bandwidth.

Set the RBW = 100 kHz.

Set the VBW $\geq 3 \times$ RBW.

Set Detector = peak.

Set Sweep time = auto couple.

Set Trace mode = max hold.

Allow trace to fully stabilize.

Use the peak marker function to determine the maximum PSD level.

Note that the channel found to contain the maximum PSD level can be used to establish the reference level.

■ Emission level measurement

Set the center frequency and span to encompass frequency range to be measured.

Set the RBW = 100 kHz.

Set the VBW = 300 kHz.

Set Detector = peak

Sweep time = auto couple.

Trace mode = max hold.

Allow trace to fully stabilize.

Use the peak marker function to determine the maximum amplitude level.

Ensure that the amplitude of all unwanted emissions outside of the authorized frequency band (excluding restricted frequency bands) are attenuated by at least the minimum requirements. Report the three highest emissions relative to the limit.

8.4.5 Test Results

All the modulation modes(11b/g/n mode) were tested, the data of the worst mode are described in the following table

PSD(Power Spectral Density) RBW=100kHz

Test Model	<input type="checkbox"/> 802.11b	<input checked="" type="checkbox"/> 802.11g	<input type="checkbox"/> 802.11n(HT20)	<input type="checkbox"/> 802.11n(HT40)
	<input checked="" type="checkbox"/> Channel 1: 2412MHz	<input type="checkbox"/> Channel 3: 2422MHz	<input checked="" type="checkbox"/> Ant1	<input type="checkbox"/> Ant2

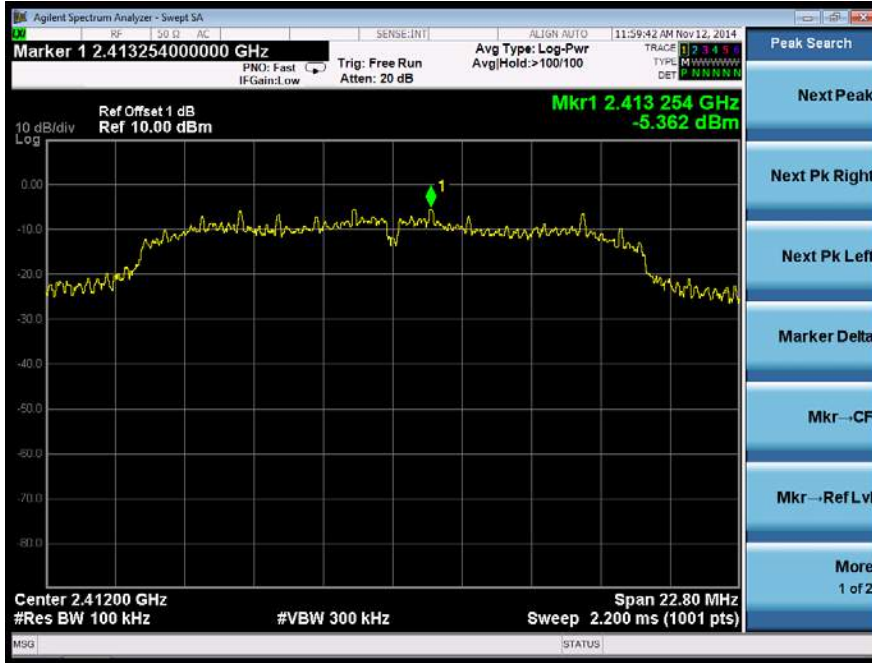

Unwanted Emissions in non-restricted frequency bands

Test Model	<input type="checkbox"/> 802.11b	<input checked="" type="checkbox"/> 802.11g	<input type="checkbox"/> 802.11n(HT20)	<input type="checkbox"/> 802.11n(HT40)
	<input checked="" type="checkbox"/> Channel 1: 2412MHz	<input type="checkbox"/> Channel 3: 2422MHz	<input checked="" type="checkbox"/> Ant1	<input type="checkbox"/> Ant2

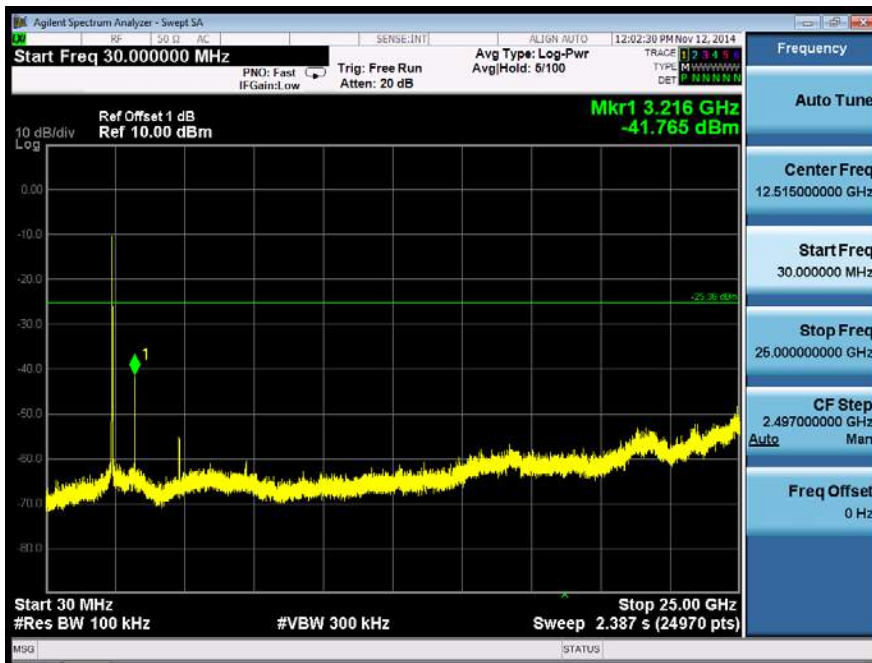

Test Model	<input type="checkbox"/> 802.11b	<input checked="" type="checkbox"/> 802.11g	<input type="checkbox"/> 802.11n(HT20)	<input type="checkbox"/> 802.11n(HT40)
	<input checked="" type="checkbox"/> Channel 1: 2412MHz	<input type="checkbox"/> Channel 3: 2422MHz	<input checked="" type="checkbox"/> Ant1	<input type="checkbox"/> Ant2



Test Model	PSD(Power Spectral Density) RBW=100kHz			
	<input type="checkbox"/> 802.11b	<input checked="" type="checkbox"/> 802.11g	<input type="checkbox"/> 802.11n(HT20)	<input type="checkbox"/> 802.11n(HT40)
	Channel 6: 2437MHz		<input checked="" type="checkbox"/> Ant1	<input type="checkbox"/> Ant2



Unwanted Emissions In Non-Restricted Frequency Bands				
Test Model	<input type="checkbox"/> 802.11b	<input checked="" type="checkbox"/> 802.11g	<input type="checkbox"/> 802.11n(HT20)	<input type="checkbox"/> 802.11n(HT40)
	Channel 6: 2437MHz		<input checked="" type="checkbox"/> Ant1	<input type="checkbox"/> Ant2



PSD(Power Spectral Density) RBW=100kHz				
Test Model	<input type="checkbox"/> 802.11b	<input checked="" type="checkbox"/> 802.11g	<input type="checkbox"/> 802.11n(HT20)	<input type="checkbox"/> 802.11n(HT40)
	<input checked="" type="checkbox"/> Channel 11: 2462MHz	<input type="checkbox"/> Channel 9: 2452MHz	<input checked="" type="checkbox"/> Ant1	<input type="checkbox"/> Ant2

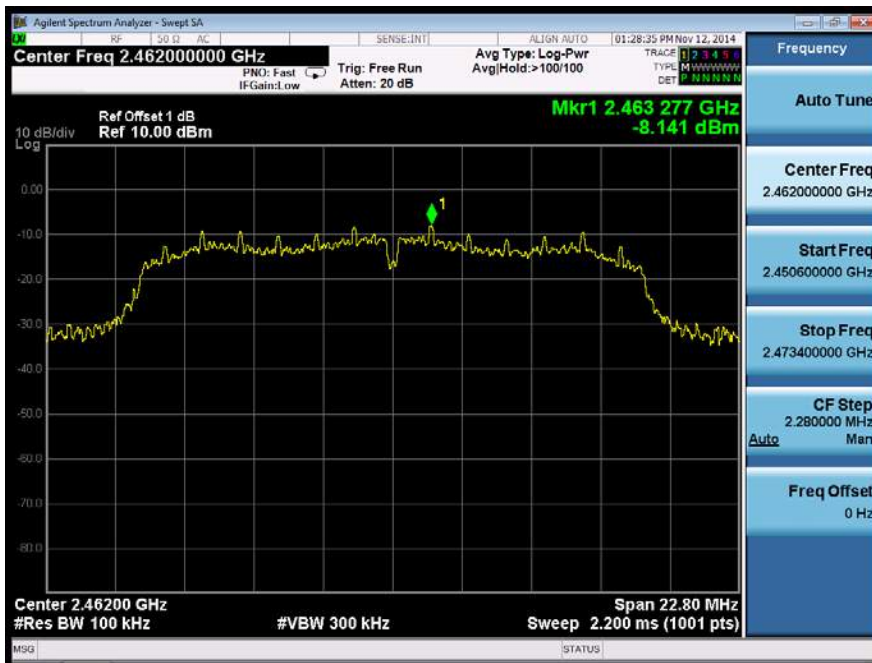

Unwanted Emissions In Non-Restricted Frequency Bands			
Test Model	<input type="checkbox"/> 802.11b	<input checked="" type="checkbox"/> 802.11g	<input type="checkbox"/> 802.11n(HT20)
	<input checked="" type="checkbox"/> Channel 11: 2462MHz	<input type="checkbox"/> Channel 9: 2452MHz	<input checked="" type="checkbox"/> Ant1
			<input type="checkbox"/> Ant2



Band edge			
Test Model	<input type="checkbox"/> 802.11b	<input checked="" type="checkbox"/> 802.11g	<input type="checkbox"/> 802.11n(HT20)
	<input checked="" type="checkbox"/> Channel 11: 2462MHz	<input type="checkbox"/> Channel 9: 2452MHz	<input checked="" type="checkbox"/> Ant1
			<input type="checkbox"/> Ant2



Test Model	PSD(Power Spectral Density) RBW=100kHz			
	<input checked="" type="checkbox"/> 802.11b	<input type="checkbox"/> 802.11g	<input type="checkbox"/> 802.11n(HT20)	<input type="checkbox"/> 802.11n(HT40)
	<input checked="" type="checkbox"/> Channel 1: 2412MHz	<input type="checkbox"/> Channel 3: 2422MHz	<input type="checkbox"/> Ant1	<input checked="" type="checkbox"/> Ant2



Test Model	Unwanted Emissions in non-restricted frequency bands			
	<input checked="" type="checkbox"/> 802.11b	<input type="checkbox"/> 802.11g	<input type="checkbox"/> 802.11n(HT20)	<input type="checkbox"/> 802.11n(HT40)
	<input checked="" type="checkbox"/> Channel 1: 2412MHz	<input type="checkbox"/> Channel 3: 2422MHz	<input type="checkbox"/> Ant1	<input checked="" type="checkbox"/> Ant2



Test Model	<input checked="" type="checkbox"/> 802.11b	<input type="checkbox"/> 802.11g	<input type="checkbox"/> 802.11n(HT20)	<input type="checkbox"/> 802.11n(HT40)
	<input checked="" type="checkbox"/> Channel 1: 2412MHz	<input type="checkbox"/> Channel 3: 2422MHz	<input type="checkbox"/> Ant1	<input checked="" type="checkbox"/> Ant2



Test Model	PSD(Power Spectral Density) RBW=100kHz			
	<input checked="" type="checkbox"/> 802.11b	<input type="checkbox"/> 802.11g	<input type="checkbox"/> 802.11n(HT20)	<input type="checkbox"/> 802.11n(HT40)
	Channel 6: 2437MHz		<input type="checkbox"/> Ant1	<input checked="" type="checkbox"/> Ant2



Test Model	Unwanted Emissions In Non-Restricted Frequency Bands			
	<input checked="" type="checkbox"/> 802.11b	<input type="checkbox"/> 802.11g	<input type="checkbox"/> 802.11n(HT20)	<input type="checkbox"/> 802.11n(HT40)
	Channel 6: 2437MHz		<input type="checkbox"/> Ant1	<input checked="" type="checkbox"/> Ant2



Test Model	PSD(Power Spectral Density) RBW=100kHz			
	<input checked="" type="checkbox"/> 802.11b	<input type="checkbox"/> 802.11g	<input type="checkbox"/> 802.11n(HT20)	<input type="checkbox"/> 802.11n(HT40)
	<input checked="" type="checkbox"/> Channel 11: 2462MHz	<input type="checkbox"/> Channel 9: 2452MHz	<input type="checkbox"/> Ant1	<input checked="" type="checkbox"/> Ant2

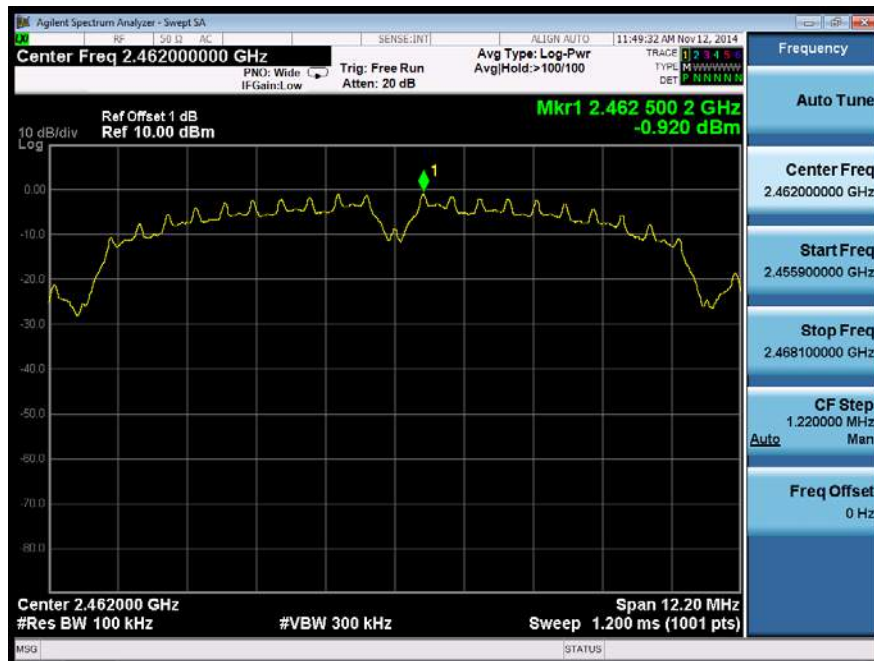

Unwanted Emissions In Non-Restricted Frequency Bands				
Test Model	<input checked="" type="checkbox"/> 802.11b	<input type="checkbox"/> 802.11g	<input type="checkbox"/> 802.11n(HT20)	<input type="checkbox"/> 802.11n(HT40)
	<input checked="" type="checkbox"/> Channel 11: 2462MHz	<input type="checkbox"/> Channel 9: 2452MHz	<input type="checkbox"/> Ant1	<input checked="" type="checkbox"/> Ant2



Band edge				
Test Model	<input checked="" type="checkbox"/> 802.11b	<input type="checkbox"/> 802.11g	<input type="checkbox"/> 802.11n(HT20)	<input type="checkbox"/> 802.11n(HT40)
	<input checked="" type="checkbox"/> Channel 11: 2462MHz	<input type="checkbox"/> Channel 9: 2452MHz	<input type="checkbox"/> Ant1	<input checked="" type="checkbox"/> Ant2



8.5 RADIATED SPURIOUS EMISSION

8.5.1 Applicable Standard

According to FCC Part 15.247(d) and 15.209 and KDB 558074 DTS 01 Meas. Guidance v03r02

8.5.2 Conformance Limit

According to FCC Part 15.247(d): radiated emissions which fall in the restricted bands, as defined in §15.205(a), must also comply with the radiated emission limits specified in §15.209(a) (see §15.205(c)).

According to FCC Part 15.205, Restricted bands

MHz	MHz	MHz	GHz
0.090-0.110	16.42-16.423	399.9-410	4.5-5.15
10.495-0.505	16.69475-16.69525	608-614	5.35-5.46
2.1735-2.1905	16.80425-16.80475	960-1240	7.25-7.75
4.125-4.128	25.5-25.67	1300-1427	8.025-8.5
4.17725-4.17775	37.5-38.25	1435-1626.5	9.0-9.2
4.20725-4.20775	73-74.6	1645.5-1646.5	9.3-9.5
6.215-6.218	74.8-75.2	1660-1710	10.6-12.7
6.26775-6.26825	123-138	2200-2300	14.47-14.5
8.291-8.294	149.9-150.05	2310-2390	15.35-16.2
8.362-8.366	156.52475-156.52525	2483.5-2500	17.7-21.4
8.37625-8.38675	156.7-156.9	2690-2900	22.01-23.12
8.41425-8.41475	162.0125-167.17	3260-3267	23.6-24.0
12.29-12.293	167.72-173.2	3332-3339	31.2-31.8
12.51975-12.52025	240-285	3345.8-3358	36.43-36.5
12.57675-12.57725	322-335.4	3600-4400	(2)
13.36-13.41			

According to FCC Part 15.205, the level of any transmitter spurious emission in Restricted bands shall not exceed the level of the emission specified in the following table

Restricted Frequency(MHz)	Field Strength ($\mu\text{V}/\text{m}$)	Field Strength ($\text{dB}\mu\text{V}/\text{m}$)	Measurement Distance
30-88	100	40	3
88-216	150	43.5	3
216-960	200	46	3
Above 960	500	54	3

8.5.3 Test Configuration

Test according to clause 7.2 radio frequency test setup 2

8.5.4 Test Procedure

This test is required for any spurious emission that falls in a Restricted Band, as defined in Section 15.205. It must be performed with the highest gain of each type of antenna proposed for use with the EUT. Use the following spectrum analyzer settings:

The EUT was placed on a turn table which is 0.8m above ground plane.

Maximum procedure was performed on the highest emissions to ensure EUT compliance.

Span = wide enough to fully capture the emission being measured

RBW = 1 MHz for $f \geq 1$ GHz (1GHz to 25GHz), 100 kHz for $f < 1$ GHz (30MHz to 1GHz)

VBW \geq RBW

Sweep = auto

Detector function = peak

Trace = max hold

Follow the guidelines in ANSI C63.4-1992 with respect to maximizing the emission by rotating the EUT, measuring the emission while the EUT is situated in three orthogonal planes (if appropriate), adjusting the measurement antenna height and polarization, etc. A pre-amp and a high pass filter are required for this test, in order to provide the measuring system with sufficient sensitivity. Allow the trace to stabilize. The peak reading of the emission, after being corrected by the antenna factor, cable loss, pre-amp gain, etc., is the peak field strength, which must comply with the limit specified in Section 15.35(b). Submit this data.

Now set the VBW to 10 Hz, while maintaining all of the other instrument settings. This peak level, once corrected, must comply with the limit specified in Section 15.209. If the dwell time per channel of the hopping signal is less than 100 ms, then the reading obtained with the 10 Hz VBW may be further adjusted by a “duty cycle correction factor”, derived from $20\log(\text{dwell time}/100 \text{ ms})$, in an effort to demonstrate compliance with the 15.209 limit. Submit this data.

Repeat above procedures until all frequency measured was complete.

8.5.5 Test Results

■ Spurious Emission Above 1GHz (1GHz to 25GHz)

All modes 2.4G 802.11b/g/n have been tested, and the worst result 802.11b recorded was report as below:

Temperature : 28°C Test Date : Nov. 5, 2014
 Humidity : 65 % Test By: King Kong
 Test mode: 802.11b Frequency: Channel 1: 2412MHz

Freq. (MHz)	Ant.Pol. H/V	Emission Level(dBuV/m)		Limit 3m(dBuV/m)		Over(dB)	
		PK	AV	PK	AV	PK	AV
4822.42	V	54.40	41.67	74.00	54.00	-19.60	-12.33
7235.23	V	51.54	39.39	74.00	54.00	-22.46	-14.61
9649.53	V	51.67	38.31	74.00	54.00	-22.33	-15.69
--	--	--	--	--	--	--	--
--	--	--	--	--	--	--	--
--	--	--	--	--	--	--	--
4822.49	H	55.48	42.46	74.00	54.00	-18.52	-11.54
7237.34	H	51.93	39.97	74.00	54.00	-22.07	-14.03
9646.58	H	47.23	34.61	74.00	54.00	-26.77	-19.39

Temperature : 28°C Test Date : Nov. 5, 2014
 Humidity : 65 % Test By: King Kong
 Test mode: 802.11b Frequency: Channel 6: 2437MHz

Freq. (MHz)	Ant.Pol. H/V	Emission Level(dBuV/m)		Limit 3m(dBuV/m)		Over(dB)	
		PK	AV	PK	AV	PK	AV
4873.28	V	55.56	41.93	74.00	54.00	-18.44	-12.07
7312.13	V	53.03	39.14	74.00	54.00	-20.97	-14.86
9746.90	V	51.87	38.60	74.00	54.00	-22.13	-15.40
--	--	--	--	--	--	--	--
--	--	--	--	--	--	--	--
--	--	--	--	--	--	--	--
4872.98	H	51.10	39.85	74.00	54.00	-22.90	-14.15
7311.89	H	51.91	38.98	74.00	54.00	-22.09	-15.02
9748.45	H	49.27	38.79	74.00	54.00	-24.73	-15.21

Temperature : 28°C Test Date : Nov. 5, 2014
 Humidity : 65 % Test By: King Kong
 Test mode: 802.11b Frequency: Channel 11: 2462MHz

Freq. (MHz)	Ant.Pol. H/V	Emission Level(dBuV/m)		Limit 3m(dBuV/m)		Over(dB)	
		PK	AV	PK	AV	PK	AV
4942.77	V	56.32	42.52	74.00	54.00	-17.68	-11.48
7461.88	V	52.65	40.26	74.00	54.00	-21.35	-13.74
9889.26	V	51.74	38.82	74.00	54.00	-22.26	-15.18
--	--	--	--	--	--	--	--
--	--	--	--	--	--	--	--
--	--	--	--	--	--	--	--
4942.96	H	54.61	41.87	74.00	54.00	-19.39	-12.13
7462.28	H	49.18	37.85	74.00	54.00	-24.82	-16.15
9889.50	H	46.62	31.86	74.00	54.00	-27.38	-22.14

- Note:** (1) All Readings are Peak Value (VBW=3MHz) and Peak Value (VBW=10Hz).
 (2) Emission Level= Reading Level+Probe Factor +Cable Loss.
 (3) Data of measurement within this frequency range shown "--" in the table above means the reading of emissions are attenuated more than 20dB below the permissible limits or the field strength is too small to be measured.

■ Spurious Emission in Restricted Band 2310-2390MHz and 2483.5-2500MHz

Temperature : 28°C Test Date : Nov. 5, 2014
 Humidity : 65 % Test By: King Kong
 Test mode: 802.11b Frequency: Channel 1: 2412MHz
 Antenna 1

Frequency (MHz)	Polarity	PK(dBuV/m) (VBW=3MHz)	Limit 3m (dBuV/m)	PK(dBuV/m) (VBW=3MHz)	Limit 3m (dBuV/m)
2390.00	H	54.45	74	53.00	54
2390.00	V	55.85	74	50.14	54

Temperature : 28°C Test Date : Nov. 5, 2014
 Humidity : 65 % Test By: King Kong
 Test mode: 802.11b Frequency: Channel 11: 2462MHz
 Antenna 1

Frequency (MHz)	Polarity	PK(dBuV/m) (VBW=3MHz)	Limit 3m (dBuV/m)	PK(dBuV/m) (VBW=3MHz)	Limit 3m (dBuV/m)
2484.50	H	54.06	74	50.20	54
2484.50	V	57.45	74	50.60	54

Temperature : 28°C Test Date : Nov. 5, 2014
 Humidity : 65 % Test By: King Kong
 Test mode: 802.11g Frequency: Channel 1: 2412MHz
 Antenna 1

Frequency (MHz)	Polarity	PK(dBuV/m) (VBW=3MHz)	Limit 3m (dBuV/m)	PK(dBuV/m) (VBW=3MHz)	Limit 3m (dBuV/m)
2390.00	H	62.11	74	52.10	54
2390.00	V	66.00	74	52.00	54

Temperature : 28°C Test Date : Nov. 5, 2014
 Humidity : 65 % Test By: King Kong
 Test mode: 802.11g Frequency: Channel 11: 2462MHz
 Antenna 1

Frequency (MHz)	Polarity	PK(dBuV/m) (VBW=3MHz)	Limit 3m (dBuV/m)	PK(dBuV/m) (VBW=3MHz)	Limit 3m (dBuV/m)
2484.50	H	66.75	74	50.20	54
2484.50	V	65.48	74	51.30	54

Temperature : 28°C Test Date : Nov. 5, 2014
 Humidity : 65 % Test By: King Kong
 Test mode: 802.11n (HT20) Frequency: Channel 1: 2412MHz
 Antenna 1

Frequency (MHz)	Polarity	PK(dBuV/m) (VBW=3MHz)	Limit 3m (dBuV/m)	PK(dBuV/m) (VBW=3MHz)	Limit 3m (dBuV/m)
2390.00	H	57.70	74	52.10	54
2390.00	V	68.15	74	51.10	54

Temperature : 28°C Test Date : Nov. 5, 2014
 Humidity : 65 % Test By: King Kong
 Test mode: 802.11 n (HT20) Frequency: Channel 11: 2462MHz
 Antenna 1

Frequency (MHz)	Polarity	PK(dBuV/m) (VBW=3MHz)	Limit 3m (dBuV/m)	PK(dBuV/m) (VBW=3MHz)	Limit 3m (dBuV/m)
2484.50	H	67.84	74	50.20	54
2484.50	V	63.05	74	50.16	54

Temperature : 28°C Test Date : Nov. 5, 2014
 Humidity : 65 % Test By: King Kong
 Test mode: 802.11 n (HT40) Frequency: Channel 3: 2422MHz
 Antenna 1

Frequency (MHz)	Polarity	PK(dBuV/m) (VBW=3MHz)	Limit 3m (dBuV/m)	PK(dBuV/m) (VBW=3MHz)	Limit 3m (dBuV/m)
2390.00	H	64.47	74	52.00	54
2390.00	V	63.15	74	51.02	54

Temperature : 28°C Test Date : Nov. 5, 2014
 Humidity : 65 % Test By: King Kong
 Test mode: 802.11 n (HT40) Frequency: Channel 9: 2452MHz
 Antenna 1

Frequency (MHz)	Polarity	PK(dBuV/m) (VBW=3MHz)	Limit 3m (dBuV/m)	PK(dBuV/m) (VBW=3MHz)	Limit 3m (dBuV/m)
2484.50	H	65.64	74	51.02	54
2484.50	V	63.58	74	50.16	54

Temperature : 28°C Test Date : Nov. 5, 2014
 Humidity : 65 % Test By: King Kong
 Test mode: 802.11b Frequency: Channel 1: 2412MHz
 Antenna 2

Frequency (MHz)	Polarity	PK(dBuV/m) (VBW=3MHz)	Limit 3m (dBuV/m)	PK(dBuV/m) (VBW=3MHz)	Limit 3m (dBuV/m)
2390.00	H	52.49	74	50.00	54
2390.00	V	54.47	74	50.10	54

Temperature : 28°C Test Date : Nov. 5, 2014
 Humidity : 65 % Test By: King Kong
 Test mode: 802.11b Frequency: Channel 11: 2462MHz
 Antenna 2

Frequency (MHz)	Polarity	PK(dBuV/m) (VBW=3MHz)	Limit 3m (dBuV/m)	PK(dBuV/m) (VBW=3MHz)	Limit 3m (dBuV/m)
2484.50	H	45.68	74	41.30	54
2484.50	V	59.18	74	50.20	54

Temperature : 28°C Test Date : Nov. 5, 2014
 Humidity : 65 % Test By: King Kong
 Test mode: 802.11g Frequency: Channel 1: 2412MHz
 Antenna 2

Frequency (MHz)	Polarity	PK(dBuV/m) (VBW=3MHz)	Limit 3m (dBuV/m)	PK(dBuV/m) (VBW=3MHz)	Limit 3m (dBuV/m)
2390.00	H	65.14	74	52.50	54
2390.00	V	69.17	74	52.10	54

Temperature : 28°C Test Date : Nov. 5, 2014
 Humidity : 65 % Test By: King Kong
 Test mode: 802.11g Frequency: Channel 11: 2462MHz
 Antenna 2

Frequency (MHz)	Polarity	PK(dBuV/m) (VBW=3MHz)	Limit 3m (dBuV/m)	PK(dBuV/m) (VBW=3MHz)	Limit 3m (dBuV/m)
2484.50	H	68.58	74	50.10	54
2484.50	V	70.15	74	52.10	54

Temperature : 28°C Test Date : Nov. 5, 2014
 Humidity : 65 % Test By: King Kong
 Test mode: 802.11n (HT20) Frequency: Channel 1: 2412MHz
 Antenna 2

Frequency (MHz)	Polarity	PK(dBuV/m) (VBW=3MHz)	Limit 3m (dBuV/m)	PK(dBuV/m) (VBW=3MHz)	Limit 3m (dBuV/m)
2390.00	H	68.84	74	50.10	54
2390.00	V	68.15	74	51.43	54

Temperature : 28°C Test Date : Nov. 5, 2014
 Humidity : 65 % Test By: King Kong
 Test mode: 802.11 n (HT20) Frequency: Channel 11: 2462MHz
 Antenna 2

Frequency (MHz)	Polarity	PK(dBuV/m) (VBW=3MHz)	Limit 3m (dBuV/m)	PK(dBuV/m) (VBW=3MHz)	Limit 3m (dBuV/m)
2484.50	H	64.15	74	49.15	54
2484.50	V	63.45	74	49.62	54

Temperature : 28°C Test Date : Nov. 5, 2014
 Humidity : 65 % Test By: King Kong
 Test mode: 802.11 n (HT40) Frequency: Channel 3: 2422MHz
 Antenna 2

Frequency (MHz)	Polarity	PK(dBuV/m) (VBW=3MHz)	Limit 3m (dBuV/m)	PK(dBuV/m) (VBW=3MHz)	Limit 3m (dBuV/m)
2390.00	H	64.50	74	50.25	54
2390.00	V	65.13	74	52.40	54

Temperature : 28°C Test Date : Nov. 5, 2014
 Humidity : 65 % Test By: King Kong
 Test mode: 802.11 n (HT40) Frequency: Channel 9: 2452MHz
 Antenna 2

Frequency (MHz)	Polarity	PK(dBuV/m) (VBW=3MHz)	Limit 3m (dBuV/m)	PK(dBuV/m) (VBW=3MHz)	Limit 3m (dBuV/m)
2484.50	H	68.15	74	52.10	54
2484.50	V	71.60	74	52.30	54

Temperature : 28°C Test Date : Nov. 5, 2014
 Humidity : 65 % Test By: King Kong
 Test mode: 802.11 n (HT40) Frequency: Channel 3: 2422MHz
 Antenna 1+2

Frequency (MHz)	Polarity	PK(dBuV/m) (VBW=3MHz)	Limit 3m (dBuV/m)	PK(dBuV/m) (VBW=3MHz)	Limit 3m (dBuV/m)
2390.00	H	70.25	74	51.42	54
2390.00	V	68.15	74	51.20	54

Temperature : 28°C Test Date : Nov. 5, 2014
 Humidity : 65 % Test By: King Kong
 Test mode: 802.11 n (HT40) Frequency: Channel 9: 2452MHz
 Antenna 1+2

Frequency (MHz)	Polarity	PK(dBuV/m) (VBW=3MHz)	Limit 3m (dBuV/m)	PK(dBuV/m) (VBW=3MHz)	Limit 3m (dBuV/m)
2484.50	H	69.23	74	51.10	54
2484.50	V	62.15	74	50.03	54

- Note:** (1) All Readings are Peak Value (VBW=3MHz) and Peak Value (VBW=10Hz).
 (2) Emission Level= Reading Level+Probe Factor +Cable Loss.
 (3) Data of measurement within this frequency range shown "--" in the table above means the reading of emissions are attenuated more than 20dB below the permissible limits or the field strength is too small to be measured.

All the modulation modes(11b/g/n mdoe) were tested, the data of the worst mode(11b mode) are described in the following table

Spurious Emission in Restricted Band 2310-2390MHz				
Test Model	<input checked="" type="checkbox"/> 802.11b	<input type="checkbox"/> 802.11g	<input type="checkbox"/> 802.11n(HT20)	<input type="checkbox"/> 802.11n(HT40)
	<input checked="" type="checkbox"/> Channel 1: 2412MHz	<input type="checkbox"/> Channel 3: 2422MHz		Polarity: H
	<input checked="" type="checkbox"/> Ant1	<input type="checkbox"/> Ant2	<input type="checkbox"/> Ant1+2	

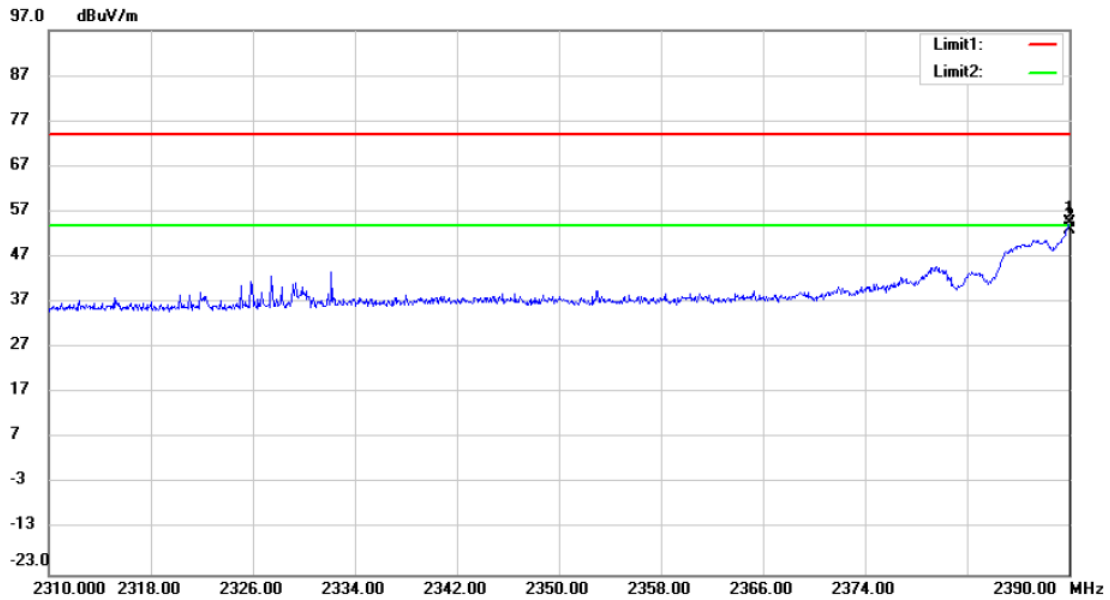

Site 3m Chamber #3 Polarization: **Horizontal** Temperature: 24 C
 Limit: (RE)FCC PART 15 CLASS B Power: Humidity: 53 %

Spurious Emission in Restricted Band 2483.5-2500MHz				
Test Model	<input checked="" type="checkbox"/> 802.11b	<input type="checkbox"/> 802.11g	<input type="checkbox"/> 802.11n(HT20)	<input type="checkbox"/> 802.11n(HT40)
	<input checked="" type="checkbox"/> Channel 1: 2412MHz	<input type="checkbox"/> Channel 3: 2422MHz		Polarity: V
	<input checked="" type="checkbox"/> Ant1	<input type="checkbox"/> Ant2	<input type="checkbox"/> Ant1+2	

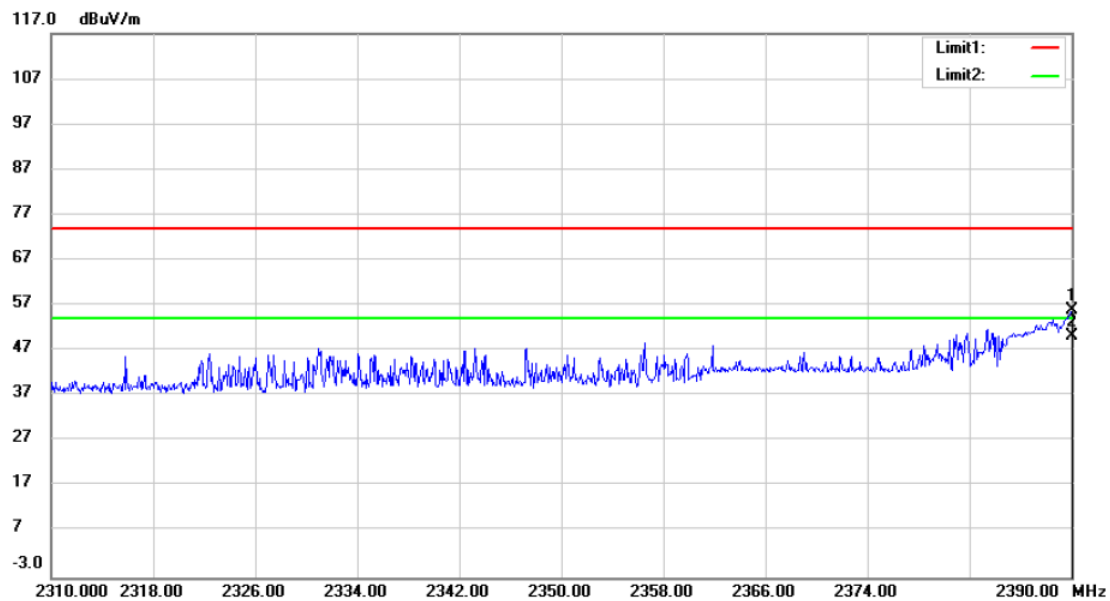

Site 3m Chamber #3 Polarization: **Vertical** Temperature: 24 C
 Limit: (RE)FCC PART 15 CLASS B Power: Humidity: 53 %

Spurious Emission in Restricted Band 2310-2390MHz

Test Model	<input checked="" type="checkbox"/> 802.11b	<input type="checkbox"/> 802.11g	<input type="checkbox"/> 802.11n(HT20)	<input type="checkbox"/> 802.11n(HT40)
	<input checked="" type="checkbox"/> Channel 11: 2462MHz	<input type="checkbox"/> Channel 9: 2452MHz		
	<input checked="" type="checkbox"/> Ant1	<input type="checkbox"/> Ant2	<input type="checkbox"/> Ant1+2	

Polarity: H

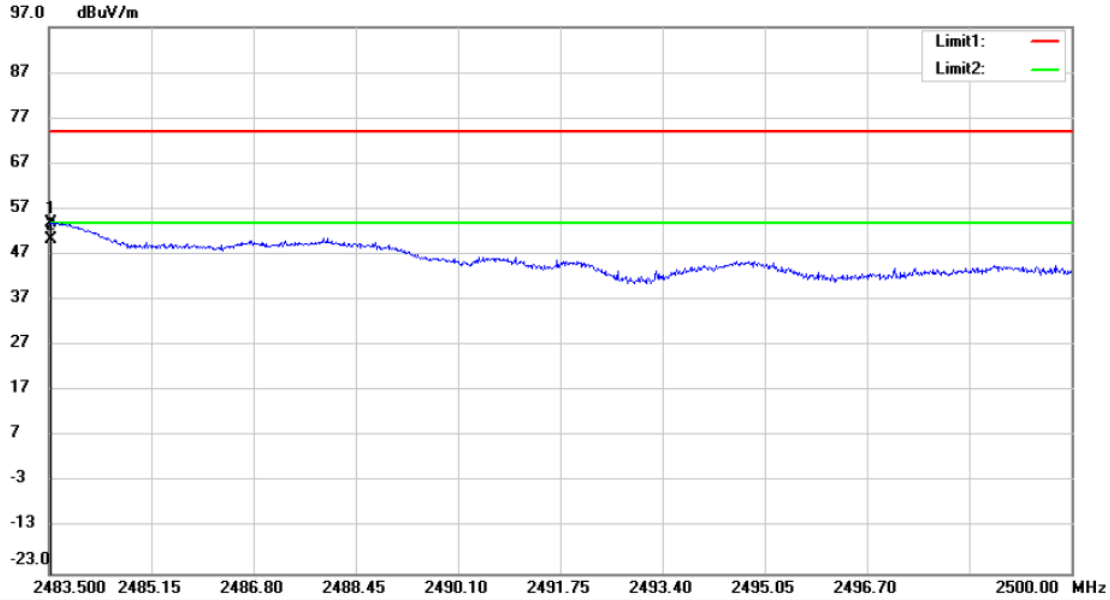

Site 3m Chamber #3 Polarization: **Horizontal** Temperature: 24 C
 Limit: (RE)FCC PART 15 CLASS B Power: Humidity: 53 %

Spurious Emission in Restricted Band 2483.5-2500MHz

Test Model	<input type="checkbox"/> 802.11b	<input type="checkbox"/> 802.11g	<input type="checkbox"/> 802.11n(HT20)	<input type="checkbox"/> 802.11n(HT40)
	<input checked="" type="checkbox"/> Channel 11: 2462MHz	<input type="checkbox"/> Channel 9: 2452MHz		
	<input checked="" type="checkbox"/> Ant1	<input type="checkbox"/> Ant2	<input type="checkbox"/> Ant1+2	

Polarity: V

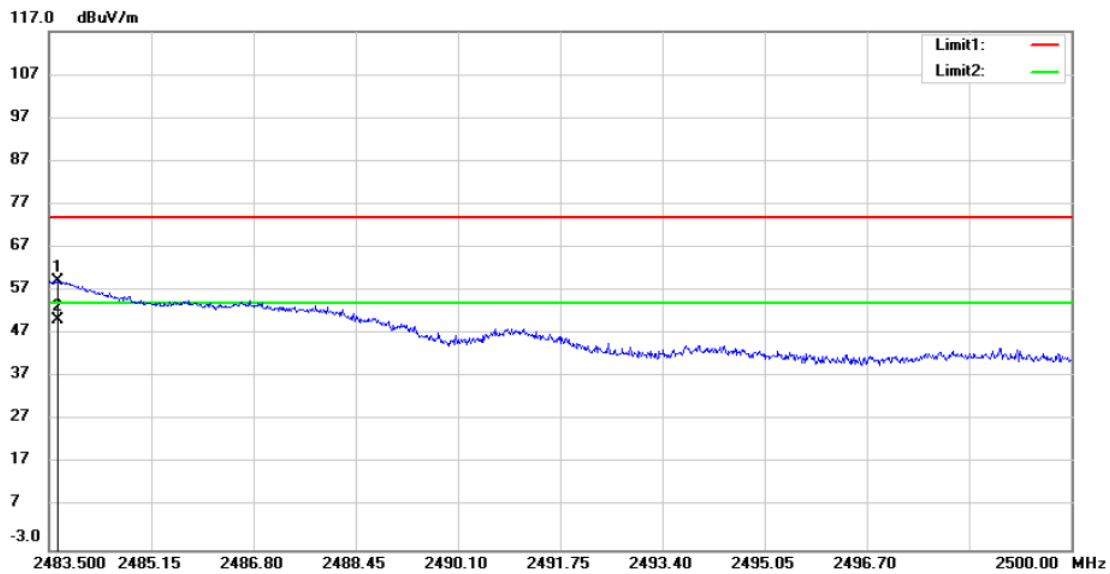

Site 3m Chamber #3 Polarization: **Vertical** Temperature: 24 C
 Limit: (RE)FCC PART 15 CLASS B Power: Humidity: 53 %

Spurious Emission in Restricted Band 2310-2390MHz

Test Model	<input checked="" type="checkbox"/> 802.11b	<input type="checkbox"/> 802.11g	<input type="checkbox"/> 802.11n(HT20)	<input type="checkbox"/> 802.11n(HT40)
	<input checked="" type="checkbox"/> Channel 1: 2412MHz	<input type="checkbox"/> Channel 3: 2422MHz		Polarity: H
	<input type="checkbox"/> Ant1	<input checked="" type="checkbox"/> Ant2	<input type="checkbox"/> Ant1+2	

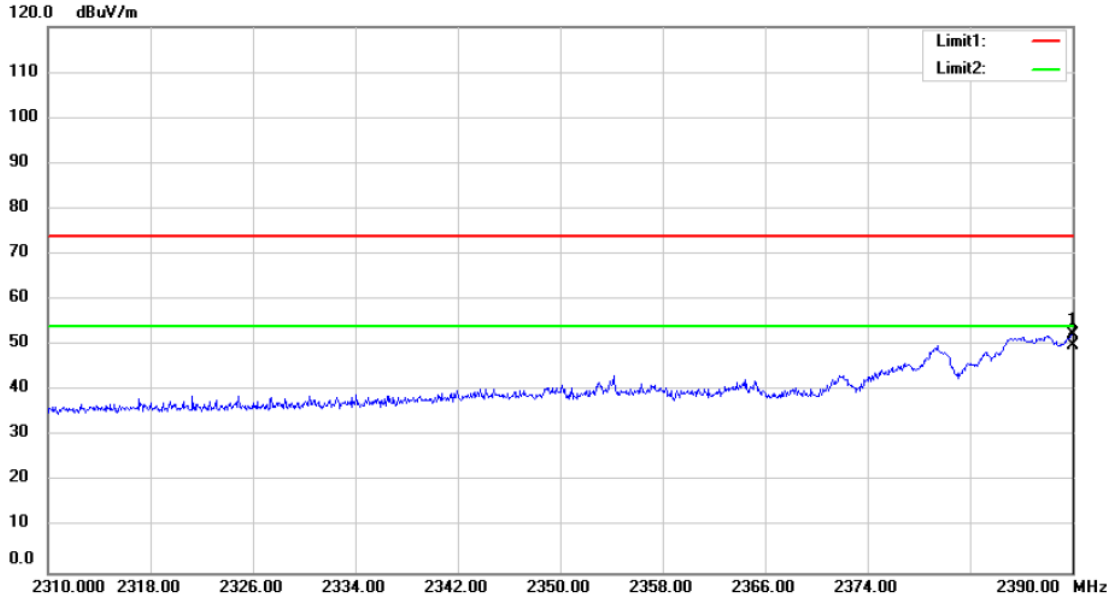

Site 3m Chamber #3 Polarization: **Horizontal** Temperature: 24 C
 Limit: (RE)FCC PART 15 CLASS B Power: Humidity: 53 %

Spurious Emission in Restricted Band 2483.5-2500MHz

Test Model	<input checked="" type="checkbox"/> 802.11b	<input type="checkbox"/> 802.11g	<input type="checkbox"/> 802.11n(HT20)	<input type="checkbox"/> 802.11n(HT40)
	<input checked="" type="checkbox"/> Channel 1: 2412MHz	<input type="checkbox"/> Channel 3: 2422MHz		Polarity: V
	<input type="checkbox"/> Ant1	<input checked="" type="checkbox"/> Ant2	<input type="checkbox"/> Ant1+2	

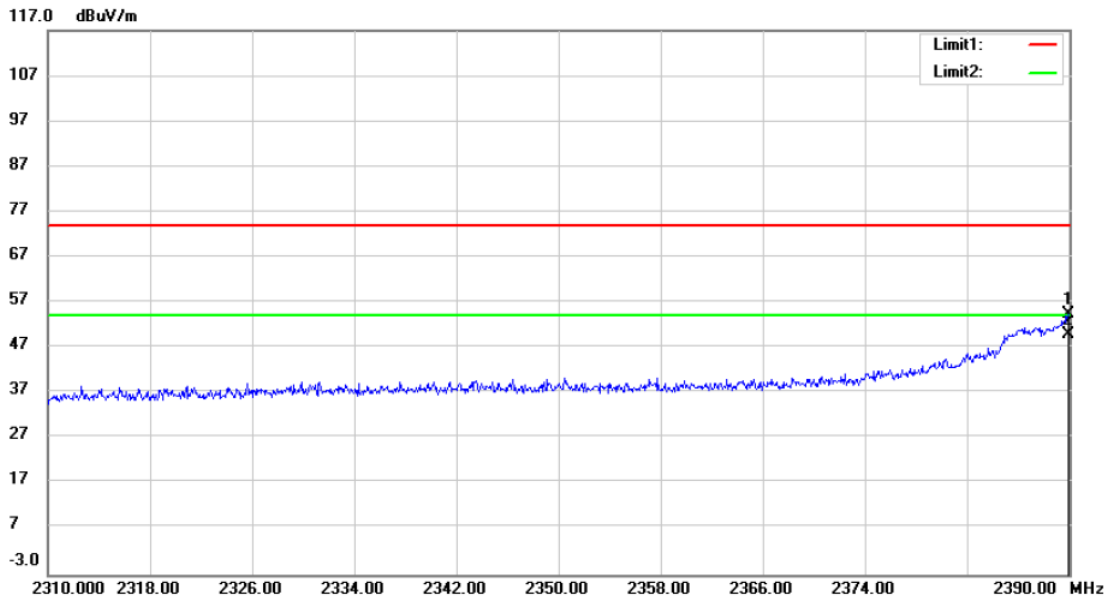

Site 3m Chamber #3 Polarization: **Vertical** Temperature: 24 C
 Limit: (RE)FCC PART 15 CLASS B Power: Humidity: 53 %

Spurious Emission in Restricted Band 2310-2390MHz

Test Model 802.11b 802.11g 802.11n(HT20) 802.11n(HT40)
Channel 11: 2462MHz Channel 9: 2452MHz Polarity: H
Ant1 Ant2 Ant1+2

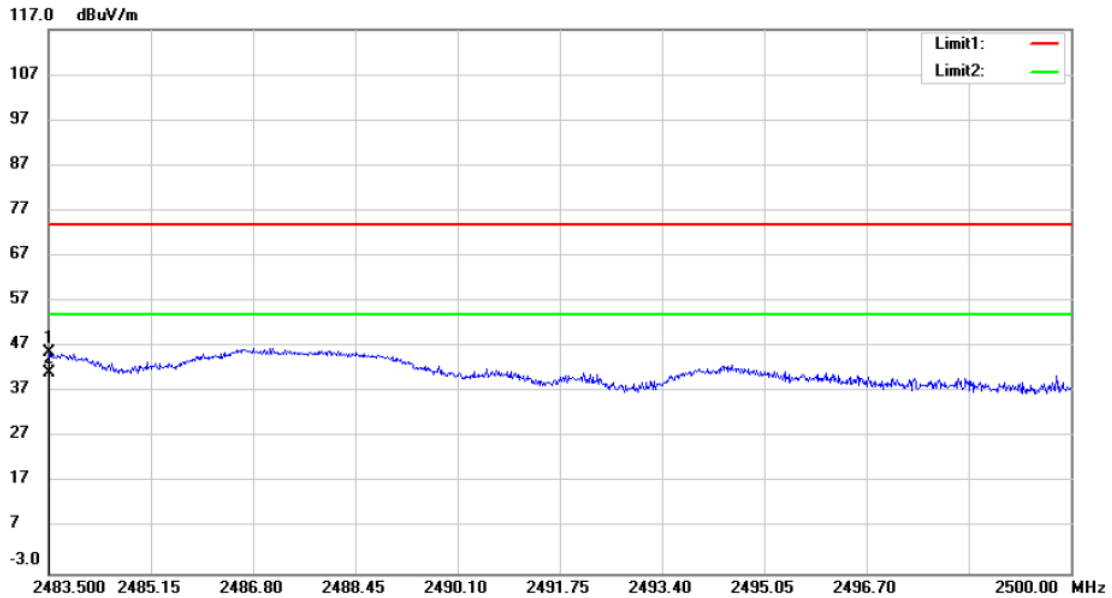

Site 3m Chamber #3 Polarization: *Horizontal* Temperature: 24 C
 Limit: (RE)FCC PART 15 CLASS B Power: Humidity: 53 %

Spurious Emission in Restricted Band 2483.5-2500MHz

Test Model 802.11b 802.11g 802.11n(HT20) 802.11n(HT40)
Channel 11: 2462MHz Channel 9: 2452MHz Polarity: V
Ant1 Ant2 Ant1+2

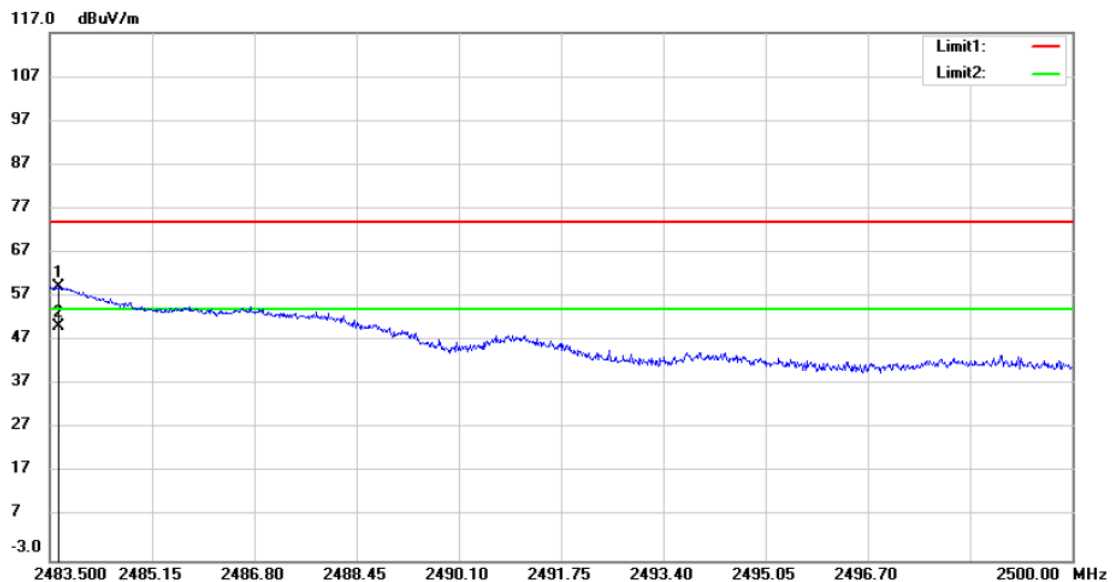

Site 3m Chamber #3 Polarization: *Vertical* Temperature: 24 C
 Limit: (RE)FCC PART 15 CLASS B Power: Humidity: 53 %

■ Spurious Emission below 1GHz (30MHz to 1GHz)

All the modulation modes(11b/g/n mdoe) were tested, the data of the worst mode(11b mode) are described in the following table

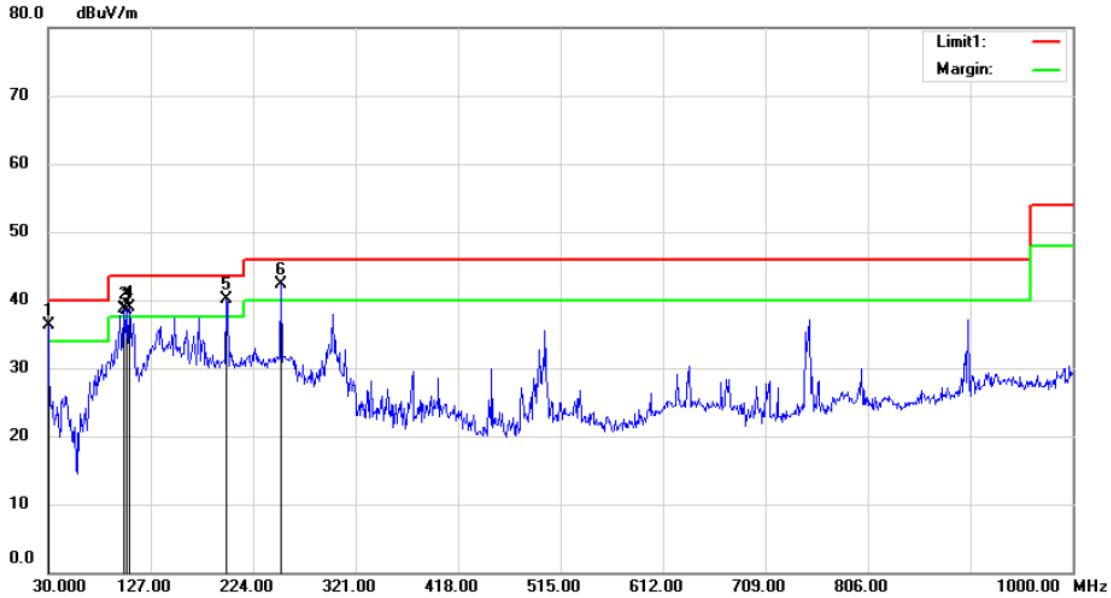

Site 3m Chamber #1 Polarization: *Horizontal* Temperature: 24 C
 Limit: (RE)FCC PART 15 CLASS B Power: AC 120V/60Hz Humidity: 53 %
 EUT: 300Mbps Wireless N Router
 M/N: N302R Plus,IP04213
 Mode:2412
 Note:

No.	Mk.	Freq.	Reading Level	Correct Factor	Measurement	Limit	Over	Antenna Height	Table Degree	
		MHz	dBuV	dB	dBuV/m	dBuV/m	dB	cm	degree	Comment
1	!	30.0000	50.73	-14.42	36.31	40.00	-3.69	QP		
2	!	101.7800	52.13	-13.45	38.68	43.50	-4.82	QP		
3	!	104.6900	51.94	-13.38	38.56	43.50	-4.94	QP		
4	!	106.6300	52.26	-13.42	38.84	43.50	-4.66	QP		
5	*	198.7800	55.64	-15.57	40.07	43.50	-3.43	QP		
6	!	250.1900	54.22	-11.93	42.29	46.00	-3.71	QP		

*:Maximum data x:Over limit !:over margin

Operator: GMR

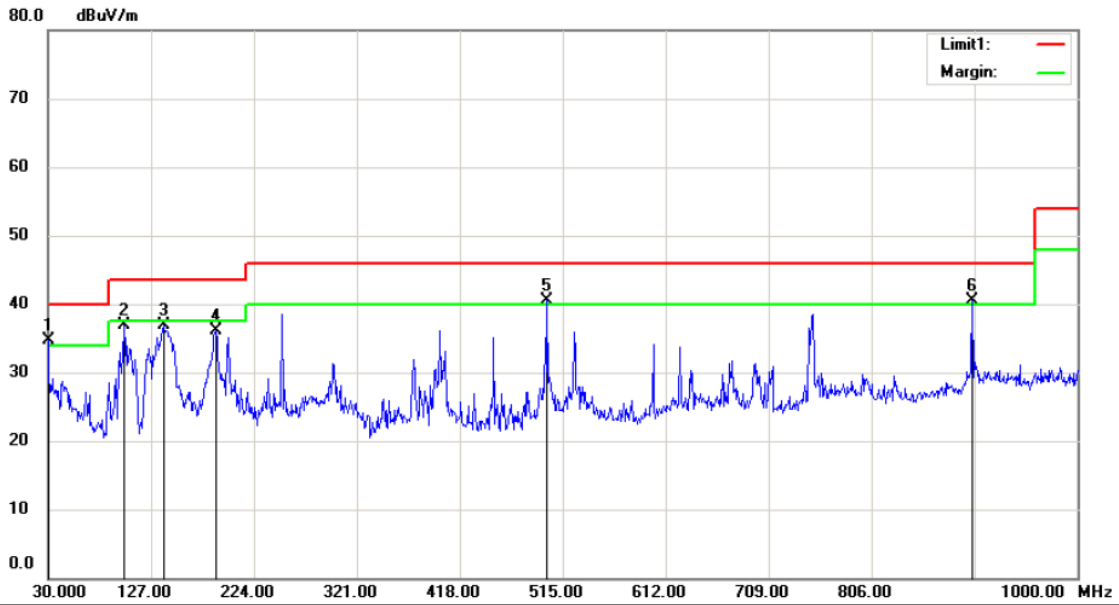

Site 3m Chamber #1 Polarization: *Vertical* Temperature: 24 C
 Limit: (RE)FCC PART 15 CLASS B Power: AC 120V/60Hz Humidity: 53 %
 EUT: 300Mbps Wireless N Router
 M/N: N302R Plus,IP04213
 Mode:2412
 Note:

No.	Mk.	Freq.	Reading Level	Correct Factor	Measurement	Limit	Over	Antenna Height	Table Degree	
		MHz	dBuV	dB	dBuV/m	dBuV/m	dB	cm	degree	Comment
1	*	30.0000	49.18	-14.42	34.76	40.00	-5.24	QP		
2		101.7800	50.35	-13.45	36.90	43.50	-6.60	QP		
3		138.6400	53.88	-16.94	36.94	43.50	-6.56	QP		
4		188.1100	52.35	-16.23	36.12	43.50	-7.38	QP		
5	!	500.4500	47.58	-7.17	40.41	46.00	-5.59	QP		
6	!	901.0600	41.39	-0.92	40.47	46.00	-5.53	QP		

*:Maximum data x:Over limit !:over margin

Operator: GMR

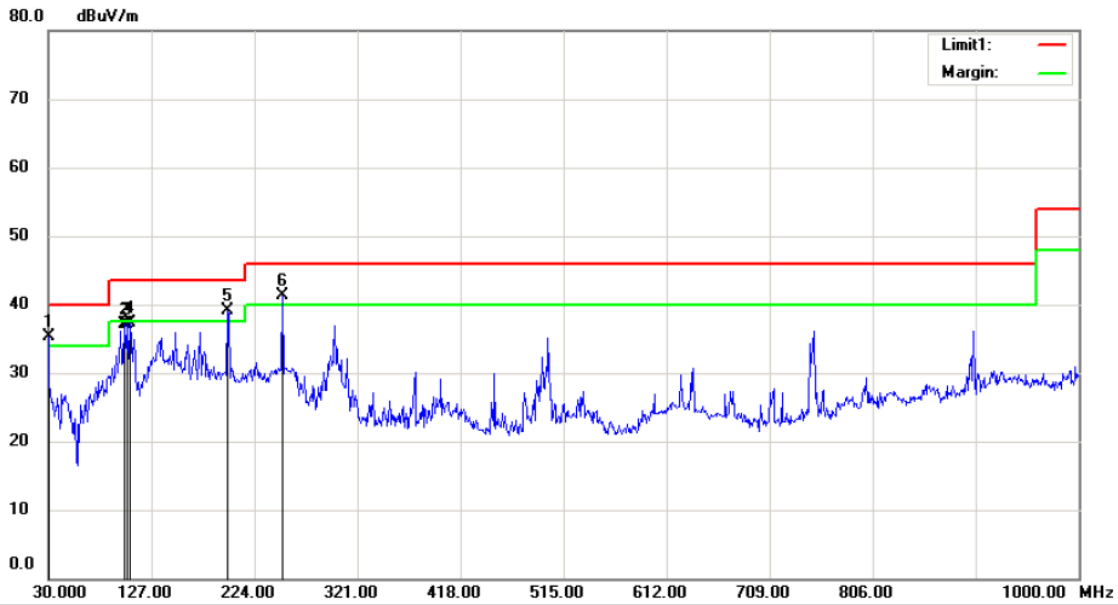

Site 3m Chamber #1 Polarization: **Horizontal** Temperature: 24 C
 Limit: (RE)FCC PART 15 CLASS B Power: AC 120V/60Hz Humidity: 53 %
 EUT: 300Mbps Wireless N Router
 M/N: N302R Plus,IP04213
 Mode:2437
 Note:

No.	Mk.	Freq.	Reading Level	Correct Factor	Measurement	Limit	Over	Antenna Height	Table Degree		
		MHz	dBuV	dB	dBuV/m	dBuV/m	dB	Detector	cm	degree	Comment
1	!	30.0000	49.73	-14.42	35.31	40.00	-4.69	QP			
2		101.7800	50.63	-13.45	37.18	43.50	-6.32	QP			
3		104.6900	50.44	-13.38	37.06	43.50	-6.44	QP			
4		106.6300	50.76	-13.42	37.34	43.50	-6.16	QP			
5	*	198.7800	54.64	-15.57	39.07	43.50	-4.43	QP			
6	!	250.1900	53.22	-11.93	41.29	46.00	-4.71	QP			

*:Maximum data x:Over limit !:over margin

Operator: GMR

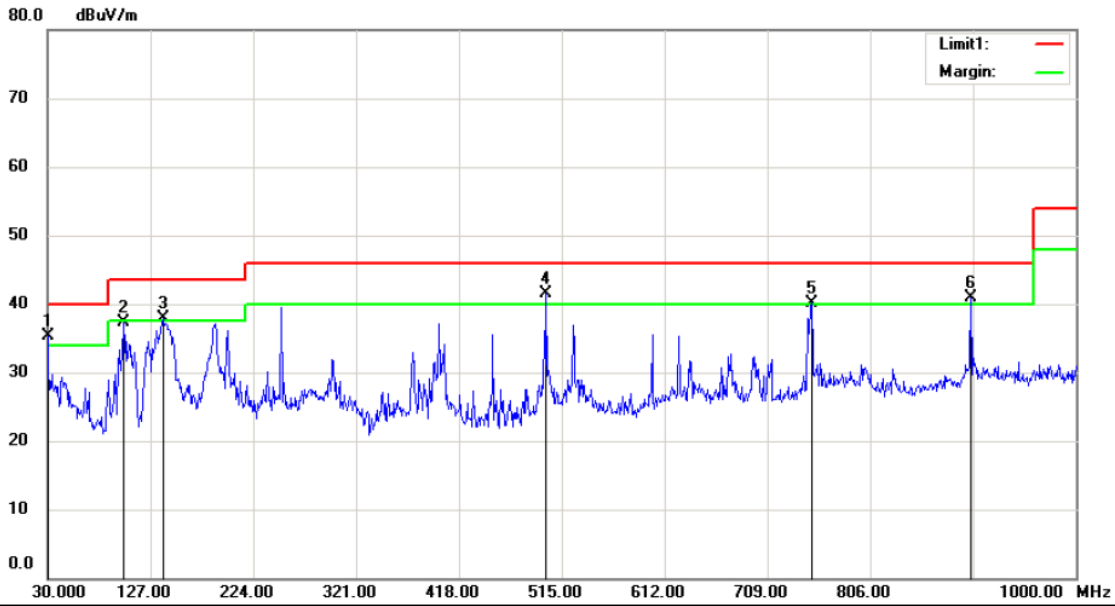

Site 3m Chamber #1 Polarization: **Vertical** Temperature: 24 C
 Limit: (RE)FCC PART 15 CLASS B Power: AC 120V/60Hz Humidity: 53 %
 EUT: 300Mbps Wireless N Router
 M/N: N302R Plus,IP04213
 Mode:2437
 Note:

No.	Mk.	Freq.	Reading Level	Correct Factor	Measurement	Limit	Over	Antenna Height	Table Degree	
		MHz	dBuV	dB	dBuV/m	dBuV/m	dB	cm	degree	Comment
1	!	30.0000	49.68	-14.42	35.26	40.00	-4.74	QP		
2		101.7800	50.85	-13.45	37.40	43.50	-6.10	QP		
3	!	138.6400	54.88	-16.94	37.94	43.50	-5.56	QP		
4	*	500.4500	48.58	-7.17	41.41	46.00	-4.59	QP		
5	!	750.7100	43.14	-3.13	40.01	46.00	-5.99	QP		
6	!	901.0600	41.89	-0.92	40.97	46.00	-5.03	QP		

*:Maximum data x:Over limit !:over margin

Operator: GMR

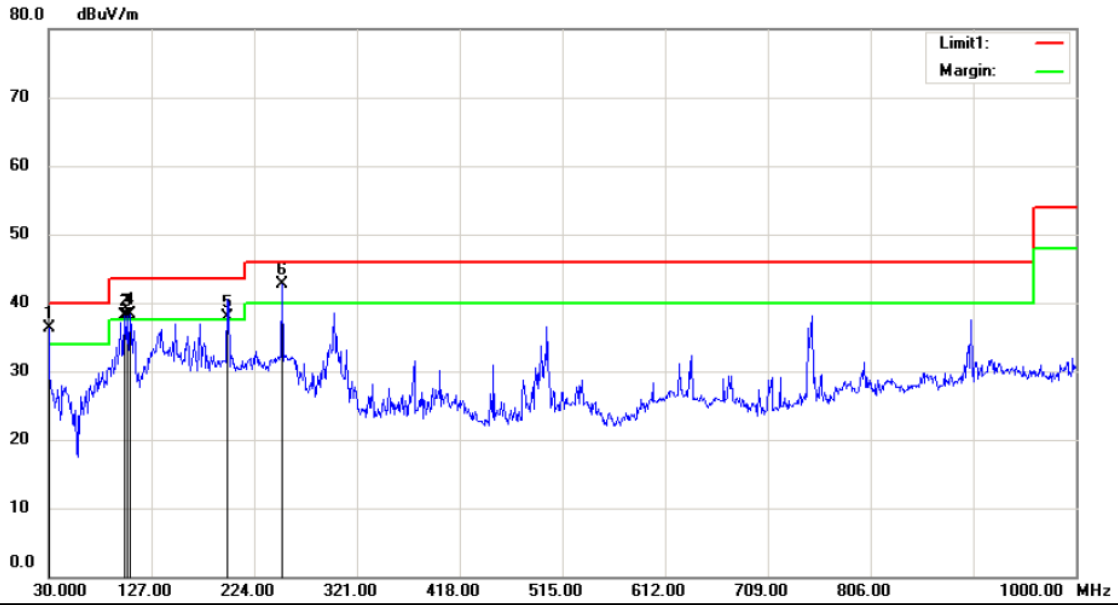

Site 3m Chamber #1 Polarization: *Horizontal* Temperature: 24 C
 Limit: (RE)FCC PART 15 CLASS B Power: AC 120V/60Hz Humidity: 53 %
 EUT: 300Mbps Wireless N Router
 M/N: N302R Plus,IP04213
 Mode:TX 2462
 Note:

No.	Mk.	Freq. MHz	Reading Level dBuV	Correct Factor dB	Measure- ment dBuV/m	Limit dBuV/m	Over dB	Antenna Height cm	Table Degree	Comment
1	!	30.0000	50.73	-14.42	36.31	40.00	-3.69	QP		
2	!	101.7800	51.63	-13.45	38.18	43.50	-5.32	QP		
3	!	104.6900	51.44	-13.38	38.06	43.50	-5.44	QP		
4	!	106.6300	51.76	-13.42	38.34	43.50	-5.16	QP		
5	!	198.7800	53.57	-15.57	38.00	43.50	-5.50	QP		
6	*	250.1900	54.72	-11.93	42.79	46.00	-3.21	QP		

*:Maximum data x:Over limit !:over margin

Operator: GMR

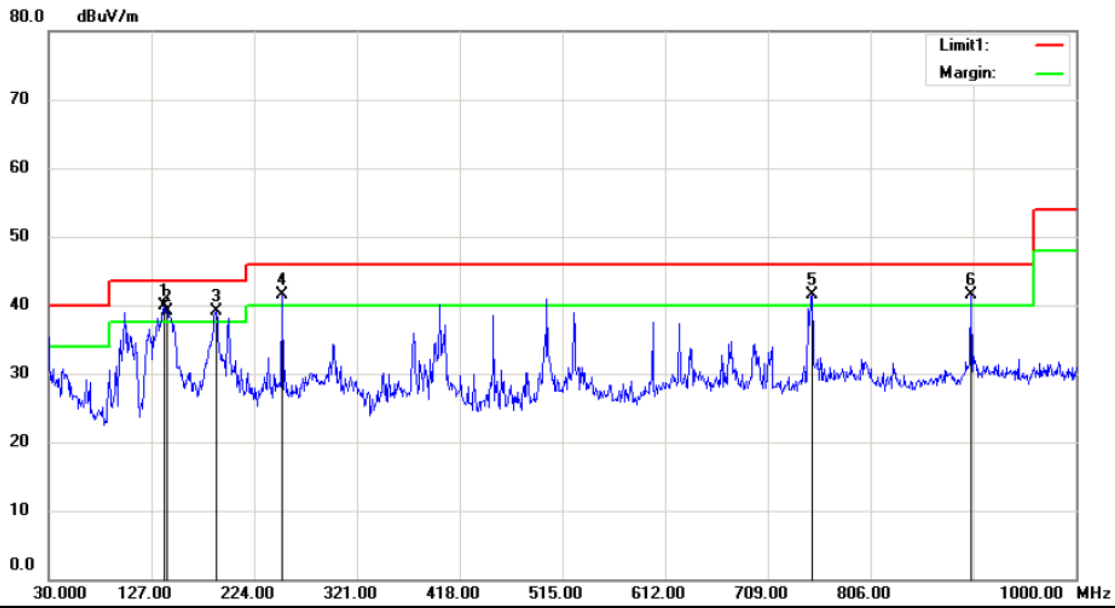

Site 3m Chamber #1 Polarization: **Vertical** Temperature: 24 C
 Limit: (RE)FCC PART 15 CLASS B Power: AC 120V/60Hz Humidity: 53 %
 EUT: 300Mbps Wireless N Router
 M/N: N302R Plus,IP04213
 Mode:TX 2462
 Note:

No.	Mk.	Freq.	Reading Level	Correct Factor	Measurement	Limit	Over	Antenna Height	Table Degree	
		MHz	dBuV	dB	dBuV/m	dBuV/m	dB	cm	degree	Comment
1	*	138.6400	56.88	-16.94	39.94	43.50	-3.56	QP		
2	!	141.5500	56.16	-17.15	39.01	43.50	-4.49	QP		
3	!	188.1100	55.35	-16.23	39.12	43.50	-4.38	QP		
4	!	250.1900	53.41	-11.93	41.48	46.00	-4.52	QP		
5	!	750.7100	44.64	-3.13	41.51	46.00	-4.49	QP		
6	!	901.0600	42.39	-0.92	41.47	46.00	-4.53	QP		

*:Maximum data x:Over limit !:over margin

Operator: GMR

8.6 CONDUCTED EMISSIONS TEST

8.6.1 Applicable Standard

According to FCC Part 15.207(a)

8.6.2 Conformance Limit

Frequency(MHz)	Conducted Emission Limit	
	Quasi-peak	Average
0.15-0.5	66-56	56-46
0.5-5.0	56	46
5.0-30.0	60	50

Note: 1. The lower limit shall apply at the transition frequencies
2. The limit decreases in line with the logarithm of the frequency in the range of 0.15 to 0.50MHz.

8.6.3 Test Configuration

Test according to clause 7.3 conducted emission test setup

8.6.4 Test Procedure

The EUT was placed on a table which is 0.8m above ground plane.
Maximum procedure was performed on the highest emissions to ensure EUT compliance.
Repeat above procedures until all frequency measured were complete.

8.6.5 Test Results

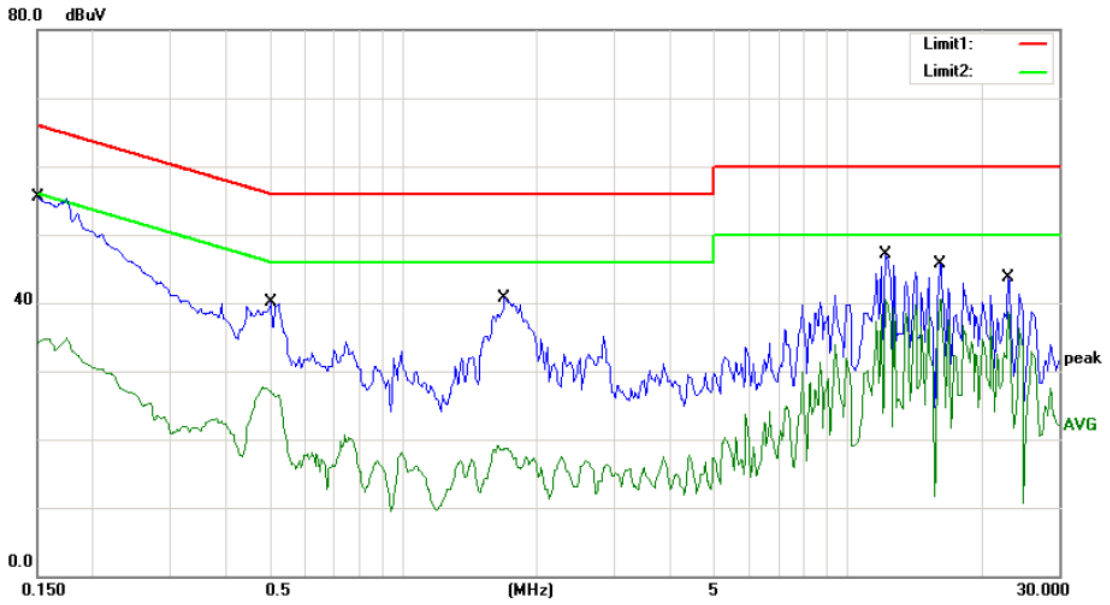

Site Conduction #2
 Limit: (CE)FCC PART 15 class B_QP
 EUT: 300Mbps Wireless N Router
 M/N: N302R Plus,IP04213
 Mode: ON
 Note:

Phase: **L1** Temperature: 26
 Power: AC 120V/60Hz Humidity: 55 %

No. Mk.	Freq. MHz	Reading Level dBuV	Correct Factor dB	Measure- ment dBuV	Limit dBuV	Over dB	Detector	Comment
1	0.1500	55.52	0.00	55.52	66.00	-10.48	QP	
2	0.1500	34.88	0.00	34.88	56.00	-21.12	AVG	
3	0.5050	40.05	0.00	40.05	56.00	-15.95	QP	
4	0.5050	27.64	0.00	27.64	46.00	-18.36	AVG	
5	1.6950	40.77	0.00	40.77	56.00	-15.23	QP	
6	1.6950	19.09	0.00	19.09	46.00	-26.91	AVG	
7	12.2000	47.15	0.00	47.15	60.00	-12.85	QP	
8	12.2000	40.45	0.00	40.45	50.00	-9.55	AVG	
9	16.2250	45.65	0.00	45.65	60.00	-14.35	QP	
10 *	16.2250	40.51	0.00	40.51	50.00	-9.49	AVG	
11	23.1250	43.78	0.00	43.78	60.00	-16.22	QP	
12	23.1250	38.71	0.00	38.71	50.00	-11.29	AVG	

*:Maximum data x:Over limit !:over margin Comment: Factor build in receiver. Operator: WHT

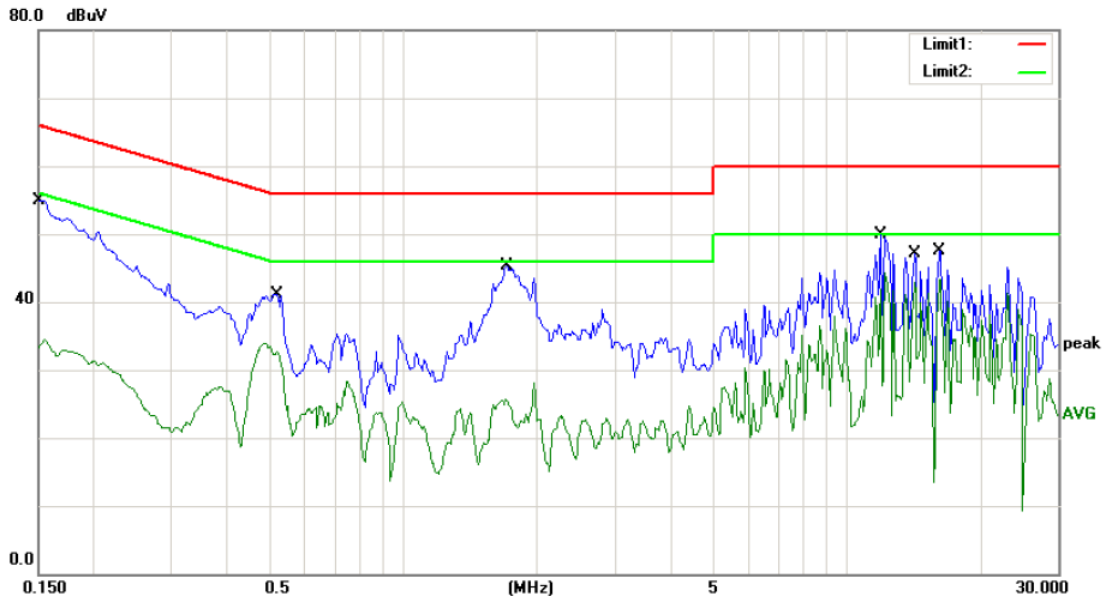

Site Conduction #2
 Limit: (CE)FCC PART 15 class B_QP
 EUT: 300Mbps Wireless N Router
 M/N: N302R Plus,IP04213
 Mode: ON
 Note:

Phase: **N** Temperature: 26
 Power: AC 120V/60Hz Humidity: 55 %

No.	Mk.	Freq.	Reading Level	Correct Factor	Measurement	Limit	Over	Detector	Comment
		MHz	dBuV	dB	dBuV	dBuV	dB		
1		0.1500	54.92	0.00	54.92	66.00	-11.08	QP	
2		0.1500	34.44	0.00	34.44	56.00	-21.56	AVG	
3		0.5200	41.12	0.00	41.12	56.00	-14.88	QP	
4		0.5200	33.96	0.00	33.96	46.00	-12.04	AVG	
5		1.7071	45.39	0.00	45.39	56.00	-10.61	QP	
6		1.7071	28.04	0.00	28.04	46.00	-17.96	AVG	
7		11.9500	49.84	0.00	49.84	60.00	-10.16	QP	
8	*	11.9500	44.22	0.00	44.22	50.00	-5.78	AVG	
9		14.2750	47.14	0.00	47.14	60.00	-12.86	QP	
10		14.2750	39.82	0.00	39.82	50.00	-10.18	AVG	
11		16.2250	47.51	0.00	47.51	60.00	-12.49	QP	
12		16.2250	43.22	0.00	43.22	50.00	-6.78	AVG	

*:Maximum data x:Over limit !:over margin Comment: Factor build in receiver. Operator: WHT

8.7 ANTENNA APPLICATION

8.7.1 Antenna Requirement

Standard	Requirement
FCC CRF Part 15.203	An intentional radiator shall be designed to ensure that no antenna other than that furnished by the responsible party shall be used with the device. The use of a permanently attached antenna or of an antenna that uses a unique coupling to the intentional radiator shall be considered sufficient to comply with the provisions of this section. The manufacturer may design the unit so that a broken antenna can be replaced by the user, but the use of a standard antenna jack or electrical connector is prohibited. This requirement does not apply to carrier current devices or to devices operated under the provisions of §15.211, §15.213, §15.217, §15.219, or §15.221. Further, this requirement does not apply to intentional radiators that must be professionally installed, such as perimeter protection systems and some field disturbance sensors, or to other intentional radiators which, in accordance with §15.31(d), must be measured at the installation site. However, the installer shall be responsible for ensuring that the proper antenna is employed so that the limits in this part are not exceeded.

For intentional device, according to FCC 47 CFR Section 15.203, an intentional radiator shall be designed to ensure that no antenna other than that furnished by the responsible party shall be used with the device. And according to FCC 47 CFR Section 15.247 (b), if transmitting antennas of directional gain greater than 6dBi are used, the power shall be reduced by the amount in dB that the directional gain of the antenna exceeds 6dBi.

The EUT has 3 antennas(2TX2RX): a chip antenna for 2.4G WIFI, the gain is 5.0 dBi;
 a chip antenna for 2.4G WIFI, the gain is 5.0 dBi;
 a chip antenna for 2.4G WIFI, the gain is 5.0 dBi;

Note:Antenna use a permanently attached antenna which is not replaceable.
 which in accordance to section 15.203, please refer to the internal photos.

8.7.2 Result

PASS.