

RADIO REPORT FCC 47 CFR Part 15C ISED Canada RSS-247 Digital transmission systems operating within the 2400.0 MHz - 2483.5 MHz band	
Report Reference No	G0M-2103-9685-TFC247ZB-V01
Testing Laboratory	Eurofins Product Service GmbH
Address	Storkower Str. 38c 15526 Reichenwalde Germany
Accreditation	 <p>DAkkS - Registration number : D-PL-12092-01-03 (ISED) ISED Testing Laboratory site: 3470A DAkkS - Registration number : D-PL-12092-01-04 (FCC) FCC Filed Test Laboratory, Reg.-No.: 96970</p>
Applicant	Dräger Safety AG & Co. KGaA
Address	Revalstraße 1 23560 Lübeck GERMANY
Test Specification	47 CFR Part 15C RSS-247, Issue 2, 2017-02 RSS-Gen, Issue 5, Amendment 2, 2021-02
Non-Standard Test Method	None
Equipment under Test (EUT):	
Product Description	Fixed Gas Detector
Model(s)	Polytron 6100 EC WL
Additional Model(s)	None
Brand Name(s)	None
Hardware Version(s)	RC003
Software Version(s)	Transmitter: P6100 V1.5.0, Centro FW v1.5.02c, Bootloader V2.5.0, SW Telit BLT V3.12.002
FCC ID	X6O-RC003
IC	5895F-RC003
Test Result	PASSED

Possible test case verdicts:		
Required by standard but not tested	N/T	
Not required by standard	N/R	
Not applicable to EUT	N/A	
Test object does meet the requirement	P(PASS)	
Test object does not meet the requirement	F(FAIL)	
Testing:		
Test Lab Temperature	20 °C - 30 °C	
Test Lab Humidity	25 % - 55 %	
Date of receipt of test item	2021-04-06	
Report:		
Compiled by	Florian Voigt	
Tested by (+ signature) (Responsible for Test)	Florian Voigt	
Approved by (+ signature) (Deputy Head of Lab)	Toralf Jahn	
Date of Issue	2021-11-18	
Total number of pages	55	
General Remarks:		
<p>The test results presented in this report relate only to the object tested.</p> <p>The results contained in this report reflect the results for this particular model and serial number. It is the responsibility of the manufacturer to ensure that all production models meet the intent of the requirements detailed within this report.</p> <p>This report shall not be reproduced, except in full, without the written approval of the Issuing testing laboratory.</p>		
Additional Comments:		
<p>There are multiple antennas associated to the EUT. EUT is tested with antenna Yokogawa, F9915KW. There are 2 more additional antennas listed, which are of same kind.</p>		

ADDITIONAL VARIANTS

Additional Variants (not tested and not evaluated variants)		
Not-tested Variant	Description	
1	Product Type Description	Polytron Repeater WirelessHART
	Model name	Polytron Repeater WirelessHART
	Brand name	
	Hardware Version	RC003
	Software Version	Polytron Repeater V1.5.0, Centero FW v1.5.02c, Bootloader V2.5.0, SW Telit BLT V3.12.002
Comment: Those named additional variants above have not been tested. Those additional variants of the series have been declared by the manufacturer. The test report explicitly states that those variants were neither tested nor assessed nor evaluated.		

VERSION HISTORY

Version History			
Version	Issue Date	Remarks	Revised By
01	2021-11-08	Initial Release	

ABBREVIATIONS AND ACRONYMS

Acronyms	
Acronym	Description
DSSS	Direct Sequence Spread Spectrum
EUT	Equipment Under Test
FCC	Federal Communications Commission
IEEE 802.15.4	MAC and PHY Layer for Wireless Personal Area Networks
ISED	Innovation, Science and Economic Development Canada
O-QPSK	Offset-Quadrature Phase Shift Keying
QPSK	Quadrature Phase Shift Keying
RBW	Resolution bandwidth
RMS	Root mean square
VBW	Video bandwidth
V _{NOM}	Nominal supply voltage

REPORT INDEX

1	Equipment (Test Item) Under Test.....	7
1.1	Photos – Equipment External.....	8
1.2	Photos – Equipment Internal.....	16
1.3	Support Equipment.....	23
1.4	Test Modes.....	24
1.5	Test Frequencies.....	25
1.6	Sample emission level calculation.....	26
2	Result Summary.....	27
3	Test Conditions and Results.....	28
3.1	Test Conditions and Results - AC powerline conducted emissions.....	28
3.2	Test Conditions and Results - Transmitter radiated emissions.....	31
3.3	Test Conditions and Results - Receiver radiated emissions.....	37
ANNEX A	Transmitter spurious emissions.....	42
ANNEX B	Receiver spurious emissions.....	52

1 Equipment (Test Item) Under Test

Description	Fixed Gas Detector	
Model	Polytron 6100 EC WL	
Additional Model(s)	None	
Brand Name(s)	None	
Serial Number(s)	ARNK-0038	
Test Sample Id(s)	35065	
Hardware Version(s)	RC003	
Software Version(s)	Transmitter: P6100 V1.5.0, Centro FW v1.5.02c, Bootloader V2.5.0, SW Telit BLT V3.12.002	
PMN	Polytron Repeater WirelessHART + Polytron 6100 EC WL	
HVIN	RC003	
FVIN	n/a	
HMN	n/a	
FCC ID	X6O-RC003	
IC	5895F-RC003	
Equipment type	End Product	
Radio type	Transceiver	
Assigned frequency bands	2400.0 MHz - 2483.5 MHz	
Radio technology	IEEE 802.15.4	
Modulation	QPSK	
Supported data rates	250 kbps	
Number of antenna ports	1	
Radio Module	Type	Wireless HART radio module
	Model	CW24-012
	Manufacturer	Centro LLC
	HW Version	2
	SW Version	v1.5.02c
	FCC-ID	2ANDP-CW24-012
	IC	23069-CW24012
Antenna (tested)	Type	External rod antenna
	Model	F9915KW
	Manufacturer	Yokogawa
	Gain	2 dBi
Antenna (additionally listed)	Type	External rod antenna
	Model	1399.17.0237
	Manufacturer	Huber+Suhner
	Gain	2 dBi
Antenna (additionally listed)	Type	External rod antenna
	Model	1399.17.0232
	Manufacturer	Huber+Suhner
	Gain	2 dBi
Supply Voltage	V _{NOM}	14.4 VDC
Operating Temperature	T _{NOM}	20 °C
AC/DC-Adaptor	None	
Manufacturer	Dräger Safety AG & Co. KGaA Revalstraße 1 23560 Lübeck GERMANY	

1.1 Photos – Equipment External

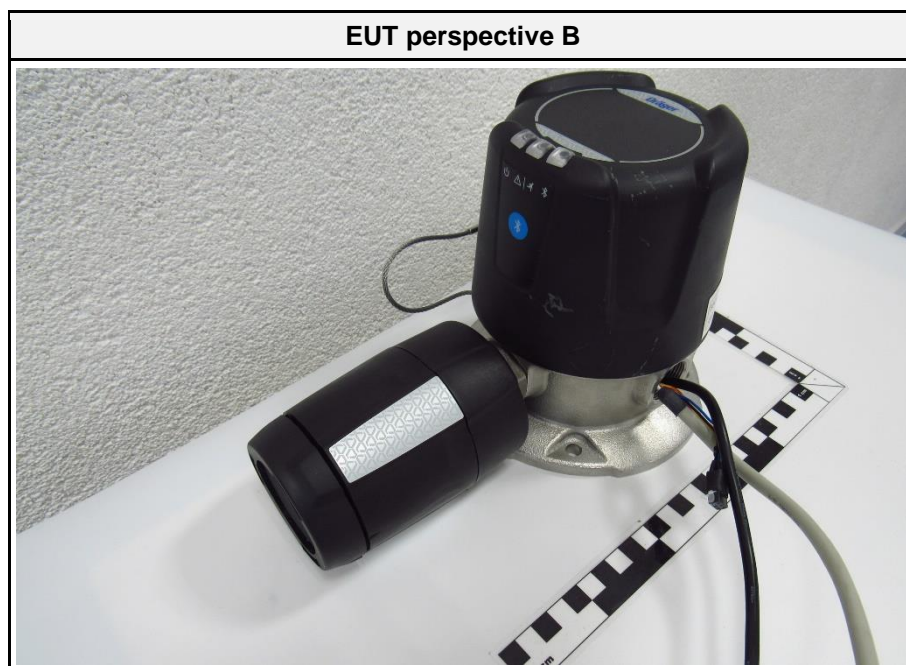
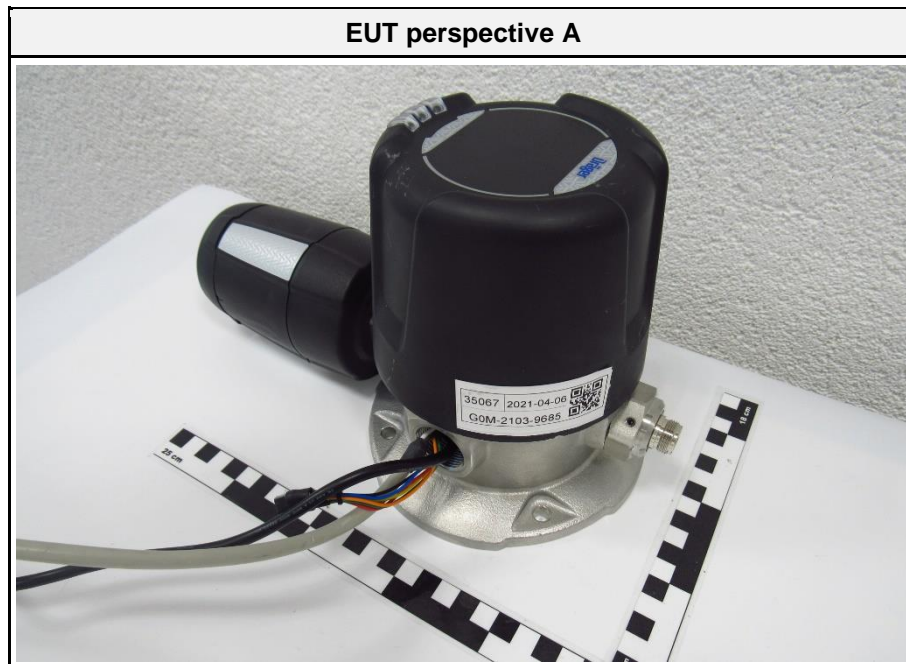

EUT perspective C



EUT top side view



EUT front side view



EUT back side view



EUT left side view

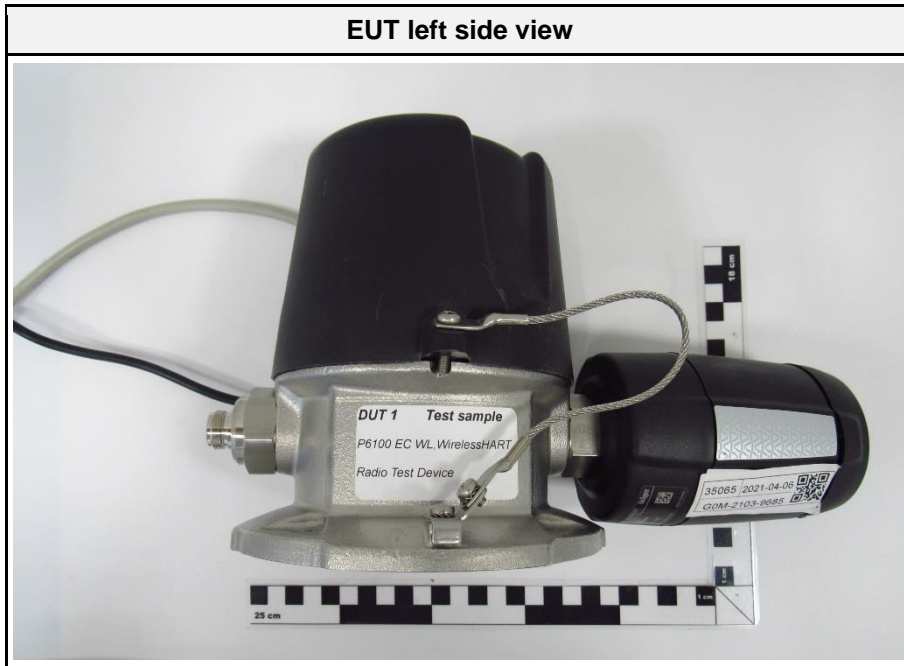

EUT right side view

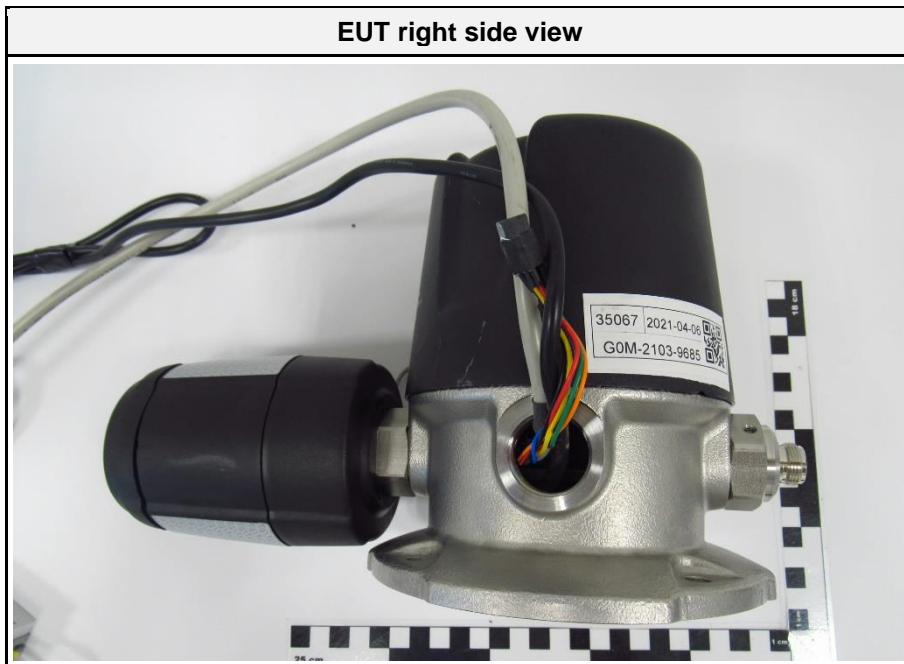

EUT bottom side view



EUT battery housing



EUT label

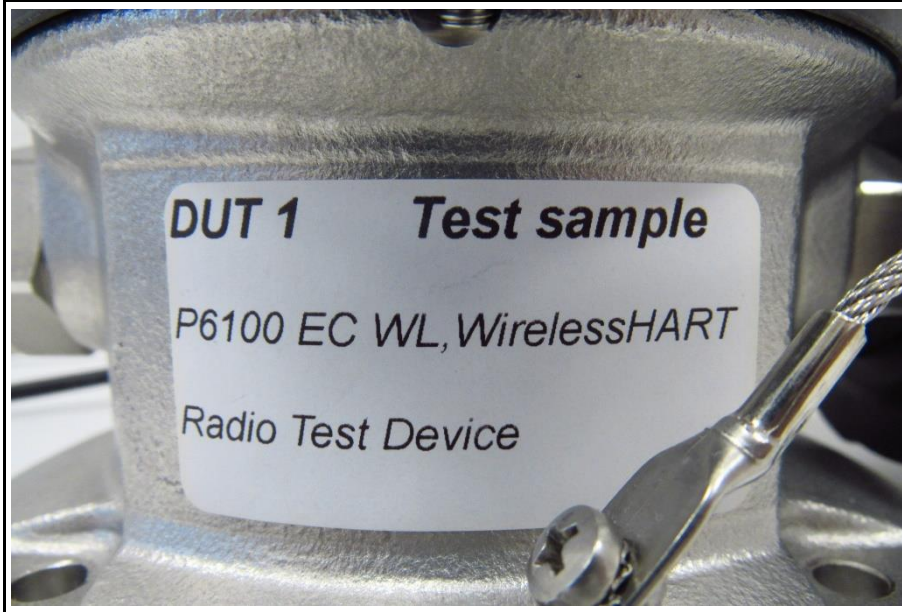

EUT sensor label



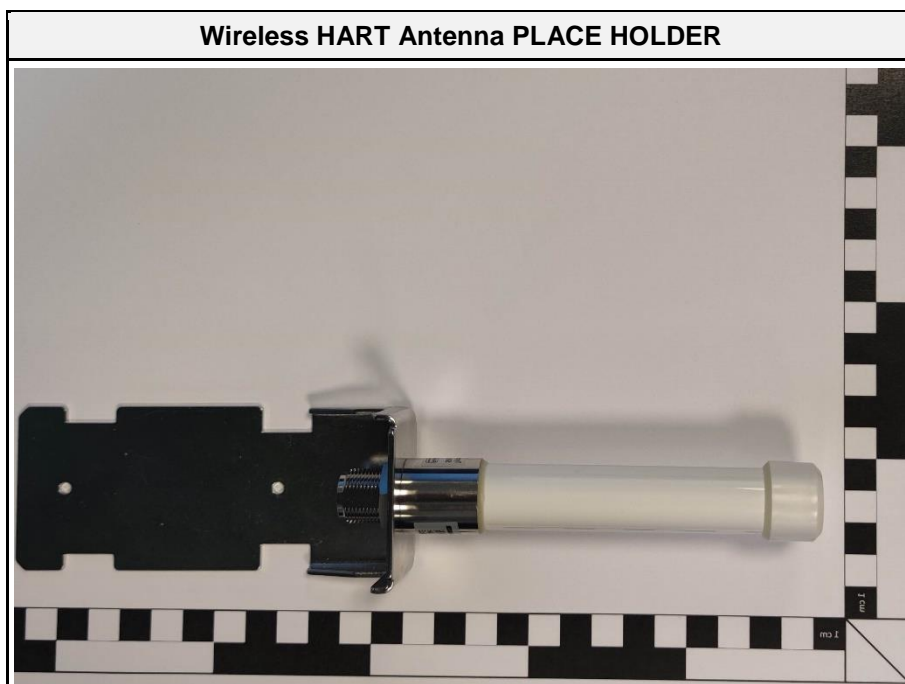
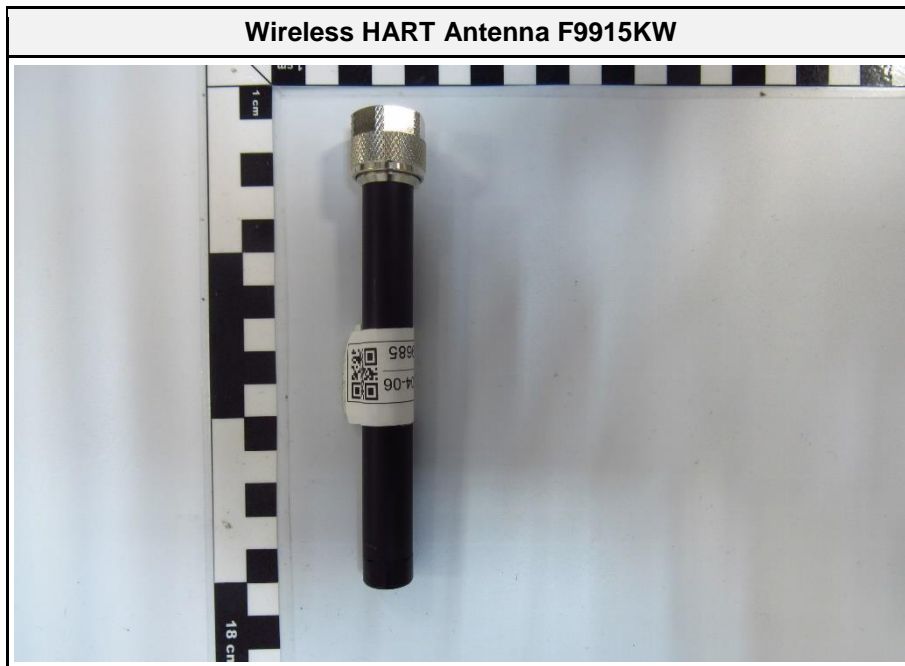

Note: Image is made by customer

Wireless HART Antenna 1399.17.0237

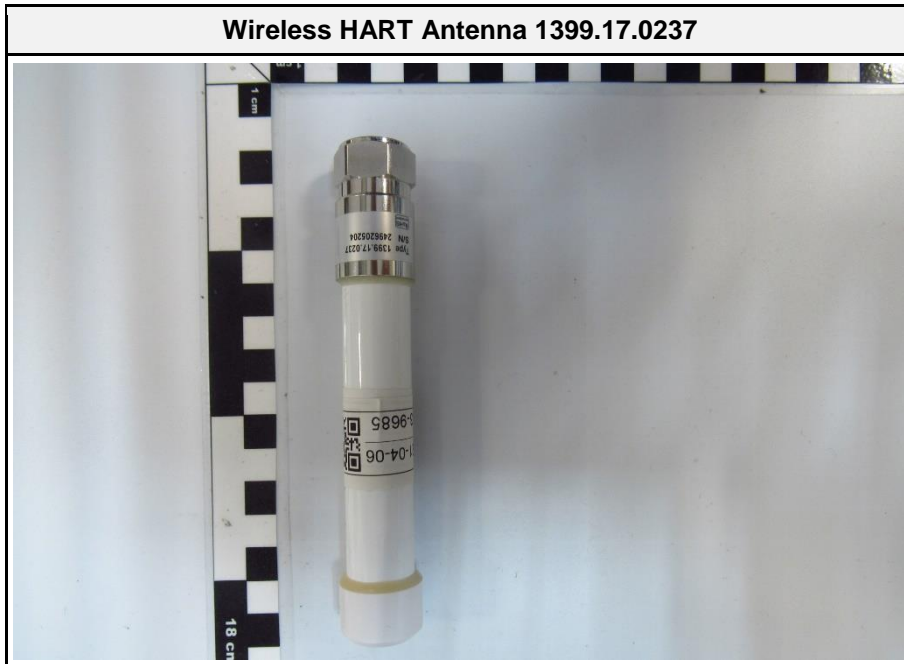

EUT with ancillary equipment ACDC-Adapter



1.2 Photos – Equipment Internal

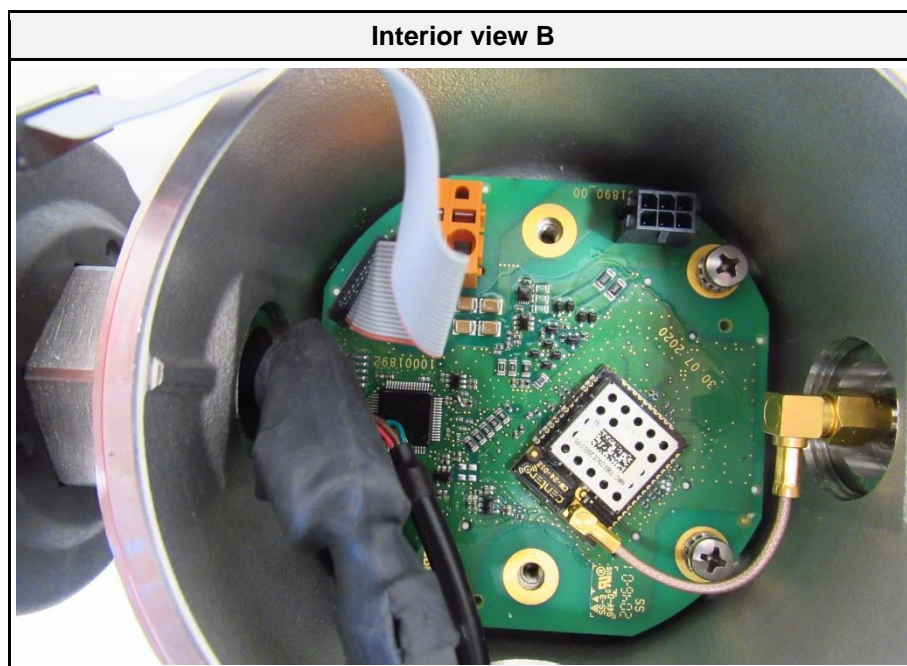
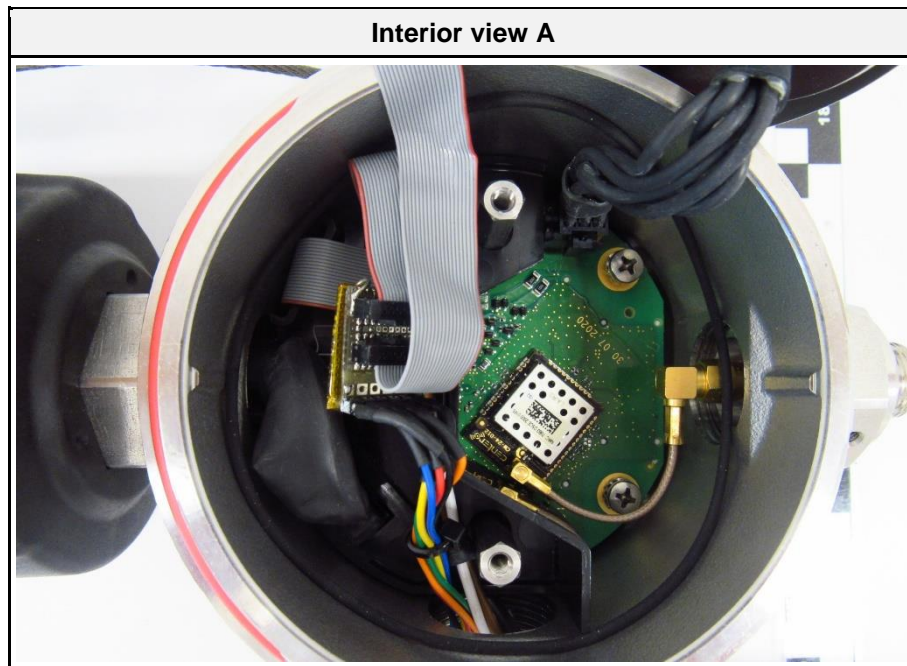

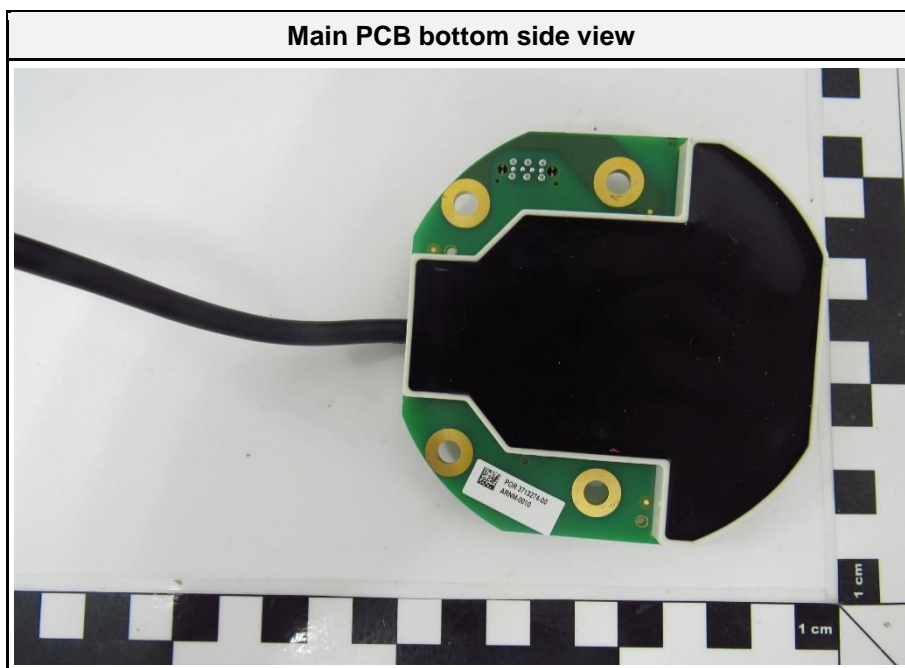
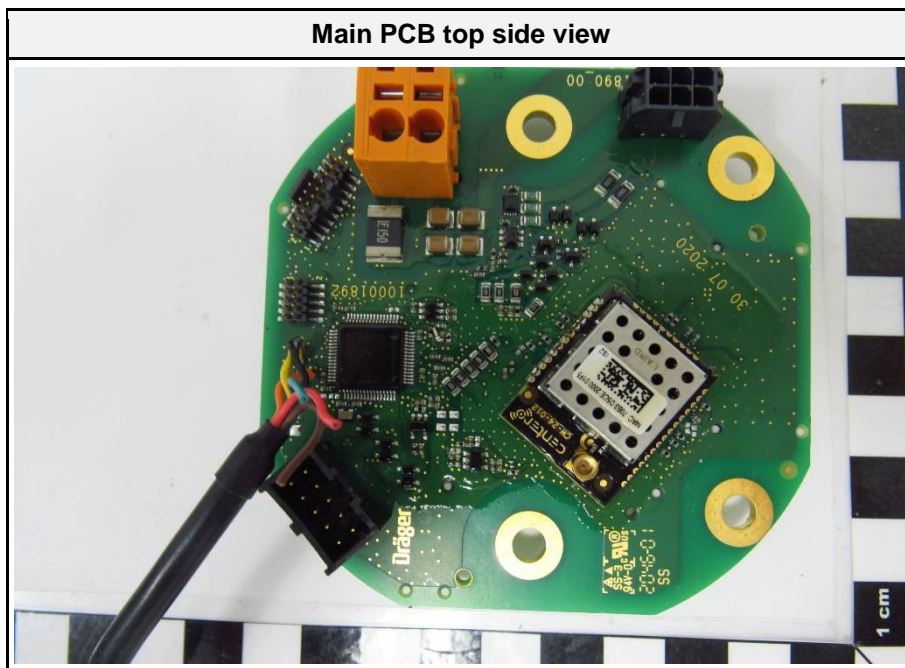

Main PCB bottom side view without casting compound

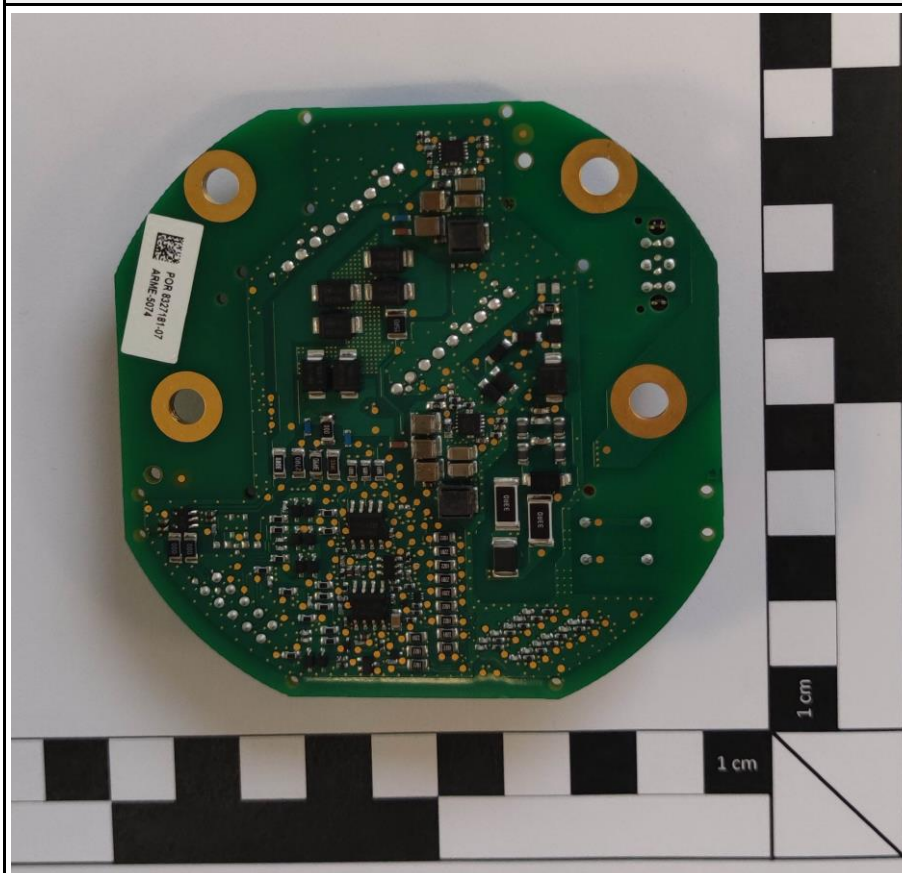

Note: Image is made by customer

Zigbee radio

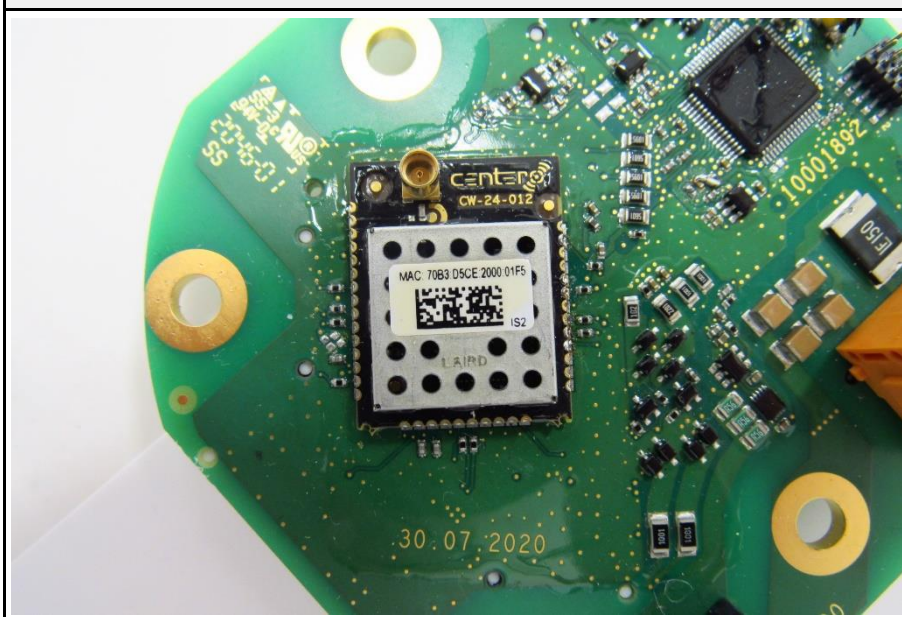

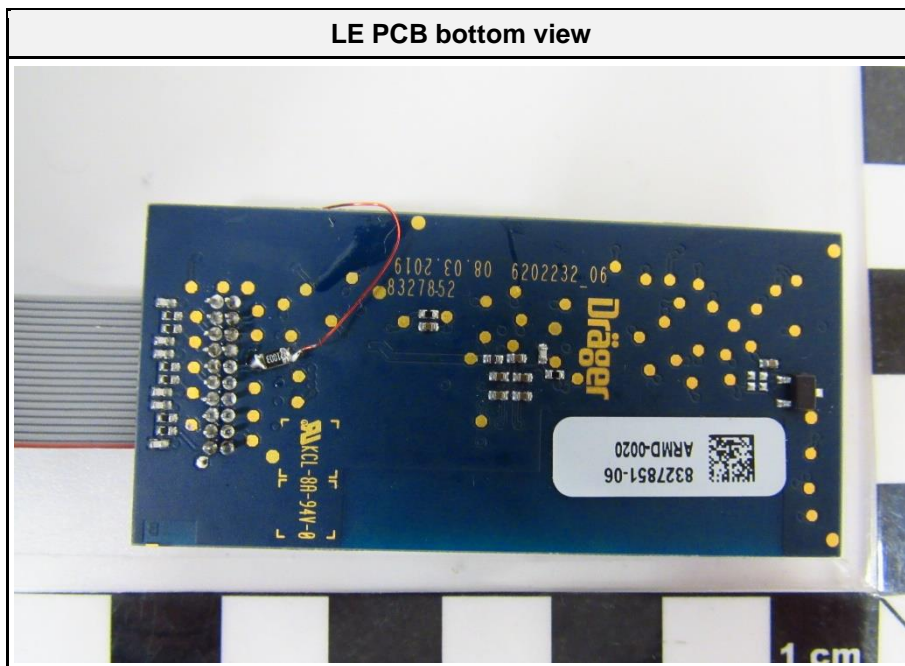
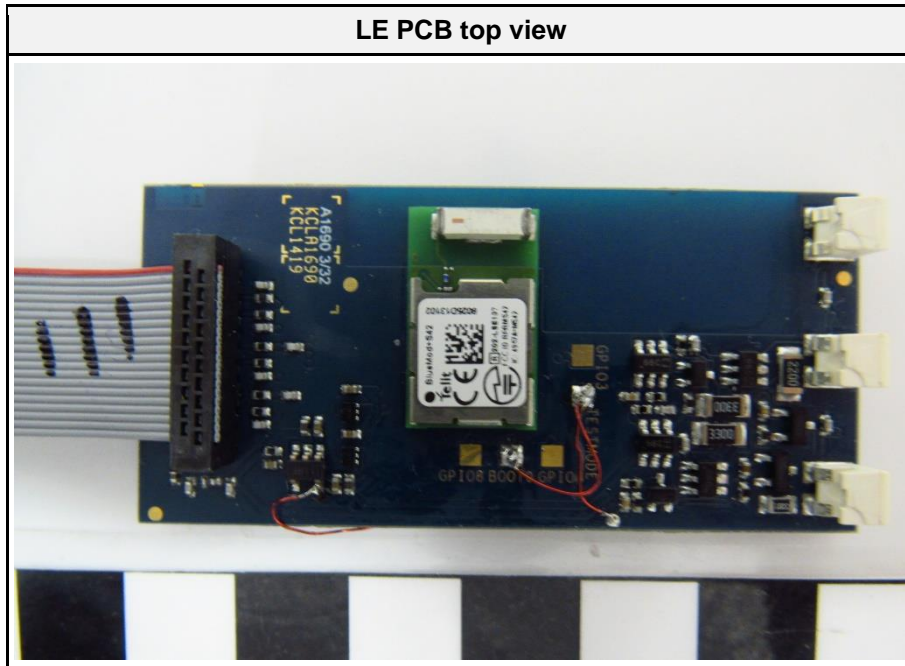

Sensor connector view

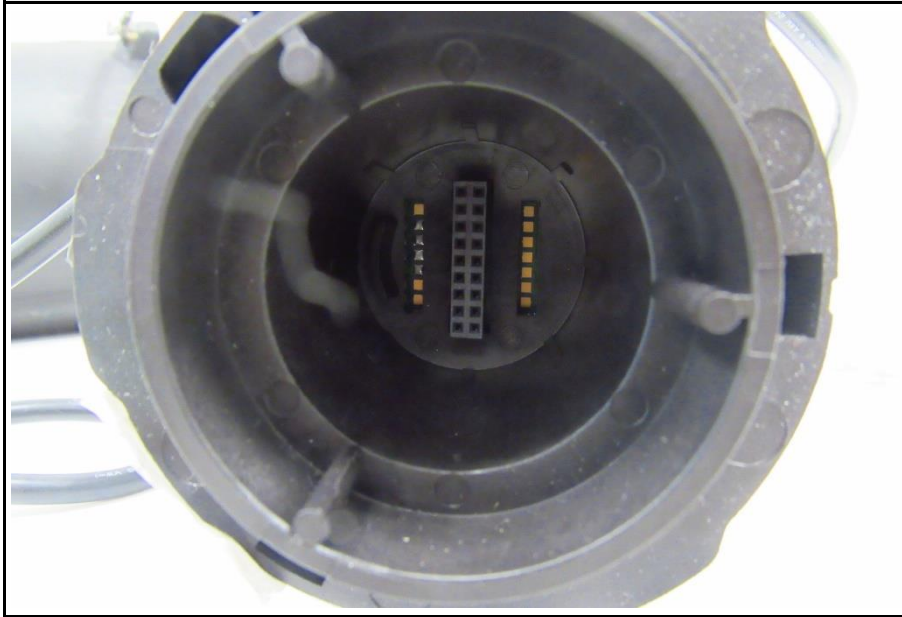

Sensor logic PCB top side view

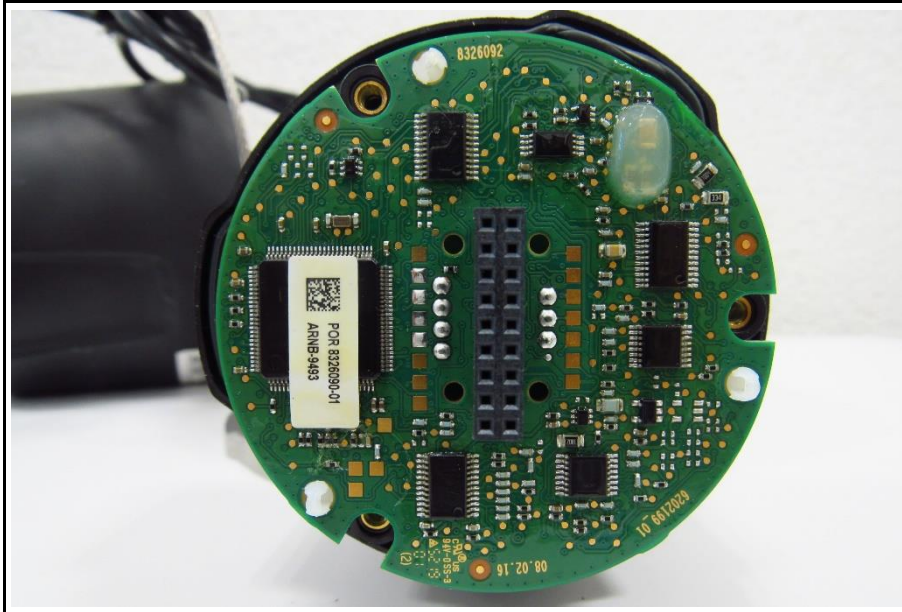

Sensor logic PCB bottom side view

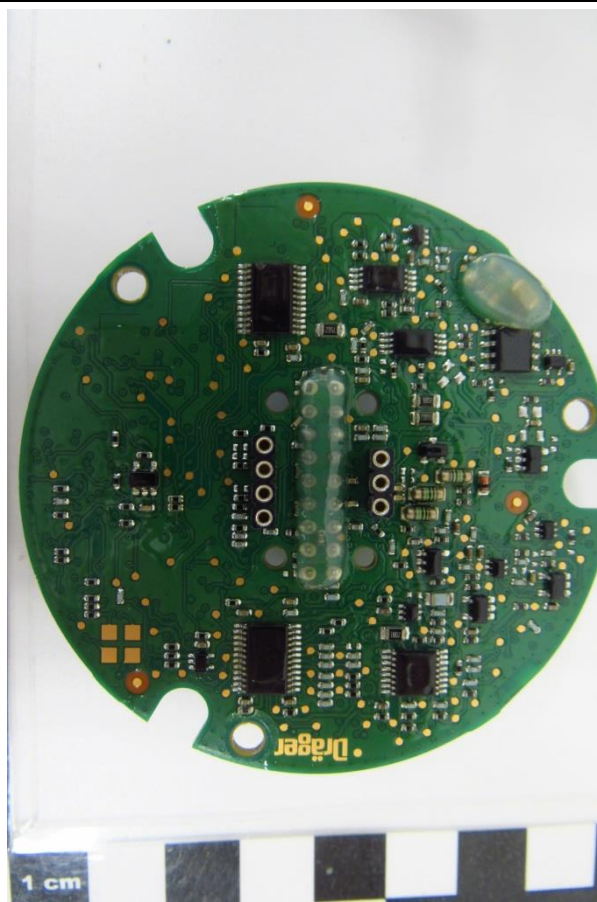

Sensor interface PCB top side view

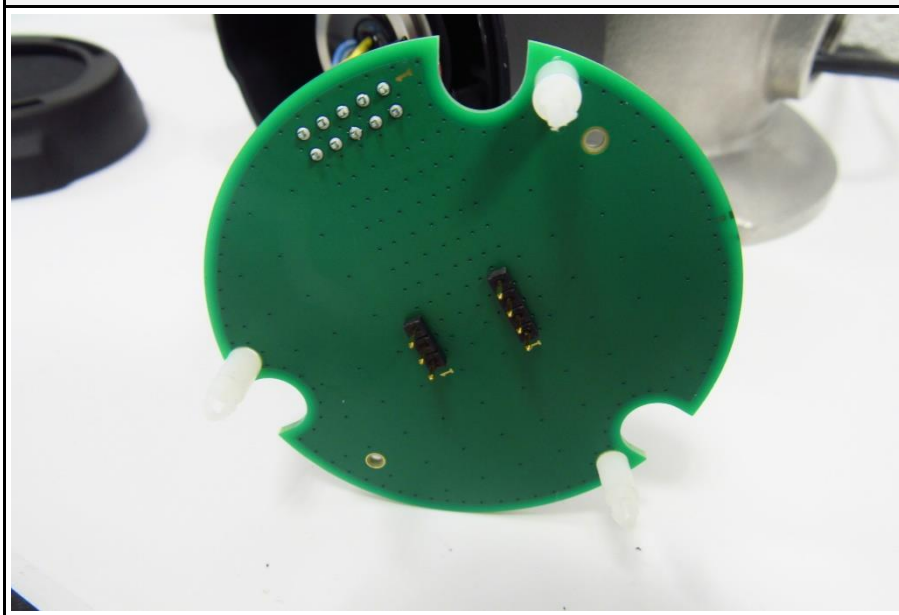

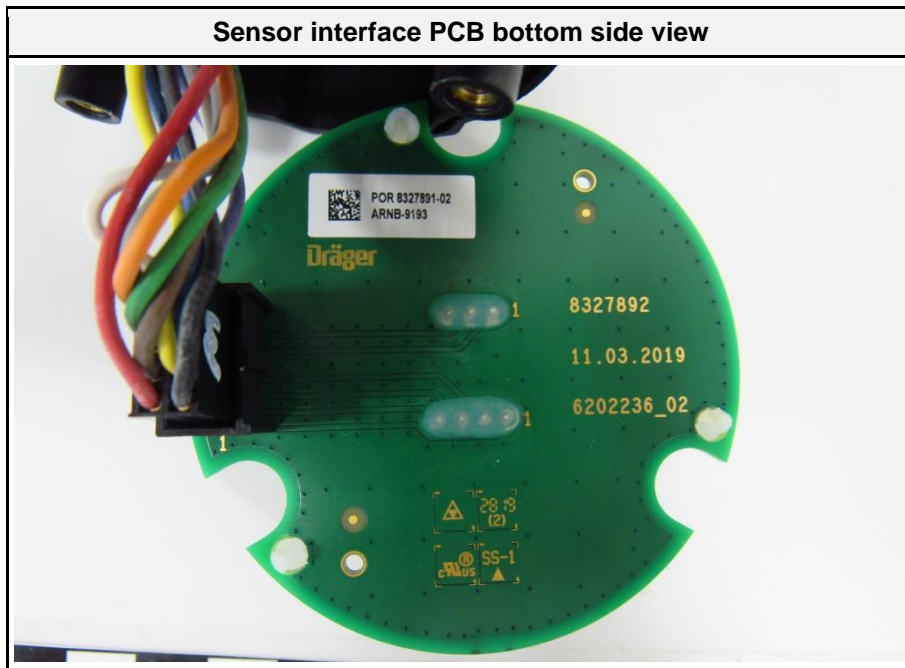

1.3 Support Equipment

Product Type	Device	Manufacturer	Model	Comment
AE	AC/DC adapter	Phoenix Contact	UNO-PS/1AC/24DC/30W	
Description:				
AE	Auxiliary Equipment			
SIM	Simulator			
CBL	Connecting Cable			
SFT	Software			
Comment:				

1.4 Test Modes

Mode	Description
DSSS QPSK	Mode = Transmit Modulation = QPSK Spreading = DSSS Data rate = 250 kbps Chip rate = 2000 kbps Duty cycle = 100% Powersetting = 10dBm (Software setting)
Receive	Mode = Receive
Comment:	

1.5 Test Frequencies

Designator	Mode	Channel	Frequency [MHz]
F1	Tx / Rx	11	2405
Comment: Test frequency selected as the worst case scenario regarding maximum peak output power from modular approval test report 17-0343 issued by US Tech on 2017-11-04.			

1.6 Sample emission level calculation

The following is a description of terms and a sample calculation, as appears in the radiated emissions data table. The numbers used in the calculation are for example only. There is no direct correlation to the specific data taken for the product described in this document:

Reading:

This is the reading obtained on the spectrum analyzer in dBµV. Any external preamplifiers used are taken into account through internal analyzer settings.

A.F.:

This is the antenna factor for the receiving antenna. It is a conversion factor, which converts electric fields strengths to voltages, which can be measured directly on the spectrum analyzer. It is treated as a loss in dB. Cable losses have been included with the A.F. to simplify the calculations. The antenna factor is used in calculations as follows:

$$\text{Reading on Analyzer (dB}\mu\text{V)} + \text{A.F. (dB/m)} = \text{Net field strength (dB}\mu\text{V/m)}$$

Net:

This is the net field strength measurement (as shown above).

Limit:

This is the FCC Class B radiated emission limit (in units of dBµV/m). The FCC limits are given in units of µV/m. The following formula is used to convert the units of µV/m to dBµV/m:

$$\text{Limit (dB}\mu\text{V/m)} = 20 \cdot \log(\mu\text{V/m})$$

Margin:

This is the margin of compliance below the FCC limit. The units are given in dB. A negative margin indicates the emission was below the limit. A positive margin indicates that the emission exceeds the limit.

Example only:

Reading + AF	= Net Reading	:	Net reading - FCC limit	= Margin
+21.5 dBµV + 26 dB/m	= 47.5 dBµV/m	:	47.5 dBµV/m - 57.0 dBµV/m	= -9.5 dB

2 Result Summary

FCC 47 CFR Part 15C, ISED RSS-247				
Product Standard Reference	Requirement	Reference Method	Result	Remarks
ISED RSS-Gen, Issue 5 A2 (section 6.7)	Occupied Bandwidth	ANSI C63.10-2013	N/R	Informational only
FCC § 15.247(a)(2) ISED RSS-247, Issue 2 (section 5.2)	6 dB Bandwidth	ANSI C63.10-2013	N/T	
FCC § 15.247(b) ISED RSS-247, Issue 2 (section 5.4)	Maximum peak conducted power	ANSI C63.10-2013	N/T	
FCC § 15.247(e) ISED RSS-247, Issue 2 (section 5.2)	Power spectral density	ANSI C63.10-2013	N/T	
FCC § 15.207 ISED RSS-247, Issue 2 (section 3.1)	AC power line conducted emissions	ANSI C63.10-2013	PASS	
FCC § 15.247(d) ISED RSS-247, Issue 2 (section 5.5)	Band edge compliance	ANSI C63.10-2013	N/T	
FCC § 15.247(d) ISED RSS-247, Issue 2 (section 5.5)	Conducted spurious emissions	ANSI C63.10-2013	N/T	
FCC § 15.247(d) FCC § 15.209 ISED RSS-Gen, Issue 5 A2 (section 6.13)	Transmitter radiated spurious emissions	ANSI C63.10-2013	PASS	
ISED RSS-247, Issue 2 (section 3.1)	Receiver radiated spurious emissions	ANSI C63.4-2014	PASS	
Comment:				

Possible Test Case Verdicts	
PASS	Test object does meet the requirements
FAIL	Test object does not meet the requirements
N/T	Required by standard but not tested
N/R	Not required by standard for the test object

3 Test Conditions and Results

3.1 Test Conditions and Results - AC powerline conducted emissions

3.1.1 Information

Test Information	
Reference	FCC § 15.207; ISED RSS-247, Issue 2 (section 3.1)
Measurement Method	ANSI C63.10 6.2
Measurement Uncertainty	± 3.82 dB
Operator	Florian Voigt
Date	2021-09-27

3.1.2 Limits

Limits		
Frequency [MHz]	Quasi-Peak [dBµV]	Average [dBµV]
0.15 - 0.5	66 - 56*	56 - 46*
0.5 - 5	56	46
5 - 30	60	50

* Limit decreases linearly with the logarithm of the frequency

3.1.3 Setup

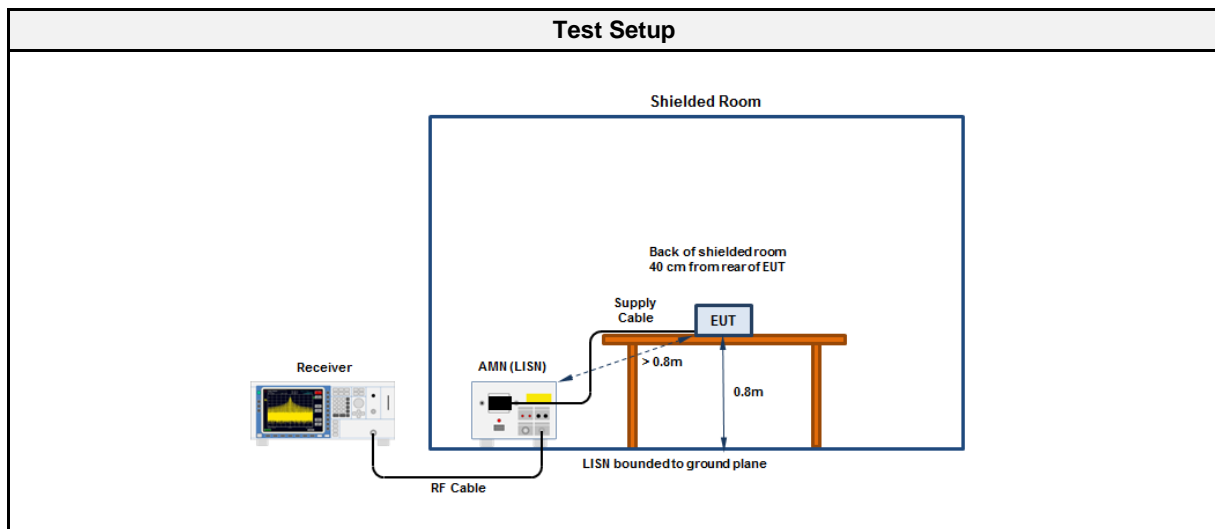

3.1.4 Equipment

Test Software			
Description	Manufacturer	Name	Version
EMC Software	DARE Instruments	RadiMation	2020.1.8

Test Equipment					
Description	Manufacturer	Model	Identifier	Cal. Date	Cal. Due
EMI Test Receiver	R&S	ESR7	EF00943	2021-08	2022-08
Pulse Limiter	R&S	ESH3-Z2	EF01222	2021-07	2022-07
LISN	Schwarzbeck	NSLK 8127 RC	EF01592	2021-07	2022-07

3.1.5 Results

Conducted emissions at the mains power port according to RSS-247, 47 CFR Part 15.247

Project Number: G0M-2103-9685
 Applicant: Dräger Safety AG & Co. KGaA
 Model Description: Fixed Gas Detector
 Model: Polytron 6100 EC WL
 Test Sample ID: 35067
 Test Site: Eurofins Product Service GmbH
 Operator: Mr. Voigt
 Test Date: 2021-09-27
 Operating Conditions: ambient temperature: 23 °Celsius
 power input: 120 VAC converted to 24 VDC
 LISN: Schwarzbeck NSLK 8127 RC N
 Operational Mode: Tx; DSSS QPSK, 2405MHz
 Applied to Port: Mains
 Note 1:

Index 24

RadiMation

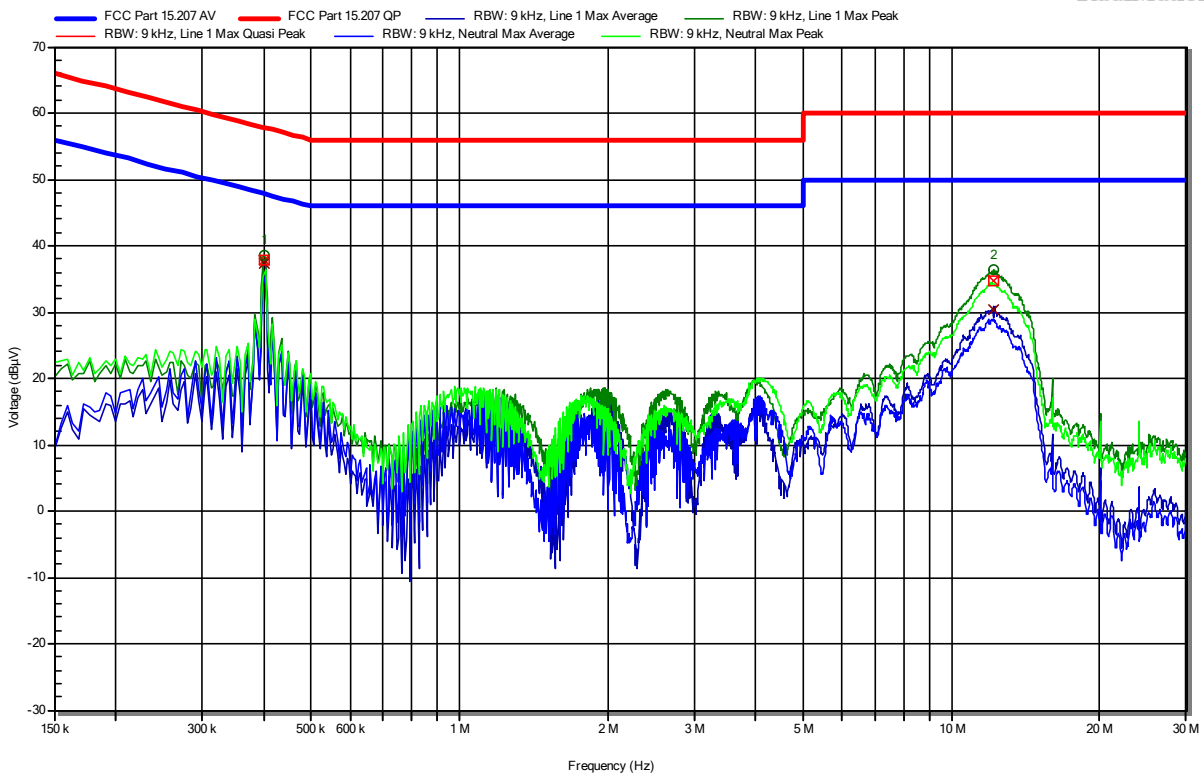

Peak Number	Frequency	Quasi-Peak	Quasi-Peak Limit	Quasi-Peak Difference	Quasi-Peak Status	LISN
1	400.65 kHz	37.84 dBµV	57.84 dBµV	-20 dB	Pass	Line 1
2	12.156 MHz	34.7 dBµV	60 dBµV	-25.3 dB	Pass	Line 1

Peak Number	Frequency	Average	Average Limit	Average Difference	Average Status	LISN
1	400.65 kHz	37.32 dBµV	47.84 dBµV	-10.52 dB	Pass	Line 1
2	12.156 MHz	30.4 dBµV	50 dBµV	-19.6 dB	Pass	Line 1

3.1.6 Setup photos

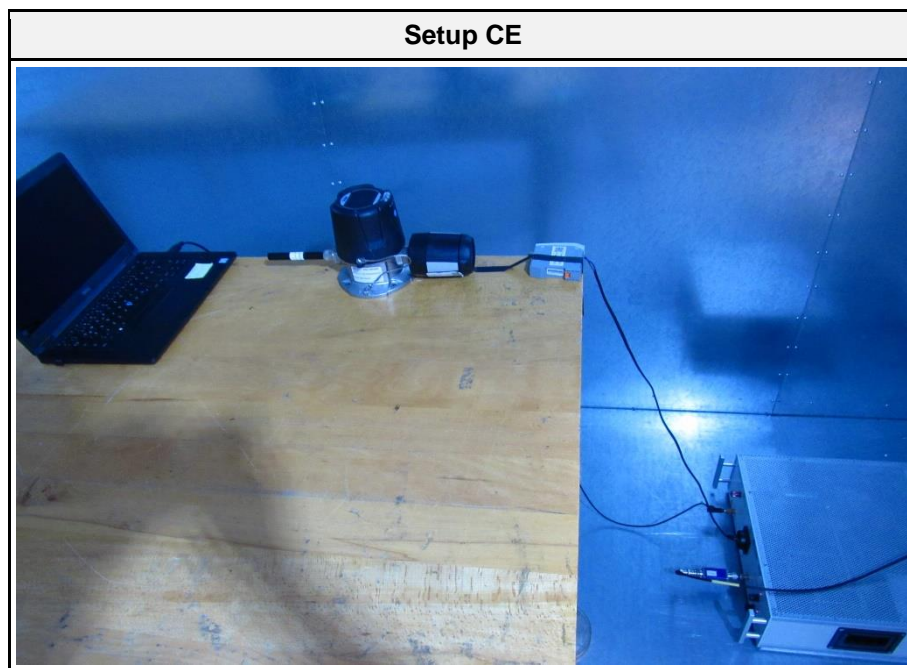

3.2 Test Conditions and Results - Transmitter radiated emissions

3.2.1 Information

Test Information	
Reference	FCC § 15.247(d); FCC § 15.209; ISSED RSS-Gen, Issue 5 A2 (section 6.13)
Measurement Uncertainty	± 5.95 dB
Measurement Method	ANSI C63.10 6.4, 6.5, 6.6, 11.12
Operator	Florian Voigt
Date	2021-09-23 - 2021-09-24

3.2.2 Limits

Limits			
Frequency range [MHz]	Detector	Field strength [$\mu\text{V}/\text{m}$]	Measurement distance [m]
0.009 - 0.09	Average	2400/F[kHz]	300
0.09 - 0.110	Quasi-Peak	2400/F[kHz]	300
0.110 - 0.490	Average	2400/F[kHz]	300
0.490 - 1.705	Quasi-Peak	24000/F[kHz]	30
1.705 - 30.0	Quasi-Peak	30	30
30 - 88	Quasi-Peak	100	3
88 - 216	Quasi-Peak	150	3
216 - 960	Quasi-Peak	200	3
960 - 1000	Quasi-Peak	500	3
>1000	Average	500	3

3.2.3 Setup

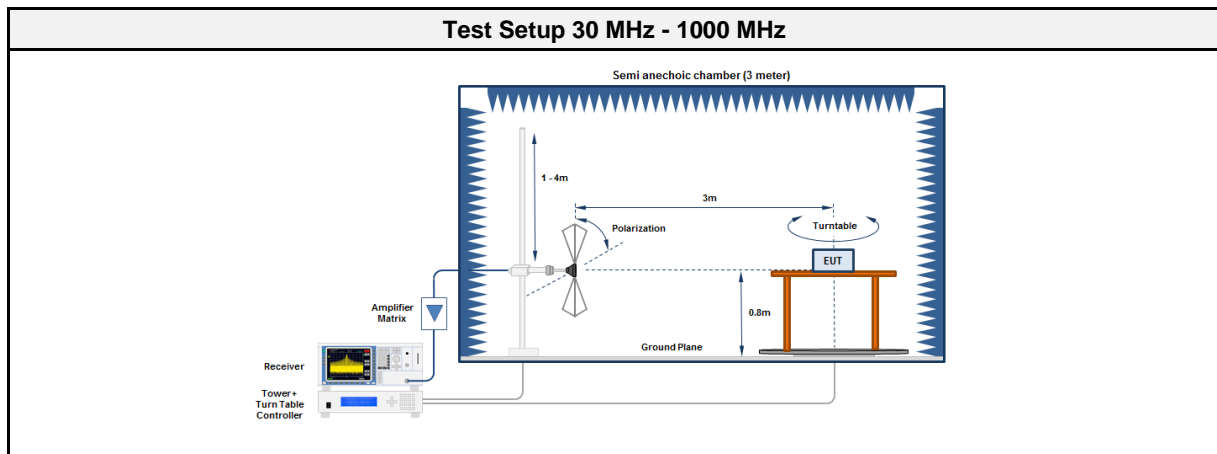

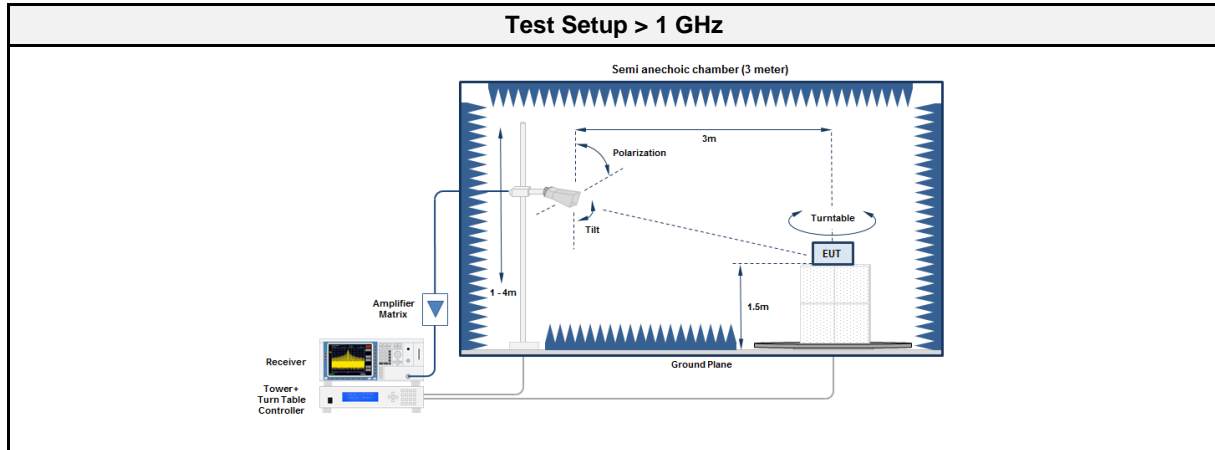

3.2.4 Equipment

Test Software			
Description	Manufacturer	Name	Version
EMC Software	DARE Instruments	RadiMation	2020.1.8

Test Equipment 30 MHz - 1000 MHz					
Description	Manufacturer	Model	Identifier	Cal. Date	Cal. Due
Anechoic Chamber	Frankonia	AC1	EF00062	2021-02	2024-02
Measurement Receiver	Agilent	N9038A-526/WXP	EF01070	2021-07	2022-07
Antenna	R&S	HK 116	EF00030	2021-05	2024-05
Antenna	R&S	HL 223	EF00187	2019-05	2022-05

Test Equipment > 1 GHz					
Description	Manufacturer	Model	Identifier	Cal. Date	Cal. Due
Anechoic Chamber	Frankonia	AC1	EF00062	2021-02	2024-02
Measurement Receiver	Agilent	N9038A-526/WXP	EF01070	2021-07	2022-07
Antenna	Schwarzbeck	BBHA 9120D	EF00018	2019-10	2022-10
Antenna	Schwarzbeck	HWRD 650	EF01679	2021-03	2022-03
Antenna	Amplifier Research	AT4560	EF00302	2021-06	2023-06

3.2.5 Procedure

Test Procedure 30 MHz - 1000 MHz
<ol style="list-style-type: none"> EUT is placed on a non conducting support at the center of a turn table 0.8 m above the ground EUT set to test mode The receiver is set to peak detection with max hold The EUT is rotated through 360° and the height of the antenna is varied from 1 m to 4 m All significant emissions are measured again using the corresponding final detector

Test Procedure > 1 GHz
<ol style="list-style-type: none"> EUT is placed on a non conducting support at the center of a turn table 1.5 m above the ground EUT set to test mode The receiver is set to peak detection with max hold The EUT is rotated through 360° and the height of the antenna is varied from 1 m to 4 m All significant emissions are measured again using the corresponding final detector

3.2.6 Results

Test Results						
Channel [MHz]	Emission [MHz]	Level [dB μ V/m]	Det.	Pol.	Limit [dB μ V/m]	Margin [dB]
2405	2277.4	44.52	pk	hor	74.00	-29.48
2405	2277.4	37.40	avg	hor	54.00	-16.60
2405	2341.1	49.91	pk	ver	74.00	-24.09
2405	2341.1	44.36	avg	ver	54.00	-09.64
2405	2365	44.53	pk	ver	74.00	-29.47
2405	2365	36.21	avg	ver	54.00	-17.79
2405	2373	55.23	pk	ver	74.00	-18.77
2405	2373	51.21	avg	ver	54.00	-02.79
2405	2373.1	46.41	pk	hor	74.00	-27.59
2405	2373.1	39.16	avg	hor	54.00	-14.84
2405	2373.2	55.54	pk	hor	74.00	-18.46
2405	2373.2	51.80	avg	hor	54.00	-02.20
2405	2496	40.70	pk	hor	74.00	-33.30
2405	2496	33.13	avg	hor	54.00	-20.87
2405	7440	36.06	pk	ver	74.00	-37.94
2405	7440	29.51	avg	ver	54.00	-24.49
2405	7441	40.42	pk	hor	74.00	-33.58
2405	7441	34.36	avg	hor	54.00	-19.64
2405	7441	37.85	pk	ver	74.00	-36.15
2405	7441	33.87	avg	ver	54.00	-20.13
2405	12023	51.65	pk	ver	74.00	-22.35
2405	12023	48.33	avg	ver	54.00	-05.67
2405	12027	50.73	pk	ver	74.00	-23.27
2405	12027	44.82	avg	ver	54.00	-09.18
2405	12027	54.25	pk	hor	74.00	-19.75
2405	12027	48.82	avg	hor	54.00	-05.18

3.2.7 Setup photos

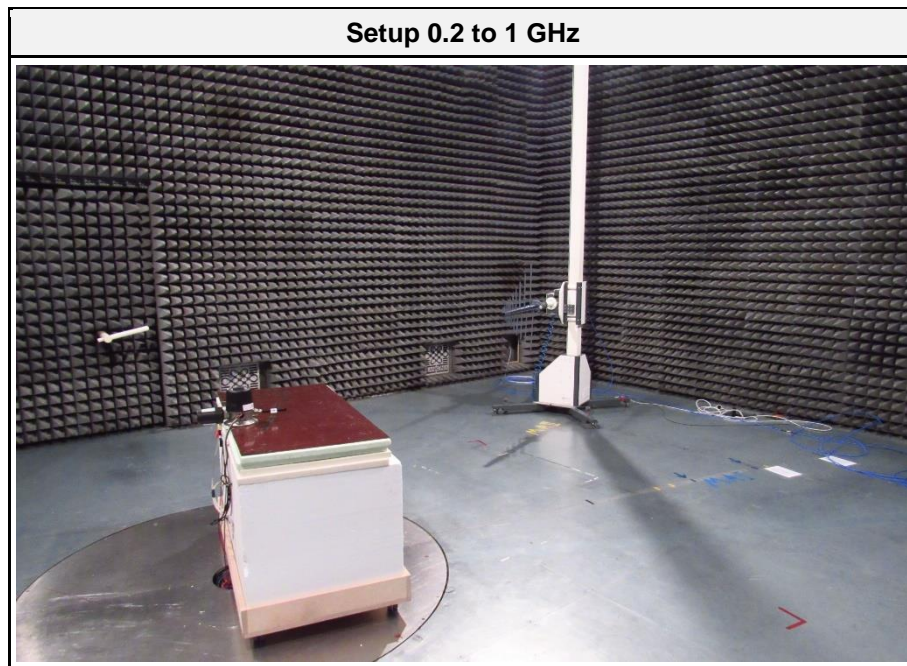
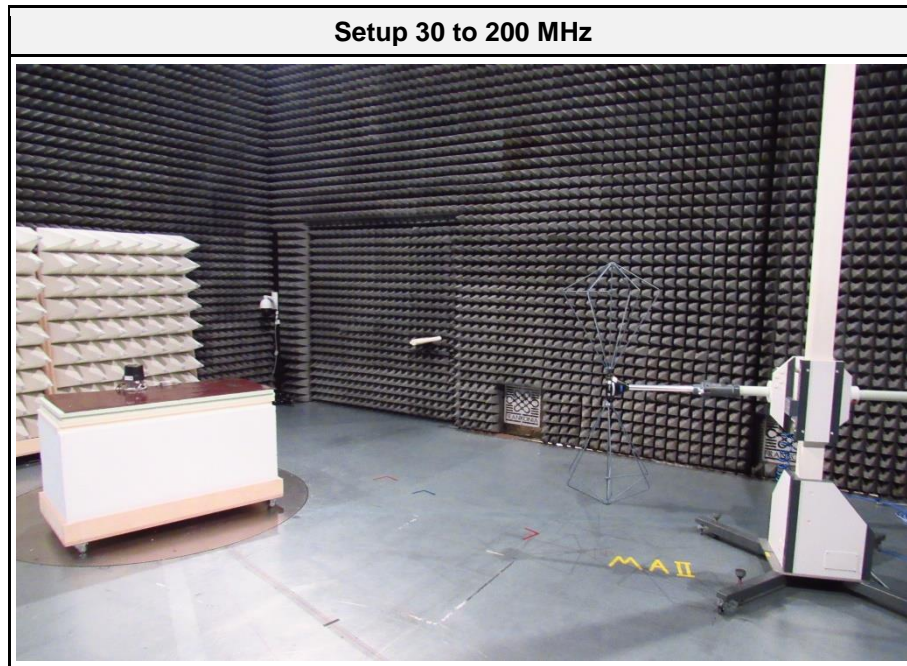

Setup 1 to 6.5 GHz

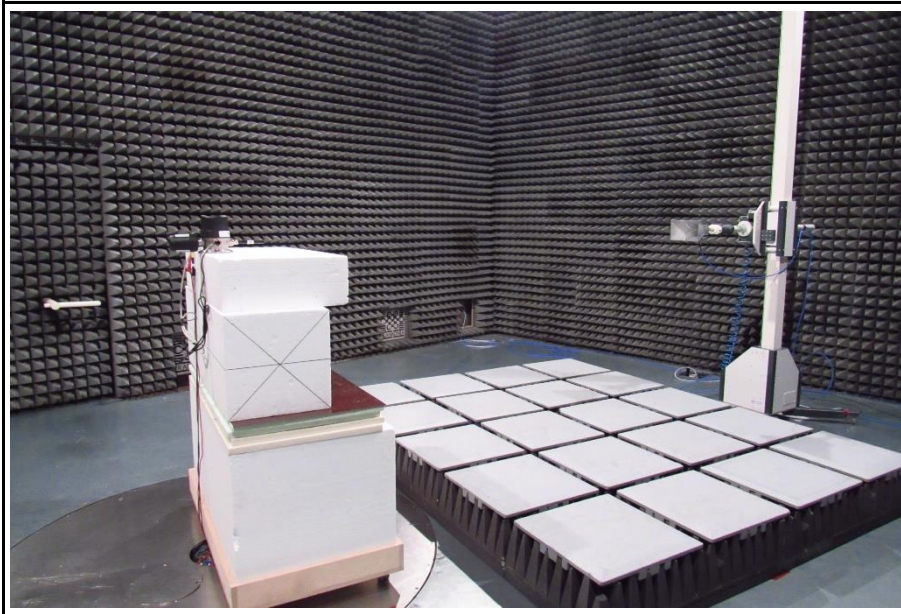

Setup 6.5 to 18 GHz

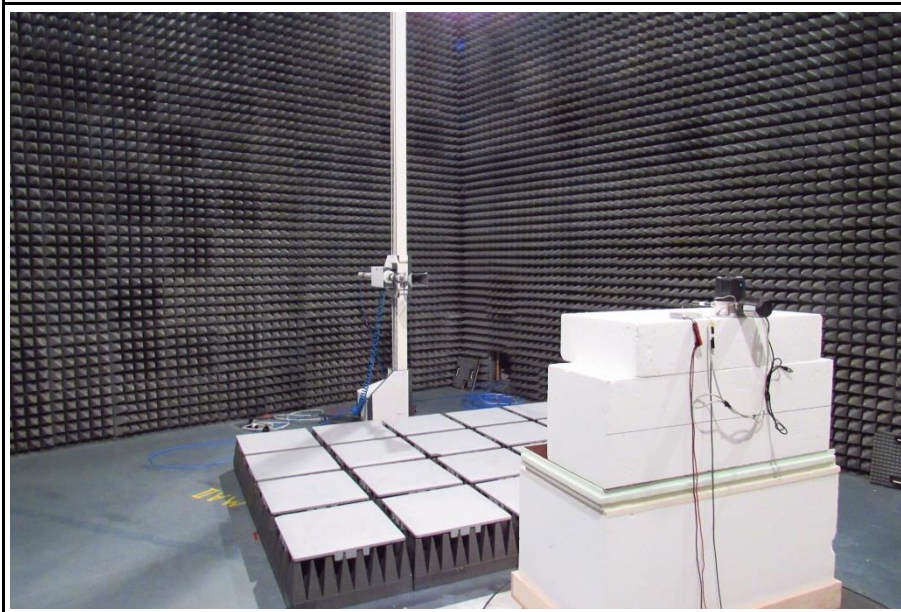

Setup 6.5 to 18 GHz EUT vertical

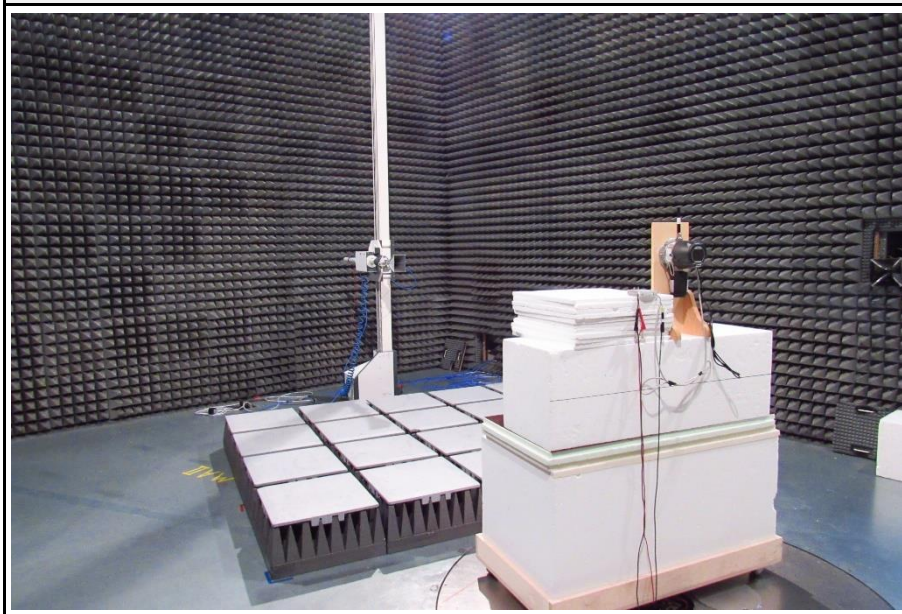

Setup 18 to 26.5 GHz

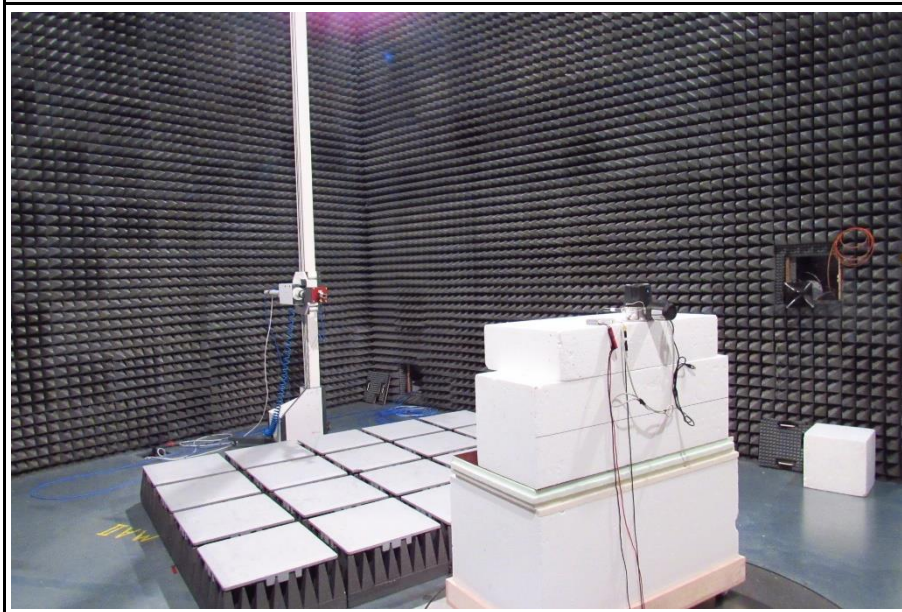

3.3 Test Conditions and Results - Receiver radiated emissions

3.3.1 Information

Test Information	
Reference	ISED RSS-247, Issue 2 (section 3.1)
Measurement Uncertainty	± 5.95 dB
Measurement Method	ANSI C63.4-2014 8.1-8.3
Operator	Florian Voigt
Date	2021-09-24

3.3.2 Limits

Limits			
Frequency range [MHz]	Detector	Field strength [$\mu\text{V/m}$]	Measurement distance [m]
30 - 88	Quasi-Peak	100	3
88 - 216	Quasi-Peak	150	3
216 - 960	Quasi-Peak	200	3
960 - 1000	Quasi-Peak	500	3
>1000	Average	500	3

3.3.3 Setup

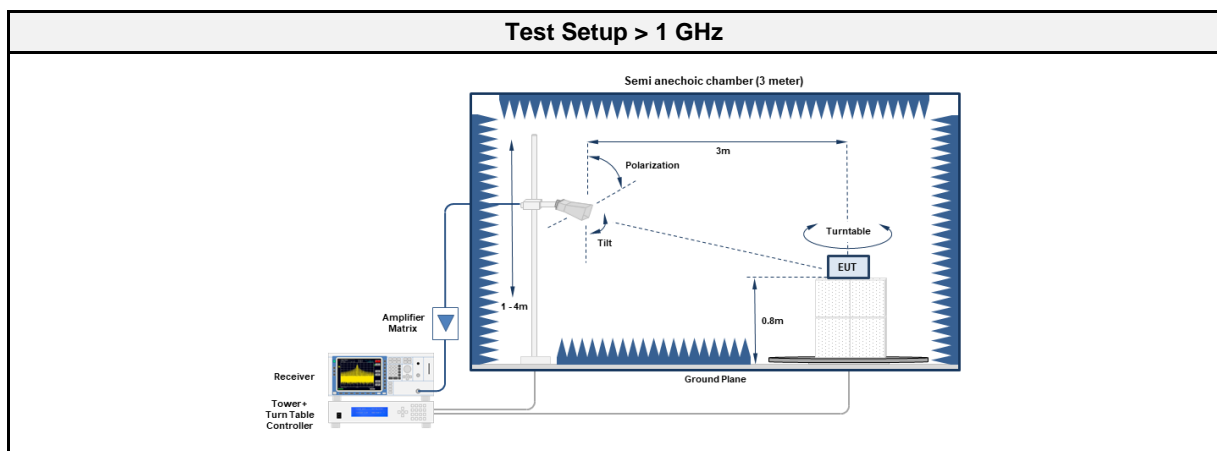
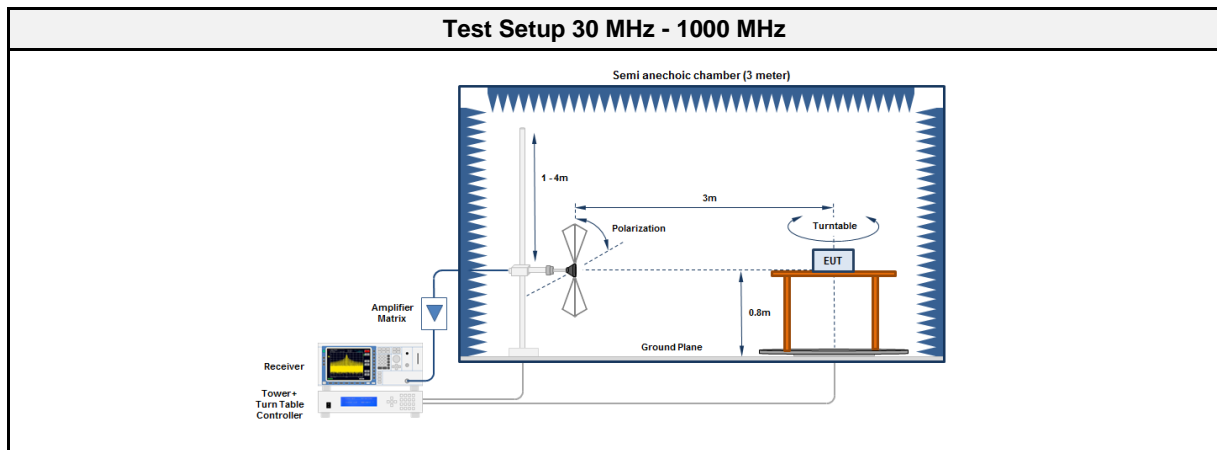

3.3.4 Equipment

Test Software			
Description	Manufacturer	Name	Version
EMC Software	DARE Instruments	RadiMation	2020.1.8

Test Equipment 30 MHz - 1000 MHz					
Description	Manufacturer	Model	Identifier	Cal. Date	Cal. Due
Anechoic Chamber	Frankonia	AC1	EF00062	2021-02	2024-02
Measurement Receiver	Agilent	N9038A-526/WXP	EF01070	2021-07	2022-07
Antenna	R&S	HK 116	EF00030	2021-05	2024-05
Antenna	R&S	HL 223	EF00187	2019-05	2022-05

Test Equipment > 1 GHz					
Description	Manufacturer	Model	Identifier	Cal. Date	Cal. Due
Anechoic Chamber	Frankonia	AC1	EF00062	2021-02	2024-02
Measurement Receiver	Agilent	N9038A-526/WXP	EF01070	2021-07	2022-07
Antenna	Schwarzbeck	BBHA 9120D	EF00018	2019-10	2022-10
Antenna	Schwarzbeck	HWRD 650	EF01679	2021-03	2022-03

3.3.5 Procedure

Test Procedure 30 - 1000 MHz
<ol style="list-style-type: none"> EUT is placed on a non conducting support at the center of a turn table 0.8 m above the ground EUT set to test mode The receiver is set to peak detection with max hold The EUT is rotated through 360° and the height of the antenna is varied from 1 m to 4 m All significant emissions are measured again using the corresponding final detector

Test Procedure > 1 GHz
<ol style="list-style-type: none"> EUT is placed on a non conducting support at the center of a turn table 1.5 m above the ground EUT set to test mode The receiver is set to peak detection with max hold The EUT is rotated through 360° and the height of the antenna is varied from 1 m to 4 m All significant emissions are measured again using the corresponding final detector

3.3.6 Results

Test Results						
Channel [MHz]	Emission [MHz]	Level [dB μ V/m]	Det.	Pol.	Limit [dB μ V/m]	Margin [dB]
2480	33.4552	23.20	pk	hor	40.00	-16.80
2480	33.4552	16.10	qpk	hor	40.00	-23.93
2480	69.2445	24.00	pk	hor	40.00	-16.01
2480	69.2445	18.50	qpk	hor	40.00	-21.49
2480	2403	44.07	pk	hor	53.98	-09.91
2480	2403	38.73	avg	hor	53.98	-15.25

3.3.7 Setup photos

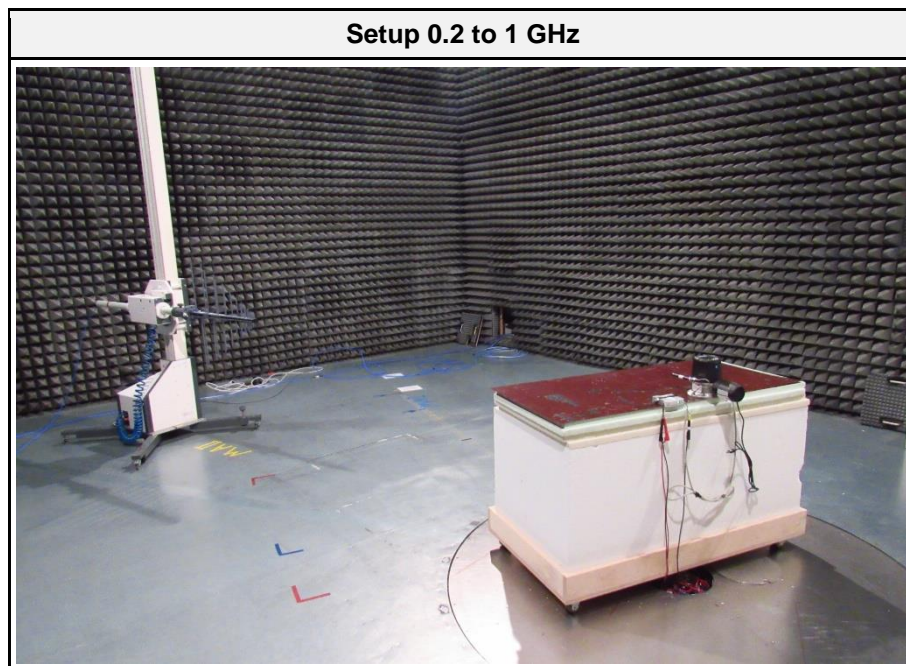
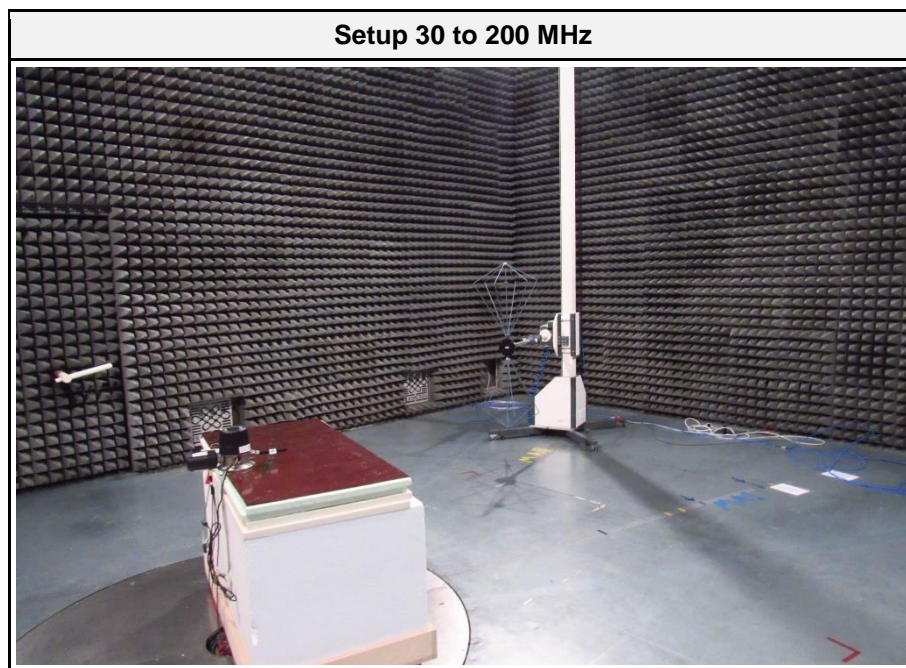

Setup 1 to 6.5 GHz

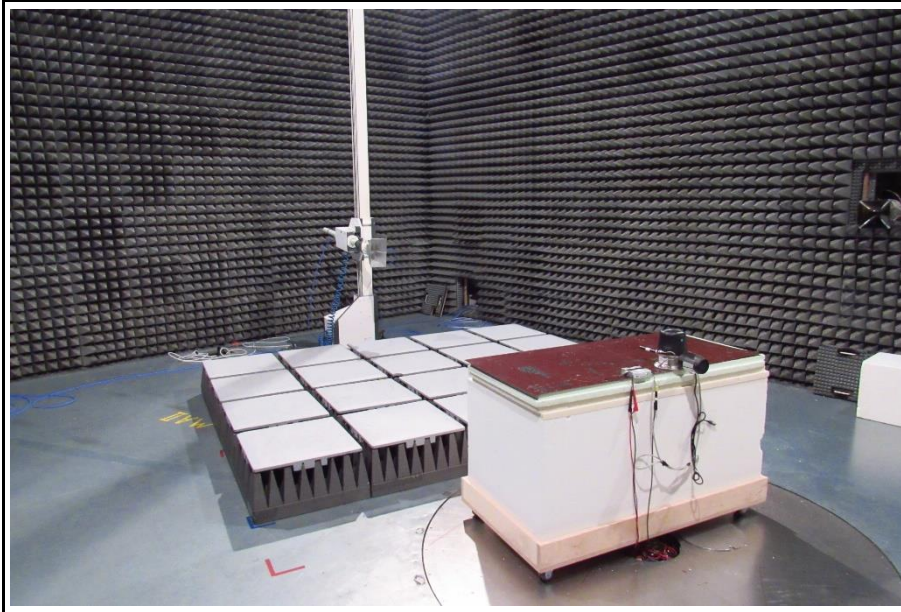

Setup 6.5 to 18 GHz

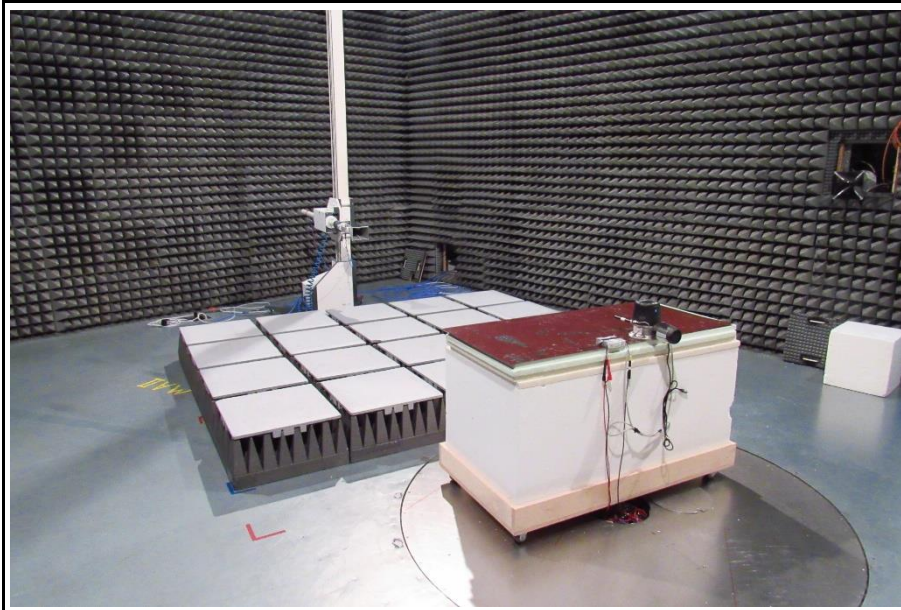

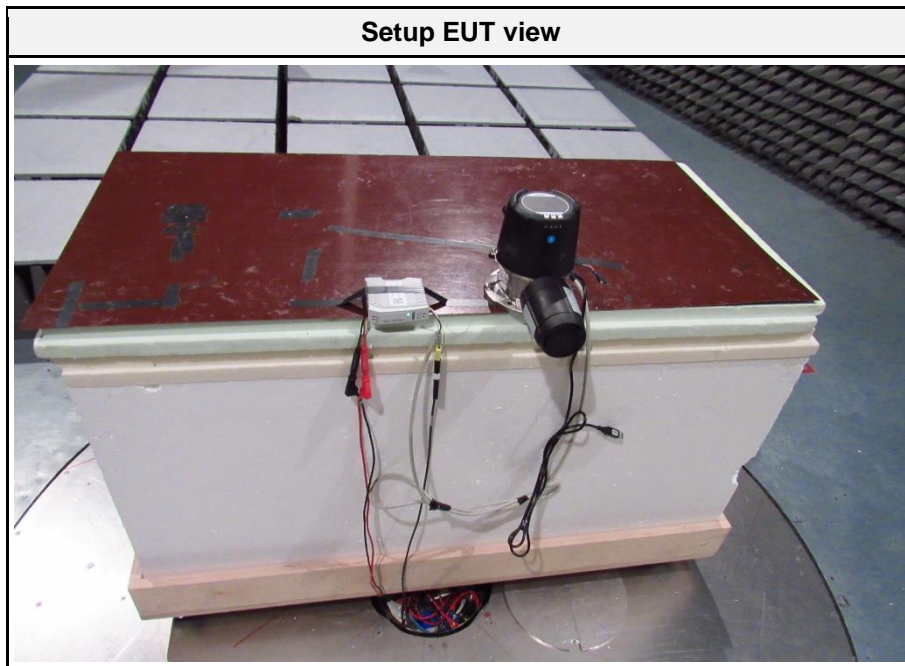

ANNEX A Transmitter spurious emissions

Radiated Spurious Emissions according to RSS-247, 47 CFR Part 15.247

Project Number: G0M-2103-9685
 Applicant: Dräger Safety AG & Co. KGaA
 Model Description: Fixed Gas Detector
 Model: Polytron 6100 EC WL
 Test Sample ID: 35067
 Test Site: Eurofins Product Service GmbH
 Operator: Mr. Voigt
 Measurement software: RadiMation, version 2020.1.8
 Test Conditions: Tnom: 23 °Celsius, Vnom: 120 VAC converted to 24 VDC
 Antenna: Rohde & Schwarz HK 116
 Measurement distance: 3 m
 Mode: Tx; DSSS QPSK, 2405MHz
 Test Date: 2021-09-24
 Note:

Index 20

RadiMation

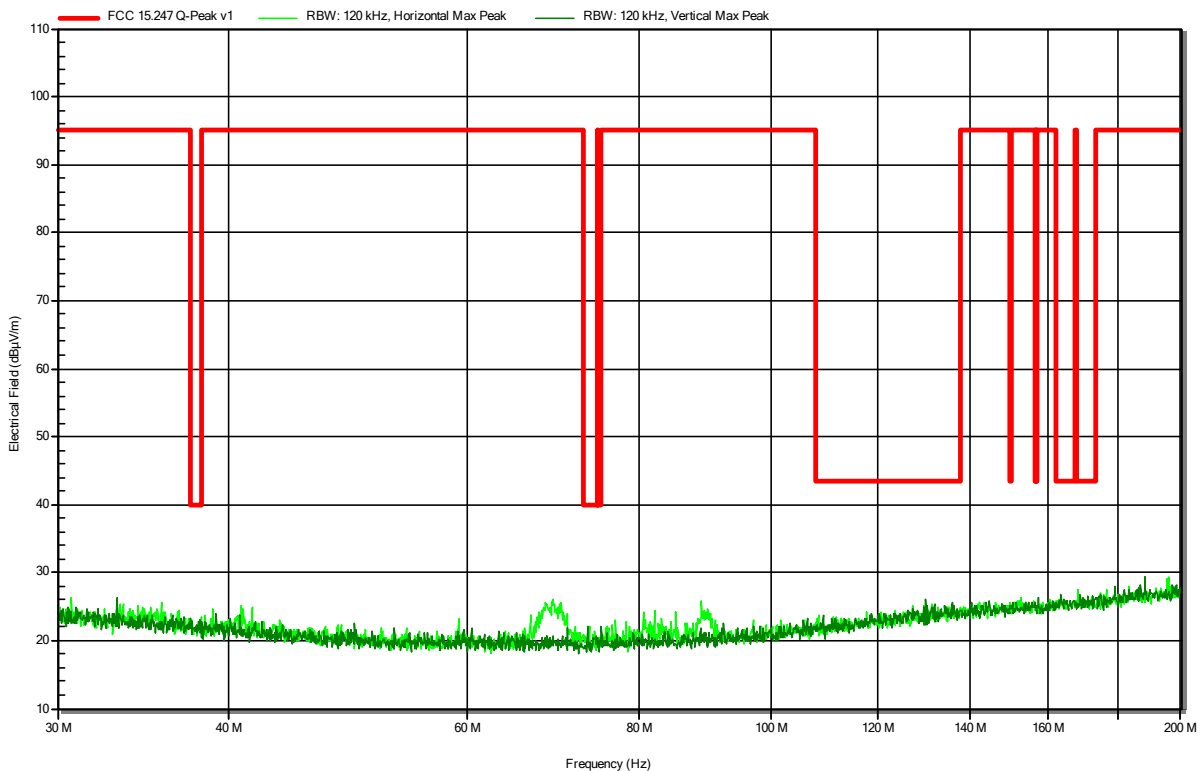

Radiated Spurious Emissions according to RSS-247, 47 CFR Part 15.247

Project Number: G0M-2103-9685
 Applicant: Dräger Safety AG & Co. KGaA
 Model Description: Fixed Gas Detector
 Model: Polytron 6100 EC WL
 Test Sample ID: 35067
 Test Site: Eurofins Product Service GmbH
 Operator: Mr. Voigt
 Measurement software: RadiMation, version 2020.1.8
 Test Conditions: Tnom: 23 °Celsius, Vnom: 120 VAC converted to 24 VDC
 Antenna: Rohde & Schwarz HL 223
 Measurement distance: 3 m
 Mode: Tx; DSSS QPSK, 2405MHz
 Test Date: 2021-09-24
 Note:

Index 19

RadiMation

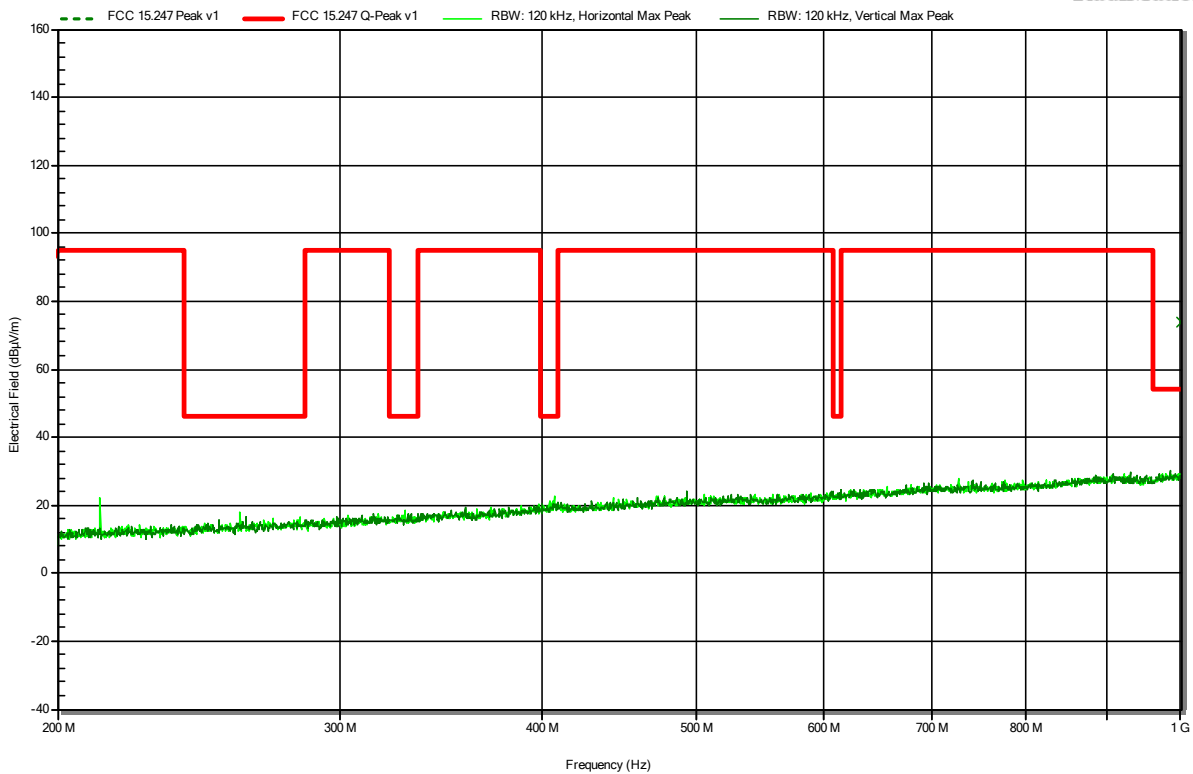

Radiated Spurious Emissions according to RSS-247, 47 CFR Part 15.247

Project Number: G0M-2103-9685
 Applicant: Dräger Safety AG & Co. KGaA
 Model Description: Fixed Gas Detector
 Model: Polytron 6100 EC WL
 Test Sample ID: 35067
 Test Site: Eurofins Product Service GmbH
 Operator: Mr. Voigt
 Measurement software: RadiMation, version 2020.1.8
 Test Conditions: Tnom: 23 °Celsius, Vnom: 120 VAC converted to 24 VDC
 Antenna: Schwarzbeck BBHA 9120D
 Measurement distance: 3 m
 Mode: Tx; DSSS QPSK, 2405MHz
 Test Date: 2021-09-23
 Note:

Index 8

RadiMation

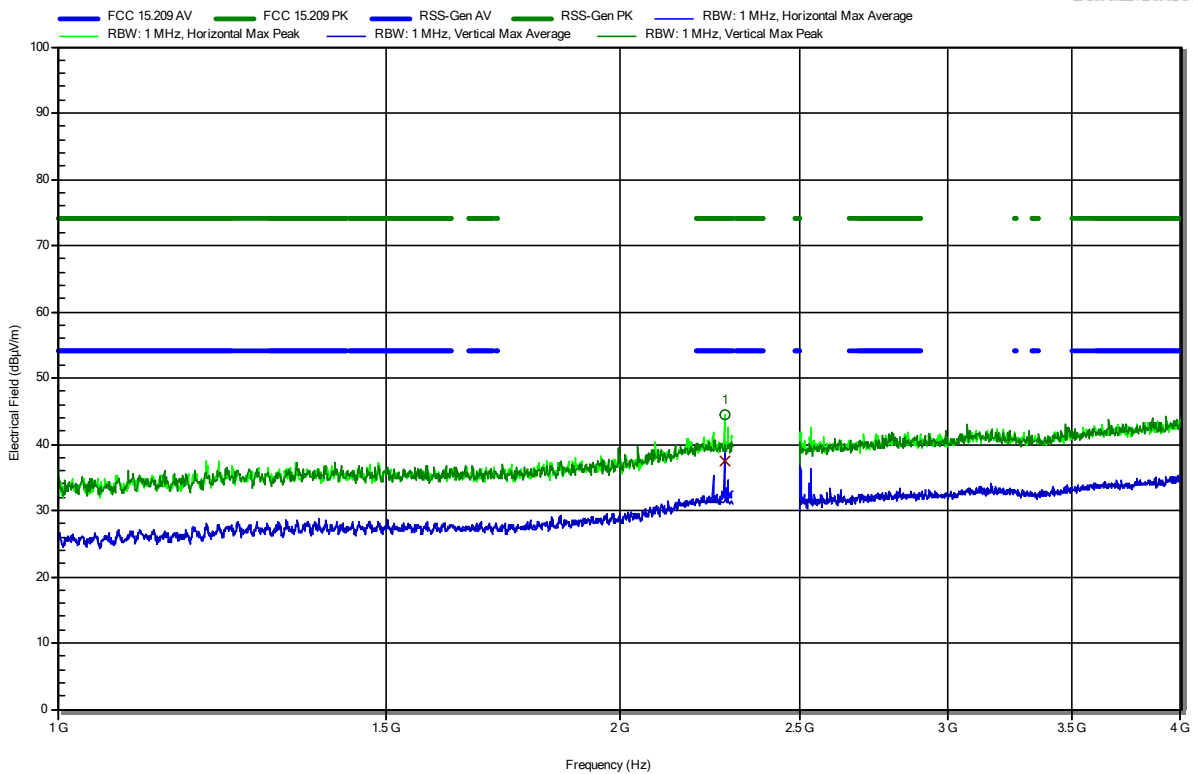

Frequency	Peak	Peak Limit	Peak Difference	Peak Status	Polarization
2.2774 GHz	44.52 dBµV/m	74 dBµV/m	-29.48 dB	Pass	Horizontal
Frequency	Average	Average Limit	Average Difference	Average Status	Polarization
2.2774 GHz	37.4 dBµV/m	54 dBµV/m	-16.6 dB	Pass	Horizontal

Test Report No.: G0M-2103-9685-TFC247ZB-V01

Eurofins Product Service GmbH
 Storkower Str. 38c, D-15526 Reichenwalde, Germany

Radiated Spurious Emissions according to RSS-247, 47 CFR Part 15.247

Project Number: G0M-2103-9685
 Applicant: Dräger Safety AG & Co. KGaA
 Model Description: Fixed Gas Detector
 Model: Polytron 6100 EC WL
 Test Sample ID: 35067
 Test Site: Eurofins Product Service GmbH
 Operator: Mr. Voigt
 Measurement software: RadiMation, version 2020.1.8
 Test Conditions: Tnom: 23 °Celsius, Vnom: 120 VAC converted to 24 VDC
 Antenna: Schwarzbeck BBHA 9120D
 Measurement distance: 3 m
 Mode: Tx; DSSS QPSK, 2405MHz
 Test Date: 2021-09-23
 Note: Lower band edge

Index 5

RadiMation

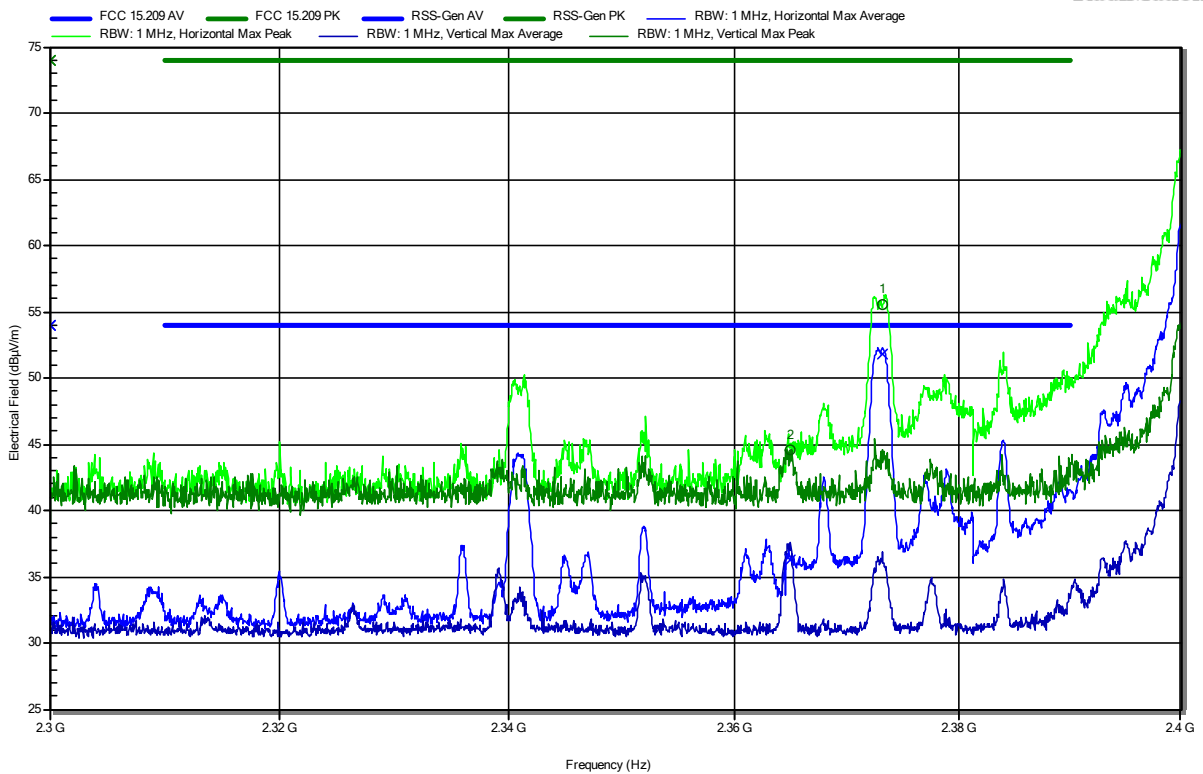

Frequency	Peak	Peak Limit	Peak Difference	Peak Status	Polarization
2.365 GHz	44.53 dBµV/m	74 dBµV/m	-29.47 dB	Pass	Vertical
2.3732 GHz	55.54 dBµV/m	74 dBµV/m	-18.46 dB	Pass	Horizontal

Frequency	Average	Average Limit	Average Difference	Average Status	Polarization
2.365 GHz	36.21 dBµV/m	54 dBµV/m	-17.79 dB	Pass	Vertical
2.3732 GHz	51.8 dBµV/m	54 dBµV/m	-2.2 dB	Pass	Horizontal

Test Report No.: G0M-2103-9685-TFC247ZB-V01

Eurofins Product Service GmbH
 Storkower Str. 38c, D-15526 Reichenwalde, Germany

Radiated Spurious Emissions according to RSS-247, 47 CFR Part 15.247

Project Number: G0M-2103-9685
 Applicant: Dräger Safety AG & Co. KGaA
 Model Description: Fixed Gas Detector
 Model: Polytron 6100 EC WL
 Test Sample ID: 35067
 Test Site: Eurofins Product Service GmbH
 Operator: Mr. Voigt
 Measurement software: RadiMation, version 2020.1.8
 Test Conditions: Tnom: 23 °Celsius, Vnom: 120 VAC converted to 24 VDC
 Antenna: Schwarzbeck BBHA 9120D
 Measurement distance: 3 m
 Mode: Tx; DSSS QPSK, 2405MHz
 Test Date: 2021-09-24
 Note: Lower band edge, EUT vertical

Index 14

RadiMation

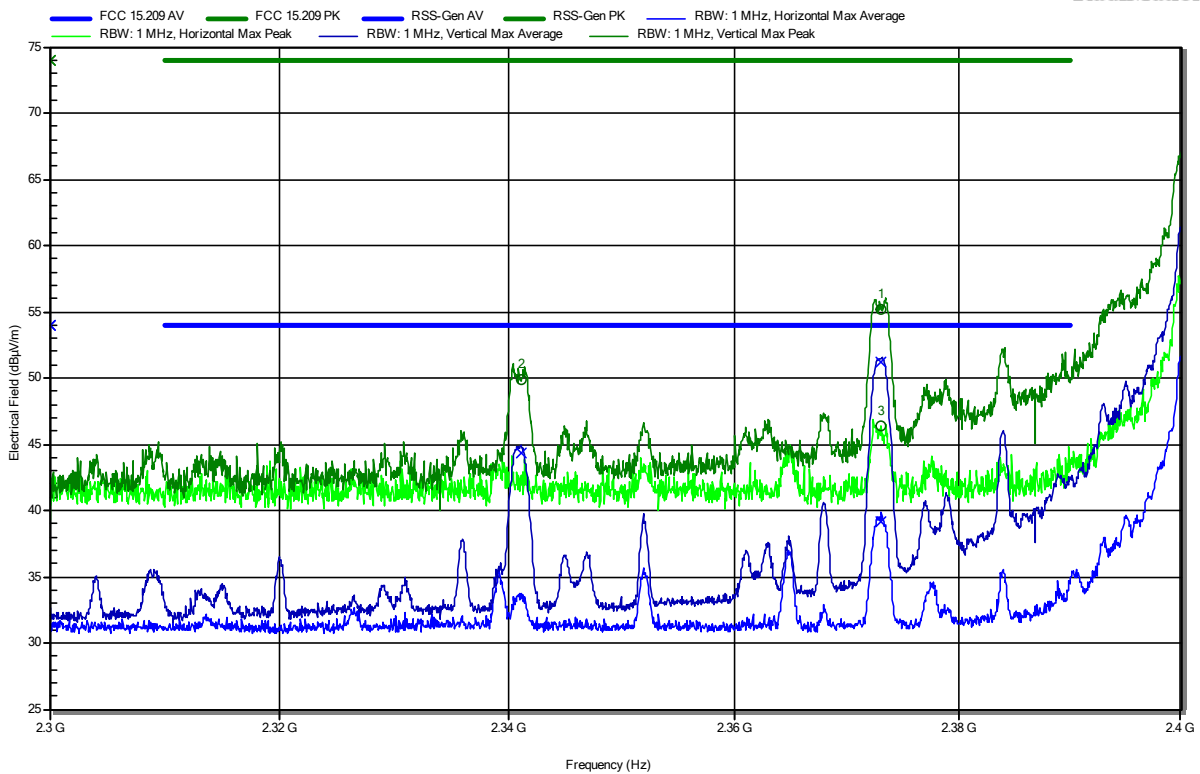

Frequency	Peak	Peak Limit	Peak Difference	Peak Status	Polarization
2.3411 GHz	49.91 dBµV/m	74 dBµV/m	-24.09 dB	Pass	Vertical
2.373 GHz	55.23 dBµV/m	74 dBµV/m	-18.77 dB	Pass	Vertical
2.3731 GHz	46.41 dBµV/m	74 dBµV/m	-27.59 dB	Pass	Horizontal

Frequency	Average	Average Limit	Average Difference	Average Status	Polarization
2.3411 GHz	44.36 dBµV/m	54 dBµV/m	-9.64 dB	Pass	Vertical
2.373 GHz	51.21 dBµV/m	54 dBµV/m	-2.79 dB	Pass	Vertical
2.3731 GHz	39.16 dBµV/m	54 dBµV/m	-14.84 dB	Pass	Horizontal

Test Report No.: G0M-2103-9685-TFC247ZB-V01

Eurofins Product Service GmbH
 Storkower Str. 38c, D-15526 Reichenwalde, Germany

Radiated Spurious Emissions according to RSS-247, 47 CFR Part 15.247

Project Number: G0M-2103-9685
 Applicant: Dräger Safety AG & Co. KGaA
 Model Description: Fixed Gas Detector
 Model: Polytron 6100 EC WL
 Test Sample ID: 35067
 Test Site: Eurofins Product Service GmbH
 Operator: Mr. Voigt
 Measurement software: RadiMation, version 2020.1.8
 Test Conditions: Tnom: 23 °Celsius, Vnom: 120 VAC converted to 24 VDC
 Antenna: Schwarzbeck BBHA 9120D
 Measurement distance: 3 m
 Mode: Tx; DSSS QPSK, 2405MHz
 Test Date: 2021-09-23
 Note:

Index 7

RadiMation

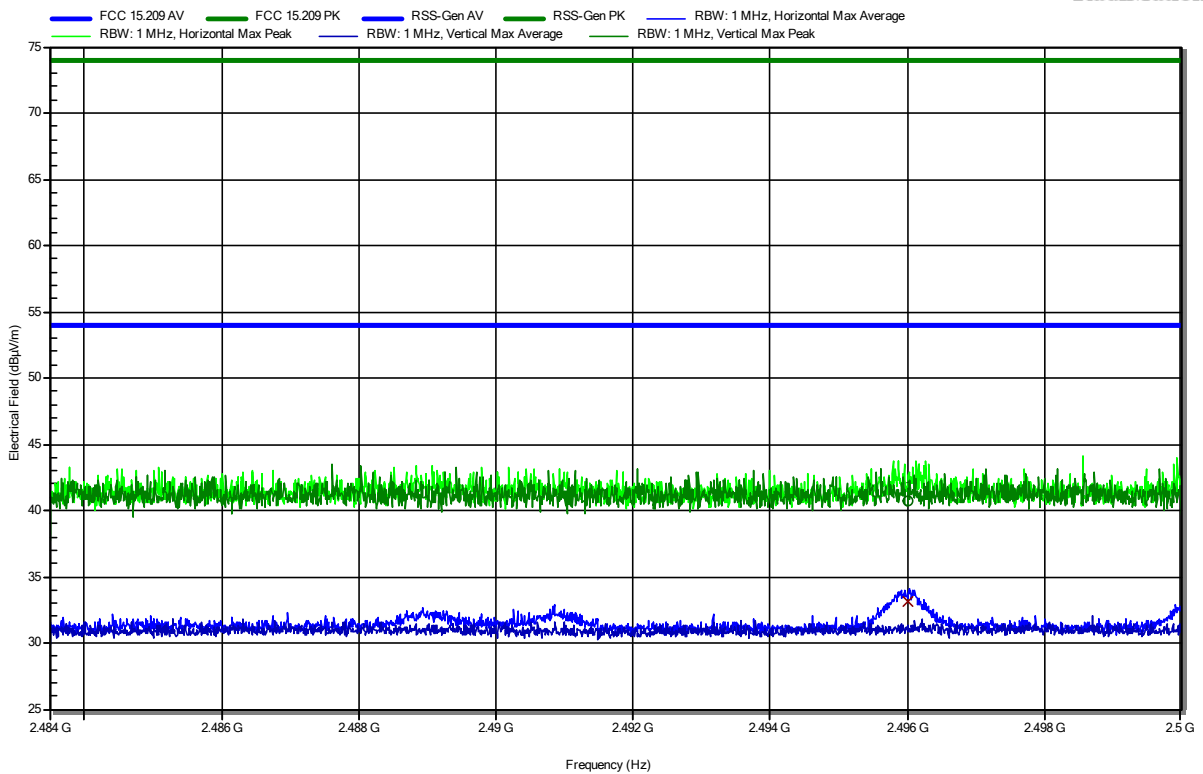

Frequency	Peak	Peak Limit	Peak Difference	Peak Status	Polarization
2.496 GHz	40.7 dBµV/m	74 dBµV/m	-33.3 dB	Pass	Horizontal
Frequency	Average	Average Limit	Average Difference	Average Status	Polarization
2.496 GHz	33.13 dBµV/m	54 dBµV/m	-20.87 dB	Pass	Horizontal

Radiated Spurious Emissions according to RSS-247, 47 CFR Part 15.247

Project Number: G0M-2103-9685
 Applicant: Dräger Safety AG & Co. KGaA
 Model Description: Fixed Gas Detector
 Model: Polytron 6100 EC WL
 Test Sample ID: 35067
 Test Site: Eurofins Product Service GmbH
 Operator: Mr. Voigt
 Measurement software: RadiMation, version 2020.1.8
 Test Conditions: Tnom: 23 °Celsius, Vnom: 120 VAC converted to 24 VDC
 Antenna: Schwarzbeck BBHA 9120D
 Measurement distance: 3 m
 Mode: Tx; DSSS QPSK, 2405MHz
 Test Date: 2021-09-23
 Note:

Index 13

RadiMation

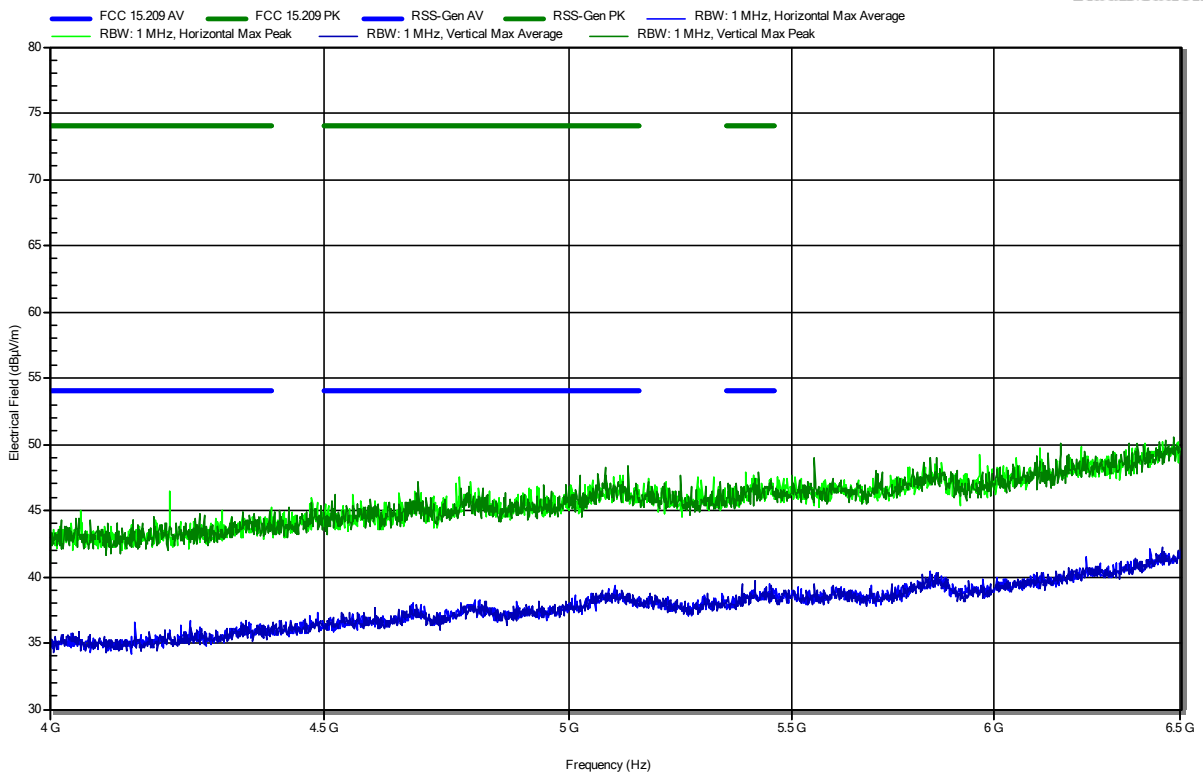

Radiated Spurious Emissions according to RSS-247, 47 CFR Part 15.247

Project Number: G0M-2103-9685
 Applicant: Dräger Safety AG & Co. KGaA
 Model Description: Fixed Gas Detector
 Model: Polytron 6100 EC WL
 Test Sample ID: 35067
 Test Site: Eurofins Product Service GmbH
 Operator: Mr. Voigt
 Measurement software: RadiMation, version 2020.1.8
 Test Conditions: Tnom: 23 °Celsius, Vnom: 120 VAC converted to 24 VDC
 Antenna: Schwarzbeck Schwarzbeck HWRD 650
 Measurement distance: 3 m
 Mode: Tx; DSSS QPSK, 2405MHz
 Test Date: 2021-09-23

Index 9

RadiMation

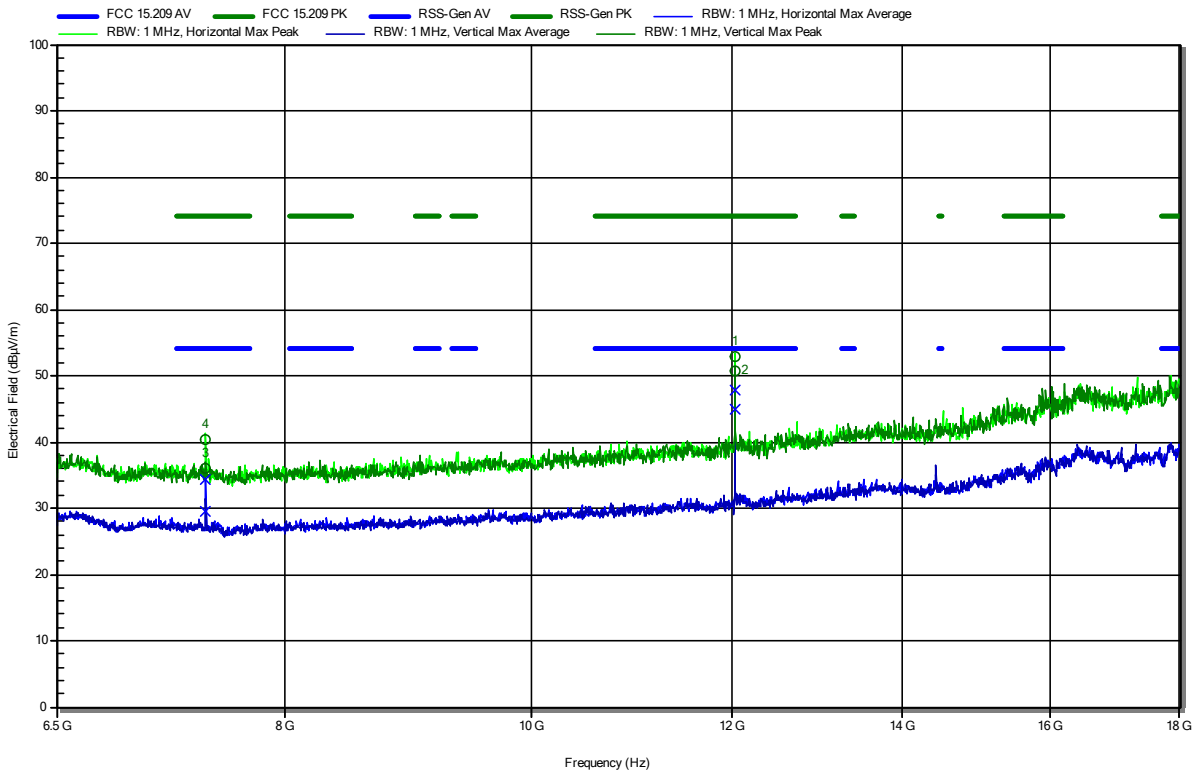

Frequency	Peak	Peak Limit	Peak Difference	Peak Status	Polarization
7.44 GHz	36.06 dBµV/m	74 dBµV/m	-37.94 dB	Pass	Vertical
7.441 GHz	40.42 dBµV/m	74 dBµV/m	-33.58 dB	Pass	Horizontal
12.027 GHz	50.73 dBµV/m	74 dBµV/m	-23.27 dB	Pass	Vertical
12.027 GHz	52.99 dBµV/m	74 dBµV/m	-21.01 dB	Pass	Horizontal

Frequency	Average	Average Limit	Average Difference	Average Status	Polarization
7.44 GHz	29.51 dBµV/m	54 dBµV/m	-24.49 dB	Pass	Vertical
7.441 GHz	34.36 dBµV/m	54 dBµV/m	-19.64 dB	Pass	Horizontal
12.027 GHz	44.82 dBµV/m	54 dBµV/m	-9.18 dB	Pass	Vertical
12.027 GHz	47.91 dBµV/m	54 dBµV/m	-6.09 dB	Pass	Horizontal

Test Report No.: G0M-2103-9685-TFC247ZB-V01

Eurofins Product Service GmbH
 Storkower Str. 38c, D-15526 Reichenwalde, Germany

Radiated Spurious Emissions according to RSS-247, 47 CFR Part 15.247

Project Number: G0M-2103-9685
 Applicant: Dräger Safety AG & Co. KGaA
 Model Description: Fixed Gas Detector
 Model: Polytron 6100 EC WL
 Test Sample ID: 35067
 Test Site: Eurofins Product Service GmbH
 Operator: Mr. Voigt
 Measurement software: RadiMation, version 2020.1.8
 Test Conditions: Tnom: 23 °Celsius, Vnom: 120 VAC converted to 24 VDC
 Antenna: Schwarzbeck Schwarzbeck HWRD 650
 Measurement distance: 3 m
 Mode: Tx; DSSS QPSK, 2405MHz
 Test Date: 2021-09-24
 Note: EUT vertical

Index 15

RadiMation

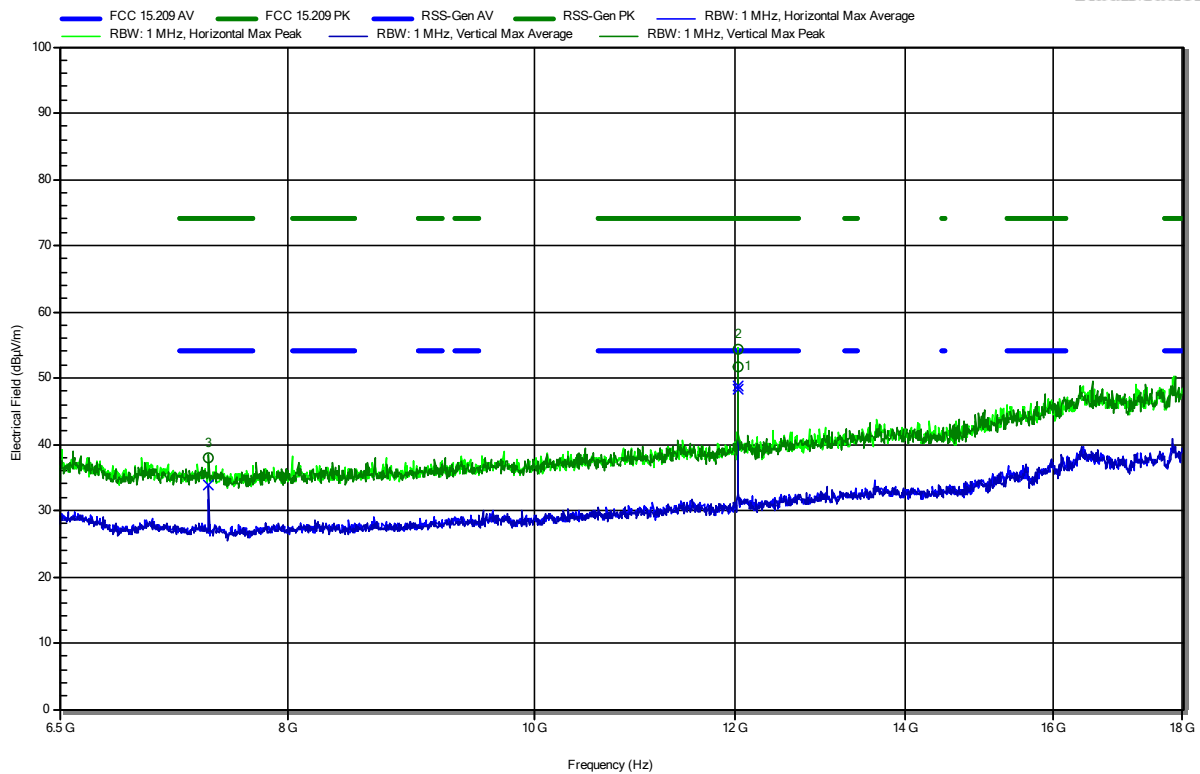

Frequency	Peak	Peak Limit	Peak Difference	Peak Status	Polarization
7.441 GHz	37.85 dBµV/m	74 dBµV/m	-36.15 dB	Pass	Vertical
12.023 GHz	51.65 dBµV/m	74 dBµV/m	-22.35 dB	Pass	Vertical
12.027 GHz	54.25 dBµV/m	74 dBµV/m	-19.75 dB	Pass	Horizontal

Frequency	Average	Average Limit	Average Difference	Average Status	Polarization
7.441 GHz	33.87 dBµV/m	54 dBµV/m	-20.13 dB	Pass	Vertical
12.023 GHz	48.33 dBµV/m	54 dBµV/m	-5.67 dB	Pass	Vertical
12.027 GHz	48.82 dBµV/m	54 dBµV/m	-5.18 dB	Pass	Horizontal

Test Report No.: G0M-2103-9685-TFC247ZB-V01

Eurofins Product Service GmbH
 Storkower Str. 38c, D-15526 Reichenwalde, Germany

Radiated Spurious Emissions according to RSS-247, 47 CFR Part 15.247

Project Number: G0M-2103-9685
 Applicant: Dräger Safety AG & Co. KGaA
 Model Description: Fixed Gas Detector
 Model: Polytron 6100 EC WL
 Test Sample ID: 35067
 Test Site: Eurofins Product Service GmbH
 Operator: Mr. Voigt
 Measurement software: RadiMation, version 2020.1.8
 Test Conditions: Tnom: 23 °Celsius, Vnom: 120 VAC converted to 24 VDC
 Antenna: Configurable Antenna
 Measurement distance: 3 m
 Mode: Tx; DSSS QPSK, 2405MHz
 Test Date: 2021-09-23
 Note:

Index 11

RadiMation

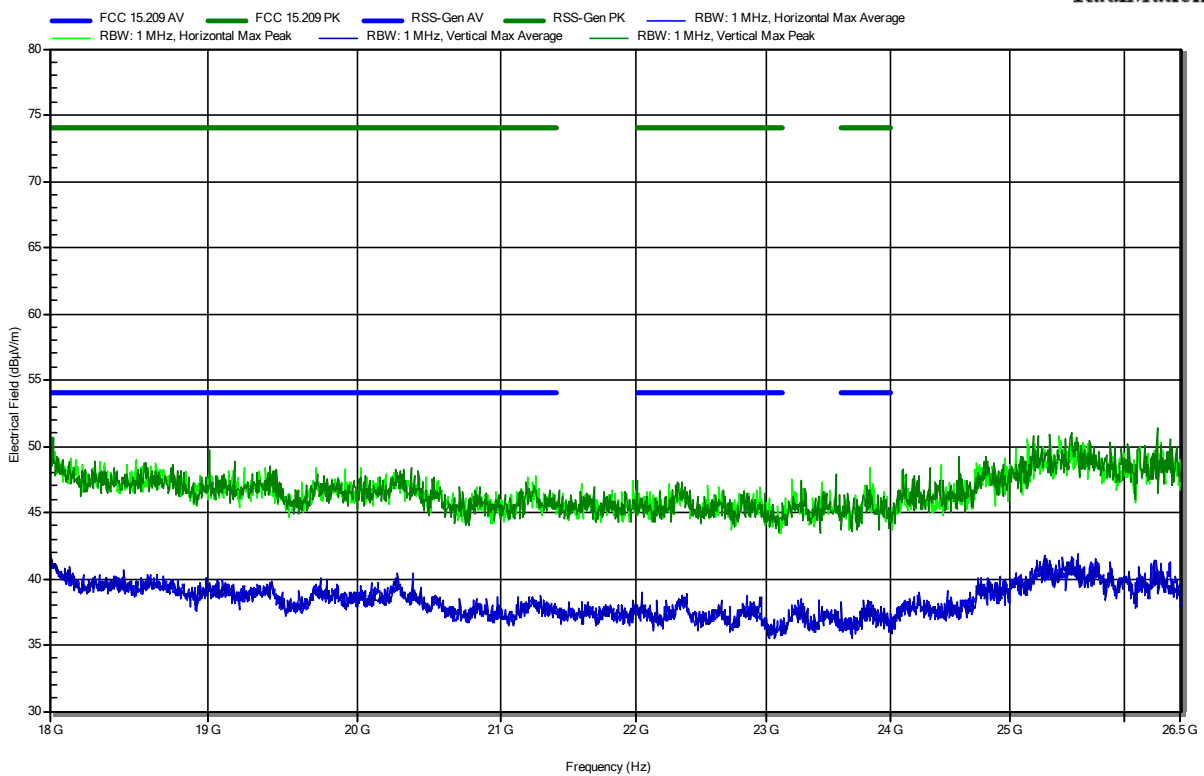

ANNEX B Receiver spurious emissions

Radiated Spurious Emissions according to RSS-247, 47 CFR Part 15.247

Project Number: G0M-2103-9685
 Applicant: Dräger Safety AG & Co. KGaA
 Model Description: Fixed Gas Detector
 Model: Polytron 6100 EC WL
 Test Sample ID: 35067
 Test Site: Eurofins Product Service GmbH
 Operator: Mr. Voigt
 Measurement software: RadiMation, version 2020.1.8
 Test Conditions: Tnom: 23 °Celsius, Vnom: 120 VAC converted 24 VDC
 Antenna: Rohde & Schwarz HK 116
 Measurement distance: 3 m
 Mode: Rx; Receive, 2405 MHz
 Test Date: 2021-09-24
 Note:

Index 22

RadiMation

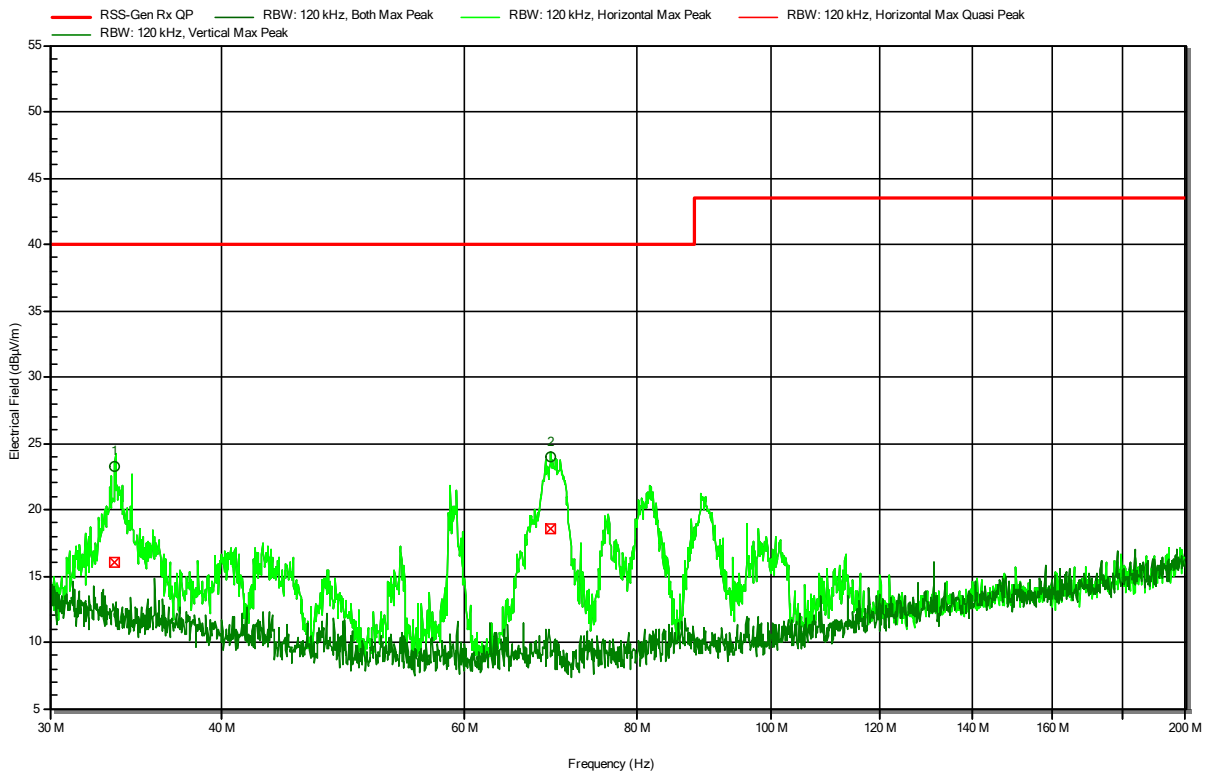

Frequency	Peak	Peak Limit	Peak Difference	Peak Status	Polarization
33.4552 MHz	23.2 dBµV/m	40 dBµV/m	-16.8 dB	Pass	Horizontal
69.2445 MHz	24 dBµV/m	40 dBµV/m	-16.01 dB	Pass	Horizontal

Frequency	Quasi-Peak	Quasi-Peak Limit	Quasi-Peak Difference	Quasi-Peak Status	Polarization
33.4552 MHz	16.1 dBµV/m	40 dBµV/m	-23.93 dB	Pass	Horizontal
69.2445 MHz	18.5 dBµV/m	40 dBµV/m	-21.49 dB	Pass	Horizontal

Test Report No.: G0M-2103-9685-TFC247ZB-V01

Eurofins Product Service GmbH
 Storkower Str. 38c, D-15526 Reichenwalde, Germany

Radiated Spurious Emissions according to RSS-247, 47 CFR Part 15.247

Project Number: G0M-2103-9685
 Applicant: Dräger Safety AG & Co. KGaA
 Model Description: Fixed Gas Detector
 Model: Polytron 6100 EC WL
 Test Sample ID: 35067
 Test Site: Eurofins Product Service GmbH
 Operator: Mr. Voigt
 Measurement software: RadiMation, version 2020.1.8
 Test Conditions: Tnom: 23 °Celsius, Vnom: 120 VAC converted 24 VDC
 Antenna: Rohde & Schwarz HL 223
 Measurement distance: 3 m
 Mode: Rx; Receive, 2405 MHz
 Test Date: 2021-09-24
 Note:

Index 23

RadiMation

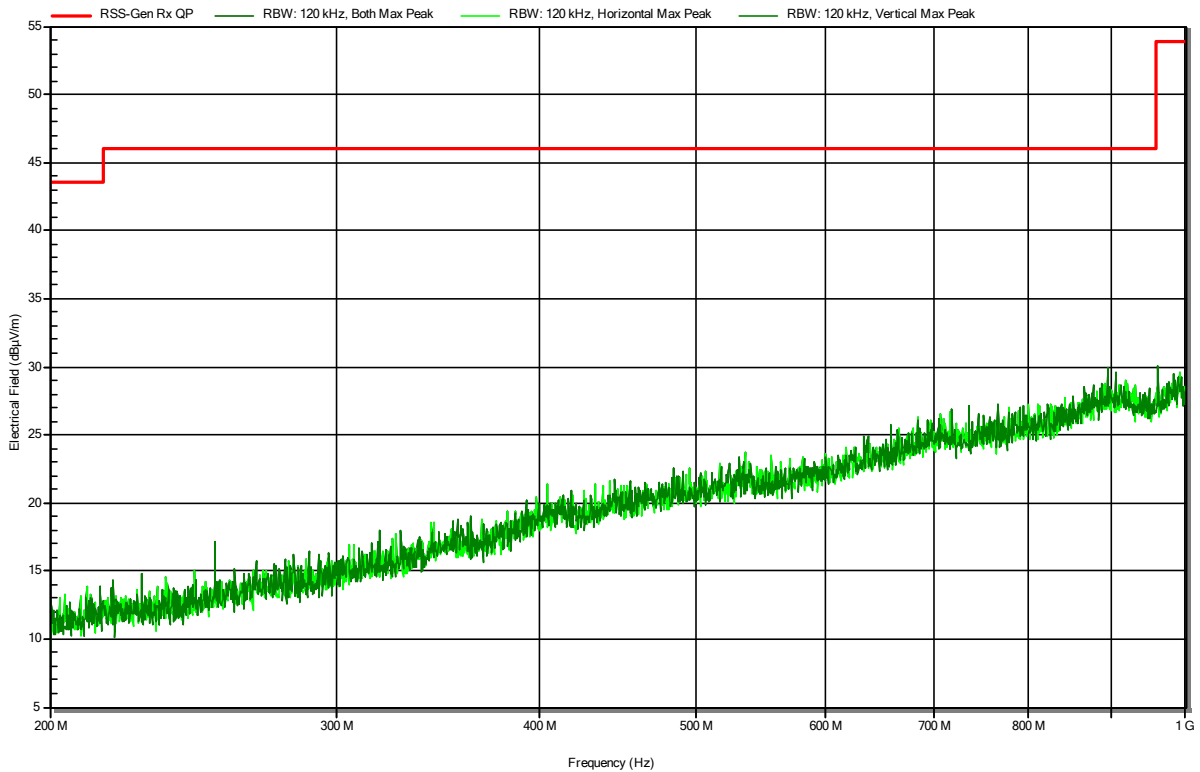

Radiated Spurious Emissions according to RSS-247, 47 CFR Part 15.247

Project Number: G0M-2103-9685
 Applicant: Dräger Safety AG & Co. KGaA
 Model Description: Fixed Gas Detector
 Model: Polytron 6100 EC WL
 Test Sample ID: 35067
 Test Site: Eurofins Product Service GmbH
 Operator: Mr. Voigt
 Measurement software: RadiMation, version 2020.1.8
 Test Conditions: Tnom: 23 °Celsius, Vnom: 120 VAC converted 24 VDC
 Antenna: Schwarzbeck BBHA 9120D
 Measurement distance: 3 m
 Mode: Rx; Receive, 2405 MHz
 Test Date: 2021-09-24
 Note:

Index 17

RadiMation

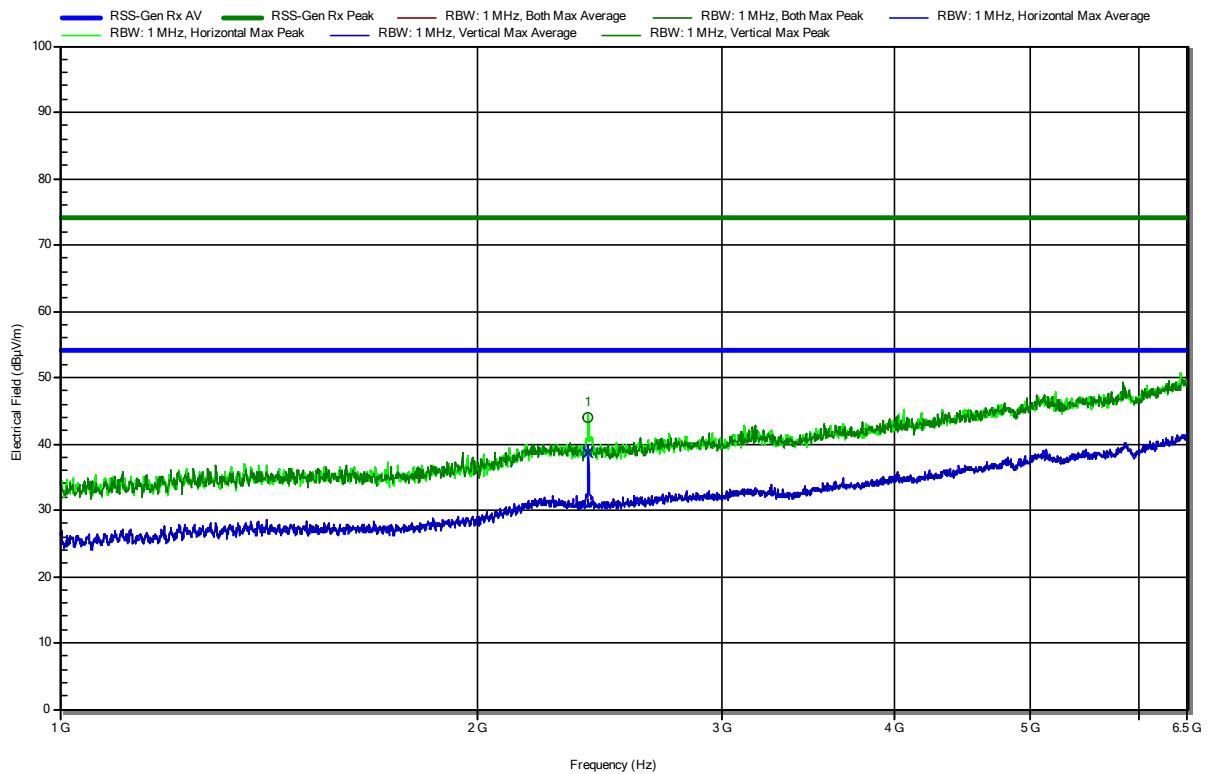

Frequency	Peak	Peak Limit	Peak Difference	Peak Status	Polarization
2.403 GHz	44.07 dBµV/m	73.98 dBµV/m	-29.91 dB	Pass	Horizontal
Frequency	Average	Average Limit	Average Difference	Average Status	Polarization
2.403 GHz	38.73 dBµV/m	53.98 dBµV/m	-15.25 dB	Pass	Horizontal

Radiated Spurious Emissions according to RSS-247, 47 CFR Part 15.247

Project Number: G0M-2103-9685
 Applicant: Dräger Safety AG & Co. KGaA
 Model Description: Fixed Gas Detector
 Model: Polytron 6100 EC WL
 Test Sample ID: 35067
 Test Site: Eurofins Product Service GmbH
 Operator: Mr. Voigt
 Measurement software: RadiMation, version 2020.1.8
 Test Conditions: Tnom: 23 °Celsius, Vnom: 120 VAC converted 24 VDC
 Antenna: Schwarzbeck Schwarzbeck HWRD 650
 Measurement distance: 3 m
 Mode: Rx; Receive, 2405 MHz
 Test Date: 2021-09-24
 Note:

Index 16

RadiMation

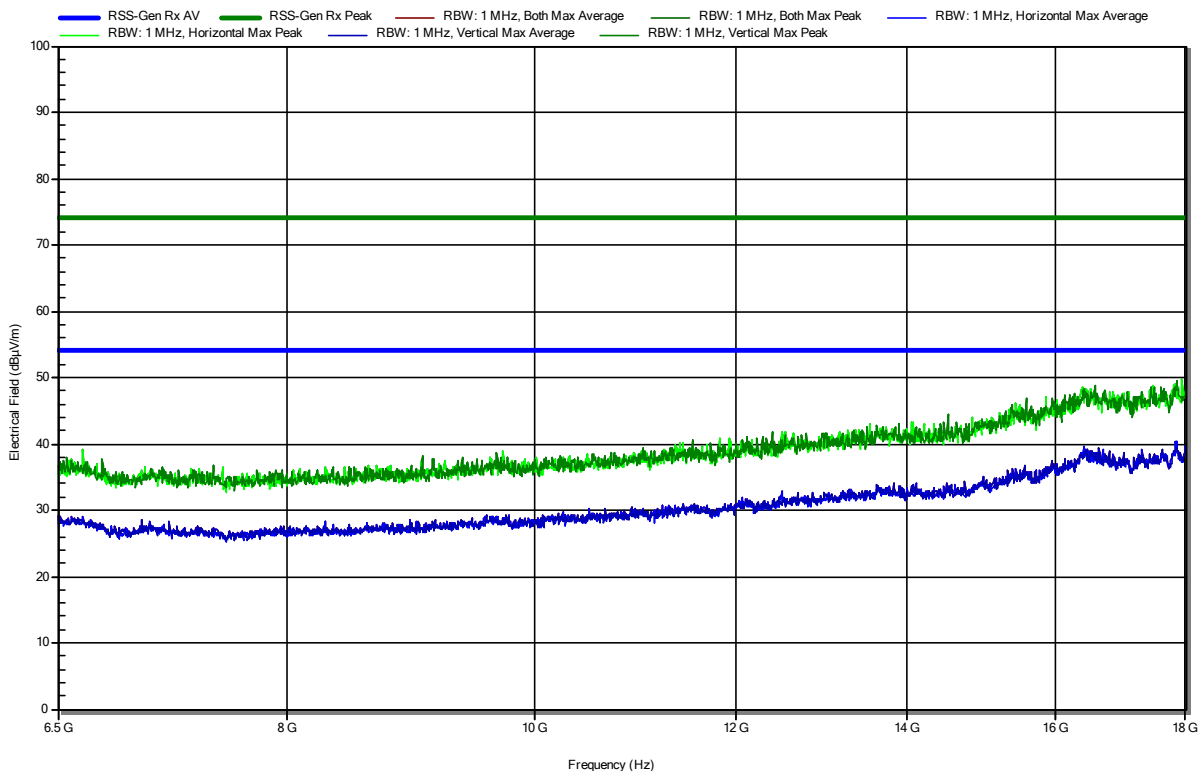

=== End of test report ===