

<b>EMC TEST REPORT</b> Title 47 CFR Part 15B, ISED ICES-003 Issue 7	
<b>Report Reference No</b>	G0M-2103-9685-EF0215B-V01
<b>Testing Laboratory</b>	Eurofins Product Service GmbH
<b>Address</b>	Storkower Str. 38c 15526 Reichenwalde Germany
<b>Accreditation</b>	    <p>                         A2LA - Registration number: 1983.01 (ISED)                          ISED wireless device testing laboratory: CN 3470A                          DAkKS - Registration number : D-PL-12092-01-04 (FCC)                          FCC Filed Test Laboratory, Reg.-No.: 96970                     </p>
<b>Applicant</b>	Dräger Safety AG & Co. KGaA
<b>Address</b>	Revalstraße 1 23560 Lübeck GERMANY
<b>Test Specification Standard(s)</b>	Title 47 CFR Part 15 Subpart B ISED ICES-003 Issue 7 ANSI C63.4:2014+A1:2017
<b>Non-Standard Test Method</b>	None
<b>Equipment under Test (EUT):</b>	
<b>Product Description</b>	Polytron Repeater WirelessHART
<b>Model(s)</b>	Polytron Repeater WirelessHART
<b>Additional Model(s)</b>	None
<b>Brand Name(s)</b>	None
<b>Hardware Version(s)</b>	RC003
<b>Software Version(s)</b>	Polytron Repeater V1.5.0, Centro FW v1.5.02c, Bootloader V2.5.0, SW Telit BLT V3.12.002
<b>FCC-ID</b>	X6O-RC003
<b>IC</b>	5895F-RC003
<b>Test Result</b>	<b>PASSED</b>

<b>Possible test case verdicts:</b>		
required by standard but not tested	N/T	
not required by standard	N/R	
required by standard but not appl. to test object	N/A	
test object does meet the requirement	P(PASS)	
test object does not meet the requirement	F(FAIL)	
<b>Testing:</b>		
Date of receipt of test item	2021-05-04	
<b>Report:</b>		
Compiled by	Stephan Liebich	
Tested by (+ signature) (Responsible for Test)	Stephan Liebich	
Approved by (+ signature) (Test Lab Technician)	Andreas Pflug	
Date of Issue	2021-11-18	
Total number of pages	52	
<b>General Remarks:</b>		
<p>The test results presented in this report relate only to the object tested.</p> <p>The results contained in this report reflect the results for this particular model and serial number. It is the responsibility of the manufacturer to ensure that all production models meet the intent of the requirements detailed within this report.</p> <p>This report shall not be reproduced, except in full, without the written approval of the Issuing testing laboratory.</p>		
<b>Additional Comments:</b>		
--		

**ABBREVIATIONS AND ACRONYMS**

Acronyms	
Acronym	Description
EUT	Equipment Under Test
FCC	Federal Communications Commission
ISED	Innovation, Science and Economic Development Canada
T <sub>NOM</sub>	Nominal operating temperature
V <sub>NOM</sub>	Nominal supply voltage

## VERSION HISTORY

Version History			
Version	Issue Date	Remarks	Revised By
01	2021-11-18	Initial Release	

**REPORT INDEX**

<b>1</b>	<b>Equipment (Test Item) Under Test.....</b>	<b>6</b>
1.1	Equipment Ports.....	7
1.2	Equipment Photos - Internal.....	8
1.3	Equipment Photos - External.....	14
1.4	Support Equipment.....	22
1.5	Operational Modes.....	23
1.6	EUT Configuration.....	23
1.7	Sample emission level calculation.....	25
<b>2</b>	<b>Result Summary.....</b>	<b>26</b>
2.1	Test Conditions and Results - Radiated emissions acc. to ANSI C63.4.....	27
2.2	Test Conditions and Results - Conducted emissions acc. to ANSI C63.4.....	47
<b>3</b>	<b>Measurement Uncertainty .....</b>	<b>52</b>

## 1 Equipment (Test Item) Under Test

Description	The Polytron Repeater WirelessHART is used to forward data from other WirelessHART® network subscribers. The Polytron Repeater provides wireless signal transmission and power supply. The internal battery pack allows continuous operation for up to 24 months. This makes the repeater a flexible and cost-effective solution for system expansions, upgrades or new installations.	
Model	Polytron Repeater WirelessHART	
Additional Model(s)	None	
Brand Name(s)	None	
Serial Number(s)	Prototype DUT5	
Sample-ID	34489	
Hardware Version(s)	RC003	
Software Version(s)	Polytron Repeater V1.5.0, Centero FW v1.5.02c, Bootloader V2.5.0, SW Telit BLT V3.12.002	
EUT Dimensions [cm]	28 x 15 x 13	
FCC-ID	X6O-RC003	
IC	5895F-RC003	
Class	Class B	
Equipment type	Table top	
Highest internal frequency [MHz]	2483.5 (radio frequency) 32.0 (clock frequency)	
Radio Module 1	Type	Bluetooth Low Energy (LE)
	Model	BlueMod + S42 ATEX
	Manufacturer	Telit Communication
	FCC-ID	RFRMS42
	IC	4957A-MS42
Radio Module 2	Type	ZigBee (WHART)
	Model	Centero LLC
	Manufacturer	CW24-012
	FCC-ID	2ANDP-CW24-012
	IC	23069-CW24012
Supply Voltage	V <sub>NOM</sub>	24.0 V DC 14.4 V DC by not rechargeable Lithium battery
AC/DC-Adaptor	None	
Manufacturer	Dräger Safety AG & Co. KGaA Revalstraße 1 23560 Lübeck GERMANY	

**1.1 Equipment Ports**

Name	Type	Attributes	Comment
DC Mains	DC	Count: 1 Cable length [m]: >3 Direction: In Service only: No Shielded: No	Rated power between 10 V DC and 30 V DC, if none battery powered
Antenna	IO	Count: 1 Cable length [m]: 20 Direction: IO Service only: No Shielded: Yes	Cable length between 5 m and 20 m; Antenna is grounded to earth on both sides
Description:			
AC	AC mains power input/output port		
DC	DC power input/output port		
BAT	DC power input port connected to external battery		
IO	Input/Output port		
TP	Telecommunication port		
NE	Non-electrical port		

1.2 Equipment Photos - Internal

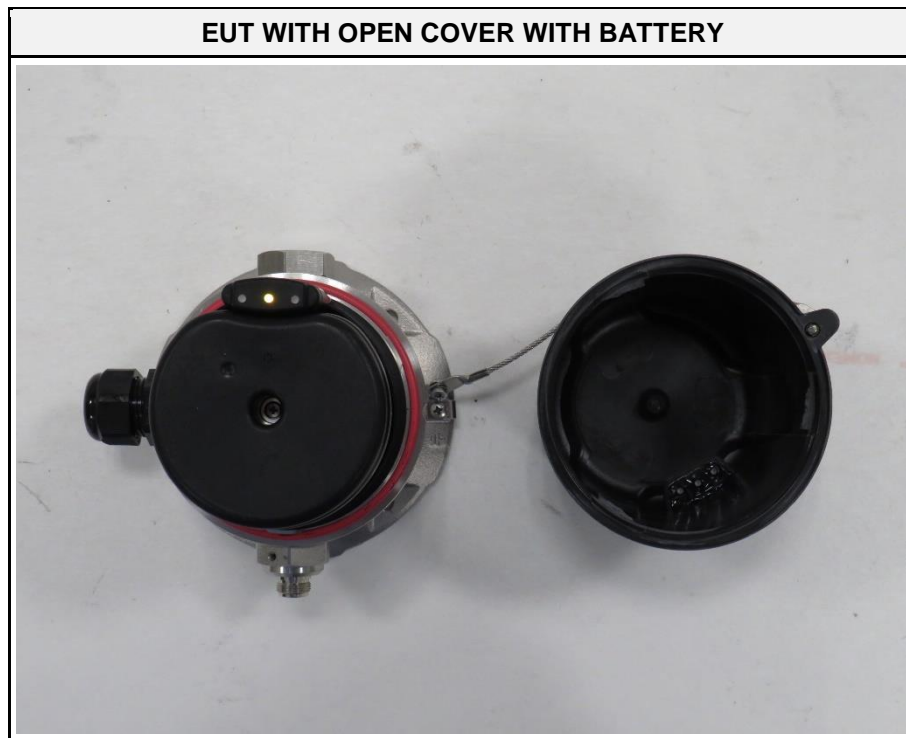



**EUT WITHOUT TOP COVER BUT WITH BATTERY**



**EUT WITHOUT TOP COVER AND BATTERY**



EUT WITHOUT BATTERY CASE BUT BATTERY POWERED

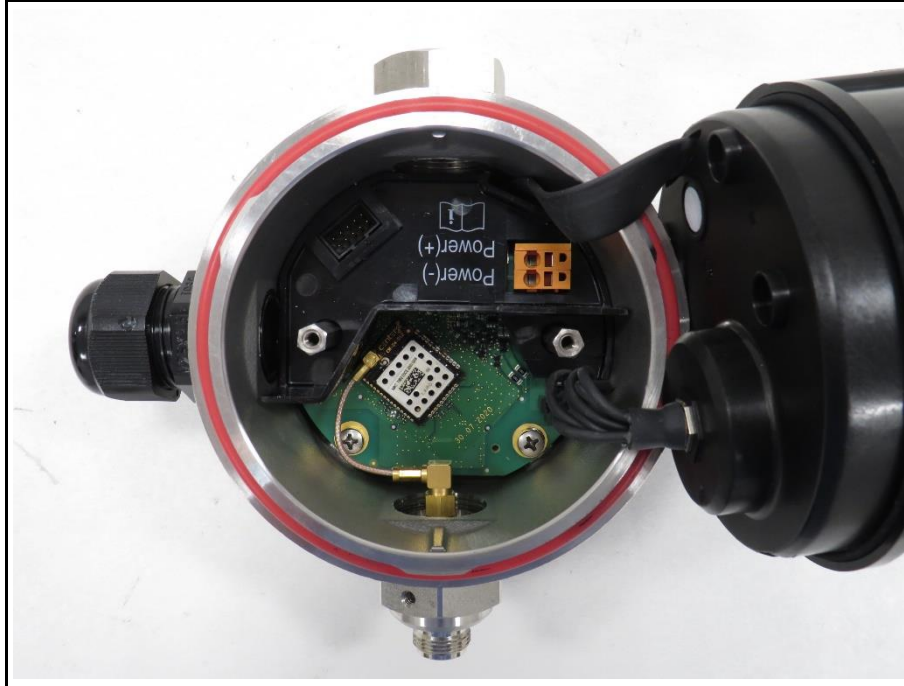

EUT WITHOUT BATTERY CASE BUT 24 V DC POWERED

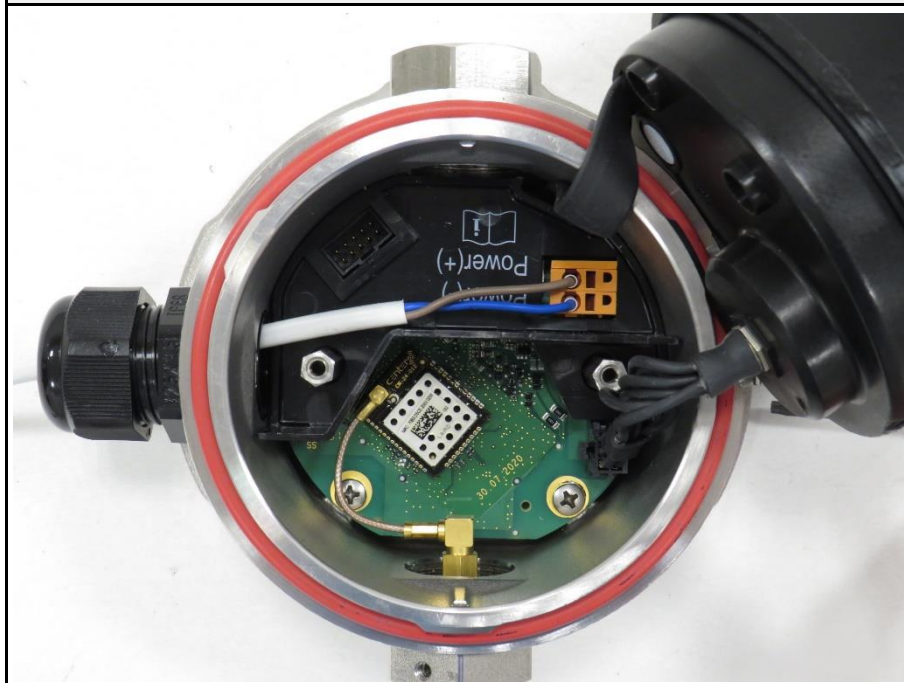

EUT PCB TOP SIDE

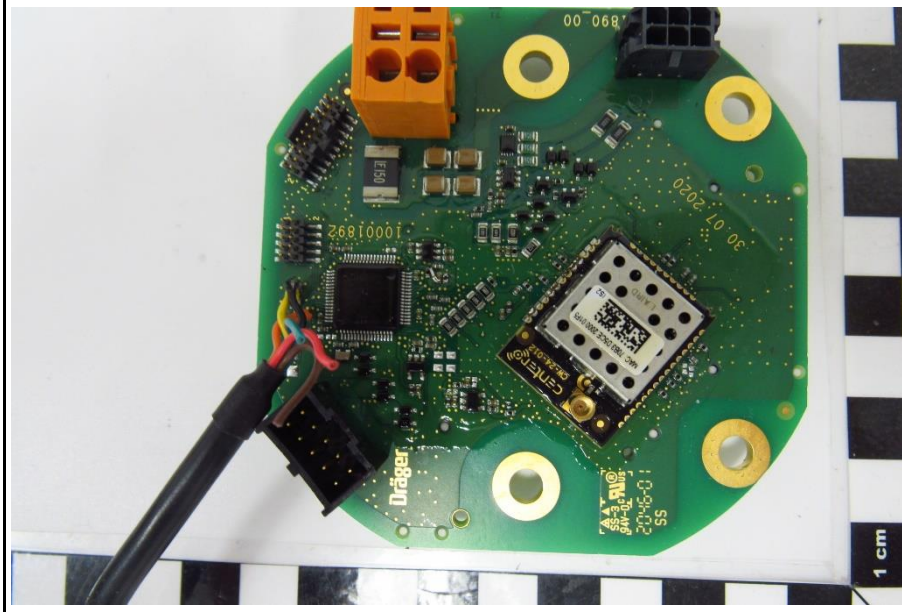

EUT PCB BOTTOM SIDE WITH COVER

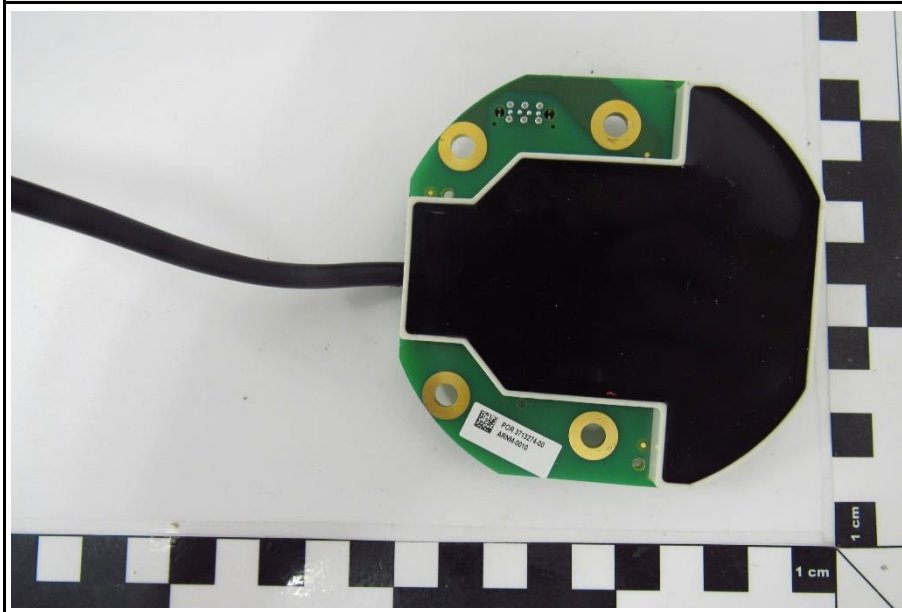



EUT PCB BOTTOM SIDE WITHOUT COVER

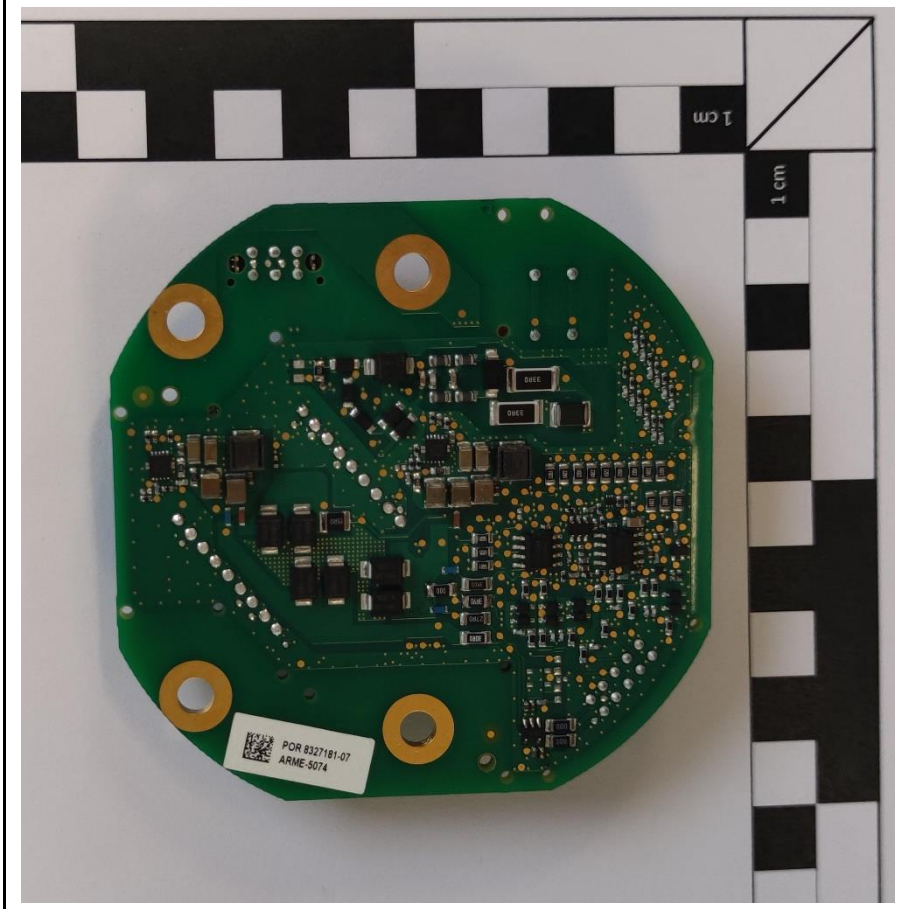

RADIO MODULE

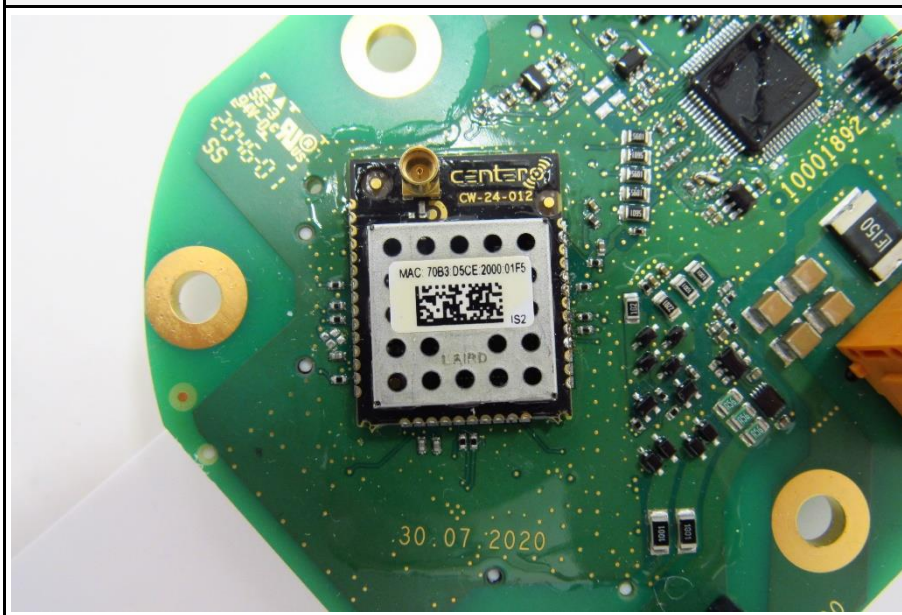

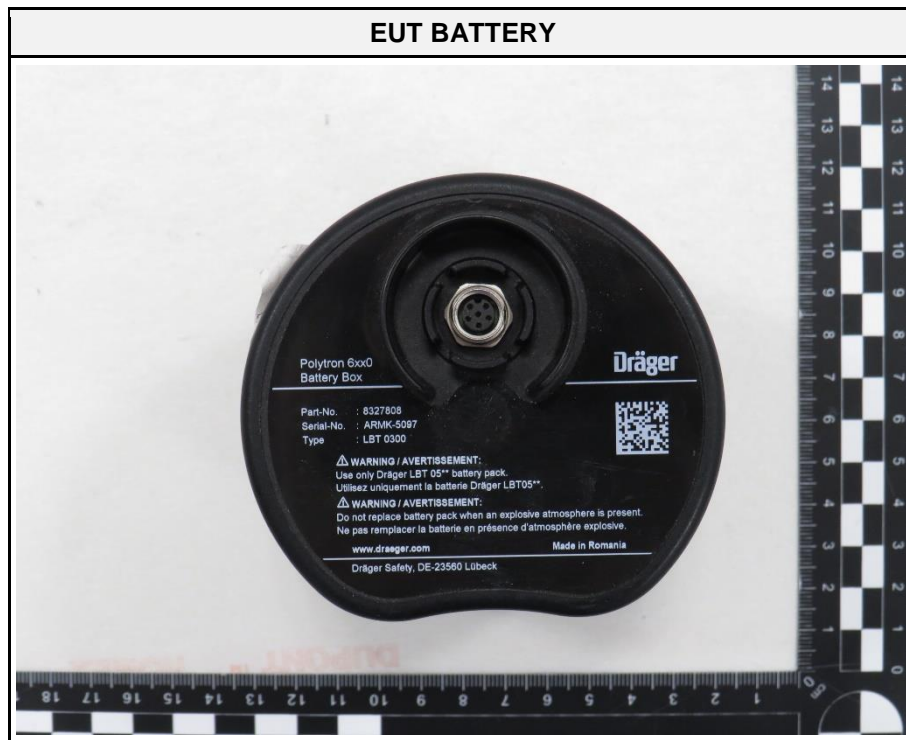

### 1.3 Equipment Photos - External

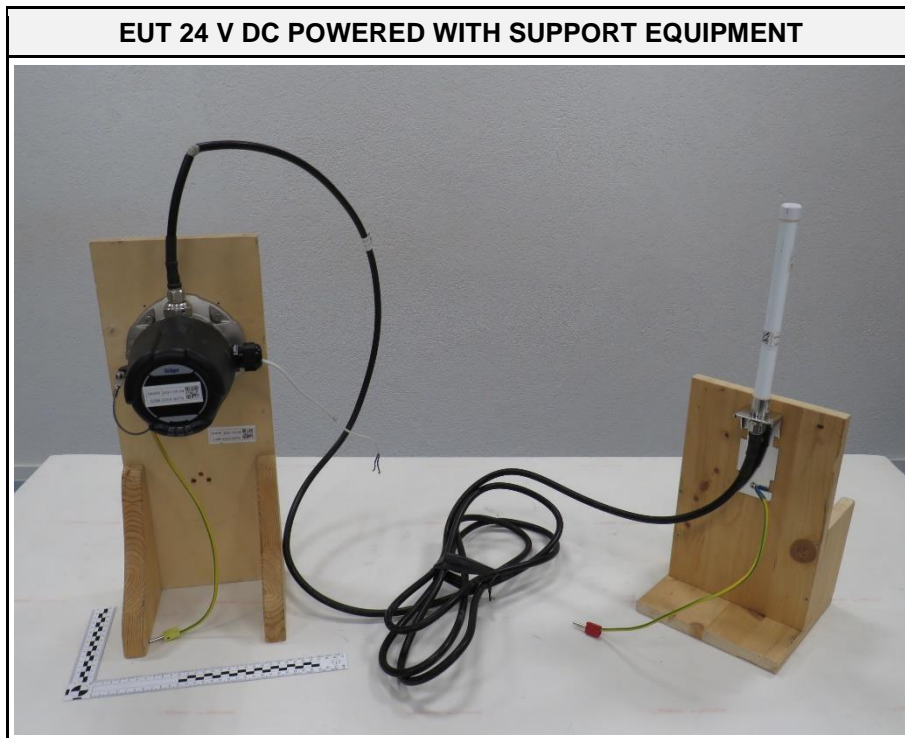
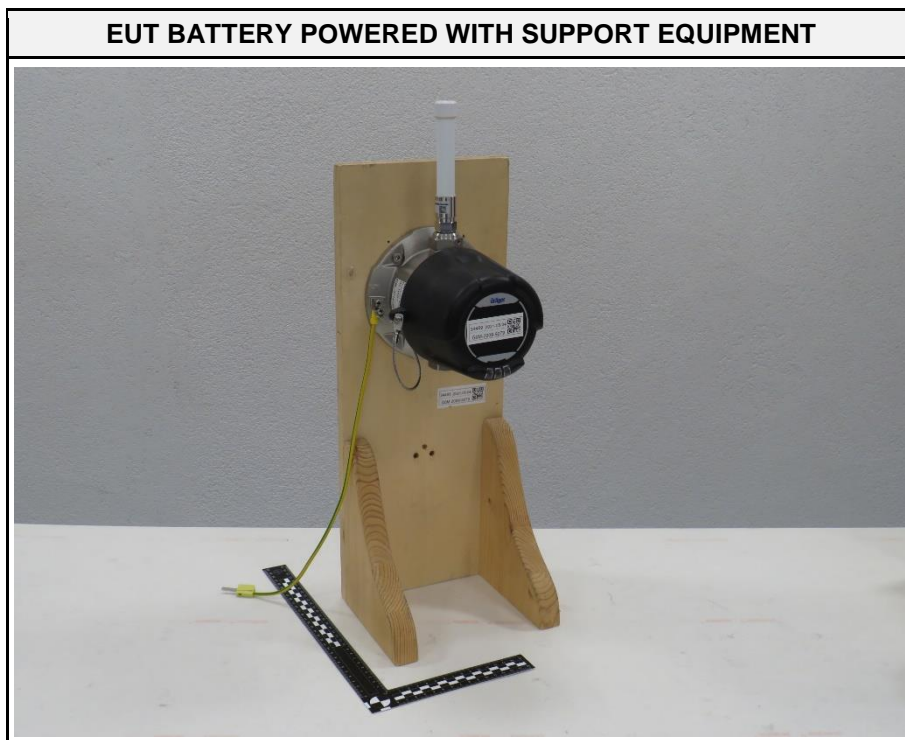

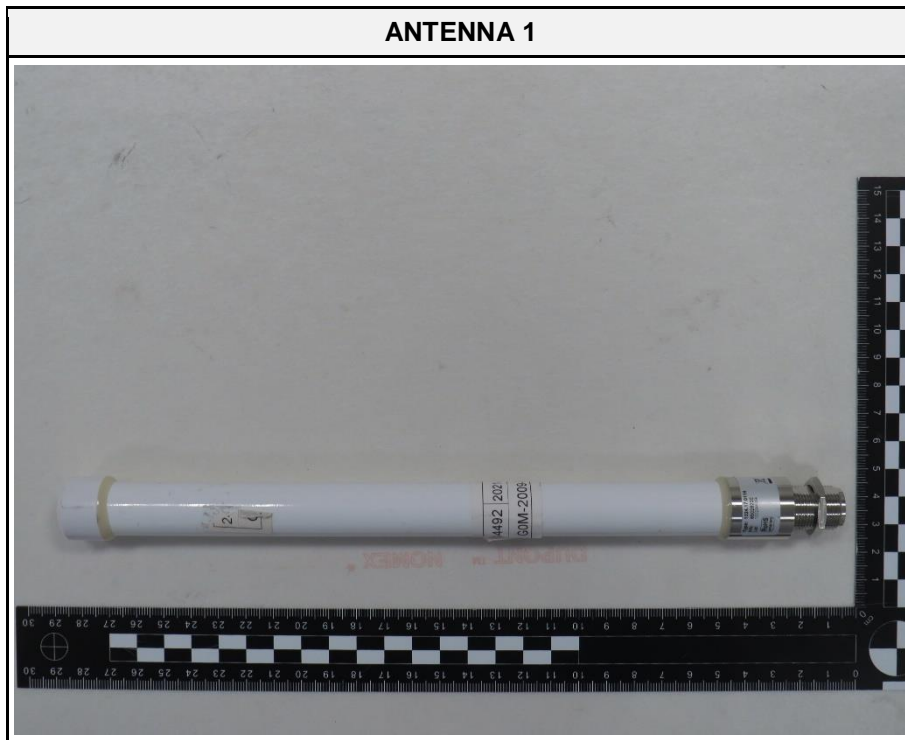



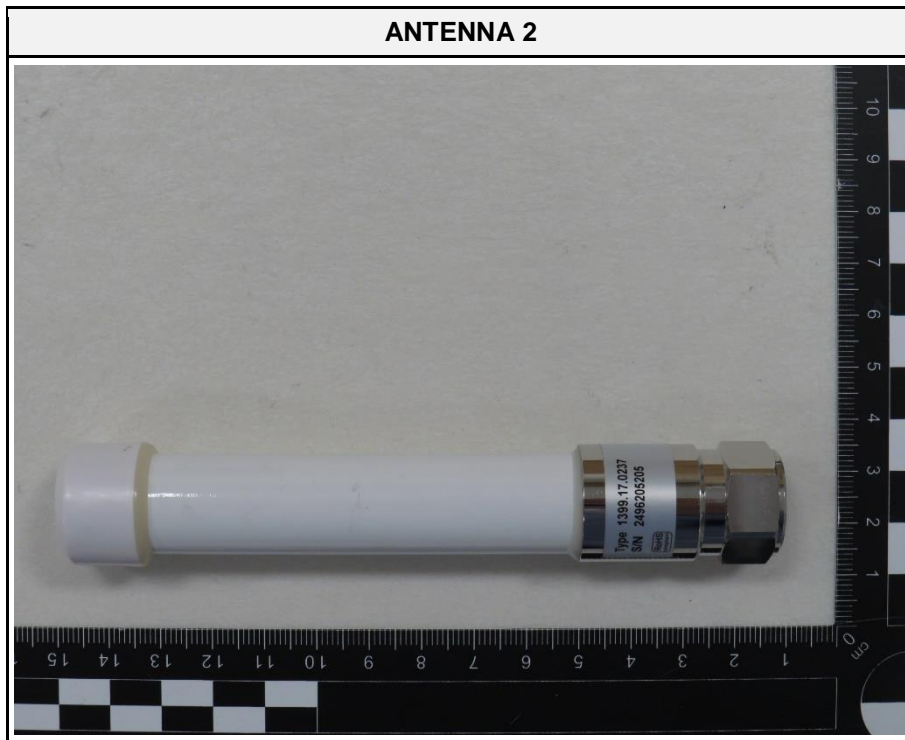



**EUT IN PERSPECTIVE I**



**EUT IN PERSPECTIVE II**



EUT FRONT SIDE

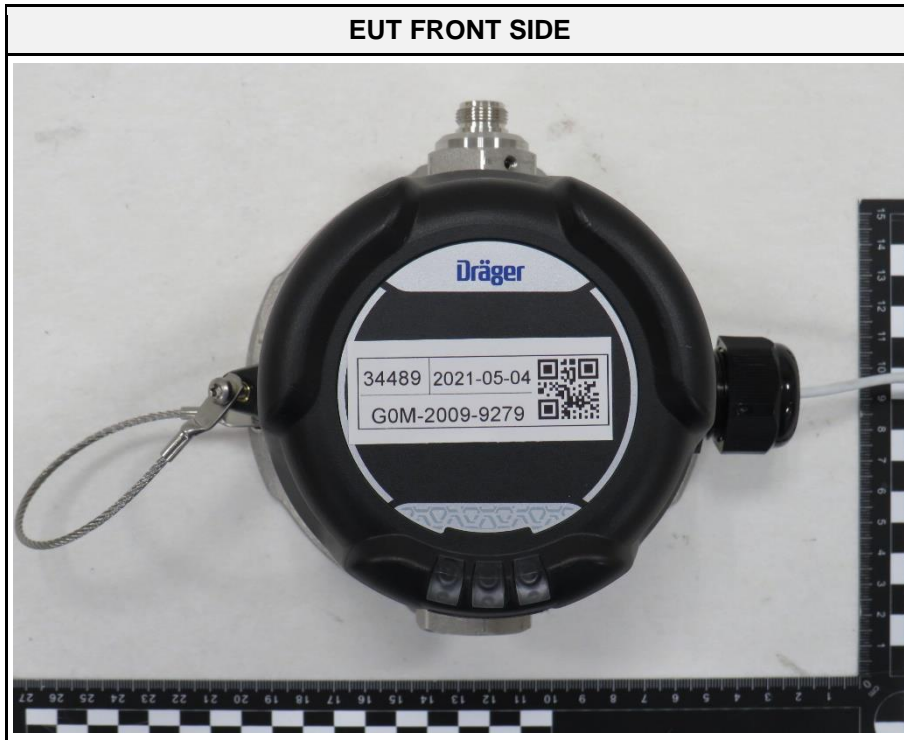

EUT BOTTOM SIDE



EUT LEFT SIDE



EUT RIGHT SIDE



**EUT TOP SIDE**



**EUT REAR SIDE**

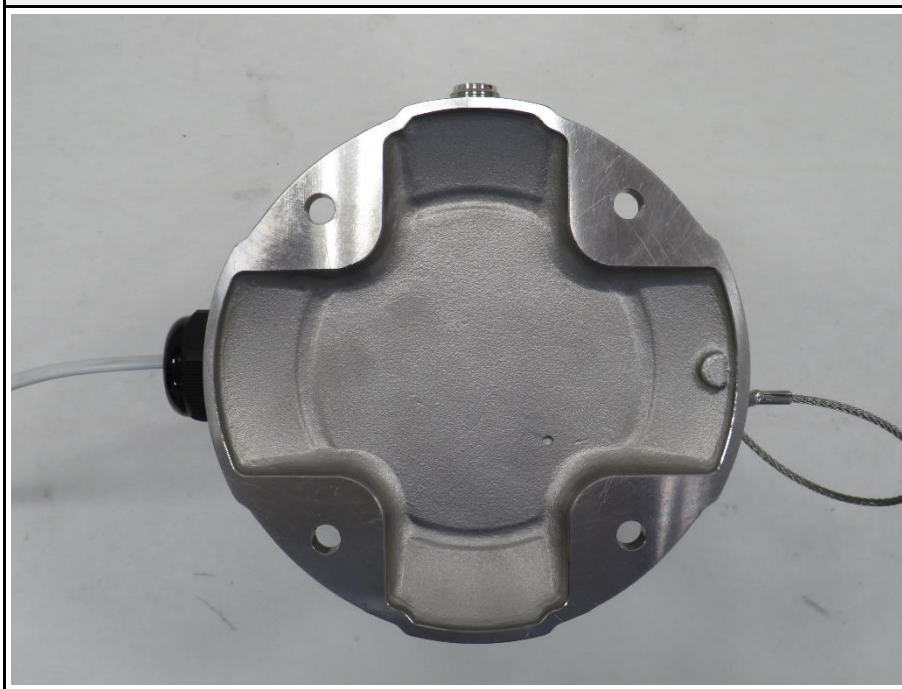

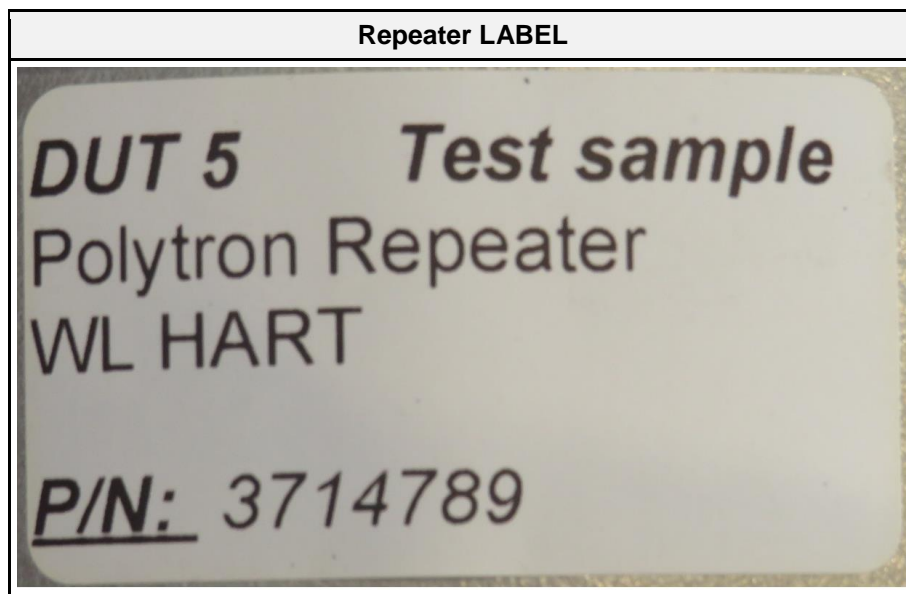

**1.4 Support Equipment**

Product Type	Device	Manufacturer	Model	Comment
AE	Fixed Gas Detector	Dräger	Polytron 6100 EC WL	Transmitter for Wireless HART network; Customer Support Equipment
AE	Antenna 1	Huber+Suhner	1324.17.0114	Customer Support Equipment
AE	Antenna 2	Huber+Suhner	1399.17.0237	Customer Support Equipment
AE	Honeywell Wireless Device Manager	Honeywell	WDMY	Customer Support Equipment
AE	Honeywell Field Device Access Point	Honeywell	FDAP2	Customer Support Equipment
CBL	Remote Antenna Cable	Huber+Suhner	SPUMA 400-FR	5 m; Customer Support Equipment
MON	Laptop	Dell	Latitude 5490	Customer Support Equipment
AE	AC/DC-Adaptor	Phoenix Contact	2902991	Customer Support Equipment to provide 24 V DC
SW	Honeywell Device Manager Station	Honeywell	OneWireless 320.3.2.0	Customer Support Equipment for ZigBee monitoring
SW	GSTERM	Dräger	GasSecure Service Application – v1.75.1.1313	Customer Support Equipment for Bluetooth LE monitoring
Description:				
AE	Auxiliary Equipment			
SIM	Simulator			
MON	Monitoring Equipment			
CBL	Connecting Cable			
SW	Software			
Comment: --				



### 1.5 Operational Modes

Mode #	Description
1	EUT receives sensor data every eight seconds from Fixed Gas Detector via ZigBee (WHART), sends received data to Honeywell Field Device Access Point via ZigBee and status information every one second to Laptop via Bluetooth connection.
Comment: --	

### 1.6 EUT Configuration

Configuration #	Description
1	<p>EUT powered by 14.4 V DC not rechargeable Lithium battery.                      EUT with Antenna 2.                      EUT is connected to functional earth (1 m cable length).</p> <p><b>Block diagram:</b></p> <p>EMC Chamber</p>

2

EUT powered by 24.0 V DC via AC/DC-Adaptor.  
 AC/DC-Adaptor powered by 230 V / 50 Hz.  
 EUT is connected with Antenna 1 via five-meter Remote Antenna Cable (1 m cable length).  
 Remote Antenna Cable and EUT are connected to functional earth (1 m cable length).

**Block diagram:**

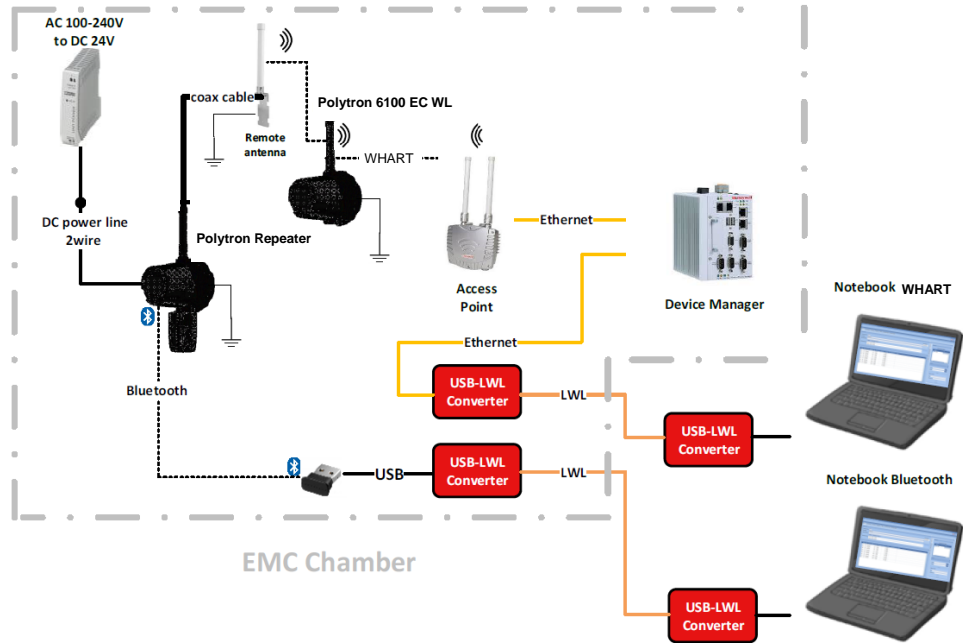

Comment: --



### 1.7 Sample emission level calculation

The following is a description of terms and a sample calculation, as appears in the radiated emissions data table. The numbers used in the calculation are for example only. There is no direct correlation to the specific data taken for the product described in this document:

Reading:

This is the reading obtained on the spectrum analyser in dBµV. Any external preamplifiers used are taken into account through internal analyser settings.

A.F.:

This is the antenna factor for the receiving antenna. It is a conversion factor, which converts electric fields strengths to voltages, which can be measured directly on the spectrum analyser. It is treated as a loss in dB. Cable losses have been included with the A.F. to simplify the calculations. The antenna factor is used in calculations as follows:

$$\text{Reading on Analyser (dB}\mu\text{V)} + \text{A.F. (dB/m)} = \text{Net field strength (dB}\mu\text{V/m)}$$

Net:

This is the net field strength measurement (as shown above).

Limit:

This is the FCC Class B radiated emission limit (in units of dBµV/m). The FCC limits are given in units of µV/m. The following formula is used to convert the units of µV/m to dBµV/m:

$$\text{Limit (dB}\mu\text{V/m)} = 20 \cdot \log(\mu\text{V/m})$$

Margin:

This is the margin of compliance below the FCC limit. The units are given in dB. A negative margin indicates the emission was below the limit. A positive margin indicates that the emission exceeds the limit.

Example only:

Reading + AF	= Net Reading	:	Net reading - FCC limit	= Margin
+21.5 dBµV + 26 dB/m	= 47.5 dBµV/m	:	47.5 dBµV/m - 57.0 dBµV/m	= -9.5 dB

## 2 Result Summary

Title 47 CFR Part 15B, ISED ICES-003 Issue 7				
Reference	Requirement	Reference Method	Result	Remarks
Emission				
FCC 15.109 ICES-003, 3.2.2	Radiated emissions	ANSI C63.4:2014 +A1:2017	PASS	--
FCC 15.107 ICES-003, 3.2.1	AC power line conducted emissions	ANSI C63.4:2014 +A1:2017	PASS	--
Comment:				

Possible Test Case Verdicts	
PASS	Test object does meet the requirements
FAIL	Test object does not meet the requirements
N/T	Required by standard but not tested
N/R	Not required by standard for the test object

## 2.1 Test Conditions and Results - Radiated emissions acc. to ANSI C63.4

### 2.1.1 Information

Test Information	
Reference	FCC 15.109, ICES-003, 3.2.2
Reference method	ANSI C63.4:2014+A1:2017 Section 8
Equipment class	Class B
Equipment type	Table top
Highest internal frequency [MHz]	2483.5
Measurement range	30 MHz to 13000 MHz
Temperature [°C]	19 – 23
Humidity [%]	46 – 50
Operator	Stephan Liebich
Date	2021-09-23

### 2.1.2 Setup

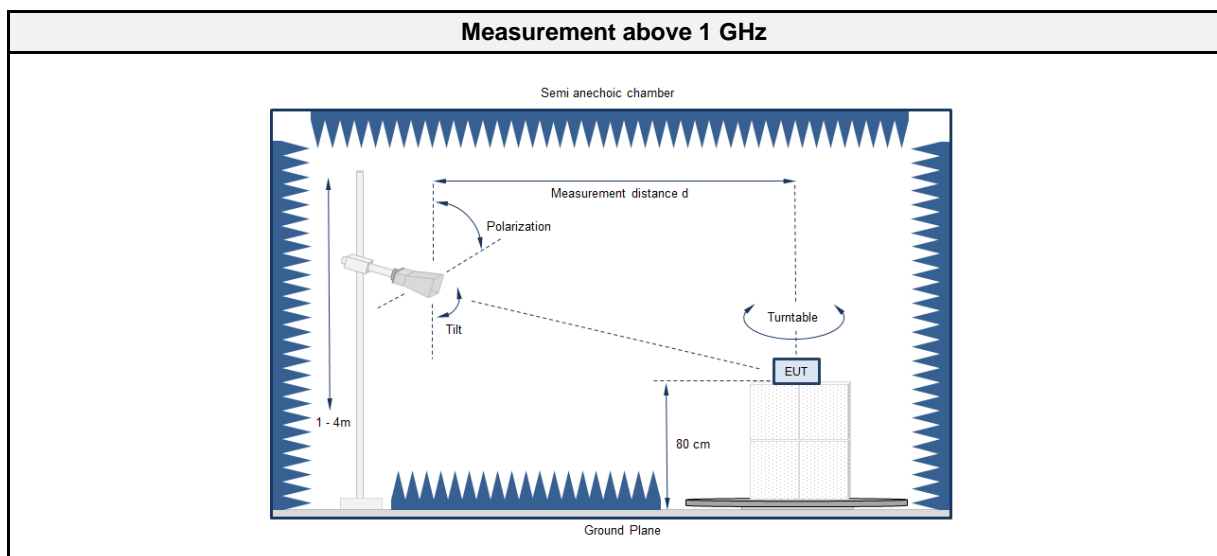
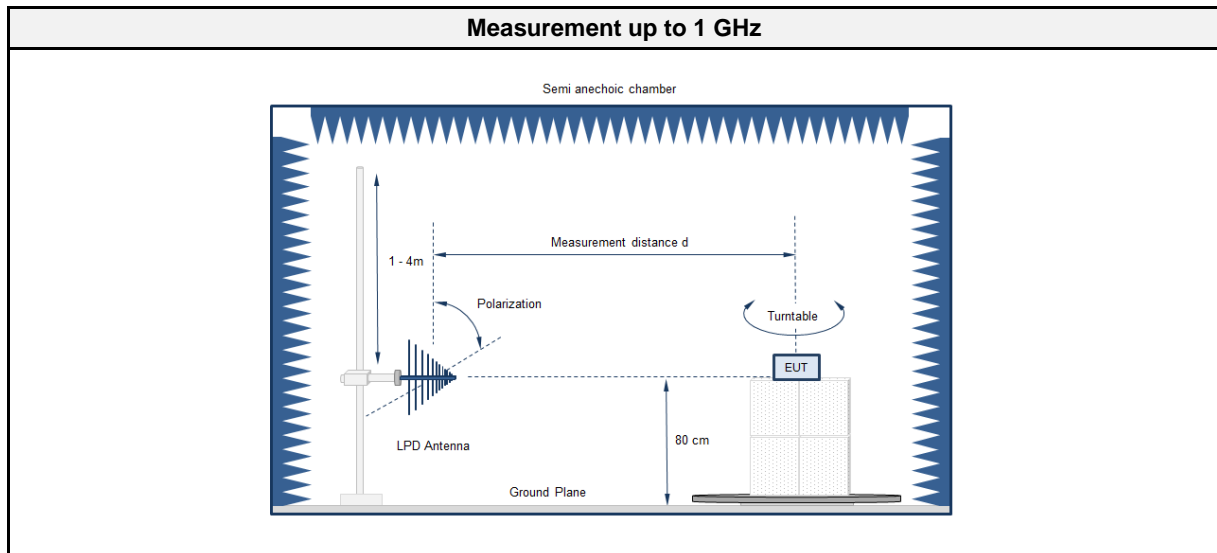

### Equipment placement - Table top

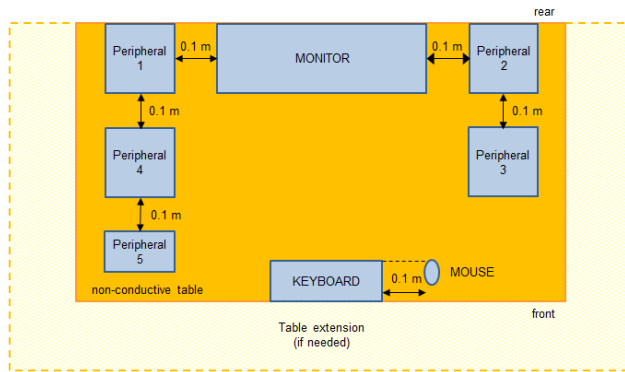

### Test Setup

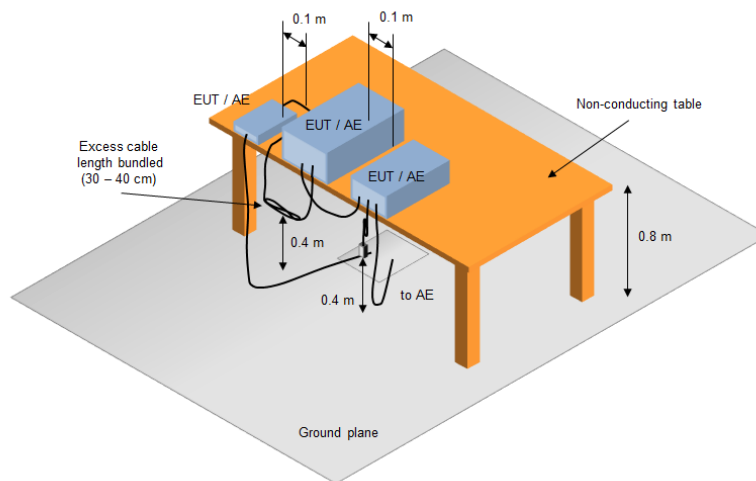

2.1.3 Equipment

Test Software			
Description	Manufacturer	Name	Version
EMC Software	DARE Instruments	Radimation	2020.1.8

Test Equipment					
Description	Manufacturer	Model	Identifier	Cal. Date	Cal. Due
Anechoic chamber (NSA)	Frankonia	AC1	EF00062	2021-02	2024-02
Anechoic chamber (SVSWR)	Frankonia	AC 1	EF01011	2019-06	2022-06
Programmable AC Source	Chroma ATE Inc.	61604	EF01068	2021-07	2022-07
EMI Test Receiver	Keysight	N9038A-526/WXP	EF01070	2021-07	2022-07
Biconical Antenna	R&S	HK 116	EF00030	2021-05	2024-05
LPD Antenna	R&S	HL 223	EF00187	2019-05	2022-05
Horn Antenna	Schwarzbeck	BBHA9120D	EF00018	2019-10	2022-10
Programmable AC Source	Chroma ATE Inc.	61604	EF01068	2021-07	2022-07
Digital Multimeter	Rohde & Schwarz GmbH & Co. KG - Zentralservice München	HMC8012	EF01481	2021-08	2022-08
Climatic Sensor	Embedded Data Systems, LLC.	280010000025417E	EF01054	2021-03	2022-03

2.1.4 Procedure

Exploratory measurement
<ol style="list-style-type: none"> <li>1. The EUT was placed on a non-conductive table at a height of 0.8m.</li> <li>2. The EUT and support equipment, if needed, were set up to simulate typical usage.</li> <li>3. Cables, of type and length specified by the manufacturer, were connected to at least one port of each type and were terminated by a device or simulating load of actual usage.</li> <li>4. The antenna was placed at a distance of 3 or 10 m.</li> <li>5. The received signal was monitored at the measurement receiver.</li> <li>6. This procedure has to be performed in both antenna polarizations, horizontal and vertical.</li> <li>7. The arrangement of the equipment with the maximum emission level is shown on the setup picture at item 2.1.2</li> </ol>

Final measurement
<ol style="list-style-type: none"> <li>1. The EUT was placed on a 0.8 m non-conductive table at a 3 m distance from the receive antenna. The antenna output was connected to the measurement receiver.</li> <li>2. A biconical antenna was used for the frequency range 30 – 200 MHz, a logarithmic periodical antenna was used for the frequency range from 200 – 1000 MHz. Above one 1 GHz a Double Ridged Broadband Horn antenna was used. The antenna was placed on an adjustable height antenna mast.</li> <li>3. The EUT and cable arrangement were based on the exploratory measurement results.</li> <li>4. Emissions were maximized at each frequency by rotating the EUT and adjusting the receive antenna height and polarization. The maximum values were recorded.</li> <li>5. The test data of the worst-case conditions were recorded and shown on the next pages.</li> </ol>

## 2.1.5 Limits

<b>Class B @ 3 m</b>		
Frequency [MHz]	Detector	Limit [dB $\mu$ V/m]
30 - 88	Quasi-peak	40
88 - 216	Quasi-peak	43.5
216 - 960	Quasi-peak	46
960 - 1000	Quasi-peak	54
> 1000	Peak Average	74 54

## 2.1.6 Results

<b>Test Results</b>			
Operational mode	EUT Configuration	Verdict	Remark
1	1	PASS	--
1	2	PASS	--

2.1.7 Setup Photos

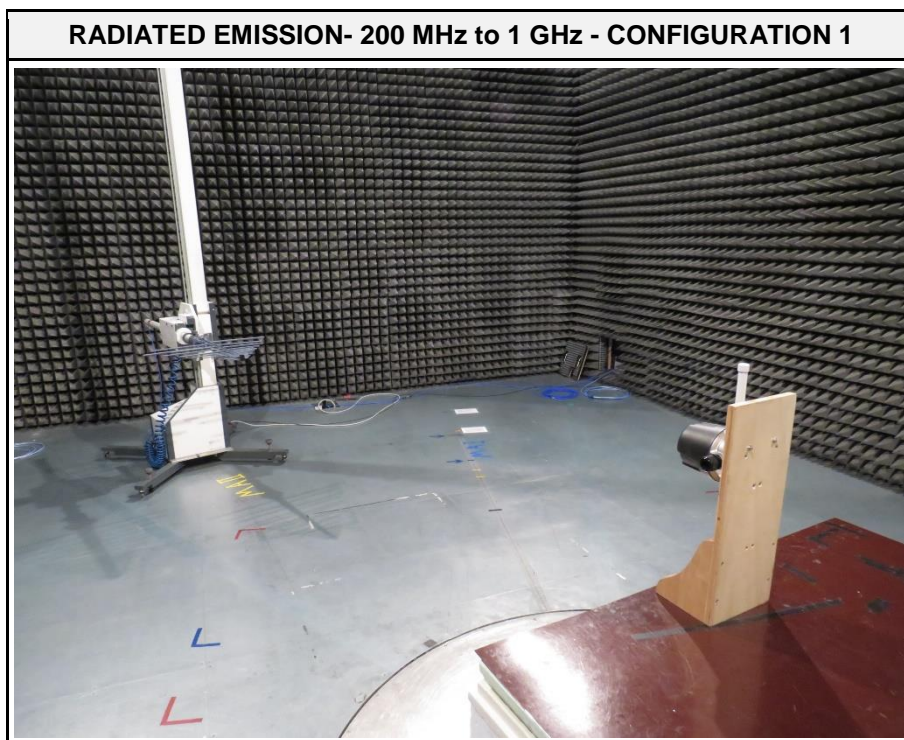
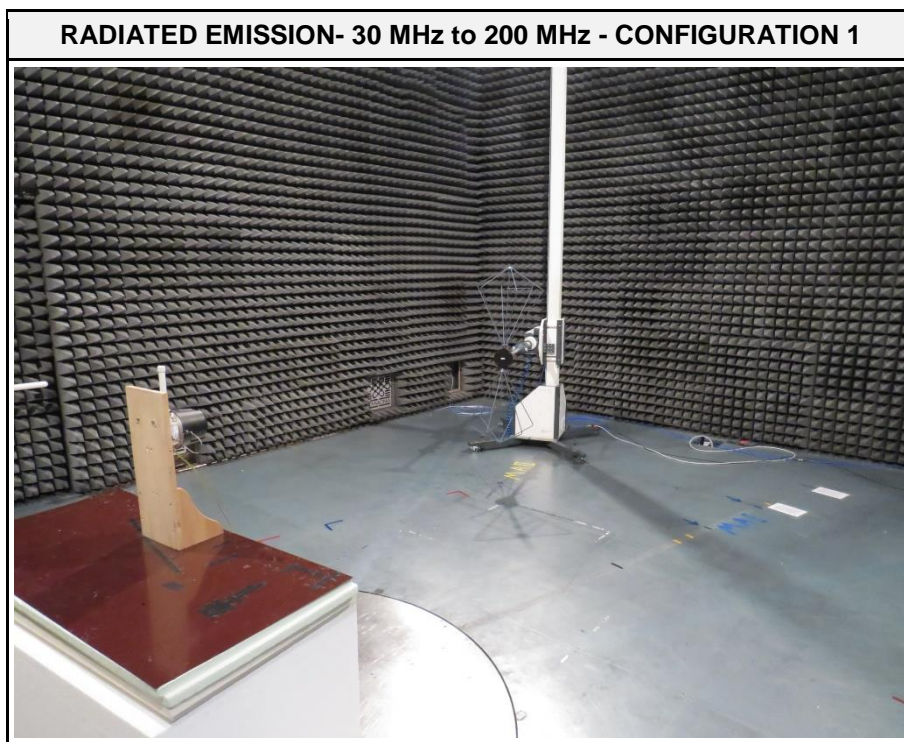



**RADIATED EMISSION- 1 GHz to 13 GHz - CONFIGURATION 1**

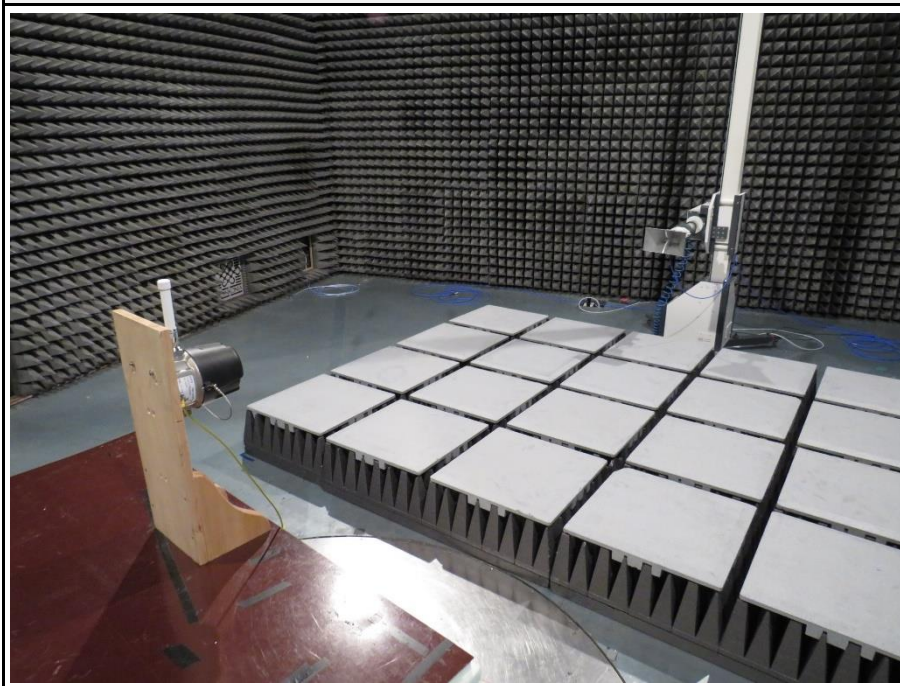

**RADIATED EMISSION- FOCUS - CONFIGURATION 1**

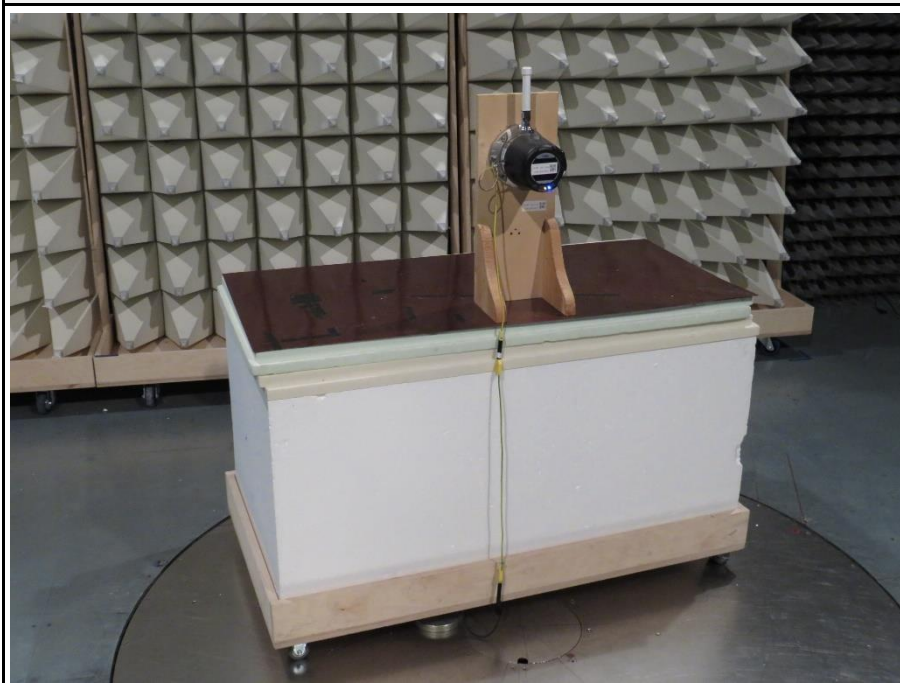



**RADIATED EMISSION- 30 MHz to 200 MHz - CONFIGURATION 2**

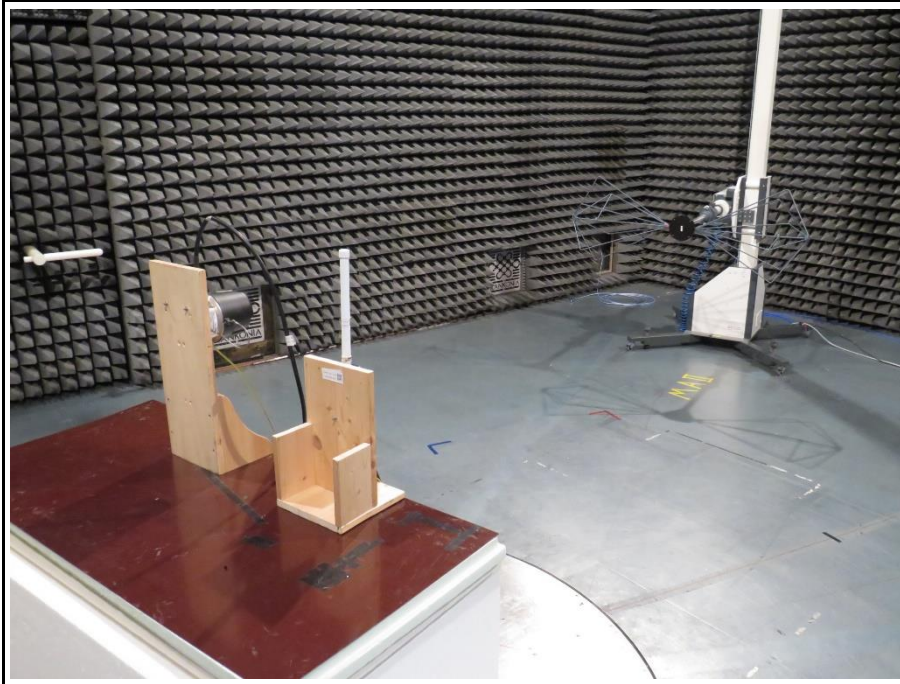

**RADIATED EMISSION- 200 MHz to 1 GHz - CONFIGURATION 2**

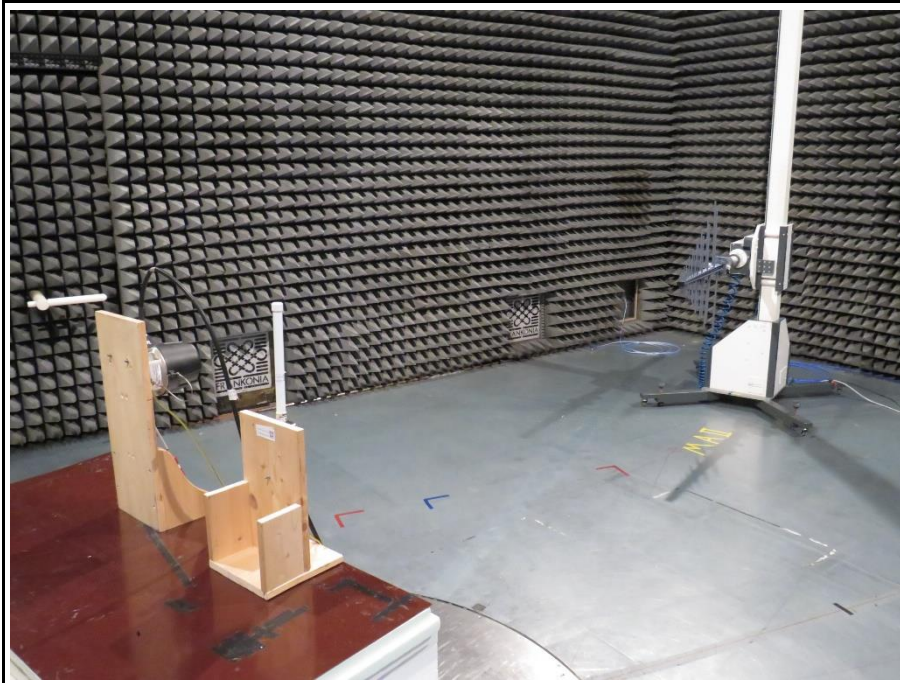

**RADIATED EMISSION- 1 GHz to 13 GHz - CONFIGURATION 2**

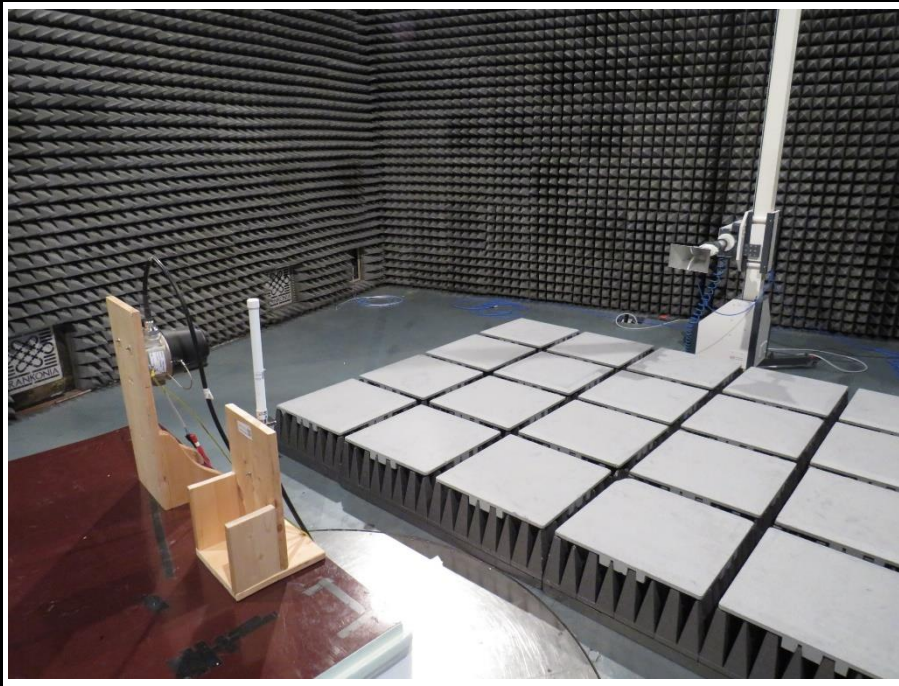

**RADIATED EMISSION- FOCUS - CONFIGURATION 2**

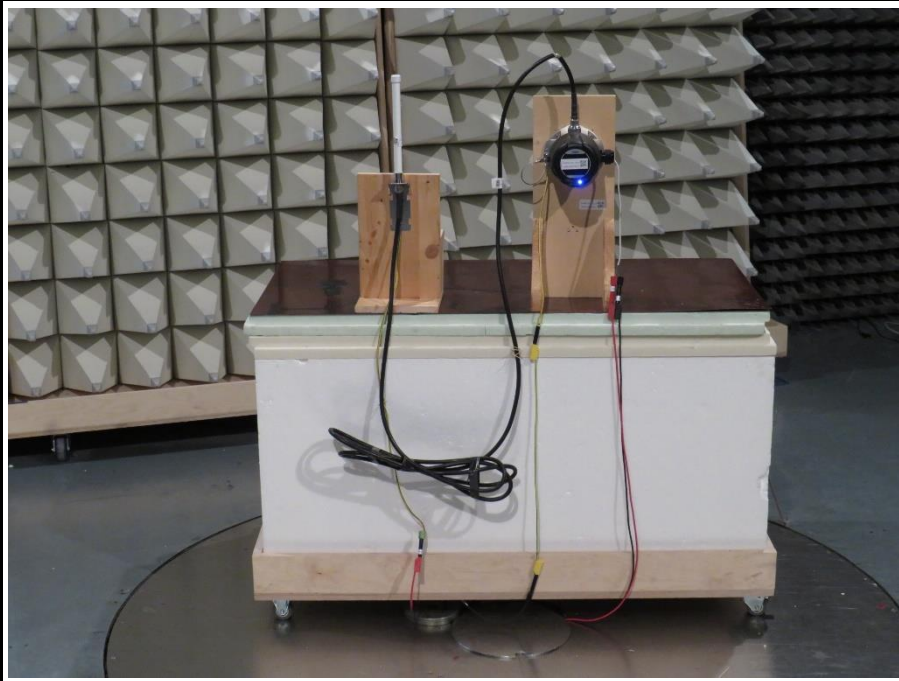

2.1.8 Records

**Radiated emissions according to FCC part 15B**

Project Number: G0M-2103-9685  
 Applicant: Dräger Safety AG & Co. KGaA  
 Model Description: Polytron Repeater WirelessHART  
 Model: Polytron Repeater WirelessHART  
 Test Sample ID: 34489  
 Test Site: Eurofins Product Service GmbH  
 Operator: Mr. Liebich  
 Test Date: 2021-09-23  
 Operating Conditions: ambient temperature: 21 °Celsius  
 power input: 14.4 V DC by not rechargeable Lithium battery  
 Antenna: Rohde & Schwarz HK 116, Vertical  
 Measurement Distance: 3m  
 Operational Mode & EUT Configuration: Mode 1  
 Configuration 1  
 Note 1: --

Index 9

**RadiMation**

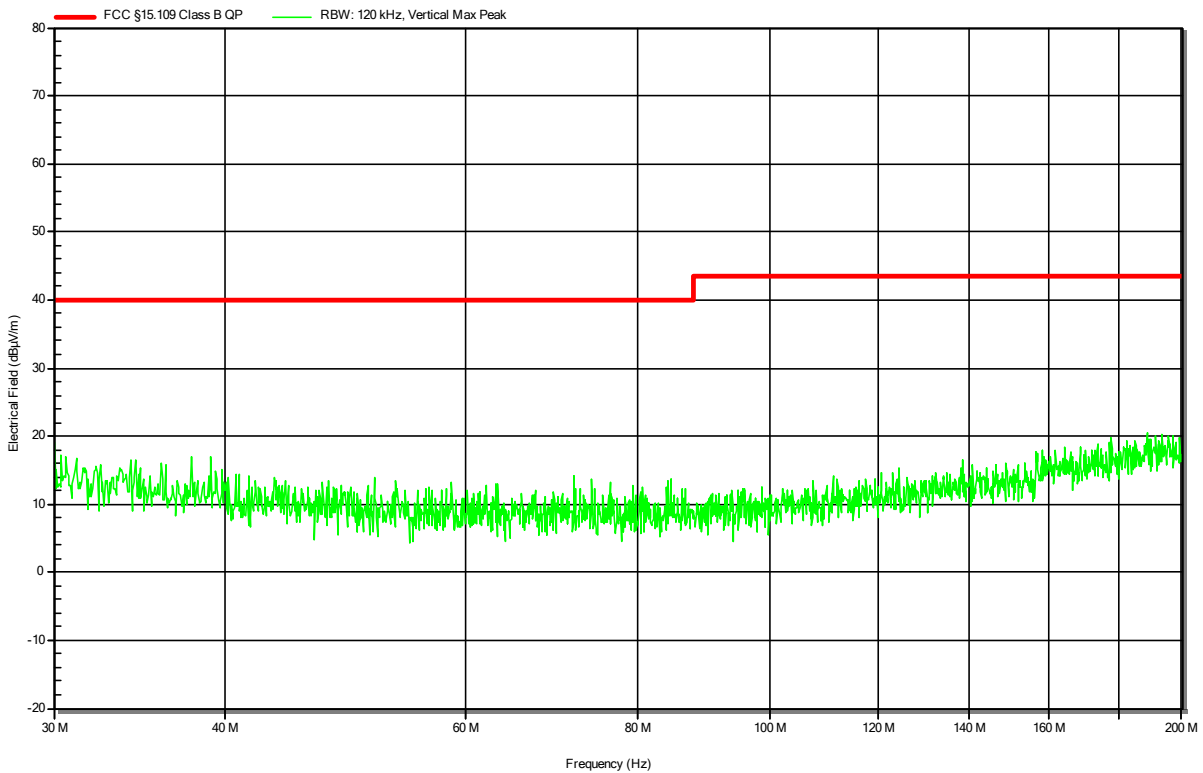

**Radiated emissions according to FCC part 15B**

Project Number: G0M-2103-9685  
 Applicant: Dräger Safety AG & Co. KGaA  
 Model Description: Polytron Repeater WirelessHART  
 Model: Polytron Repeater WirelessHART  
 Test Sample ID: 34489  
 Test Site: Eurofins Product Service GmbH  
 Operator: Mr. Liebich  
 Test Date: 2021-09-23  
 Operating Conditions: ambient temperature: 21 °Celsius  
 power input: 14.4 V DC by not rechargeable Lithium battery  
 Antenna: Rohde & Schwarz HK 116, Horizontal  
 Measurement Distance: 3m  
 Operational Mode & EUT Configuration: Mode 1  
 Configuration 1  
 Note 1: --

Index 11

**RadiMation**

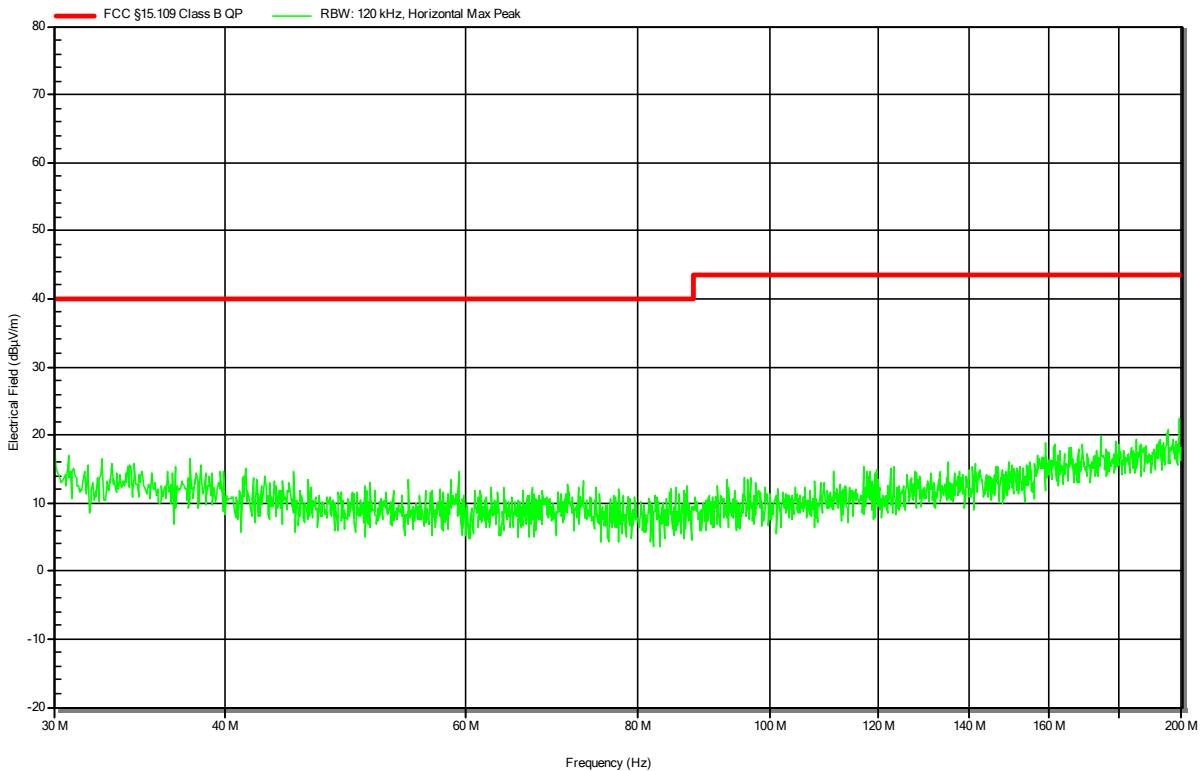



**Radiated emissions according to FCC part 15B**

Project Number:	G0M-2103-9685
Applicant:	Dräger Safety AG & Co. KGaA
Model Description:	Polytron Repeater WirelessHART
Model:	Polytron Repeater WirelessHART
Test Sample ID:	34489
Test Site:	Eurofins Product Service GmbH
Operator:	Mr. Liebich
Test Date:	2021-09-23
Operating Conditions:	ambient temperature: 20 °Celsius power input: 14.4 V DC by not rechargeable Lithium battery
Antenna:	Rohde & Schwarz HL 223, Vertical
Measurement Distance:	3m
Operational Mode & EUT Configuration:	Mode 1 Configuration 1
Note 1:	--

Index 7

**RadiMation**

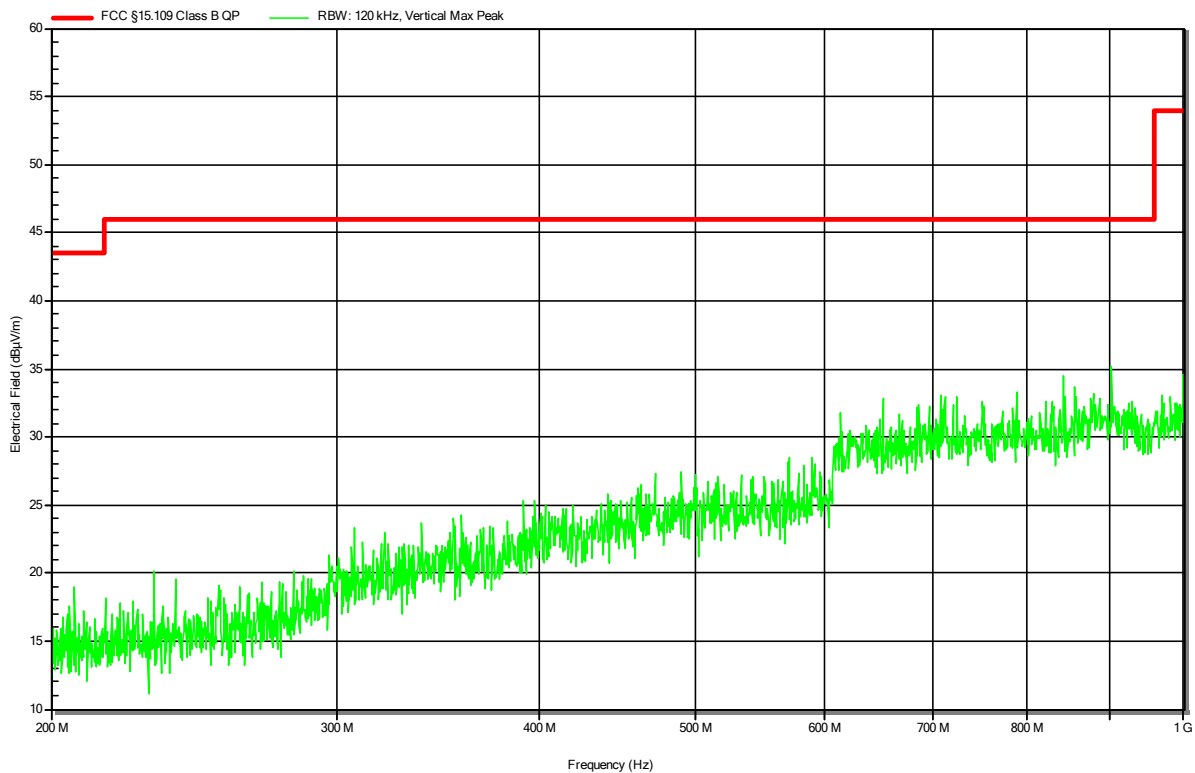

**Radiated emissions according to FCC part 15B**

Project Number:	G0M-2103-9685
Applicant:	Dräger Safety AG & Co. KGaA
Model Description:	Polytron Repeater WirelessHART
Model:	Polytron Repeater WirelessHART
Test Sample ID:	34489
Test Site:	Eurofins Product Service GmbH
Operator:	Mr. Liebich
Test Date:	2021-09-23
Operating Conditions:	ambient temperature: 20 °Celsius power input: 14.4 V DC by not rechargeable Lithium battery
Antenna:	Rohde & Schwarz HL 223, Horizontal
Measurement Distance:	3m
Operational Mode & EUT Configuration:	Mode 1 Configuration 1
Note 1:	--

Index 6

**RadiMation**

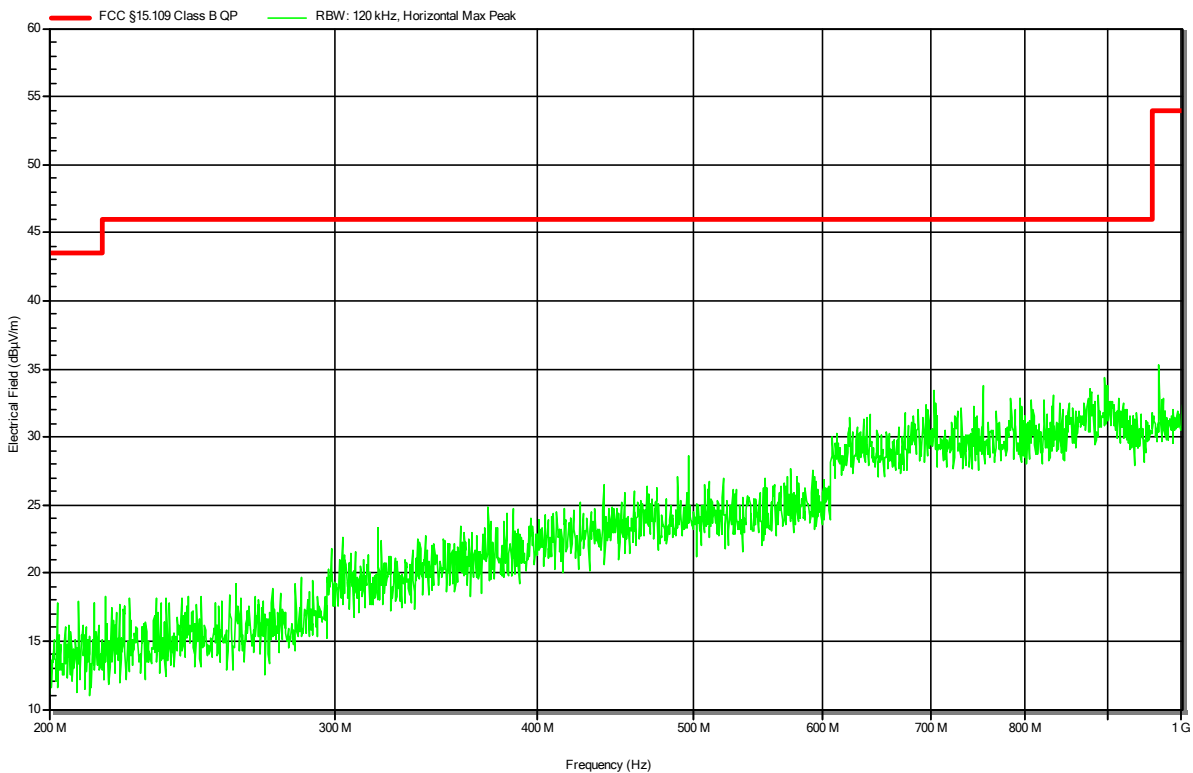

**Radiated emissions according to FCC part 15B**

Project Number: G0M-2103-9685  
 Applicant: Dräger Safety AG & Co. KGaA  
 Model Description: Polytron Repeater WirelessHART  
 Model: Polytron Repeater WirelessHART  
 Test Sample ID: 34489  
 Test Site: Eurofins Product Service GmbH  
 Operator: Mr. Liebich  
 Test Date: 2021-09-23  
 Operating Conditions: ambient temperature: 21 °Celsius  
 power input: 14.4 V DC by not rechargeable Lithium battery  
 Antenna: Schwarzbeck BBHA 9120D, Vertical  
 Measurement Distance: 3m  
 Operational Mode & EUT Configuration: Mode 1  
 Configuration 1  
 Note 1: --

Index 12

RadiMation

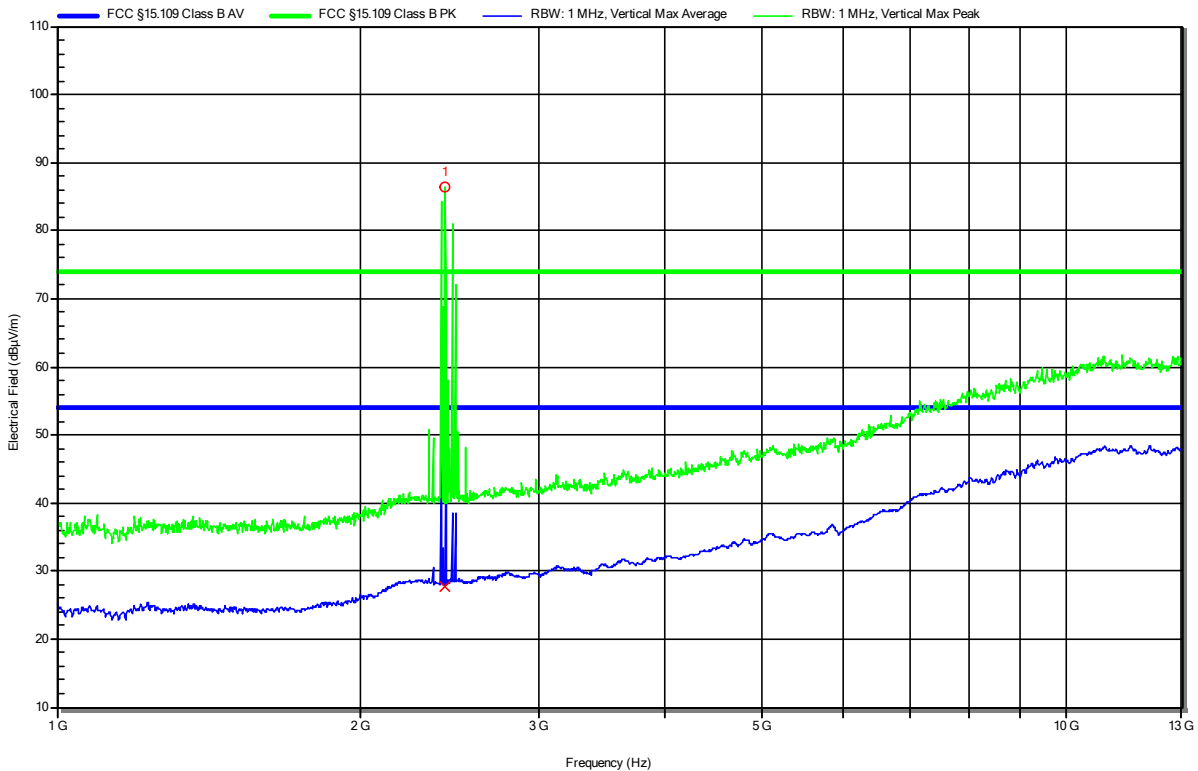

Peak Number	Frequency	Peak	Peak Limit	Peak Difference	Peak Status	Angle	Height
1	2.426 GHz	Radio-Carrier					
Peak Number	Frequency	Average	Average Limit	Average Difference	Average Status	Angle	Height
1	2.426 GHz	Radio-Carrier					

**Radiated emissions according to FCC part 15B**

Project Number: G0M-2103-9685  
 Applicant: Dräger Safety AG & Co. KGaA  
 Model Description: Polytron Repeater WirelessHART  
 Model: Polytron Repeater WirelessHART  
 Test Sample ID: 34489  
 Test Site: Eurofins Product Service GmbH  
 Operator: Mr. Liebich  
 Test Date: 2021-09-23  
 Operating Conditions: ambient temperature: 21 °Celsius  
 power input: 14.4 V DC by not rechargeable Lithium battery  
 Antenna: Schwarzbeck BBHA 9120D, Horizontal  
 Measurement Distance: 3m  
 Operational Mode & EUT Configuration: Mode 1  
 Configuration 1  
 Note 1: --

Index 13

RadiMation

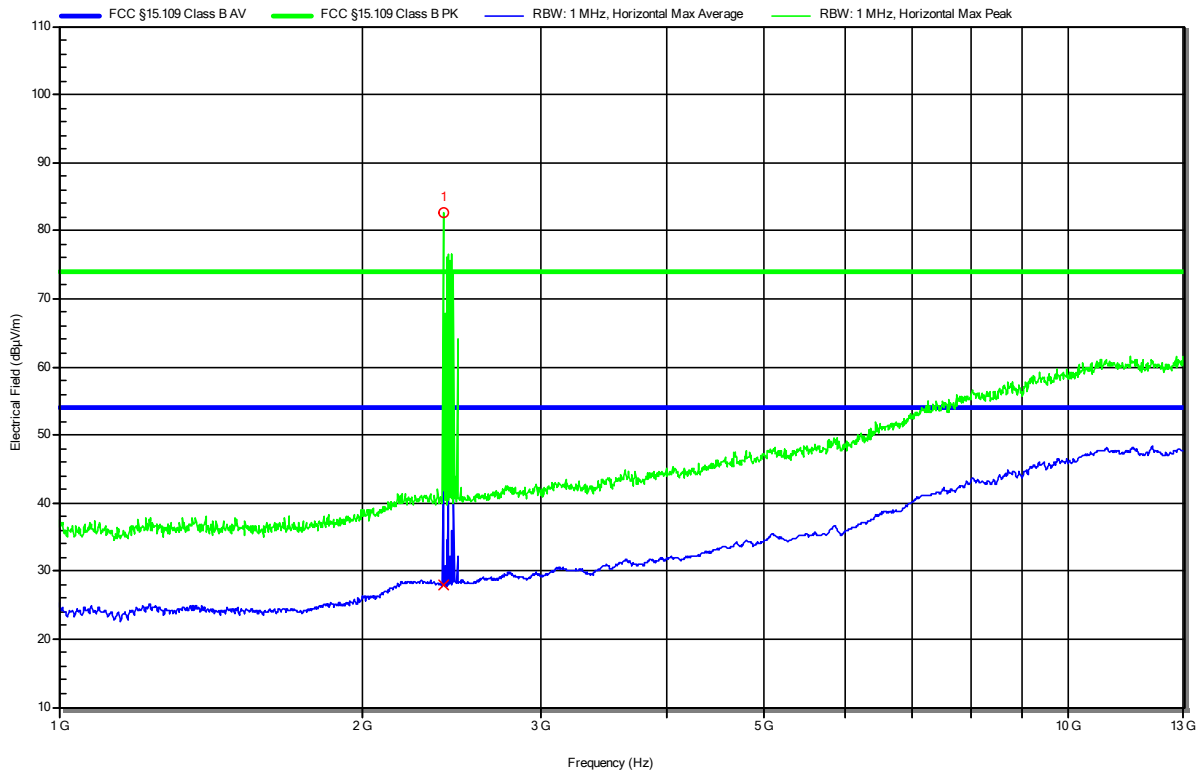

Peak Number	Frequency	Peak	Peak Limit	Peak Difference	Peak Status	Angle	Height
1	2.402 GHz	Radio-Carrier					
Peak Number	Frequency	Average	Average Limit	Average Difference	Average Status	Angle	Height
1	2.402 GHz	Radio-Carrier					



**Radiated emissions according to FCC part 15B**

Project Number: G0M-2103-9685  
 Applicant: Dräger Safety AG & Co. KGaA  
 Model Description: Polytron Repeater WirelessHART  
 Model: Polytron Repeater WirelessHART  
 Test Sample ID: 34489  
 Test Site: Eurofins Product Service GmbH  
 Operator: Mr. Liebich  
 Test Date: 2021-09-23  
 Operating Conditions: ambient temperature: 23 °Celsius  
 power input: 24 V DC by external laboratory power supply  
 Antenna: Rohde & Schwarz HK 116, Vertical  
 Measurement Distance: 3m  
 Operational Mode & EUT Configuration: Mode 1  
 Configuration 2  
 Note 1:

Index 17

**RadiMation**

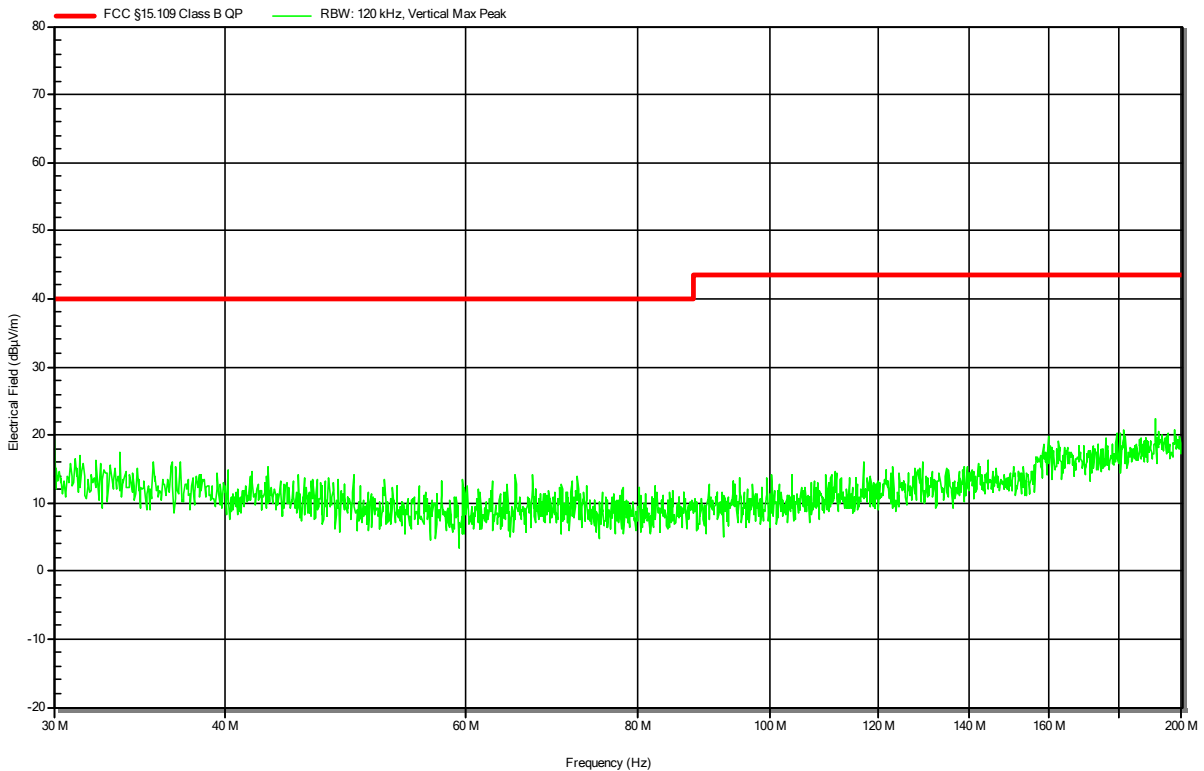

**Radiated emissions according to FCC part 15B**

Project Number: G0M-2103-9685  
 Applicant: Dräger Safety AG & Co. KGaA  
 Model Description: Polytron Repeater WirelessHART  
 Model: Polytron Repeater WirelessHART  
 Test Sample ID: 34489  
 Test Site: Eurofins Product Service GmbH  
 Operator: Mr. Liebich  
 Test Date: 2021-09-23  
 Operating Conditions: ambient temperature: 23 °Celsius  
 power input: 24 V DC by external laboratory power supply  
 Antenna: Rohde & Schwarz HK 116, Horizontal  
 Measurement Distance: 3m  
 Operational Mode & EUT Configuration: Mode 1  
 Configuration 2  
 Note 1:

Index 16

**RadiMation**

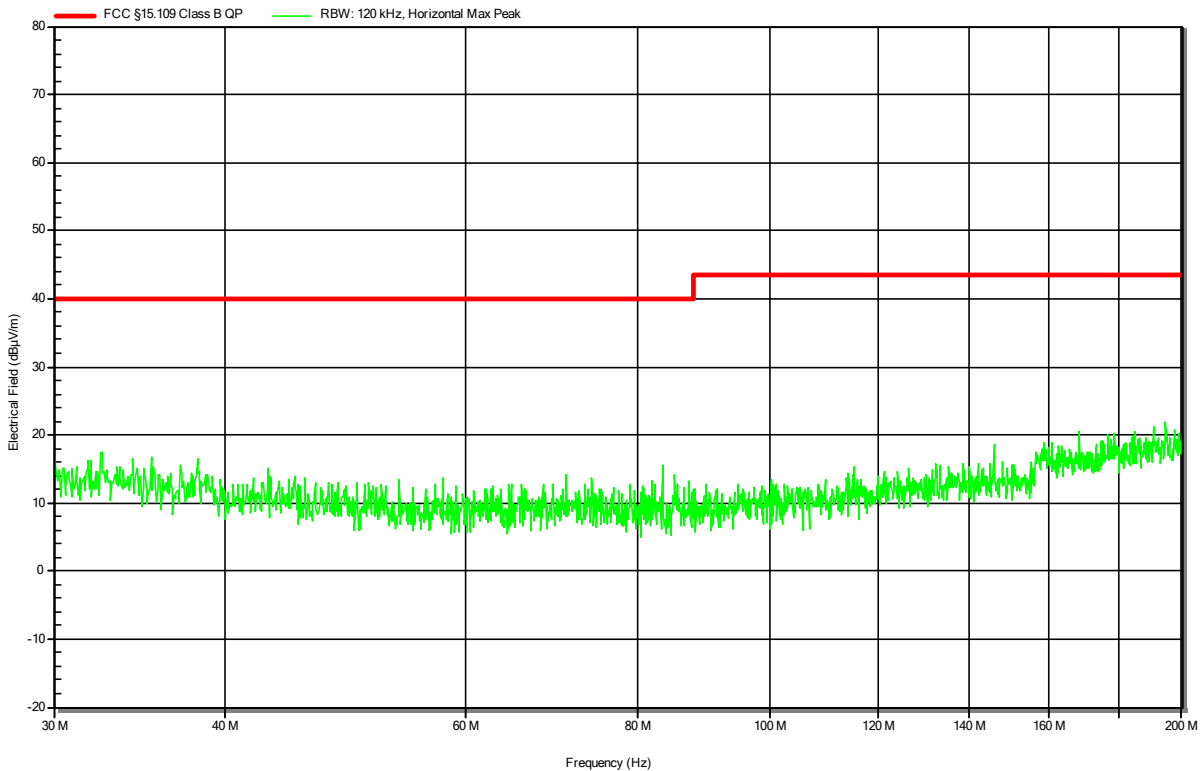

**Radiated emissions according to FCC part 15B**

Project Number: G0M-2103-9685  
 Applicant: Dräger Safety AG & Co. KGaA  
 Model Description: Polytron Repeater WirelessHART  
 Model: Polytron Repeater WirelessHART  
 Test Sample ID: 34489  
 Test Site: Eurofins Product Service GmbH  
 Operator: Mr. Liebich  
 Test Date: 2021-09-23  
 Operating Conditions: ambient temperature: 23 °Celsius  
 power input: 24 V DC by external laboratory power supply  
 Antenna: Rohde & Schwarz HL 223, Vertical  
 Measurement Distance: 3m  
 Operational Mode & EUT Configuration: Mode 1  
 Configuration 2  
 Note 1:

Index 20

**RadiMation**

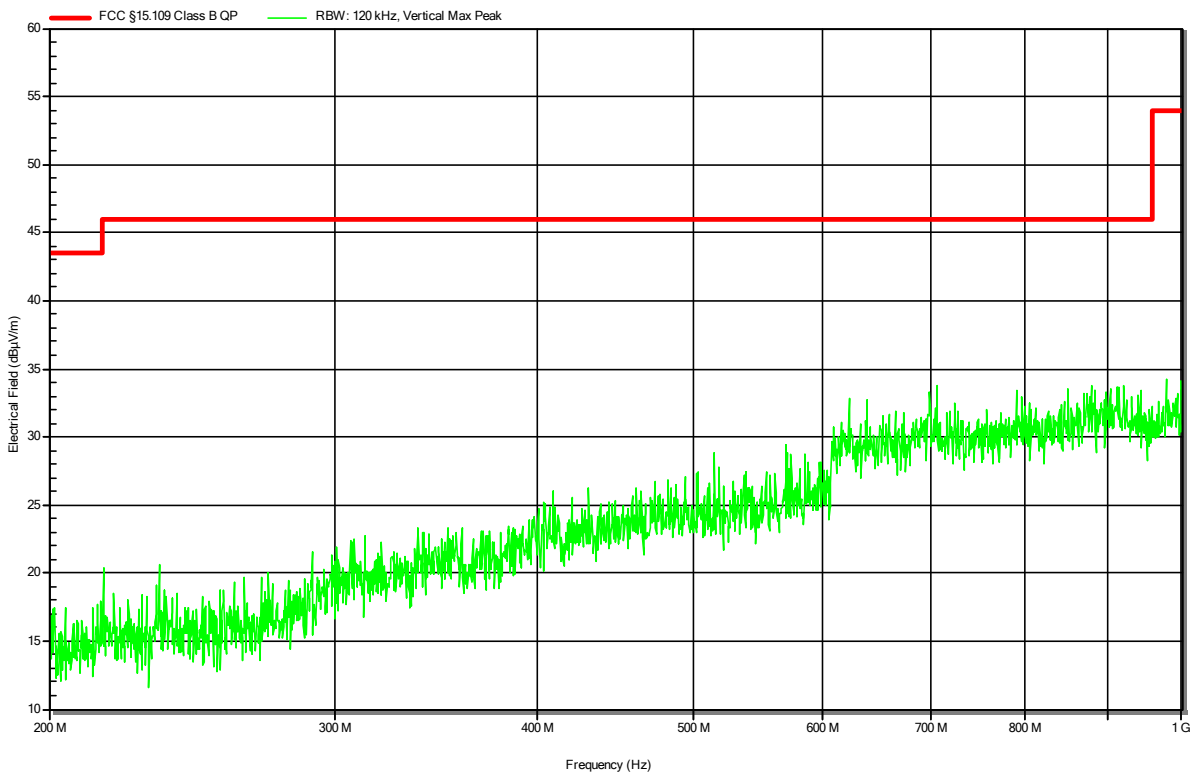

**Radiated emissions according to FCC part 15B**

Project Number: G0M-2103-9685  
 Applicant: Dräger Safety AG & Co. KGaA  
 Model Description: Polytron Repeater WirelessHART  
 Model: Polytron Repeater WirelessHART  
 Test Sample ID: 34489  
 Test Site: Eurofins Product Service GmbH  
 Operator: Mr. Liebich  
 Test Date: 2021-09-23  
 Operating Conditions: ambient temperature: 23 °Celsius  
 power input: 24 V DC by external laboratory power supply  
 Antenna: Rohde & Schwarz HL 223, Horizontal  
 Measurement Distance: 3m  
 Operational Mode & EUT Configuration: Mode 1  
 Configuration 2  
 Note 1:

Index 19

**RadiMation**

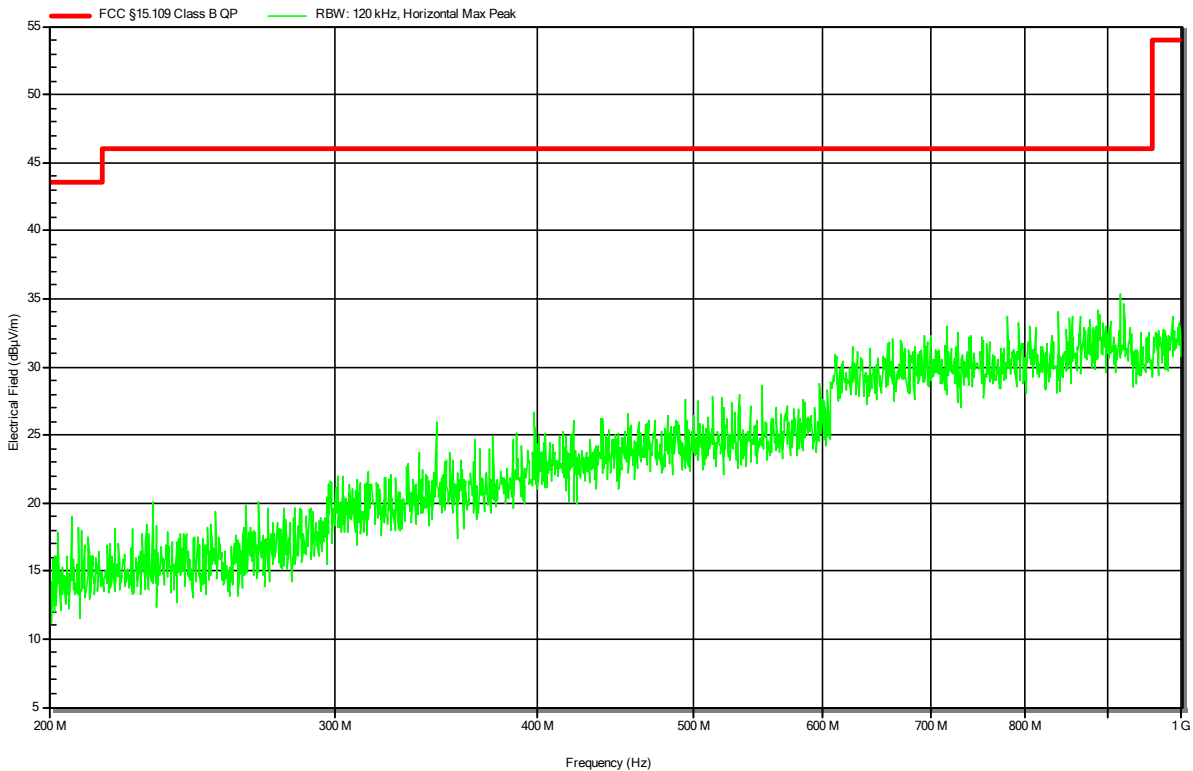

**Radiated emissions according to FCC part 15B**

Project Number: G0M-2103-9685  
 Applicant: Dräger Safety AG & Co. KGaA  
 Model Description: Polytron Repeater WirelessHART  
 Model: Polytron Repeater WirelessHART  
 Test Sample ID: 34489  
 Test Site: Eurofins Product Service GmbH  
 Operator: Mr. Liebich  
 Test Date: 2021-09-23  
 Operating Conditions: ambient temperature: 22 °Celsius  
 power input: 24 V DC by external laboratory power supply  
 Antenna: Schwarzbeck BBHA 9120D, Vertical  
 Measurement Distance: 3m  
 Operational Mode & EUT Configuration: Mode 1 Configuration 2  
 Note 1:

Index 14

RadiMation

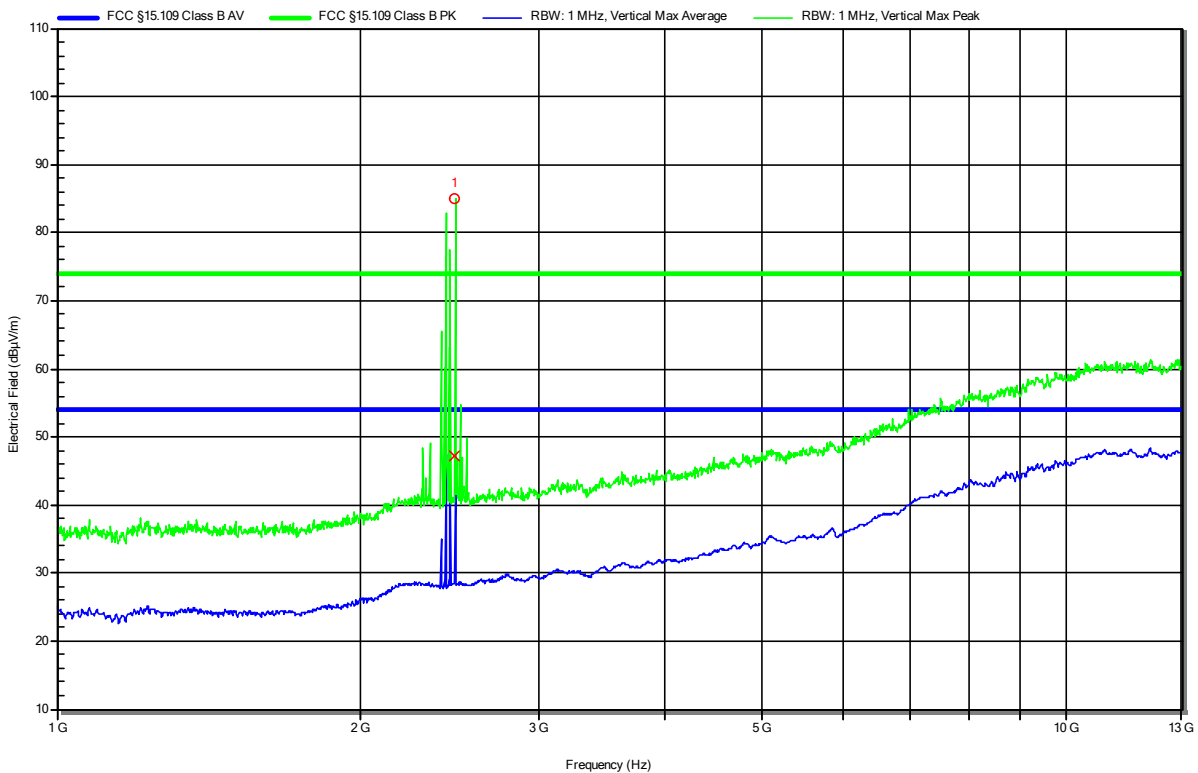

Peak Number	Frequency	Peak	Peak Limit	Peak Difference	Peak Status	Angle	Height
1	2.48 GHz	Radio-Carrier					
Peak Number	Frequency	Average	Average Limit	Average Difference	Average Status	Angle	Height
1	2.48 GHz	Radio-Carrier					

**Radiated emissions according to FCC part 15B**

Project Number: G0M-2103-9685  
 Applicant: Dräger Safety AG & Co. KGaA  
 Model Description: Polytron Repeater WirelessHART  
 Model: Polytron Repeater WirelessHART  
 Test Sample ID: 34489  
 Test Site: Eurofins Product Service GmbH  
 Operator: Mr. Liebich  
 Test Date: 2021-09-23  
 Operating Conditions: ambient temperature: 22 °Celsius  
 power input: 24 V DC by external laboratory power supply  
 Antenna: Schwarzbeck BBHA 9120D, Horizontal  
 Measurement Distance: 3m  
 Operational Mode & EUT Configuration: Mode 1  
 Configuration 2  
 Note 1: --

Index 15

RadiMation

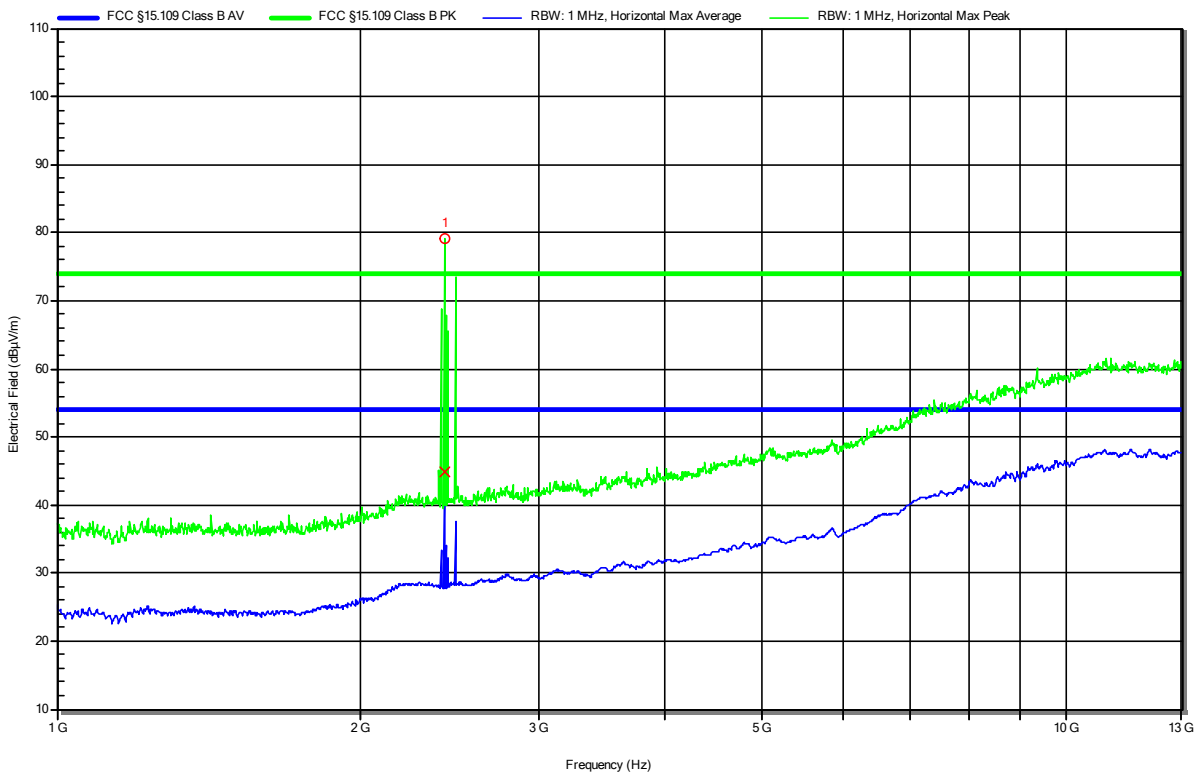

Peak Number	Frequency	Peak	Peak Limit	Peak Difference	Peak Status	Angle	Height
1	2.419 GHz	Radio-Carrier					
Peak Number	Frequency	Average	Average Limit	Average Difference	Average Status	Angle	Height
1	2.419 GHz	Radio-Carrier					

## 2.2 Test Conditions and Results - Conducted emissions acc. to ANSI C63.4

### 2.2.1 Information

Test Information	
Reference	FCC 15.107, ICES-003, 3.2.1
Reference method	ANSI C63.4:2014+A1:2017 Section 12
Measurement range	150 kHz to 30 MHz
Equipment class	Class B
Equipment type	Table top
Temperature [°C]	22 – 23
Humidity [%]	43 – 45
Operator	Stephan Liebich
Date	2021-09-24

### 2.2.2 Setup

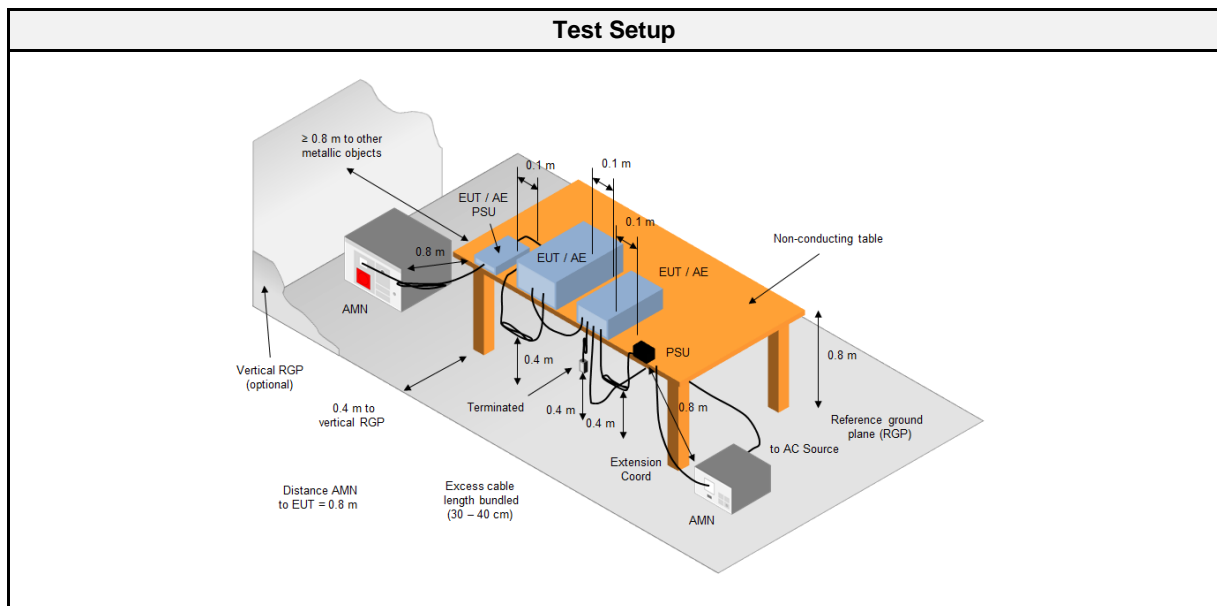
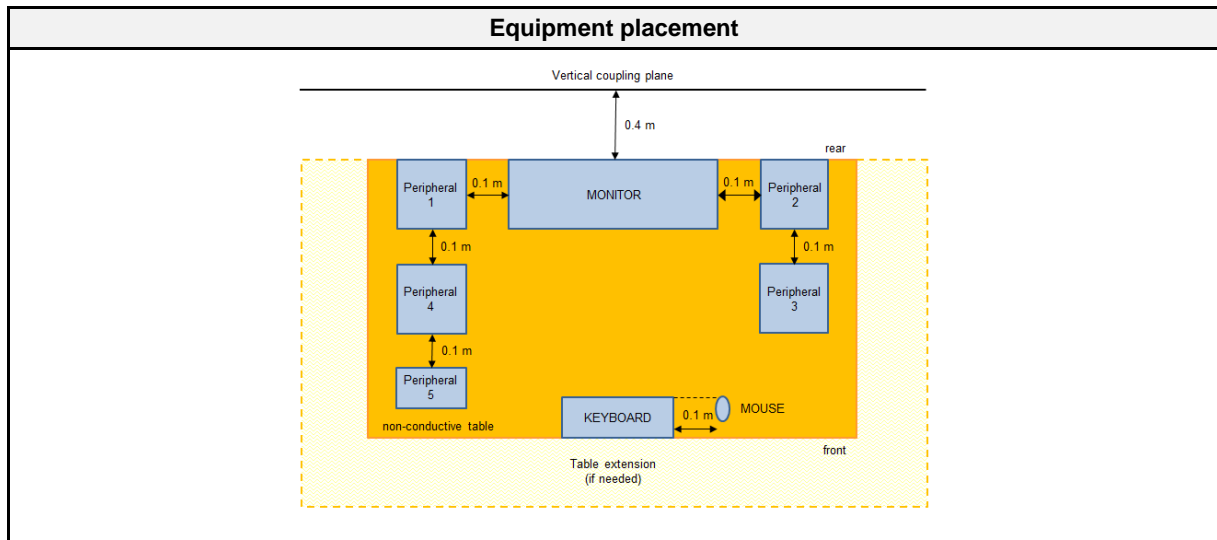



### 2.2.3 Equipment

Test Software			
Description	Manufacturer	Name	Version
EMC Software	DARE Instruments	Radimation	2020.1.8

Test Equipment					
Description	Manufacturer	Model	Identifier	Cal. Date	Cal. Due
AMN	Schwarzbeck	NSLK 8127	EF01592	2021-07	2022-07
Pulse Limiter	R&S	ESH3-Z2	EF01063	2021-07	2022-07
EMI Test Receiver	R&S	ESR 7	EF00943	2021-08	2022-08
Climatic Sensor	Embedded Data Systems, LLC.	2800100000254 17E	EF01054	2021-03	2022-03

### 2.2.4 Procedure

Exploratory measurement
<ol style="list-style-type: none"> <li>The EUT was placed on a non conductive table 0.8 m above the reference ground plane and 0.4 m away from the vertical conducting plane (ANSI C63.4: 2014 item 7.3.1)</li> <li>The power cord that is normally supplied or recommended by the manufacturer was connected to the LISN.</li> <li>The distance between the outer edge of the EUT and the LISN shall be set to 0.8 m. A longer power cord shall be bundled to this length (bundling shall not exceed 40 cm in length).</li> <li>The LISN measurement port was connected to a measurement receiver</li> <li>I/O cables were bundled not longer than 0.4 m</li> <li>Measurement was performed in the frequency range 0.15 – 30MHz on each current-carrying conductor</li> <li>To maximize the emissions the cable positions were manipulated</li> <li>The worst configuration of EUT and cables is shown on a test setup picture at item 2.2.2</li> </ol>

Final measurement
<ol style="list-style-type: none"> <li>The EUT was placed on a non conductive table 0.8 m above the reference ground plane and 0.4 m away from the vertical conducting plane (ANSI C63.4: 2014 item 7.3.1)</li> <li>The power cord that is normally supplied or recommended by the manufacturer was connected to the LISN.</li> <li>The distance between the outer edge of the EUT and the LISN shall be set to 0.8 m. A longer power cord shall be bundled to this length (bundling shall not exceed 40 cm in length).</li> <li>The LISN measurement port was connected to a measurement receiver</li> <li>The EUT and cable arrangement were based on the exploratory measurement results</li> <li>The test data of the worst-case conditions were recorded and shown on the next pages</li> </ol>

### 2.2.5 Limits

Class B		
Frequency [MHz]	Quasi-peak Limit [dB $\mu$ V]	Average Limit [dB $\mu$ V]
0.15 - 0.5	66 - 56 *	56 - 46 *
0.5 - 5	56	46
5 - 30	60	50

\* Decreases with the logarithm of the frequency

2.2.6 Results

AC power line conducted emissions					
Port	Coupling	Operational mode	EUT Configuration	Verdict	Remark
AC Mains	AMN	1	1	PASS	AC/DC-Adaptor port

2.2.7 Setup Photos

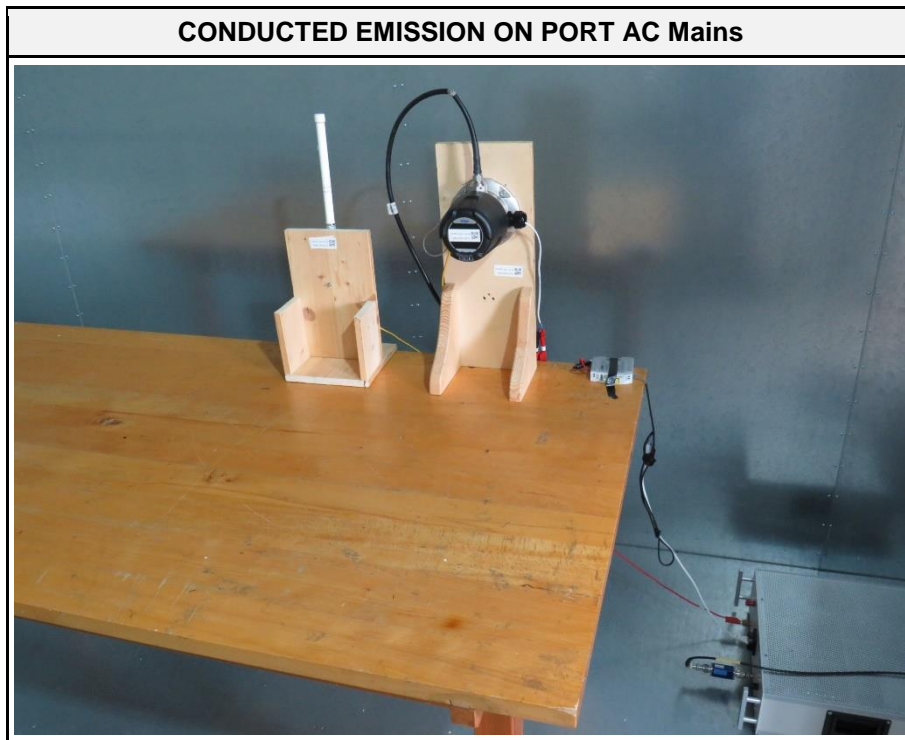

2.2.8 Records

**Conducted emissions at the mains power port according to FCC part 15B**

Project Number: G0M-2103-9685  
 Applicant: Dräger Safety AG & Co. KGaA  
 Model Description: Polytron Repeater WirelessHART  
 Model: Polytron Repeater WirelessHART  
 Test Sample ID: 34489  
 Test Site: Eurofins Product Service GmbH  
 Operator: Mr. Liebich  
 Test Date: 2021-09-24  
 Operating Conditions: ambient temperature: 22 °Celsius  
 power input: 24 V DC by AC/DC-Adaptor (120 V / 60 Hz)  
 LISN: Schwarzbeck NSLK 8127 RC N  
 Operational Mode & EUT Configuration: Mode 1  
 Configuration 2  
 Applied to Port: AC Mains  
 Note 1: --

Index 21

**RadiMation**

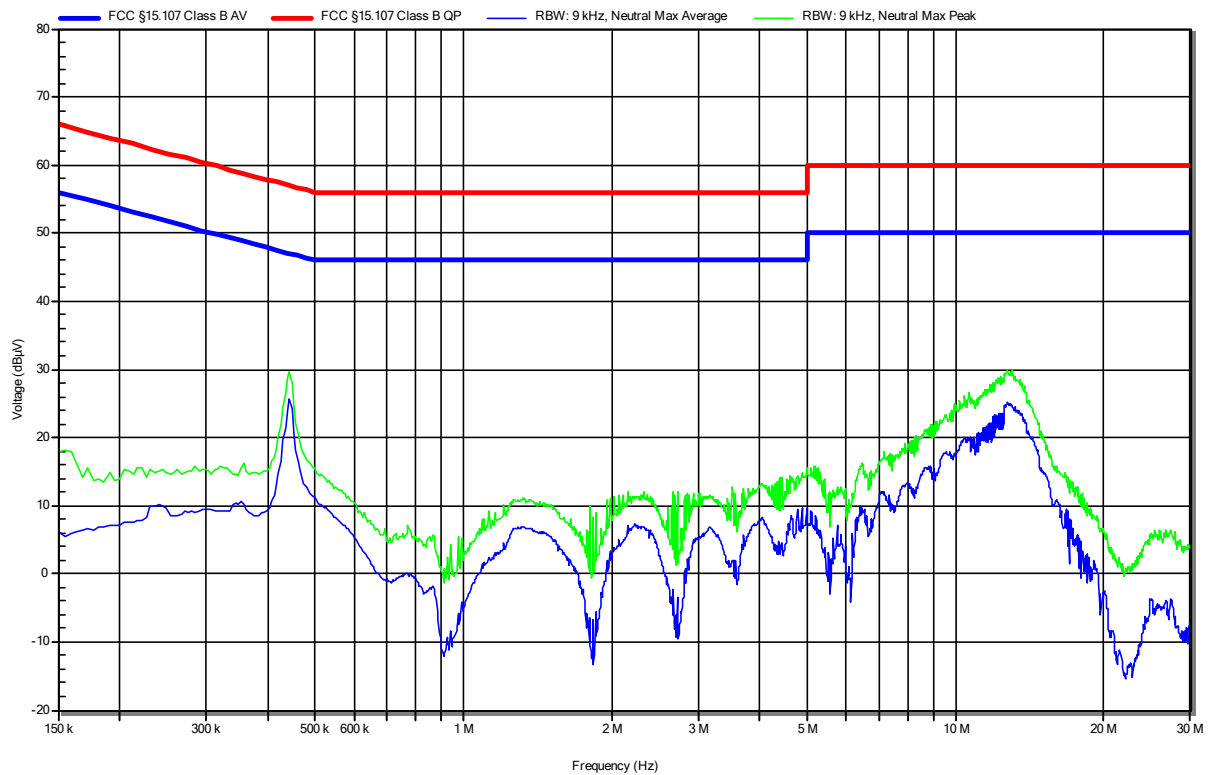

**Conducted emissions at the mains power port according to FCC part 15B**

Project Number: G0M-2103-9685  
 Applicant: Dräger Safety AG & Co. KGaA  
 Model Description: Polytron Repeater WirelessHART  
 Model: Polytron Repeater WirelessHART  
 Test Sample ID: 34489  
 Test Site: Eurofins Product Service GmbH  
 Operator: Mr. Liebich  
 Test Date: 2021-09-24  
 Operating Conditions: ambient temperature: 22 °Celsius  
 power input: 24 V DC by AC/DC-Adaptor (120 V / 60 Hz)  
 LISN: Schwarzbeck NSLK 8127 RC L  
 Operational Mode & EUT Configuration: Mode 1  
 Configuration 2  
 Applied to Port: AC Mains  
 Note 1: --

Index 22

**Radiation**

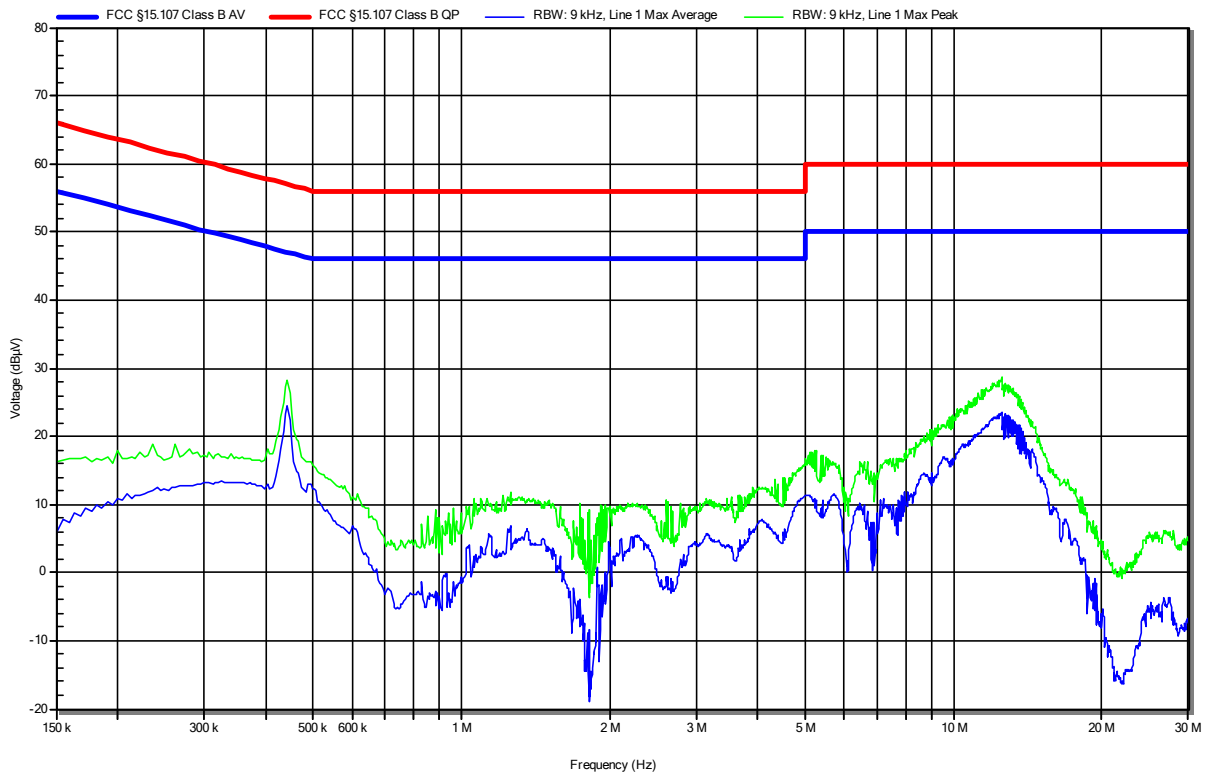

### 3 Measurement Uncertainty

All test measurements carried out are traceable to national standards. The uncertainty of the measurement at a confidence level of approximately 95%, with a coverage factor of 2.

Test Name	Measurement Uncertainty
Conducted emissions at the mains power port	150kHz to 30MHz, 3.35dB
Radiated Emission	30MHz to 200MHz @ 3m, 5.1dB 200MHz to 1GHz @ 3m, 5.3dB >1GHz to 6GHz @3m, 5.95dB