



<b>RADIO REPORT</b> <b>FCC 47 CFR Part 15C</b> <b>Digital transmission systems operating within the 2400.0 MHz - 2483.5 MHz band</b>	
<b>Report Reference No</b>	G0M-2009-9279-TFC247BL-V01
<b>Testing Laboratory</b>	Eurofins Product Service GmbH
<b>Address</b>	Storkower Str. 38c 15526 Reichenwalde Germany
<b>Accreditation</b>	 <p>                     DAkkS - Registration number : D-PL-12092-01-03 (ISED)                      ISED Testing Laboratory site: 3470A                      DAkkS - Registration number : D-PL-12092-01-04 (FCC)                      FCC Filed Test Laboratory, Reg.-No.: 96970                 </p>
<b>Applicant</b>	Dräger Safety AG & Co. KGaA
<b>Address</b>	Revalstraße 1 23560 Lübeck GERMANY
<b>Test Specification</b>	47 CFR Part 15C
<b>Non-Standard Test Method</b>	None
<b>Equipment under Test (EUT):</b>	
<b>Product Description</b>	Fixed Gas Detector
<b>Model(s)</b>	Polytron 6100 EC WL
<b>Additional Model(s)</b>	None
<b>Brand Name(s)</b>	None
<b>Hardware Version(s)</b>	RC002
<b>Software Version(s)</b>	Transmitter: P6100 V1.5.7, Centero FW v02.00.08, Bootloader V2.5.0, SW Telit BLT V3.12.002
<b>FCC ID</b>	X6O-RC002
<b>IC</b>	5895F-RC002
<b>Test Result</b>	<b>PASSED</b>

<b>Possible test case verdicts:</b>		
Required by standard but not tested	N/T	
Not required by standard	N/R	
Not applicable to EUT	N/A	
Test object does meet the requirement	P(PASS)	
Test object does not meet the requirement	F(FAIL)	
<b>Testing:</b>		
Test Lab Temperature	20 °C - 30 °C	
Test Lab Humidity	25 % - 55 %	
Date of receipt of test item	2022-06-20	
<b>Report:</b>		
Compiled by	Odai Qawasmeh	
Tested by (+ signature) (Responsible for Test)	Odai Qawasmeh	
Approved by (+ signature) (Test Lab Engineer)	Wilfried Treffke	
Date of Issue	2022-12-12	
Total number of pages	35	
<b>General Remarks:</b>		
<p>The test results presented in this report relate only to the object tested.</p> <p>The results contained in this report reflect the results for this particular model and serial number. It is the responsibility of the manufacturer to ensure that all production models meet the intent of the requirements detailed within this report.</p> <p>This report shall not be reproduced, except in full, without the written approval of the Issuing testing laboratory.</p>		
<b>Additional Comments:</b>		

**ADDITIONAL VARIANTS**

Additional Variants (not tested and not evaluated variants)		
Not-tested Variant	Description	
1	Product Type Description	Polytron Repeater ISA100
	Model name	Polytron Repeater ISA
	Brand name	-
	Hardware Version	RC002
	Software Version	Polytron Repeater V1.5.7, Centero FW v02.00.08, Bootloader V2.5.0, SW Telit BLT V3.12.002
	HVIN	RC002
	PMN	Polytron Repeater ISA
Comment: This named additional variant above has not been tested. This additional variant of the series has been declared by the manufacturer. The test report explicitly states that this variant was neither tested nor assessed nor evaluated.		

Additional Antennas (not tested and not evaluated variants)		
Not-tested Antenna	Description	
1	Type	External
	Model	1399.17.0232
	Manufacturer	Huber+Suhner
	Gain	2 dBi (declared by customer)
2	Type	External
	Model	F9915KW
	Manufacturer	Yokogawa
	Gain	2 dBi (declared by customer)
Comment: Those named additional antennas above have not been tested. Those additional antennas of the series have been declared by the manufacturer. The test report explicitly states that those antennas were neither tested nor assessed nor evaluated.		

## VERSION HISTORY

Version History			
Version	Issue Date	Remarks	Revised By
01	2022-12-12	Initial Release	

**ABBREVIATIONS AND ACRONYMS**

Acronyms	
Acronym	Description
EUT	Equipment Under Test
FCC	Federal Communications Commission
ISED	Innovation, Science and Economic Development Canada
RBW	Resolution bandwidth
RMS	Root mean square
VBW	Video bandwidth
V <sub>NOM</sub>	Nominal supply voltage

**REPORT INDEX**

<b>1</b>	<b>Equipment (Test Item) Under Test.....</b>	<b>7</b>
1.1	Photos – Equipment External.....	8
1.2	Photos – Equipment Internal.....	12
1.3	Support Equipment.....	14
1.4	Test Modes.....	15
1.5	Test Frequencies.....	16
1.6	Sample emission level calculation.....	17
<b>2</b>	<b>Result Summary.....</b>	<b>18</b>
<b>3</b>	<b>Test Conditions and Results.....</b>	<b>19</b>
3.1	Test Conditions and Results - AC powerline conducted emissions.....	19
3.2	Test Conditions and Results - Transmitter radiated emissions.....	23
ANNEX A	Transmitter spurious emissions.....	29

## 1 Equipment (Test Item) Under Test

Description	Fixed Gas Detector	
Model	Polytron 6100 EC WL	
Additional Model(s)	None	
Brand Name(s)	None	
Serial Number(s)	ARB-0024	
Test Sample ID(s)	40425	
Hardware Version(s)	RC002	
Software Version(s)	Transmitter: P6100 V1.5.7, Centro FW v02.00.08, Bootloader V2.5.0, SW Telit BLT V3.12.002	
FCC ID	X6O-RC002	
IC	5895F-RC002	
Equipment type	End Product	
Radio type	Transceiver	
Assigned frequency bands	2400.0 MHz - 2483.5 MHz	
Radio technology	Bluetooth LE 4.2	
Bluetooth Specification	LE 1M PHY	Yes
	LE 2M PHY	Yes
	LE Coded PHY S=8 (125 kbit)	No
	LE Coded PHY S=2 (500 kbit)	No
	Stable Modulation Index - Transmitter	No
	Stable Modulation Index - Receiver	No
Modulation	GFSK	
Number of antenna ports	1	
Radio Module	Type	Bluetooth Module
	Model	BlueMod + S42 ATEX
	Manufacturer	Telit Communication
	HW Version	BE890D2SY3ATA11
	SW Version	3.012.0002
	FCC-ID	RFRMS42
	IC	4957A-MS42
Antenna	Type	Integrated ceramic chip antenna
	Model	Not specified
	Manufacturer	Not specified
	Gain	2 dBi
Supply Voltage 1	V <sub>NOM</sub>	24 VDC
Supply Voltage 2	V <sub>NOM</sub>	14.4 VDC (Battery)
Operating Temperature	T <sub>NOM</sub>	20°C
Manufacturer	Dräger Safety AG & Co. KGaA Revalstraße 1 23560 Lübeck GERMANY	

1.1 Photos – Equipment External

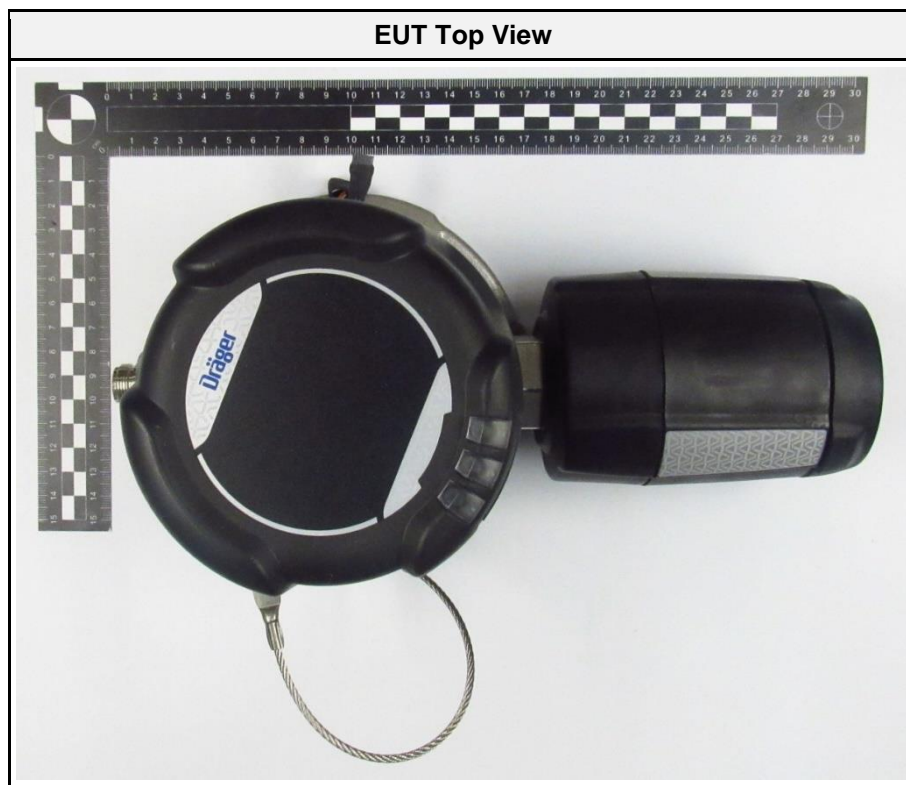



**EUT Bottom View**



**EUT Battery Slot**



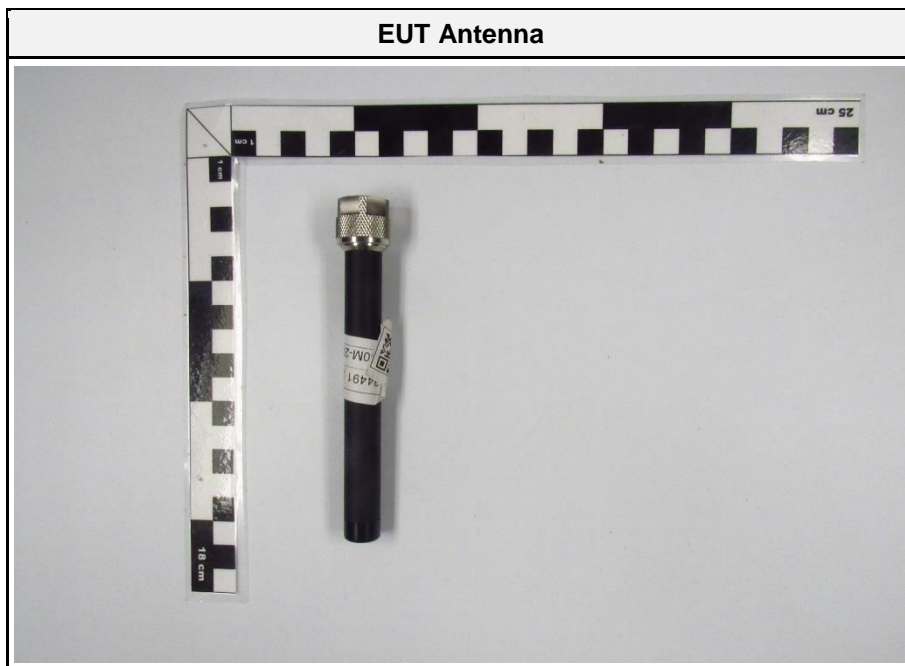
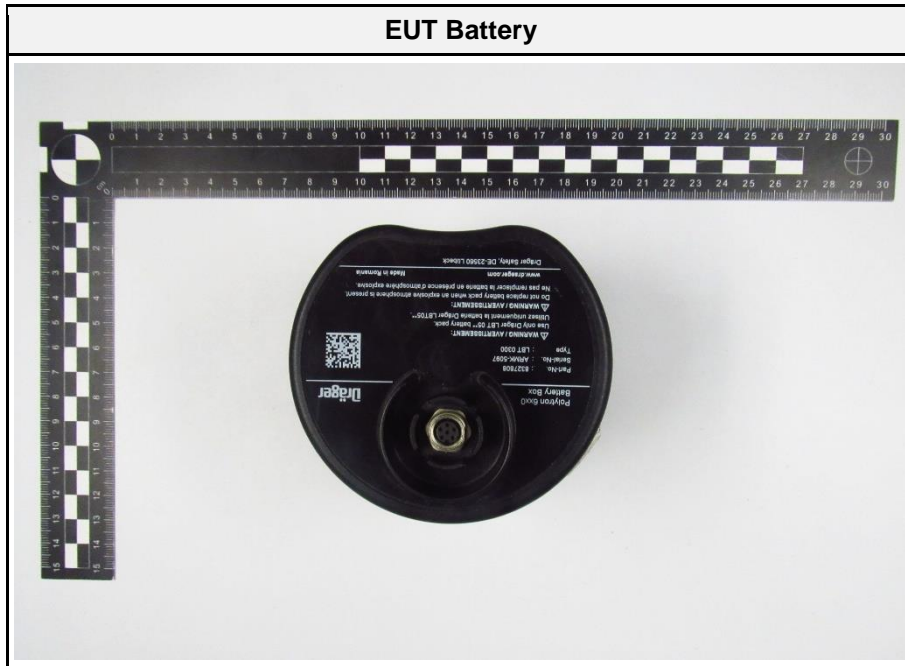

**USB Cable for BT Mode**



**EUT with auxiliary equipment**



## 1.2 Photos – Equipment Internal

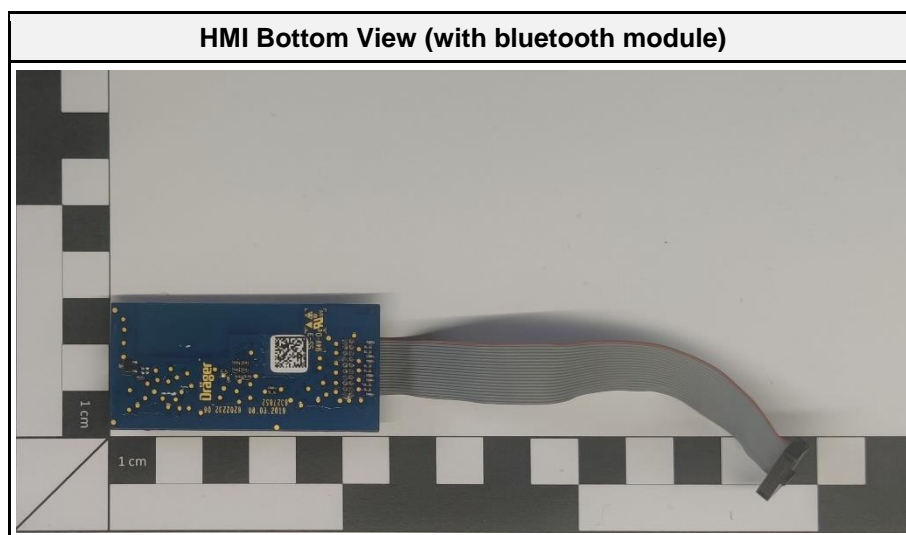
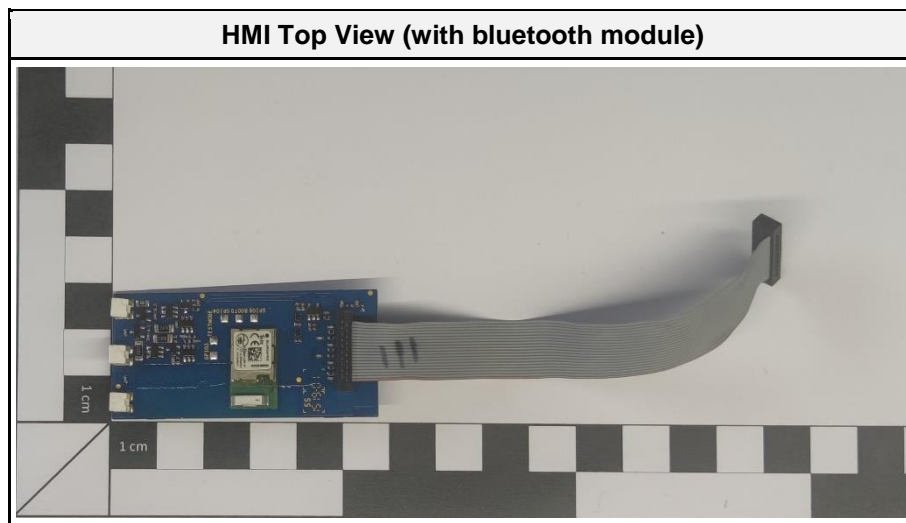

**SWEETII Top (main board with ISA100)**

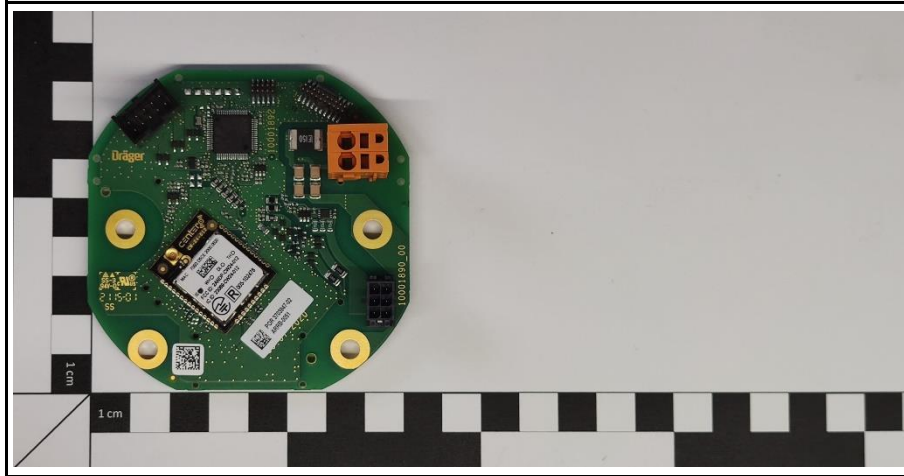

**SWEETII Bottom (main board with ISA100)**

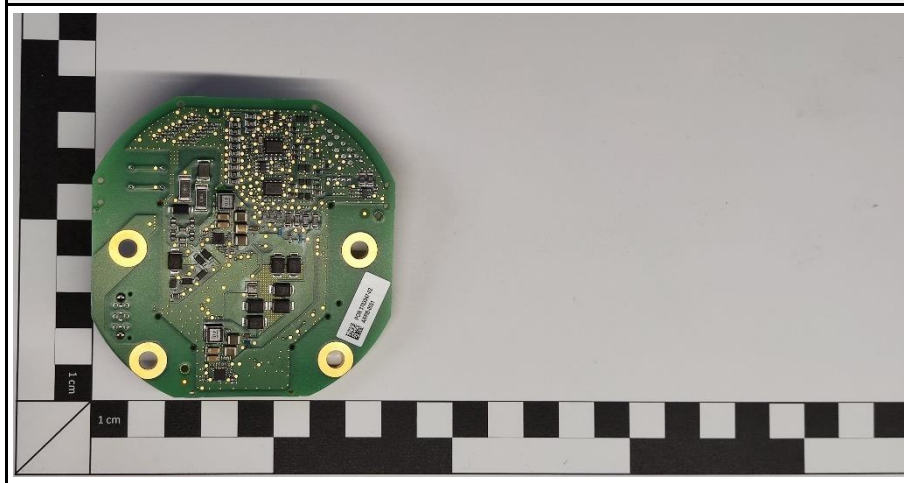

### 1.3 Support Equipment

Product Type	Device	Manufacturer	Model	Comment
AE	Notebook	Dell	-	-
CBL	USB cable	-	-	for configuring test modes
Description:				
AE	Auxiliary Equipment			
SIM	Simulator			
CBL	Connecting Cable			
SFT	Software			
Comment:				

#### 1.4 Test Modes

Mode	Description
GFSK	Mode = Transmit Modulation = GFSK Channel = 0 (2402 MHz) Spreading = None Data rate = 1 Mbps Duty cycle = 64%
Receive	Mode = Receive
Comment 1: Worst case was found in module test report number 1-2078/16-01-05-A issued by CETECOM ICT Services on 2016-09-07. Comment 2: Packet length, packet type and output power could not be adjusted with provided software tool.	

### 1.5 Test Frequencies

Designator	Mode	Channel	Frequency [MHz]
F1	Tx	0	2402
F2	Tx	39	2480



### 1.6 Sample emission level calculation

The following is a description of terms and a sample calculation, as appears in the radiated emissions data table. The numbers used in the calculation are for example only. There is no direct correlation to the specific data taken for the product described in this document:

Reading:

This is the reading obtained on the spectrum analyzer in dBµV. Any external preamplifiers used are taken into account through internal analyzer settings.

A.F.:

This is the antenna factor for the receiving antenna. It is a conversion factor, which converts electric fields strengths to voltages, which can be measured directly on the spectrum analyzer. It is treated as a loss in dB. Cable losses have been included with the A.F. to simplify the calculations. The antenna factor is used in calculations as follows:

$$\text{Reading on Analyzer (dB}\mu\text{V)} + \text{A.F. (dB/m)} = \text{Net field strength (dB}\mu\text{V/m)}$$

Net:

This is the net field strength measurement (as shown above).

Limit:

This is the FCC Class B radiated emission limit (in units of dBµV/m). The FCC limits are given in units of µV/m. The following formula is used to convert the units of µV/m to dBµV/m:

$$\text{Limit (dB}\mu\text{V/m)} = 20 \cdot \log(\mu\text{V/m})$$

Margin:

This is the margin of compliance below the FCC limit. The units are given in dB. A negative margin indicates the emission was below the limit. A positive margin indicates that the emission exceeds the limit.

Example only:

Reading + AF	=	Net Reading	:	Net reading - FCC limit	=	Margin
+21.5 dBµV + 26 dB/m		= 47.5 dBµV/m		47.5 dBµV/m - 57.0 dBµV/m		= -9.5 dB

## 2 Result Summary

FCC 47 CFR Part 15C				
Product Standard Reference	Requirement	Reference Method	Result	Remarks
FCC § 15.247(a)(2)	6 dB Bandwidth	ANSI C63.10-2013	N/T	
FCC § 15.247(b)	Maximum peak conducted power	ANSI C63.10-2013	N/T	
FCC § 15.247(e)	Power spectral density	ANSI C63.10-2013	N/T	
FCC § 15.207	AC power line conducted emissions	ANSI C63.10-2013	PASS	
FCC § 15.247(d)	Band edge compliance	ANSI C63.10-2013	N/T	
FCC § 15.247(d)	Conducted spurious emissions	ANSI C63.10-2013	N/T	
FCC § 15.247(d) FCC § 15.209	Transmitter radiated spurious emissions	ANSI C63.10-2013	PASS	
Comment:				

Possible Test Case Verdicts	
PASS	Test object does meet the requirements
FAIL	Test object does not meet the requirements
N/T	Required by standard but not tested
N/R	Not required by standard for the test object

### 3 Test Conditions and Results

#### 3.1 Test Conditions and Results - AC powerline conducted emissions

##### 3.1.1 Information

Test Information	
Reference	FCC § 15.207
Measurement Method	ANSI C63.10 6.2
Measurement Uncertainty	± 3.82 dB
Operator	Odai Qawasmeh
Date	2022-06-27

##### 3.1.2 Limits

Limits		
Frequency [MHz]	Quasi-Peak [dBµV]	Average [dBµV]
0.15 - 0.5	66 - 56*	56 - 46*
0.5 - 5	56	46
5 - 30	60	50

\* Limit decreases linearly with the logarithm of the frequency

##### 3.1.3 Setup

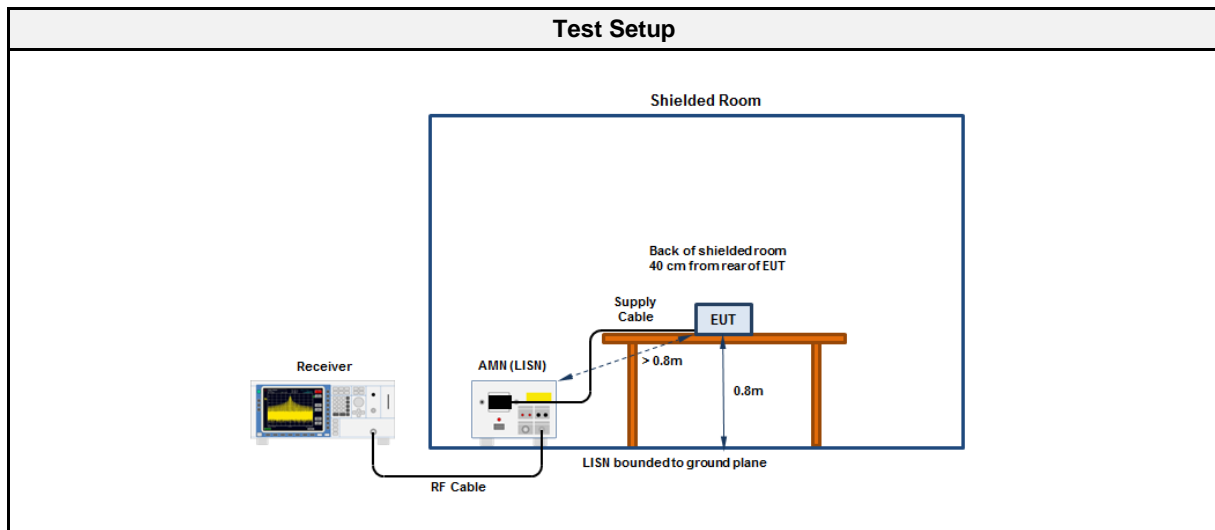

##### 3.1.4 Equipment

Test Software			
Description	Manufacturer	Name	Version
EMC Software	DARE Instruments	RadiMation	2020.1.8

Test Equipment					
Description	Manufacturer	Model	Identifier	Cal. Date	Cal. Due
EMI Test Receiver	R&S	ESR7	EF00943	2021-08	2022-08
Pulse Limiter	R&S	ESH3-Z2	EF01222	2021-07	2022-07
LISN	Schwarzbeck	NSLK 8127 RC	EF01592	2021-07	2022-07

3.1.5 Setup Photos

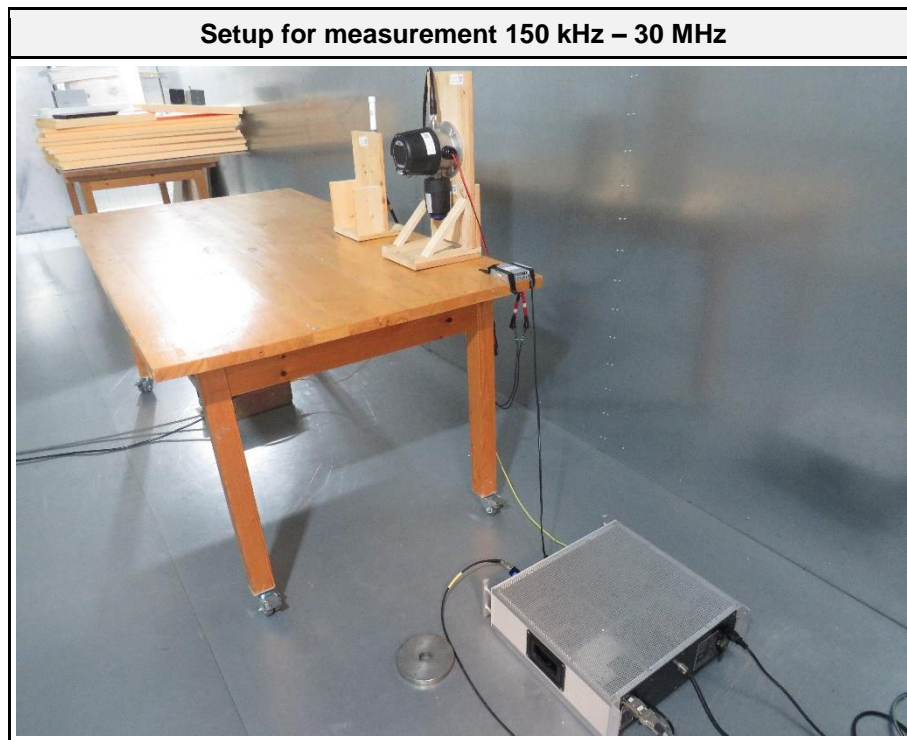

**Conducted emissions at the mains power port according to 47 CFR Part FCC 15.247**

Project Number: G0M-2009-9279  
 Applicant: Dräger Safety AG & Co. KGaA  
 Model Description: Fixed Gas Detector  
 Model: Polytron 6100 EC WL  
 Test Sample ID: 40294  
 Test Site: Eurofins Product Service GmbH  
 Operator: Mr. Neuner  
 Test Date: 2022-06-27  
 Operating Conditions: ambient temperature: 24.6 °Celsius  
 LISN: Schwarzbeck NSLK 8127  
 Operational Mode: BT-LE, Channel 0, 1 Mbps  
 EUT Configuration:  
 Applied to Port: 120V AC, 60Hz  
 Note 1:

Index 42  
**RadiMation**

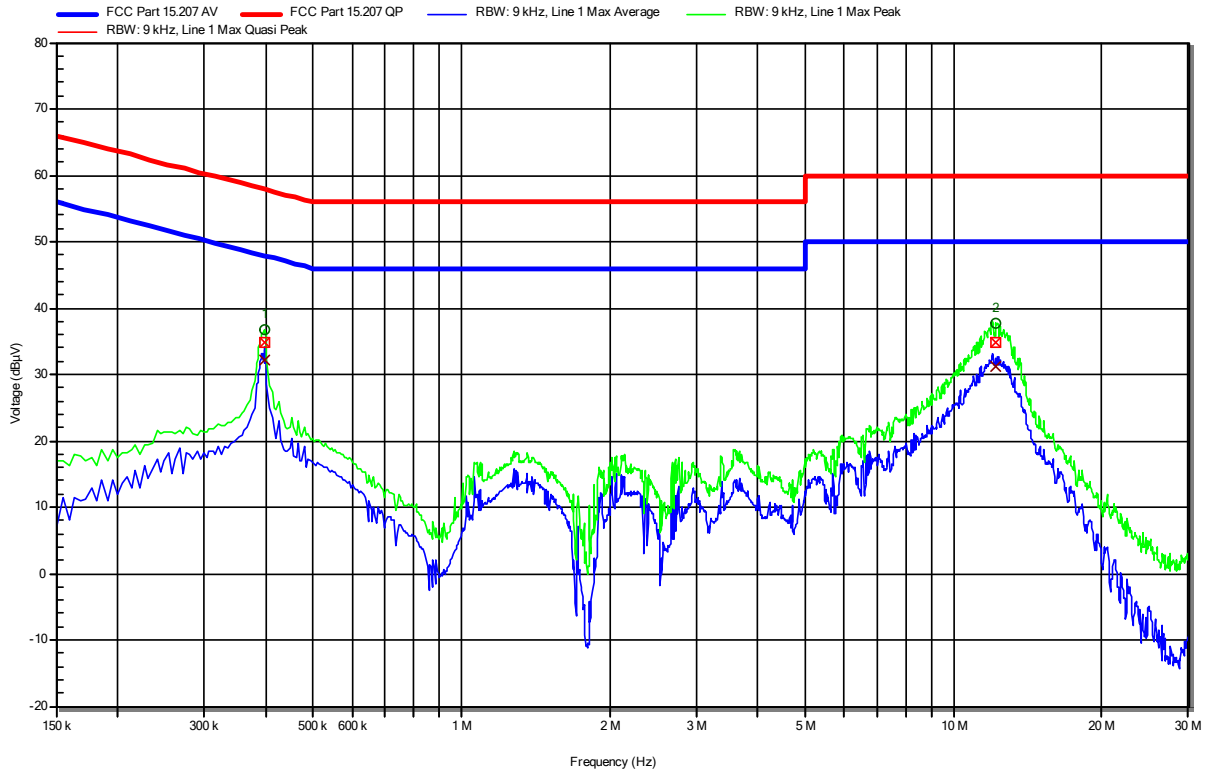

Peak Number	Frequency	Quasi-Peak	Quasi-Peak Limit	Quasi-Peak Difference	Quasi-Peak Status	LISN
1	397.05 kHz	34.71 dBµV	57.91 dBµV	-23.21 dB	Pass	Line 1
2	12.201 MHz	34.75 dBµV	60 dBµV	-25.25 dB	Pass	Line 1

  

Peak Number	Frequency	Average	Average Limit	Average Difference	Average Status	LISN
1	397.05 kHz	32.26 dBµV	47.91 dBµV	-15.66 dB	Pass	Line 1
2	12.201 MHz	31.22 dBµV	50 dBµV	-18.78 dB	Pass	Line 1

**Conducted emissions at the mains power port according to 47 CFR Part FCC 15.247**

Project Number: G0M-2009-9279  
 Applicant: Dräger Safety AG & Co. KGaA  
 Model Description: Fixed Gas Detector  
 Model: Polytron 6100 EC WL  
 Test Sample ID: 40294  
 Test Site: Eurofins Product Service GmbH  
 Operator: Mr. Neuner  
 Test Date: 2022-06-27  
 Operating Conditions: ambient temperature: 24.6 °Celsius  
 LISN: Schwarzbeck NSLK 8127  
 Operational Mode: BT-LE, Channel 0, 1 Mbps  
 EUT Configuration:  
 Applied to Port: 120V AC, 60Hz  
 Note 1:

Index 43  
**RadiMation**

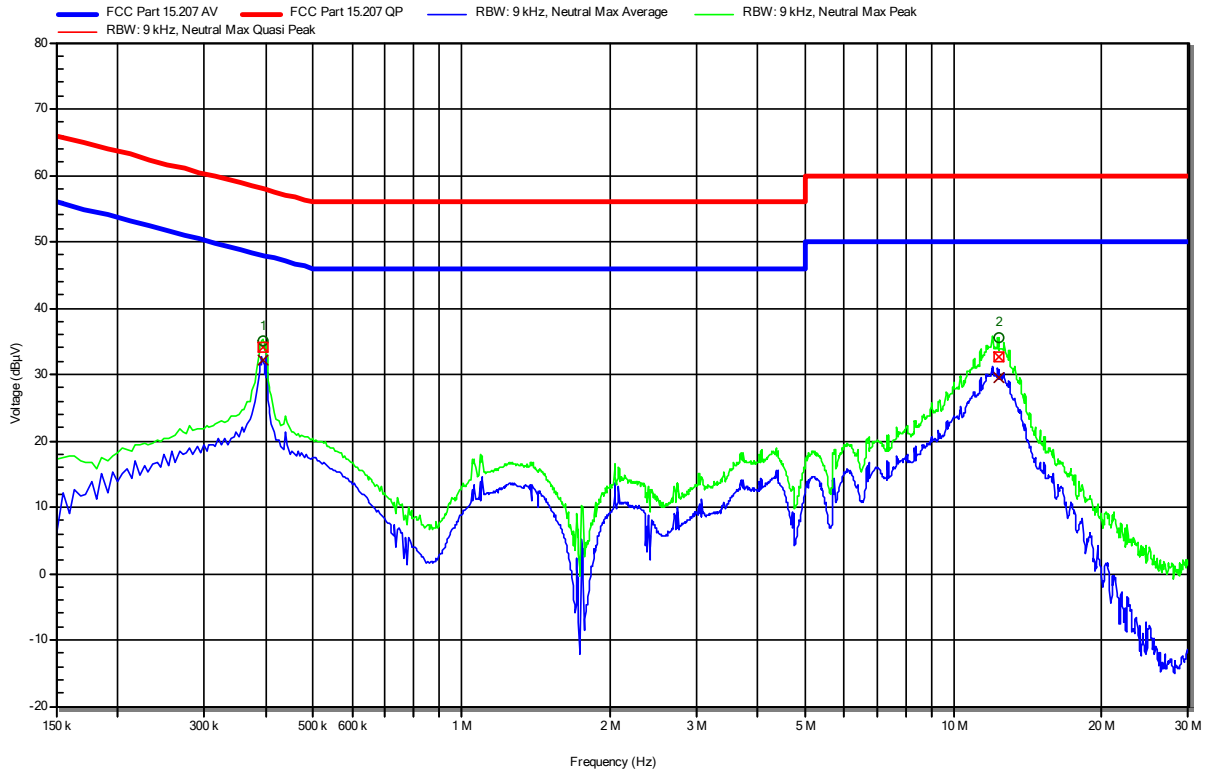

Peak Number	Frequency	Quasi-Peak	Quasi-Peak Limit	Quasi-Peak Difference	Quasi-Peak Status	LISN
1	393.9 kHz	34.21 dBµV	57.98 dBµV	-23.77 dB	Pass	Neutral
2	12.332 MHz	32.75 dBµV	60 dBµV	-27.25 dB	Pass	Neutral
Peak Number	Frequency	Average	Average Limit	Average Difference	Average Status	LISN
1	393.9 kHz	32.09 dBµV	47.98 dBµV	-15.89 dB	Pass	Neutral
2	12.332 MHz	29.46 dBµV	50 dBµV	-20.54 dB	Pass	Neutral

### 3.2 Test Conditions and Results - Transmitter radiated emissions

#### 3.2.1 Information

Test Information	
Reference	FCC § 15.247(d); FCC § 15.209
Measurement Uncertainty	± 5.95 dB
Measurement Method	ANSI C63.10 6.4, 6.5, 6.6, 11.12
Operator	Odai Qawasmeh
Date	2022-06-24

#### 3.2.2 Limits

Limits			
Frequency range [MHz]	Detector	Field strength [ $\mu\text{V}/\text{m}$ ]	Measurement distance [m]
0.009 - 0.09	Average	2400/F[kHz]	300
0.09 - 0.110	Quasi-Peak	2400/F[kHz]	300
0.110 - 0.490	Average	2400/F[kHz]	300
0.490 - 1.705	Quasi-Peak	24000/F[kHz]	30
1.705 - 30.0	Quasi-Peak	30	30
30 - 88	Quasi-Peak	100	3
88 - 216	Quasi-Peak	150	3
216 - 960	Quasi-Peak	200	3
960 - 1000	Quasi-Peak	500	3
>1000	Average	500	3

#### 3.2.3 Setup

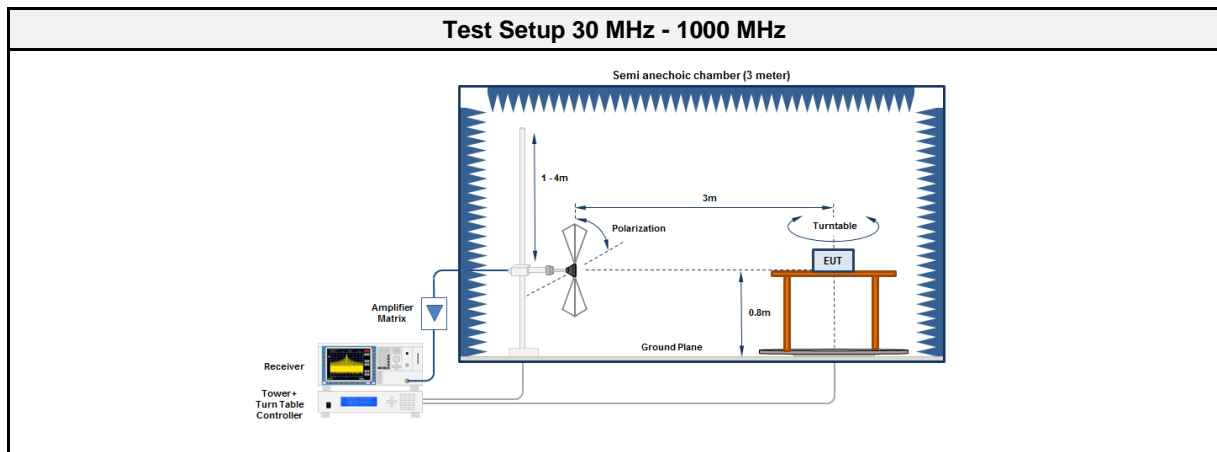

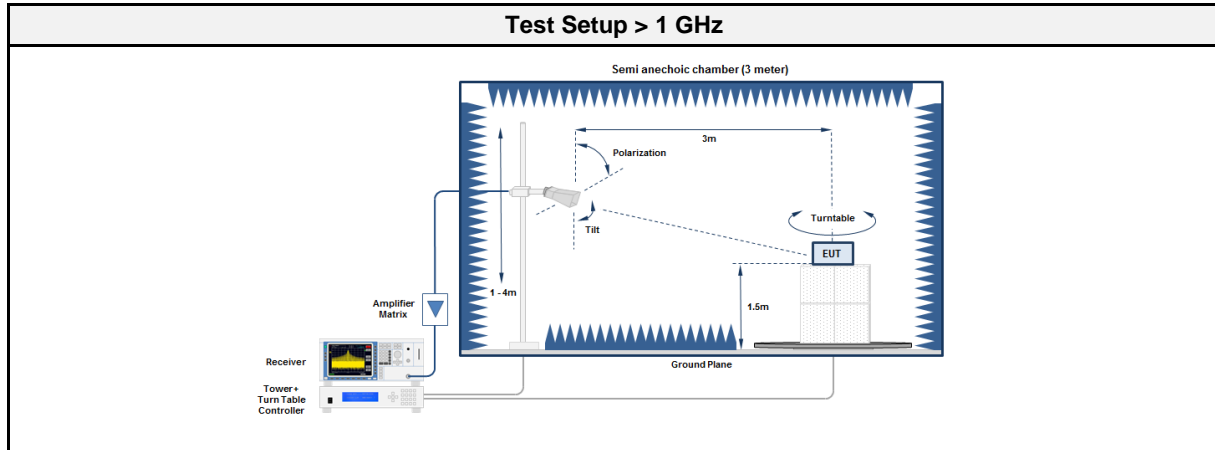

### 3.2.4 Equipment

Test Software			
Description	Manufacturer	Name	Version
EMC Software	DARE Instruments	RadiMation	2020.1.8

Test Equipment 30 MHz - 1000 MHz					
Description	Manufacturer	Model	Identifier	Cal. Date	Cal. Due
Anechoic Chamber	Frankonia	AC1	EF00062	2021-02	2024-02
Measurement Receiver	Agilent	N9038A-526/WXP	EF01070	2021-07	2022-07
Antenna	R&S	HK 116	EF00030	2021-05	2024-05
Antenna	R&S	HL 223	EF00187	2022-06	2025-06

Test Equipment > 1 GHz					
Description	Manufacturer	Model	Identifier	Cal. Date	Cal. Due
Anechoic chamber	Frankonia	AC 2	EF01616	2021-09	2022-09
Spectrum analyzer	R&S	FSU43	EF01631	2021-07	2022-07
Horn antenna	Schwarzbeck	BBHA 9120B	EF01678	2021-03	2024-03
Horn Antenna	Schwarzbeck	HWRD 650	EF01679	2021-03	2024-03
Antenna	Amplifier Research	AT4560	EF00302	2021-06	2023-06

### 3.2.5 Procedure

Test Procedure 30 MHz - 1000 MHz
<ol style="list-style-type: none"> <li>EUT is placed on a non conducting support at the center of a turn table 0.8 m above the ground</li> <li>EUT set to test mode</li> <li>The receiver is set to peak detection with max hold</li> <li>The EUT is rotated through 360° and the height of the antenna is varied from 1 m to 4 m</li> <li>All significant emissions are measured again using the corresponding final detector</li> </ol>

Test Procedure > 1 GHz
<ol style="list-style-type: none"> <li>EUT is placed on a non conducting support at the center of a turn table 1.5 m above the ground</li> <li>EUT set to test mode</li> <li>The receiver is set to peak detection with max hold</li> <li>The EUT is rotated through 360° and the height of the antenna is varied from 1 m to 4 m</li> <li>All significant emissions are measured again using the corresponding final detector</li> </ol>



### 3.2.6 Results

Test Results						
Channel [MHz]	Emission [MHz]	Level [dB $\mu$ V/m]	Det.	Pol.	Limit [dB $\mu$ V/m]	Margin [dB]
2402	2286.8	43.12	pk	ver	74.00	-30.88
2402	2286.8	40.89	avg	ver	54.00	-13.11
2402	2312.9	58.34	pk	hor	74.00	-15.66
2402	2312.9	45.64	avg	hor	54.00	-08.36
2402	17819	44.44	pk	ver	74.00	-29.56
2402	17819	32.00	avg	ver	54.00	-22.00
2402	18466	48.50	pk	ver	74.00	-25.50
2402	18466	36.30	avg	ver	54.00	-17.70
2480	2491.2	59.34	pk	ver	74.00	-14.66
2480	2491.2	45.75	avg	ver	54.00	-08.25

3.2.7 Setup Photos

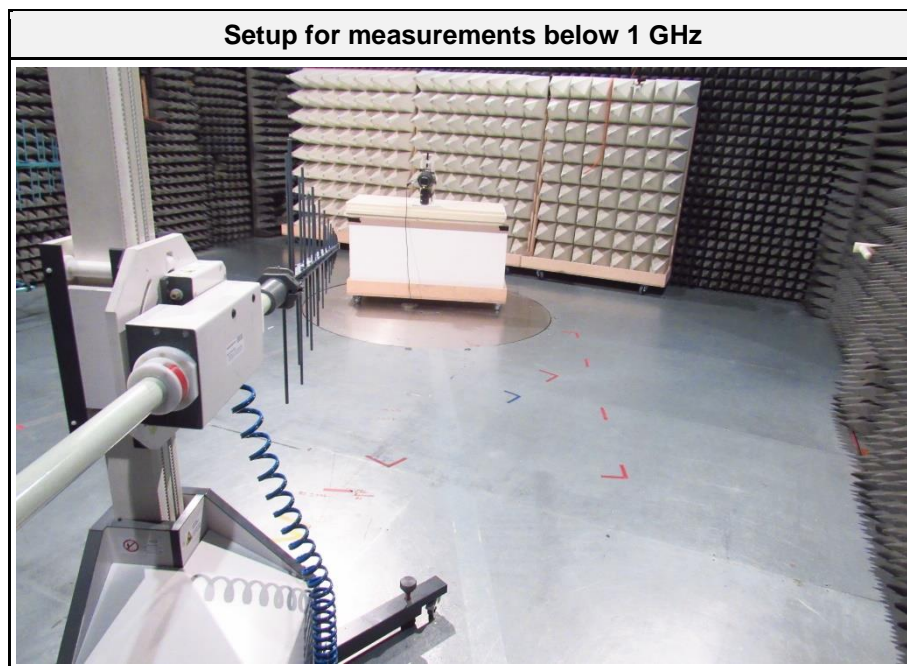
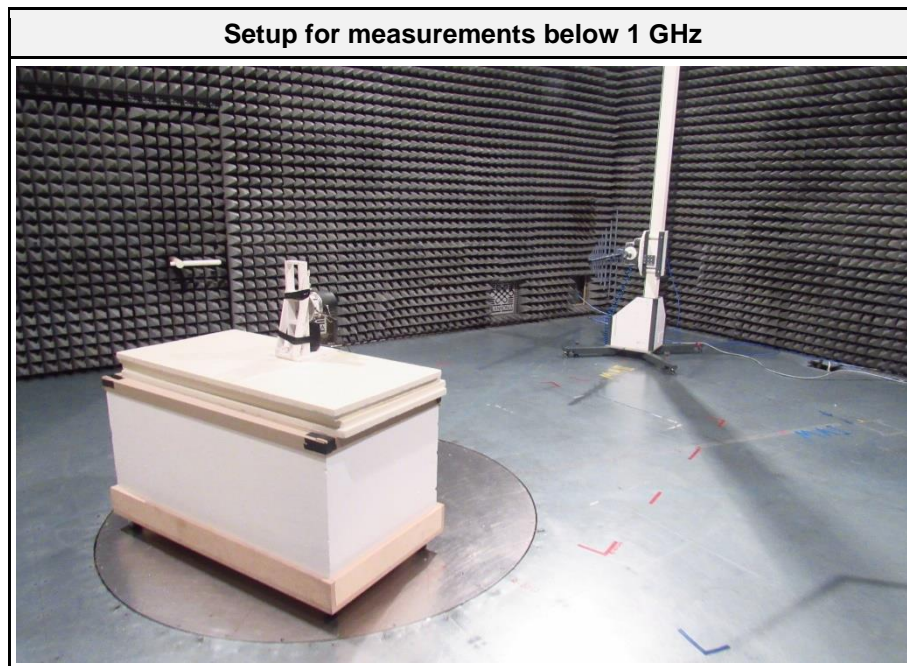

**EUT Test Setup**

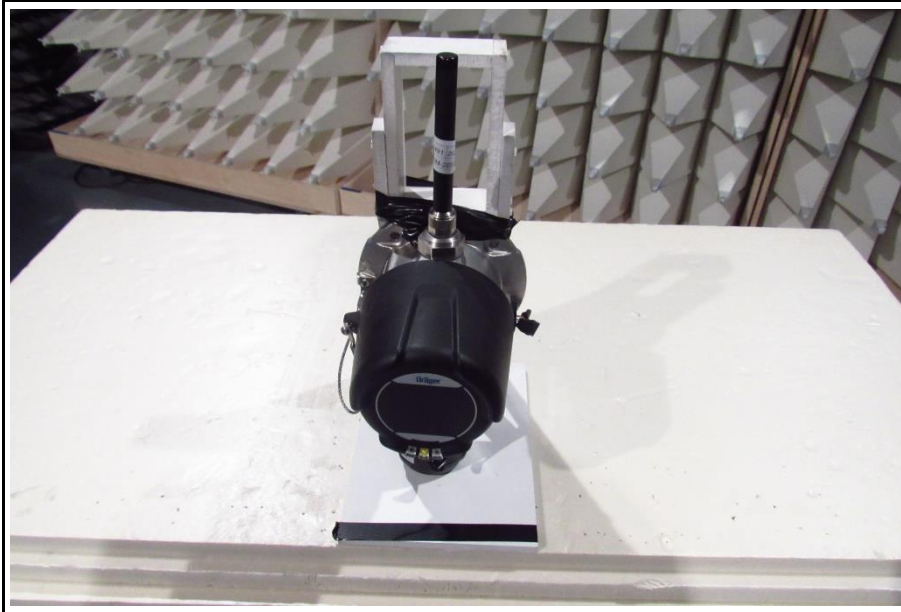

**Setup for measurements above 1 GHz**

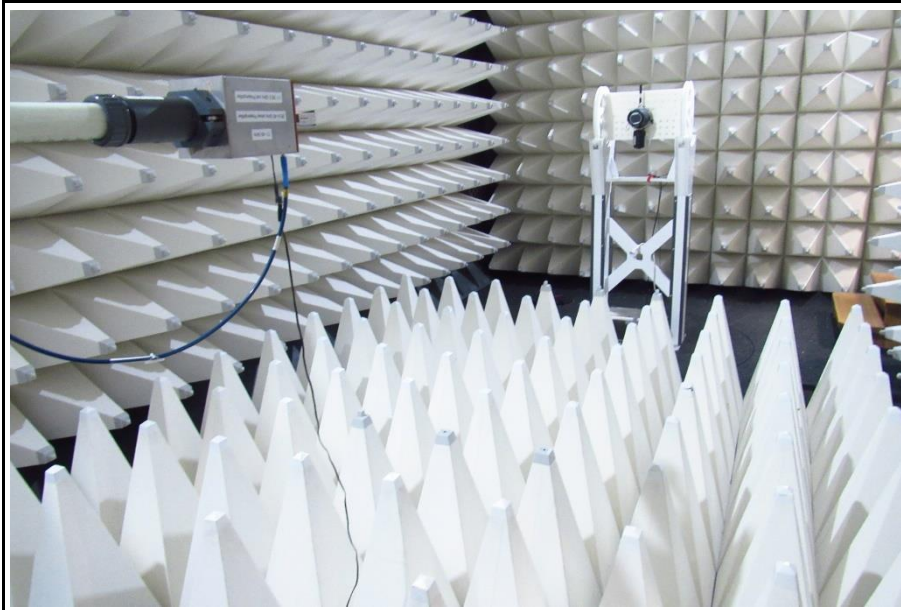

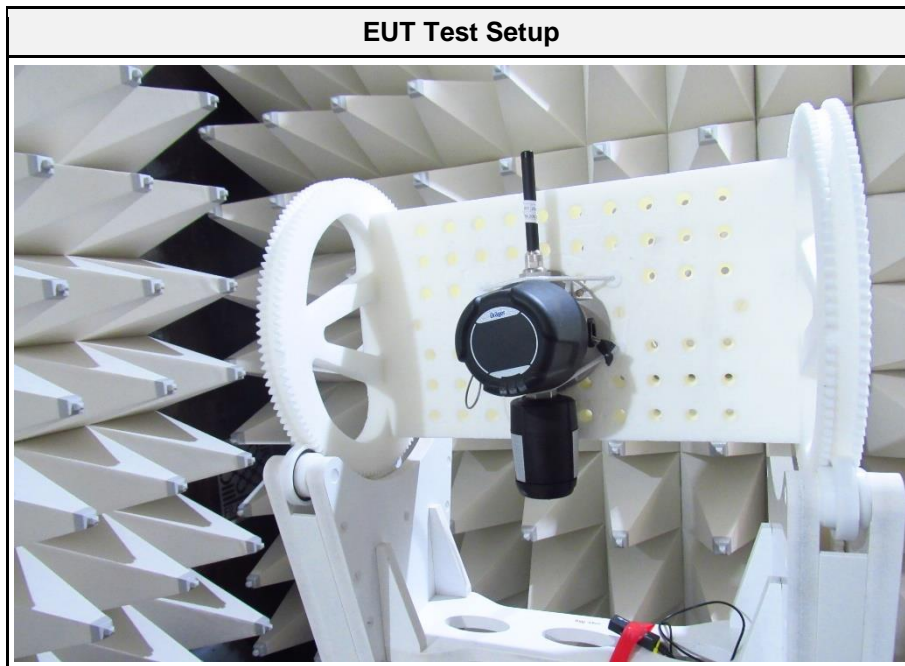

## ANNEX A Transmitter spurious emissions

### Radiated Spurious Emissions according to 47 CFR Part 15.247

Project Number: G0M-2009-9279  
 Applicant: Dräger Safety AG & Co. KGaA  
 Model Description: Fixed Gas Detector  
 Model: Polytron 6100 EC WL  
 Test Sample ID: 40425  
 Test Site: Eurofins Product Service GmbH  
 Operator: Mr. Qawasmeh  
 Measurement software: RadiMation, version 2020.1.8  
 Test Conditions: Tnom: 24 °Celsius, Vnom: 14.4 VDC (Lithium battery)  
 Antenna: Rohde & Schwarz HK 116  
 Measurement distance: 3 m  
 Mode: Tx; BLE 4.2; Ch 0; 1 Mbps  
 Test Date: 2022-06-27  
 Note:

Index 7

RadiMation

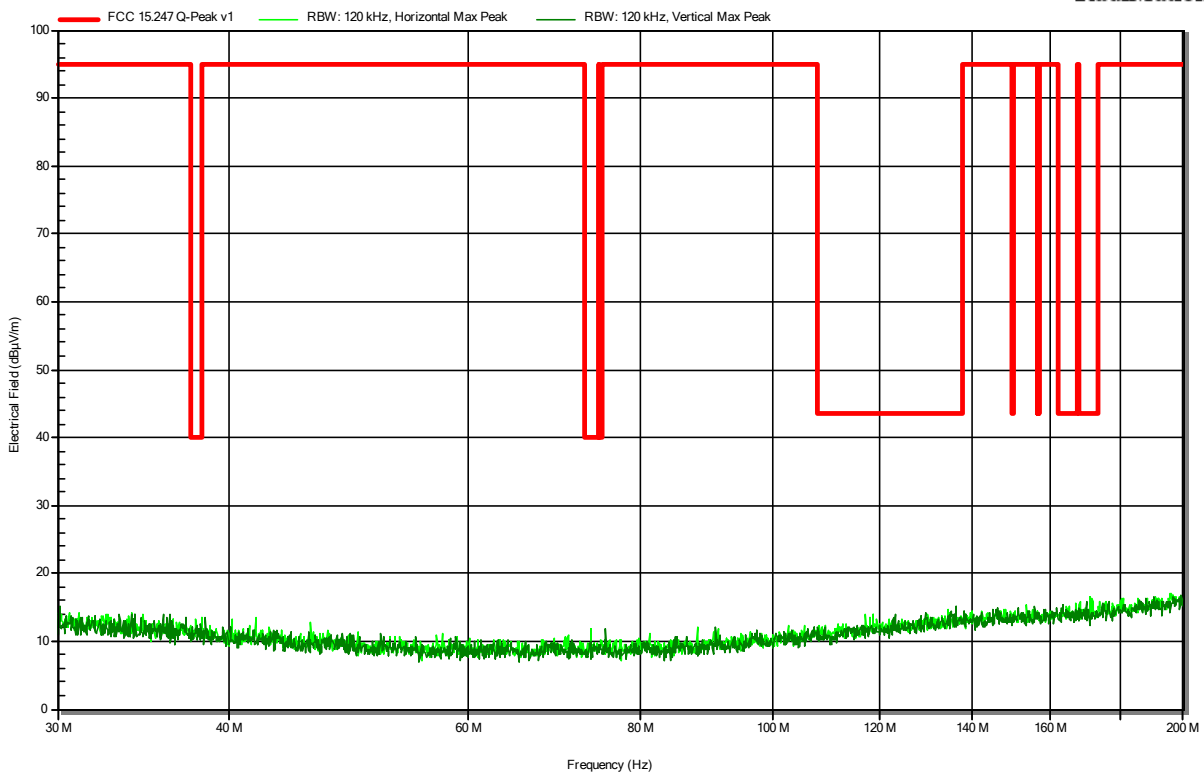

### Radiated Spurious Emissions according to 47 CFR Part 15.247

Project Number: G0M-2009-9279  
 Applicant: Dräger Safety AG & Co. KGaA  
 Model Description: Fixed Gas Detector  
 Model: Polytron 6100 EC WL  
 Test Sample ID: 40425  
 Test Site: Eurofins Product Service GmbH  
 Operator: Mr. Qawasmeh  
 Measurement software: RadiMation, version 2020.1.8  
 Test Conditions: Tnom: 24 °Celsius, Vnom: 14.4 VDC (Lithium battery)  
 Antenna: Rohde & Schwarz HL 223  
 Measurement distance: 3 m  
 Mode: Tx; BLE 4.2; Ch 0; 1 Mbps  
 Test Date: 2022-06-27  
 Note:

Index 9

**RadiMation**

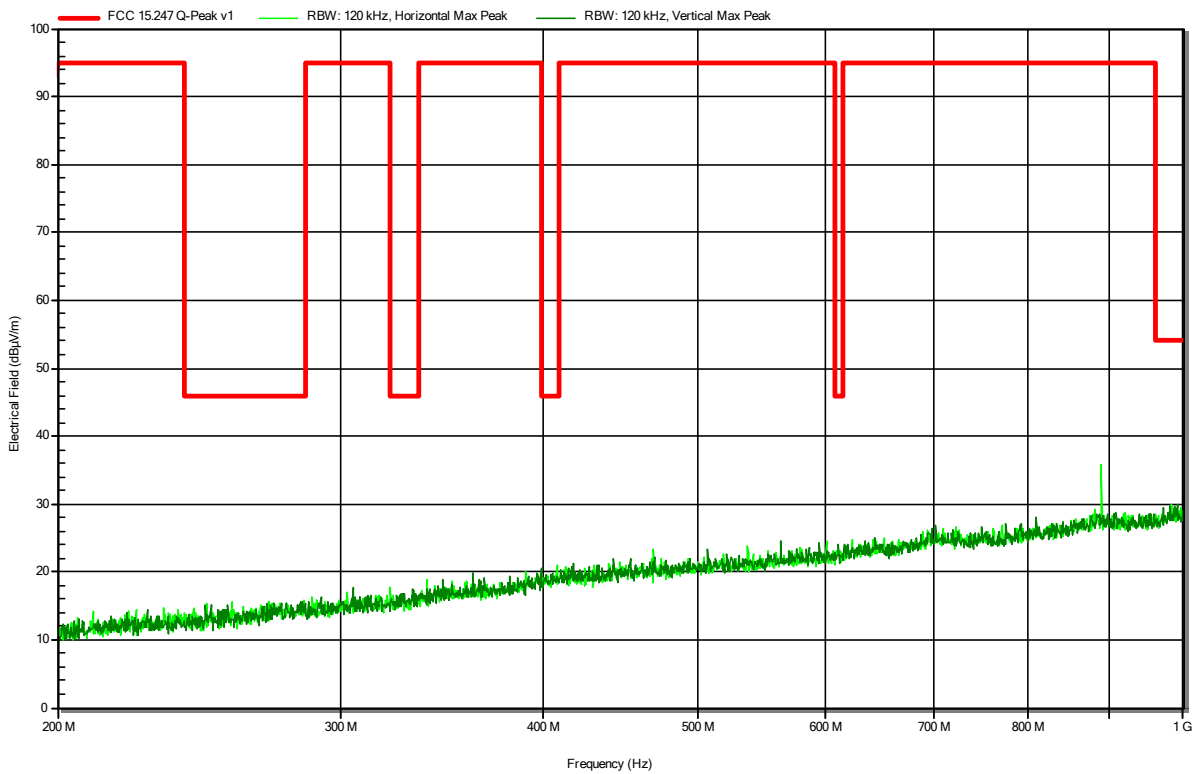

### Radiated Spurious Emissions according to 47 CFR Part 15.247

Project Number: G0M-2009-9279  
 Applicant: Dräger Safety AG & Co. KGaA  
 Model Description: Fixed Gas Detector  
 Model: Polytron 6100 EC WL  
 Test Sample ID: 40425  
 Test Site: Eurofins Product Service GmbH  
 Operator: Mrs Hoang  
 Measurement software: RadiMation, version 2020.1.8  
 Test Conditions: Tnom: 24 °Celsius, Vnom: 14.4 VDC (Lithium battery)  
 Antenna: Schwarzbeck BBHA 9120B  
 Measurement distance: 3 m  
 Mode: Tx; BLE 4.2; Ch 0; 1 Mbps  
 Test Date: 2022-06-24  
 Note: EUT horizontal

Index 2

**RadiMation**

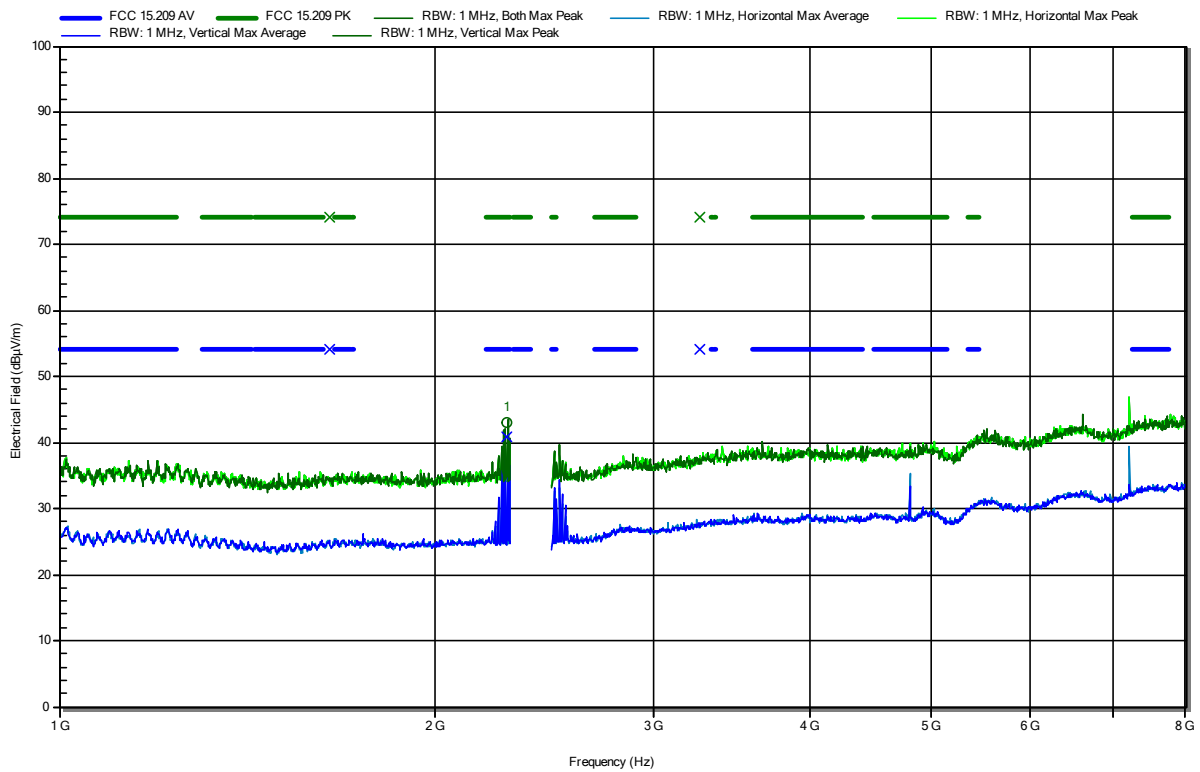

Frequency	Peak	Peak Limit	Peak Difference	Peak Status	Polarization
2.2868 GHz	43.12 dBµV/m	74 dBµV/m	-30.88 dB	Pass	Vertical
Frequency	Average	Average Limit	Average Difference	Average Status	Polarization
2.2868 GHz	40.89 dBµV/m	54 dBµV/m	-13.11 dB	Pass	Vertical

**Radiated Spurious Emissions according to 47 CFR Part 15.247**

Project Number: G0M-2009-9279  
 Applicant: Dräger Safety AG & Co. KGaA  
 Model Description: Fixed Gas Detector  
 Model: Polytron 6100 EC WL  
 Test Sample ID: 40425  
 Test Site: Eurofins Product Service GmbH  
 Operator: Mrs Hoang  
 Measurement software: RadiMation, version 2020.1.8  
 Test Conditions: Tnom: 24 °Celsius, Vnom: 14.4 VDC (Lithium battery)  
 Antenna: Schwarzbeck BBHA 9120B  
 Measurement distance: 3 m  
 Mode: Tx; BLE 4.2; Ch 0; 1 Mbps  
 Test Date: 2022-06-24  
 Note: lower bandedge

Index 3

**RadiMation**

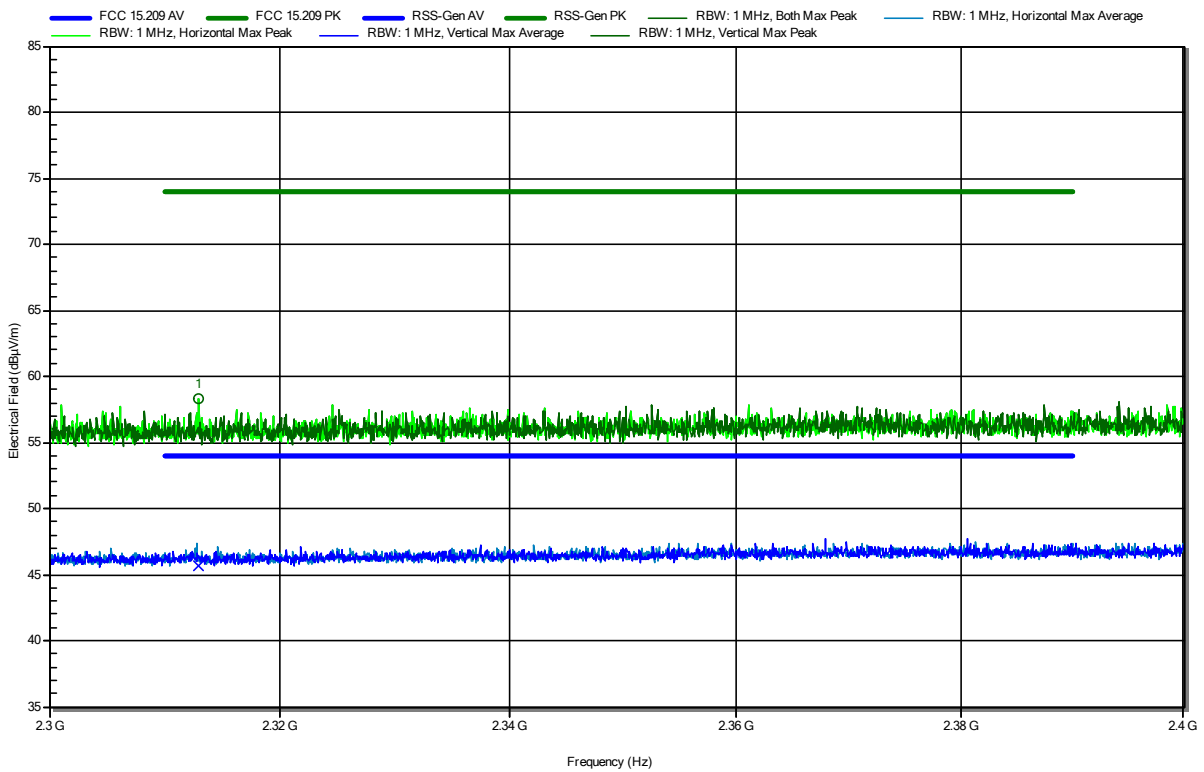

Frequency	Peak	Peak Limit	Peak Difference	Peak Status	Polarization
2.3129 GHz	58.34 dBµV/m	74 dBµV/m	-15.66 dB	Pass	Horizontal
Frequency	Average	Average Limit	Average Difference	Average Status	Polarization
2.3129 GHz	45.64 dBµV/m	54 dBµV/m	-8.36 dB	Pass	Horizontal



**Radiated Spurious Emissions according to 47 CFR Part 15.247**

Project Number: G0M-2009-9279  
 Applicant: Dräger Safety AG & Co. KGaA  
 Model Description: Fixed Gas Detector  
 Model: Polytron 6100 EC WL  
 Test Sample ID: 40425  
 Test Site: Eurofins Product Service GmbH  
 Operator: Mrs Hoang  
 Measurement software: RadiMation, version 2020.1.8  
 Test Conditions: Tnom: 24 °Celsius, Vnom: 14.4 VDC (Lithium battery)  
 Antenna: Schwarzbeck BBHA 9120B  
 Measurement distance: 3 m  
 Mode: Tx; BLE 4.2; Ch 0; 1 Mbps  
 Test Date: 2022-06-24  
 Note: upper bandedge

Index 4

**RadiMation**

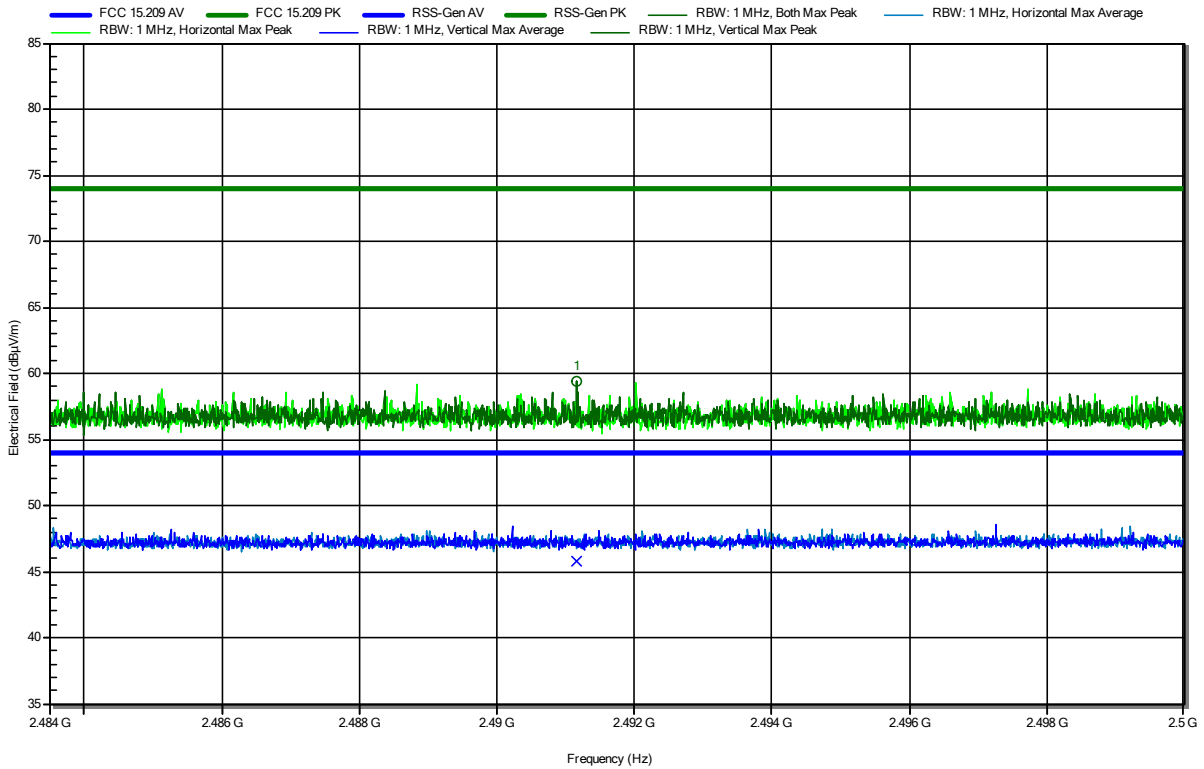

Frequency	Peak	Peak Limit	Peak Difference	Peak Status	Polarization
2.4912 GHz	59.34 dBµV/m	74 dBµV/m	-14.66 dB	Pass	Vertical
Frequency	Average	Average Limit	Average Difference	Average Status	Polarization
2.4912 GHz	45.75 dBµV/m	54 dBµV/m	-8.25 dB	Pass	Vertical

**Radiated Spurious Emissions according to 47 CFR Part 15.247**

Project Number: G0M-2009-9279  
 Applicant: Dräger Safety AG & Co. KGaA  
 Model Description: Fixed Gas Detector  
 Model: Polytron 6100 EC WL  
 Test Sample ID: 40425  
 Test Site: Eurofins Product Service GmbH  
 Operator: Mrs Hoang  
 Measurement software: RadiMation, version 2020.1.8  
 Test Conditions: Tnom: 24 °Celsius, Vnom: 14.4 VDC (Lithium battery)  
 Antenna: Schwarzbeck HWRD 650  
 Measurement distance: 3 m  
 Mode: Tx; BLE 4.2; Ch 0; 1 Mbps  
 Test Date: 2022-06-24  
 Note:

Index 5

**RadiMation**

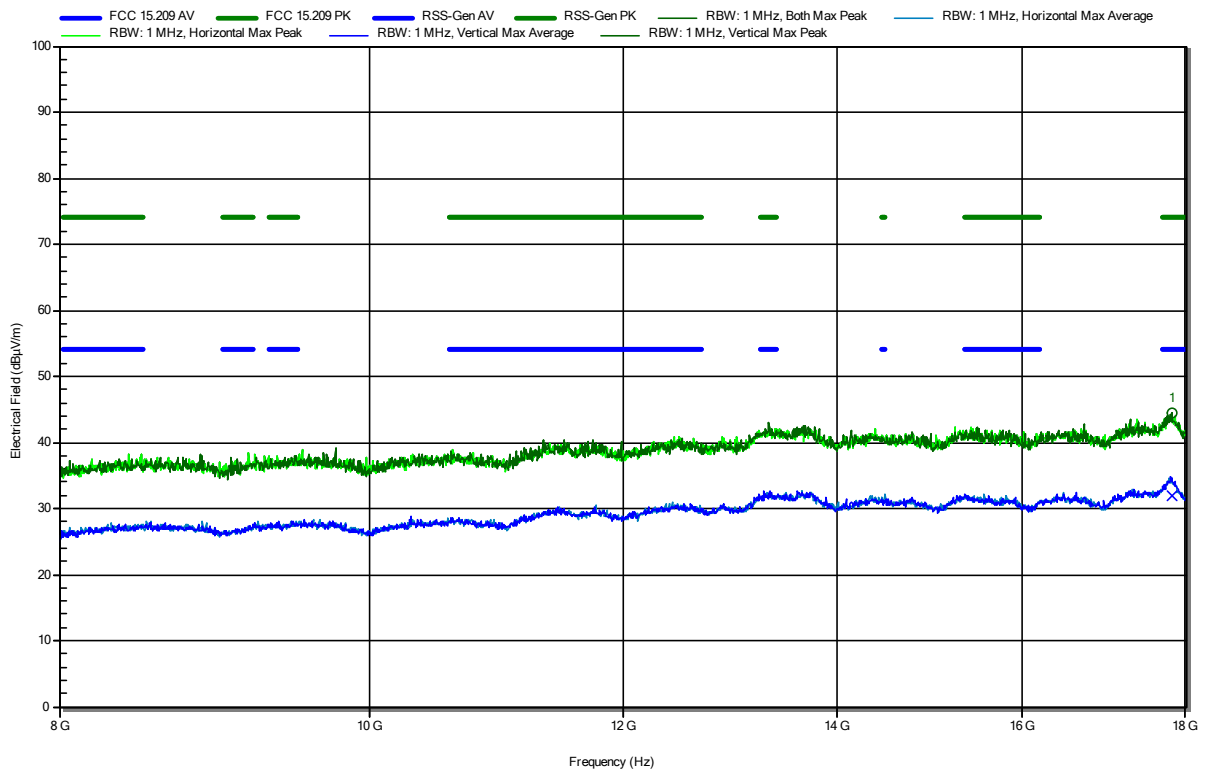

Frequency	Peak	Peak Limit	Peak Difference	Peak Status	Polarization
17.819 GHz	44.44 dBµV/m	74 dBµV/m	-29.56 dB	Pass	Vertical
Frequency	Average	Average Limit	Average Difference	Average Status	Polarization
17.819 GHz	32 dBµV/m	54 dBµV/m	-22 dB	Pass	Vertical

**Radiated Spurious Emissions according to 47 CFR Part 15.247**

Project Number: G0M-2009-9279  
 Applicant: Dräger Safety AG & Co. KGaA  
 Model Description: Fixed Gas Detector  
 Model: Polytron 6100 EC WL  
 Test Sample ID: 40425  
 Test Site: Eurofins Product Service GmbH  
 Operator: Mrs Hoang  
 Measurement software: RadiMation, version 2020.1.8  
 Test Conditions: Tnom: 24 °Celsius, Vnom: 14.4 VDC (Lithium battery)  
 Antenna: Amplifier Research AT4560  
 Measurement distance: 3 m  
 Mode: Tx; BLE 4.2; Ch 0; 1 Mbps  
 Test Date: 2022-06-24  
 Note:

Index 6

**RadiMation**

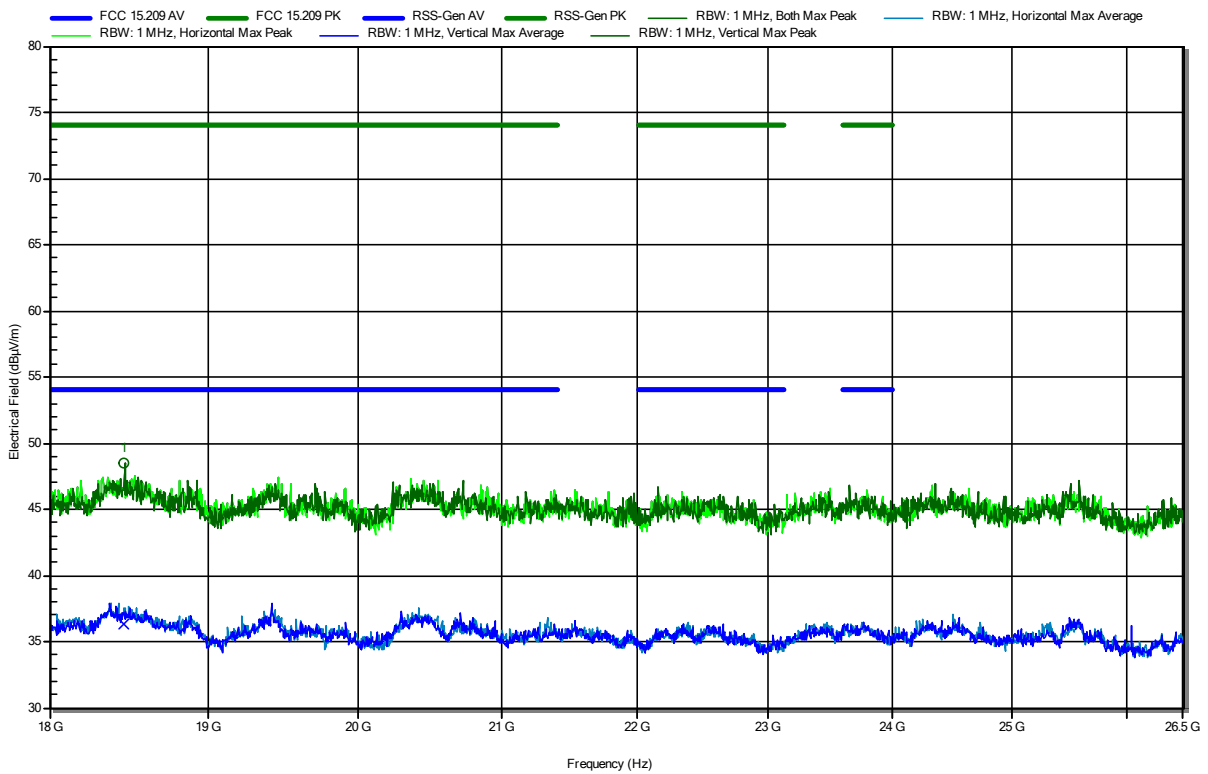

Frequency	Peak	Peak Limit	Peak Difference	Peak Status	Polarization
18.466 GHz	48.5 dBµV/m	74 dBµV/m	-25.5 dB	Pass	Vertical
Frequency	Average	Average Limit	Average Difference	Average Status	Polarization
18.466 GHz	36.3 dBµV/m	54 dBµV/m	-17.7 dB	Pass	Vertical

== = END OF TEST REPORT == =

Test Report No.: G0M-2009-9279-TFC247BL-V01

Eurofins Product Service GmbH  
 Storkower Str. 38c, D-15526 Reichenwalde, Germany