



FCC TEST REPORT

REPORT NO.: RF990111H01

MODEL NO.: 25x

RECEIVED: Jan. 11, 2010

TESTED: Jan. 18 to 20, 2010

ISSUED: May 11, 2010

APPLICANT: Edgewater Networks Inc.

ADDRESS: 2895 Northwestern Parkway, Santa Clara, CA
95051 USA

ISSUED BY: Bureau Veritas Consumer Products Services (H.K.)
Ltd., Taoyuan Branch Hsin Chu Laboratory

ADDRESS: No. 81-1, Lu Liao Keng, 9th Ling, Wu Lung Tsuen,
Chiung Lin Hsiang, Hsin Chu Hsien 307, Taiwan

This test report consists of 79 pages in total. It may be duplicated completely for legal use with the approval of the applicant. It should not be reproduced except in full, without the written approval of our laboratory. The client should not use it to claim product endorsement by TAF or any government agencies. The test results in the report only apply to the tested sample.





A D T

Table of Contents

1.	CERTIFICATION	4
2.	SUMMARY OF TEST RESULTS	5
2.1	MEASUREMENT UNCERTAINTY	6
3.	GENERAL INFORMATION	7
3.1	GENERAL DESCRIPTION OF EUT	7
3.2	DESCRIPTION OF TEST MODES	9
3.2.1	TEST MODE APPLICABILITY AND TESTED CHANNEL DETAIL	10
3.3	GENERAL DESCRIPTION OF APPLIED STANDARDS	13
3.4	DESCRIPTION OF SUPPORT UNITS.....	14
3.5	CONFIGURATION OF SYSTEM UNDER TEST	15
4.	TEST TYPES AND RESULTS	17
4.1	CONDUCTED EMISSION MEASUREMENT	17
4.1.1	LIMITS OF CONDUCTED EMISSION MEASUREMENT	17
4.1.2	TEST INSTRUMENTS.....	17
4.1.3	TEST PROCEDURES	18
4.1.4	DEVIATION FROM TEST STANDARD	18
4.1.5	TEST SETUP	19
4.1.6	EUT OPERATING CONDITIONS	19
4.1.7	TEST RESULTS	20
4.2	RADIATED EMISSION MEASUREMENT	22
4.2.1	LIMITS OF RADIATED EMISSION MEASUREMENT	22
4.2.2	TEST INSTRUMENTS.....	23
4.2.3	TEST PROCEDURES	25
4.2.4	DEVIATION FROM TEST STANDARD	25
4.2.5	TEST SETUP	26
4.2.6	EUT OPERATING CONDITIONS	26
4.2.7	TEST RESULTS	27
4.3	6dB BANDWIDTH MEASUREMENT	56
4.3.1	LIMITS OF 6dB BANDWIDTH MEASUREMENT	56
4.3.2	TEST INSTRUMENTS.....	56
4.3.3	TEST PROCEDURE.....	56
4.3.4	DEVIATION FROM TEST STANDARD	56
4.3.5	TEST SETUP	56
4.3.6	EUT OPERATING CONDITIONS	56
4.3.7	TEST RESULTS	57
4.4	MAXIMUM PEAK OUTPUT POWER.....	61
4.4.1	LIMITS OF MAXIMUM PEAK OUTPUT POWER MEASUREMENT	61
4.4.2	INSTRUMENTS.....	61
4.4.3	TEST PROCEDURES	61
4.4.4	DEVIATION FROM TEST STANDARD	61



A D T

4.4.5	TEST SETUP	61
4.4.6	EUT OPERATING CONDITIONS	61
4.4.7	TEST RESULTS	62
4.5	POWER SPECTRAL DENSITY MEASUREMENT	64
4.5.1	LIMITS OF POWER SPECTRAL DENSITY MEASUREMENT	64
4.5.2	TEST INSTRUMENTS.....	64
4.5.3	TEST PROCEDURE.....	64
4.5.4	DEVIATION FROM TEST STANDARD	64
4.5.5	TEST SETUP	64
4.5.6	EUT OPERATING CONDITION.....	64
4.5.7	TEST RESULTS	65
4.6	CONDUCTED OUT-BAND EMISSION MEASUREMENT	69
4.6.1	LIMITS OF CONDUCTED OUT-BAND EMISSION MEASUREMENT.....	69
4.6.2	TEST INSTRUMENTS.....	69
4.6.3	TEST PROCEDURE.....	69
4.6.4	DEVIATION FROM TEST STANDARD	69
4.6.5	EUT OPERATING CONDITION.....	69
4.6.6	TEST RESULTS	69
5.	INFORMATION ON THE TESTING LABORATORIES	78
6.	APPENDIX A - MODIFICATIONS RECORDERS FOR ENGINEERING CHANGES TO THE EUT BY THE LAB.....	79



1. CERTIFICATION

PRODUCT: Network Services Gateway
BRAND NAME: EdgeMarc
MODEL NO.: 25x
TEST SAMPLE: ENGINEERING SAMPLE
TESTED: Jan. 18 to 20, 2010
APPLICANT: Edgewater Networks Inc.
STANDARDS: FCC Part 15, Subpart C (Section 15.247),
ANSI C63.4-2003

The above equipment (Model: 250) has been tested by **Bureau Veritas Consumer Products Services (H.K.) Ltd., Taoyuan Branch**, and found compliance with the requirement of the above standards. The test record, data evaluation & Equipment Under Test (EUT) configurations represented herein are true and accurate accounts of the measurements of the sample's EMC characteristics under the conditions specified in this report.

PREPARED BY :  , **DATE:** May 11, 2010
(Claire Kuan, Specialist)

TECHNICAL ACCEPTANCE :  , **DATE:** May 11, 2010
(Hank Chung, Deputy Manager)

APPROVED BY :  , **DATE:** May 11, 2010
(May Chen, Deputy Manager)

2. SUMMARY OF TEST RESULTS

The EUT has been tested according to the following specifications:

For 802.11b & g, 2412~2462MHz Band

APPLIED STANDARD: FCC Part 15, Subpart C (Section 15.247)			
Standard Section	Test Type and Limit	Result	Remark
15.207	AC Power Conducted Emission	PASS	Meet the requirement of limit. Minimum passing margin is -4.09dB at 0.599MHz
15.247(a)(2)	Spectrum Bandwidth of a Direct Sequence Spread Spectrum System Limit: min. 500kHz	PASS	Meet the requirement of limit.
15.247(b)	Maximum Peak Output Power Limit: max. 30dBm	PASS	Meet the requirement of limit.
15.247(d)	Radiated Emissions Limit: Table 15.209	PASS	Meet the requirement of limit. Minimum passing margin is -0.7dB at 2483.5MHz
15.247(e)	Power Spectral Density Limit: max. 8dBm	PASS	Meet the requirement of limit.
15.247(d)	Conducted Out-Band Emission Measurement Limit: 20dB less than the peak value of fundamental frequency	PASS	Meet the requirement of limit.
15.203	Antenna Requirement	PASS	Antenna connector is U.L. not a standard connector.



A D T

2.1 MEASUREMENT UNCERTAINTY

Where relevant, the following measurement uncertainty levels have been estimated for tests performed on the EUT as specified in CISPR 16-4-2:

This uncertainty represents an expanded uncertainty expressed at approximately the 95% confidence level using a coverage factor of $k=2$.

Measurement	Value
Conducted emissions	2.45 dB
Radiated emissions (30MHz-1GHz)	4 dB
Radiated emissions (1GHz-18GHz)	2.49 dB
Radiated emissions (18GHz-40GHz)	2.70 dB



A D T

3. GENERAL INFORMATION

3.1 GENERAL DESCRIPTION OF EUT

PRODUCT	Network Services Gateway
MODEL NO.	25x
FCC ID	X6G250
POWER SUPPLY	DC 12V from power adapter
MODULATION TYPE	CCK, DQPSK, DBPSK for DSSS 64QAM, 16QAM, QPSK, BPSK for OFDM
MODULATION TECHNOLOGY	DSSS, OFDM
TRANSFER RATE	802.11b: 11 / 5.5 / 2 / 1Mbps 802.11g: 54 / 48 / 36 / 24 / 18 / 12 / 9 / 6Mbps 802.11n (20MHz, 800ns GI): 65 / 58.5 / 52 / 39 / 26 / 19.5 / 13 / 6.5Mbps 802.11n (40MHz, 800ns GI): 135 / 121.5 / 108 / 81 / 54 / 40.5 / 27 / 13.5Mbps
OPRTAING FREQUENCY	2412 ~ 2462MHz
NUMBER OF CHANNEL	11 for 802.11b, 802.11g, 802.11n (20MHz) 7 for 802.11n (40MHz)
MAXIMUM OUTPUT POWER	802.11b: 138.0mW 802.11g: 288.4mW 802.11n (20MHz): 516.3mW 802.11n (40MHz): 413.3mW
ANTENNA TYPE	Dipole antenna with 2 dBi antenna gain
ANTENNA CONNECTOR	U.L connector
DATA CABLE	NA
I/O PORTS	Ethernet LAN port x 8, Ethernet WAN port x 1, DSL/Line port x 1, Phone port x 4, USB port x 1 (Only For Storage device)
ASSOCIATED DEVICES	Adapter x 1

NOTE:

1. The "X" in the model: 25x could be defined as 0~9 for marketing differentiation. For the final test, model: 250 was selected as the representative model for the test and its data is recorded in this report.



A D T

2. There are two antennas provided to this EUT, please refer to the following table:

Transmitter Circuit	Antenna Type	Antenna Gain (dBi)	Antenna Connector	Cable Lenth
Chain(0)	Dipole	2	U.FL	110mm
Chain(1)				390mm

3. The EUT must be supplied with a power adapter as following information:

Brand:	TRUMP WAY
Model No.:	ZWS036AP1200300
Input power :	AC 100-240V, 1A, 50/60Hz AC input cable (Unshielded, 1.4m)
Output power :	DC 12V, 3A DC output cable (Unshielded, 1m with one core)

4. The EUT incorporates a MIMO function with 802.11g and 802.11n. Physically, the EUT provides two completed transmitters and two completed receivers.
5. The EUT is 2 * 2 spatial MIMO without beam forming function. The antenna configuration is two transmitter antennas and two receiver antennas, as there are 2 Dipole antennas. Spatial multiplexing modes for simultaneous transmission using 2 antennas, and for simultaneous receiver using 2 antennas. The 11b/g legacy mode is limited to single transmitter only.
6. When the EUT operating in 802.11n, the software operation, which is defined by manufacturer, MCS (Modulation and Coding Schemes) from 0 to 15.
7. The EUT complies with 802.11n standards and backwards compatible with 802.11b, 802.11g products.
8. The above EUT information was declared by manufacturer and for more detailed feature descriptions, please refer to the manufacturer's specifications or user's manual.

3.2 DESCRIPTION OF TEST MODES

Operated in 2400 ~ 2483.5MHz band:

Eleven channels are provided for 802.11b, 802.11g, 802.11n (20MHz):

CHANNEL	FREQUENCY	CHANNEL	FREQUENCY
1	2412MHz	7	2442MHz
2	2417MHz	8	2447MHz
3	2422MHz	9	2452MHz
4	2427MHz	10	2457MHz
5	2432MHz	11	2462MHz
6	2437MHz		

Seven channels are provided for 802.11n (40MHz):

CHANNEL	FREQUENCY	CHANNEL	FREQUENCY
1	2422MHz	5	2442MHz
2	2427MHz	6	2447MHz
3	2432MHz	7	2452MHz
4	2437MHz		



A D T

3.2.1 TEST MODE APPLICABILITY AND TESTED CHANNEL DETAIL

EUT CONFIGURE MODE	APPLICABLE TO				DESCRIPTION
	PLC	RE < 1G	RE ≥ 1G	APCM	
-	√	√	√	√	-

Where PLC: Power Line Conducted Emission

RE < 1G: Radiated Emission below 1GHz

RE ≥ 1G: Radiated Emission above 1GHz

APCM: Antenna Port Conducted Measurement

ANTENNA COMBINATION MODE:

COMBINATION MODE	OPERATION MODE	TX CHAIN(0)	TX CHAIN(1)
A	802.11b	√	
B	802.11b		√
C	802.11g	√	
D	802.11g		√
E	802.11n(20MHz) for MCS 0~7	√	
F	802.11n(20MHz) for MCS 8~15	√	√
G	802.11n(40MHz) for MCS 0~7	√	
H	802.11n(40MHz) for MCS 8~15	√	√

Note:

- The above information was declared by manufacturer and for more detailed features description, please refer to the manufacturer's specifications or user's manual.
- Antenna 1 and Antenna 2 are Dipole antennas.

POWER LINE CONDUCTED EMISSION TEST:

- Pre-Scan has been conducted to determine the worst-case mode from all possible combinations between available modulations, data rates and antenna ports (if EUT with antenna diversity architecture).
- Following channel(s) was (were) selected for the final test as listed below.

MODE	AVAILABLE CHANNEL	TESTED CHANNEL	MODULATION TECHNOLOGY	MODULATION TYPE	DATA RATE (Mbps)	EUT CONFIGURE MODE
802.11n (20MHz)	1 to 11	1	OFDM	BPSK	13	A

RADIATED EMISSION TEST (BELOW 1 GHz):

- Pre-Scan has been conducted to determine the worst-case mode from all possible combinations between available modulations, data rates and antenna ports (if EUT with antenna diversity architecture).
- Following channel(s) was (were) selected for the final test as listed below.

MODE	AVAILABLE CHANNEL	TESTED CHANNEL	MODULATION TECHNOLOGY	MODULATION TYPE	DATA RATE (Mbps)	EUT CONFIGURE MODE
802.11n (20MHz)	1 to 11	1	OFDM	BPSK	13	A

RADIATED EMISSION TEST (ABOVE 1 GHz):

- Pre-Scan has been conducted to determine the worst-case mode from all possible combinations between available modulations, data rates and antenna ports (if EUT with antenna diversity architecture).
- Following channel(s) was (were) selected for the final test as listed below.

MODE	AVAILABLE CHANNEL	TESTED CHANNEL	MODULATION TECHNOLOGY	MODULATION TYPE	DATA RATE (Mbps)	EUT CONFIGURE MODE
802.11b	1 to 11	1, 6, 11	DSSS	DBPSK	1	A
802.11g	1 to 11	1, 6, 11	OFDM	BPSK	6	C
802.11n (20MHz)	1 to 11	1, 6, 11	OFDM	BPSK	13	F
802.11n (40MHz)	1 to 7	1, 4, 7	OFDM	BPSK	27	H

CONDUCTED OUT-BAND EMISSION MEASUREMENT:

- Pre-Scan has been conducted to determine the worst-case mode from all possible combinations between available modulations, data rates and antenna ports (if EUT with antenna diversity architecture).
- Following channel(s) was (were) selected for the final test as listed below.

MODE	AVAILABLE CHANNEL	TESTED CHANNEL	MODULATION TECHNOLOGY	MODULATION TYPE	DATA RATE (Mbps)	EUT CONFIGURE MODE
802.11b	1 to 11	1, 6, 11	DSSS	DBPSK	1	A
802.11g	1 to 11	1, 6, 11	OFDM	BPSK	6	C
802.11n (20MHz)	1 to 11	1, 6, 11	OFDM	BPSK	13	F
802.11n (40MHz)	1 to 7	1, 4, 7	OFDM	BPSK	27	H

※ After verification, conducted out band emission as show worst chain in report by investigations.



A D T

ANTENNA PORT CONDUCTED MEASUREMENT:

- This item includes all test value of each mode, but only includes spectrum plot of worst value of each mode.
- Pre-Scan has been conducted to determine the worst-case mode from all possible combinations between available modulations, data rates and antenna ports (if EUT with antenna diversity architecture).
- Following channel(s) was (were) selected for the final test as listed below.

MODE	AVAILABLE CHANNEL	TESTED CHANNEL	MODULATION TECHNOLOGY	MODULATION TYPE	DATA RATE (Mbps)	EUT CONFIGURE MODE
802.11b	1 to 11	1, 6, 11	DSSS	DBPSK	1	A
802.11g	1 to 11	1, 6, 11	OFDM	BPSK	6	C
802.11n (20MHz)	1 to 11	1, 6, 11	OFDM	BPSK	13	F
802.11n (40MHz)	1 to 7	1, 4, 7	OFDM	BPSK	27	H

※ After verification, bandwidth as show worst chain in report by investigations.

TEST CONDITION:

APPLICABLE TO	ENVIRONMENTAL CONDITIONS	INPUT POWER	TESTED BY
RE ³ 1G	15deg. C, 66%RH, 1024 hPa	120Vac, 60Hz	Kent Liu
RE<1G	22deg. C, 78%RH, 1024 hPa	120Vac, 60Hz	Eagle Chen
PLC	24deg. C, 63%RH, 1021 hPa	120Vac, 60Hz	Leo Peng
APCM	20deg. C, 60%RH, 1024 hPa	120Vac, 60Hz	Duke Tseng

3.3 GENERAL DESCRIPTION OF APPLIED STANDARDS

The EUT is a Network Services Gateway. According to the specifications of the manufacturer, it must comply with the requirements of the following standards:

FCC Part 15, Subpart C. (15.247)

ANSI C63.4-2003

All test items have been performed and recorded as per the above standards.

NOTE: The EUT is also considered as a kind of computer peripheral, because the connection to computer is necessary for typical use. It has been verified to comply with the requirements of FCC Part 15, Subpart B, Class B (DoC). The test report has been issued separately.



A D T

3.4 DESCRIPTION OF SUPPORT UNITS

The EUT has been tested as an independent unit together with other necessary accessories or support units. The following support units or accessories were used to form a representative test configuration during the tests.

NO.	PRODUCT	BRAND	MODEL NO.	SERIAL NO.	FCC ID
1	NOTEBOOK COMPUTER	DELL	PP18L	6976685584	FCC DoC
2	NOTEBOOK COMPUTER	DELL	PP19L	CN-OHC416-701 66-5CA-0448	PIW63250051661 0
3	NOTEBOOK COMPUTER (For conducted test)	DELL	D531	CN-0XM006-4864 3-86L-4472	QDS-BRCM1019
4	HUB	ZyXEL	ES-116P	S060H02000215	FCC DoC
5	CO-ROUTER	ZyXEL	IES-1000	S08024701597	FCC DoC
6	TELEPHONE	ROMEO	TE-812	97285638	N/A
7	TELEPHONE	ROMEO	TE-812	97280903	N/A
8	TELEPHONE	ROMEO(For radiated)	TE-812	97280926	N/A
	TELEPHONE	HTT(For conducted)	HTT-806	9545065	FCC DoC
9	TELEPHONE	DAISHO(For radiated)	DS-03	N/A	N/A
	TELEPHONE	HTT(For conducted)	HTT-806	9543663	FCC DoC
10	USB Flash Driver	SanDisk	SDCZ2-5 12-A10	5496755355	FCC DoC

NO.	SIGNAL CABLE DESCRIPTION OF THE ABOVE SUPPORT UNITS
1	UTP Cable (10m)
2	UTP Cable (10m)
3	NA
4	UTP Cable (10m)
5	TEL line (10m)
6	TEL line (1m)
7	TEL line (1m)
8	TEL line (1m)
9	TEL line (1m)
10	NA

NOTE: All power cords of the above support units are non shielded (1.8m).

3.5 CONFIGURATION OF SYSTEM UNDER TEST

For conducted test:

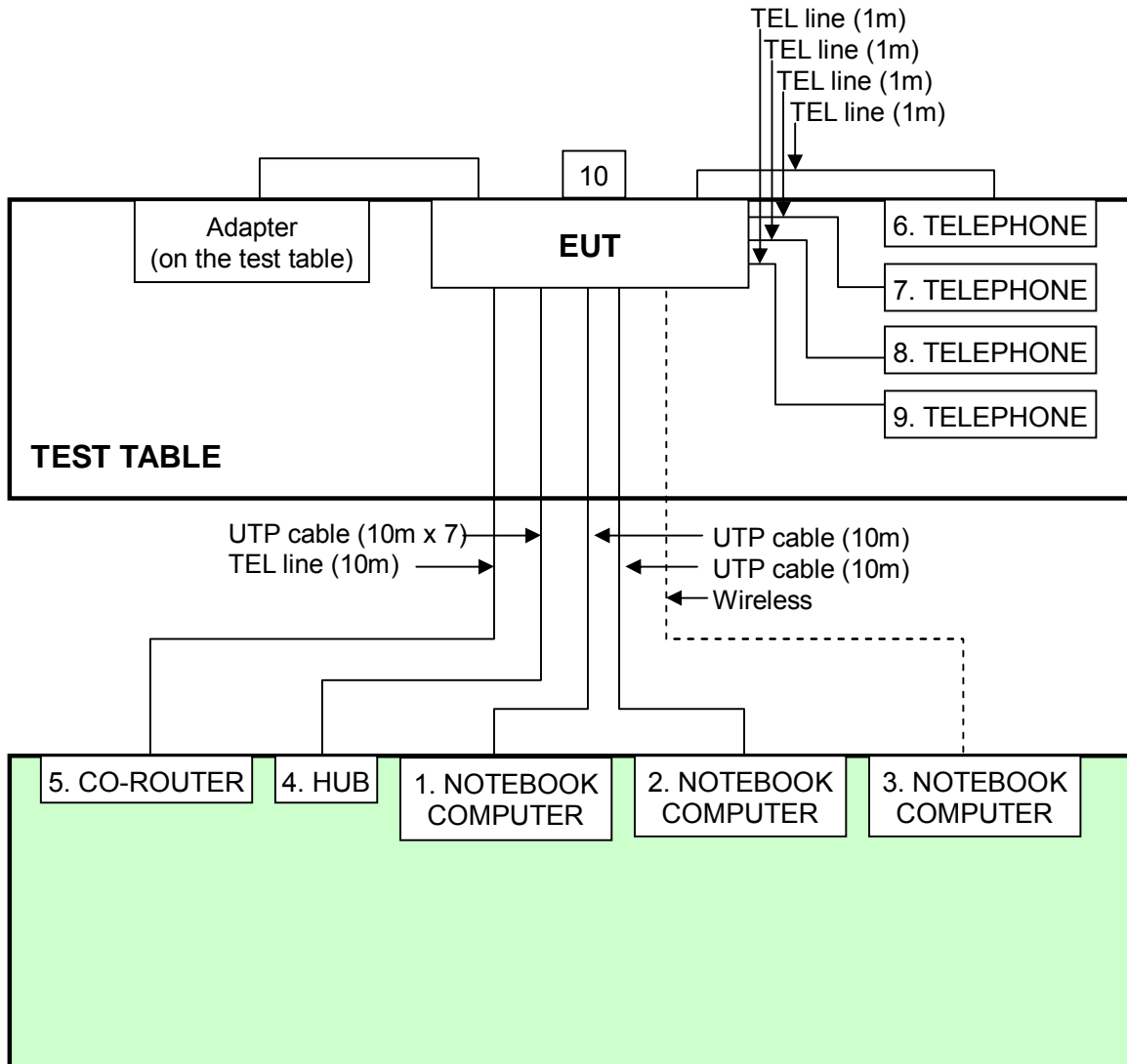

Note: Item 10 is USB Flash Driver (load).

For other test:

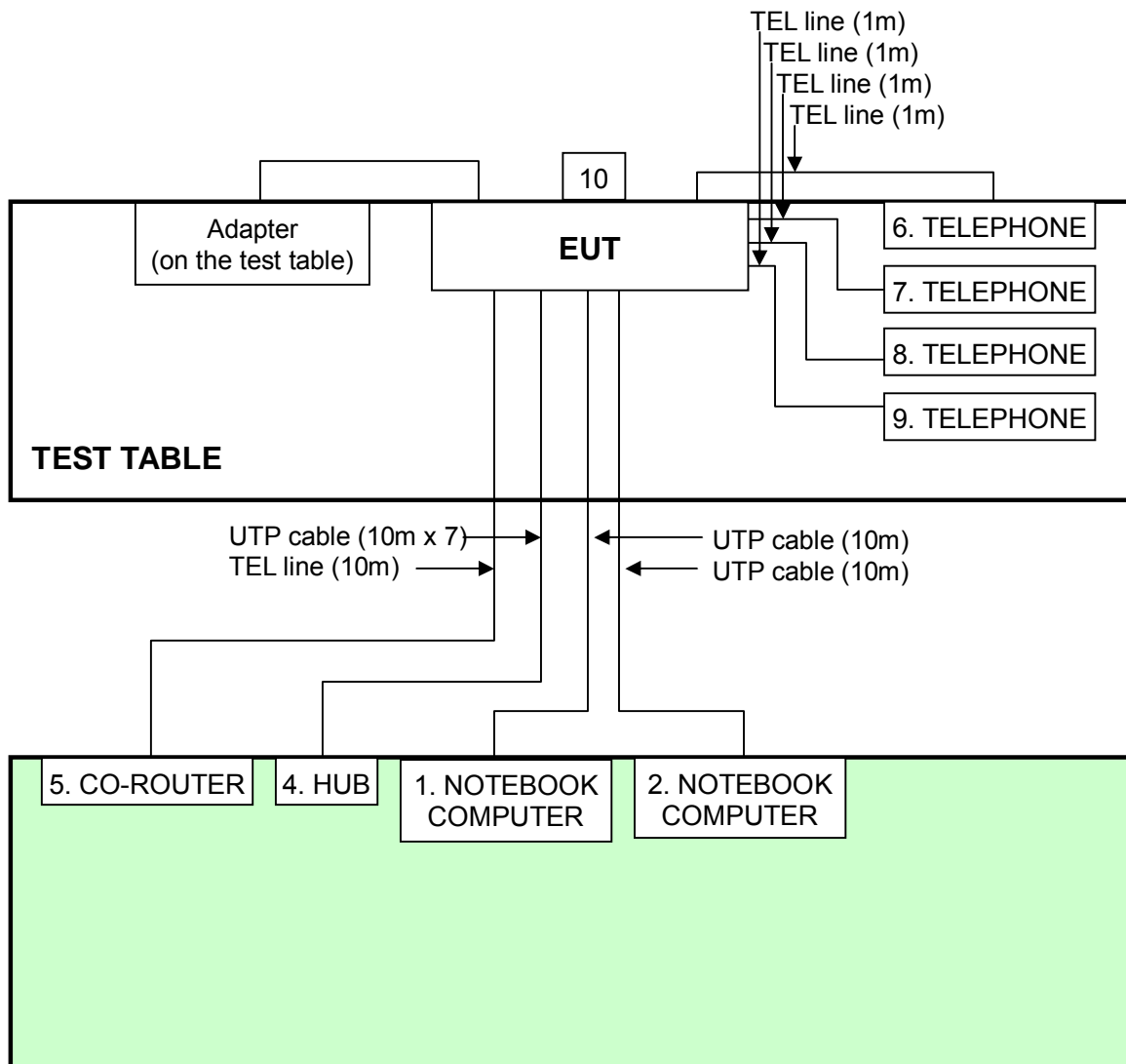

Note: Item 10 is USB Flash Driver (load).

4. TEST TYPES AND RESULTS

4.1 CONDUCTED EMISSION MEASUREMENT

4.1.1 LIMITS OF CONDUCTED EMISSION MEASUREMENT

FREQUENCY OF EMISSION (MHz)	CONDUCTED LIMIT (dB μ V)	
0.15-0.5	Quasi-peak	Average
0.5-5	66 to 56	56 to 46
5-30	56	46
	60	50

- NOTE:**
1. The lower limit shall apply at the transition frequencies.
 2. The limit decreases in line with the logarithm of the frequency in the range of 0.15 to 0.50 MHz.
 3. All emanations from a class A/B digital device or system, including any network of conductors and apparatus connected thereto, shall not exceed the level of field strengths specified above.

4.1.2 TEST INSTRUMENTS

DESCRIPTION & MANUFACTURER	MODEL NO.	SERIAL NO.	CALIBRATED DATE	CALIBRATED UNTIL
ROHDE & SCHWARZ Test Receiver	ESCS 30	100287	Mar. 05, 2009	Mar. 04, 2010
Line-Impedance Stabilization Network (for EUT)	NSLK 8127	8127-523	Sep 23, 2009	Sep 22, 2010
Line-Impedance Stabilization Network (for Peripheral)	KNW-407	8-1395-12	May 04, 2009	May 03, 2010
RF Cable (JYBAO)	5DFB	COACAB-001	Dec 14, 2009	Dec 13, 2010
50 ohms Terminator	50	3	Oct. 28, 2009	Oct. 27, 2010
Software	BV ADT_Cond_V7.3.7	NA	NA	NA

Note:

1. The calibration interval of the above test instruments is 12 months and the calibrations are traceable to NML/ROC and NIST/USA.
2. The test was performed in Shielded Room No. A.
3. The VCCI Con A Registration No. is C-817.

4.1.3 TEST PROCEDURES

- a. The EUT was placed 0.4 meters from the conducting wall of the shielded room with EUT being connected to the power mains through a line impedance stabilization network (LISN). Other support units were connected to the power mains through another LISN. The two LISNs provide 50 ohm/ 50uH of coupling impedance for the measuring instrument.
- b. Both lines of the power mains connected to the EUT were checked for maximum conducted interference.
- c. The frequency range from W241kHz to 30MHz was searched. Emission levels under (Limit - 20dB) were not recorded.

4.1.4 DEVIATION FROM TEST STANDARD

No deviation

4.1.5 TEST SETUP

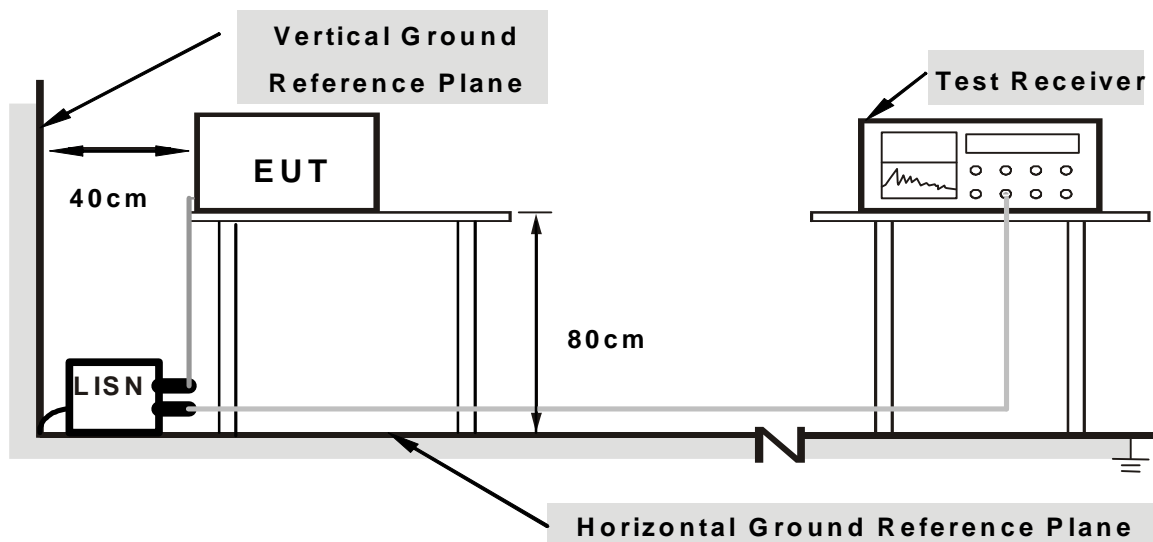

Note: 1. Support units were connected to second LISN.

2. Both of LISNs (AMN) are 80 cm from EUT and at least 80 from other units and other metal planes

For the actual test configuration, please refer to the related item – Photographs of the Test Configuration.

4.1.6 EUT OPERATING CONDITIONS

1. Placed the EUT on testing table.
2. Prepared other computer systems (support units 1 ~ 5) to act as communication partners and placed them outside of testing area.
3. The communication partners run test program “Telnet 192.168.1.1 and Ping.exe” to enable EUT under transmission/receiving condition continuously at specific channel frequency via UTP cables, TEL line and wireless.
4. Support unit 6~7 (Telephone) are call to each other via EUT.
5. Support unit 8~9 (Telephone) are call to each other via EUT.

4.1.7 TEST RESULTS

802.11n (20MHz) OFDM MODULATION:

PHASE	Line (L)	6dB BANDWIDTH	9 kHz
-------	----------	---------------	-------

No	Freq. [MHz]	Corr. Factor (dB)	Reading Value		Emission Level		Limit		Margin	
			[dB (uV)]		[dB (uV)]		[dB (uV)]		(dB)	
			Q.P.	AV.	Q.P.	AV.	Q.P.	AV.	Q.P.	AV.
1	0.197	0.04	51.93	-	51.97	-	63.74	53.74	-11.77	-
2	0.384	0.06	47.16	-	47.22	-	58.18	48.18	-10.97	-
3	0.478	0.06	50.27	42.05	50.33	42.11	56.37	46.37	-6.04	-4.26
4	0.599	0.07	51.36	41.84	51.43	41.91	56.00	46.00	-4.57	-4.09
5	0.693	0.07	49.13	38.68	49.20	38.75	56.00	46.00	-6.80	-7.25
6	0.853	0.08	45.16	-	45.24	-	56.00	46.00	-10.76	-
7	1.250	0.10	45.83	-	45.93	-	56.00	46.00	-10.07	-
8	1.391	0.10	46.55	34.61	46.65	34.71	56.00	46.00	-9.35	-11.29
9	1.734	0.11	49.26	37.48	49.37	37.59	56.00	46.00	-6.63	-8.41
10	2.590	0.14	44.94	-	45.08	-	56.00	46.00	-10.92	-
11	2.813	0.15	45.12	-	45.27	-	56.00	46.00	-10.73	-
12	26.449	0.75	41.42	-	42.17	-	60.00	50.00	-17.83	-

- REMARKS:**
1. Q.P. and AV. are abbreviations of quasi-peak and average individually.
 2. "-": The Quasi-peak reading value also meets average limit and measurement with the average detector is unnecessary.
 3. The emission levels of other frequencies were very low against the limit.
 4. Margin value = Emission level - Limit value
 5. Correction factor = Insertion loss + Cable loss
 6. Emission Level = Correction Factor + Reading Value.

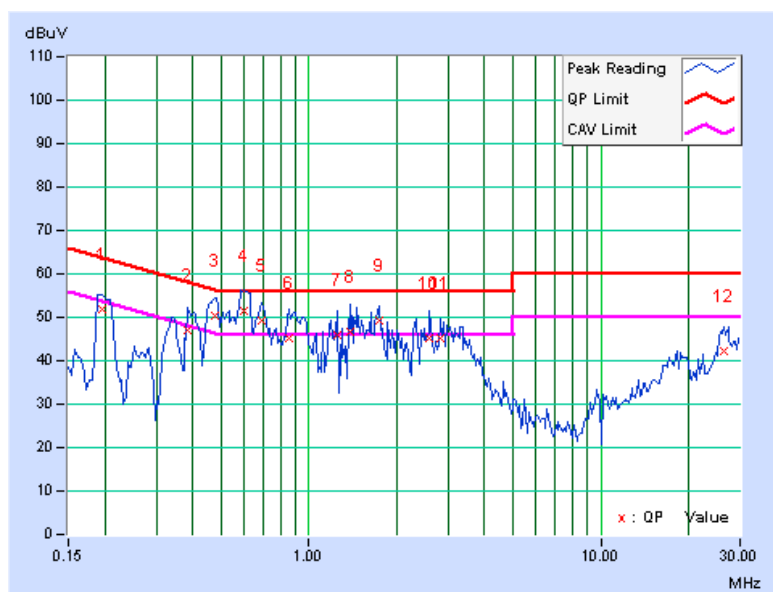

PHASE	Neutral (N)	6dB BANDWIDTH	9 kHz
--------------	-------------	----------------------	-------

No	Freq. [MHz]	Corr. Factor (dB)	Reading Value [dB (uV)]		Emission Level [dB (uV)]		Limit [dB (uV)]		Margin (dB)	
			Q.P.	AV.	Q.P.	AV.	Q.P.	AV.	Q.P.	AV.
			1	0.388	0.07	47.55	-	47.62	-	58.11
2	0.486	0.07	50.25	41.24	50.32	41.31	56.24	46.24	-5.91	-4.92
3	0.627	0.08	51.35	41.38	51.43	41.46	56.00	46.00	-4.57	-4.54
4	0.697	0.08	48.97	37.45	49.05	37.53	56.00	46.00	-6.95	-8.47
5	0.908	0.10	47.08	35.60	47.18	35.70	56.00	46.00	-8.82	-10.30
6	1.160	0.10	45.15	-	45.25	-	56.00	46.00	-10.75	-
7	1.430	0.11	47.44	35.43	47.55	35.54	56.00	46.00	-8.45	-10.46
8	1.730	0.12	48.18	36.34	48.30	36.46	56.00	46.00	-7.70	-9.54
9	2.602	0.16	44.45	-	44.61	-	56.00	46.00	-11.39	-

- REMARKS:**
1. Q.P. and AV. are abbreviations of quasi-peak and average individually.
 2. "-": The Quasi-peak reading value also meets average limit and measurement with the average detector is unnecessary.
 3. The emission levels of other frequencies were very low against the limit.
 4. Margin value = Emission level - Limit value
 5. Correction factor = Insertion loss + Cable loss
 6. Emission Level = Correction Factor + Reading Value.

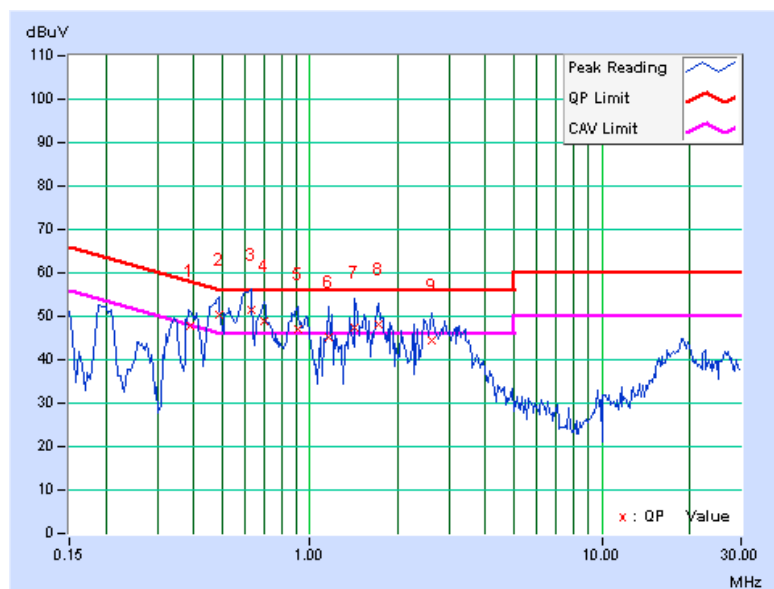

4.2 RADIATED EMISSION MEASUREMENT

4.2.1 LIMITS OF RADIATED EMISSION MEASUREMENT

Emissions radiated outside of the specified bands, shall be according to the general radiated limits in 15.209 as following:

Frequencies (MHz)	Field strength (microvolts/meter)	Measurement distance (meters)
0.009-0.490	2400/F(kHz)	300
0.490-1.705	24000/F(kHz)	30
1.705-30.0	30	30
30-88	100	3
88-216	W241	3
216-960	200	3
Above 960	500	3

NOTE:

1. The lower limit shall apply at the transition frequencies.
2. Emission level (dBuV/m) = 20 log Emission level (uV/m).
3. As shown in 15.35(b), for frequencies above 1000MHz, the field strength limits are based on average detector, however, the peak field strength of any emission shall not exceed the maximum permitted average limits, specified above by more than 20dB under any condition of modulation.



A D T

4.2.2 TEST INSTRUMENTS

Below 1GHz test

DESCRIPTION & MANUFACTURER	MODEL NO.	SERIAL NO.	CALIBRATED DATE	CALIBRATED UNTIL
ADVANTEST Spectrum Analyzer	U3751	160200410	July. 17, 2009	July. 16, 2010
ADVANTEST Spectrum Analyzer	U3772	160100280	Sep. 21, 2009	Sep. 20, 2010
HP Pre_Amplifier	8449B	3008A01922	Sep. 25, 2009	Sep. 24, 2010
ROHDE & SCHWARZ Test Receiver	ESVS 30	841977/002	Nov. 02, 2009	Nov. 01, 2010
SCHAFFNER(CHASE) Broadband Antenna	CBL6112B	2798	April 29, 2009	April 28, 2010
Schwarzbeck Horn_Antenna	BBHA9120-D1	D123	Sep. 21, 2009	Sep. 20, 2010
Schwarzbeck Horn_Antenna	BBHA 9170	BBHA9170153	Jan. 23, 2009	Jan. 22, 2010
RF Switches	MP59B	6100175593	Sep. 01, 2009	Aug. 31, 2010
RF Cable	8DFB	STBCAB-001	Sep. 01, 2009	Aug. 31, 2010
Software	ADT_Radiated_V7.6.15.9.2	NA	NA	NA
CT Antenna Tower & Turn Table	NA	NA	NA	NA
CORCOM AC Filter	MRI2030	024/019	NA	NA

Note: 1. The calibration interval of the above test instruments is 12 months and the calibrations are traceable to NML/ROC and NIST/USA.

2. The horn antenna, HP preamplifier (model: 8449B) and Spectrum Analyzer (model: U3772) are used only for the measurement of emission frequency above 1GHz if tested.
3. The test was performed in Open Site No. B.
4. The VCCI Site Registration No. is R-847.
5. The FCC Site Registration No. is 92753.
6. The CANADA Site Registration No. is IC 7450G-2.



A D T

Above 1GHz test

DESCRIPTION & MANUFACTURER	MODEL NO.	SERIAL NO.	CALIBRATED DATE	CALIBRATED UNTIL
ROHDE & SCHWARZ Spectrum Analyzer	FSP40	100036	Dec. 18, 2009	Dec. 17, 2010
Agilent PSA Spectrum Analyzer	E4446A	MY46180622	Apr. 24 , 2009	Apr. 23 , 2010
HP Pre_Amplifier	8449B	300801923	Nov. 02, 2009	Nov. 01, 2010
ROHDE & SCHWARZ Test Receiver	ESCS30	847124/029	Aug. 28, 2009	Aug. 27, 2010
SCHWARZBECK TRILOG Broadband Antenna	VULB 9168	138	April 29, 2009	April 28, 2010
Schwarzbeck Horn_Antenna	BBHA9120	D124	Dec. 18, 2009	Dec. 17, 2010
Schwarzbeck Horn_Antenna	BBHA 9170	BBHA9170153	Jan. 22, 2009	Jan. 21, 2010
R&S Loop Antenna	HFH2-Z2	100070	Jan. 13, 2010	Jan. 12, 2011
RF Switches	EMH-011	1001	NA	NA
RF CABLE (Chaintek)	Sucoflex 106	28077	Aug. 14, 2009	Aug. 13, 2010
RF Cable	8DFB	STCCAB-30M-1GHz	NA	NA
Software	ADT_Radiated_V7.6.15.9.2	NA	NA	NA
CT Antenna Tower & Turn Table	NA	NA	NA	NA

- Note: 1. The calibration interval of the above test instruments is 12 months and the calibrations are traceable to NML/ROC and NIST/USA.
2. The horn antenna, HP preamplifier (model: 8449B) and Spectrum Analyzer (model: FSP40) are used only for the measurement of emission frequency above 1GHz if tested.
3. The test was performed in Open Site No. C.
4. The FCC Site Registration No. is 656396.
5. The VCCI Site Registration No. is R-1626.
6. The CANADA Site Registration No. is IC 7450G-3.



A D T

4.2.3 TEST PROCEDURES

- a. The EUT was placed on the top of a rotating table 0.8 meters above the ground at a 10 meter open area test site. The table was rotated 360 degrees to determine the position of the highest radiation.
- b. The EUT was set 3 meters away from the interference-receiving antenna, which was mounted on the top of a variable-height antenna tower.
- c. The antenna is a broadband antenna, and its height is varied from one meter to four meters above the ground to determine the maximum value of the field strength. Both horizontal and vertical polarizations of the antenna are set to make the measurement.
- d. For each suspected emission, the EUT was arranged to its worst case and then the antenna was tuned to heights from 1 meter to 4 meters and the rotatable table was turned from 0 degrees to 360 degrees to find the maximum reading.
- e. The test-receiver system was set to Peak Detect Function and Specified Bandwidth with Maximum Hold Mode.
- f. If the emission level of the EUT in peak mode was 10dB lower than the limit specified, then testing could be stopped and the peak values of the EUT would be reported. Otherwise the emissions that did not have 10dB margin would be re-tested one by one using peak, quasi-peak or average method as specified and then reported in a data sheet.

NOTE:

1. The resolution bandwidth and video bandwidth of test receiver/spectrum analyzer is 120kHz for Peak detection (PK) and Quasi-peak detection (QP) at frequency below 1GHz.
2. The resolution bandwidth of test receiver/spectrum analyzer is 1 MHz and the video bandwidth is 3 MHz for Peak detection (PK) at frequency above 1GHz.
3. The resolution bandwidth of test receiver/spectrum analyzer is 1 MHz and the video bandwidth is 10 Hz for Average detection (AV) at frequency above 1GHz.

4.2.4 DEVIATION FROM TEST STANDARD

No deviation

4.2.5 TEST SETUP

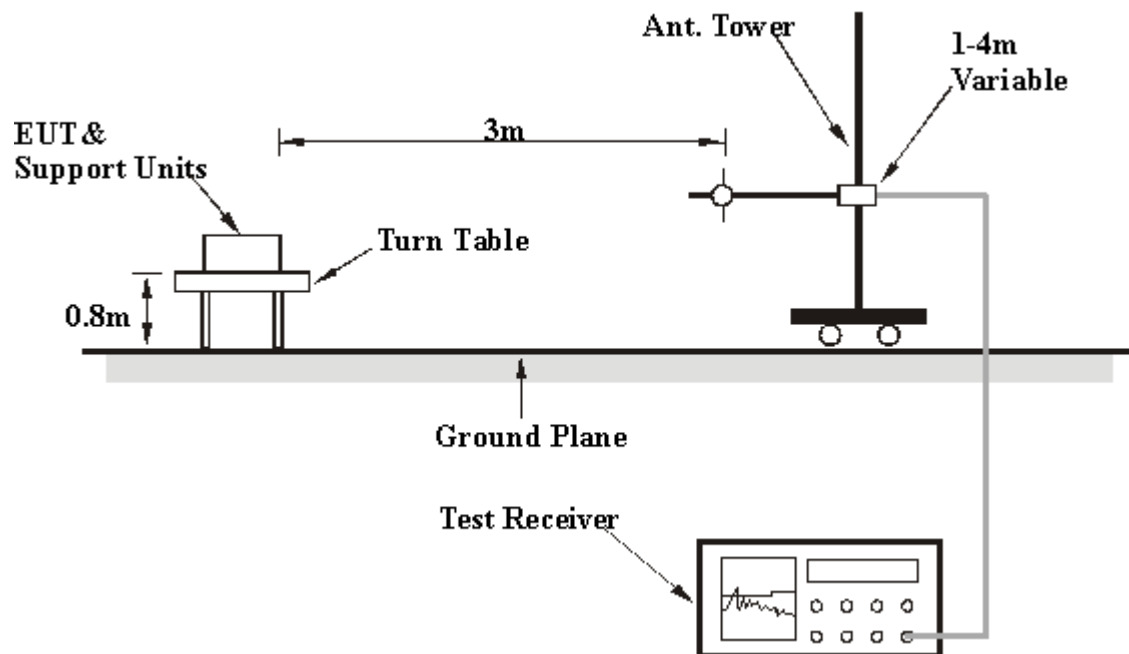

For the actual test configuration, please refer to the related item – Photographs of the Test Configuration.

4.2.6 EUT OPERATING CONDITIONS

1. Placed the EUT on testing table.
2. Prepared other computer systems (support units 1 ~ 5) to act as communication partners and placed them outside of testing area.
3. The communication partners run test program “Telnet 192.168.1.1 and Ping.exe” to enable EUT under transmission/receiving condition continuously at specific channel frequency via UTP cables and TEL line.
4. Support unit 6~7 (Telephone) are call to each other via EUT.
5. Support unit 8~9 (Telephone) are call to each other via EUT.



A D T

4.2.7 TEST RESULTS

BELOW 1GHz WORST-CASE DATA : 802.11n (20MHz) OFDM MODULATION

EUT TEST CONDITION		MEASUREMENT DETAIL	
CHANNEL	Channel 1	FREQUENCY RANGE	Below 1000MHz
INPUT POWER (SYSTEM)	120Vac, 60Hz	DETECTOR FUNCTION	Quasi-Peak
ENVIRONMENTAL CONDITIONS	22deg. C, 78RH 1021 hPa	TESTED BY	Eagle Chen

ANTENNA POLARITY & TEST DISTANCE: HORIZONTAL AT 3 M								
NO.	FREQ. (MHz)	EMISSION LEVEL (dBuV/m)	LIMIT (dBuV/m)	MARGIN (dB)	ANTENNA HEIGHT (m)	TABLE ANGLE (Degree)	RAW VALUE (dBuV)	CORRECTION FACTOR (dB/m)
1	225.00	34.8 QP	46.00	-11.2	3.16 H	248	22.27	12.53
2	250.00	36.7 QP	46.00	-9.3	2.55 H	38	22.72	14.00
3	459.23	35.5 QP	46.00	-10.5	2.47 H	316	15.99	19.50
4	499.99	35.7 QP	46.00	-10.3	1.36 H	129	15.31	20.36
5	533.32	34.5 QP	46.00	-11.5	2.63 H	249	13.67	20.83
6	799.94	36.5 QP	46.00	-9.5	2.20 H	349	12.84	23.69
7	892.91	36.7 QP	46.00	-9.3	2.22 H	30	11.97	24.77
8	917.49	38.6 QP	46.00	-7.4	2.18 H	356	13.57	25.00
9	999.99	43.5 QP	54.00	-10.5	1.49 H	230	17.92	25.56

ANTENNA POLARITY & TEST DISTANCE: VERTICAL AT 3 M								
NO.	FREQ. (MHz)	EMISSION LEVEL (dBuV/m)	LIMIT (dBuV/m)	MARGIN (dB)	ANTENNA HEIGHT (m)	TABLE ANGLE (Degree)	RAW VALUE (dBuV)	CORRECTION FACTOR (dB/m)
1	125.00	33.4 QP	43.50	-10.1	1.01 V	45	20.87	12.54
2	196.60	31.1 QP	43.50	-12.4	1.02 V	338	20.16	10.95
3	225.00	32.5 QP	46.00	-13.6	1.00 V	315	19.92	12.53
4	250.00	38.6 QP	46.00	-7.4	1.04 V	339	24.60	14.00
5	500.00	36.0 QP	46.00	-10.0	1.27 V	352	15.61	20.36
6	749.99	33.2 QP	46.00	-12.8	2.14 V	48	10.17	23.07
7	917.49	37.2 QP	46.00	-8.8	1.89 V	30	12.17	25.00
8	1000.00	42.5 QP	54.00	-11.5	1.79 V	351	16.96	25.56

- REMARKS:**
1. Emission level (dBuV/m) = Raw Value (dBuV) + Correction Factor (dB/m).
 2. Correction Factor (dB/m) = Antenna Factor (dB/m) + Cable Factor (dB).
 3. The other emission levels were very low against the limit.
 4. Margin value = Emission level – Limit value.



A D T

ABOVE 1GHz WORST-CASE DATA

802.11b DSSS MODULATION

EUT TEST CONDITION		MEASUREMENT DETAIL	
CHANNEL	Channel 1	FREQUENCY RANGE	1 ~ 25GHz
INPUT POWER (SYSTEM)	120Vac, 60 Hz	DETECTOR FUNCTION	Peak (PK) Average (AV)
ENVIRONMENTAL CONDITIONS	15deg. C, 66%RH 1021 hPa	TESTED BY	Kent Liu

ANTENNA POLARITY & TEST DISTANCE: HORIZONTAL AT 3 M								
NO.	FREQ. (MHz)	EMISSION LEVEL (dBuV/m)	LIMIT (dBuV/m)	MARGIN (dB)	ANTENNA HEIGHT (m)	TABLE ANGLE (Degree)	RAW VALUE (dBuV)	CORRECTION FACTOR (dB/m)
1	2386.13	54.9 PK	74.00	-19.1	1.45 H	290	24.81	30.05
2	2386.13	43.5 AV	54.00	-10.5	1.45 H	290	13.44	30.05
3	*2412.00	99.4 PK			1.42 H	296	69.25	30.15
4	*2412.00	96.4 AV			1.42 H	296	66.28	30.15
5	4824.00	51.7 PK	74.00	-22.3	1.29 H	123	16.27	35.43
6	4824.00	49.5 AV	54.00	-4.5	1.29 H	123	14.08	35.43
ANTENNA POLARITY & TEST DISTANCE: VERTICAL AT 3 M								
NO.	FREQ. (MHz)	EMISSION LEVEL (dBuV/m)	LIMIT (dBuV/m)	MARGIN (dB)	ANTENNA HEIGHT (m)	TABLE ANGLE (Degree)	RAW VALUE (dBuV)	CORRECTION FACTOR (dB/m)
1	2386.27	58.6 PK	74.00	-15.4	1.32 V	219	28.59	30.05
2	2386.27	50.3 AV	54.00	-3.7	1.32 V	219	20.28	30.05
3	*2412.00	109.1 PK			1.35 V	158	78.95	30.15
4	*2412.00	106.7 AV			1.35 V	158	76.55	30.15
5	4824.00	47.8 PK	74.00	-26.2	1.15 V	189	12.37	35.43
6	4824.00	43.9 AV	54.00	-10.1	1.15 V	189	8.47	35.43

- REMARKS:**
1. Emission level (dBuV/m) = Raw Value (dBuV) + Correction Factor (dB/m).
 2. Correction Factor (dB/m) = Antenna Factor (dB/m) + Cable Factor (dB).
 3. The other emission levels were very low against the limit.
 4. Margin value = Emission level – Limit value.
 5. “ * “: Fundamental frequency.



A D T

EUT TEST CONDITION		MEASUREMENT DETAIL	
CHANNEL	Channel 6	FREQUENCY RANGE	1 ~ 25GHz
INPUT POWER (SYSTEM)	120Vac, 60 Hz	DETECTOR FUNCTION	Peak (PK) Average (AV)
ENVIRONMENTAL CONDITIONS	15deg. C, 66%RH 1021 hPa	TESTED BY	Kent Liu

ANTENNA POLARITY & TEST DISTANCE: HORIZONTAL AT 3 M

NO.	FREQ. (MHz)	EMISSION LEVEL (dBuV/m)	LIMIT (dBuV/m)	MARGIN (dB)	ANTENNA HEIGHT (m)	TABLE ANGLE (Degree)	RAW VALUE (dBuV)	CORRECTION FACTOR (dB/m)
1	*2437.00	100.8 PK			1.08 H	192	70.56	30.24
2	*2437.00	98.3 AV			1.08 H	192	68.06	30.24
3	4874.00	51.5 PK	74.00	-22.5	1.44 H	165	15.98	35.52
4	4874.00	49.2 AV	54.00	-4.8	1.44 H	165	13.68	35.52
5	7311.00	49.4 PK	74.00	-24.6	1.72 H	343	7.44	41.96
6	7311.00	38.0 AV	54.00	-16.0	1.72 H	343	-3.96	41.96

ANTENNA POLARITY & TEST DISTANCE: VERTICAL AT 3 M

NO.	FREQ. (MHz)	EMISSION LEVEL (dBuV/m)	LIMIT (dBuV/m)	MARGIN (dB)	ANTENNA HEIGHT (m)	TABLE ANGLE (Degree)	RAW VALUE (dBuV)	CORRECTION FACTOR (dB/m)
1	*2437.00	109.7 PK			1.33 V	189	79.46	30.24
2	*2437.00	107.4 AV			1.33 V	189	77.20	30.24
3	4874.00	46.7 PK	74.00	-27.3	1.48 V	189	11.18	35.52
4	4874.00	42.9 AV	54.00	-11.1	1.48 V	189	7.38	35.52
5	7311.00	50.0 PK	74.00	-24.0	1.18 V	193	8.04	41.96
6	7311.00	38.3 AV	54.00	-15.7	1.18 V	193	-3.66	41.96

- REMARKS:**
1. Emission level (dBuV/m) = Raw Value (dBuV) + Correction Factor (dB/m).
 2. Correction Factor (dB/m) = Antenna Factor (dB/m) + Cable Factor (dB).
 3. The other emission levels were very low against the limit.
 4. Margin value = Emission level – Limit value.
 5. “ * “: Fundamental frequency.



A D T

EUT TEST CONDITION		MEASUREMENT DETAIL	
CHANNEL	Channel 11	FREQUENCY RANGE	1 ~ 25GHz
INPUT POWER (SYSTEM)	120Vac, 60 Hz	DETECTOR FUNCTION	Peak (PK) Average (AV)
ENVIRONMENTAL CONDITIONS	15deg. C, 66%RH 1021 hPa	TESTED BY	Kent Liu

ANTENNA POLARITY & TEST DISTANCE: HORIZONTAL AT 3 M

NO.	FREQ. (MHz)	EMISSION LEVEL (dBuV/m)	LIMIT (dBuV/m)	MARGIN (dB)	ANTENNA HEIGHT (m)	TABLE ANGLE (Degree)	RAW VALUE (dBuV)	CORRECTION FACTOR (dB/m)
1	*2462.00	100.5 PK			1.08 H	13	70.16	30.34
2	*2462.00	97.5 AV			1.08 H	13	67.16	30.34
3	2488.07	54.8 PK	74.00	-19.2	1.03 H	9	24.37	30.44
4	2488.07	42.8 AV	54.00	-11.2	1.03 H	9	12.34	30.44
5	4924.00	52.4 PK	74.00	-21.6	1.08 H	164	16.78	35.62
6	4924.00	49.4 AV	54.00	-4.6	1.08 H	164	13.78	35.62
7	7386.00	49.9 PK	74.00	-24.1	1.65 H	351	7.80	42.10
8	7386.00	38.3 AV	54.00	-15.7	1.65 H	351	-3.80	42.10

ANTENNA POLARITY & TEST DISTANCE: VERTICAL AT 3 M

NO.	FREQ. (MHz)	EMISSION LEVEL (dBuV/m)	LIMIT (dBuV/m)	MARGIN (dB)	ANTENNA HEIGHT (m)	TABLE ANGLE (Degree)	RAW VALUE (dBuV)	CORRECTION FACTOR (dB/m)
1	*2462.00	109.6 PK			1.31 V	160	79.26	30.34
2	*2462.00	107.4 AV			1.31 V	160	77.06	30.34
3	2488.18	58.8 PK	74.00	-15.2	1.28 V	160	28.40	30.44
4	2488.18	50.4 AV	54.00	-3.6	1.28 V	160	19.94	30.44
5	4924.00	46.7 PK	74.00	-27.3	1.25 V	181	11.08	35.62
6	4924.00	42.6 AV	54.00	-11.4	1.25 V	181	6.98	35.62
7	7386.00	50.4 PK	74.00	-23.6	1.20 V	189	8.30	42.10
8	7386.00	38.5 AV	54.00	-15.5	1.20 V	189	-3.60	42.10

- REMARKS:**
1. Emission level (dBuV/m) = Raw Value (dBuV) + Correction Factor (dB/m).
 2. Correction Factor (dB/m) = Antenna Factor (dB/m) + Cable Factor (dB).
 3. The other emission levels were very low against the limit.
 4. Margin value = Emission level – Limit value.
 5. “ * “: Fundamental frequency.



A D T

RESTRICTED BANDEDGE (802.11b MODE, CH1, HORIZONTAL)

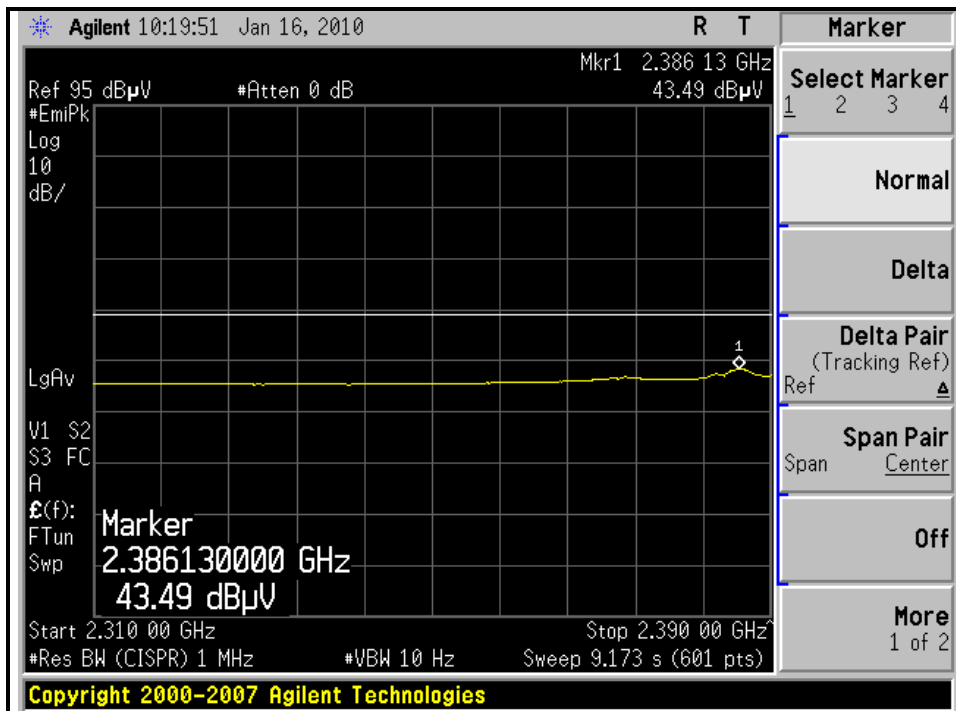
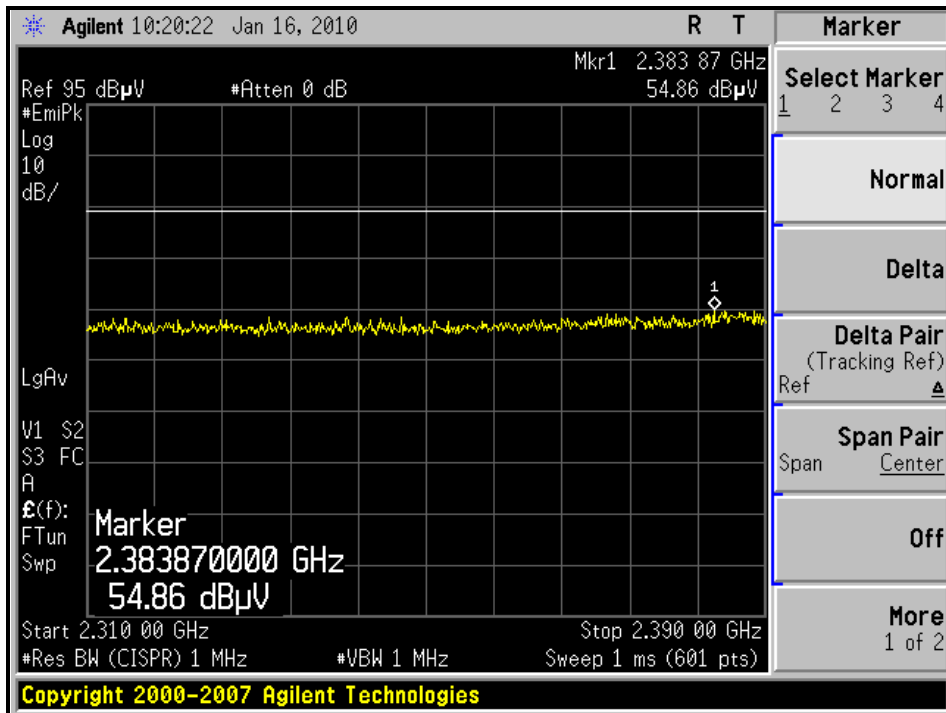



A D T

RESTRICTED BANDEDGE (802.11b MODE, CH1, VERTICAL)

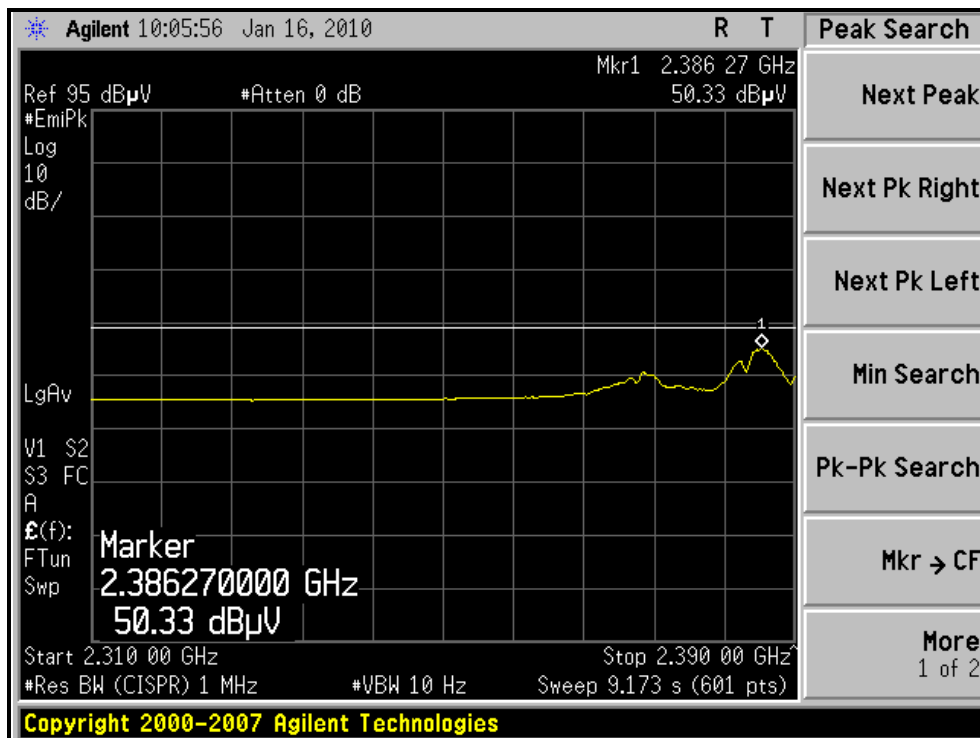
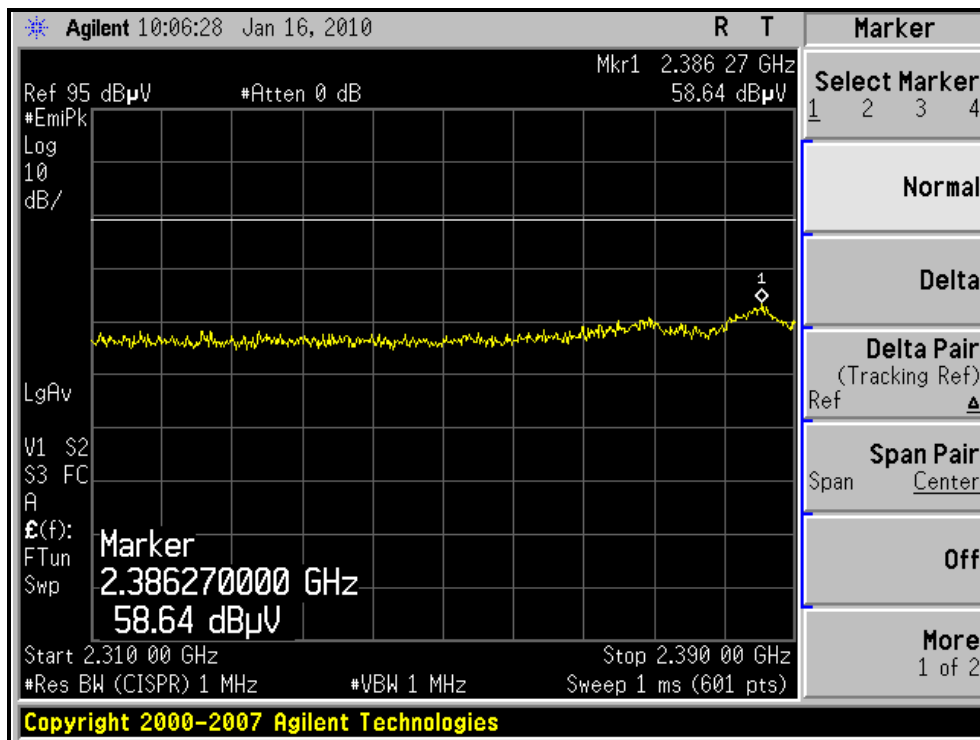



A D T

RESTRICTED BANDEDGE (802.11b MODE, CH11, HORIZONTAL)

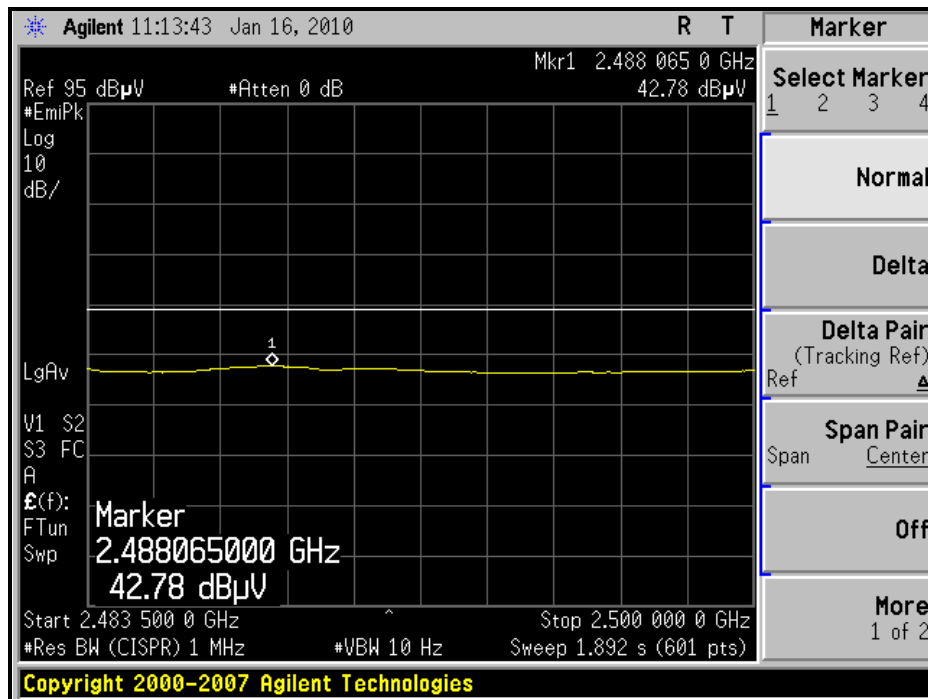
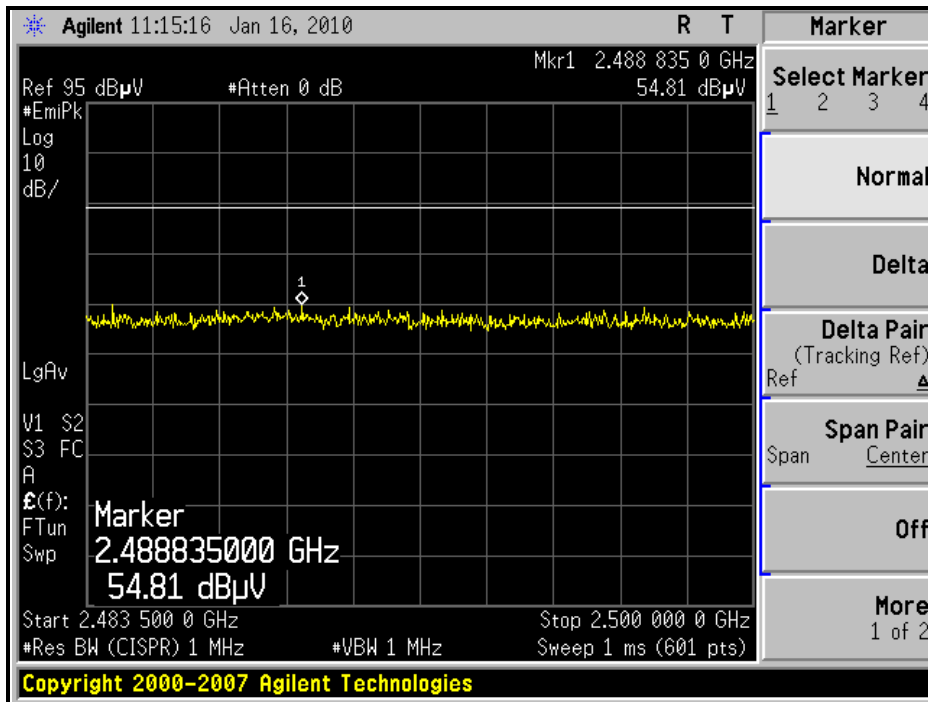



A D T

RESTRICTED BANDEDGE (802.11b MODE, CH11, VERTICAL)

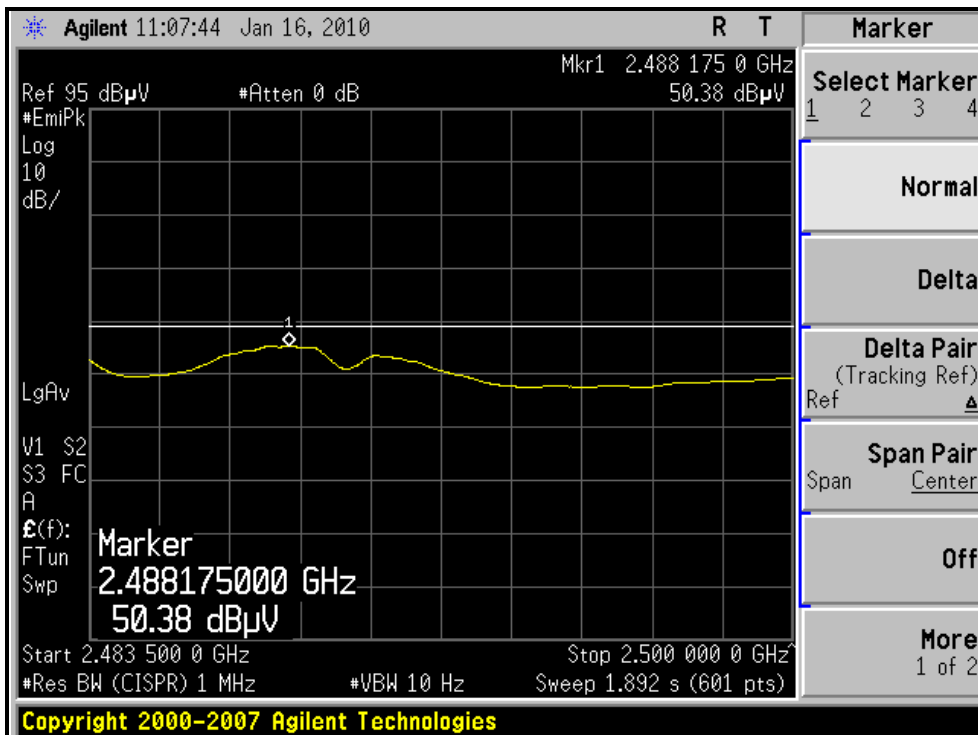
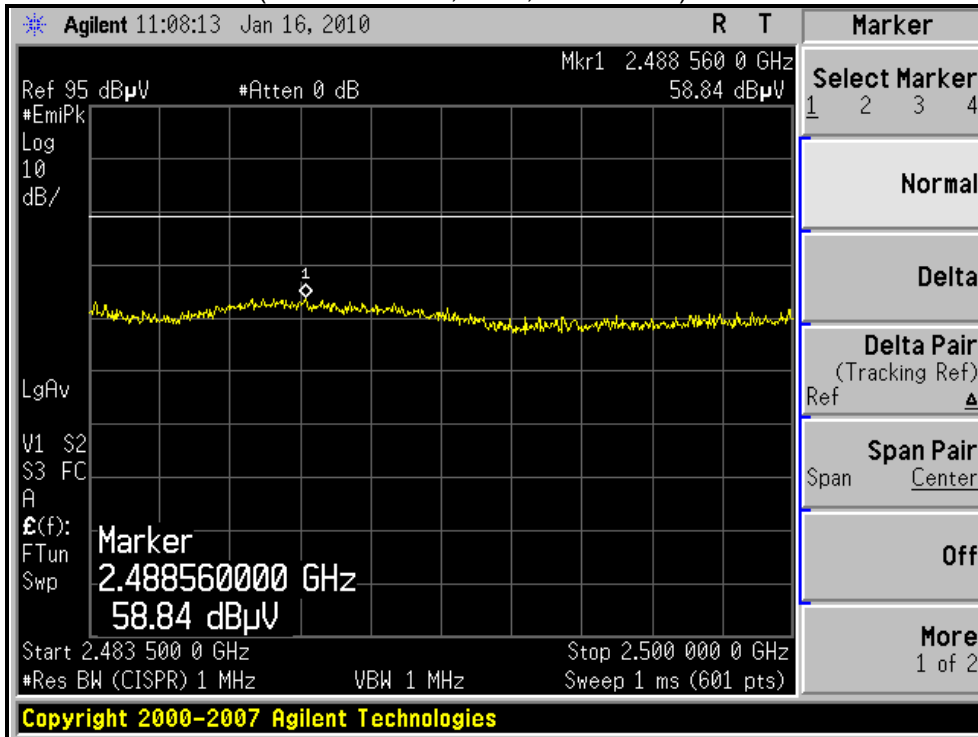



A D T

802.11g OFDM MODULATION

EUT TEST CONDITION		MEASUREMENT DETAIL	
CHANNEL	Channel 1	FREQUENCY RANGE	1 ~ 25GHz
INPUT POWER (SYSTEM)	120Vac, 60 Hz	DETECTOR FUNCTION	Peak (PK) Average (AV)
ENVIRONMENTAL CONDITIONS	15deg. C, 66%RH 1021 hPa	TESTED BY	Kent Liu

ANTENNA POLARITY & TEST DISTANCE: HORIZONTAL AT 3 M

NO.	FREQ. (MHz)	EMISSION LEVEL (dBuV/m)	LIMIT (dBuV/m)	MARGIN (dB)	ANTENNA HEIGHT (m)	TABLE ANGLE (Degree)	RAW VALUE (dBuV)	CORRECTION FACTOR (dB/m)
1	2390.00	63.1 PK	74.00	-10.9	1.06 H	198	33.01	30.06
2	2390.00	46.5 AV	54.00	-7.5	1.06 H	198	16.40	30.06
3	*2412.00	99.6 PK			1.05 H	199	69.44	30.15
4	*2412.00	91.6 AV			1.05 H	199	61.45	30.15
5	4824.00	48.1 PK	74.00	-25.9	1.40 H	203	12.67	35.43
6	4824.00	35.8 AV	54.00	-18.2	1.40 H	203	0.34	35.43

ANTENNA POLARITY & TEST DISTANCE: VERTICAL AT 3 M

NO.	FREQ. (MHz)	EMISSION LEVEL (dBuV/m)	LIMIT (dBuV/m)	MARGIN (dB)	ANTENNA HEIGHT (m)	TABLE ANGLE (Degree)	RAW VALUE (dBuV)	CORRECTION FACTOR (dB/m)
1	2390.00	67.1 PK	74.00	-7.0	1.26 V	234	36.99	30.06
2	2390.00	53.1 AV	54.00	-0.9	1.26 V	234	23.03	30.06
3	*2412.00	110.2 PK			1.33 V	242	80.05	30.15
4	*2412.00	100.0 AV			1.33 V	242	69.85	30.15
5	4824.00	41.7 PK	74.00	-32.3	1.24 V	222	6.27	35.43
6	4824.00	33.2 AV	54.00	-20.8	1.24 V	222	-2.23	35.43

- REMARKS:**
1. Emission level (dBuV/m) = Raw Value (dBuV) + Correction Factor (dB/m).
 2. Correction Factor (dB/m) = Antenna Factor (dB/m) + Cable Factor (dB).
 3. The other emission levels were very low against the limit.
 4. Margin value = Emission level – Limit value.
 5. “ * “: Fundamental frequency.



A D T

EUT TEST CONDITION		MEASUREMENT DETAIL	
CHANNEL	Channel 6	FREQUENCY RANGE	1 ~ 25GHz
INPUT POWER (SYSTEM)	120Vac, 60 Hz	DETECTOR FUNCTION	Peak (PK) Average (AV)
ENVIRONMENTAL CONDITIONS	15deg. C, 66%RH 1021 hPa	TESTED BY	Kent Liu

ANTENNA POLARITY & TEST DISTANCE: HORIZONTAL AT 3 M								
NO.	FREQ. (MHz)	EMISSION LEVEL (dBuV/m)	LIMIT (dBuV/m)	MARGIN (dB)	ANTENNA HEIGHT (m)	TABLE ANGLE (Degree)	RAW VALUE (dBuV)	CORRECTION FACTOR (dB/m)
1	*2437.00	100.0 PK			1.07 H	190	69.76	30.24
2	*2437.00	90.9 AV			1.07 H	190	60.66	30.24
3	4874.00	47.2 PK	74.00	-26.8	1.00 H	152	11.68	35.52
4	4874.00	34.6 AV	54.00	-19.4	1.00 H	152	-0.92	35.52
5	7311.00	49.0 PK	74.00	-25.0	1.37 H	211	7.04	41.96
6	7311.00	37.5 AV	54.00	-16.5	1.37 H	211	-4.46	41.96
ANTENNA POLARITY & TEST DISTANCE: VERTICAL AT 3 M								
NO.	FREQ. (MHz)	EMISSION LEVEL (dBuV/m)	LIMIT (dBuV/m)	MARGIN (dB)	ANTENNA HEIGHT (m)	TABLE ANGLE (Degree)	RAW VALUE (dBuV)	CORRECTION FACTOR (dB/m)
1	*2437.00	109.0 PK			1.33 V	192	78.76	30.24
2	*2437.00	99.9 AV			1.33 V	192	69.66	30.24
3	4874.00	42.9 PK	74.00	-31.1	1.13 V	208	7.38	35.52
4	4874.00	33.8 AV	54.00	-20.2	1.13 V	208	-1.72	35.52
5	7311.00	48.7 PK	74.00	-25.3	1.42 V	256	6.74	41.96
6	7311.00	37.4 AV	54.00	-16.6	1.42 V	256	-4.56	41.96

- REMARKS:**
1. Emission level (dBuV/m) = Raw Value (dBuV) + Correction Factor (dB/m).
 2. Correction Factor (dB/m) = Antenna Factor (dB/m) + Cable Factor (dB).
 3. The other emission levels were very low against the limit.
 4. Margin value = Emission level – Limit value.
 5. “ * “: Fundamental frequency.



A D T

EUT TEST CONDITION		MEASUREMENT DETAIL	
CHANNEL	Channel 11	FREQUENCY RANGE	1 ~ 25GHz
INPUT POWER (SYSTEM)	120Vac, 60 Hz	DETECTOR FUNCTION	Peak (PK) Average (AV)
ENVIRONMENTAL CONDITIONS	15deg. C, 66%RH 1021 hPa	TESTED BY	Kent Liu

ANTENNA POLARITY & TEST DISTANCE: HORIZONTAL AT 3 M								
NO.	FREQ. (MHz)	EMISSION LEVEL (dBuV/m)	LIMIT (dBuV/m)	MARGIN (dB)	ANTENNA HEIGHT (m)	TABLE ANGLE (Degree)	RAW VALUE (dBuV)	CORRECTION FACTOR (dB/m)
1	*2462.00	97.7 PK			1.01 H	57	67.36	30.34
2	*2462.00	88.9 AV			1.01 H	57	58.55	30.34
3	2483.50	59.1 PK	74.00	-14.9	1.02 H	58	28.70	30.43
4	2483.50	43.5 AV	54.00	-10.5	1.02 H	58	13.08	30.43
5	4924.00	46.8 PK	74.00	-27.2	1.34 H	211	11.18	35.62
6	4924.00	34.0 AV	54.00	-20.0	1.34 H	211	-1.58	35.62
7	7386.00	48.3 PK	74.00	-25.7	1.09 H	124	6.20	42.10
8	7386.00	36.3 AV	54.00	-17.8	1.09 H	124	-5.85	42.10
ANTENNA POLARITY & TEST DISTANCE: VERTICAL AT 3 M								
NO.	FREQ. (MHz)	EMISSION LEVEL (dBuV/m)	LIMIT (dBuV/m)	MARGIN (dB)	ANTENNA HEIGHT (m)	TABLE ANGLE (Degree)	RAW VALUE (dBuV)	CORRECTION FACTOR (dB/m)
1	*2462.00	109.2 PK			1.22 V	221	78.86	30.34
2	*2462.00	99.8 AV			1.22 V	221	69.46	30.34
3	2483.50	71.1 PK	74.00	-2.9	1.20 V	200	40.64	30.43
4	2483.50	53.3 AV	54.00	-0.7	1.20 V	200	22.88	30.43
5	4924.00	44.3 PK	74.00	-29.7	1.23 V	211	8.68	35.62
6	4924.00	33.4 AV	54.00	-20.6	1.23 V	211	-2.22	35.62
7	7386.00	48.4 PK	74.00	-25.6	1.44 V	208	6.30	42.10
8	7386.00	36.1 AV	54.00	-17.9	1.44 V	208	-6.01	42.10

- REMARKS:**
1. Emission level (dBuV/m) = Raw Value (dBuV) + Correction Factor (dB/m).
 2. Correction Factor (dB/m) = Antenna Factor (dB/m) + Cable Factor (dB).
 3. The other emission levels were very low against the limit.
 4. Margin value = Emission level – Limit value.
 5. “ * “: Fundamental frequency.



A D T

RESTRICTED BANDEDGE (802.11g MODE, CH1, HORIZONTAL)

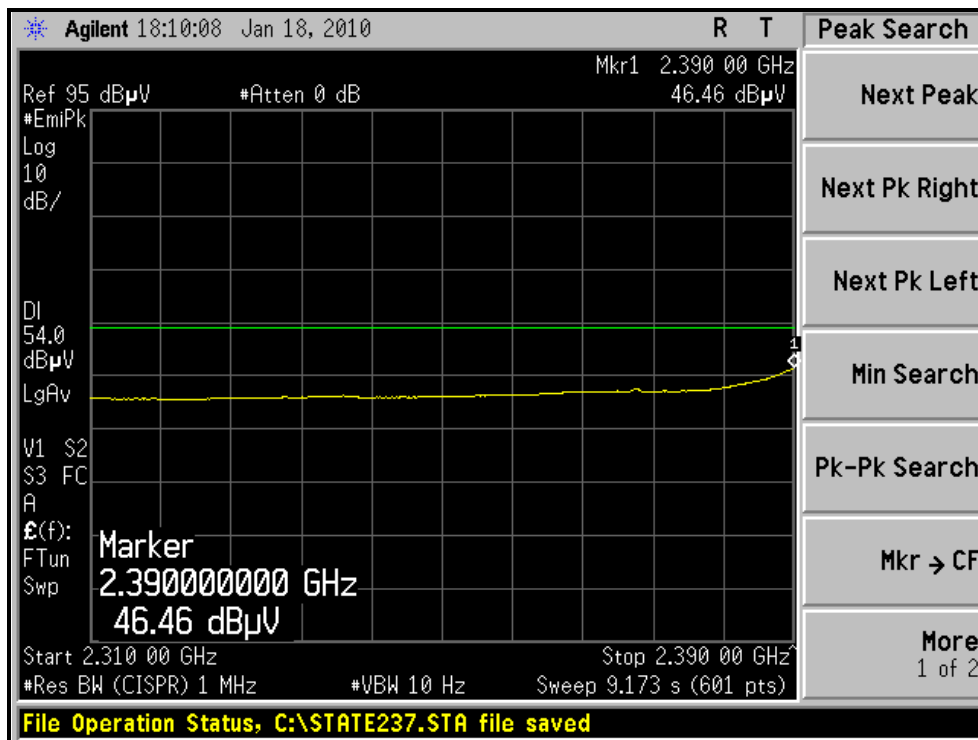
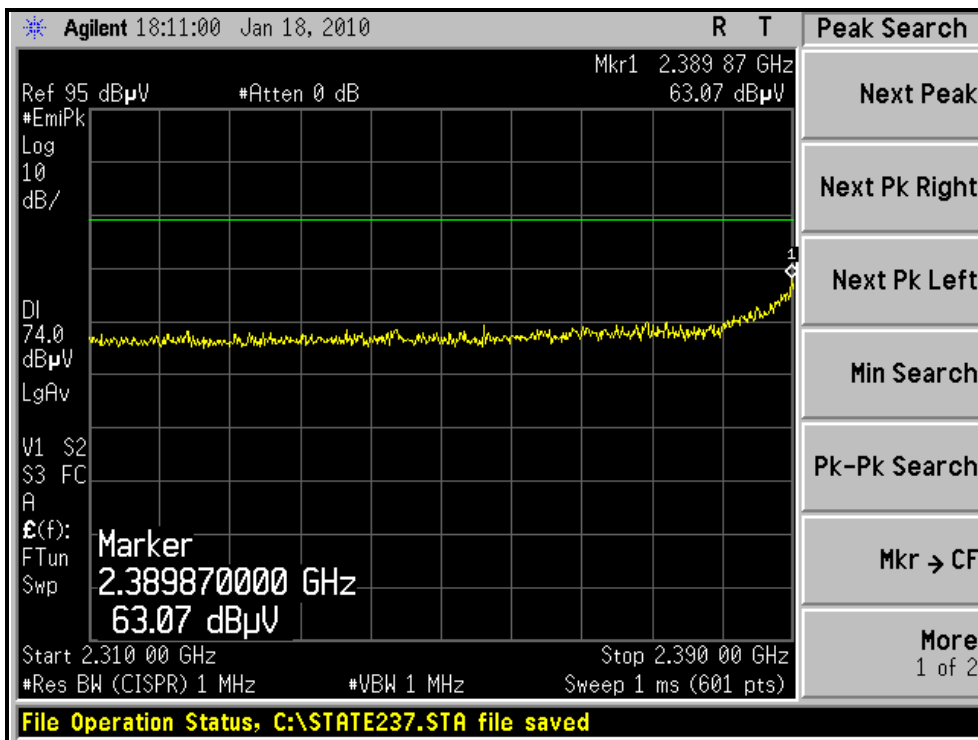



A D T

RESTRICTED BANDEDGE (802.11g MODE, CH1, VERTICAL)

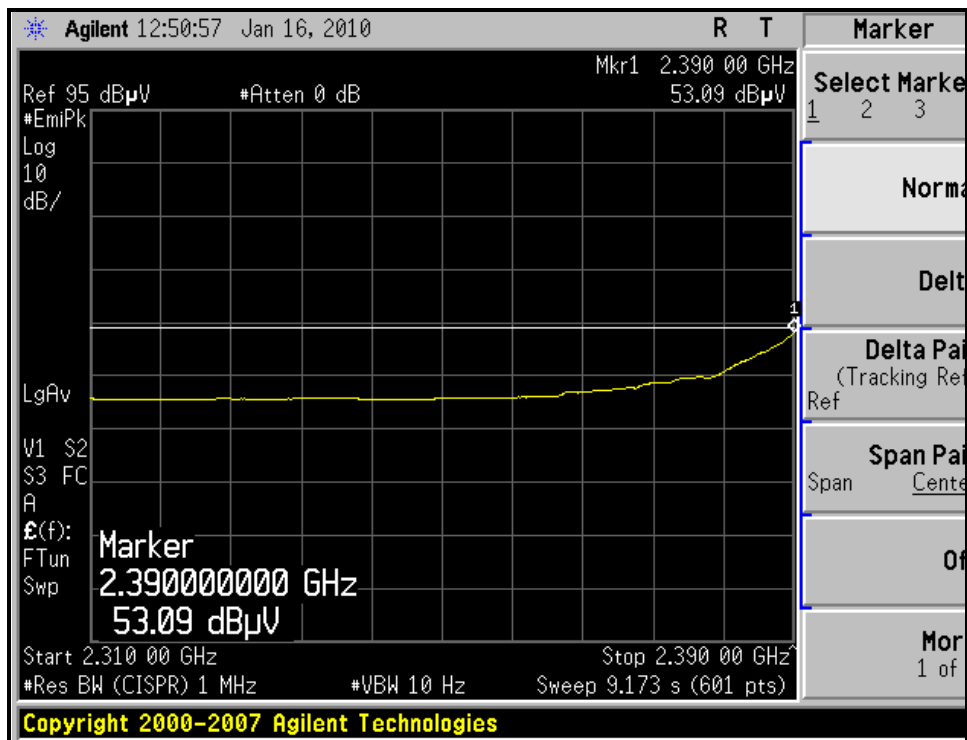
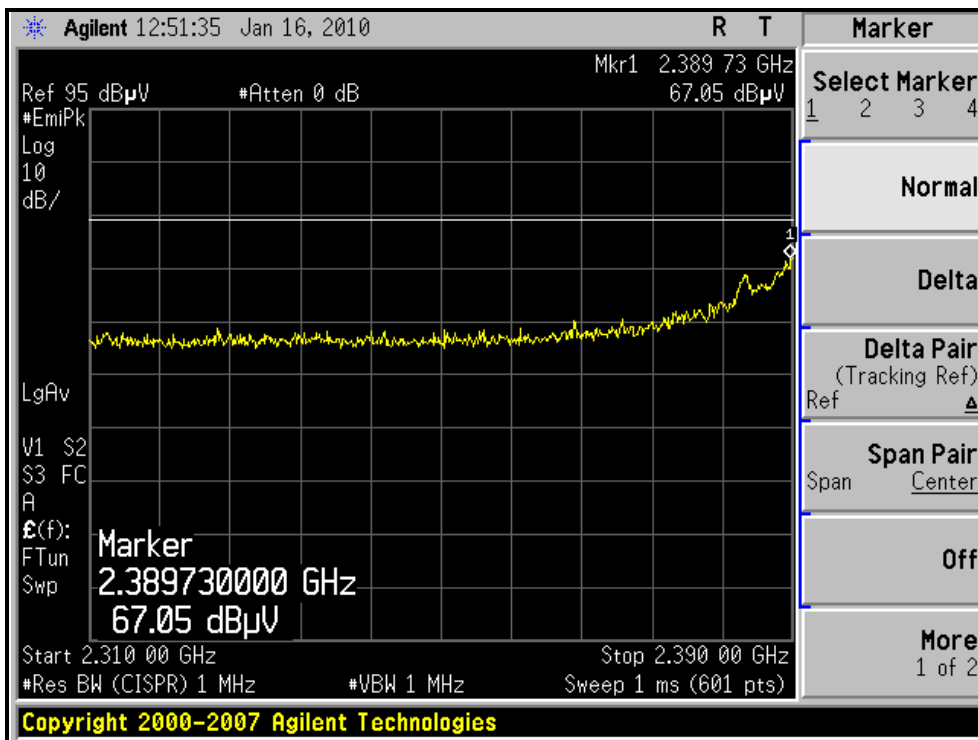



A D T

RESTRICTED BANDEDGE (802.11g MODE, CH11, HORIZONTAL)

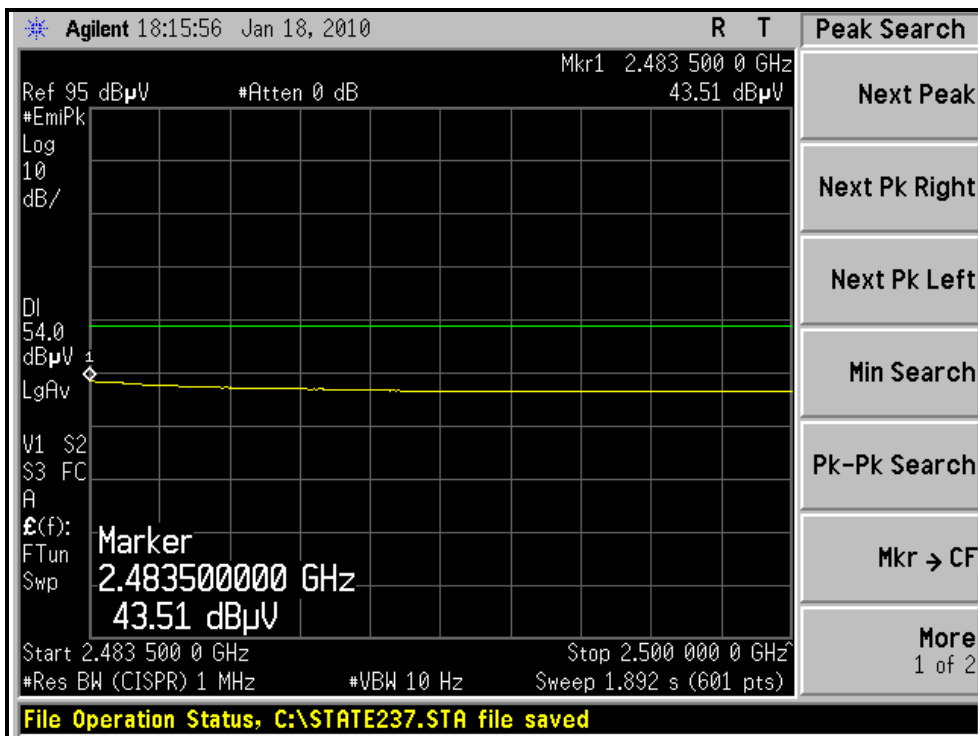
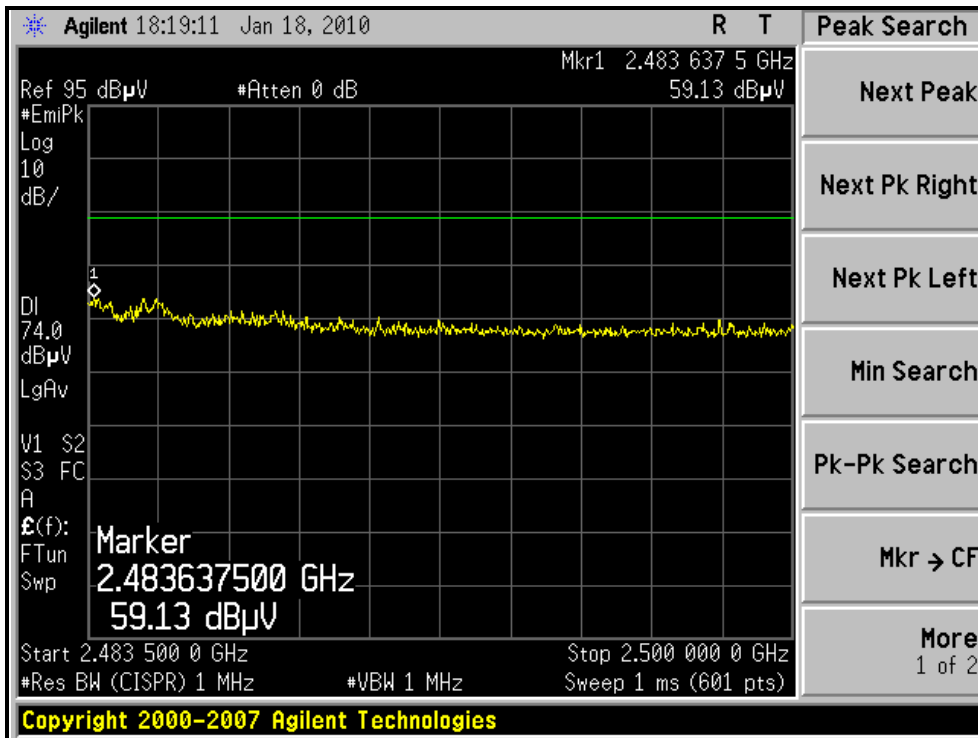



A D T

RESTRICTED BANDEDGE (802.11g MODE,CH11, VERTICAL)

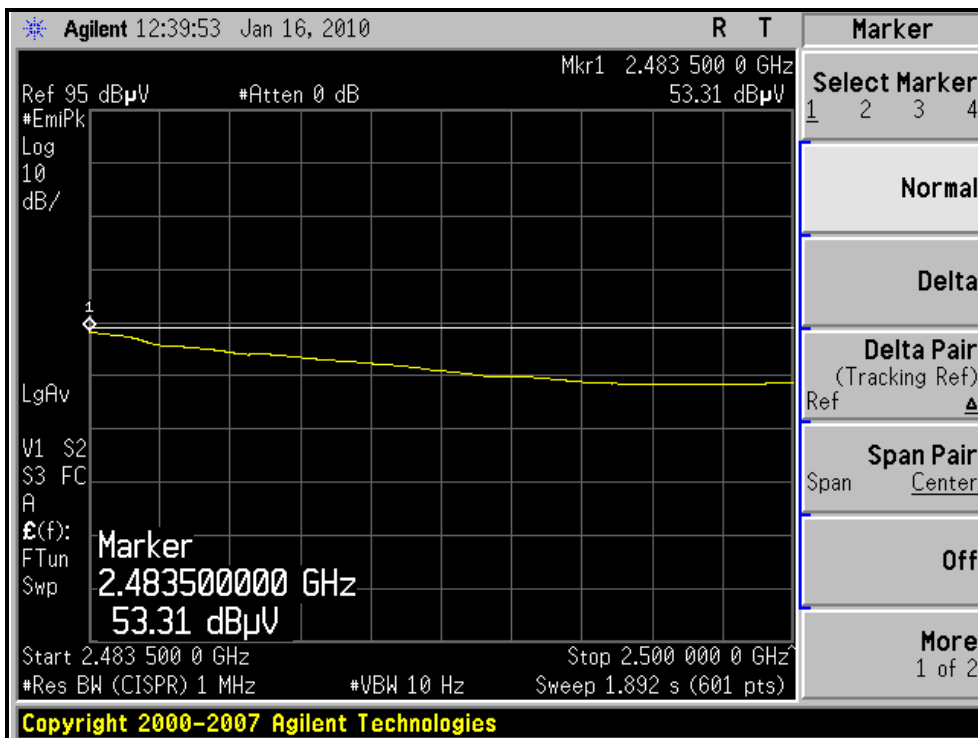
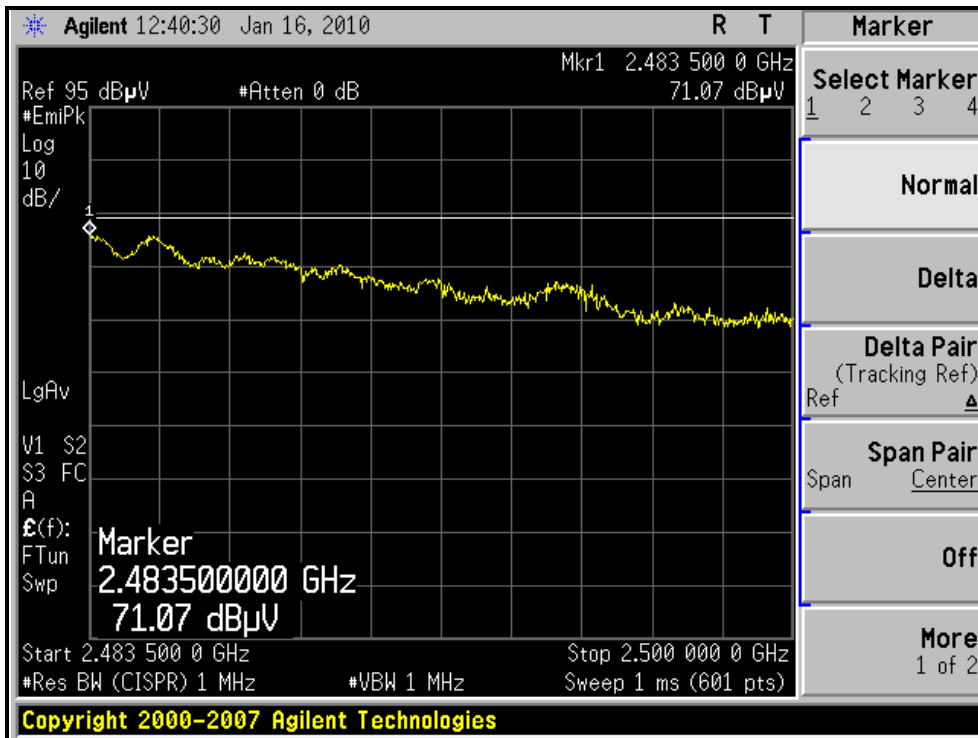



A D T

802.11n (20MHz) OFDM MODULATION

EUT TEST CONDITION		MEASUREMENT DETAIL	
CHANNEL	Channel 1	FREQUENCY RANGE	1 ~ 25GHz
INPUT POWER (SYSTEM)	120Vac, 60 Hz	DETECTOR FUNCTION	Peak (PK) Average (AV)
ENVIRONMENTAL CONDITIONS	15deg. C, 66%RH 1021 hPa	TESTED BY	Kent Liu

ANTENNA POLARITY & TEST DISTANCE: HORIZONTAL AT 3 M								
NO.	FREQ. (MHz)	EMISSION LEVEL (dBuV/m)	LIMIT (dBuV/m)	MARGIN (dB)	ANTENNA HEIGHT (m)	TABLE ANGLE (Degree)	RAW VALUE (dBuV)	CORRECTION FACTOR (dB/m)
1	2390.00	59.2 PK	74.00	-14.8	1.39 H	298	29.11	30.06
2	2390.00	44.8 AV	54.00	-9.2	1.39 H	298	14.72	30.06
3	*2412.00	102.0 PK			1.39 H	296	71.86	30.15
4	*2412.00	91.2 AV			1.39 H	296	61.07	30.15
5	4824.00	45.2 PK	74.00	-28.8	1.41 H	203	9.76	35.43
6	4824.00	33.8 AV	54.00	-20.2	1.41 H	203	-1.62	35.43
ANTENNA POLARITY & TEST DISTANCE: VERTICAL AT 3 M								
NO.	FREQ. (MHz)	EMISSION LEVEL (dBuV/m)	LIMIT (dBuV/m)	MARGIN (dB)	ANTENNA HEIGHT (m)	TABLE ANGLE (Degree)	RAW VALUE (dBuV)	CORRECTION FACTOR (dB/m)
1	2390.00	68.7 PK	74.00	-5.4	1.32 V	241	38.59	30.06
2	2390.00	52.6 AV	54.00	-1.4	1.32 V	241	22.58	30.06
3	*2412.00	111.5 PK			1.35 V	159	81.35	30.15
4	*2412.00	100.8 AV			1.35 V	159	70.65	30.15
5	4824.00	44.2 PK	74.00	-29.8	1.32 V	241	8.76	35.43
6	4824.00	33.6 AV	54.00	-20.4	1.32 V	241	-1.79	35.43

- REMARKS:**
1. Emission level (dBuV/m) = Raw Value (dBuV) + Correction Factor (dB/m).
 2. Correction Factor (dB/m) = Antenna Factor (dB/m) + Cable Factor (dB).
 3. The other emission levels were very low against the limit.
 4. Margin value = Emission level – Limit value.
 5. “ * “: Fundamental frequency.



A D T

EUT TEST CONDITION		MEASUREMENT DETAIL	
CHANNEL	Channel 6	FREQUENCY RANGE	1 ~ 25GHz
INPUT POWER (SYSTEM)	120Vac, 60 Hz	DETECTOR FUNCTION	Peak (PK) Average (AV)
ENVIRONMENTAL CONDITIONS	15deg. C, 66%RH 1021 hPa	TESTED BY	Kent Liu

ANTENNA POLARITY & TEST DISTANCE: HORIZONTAL AT 3 M								
NO.	FREQ. (MHz)	EMISSION LEVEL (dBuV/m)	LIMIT (dBuV/m)	MARGIN (dB)	ANTENNA HEIGHT (m)	TABLE ANGLE (Degree)	RAW VALUE (dBuV)	CORRECTION FACTOR (dB/m)
1	*2437.00	101.0 PK			1.38 H	255	70.71	30.24
2	*2437.00	90.7 AV			1.38 H	255	60.46	30.24
3	4874.00	44.6 PK	74.00	-29.4	1.15 H	265	9.08	35.52
4	4874.00	33.7 AV	54.00	-20.3	1.15 H	265	-1.82	35.52
5	7311.00	49.2 PK	74.00	-24.8	1.22 H	117	7.24	41.96
6	7311.00	37.3 AV	54.00	-16.7	1.22 H	117	-4.66	41.96
ANTENNA POLARITY & TEST DISTANCE: VERTICAL AT 3 M								
NO.	FREQ. (MHz)	EMISSION LEVEL (dBuV/m)	LIMIT (dBuV/m)	MARGIN (dB)	ANTENNA HEIGHT (m)	TABLE ANGLE (Degree)	RAW VALUE (dBuV)	CORRECTION FACTOR (dB/m)
1	*2437.00	111.6 PK			1.32 V	183	81.36	30.24
2	*2437.00	101.3 AV			1.32 V	183	71.06	30.24
3	4874.00	45.3 PK	74.00	-28.7	1.33 V	205	9.78	35.52
4	4874.00	34.0 AV	54.00	-20.0	1.33 V	205	-1.52	35.52
5	7311.00	49.0 PK	74.00	-25.0	1.37 V	269	7.04	41.96
6	7311.00	37.1 AV	54.00	-16.9	1.37 V	269	-4.86	41.96

- REMARKS:**
1. Emission level (dBuV/m) = Raw Value (dBuV) + Correction Factor (dB/m).
 2. Correction Factor (dB/m) = Antenna Factor (dB/m) + Cable Factor (dB).
 3. The other emission levels were very low against the limit.
 4. Margin value = Emission level – Limit value.
 5. “ * “: Fundamental frequency.



A D T

EUT TEST CONDITION		MEASUREMENT DETAIL	
CHANNEL	Channel 11	FREQUENCY RANGE	1 ~ 25GHz
INPUT POWER (SYSTEM)	120Vac, 60 Hz	DETECTOR FUNCTION	Peak (PK) Average (AV)
ENVIRONMENTAL CONDITIONS	15deg. C, 66%RH 1021 hPa	TESTED BY	Kent Liu

ANTENNA POLARITY & TEST DISTANCE: HORIZONTAL AT 3 M								
NO.	FREQ. (MHz)	EMISSION LEVEL (dBuV/m)	LIMIT (dBuV/m)	MARGIN (dB)	ANTENNA HEIGHT (m)	TABLE ANGLE (Degree)	RAW VALUE (dBuV)	CORRECTION FACTOR (dB/m)
1	*2462.00	97.2 PK			1.31 H	196	66.83	30.34
2	*2462.00	86.7 AV			1.31 H	196	56.36	30.34
3	2483.50	56.0 PK	74.00	-18.0	1.38 H	194	25.59	30.43
4	2483.50	43.7 AV	54.00	-10.3	1.38 H	194	13.24	30.43
5	4924.00	43.2 PK	74.00	-30.9	1.46 H	120	7.53	35.62
6	4924.00	32.6 AV	54.00	-21.4	1.46 H	120	-3.02	35.62
7	7386.00	48.9 PK	74.00	-25.1	1.42 H	211	6.80	42.10
8	7386.00	36.6 AV	54.00	-17.4	1.42 H	211	-5.50	42.10
ANTENNA POLARITY & TEST DISTANCE: VERTICAL AT 3 M								
NO.	FREQ. (MHz)	EMISSION LEVEL (dBuV/m)	LIMIT (dBuV/m)	MARGIN (dB)	ANTENNA HEIGHT (m)	TABLE ANGLE (Degree)	RAW VALUE (dBuV)	CORRECTION FACTOR (dB/m)
1	*2462.00	109.5 PK			1.31 V	158	79.16	30.34
2	*2462.00	99.4 AV			1.31 V	158	69.09	30.34
3	2483.50	69.2 PK	74.00	-4.8	1.30 V	158	38.76	30.43
4	2483.50	53.3 AV	54.00	-0.7	1.30 V	158	22.91	30.43
5	4924.00	42.3 PK	74.00	-31.8	1.38 V	33	6.63	35.62
6	4924.00	31.8 AV	54.00	-22.2	1.38 V	33	-3.79	35.62
7	7386.00	48.2 PK	74.00	-25.8	1.39 V	266	6.14	42.10
8	7386.00	36.8 AV	54.00	-17.2	1.39 V	266	-5.26	42.10

- REMARKS:**
1. Emission level (dBuV/m) = Raw Value (dBuV) + Correction Factor (dB/m).
 2. Correction Factor (dB/m) = Antenna Factor (dB/m) + Cable Factor (dB).
 3. The other emission levels were very low against the limit.
 4. Margin value = Emission level – Limit value.
 5. “ * “: Fundamental frequency.



A D T

RESTRICTED BANDEDGE (802.11n (20MHz) MODE,CH1, HORIZONTAL)

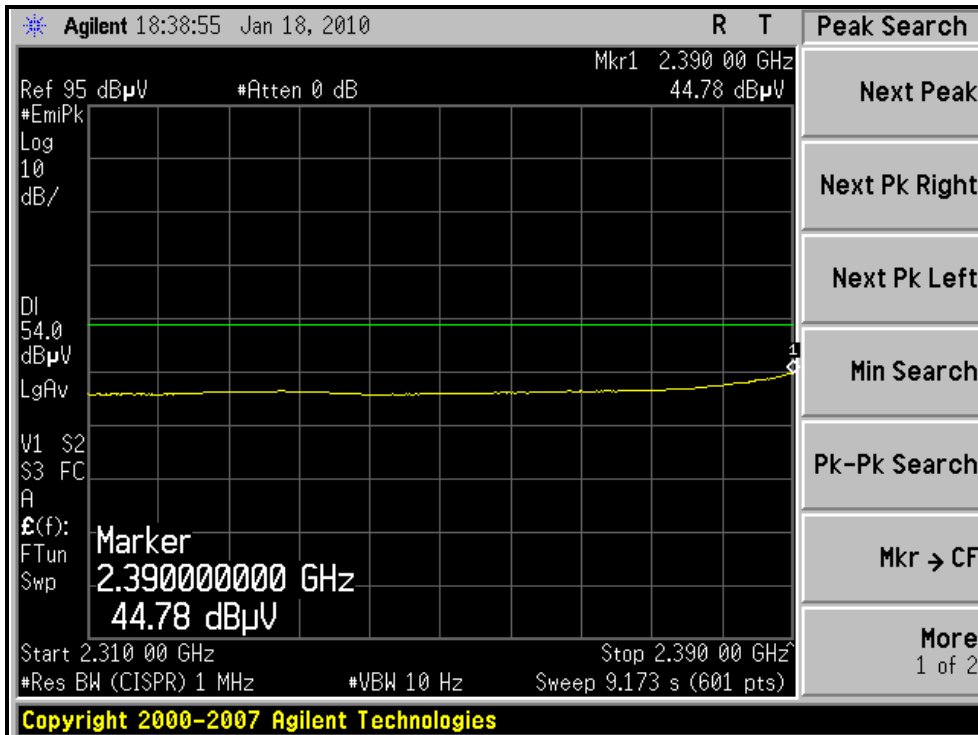
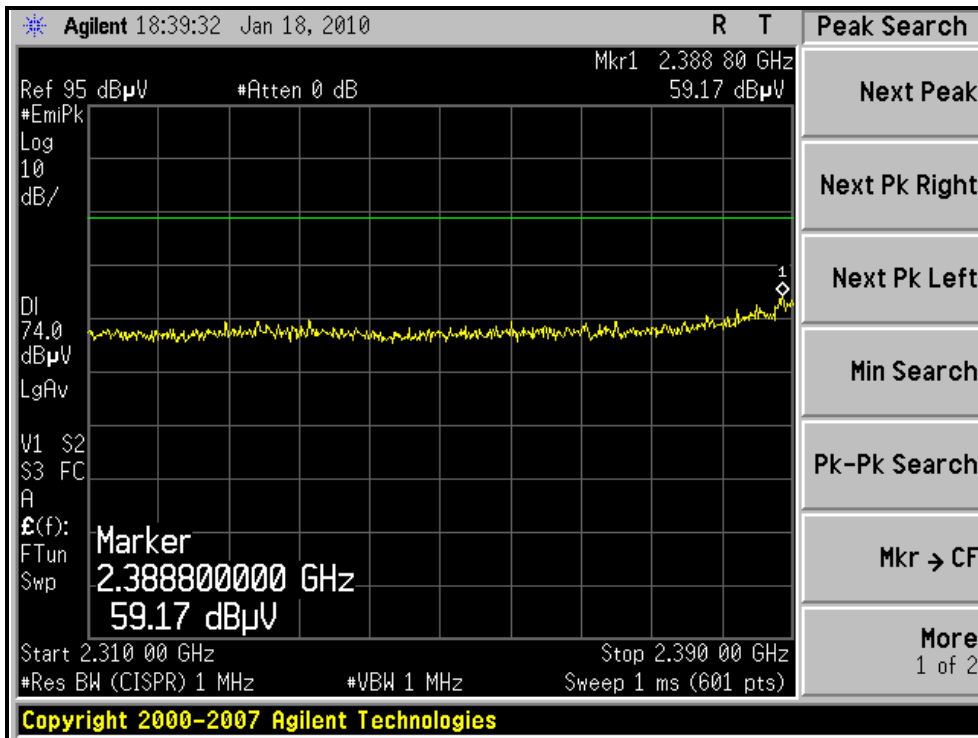



A D T

RESTRICTED BANDEDGE (802.11n (20MHz) MODE,CH1, VERTICAL)

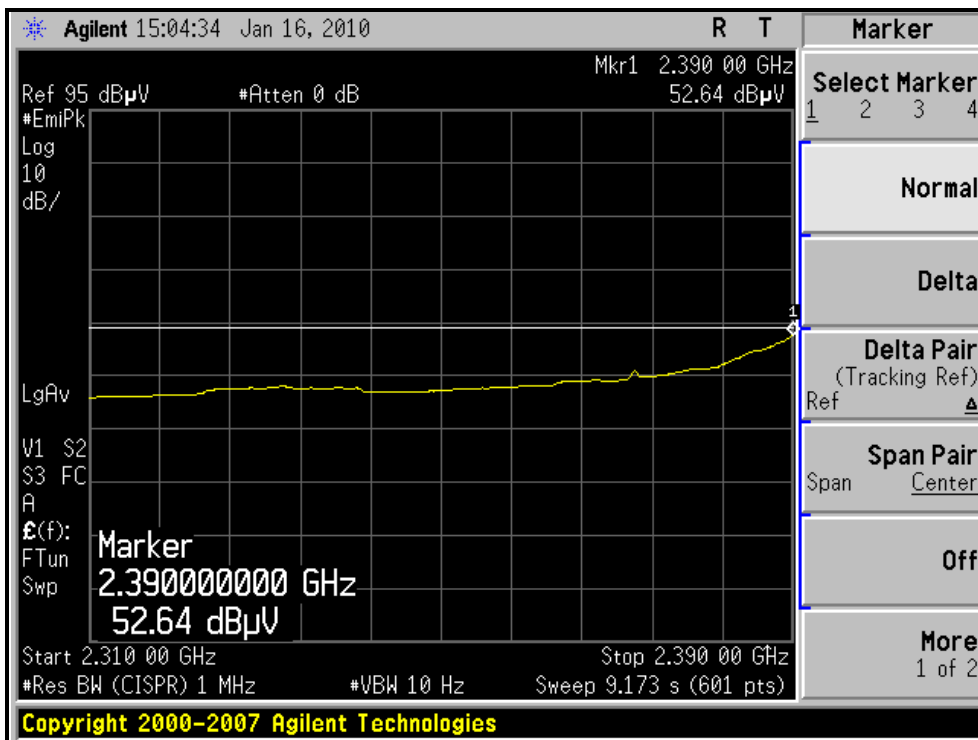
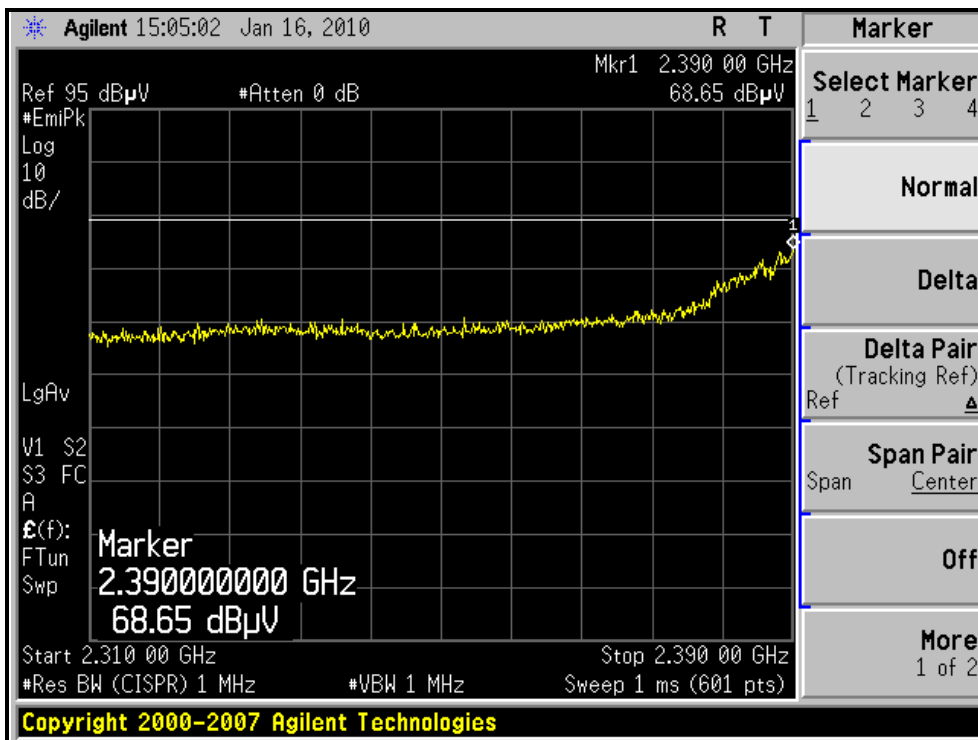



A D T

RESTRICTED BANDEDGE (802.11n (20MHz) MODE,CH11, HORIZONTAL)

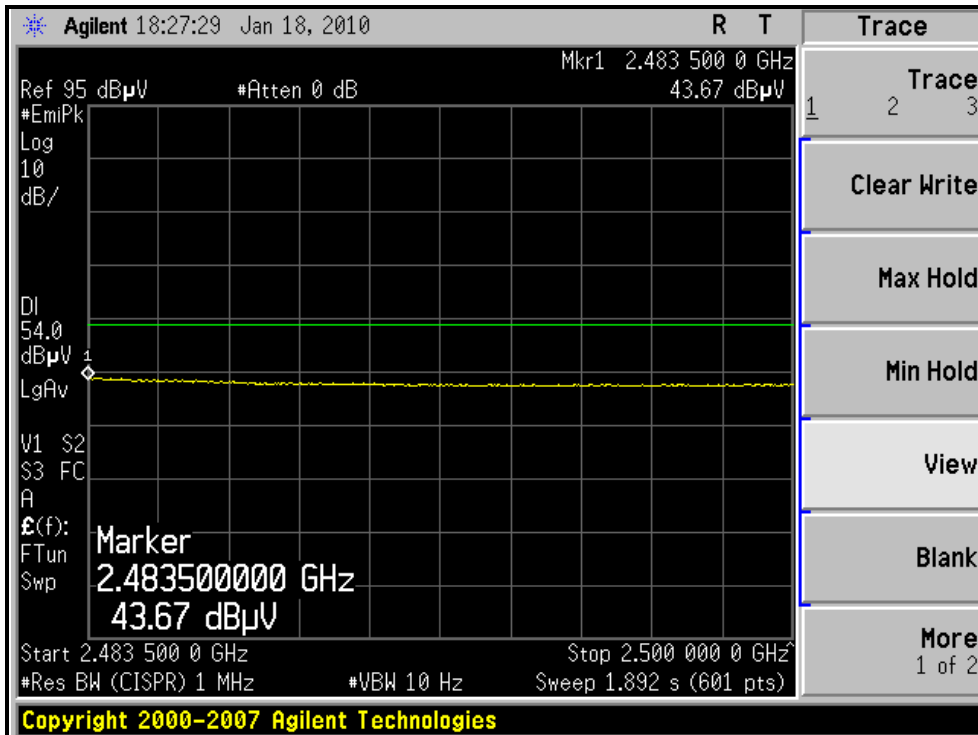
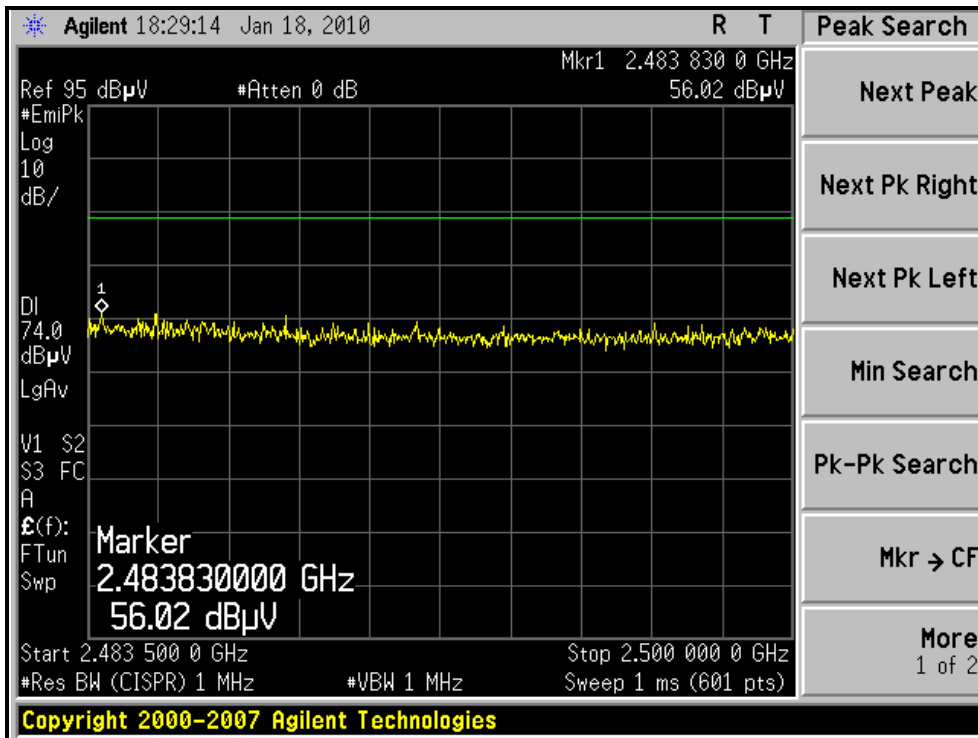



A D T

RESTRICTED BANDEDGE (802.11n (20MHz) MODE,CH11, VERTICAL)

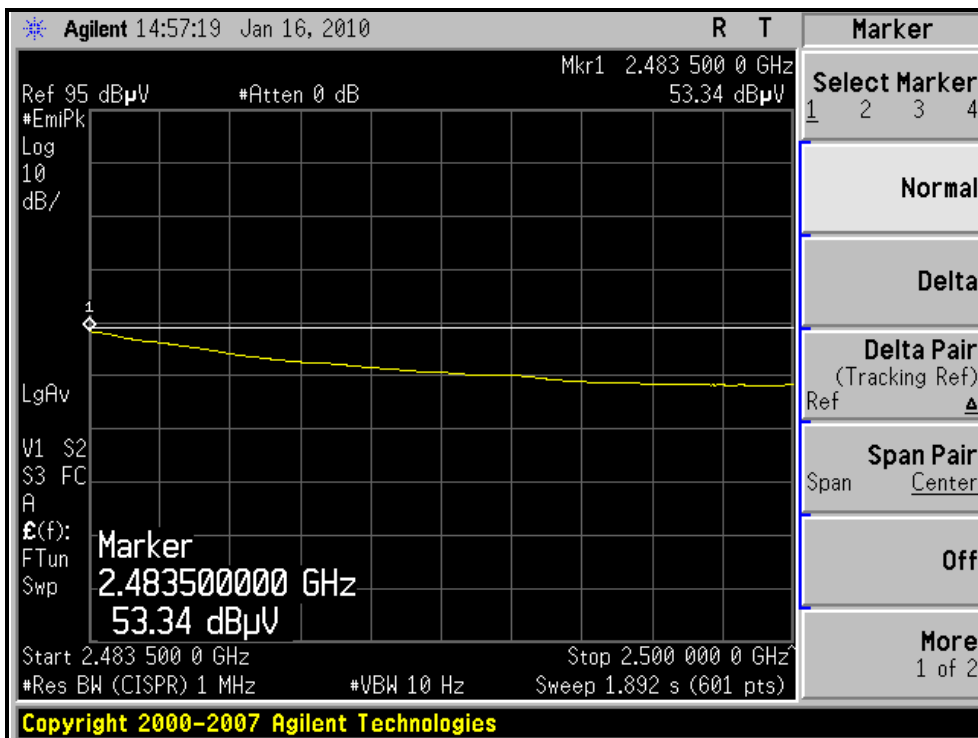
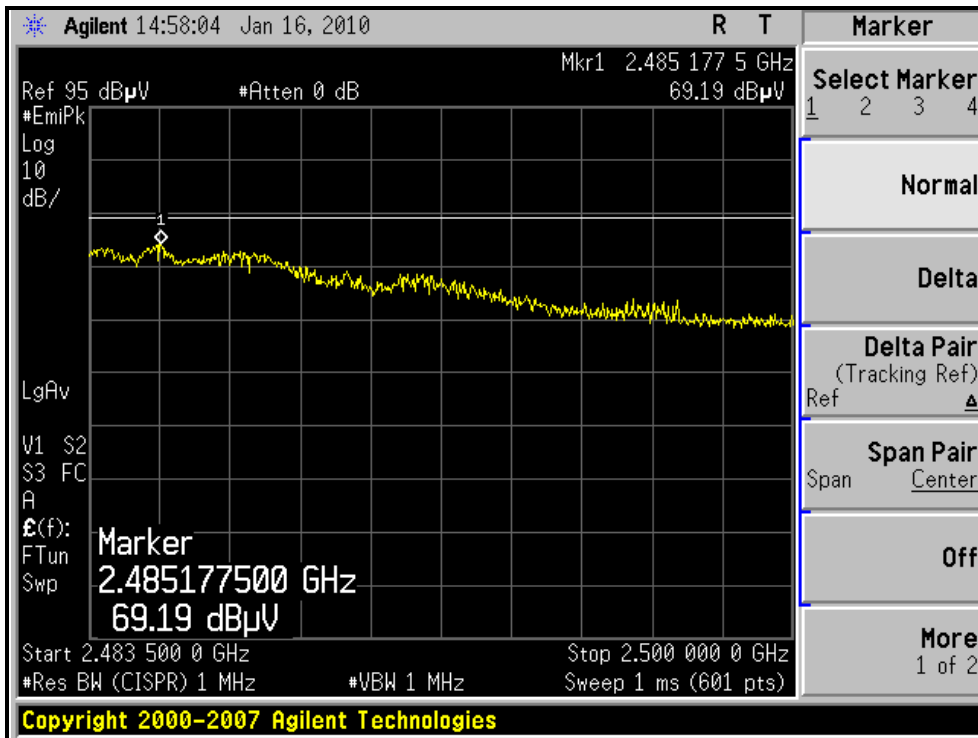



A D T

802.11n (40MHz) OFDM MODULATION

EUT TEST CONDITION		MEASUREMENT DETAIL	
CHANNEL	Channel 1	FREQUENCY RANGE	1 ~ 25GHz
INPUT POWER (SYSTEM)	120Vac, 60 Hz	DETECTOR FUNCTION	Peak (PK) Average (AV)
ENVIRONMENTAL CONDITIONS	15deg. C, 66%RH 1021 hPa	TESTED BY	Kent Liu

ANTENNA POLARITY & TEST DISTANCE: HORIZONTAL AT 3 M

NO.	FREQ. (MHz)	EMISSION LEVEL (dBuV/m)	LIMIT (dBuV/m)	MARGIN (dB)	ANTENNA HEIGHT (m)	TABLE ANGLE (Degree)	RAW VALUE (dBuV)	CORRECTION FACTOR (dB/m)
1	2390.00	55.7 PK	74.00	-18.3	1.40 H	293	25.67	30.06
2	2390.00	43.1 AV	54.00	-10.9	1.40 H	293	13.06	30.06
3	*2422.00	96.4 PK			1.40 H	294	66.21	30.19
4	*2422.00	87.3 AV			1.40 H	294	57.11	30.19
5	4844.00	43.4 PK	74.00	-30.6	1.21 H	241	7.94	35.47
6	4844.00	32.3 AV	54.00	-21.7	1.21 H	241	-3.17	35.47

ANTENNA POLARITY & TEST DISTANCE: VERTICAL AT 3 M

NO.	FREQ. (MHz)	EMISSION LEVEL (dBuV/m)	LIMIT (dBuV/m)	MARGIN (dB)	ANTENNA HEIGHT (m)	TABLE ANGLE (Degree)	RAW VALUE (dBuV)	CORRECTION FACTOR (dB/m)
1	2388.13	61.8 PK	74.00	-12.2	1.33 V	220	31.74	30.05
2	2388.13	49.0 AV	54.00	-5.0	1.33 V	220	18.93	30.05
3	*2422.00	106.8 PK			1.33 V	153	76.61	30.19
4	*2422.00	95.9 AV			1.33 V	153	65.71	30.19
5	4844.00	42.3 PK	74.00	-31.7	1.00 V	219	6.83	35.47
6	4844.00	32.9 AV	54.00	-21.1	1.00 V	219	-2.57	35.47

- REMARKS:**
1. Emission level (dBuV/m) = Raw Value (dBuV) + Correction Factor (dB/m).
 2. Correction Factor (dB/m) = Antenna Factor (dB/m) + Cable Factor (dB).
 3. The other emission levels were very low against the limit.
 4. Margin value = Emission level – Limit value.
 5. “ * “: Fundamental frequency.



A D T

EUT TEST CONDITION		MEASUREMENT DETAIL	
CHANNEL	Channel 4	FREQUENCY RANGE	1 ~ 25GHz
INPUT POWER (SYSTEM)	120Vac, 60 Hz	DETECTOR FUNCTION	Peak (PK) Average (AV)
ENVIRONMENTAL CONDITIONS	15deg. C, 66%RH 1021 hPa	TESTED BY	Kent Liu

ANTENNA POLARITY & TEST DISTANCE: HORIZONTAL AT 3 M

NO.	FREQ. (MHz)	EMISSION LEVEL (dBuV/m)	LIMIT (dBuV/m)	MARGIN (dB)	ANTENNA HEIGHT (m)	TABLE ANGLE (Degree)	RAW VALUE (dBuV)	CORRECTION FACTOR (dB/m)
1	*2437.00	95.9 PK			1.40 H	293	65.66	30.24
2	*2437.00	86.5 AV			1.40 H	293	56.26	30.24
3	4874.00	41.8 PK	74.00	-32.2	1.16 H	301	6.28	35.52
4	4874.00	32.0 AV	54.00	-22.0	1.16 H	301	-3.52	35.52
5	7311.00	49.8 PK	74.00	-24.2	1.33 H	201	7.84	41.96
6	7311.00	37.2 AV	54.00	-16.8	1.33 H	201	-4.76	41.96

ANTENNA POLARITY & TEST DISTANCE: VERTICAL AT 3 M

NO.	FREQ. (MHz)	EMISSION LEVEL (dBuV/m)	LIMIT (dBuV/m)	MARGIN (dB)	ANTENNA HEIGHT (m)	TABLE ANGLE (Degree)	RAW VALUE (dBuV)	CORRECTION FACTOR (dB/m)
1	2390.00	60.0 PK	74.00	-14.0	1.35 V	180	29.94	30.06
2	2390.00	46.8 AV	54.00	-7.3	1.35 V	180	16.69	30.06
3	*2437.00	106.7 PK			1.32 V	159	76.46	30.24
4	*2437.00	97.0 AV			1.32 V	159	66.76	30.24
5	2483.50	64.3 PK	74.00	-9.7	1.28 V	157	33.87	30.43
6	2483.50	51.1 AV	54.00	-2.9	1.28 V	157	20.67	30.43
7	4874.00	42.6 PK	74.00	-31.4	1.00 V	205	7.08	35.52
8	4874.00	33.4 AV	54.00	-20.6	1.00 V	205	-2.12	35.52
9	7311.00	50.3 PK	74.00	-23.7	1.25 V	278	8.34	41.96
10	7311.00	37.6 AV	54.00	-16.4	1.25 V	278	-4.36	41.96

- REMARKS:**
1. Emission level (dBuV/m) = Raw Value (dBuV) + Correction Factor (dB/m).
 2. Correction Factor (dB/m) = Antenna Factor (dB/m) + Cable Factor (dB).
 3. The other emission levels were very low against the limit.
 4. Margin value = Emission level – Limit value.
 5. “ * “: Fundamental frequency.



A D T

EUT TEST CONDITION		MEASUREMENT DETAIL	
CHANNEL	Channel 7	FREQUENCY RANGE	1 ~ 25GHz
INPUT POWER (SYSTEM)	120Vac, 60 Hz	DETECTOR FUNCTION	Peak (PK) Average (AV)
ENVIRONMENTAL CONDITIONS	15deg. C, 66%RH 1021 hPa	TESTED BY	Kent Liu

ANTENNA POLARITY & TEST DISTANCE: HORIZONTAL AT 3 M								
NO.	FREQ. (MHz)	EMISSION LEVEL (dBuV/m)	LIMIT (dBuV/m)	MARGIN (dB)	ANTENNA HEIGHT (m)	TABLE ANGLE (Degree)	RAW VALUE (dBuV)	CORRECTION FACTOR (dB/m)
1	*2452.00	94.9 PK			1.40 H	294	64.60	30.30
2	*2452.00	84.5 AV			1.40 H	294	54.20	30.30
3	2483.50	57.3 PK	74.00	-16.7	1.40 H	294	26.88	30.43
4	2483.50	43.8 AV	54.00	-10.2	1.40 H	294	13.40	30.43
5	4904.00	41.3 PK	74.00	-32.7	1.01 H	124	5.72	35.58
6	4904.00	32.6 AV	54.00	-21.4	1.01 H	124	-2.98	35.58
7	7356.00	48.8 PK	74.00	-25.2	1.30 H	241	6.77	42.04
8	7356.00	36.0 AV	54.00	-18.0	1.30 H	241	-6.00	42.04
ANTENNA POLARITY & TEST DISTANCE: VERTICAL AT 3 M								
NO.	FREQ. (MHz)	EMISSION LEVEL (dBuV/m)	LIMIT (dBuV/m)	MARGIN (dB)	ANTENNA HEIGHT (m)	TABLE ANGLE (Degree)	RAW VALUE (dBuV)	CORRECTION FACTOR (dB/m)
1	*2452.00	105.1 PK			1.32 V	158	74.80	30.30
2	*2452.00	95.3 AV			1.32 V	158	65.00	30.30
3	2485.73	66.3 PK	74.00	-7.7	1.30 V	158	35.90	30.43
4	2485.73	53.0 AV	54.00	-1.0	1.30 V	158	22.54	30.43
5	4904.00	42.9 PK	74.00	-31.1	1.34 V	147	7.32	35.58
6	4904.00	33.1 AV	54.00	-20.9	1.34 V	147	-2.48	35.58
7	7356.00	49.6 PK	74.00	-24.4	1.09 V	244	7.56	42.04
8	7356.00	36.8 AV	54.00	-17.2	1.09 V	244	-5.24	42.04

- REMARKS:**
1. Emission level (dBuV/m) = Raw Value (dBuV) + Correction Factor (dB/m).
 2. Correction Factor (dB/m) = Antenna Factor (dB/m) + Cable Factor (dB).
 3. The other emission levels were very low against the limit.
 4. Margin value = Emission level – Limit value.
 5. “ * “: Fundamental frequency.



A D T

RESTRICTED BANDEDGE (802.11n (40MHz) MODE,CH1, HORIZONTAL)

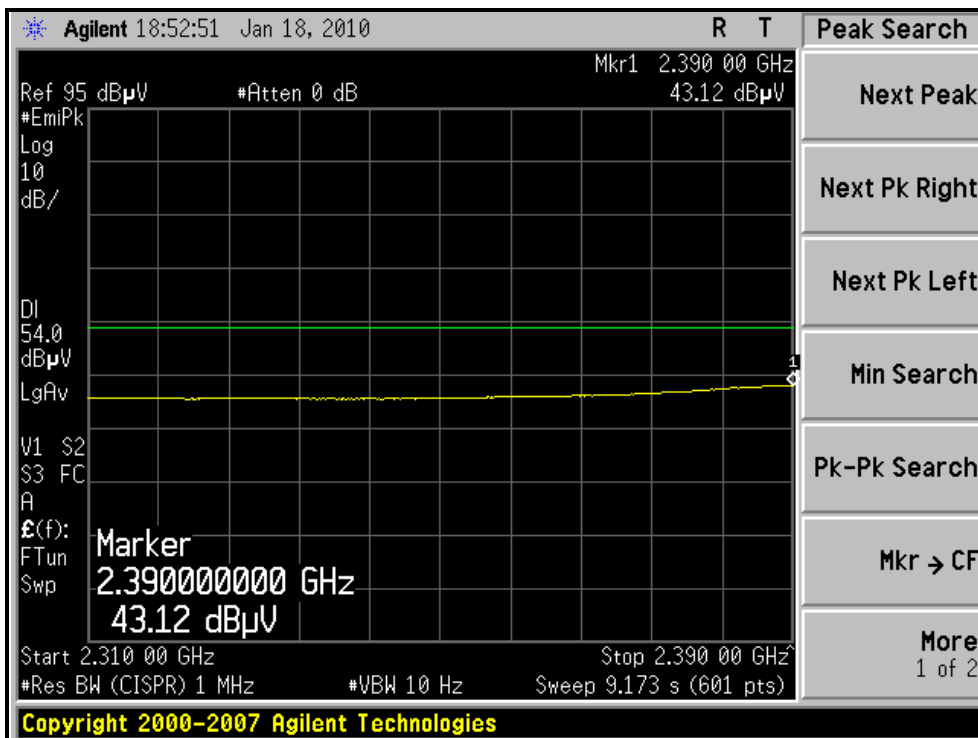
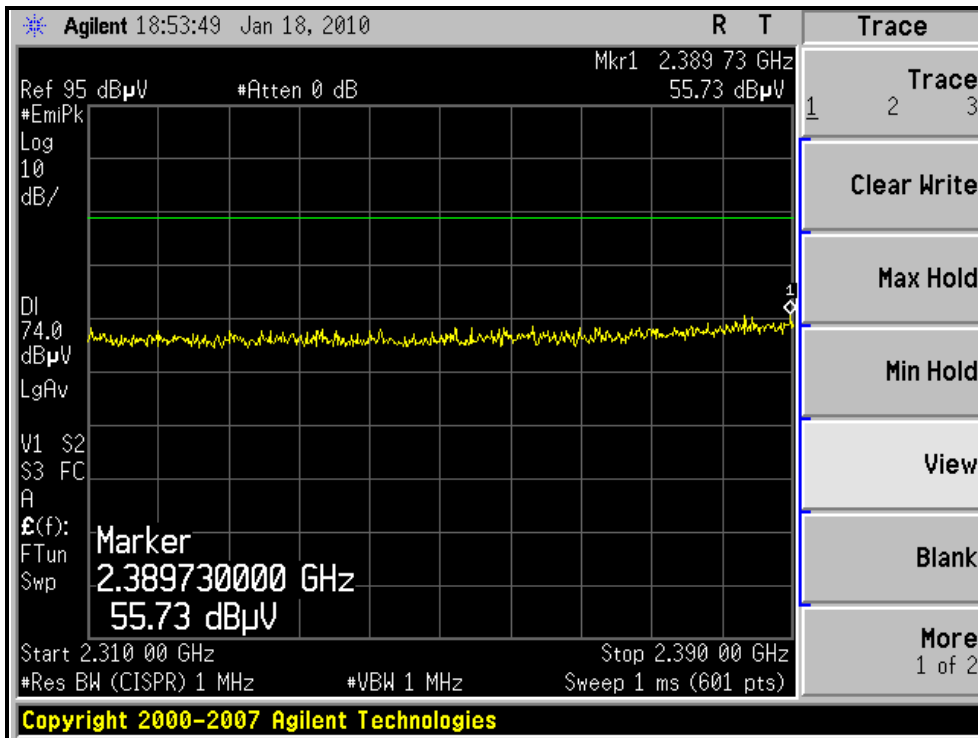



A D T

RESTRICTED BANDEDGE (802.11n (40MHz) MODE,CH1, VERTICAL)

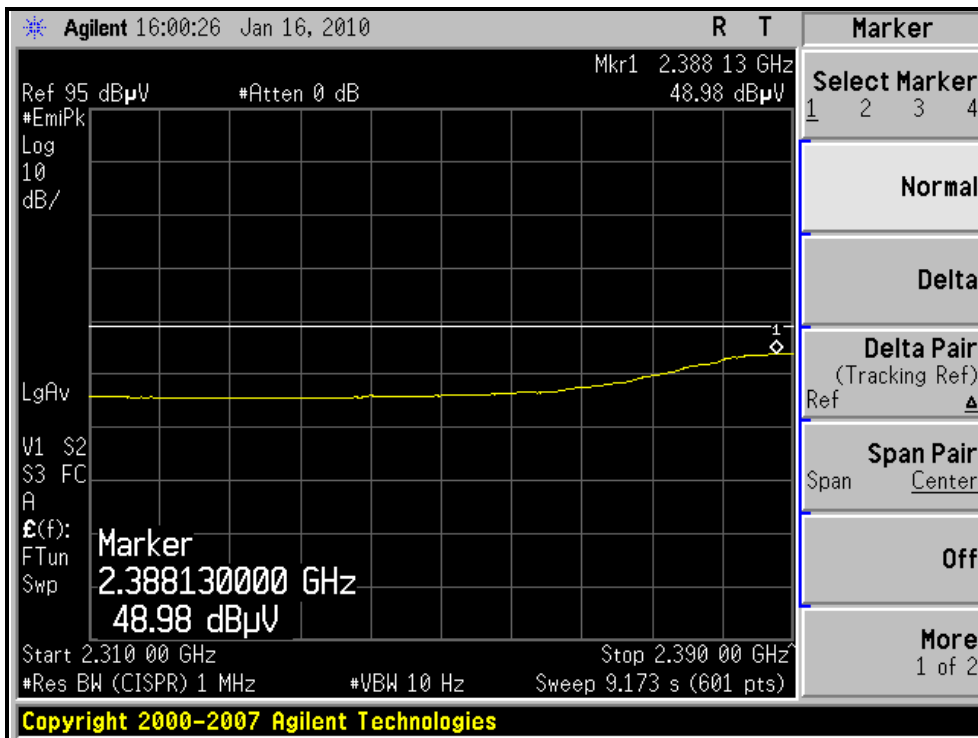
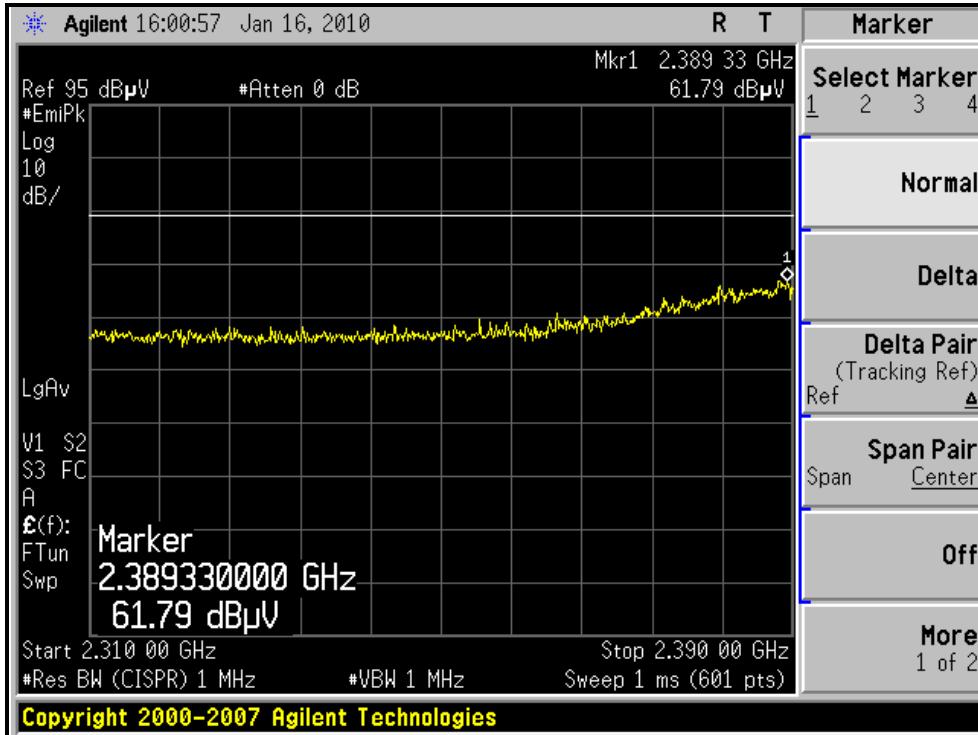



A D T

RESTRICTED BANDEDGE (802.11n (40MHz) MODE,CH7, HORIZONTAL)

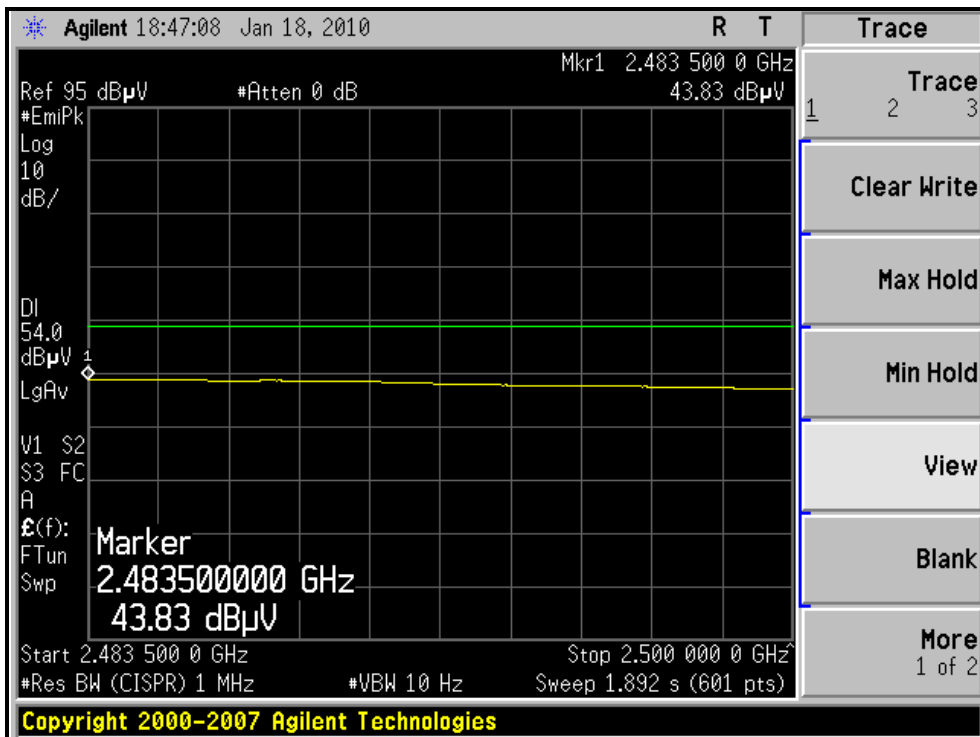
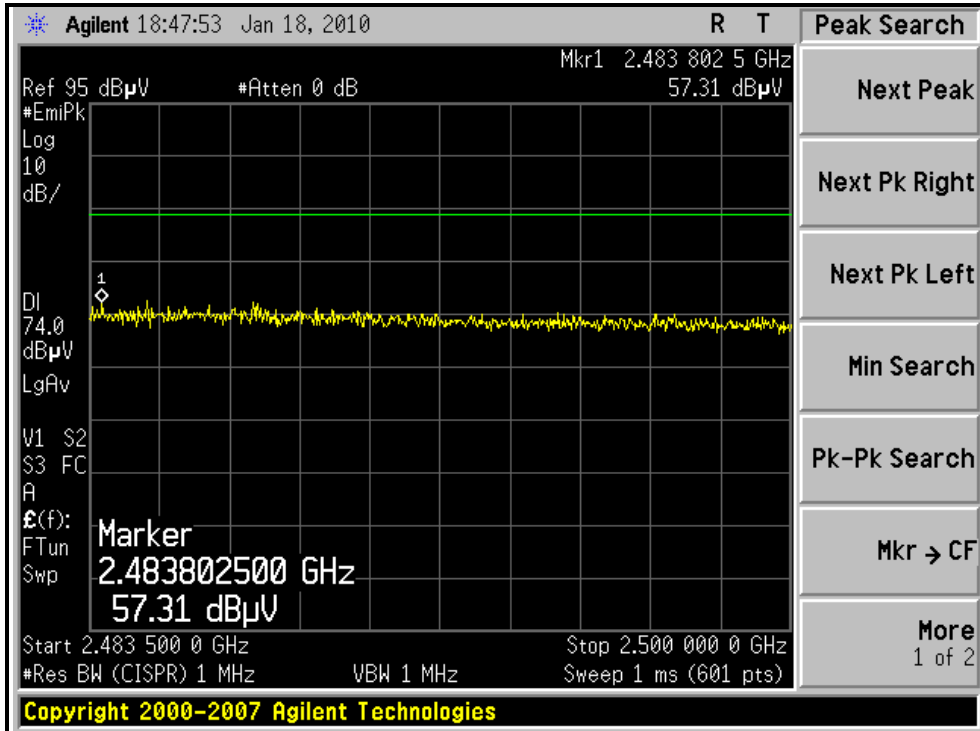



A D T

RESTRICTED BANDEDGE (802.11n (40MHz) MODE,CH7, VERTICAL)

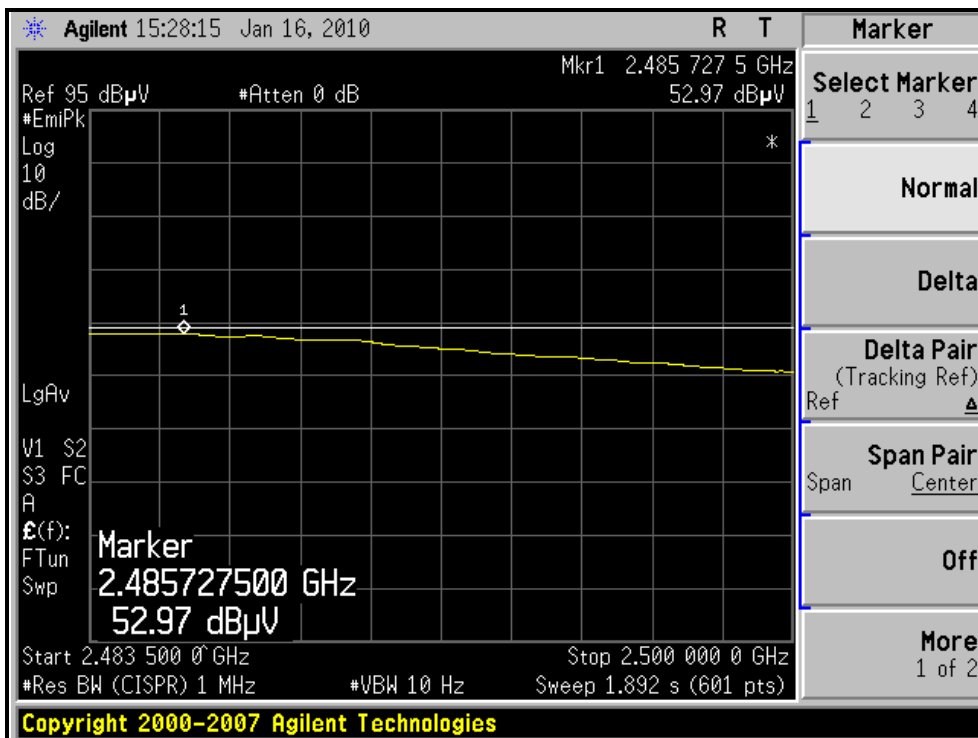
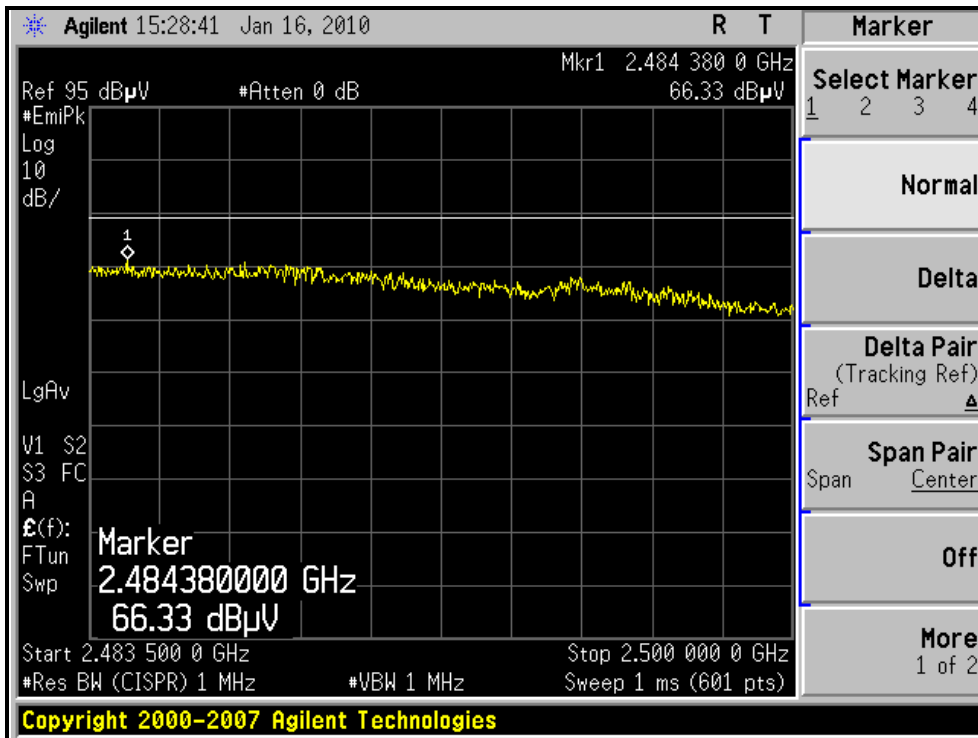

4.3 6dB BANDWIDTH MEASUREMENT

4.3.1 LIMITS OF 6dB BANDWIDTH MEASUREMENT

The minimum of 6dB Bandwidth Measurement is 0.5 MHz.

4.3.2 TEST INSTRUMENTS

DESCRIPTION & MANUFACTURER	MODEL NO.	SERIAL NO.	CALIBRATED DATE	CALIBRATED UNTIL
R&S SPECTRUM ANALYZER	FSP40	100037	Aug. 03, 2009	Aug. 02, 2010

NOTE:

- 1.The calibration interval of the above test instruments is 12 months and the calibrations are traceable to NML/ROC and NIST/USA.

4.3.3 TEST PROCEDURE

The transmitter output was connected to the spectrum analyzer through an attenuator. The bandwidth of the fundamental frequency was measured by spectrum analyzer with 100kHz RBW and 100kHz VBW. The 6dB bandwidth is defined as the total spectrum the power of which is higher than peak power minus 6dB.

4.3.4 DEVIATION FROM TEST STANDARD

No deviation

4.3.5 TEST SETUP

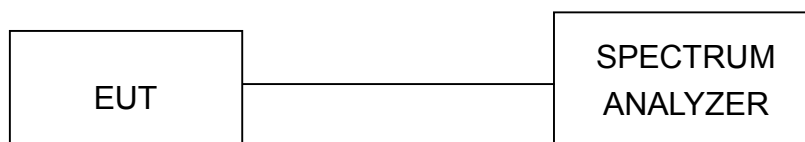

4.3.6 EUT OPERATING CONDITIONS

The software provided by client to enable the EUT under transmission condition continuously at lowest, middle and highest channel frequencies individually.



A D T

4.3.7 TEST RESULTS

802.11b DSSS MODULATION:

CHANNEL	CHANNEL FREQUENCY (MHz)	6dB BANDWIDTH (MHz)	MINIMUM LIMIT (MHz)	PASS / FAIL
1	2412	10.12	0.5	PASS
6	2437	10.09	0.5	PASS
11	2462	10.09	0.5	PASS

CH1

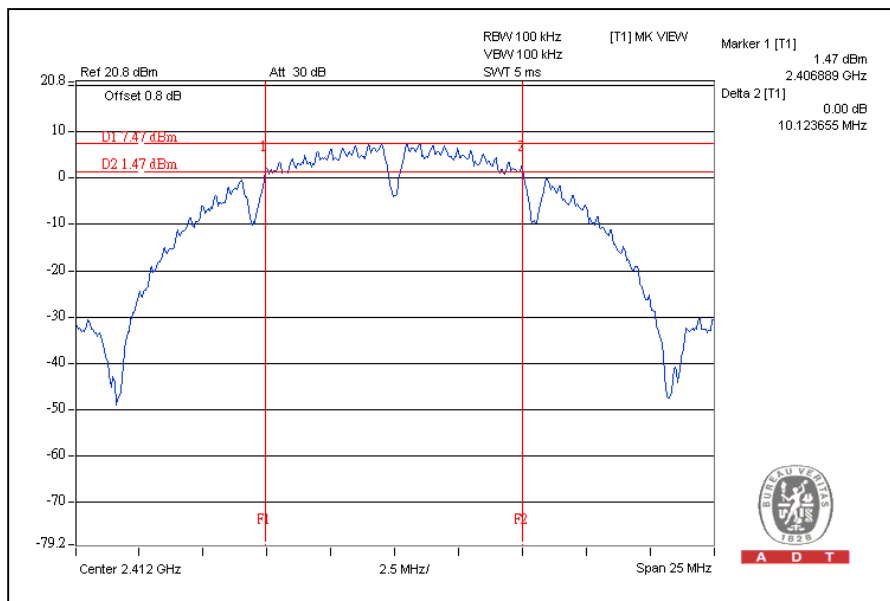

802.11g OFDM MODULATION:

CHANNEL	CHANNEL FREQUENCY (MHz)	6dB BANDWIDTH (MHz)	MINIMUM LIMIT (MHz)	PASS / FAIL
1	2412	16.57	0.5	PASS
6	2437	16.61	0.5	PASS
11	2462	16.56	0.5	PASS

CH6

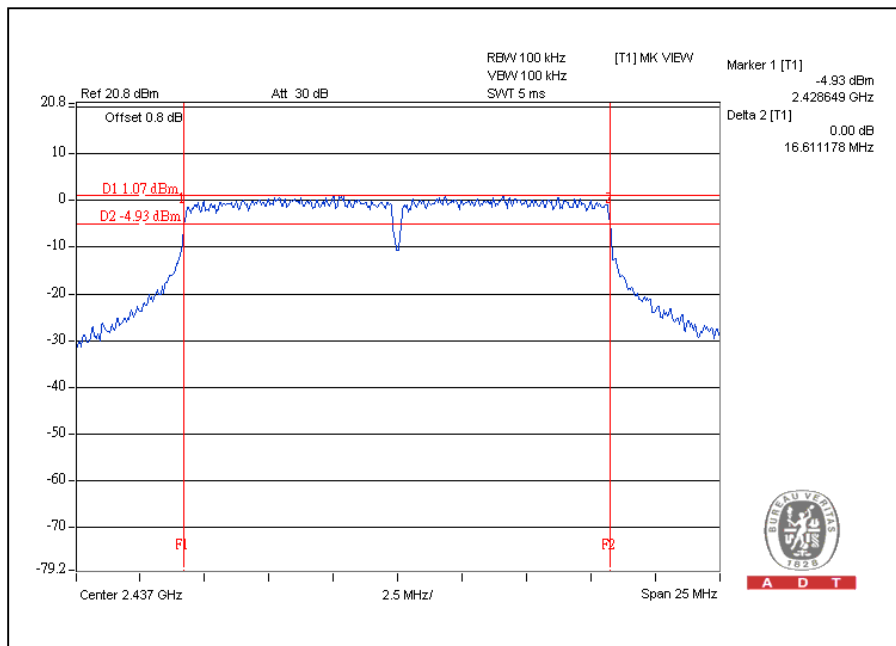



A D T

802.11n (20MHz) OFDM MODULATION:

CHANNEL	CHANNEL FREQUENCY (MHz)	6dB BANDWIDTH (MHz)	MINIMUM LIMIT (MHz)	PASS / FAIL
1	2412	17.87	0.5	PASS
6	2437	17.81	0.5	PASS
11	2462	17.81	0.5	PASS

CH1

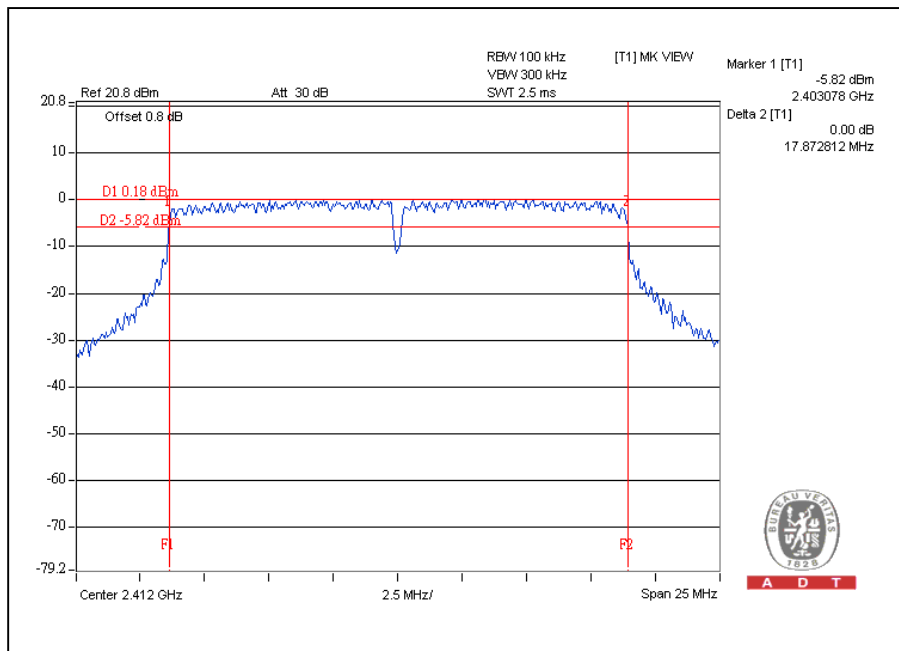

802.11n (40MHz) OFDM MODULATION:

CHANNEL	CHANNEL FREQUENCY (MHz)	6dB BANDWIDTH (MHz)	MINIMUM LIMIT (MHz)	PASS / FAIL
1	2422	36.53	0.5	PASS
4	2437	36.56	0.5	PASS
7	2452	36.53	0.5	PASS

CH4

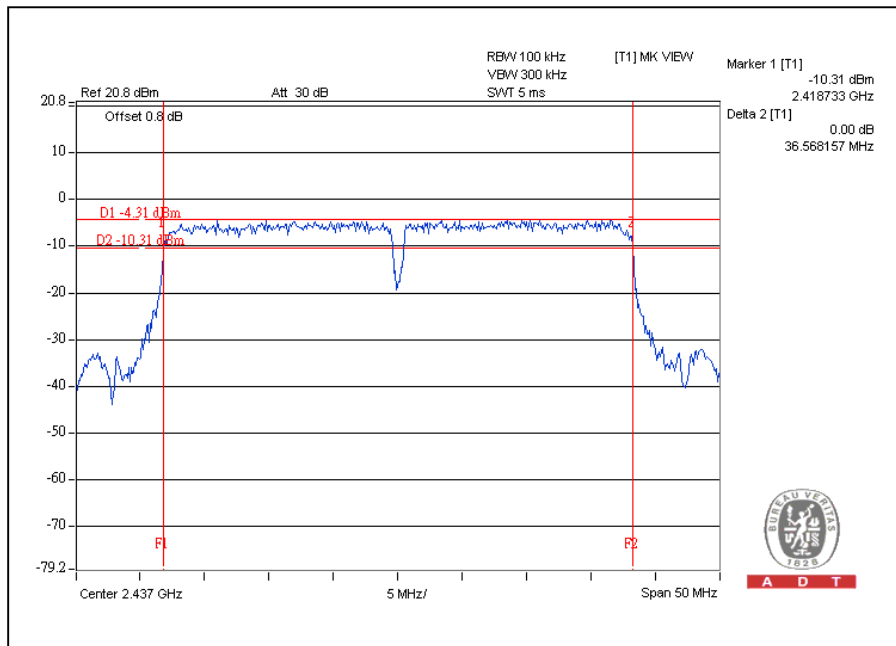

4.4 MAXIMUM PEAK OUTPUT POWER

4.4.1 LIMITS OF MAXIMUM PEAK OUTPUT POWER MEASUREMENT

The Maximum Peak Output Power Measurement is 30dBm.

4.4.2 INSTRUMENTS

DESCRIPTION & MANUFACTURER	MODEL NO.	SERIAL NO.	CALIBRATED DATE	CALIBRATED UNTIL
Anritsu Power Meter	ML2495A	0824006	April 25, 2009	April 24, 2010
Pulse Power Sensor	MA2411B	0738172	April 25, 2009	April 24, 2010

NOTE:

The calibration interval of the above test instruments is 12 months and the calibrations are traceable to NML/ROC and NIST/USA.

4.4.3 TEST PROCEDURES

1. The transmitter output was connected to the power meter through an attenuator; the bandwidth of the fundamental frequency was measured with the power meter.
2. Record the power level.

4.4.4 DEVIATION FROM TEST STANDARD

No deviation

4.4.5 TEST SETUP

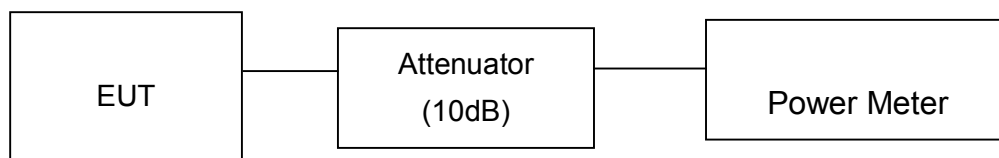

4.4.6 EUT OPERATING CONDITIONS

Same as Item 4.3.6



A D T

4.4.7 TEST RESULTS

802.11b DSSS MODULATION:

CHANNEL	CHANNEL FREQUENCY (MHz)	PEAK POWER OUTPUT (dBm)	PEAK POWER OUTPUT (mW)	PEAK POWER LIMIT (dBm)	PASS / FAIL
1	2412	21.40	138.000	30	PASS
6	2437	21.20	131.800	30	PASS
11	2462	21.30	134.900	30	PASS

802.11g OFDM MODULATION:

CHANNEL	CHANNEL FREQUENCY (MHz)	PEAK POWER OUTPUT (dBm)	PEAK POWER OUTPUT (mW)	PEAK POWER LIMIT (dBm)	PASS / FAIL
1	2412	24.60	288.400	30	PASS
6	2437	24.40	275.400	30	PASS
11	2462	24.30	269.200	30	PASS

802.11n (20MHz) OFDM MODULATION:

CHANNEL	CHANNEL FREQUENCY (MHz)	PEAK POWER OUTPUT (dBm)		TOTAL PEAK POWER (mW)	TOTAL PEAK POWER (dBm)	PEAK POWER LIMIT (dBm)	PASS / FAIL
		CHAIN(0)	CHAIN(1)				
1	2412	23.70	24.50	516.300	27.10	30	PASS
6	2437	23.80	23.50	463.800	26.70	30	PASS
11	2462	23.40	22.90	413.800	26.20	30	PASS



A D T

802.11n (40MHz) OFDM MODULATION:

CHANNEL	CHANNEL FREQUENCY (MHz)	PEAK POWER OUTPUT (dBm)		TOTAL PEAK POWER (mW)	TOTAL PEAK POWER (dBm)	PEAK POWER LIMIT (dBm)	PASS / FAIL
		CHAIN(0)	CHAIN(1)				
1	2422	22.90	23.10	399.200	26.00	30	PASS
4	2437	23.30	23.00	413.300	26.20	30	PASS
7	2452	22.80	22.10	352.700	25.50	30	PASS

4.5 POWER SPECTRAL DENSITY MEASUREMENT

4.5.1 LIMITS OF POWER SPECTRAL DENSITY MEASUREMENT

The Maximum of Power Spectral Density Measurement is 8dBm.

4.5.2 TEST INSTRUMENTS

DESCRIPTION & MANUFACTURER	MODEL NO.	SERIAL NO.	CALIBRATED DATE	CALIBRATED UNTIL
R&S SPECTRUM ANALYZER	FSP40	100037	Aug. 03, 2009	Aug. 02, 2010

NOTE:

- 1.The calibration interval of the above test instruments is 12 months and the calibrations are traceable to NML/ROC and NIST/USA.

4.5.3 TEST PROCEDURE

The transmitter output was connected to the spectrum analyzer through an attenuator, the bandwidth of the fundamental frequency was measured with the spectrum analyzer using 3kHz RBW and 30kHz VBW, set sweep time = span/3kHz. The power spectral density was measured and recorded.

The sweep time is allowed to be longer than span/3kHz for a full response of the mixer in the spectrum analyzer.

4.5.4 DEVIATION FROM TEST STANDARD

No deviation

4.5.5 TEST SETUP

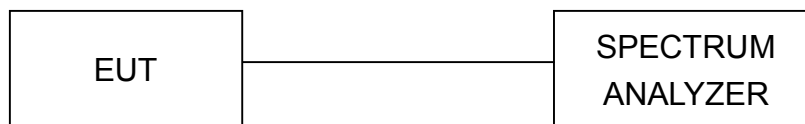

4.5.6 EUT OPERATING CONDITION

Same as Item 4.3.6



A D T

4.5.7 TEST RESULTS

802.11b DSSS MODULATION:

CHANNEL	CHANNEL FREQUENCY (MHz)	RF POWER LEVEL IN 3kHz BW (dBm)	MAXIMUM LIMIT (dBm)	PASS / FAIL
1	2412	-12.0	8	PASS
6	2437	-12.3	8	PASS
11	2462	-12.0	8	PASS

CH1

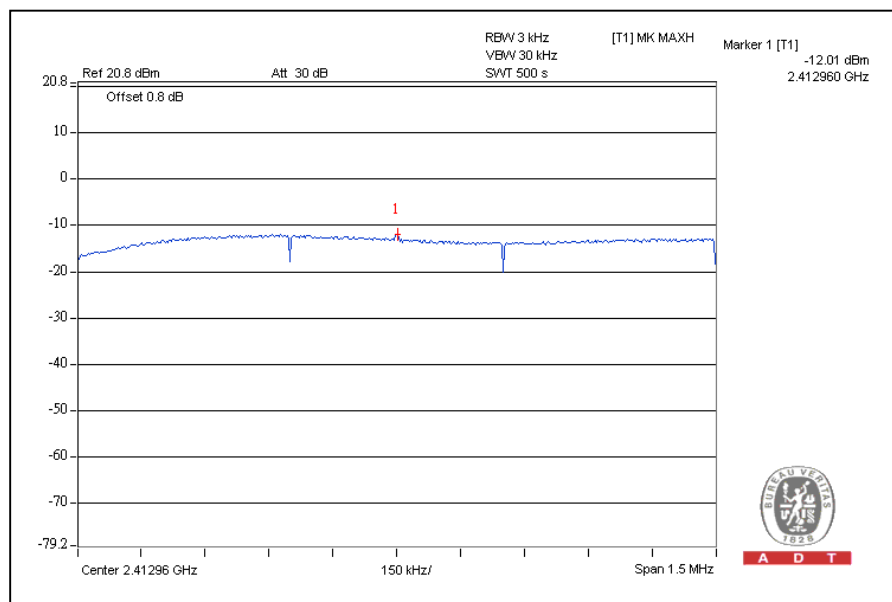



A D T

802.11g OFDM MODULATION:

CHANNEL	CHANNEL FREQUENCY (MHz)	RF POWER LEVEL IN 3kHz BW (dBm)	MAXIMUM LIMIT (dBm)	PASS / FAIL
1	2412	-12.8	8	PASS
6	2437	-13.3	8	PASS
11	2462	-14.6	8	PASS

CH1

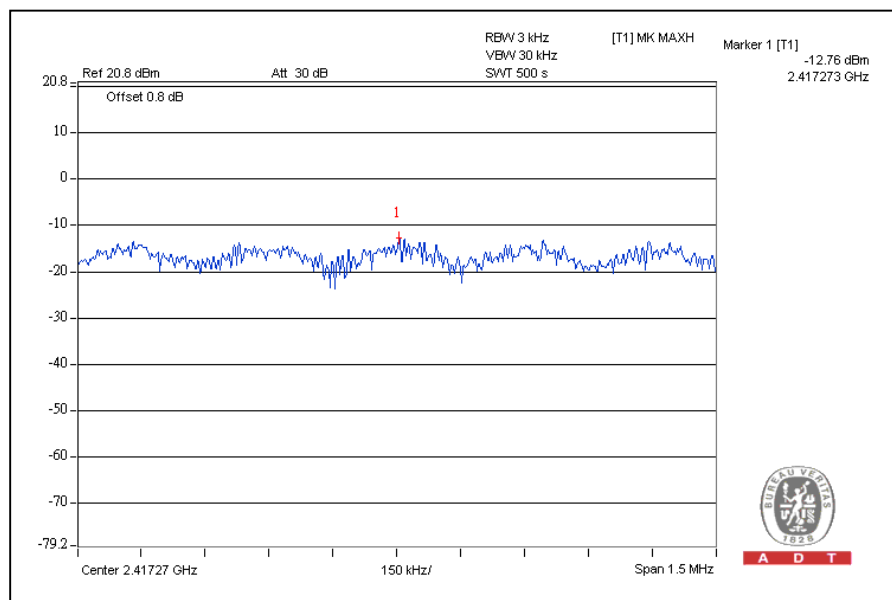

802.11n (20MHz) OFDM MODULATION:

CHANNEL	CHANNEL FREQUENCY (MHz)	RF POWER LEVEL IN 3kHz BW (dBm)		TOTAL POWER DENSITY (dBm)	MAXIMUM LIMIT (dBm)	PASS / FAIL
		CHAIN(0)	CHAIN(1)			
1	2412	-13.9	-15.0	-11.4	8	PASS
6	2437	-13.0	-14.1	-10.5	8	PASS
11	2462	-14.9	-16.8	-12.7	8	PASS

For Chain (1): CH6

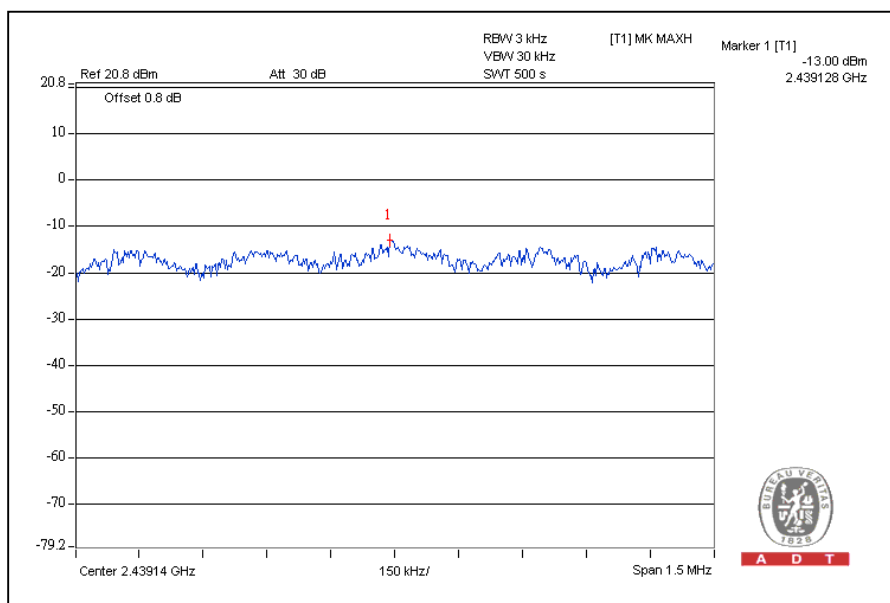

802.11n (40MHz) OFDM MODULATION:

CHANNEL	CHANNEL FREQUENCY (MHz)	RF POWER LEVEL IN 3kHz BW (dBm)		TOTAL POWER DENSITY (dBm)	MAXIMUM LIMIT (dBM)	PASS / FAIL
		CHAIN(0)	CHAIN(1)			
1	2422	-16.50	-17.40	-13.90	8	PASS
4	2437	-16.00	-17.50	-13.70	8	PASS
7	2452	-17.10	-19.60	-15.20	8	PASS

For Chain (1): CH4

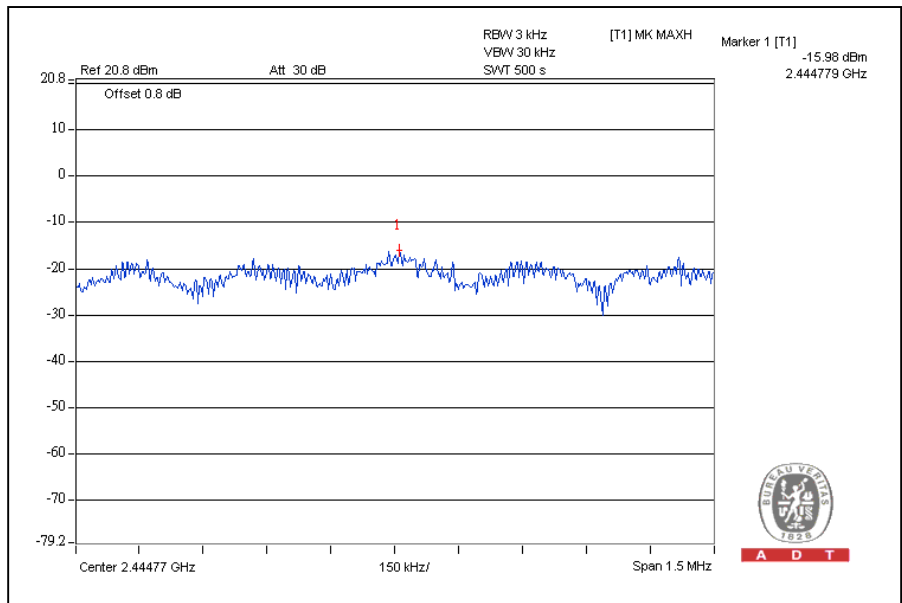

4.6 CONDUCTED OUT-BAND EMISSION MEASUREMENT

4.6.1 LIMITS OF CONDUCTED OUT-BAND EMISSION MEASUREMENT

Below -20dB of the highest emission level of operating band (in 100kHz Resolution Bandwidth).

4.6.2 TEST INSTRUMENTS

DESCRIPTION & MANUFACTURER	MODEL NO.	SERIAL NO.	CALIBRATED DATE	CALIBRATED UNTIL
R&S SPECTRUM ANALYZER	FSP40	100037	Aug. 03, 2009	Aug. 02, 2010

NOTE:

1. The calibration interval of the above test instruments is 12 months and the calibrations are traceable to NML/ROC and NIST/USA.

4.6.3 TEST PROCEDURE

The transmitter output was connected to the spectrum analyzer via a low loss cable. Set RBW of spectrum analyzer to 100kHz and VBW of spectrum analyzer to 300kHz with suitable frequency span including 100 MHz bandwidth from band edge. The band edges was measured and recorded.

The spectrum plots (RBW = 100kHz, VBW = 300kHz) are attached on the following pages.

4.6.4 DEVIATION FROM TEST STANDARD

No deviation

4.6.5 EUT OPERATING CONDITION

Same as Item 4.3.6

4.6.6 TEST RESULTS

The spectrum plots are attached on the following images. D1 line indicates the highest level, and D2 line indicates the 20dB offset below D1. It shows compliance with the requirement in part 15.247(d).

802.11b DSSS MODULATION:

CH1

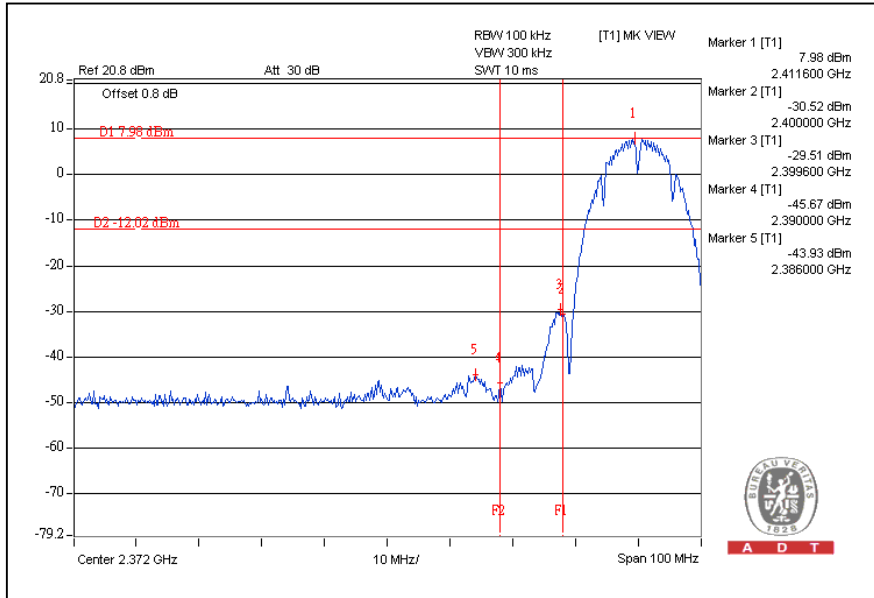

CH11

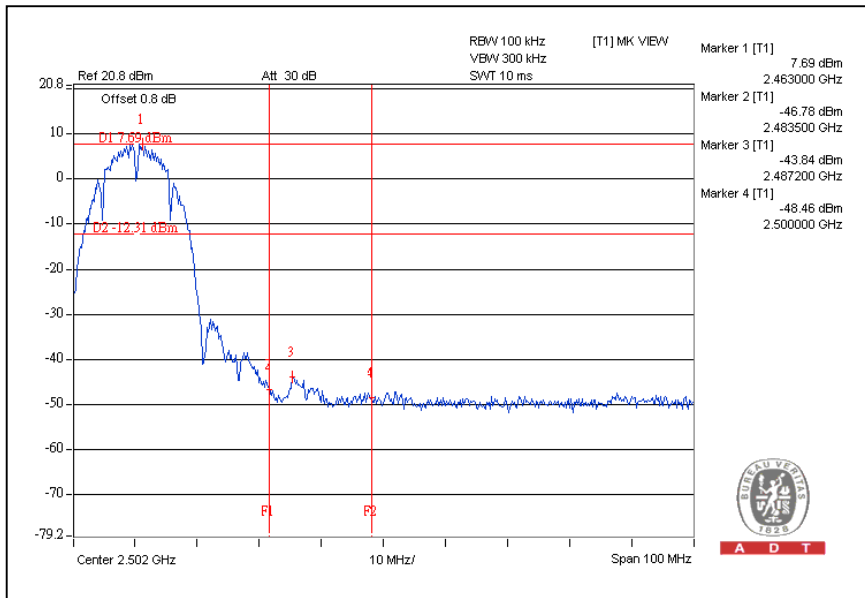



A D T

CH1

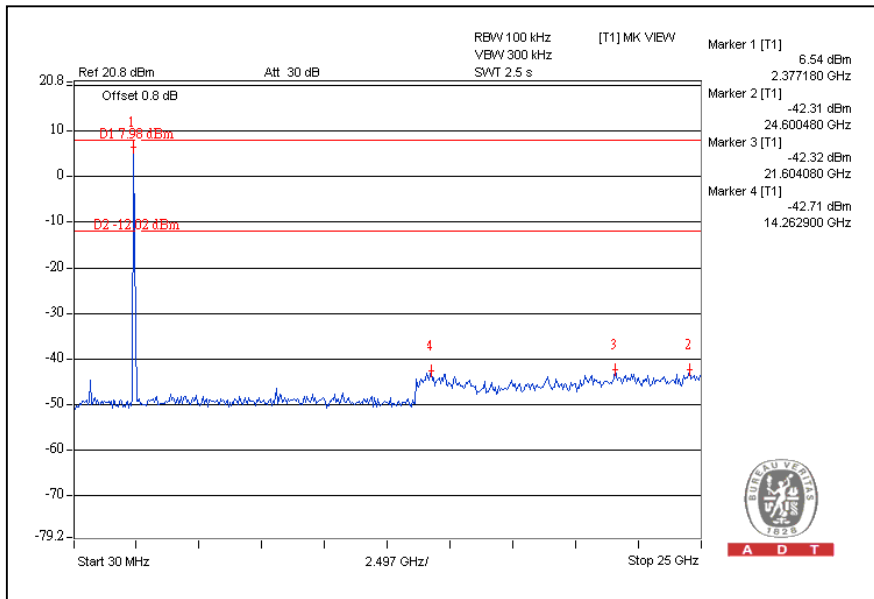

CH11

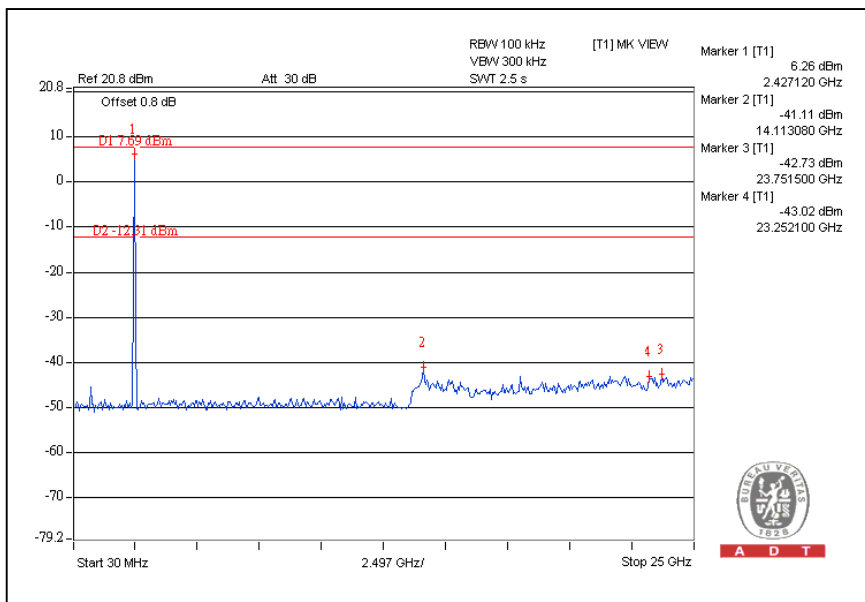

802.11g OFDM MODULATION:

CH1

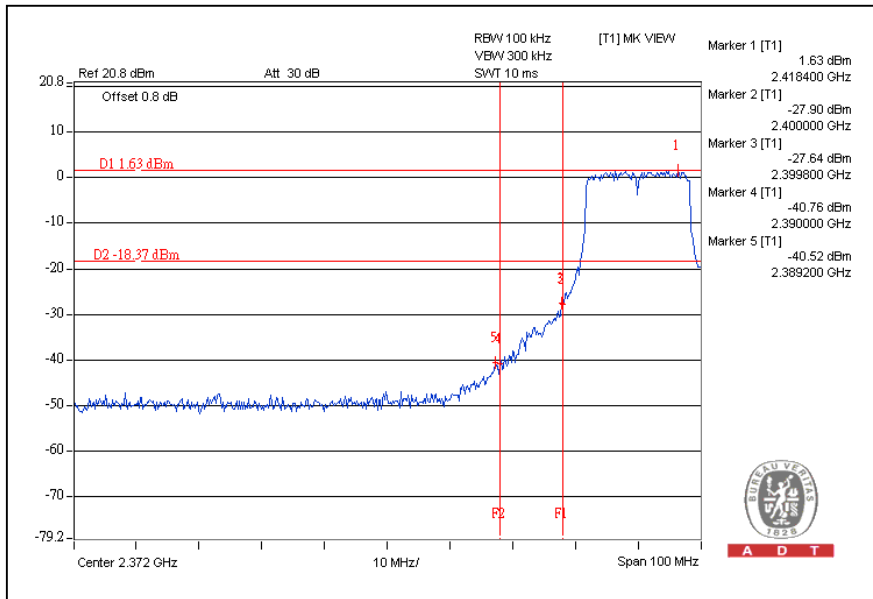

CH11

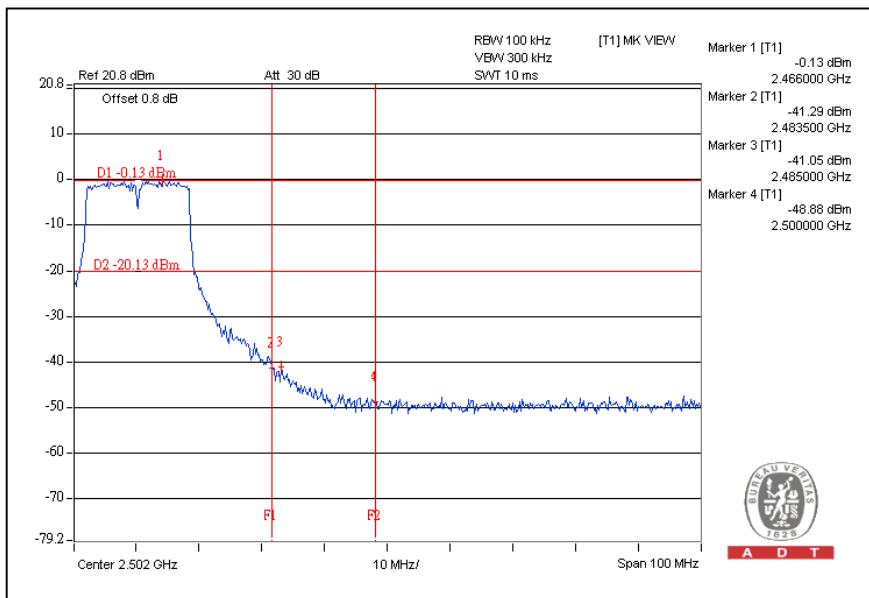



A D T

CH1

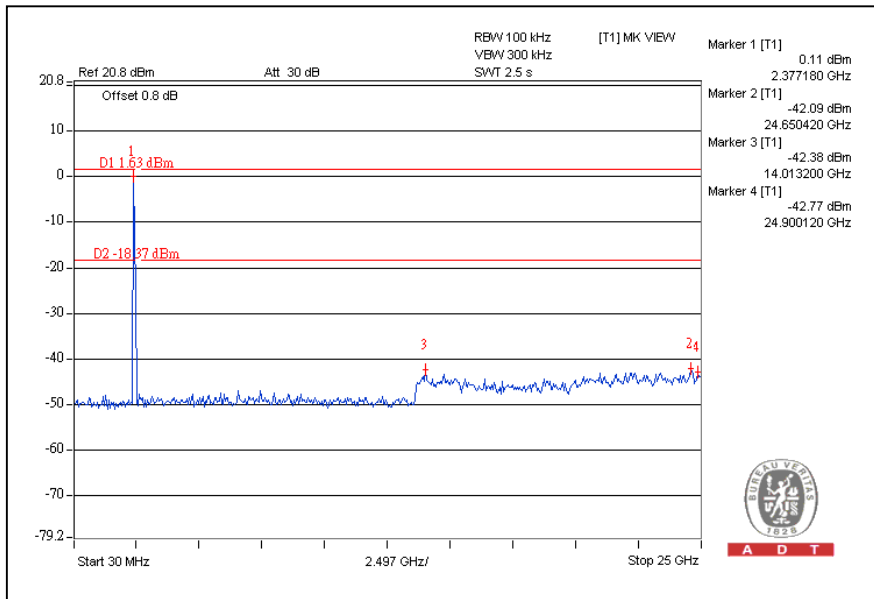

CH11

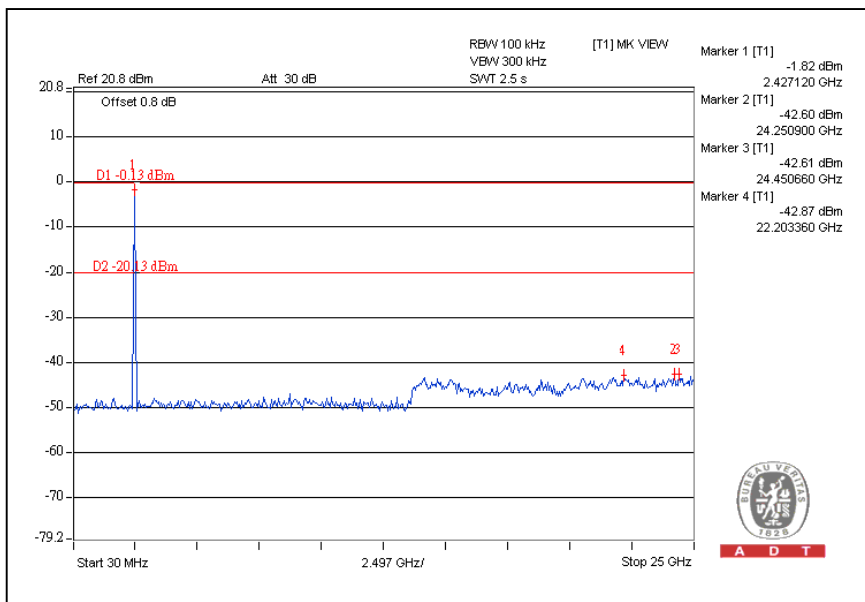

802.11n (20MHz) OFDM MODULATION:

CH1

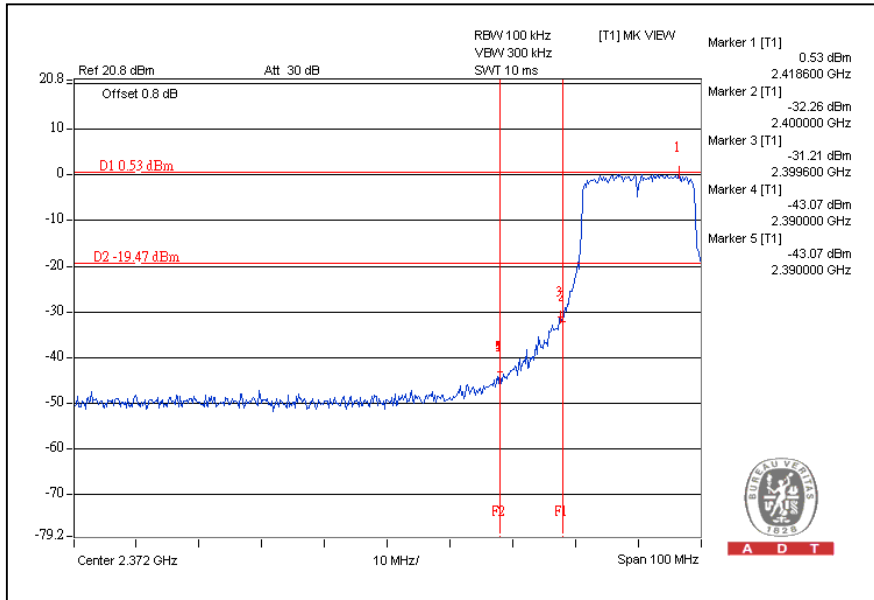

CH11

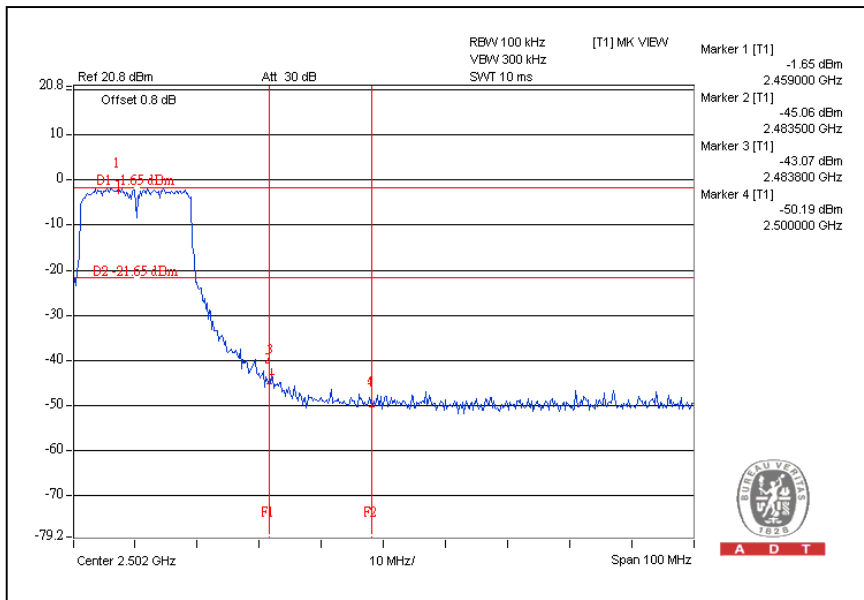



A D T

CH1

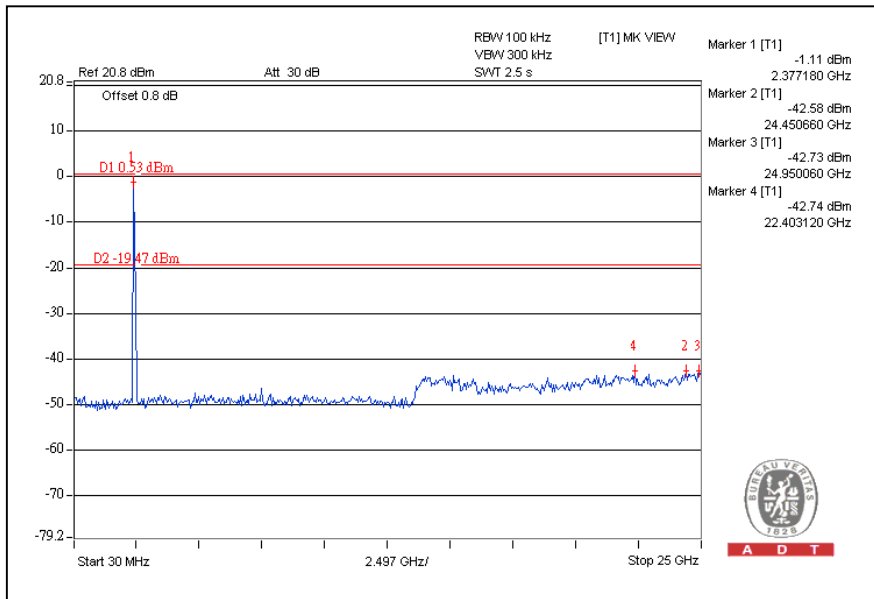

CH11

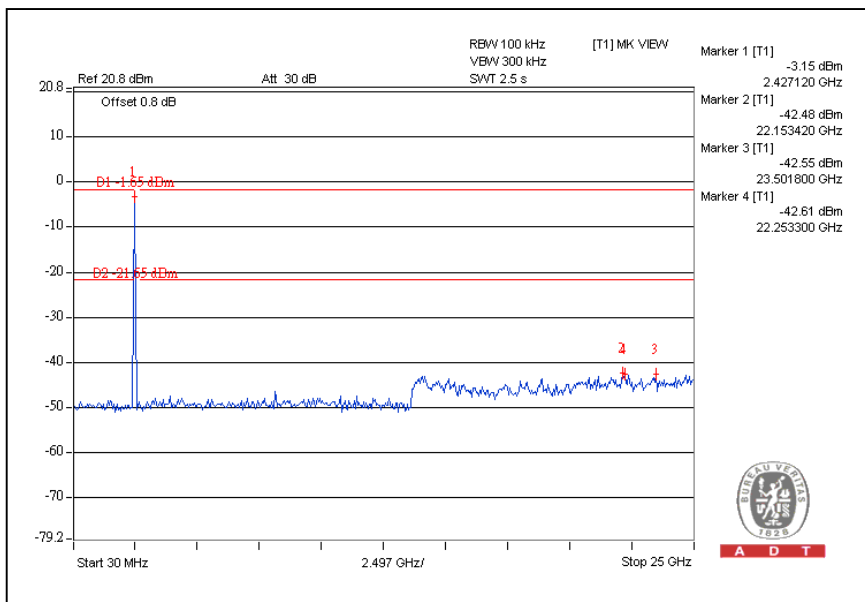

802.11n (40MHz) OFDM MODULATION:

CH1

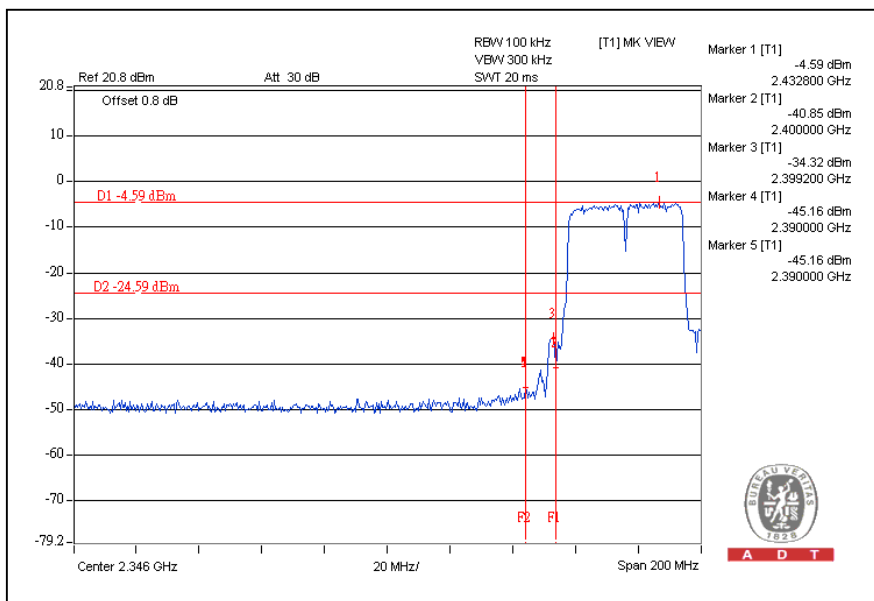

CH7

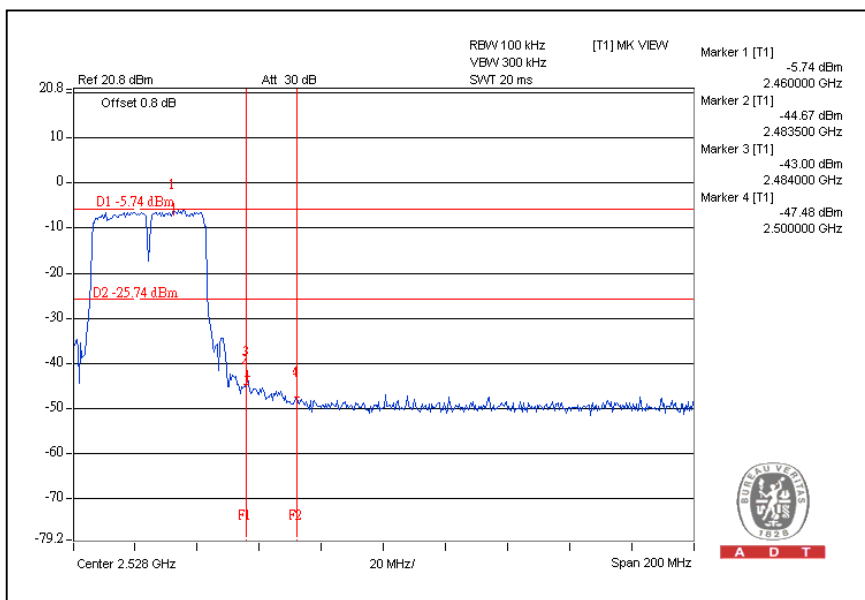



A D T

CH1

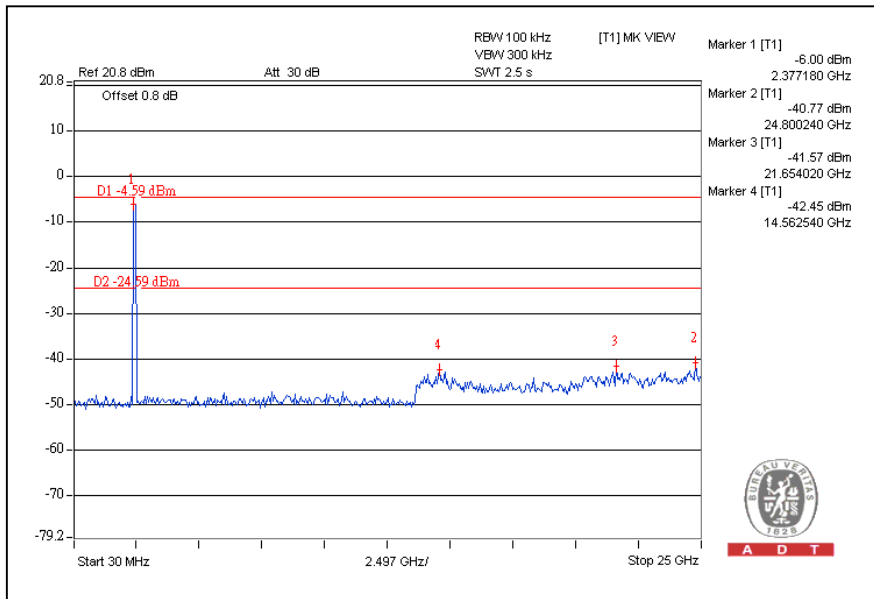

CH7

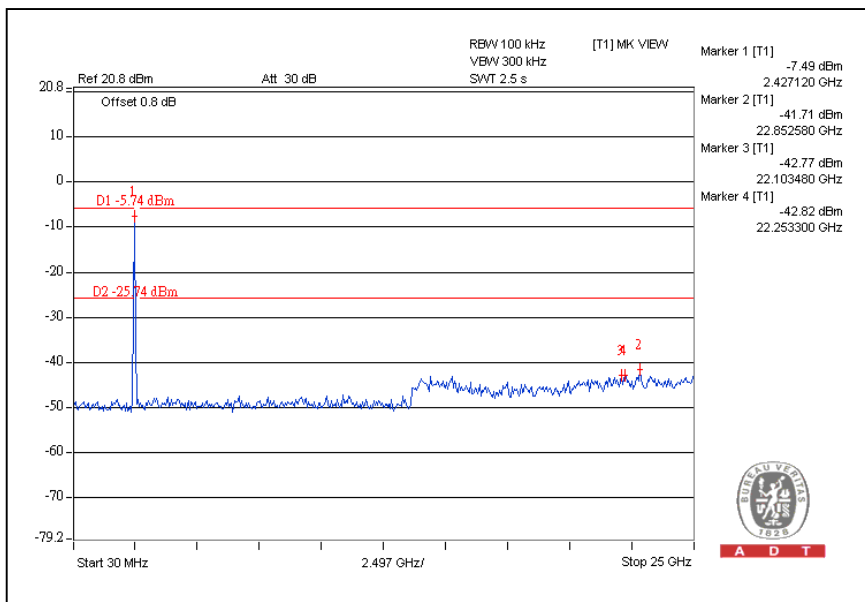



5. INFORMATION ON THE TESTING LABORATORIES

We, Bureau Veritas Consumer Products Services (H.K.) Ltd., Taoyuan Branch, were founded in 1988 to provide our best service in EMC, Radio, Telecom and Safety consultation. Our laboratories are accredited and approved according to ISO/IEC 17025:

Copies of accreditation certificates of our laboratories obtained from approval agencies can be downloaded from our web site: www.adt.com.tw/index.5/phtml. If you have any comments, please feel free to contact us at the following:

Linko EMC/RF Lab:

Tel: 886-2-26052180

Fax: 886-2-26052943

Hsin Chu EMC/RF Lab:

Tel: 886-3-5935343

Fax: 886-3-5935342

Hwa Ya EMC/RF/Safety/Telecom Lab:

Tel: 886-3-3183232

Fax: 886-3-3185050

Email: service@adt.com.tw

Web Site: www.adt.com.tw

The address and road map of all our labs can be found in our web site also.



A D T

6.APPENDIX A - MODIFICATIONS RECORDERS FOR ENGINEERING CHANGES TO THE EUT BY THE LAB

No any modifications are made to the EUT by the lab during the test.

--- END ---