



Neutron Engineering Inc.

FCC&IC Radio Test Report

FCC ID: X5B-PL6422A

IC: 8814A-PL6422A

This report concerns (check one): Original Grant Class II Change

Issued Date : Jul. 12, 2013
Project No. : 1306C235A
Equipment : AFTERGLOW PS3 WIRELESS DONGLE
Model Name : PL-6422A
Applicant : Performance Designed Products, LLC
Address : 14144 Ventura Blvd. Suite 200, Sherman Oaks, CA 91423

Tested by: Neutron Engineering Inc. EMC Laboratory

Date of Receipt: Jun. 27, 2013

Date of Test: Jun. 27, 2013~ Jul. 11, 2013

Testing Engineer : David Mao
(David Mao)

Technical Manager : Leo Hung
(Leo Hung)

Authorized Signatory : Steven Lu
(Steven Lu)

Neutron Engineering Inc.

**No.3, Jinshagang 1st Road, ShiXia, Dalang
Town, Dong Guan, China.
TEL : (0769) 8318-3000 FAX : (0769) 8319-6000**



Declaration

Neutron represents to the client that testing is done in accordance with standard procedures as applicable and that test instruments used has been calibrated with the standards traceable to National Measurement Laboratory (**NML**) of **CHINA**, or National Institute of Standards and Technology (**NIST**) of **U.S.A.**

Neutron's reports apply only to the specific samples tested under conditions. It is manufacture's responsibility to ensure that additional production units of this model are manufactured with the identical electrical and mechanical components. **Neutron** shall have no liability for any declarations, inferences or generalizations drawn by the client or others from **Neutron** issued reports.

Neutron's reports must not be used by the client to claim product endorsement by the authorities or any agency of the Government.

This report is the confidential property of the client. As a mutual protection to the clients, the public and **Neutron-self**, extracts from the test report shall not be reproduced except in full with **Neutron's** authorized written approval.

Neutron's laboratory quality assurance procedures are in compliance with the **ISO Guide 17025** requirements, and accredited by the conformity assessment authorities listed in this test report.

Limitation

For the use of the authority's logo is limited unless the Test Standard(s)/Scope(s)/Item(s) mentioned in this test report is (are) included in the conformity assessment authorities acceptance respective.



Table of Contents	Page
1 . CERTIFICATION	5
2 . SUMMARY OF TEST RESULTS	6
2.1 TEST FACILITY	7
2.2 MEASUREMENT UNCERTAINTY	7
3 . GENERAL INFORMATION	8
3.1 GENERAL DESCRIPTION OF EUT	8
3.2 DESCRIPTION OF TEST MODES	10
3.3 TABLE OF PARAMETERS OF TEXT SOFTWARE SETTING	10
3.4 BLOCK DIGRAM SHOWING THE CONFIGURATION OF SYSTEM TESTED	11
3.5 DESCRIPTION OF SUPPORT UNITS	12
4 . EMC EMISSION TEST	13
4.1 CONDUCTED EMISSION MEASUREMENT	13
4.1.1 POWER LINE CONDUCTED EMISSION LIMITS	13
4.1.2 MEASUREMENT INSTRUMENTS LIST AND SETTING	13
4.1.3 TEST PROCEDURE	14
4.1.4 DEVIATION FROM TEST STANDARD	14
4.1.5 TEST SETUP	14
4.1.6 EUT OPERATING CONDITIONS	14
4.1.7 TEST RESULTS	15
4.2 RADIATED EMISSION MEASUREMENT	18
4.2.1 RADIATED EMISSION LIMITS	18
4.2.2 MEASUREMENT INSTRUMENTS LIST ANS SETTING	19
4.2.3 TEST PROCEDURE	20
4.2.4 DEVIATION FROM TEST STANDARD	20
4.2.5 TEST SETUP	21
4.2.6 EUT OPERATING CONDITIONS	22
4.2.7 TEST RESULTS (BETWEEN30 – 1000 MHZ)	24
4.2.8 TEST RESULTS (ABOVE 1000 MHZ)	31
5 . NUMBER OF HOPPING CHANNEL	43
5.1 APPLIED PROCEDURES / LIMIT	43
5.1.1 MEASUREMENT INSTRUMENTS LIST AND SETTING	43
5.1.2 TEST PROCEDURE	43
5.1.3 DEVIATION FROM STANDARD	43
5.1.4 TEST SETUP	43
5.1.5 EUT OPERATION CONDITIONS	43
5.1.6 TEST RESULTS	44
6 . AVERAGE TIME OF OCCUPANCY	45



Table of Contents	Page
6.1 APPLIED PROCEDURES / LIMIT	45
6.1.1 MEASUREMENT INSTRUMENTS LIST	45
6.1.2 TEST PROCEDURE	45
6.1.3. TEST SETUP LAYOUT	45
6.1.4. TEST DEVIATION	45
6.1.5. EUT OPERATION DURING TEST	45
6.1.6. TEST RESULTS	46
7 . HOPPING CHANNEL SEPARATION MEASUREMENT	48
7.1 APPLIED PROCEDURES / LIMIT	48
7.1.1 MEASUREMENT INSTRUMENTS LIST AND SETTING	48
7.1.2 TEST PROCEDURE	48
7.1.3 DEVIATION FROM STANDARD	48
7.1.4 TEST SETUP	48
7.1.5 EUT OPERATION CONDITIONS	48
7.1.6 TEST RESULTS	49
8 . BANDWIDTH TEST	50
8.1 APPLIED PROCEDURES / LIMIT	50
8.1.1 MEASUREMENT INSTRUMENTS LIST AND SETTING	50
8.1.2 TEST PROCEDURE	50
8.1.3 DEVIATION FROM STANDARD	50
8.1.4 TEST SETUP	50
8.1.5 EUT OPERATION CONDITIONS	50
8.1.6 TEST RESULTS	51
9 . PEAK OUTPUT POWER TEST	53
9.1 APPLIED PROCEDURES / LIMIT	53
9.1.1 MEASUREMENT INSTRUMENTS LIST AND SETTING	53
9.1.2 TEST PROCEDURE	53
9.1.3 DEVIATION FROM STANDARD	53
9.1.4 TEST SETUP	53
9.1.5 EUT OPERATION CONDITIONS	53
9.1.6 TEST RESULTS	54
10 . ANTENNA CONDUCTED SPURIOUS EMISSION	56
10.1 APPLIED PROCEDURES / LIMIT	56
10.1.1 MEASUREMENT INSTRUMENTS LIST AND SETTING	56
10.1.2 TEST PROCEDURE	56
10.1.3 DEVIATION FROM STANDARD	56
10.1.4 TEST SETUP	56
10.1.5 EUT OPERATION CONDITIONS	56
10.1.6 TEST RESULTS	57
11 . EUT PHOTOS	63



1. CERTIFICATION

Equipment : AFTERGLOW PS3 WIRELESS DONGLE
Brand Name : AFTERGLOW
Model Name : PL-6422A
Applicant : Performance Designed Products, LLC
Manufacturer : Performance Designed Products, LLC
Address : 14144 Ventura Blvd. Suite 200, Sherman Oaks, CA 91423
Factory : Performance Designed Products, LLC
Address : 14144 Ventura Blvd. Suite 200, Sherman Oaks, CA 91423
Date of Test : Jun. 27, 2013~ Jul. 11, 2013
Test Item : ENGINEERING SAMPLE
Standard(s) : FCC Part15, Subpart C(15.247) / ANSI C63.4 : 2009
FCC Public Notice DA 00-705, March 30, 2000.
Canada RSS-210:2010
RSS-GEN Issue 3, Dec 2010

The above equipment has been tested and found compliance with the requirement of the relative standards by Neutron Engineering Inc. EMC Laboratory.

The test data, data evaluation, and equipment configuration contained in our test report (Ref No. NEI-FICP-1-1306C235A) were obtained utilizing the test procedures, test instruments, test sites that has been accredited by the Authority of TAF according to the ISO-17025 quality assessment standard and technical standard(s).



2. SUMMARY OF TEST RESULTS

Test procedures according to the technical standard(s):

APPLIED STANDARD: 47 CFR Part 15, Subpart C; Canada RSS-210:2010				
Standard(s) Section		Test Item	Judgment	Remark
RSS-210 RSS-GEN Issue 3, Dec 2010	47 CFR Part 15			
RSS-GEN Issue 3, Dec 2010 7.2.4	15.207	Conducted Emission	PASS	
RSS-210, Issue 8, Annex 8, Section 8.5	15.247(d)	Antenna conducted Spurious Emission	PASS	
RSS-210, Issue 8, Annex 8, Section A8.1(b)	15.247 (a)(1)	Hopping Channel Separation	PASS	
RSS-210 Annex 8 (A8.1b)	15.247 (b)(1)	Peak Output Power	PASS	
RSS-210, Issue 8, Annex 8, Section 8.5	15.247(d) 15.209	Radiated Spurious Emission	PASS	
RSS-210, Issue 8, Annex 8, Section A8.1(d)	15.247 (a)(1)(iii)	Number of Hopping Frequency	PASS	
RSS-210, Issue 8, Annex 8, Section A8.1(d)	15.247 (a)(1)(iii)	Dwell Time	PASS	
RSS-GEN Issue 3, Dec 2010 7.2.2	15.205	Restricted Bands	PASS	
RSS-210, Issue 8, Annex 8, Section A8.4	15.203	Antenna Requirement	PASS	

NOTE:

- (1) "N/A" denotes test is not applicable in this test report.
- (2) According to FCC Public Notice DA 00-705, March 30, 2000.



2.1 TEST FACILITY

The test facilities used to collect the test data in this report is **DG-C02/DG-CB03** at the location of No.3,Jinshagang 1st Road, ShiXia, Dalang Town, Dong Guan, China.523792
 Neutron's test firm number for FCC 319330

2.2 MEASUREMENT UNCERTAINTY

Where relevant, the following measurement uncertainty levels have been estimated for tests performed on the EUT as specified in CISPR 16-4-2:

The reported uncertainty of measurement $y \pm U$ where expanded uncertainty **U** is based on a standard uncertainty multiplied by a coverage factor of **k=2**, providing a level of confidence of approximately **95 %**.

A. Conducted Measurement :

Test Site	Method	Measurement Frequency Range	U , (dB)	NOTE
DG-C02	CISPR	150 KHz ~ 30MHz	1.94	

B. Radiated Measurement :

Test Site	Method	Measurement Frequency Range	Ant. H / V	U,(dB)	NOTE
DG-CB03	CISPR	9K~30MHz	V	3.79	
		9K~30MHz	H	3.57	
		30MHz ~ 200MHz	V	3.82	
		30MHz ~ 200MHz	H	3.60	
		200MHz ~ 1,000MHz	V	3.86	
		200MHz ~ 1,000MHz	H	3.94	
		1GHz~18GHz	V	3.12	
		1GHz~18GHz	H	3.68	
		18GHz~40GHz	V	4.15	
		18GHz~40GHz	H	4.14	



3. GENERAL INFORMATION

3.1 GENERAL DESCRIPTION OF EUT

Equipment	AFTERGLOW PS3 WIRELESS DONGLE	
Brand Name	AFTERGLOW	
Model Name	PL-6422A	
Model Difference	N/A	
Product Description	Operation Frequency:	2409~2476MHz
	Modulation Technology:	GFSK
	Bit Rate of Transmitter:	1Mbps
	Number Of Channel	63 CH, Please see note 2. (Page 9)
	Antenna Designation:	Please see note 3. (Page 9)
	Antenna Gain(Peak)	
	Output Power:	-5.26dBm (Max)
More details of EUT technical specification, please refer to the User's Manual.		
Power Source	DC Voltage supplied from PS3 system.	
Power Rating	I/P AC 120V/60Hz O/P DC 5V	
Connecting I/O Port(s)	Please refer to the User's Manual	

Note:

1. For a more detailed features description, please refer to the manufacturer's specifications or the User's Manual.



2.

Channel	Frequency (MHz)	Channel	Frequency (MHz)	Channel	Frequency (MHz)	Channel	Frequency (MHz)
01	2409	17	2427	33	2444	49	2461
02	2411	18	2428	34	2445	50	2462
03	2412	19	2429	35	2446	51	2463
04	2413	20	2430	36	2447	52	2464
05	2414	21	2431	37	2448	53	2465
06	2415	22	2432	38	2449	54	2466
07	2416	23	2433	39	2450	55	2467
08	2417	24	2434	40	2451	56	2468
09	2418	25	2435	41	2452	57	2469
10	2419	26	2436	42	2453	58	2470
11	2420	27	2437	43	2454	59	2471
12	2421	28	2438	44	2455	60	2473
13	2422	29	2439	45	2456	61	2474
14	2423	30	2440	46	2457	62	2475
15	2425	31	2441	47	2459	63	2476
16	2426	32	2442	48	2460		

Group 1	Group 2	Group 3	Group 4	Group 5	Group 6	Group 7
2411	2425	2471	2434	2466	2473	2462
2428	2475	2409	2423	2409	2459	2454
2413	2414	2428	2452	2417	2409	2412
2466	2439	2457	2432	2442	2464	2444
2415	2449	2415	2411	2460	2439	2418
2420	2421	2426	2438	2422	2419	2450
2454	2464	2433	2465	2453	2450	2429
2423	2451	2465	2418	2430	2425	2442
2474	2427	2437	2444	2474	2432	2468
2431	2411	2463	2421	2447	2457	2440
2463	2456	2440	2471	2434	2435	2446
2433	2432	2442	2449	2412	2442	2452
2440	2473	2469	2436	2439	2413	2434
2448	2418	2445	2457	2445	2447	2460
2459	2435	2448	2465	2450	2470	2438
2426	2444	2452	2416	2462	2415	2473
2469	2460	2412	2468	2420	2475	2461
2471	2447	2455	2441	2473	2422	2416
2417	2429	2419	2426	2427	2466	2409
2419	2467	2467	2455	2469	2430	2425
2476	2441	2474	2429	2414	2455	2456
2451	2470	2422	2446	2456	2428	2421
2461	2453	2461	2475	2437	2445	2436

Note: The EUT 23 channels of each sequence, total 7 sequences are used.

3. Table for Filed Antenna

Ant.	Brand	Model Name	Antenna Type	Connector	Gain (dBi)
1	N/A	N/A	Printed	N/A	0



3.2 DESCRIPTION OF TEST MODES

To investigate the maximum EMI emission characteristics generates from EUT, the test system was pre-scanning tested base on the consideration of following EUT operation mode or test configuration mode which possible have effect on EMI emission level. Each of these EUT operation mode(s) or test configuration mode(s) mentioned above was evaluated respectively.

Pretest Mode	Description
Mode 1	TX Mode NOTE (1)
Mode 2	WIRELESS

The EUT system operated these modes were found to be the worst case during the pre-scanning test as following:

For Conducted Emission	
Final Test Mode	Description
Mode 2	WIRELESS

For Radiated Emission	
Final Test Mode	Description
Mode 1	TX Mode NOTE (1)

Note:

(1) The measurements are performed at the high, middle, low available channels.

3.3 TABLE OF PARAMETERS OF TEXT SOFTWARE SETTING

During testing channel & power controlling software provided by the customer was used to control the operating channel as well as the output power level. The RF output power selection is for the setting of RF output power expected by the customer and is going to be fixed on the firmware of the final end product power parameters of FHSS

Test software version	Bluetest		
Frequency	2409MHz	2440MHz	2476MHz
Parameters-1Mbps	N/A	N/A	N/A



3.4 BLOCK DIGRAM SHOWING THE CONFIGURATION OF SYSTEM TESTED

Radiated:

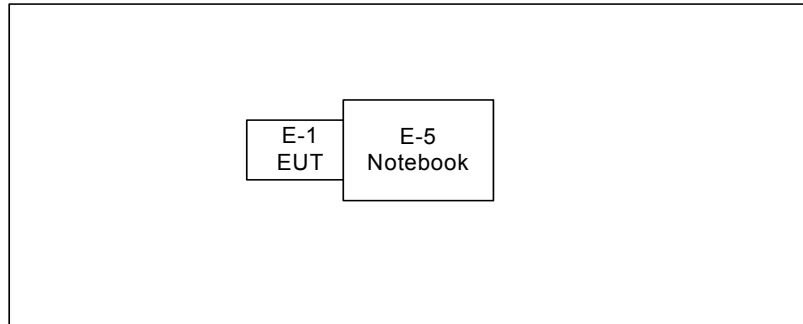

Conducted:

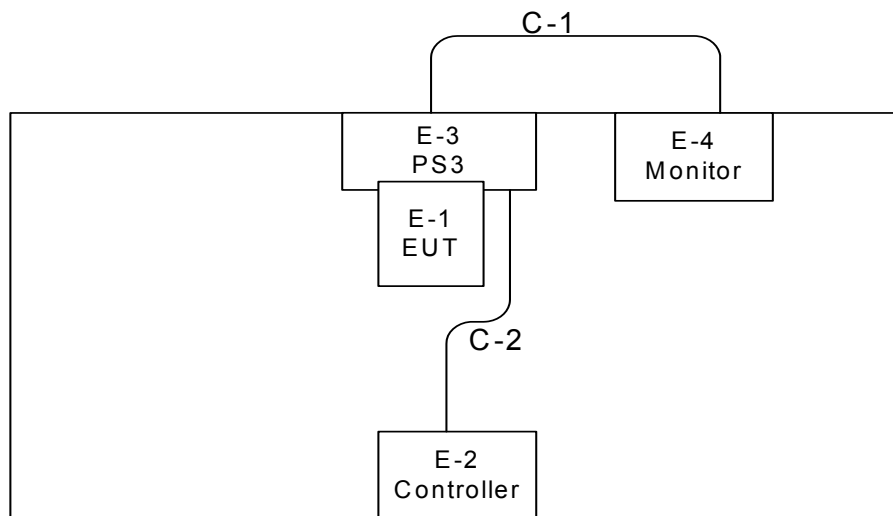

C-1 AV Cable
C-2 USB Cable



3.5 DESCRIPTION OF SUPPORT UNITS

The EUT has been tested as an independent unit together with other necessary accessories or support units. The following support units or accessories were used to form a representative test configuration during the tests.

Item	Equipment	Mfr/Brand	Model/Type No.	FCC ID	Series No.	Note
E-1	AFTERGLOW PS3 WIRELESS DONGLE	AFTERGLOW	PL-6422A	X5B-PL6422A	N/A	EUT
E-2	AFTERGLOW PS3 WIRELESS CONTROLLER	AFTERGLOW	PL-6422	X5B-PL6422	N/A	
E-3	PS3	SONY	CECHH12	DOC	02-27432691-892 4521-CECHH12 CW	
E-4	LCD monitor	Dell	E177FPc	DOC	CNOFJ179-64180 -6AG-1WNS	
E-5	Notebook	HP	HSTNN-169C-3	DOC	CNU02203XG	

Item	Shielded Type	Ferrite Core	Length	Note
C-1	NO	NO	2.3m	-
C-2	YES	YES	1.0m	

Note:

- (1) For detachable type I/O cable should be specified the length in m in 『Length』 column.



4. EMC EMISSION TEST

4.1 CONDUCTED EMISSION MEASUREMENT

4.1.1 POWER LINE CONDUCTED EMISSION Limits (Frequency Range 150KHz-30MHz)

FREQUENCY (MHz)	Class A (dBuV)		Class B (dBuV)		Standard
	Quasi-peak	Average	Quasi-peak	Average	
0.15 -0.5	79.00	66.00	66 - 56 *	56 - 46 *	CISPR
0.50 -5.0	73.00	60.00	56.00	46.00	CISPR
5.0 -30.0	73.00	60.00	60.00	50.00	CISPR

0.15 -0.5	79.00	66.00	66 - 56 *	56 - 46 *	FCC
0.50 -5.0	73.00	60.00	56.00	46.00	FCC
5.0 -30.0	73.00	60.00	60.00	50.00	FCC

Note:

- (1) The tighter limit applies at the band edges.
- (2) The limit of " * " marked band means the limitation decreases linearly with the logarithm of the frequency in the range.

4.1.2 MEASUREMENT INSTRUMENTS LIST AND SETTING

Item	Kind of Equipment	Manufacturer	Type No.	Serial No.	Calibrated until
1	LISN	EMCO	3816/2	00052765	Apr. 25, 2014
2	LISN	R&S	ENV216	100087	Nov.16.2013
3	Test Cable	N/A	C_17	N/A	Mar.15.2014
4	EMI TEST RECEIVER	R&S	ESCS30	826547/022	Apr. 25, 2014
5	50Ω Terminator	SHX	TF2-3G-A	08122902	Apr. 25, 2014

Remark: "N/A" denotes no model name, serial no. or calibration specified.

All calibration period of Equipment List is One Year.

The following table is the setting of the receiver

Receiver Parameters	Setting
Attenuation	10 dB
Start Frequency	0.15 MHz
Stop Frequency	30 MHz
IF Bandwidth	9 kHz

4.1.3 TEST PROCEDURE

- The EUT was placed 0.8 meters from the horizontal ground plane with EUT being connected to the power mains through a line impedance stabilization network (LISN). All other support equipments powered from additional LISN(s). The LISN provide 50 Ohm/ 50uH of coupling impedance for the measuring instrument.
- Interconnecting cables that hang closer than 40 cm to the ground plane shall be folded back and forth in the center forming a bundle 30 to 40 cm long.
- I/O cables that are not connected to a peripheral shall be bundled in the center. The end of the cable may be terminated, if required, using the correct terminating impedance. The overall length shall not exceed 1 m.
- LISN at least 80 cm from nearest part of EUT chassis.
- For the actual test configuration, please refer to the related Item –EUT Test Photos.

4.1.4 DEVIATION FROM TEST STANDARD

No deviation

4.1.5 TEST SETUP

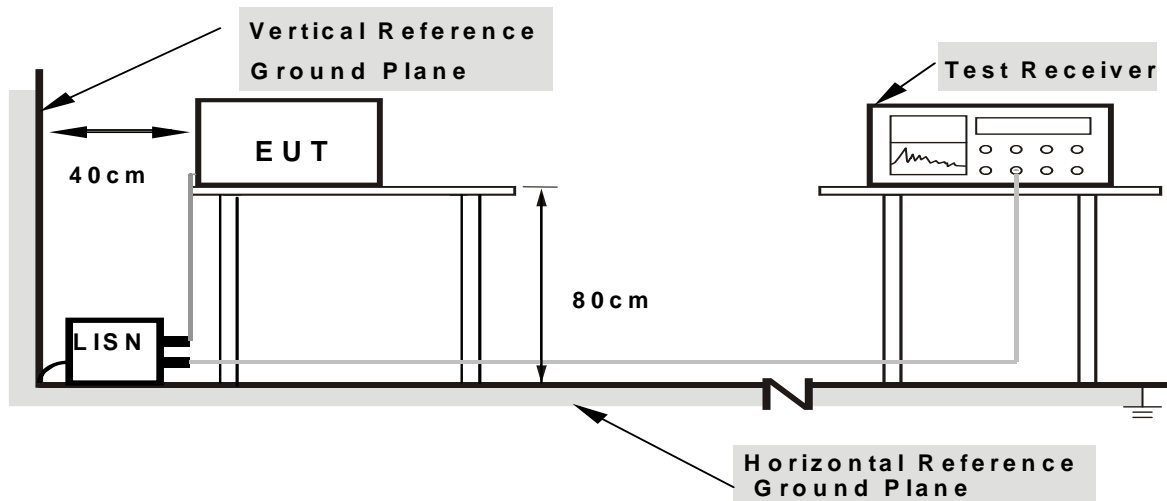

Note: 1. Support units were connected to second LISN.

2. Both of LISNs (AMN) are 80 cm from EUT and at least 80 cm from other units and other metal planes

4.1.6 EUT OPERATING CONDITIONS

The EUT was configured for testing in a typical fashion (as a customer would normally use it). The EUT has been programmed to continuously transmit during test. This operating condition was tested and used to collect the included data.

The EUT is continued Transmitter/Receive data or Hopping on mode.



4.1.7 TEST RESULTS

Remark

- (1) All readings are QP Mode value unless otherwise stated AVG in column of "Note". If the QP Mode Measured value compliance with the QP Limits and lower than AVG Limits, the EUT shall be deemed to meet both QP & AVG Limits and then only QP Mode was measured, but AVG Mode didn't perform. In this case, a " * " marked in AVG Mode column of Interference Voltage Measured.
- (2) Measuring frequency range from 150KHz to 30MHz.



EUT:	AFTERGLOW PS3 WIRELESS DONGLE	Model Name :	PL-6422A
Temperature:	25 °C	Relative Humidity:	58 %
Test Voltage:	AC 120V/60Hz	Polarization:	Line
Test Mode :	WIRELESS		

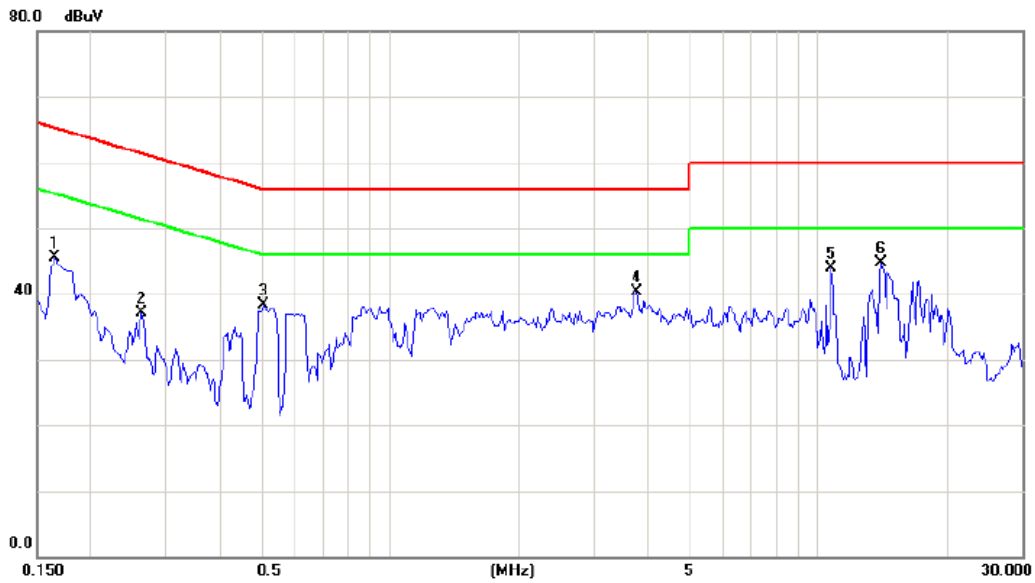

No.	Mk.	Freq. MHz	Reading Level dBuV	Correct Factor dB	Measure- ment dBuV	Limit dBuV	Over dB	Detector	Comment
1		0.1655	35.75	9.72	45.47	65.18	-19.71	peak	
2		0.2631	27.32	9.73	37.05	61.33	-24.28	peak	
3		0.5090	28.46	9.75	38.21	56.00	-17.79	peak	
4		3.7772	30.41	9.90	40.31	56.00	-15.69	peak	
5		10.7772	33.77	10.07	43.84	60.00	-16.16	peak	
6	*	13.9885	34.59	10.13	44.72	60.00	-15.28	peak	



EUT:	AFTERGLOW PS3 WIRELESS DONGLE	Model Name :	PL-6422A
Temperature:	25 °C	Relative Humidity:	58 %
Test Voltage:	AC 120V/60Hz	Polarization:	Neutral
Test Mode :	WIRELESS		

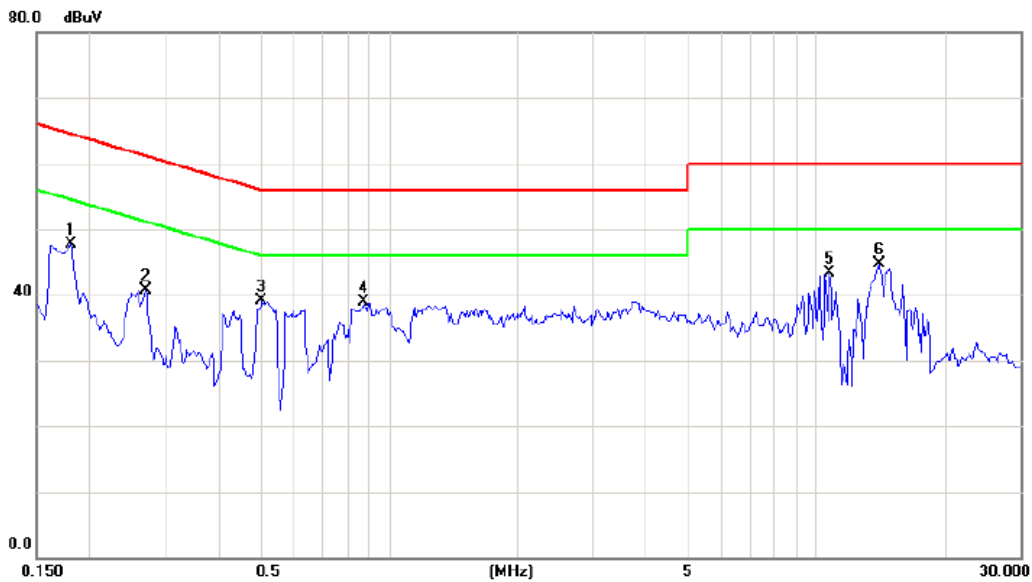

No. Mk.	Freq. MHz	Reading Level dBuV	Correct Factor dB	Measurement dBuV	Limit dBuV	Over dB	Detector	Comment
1	0.1811	37.90	9.72	47.62	64.44	-16.82	peak	
2	0.2710	31.04	9.73	40.77	61.09	-20.32	peak	
3	0.5051	29.30	9.75	39.05	56.00	-16.95	peak	
4	0.8762	29.05	9.80	38.85	56.00	-17.15	peak	
5	10.7734	33.27	10.11	43.38	60.00	-16.62	peak	
6 *	13.9885	34.43	10.18	44.61	60.00	-15.39	peak	



4.2 RADIATED EMISSION MEASUREMENT

4.2.1 RADIATED EMISSION LIMITS (Frequency Range 9kHz-1000MHz)

20dBc in any 100 kHz bandwidth outside the operating frequency band. In case the emission fall within the restricted band specified on 15.205(a), then the 15.209(a) limit in the table below has to be followed.

Frequencies (MHz)	Field Strength (micorvolts/meter)	Measurement Distance (meters)
0.009~0.490	2400/F(KHz)	300
0.490~1.705	24000/F(KHz)	30
1.705~30.0	30	30
30~88	100	3
88~216	150	3
216~960	200	3
Above 960	500	3

LIMITS OF RADIATED EMISSION MEASUREMENT (Above 1000MHz)

FREQUENCY (MHz)	(dBuV/m) (at 3M)	
	PEAK	AVERAGE
Above 1000	74	54

Notes:

- (1) The limit for radiated test was performed according to FCC PART 15C.
- (2) The tighter limit applies at the band edges.
- (3) Emission level (dBuV/m)=20log Emission level (uV/m).

FREQUENCY RANGE OF RADIATED MEASUREMENT (For unintentional radiators)

Highest frequency generated or Upper frequency of measurement used in the device or on which the device operates or tunes (MHz)	Range (MHz)
Below 1.705	30
1.705 – 108	1000
108 – 500	2000
500 – 1000	5000
Above 1000	5 th harmonic of the highest frequency or 40 GHz, whichever is lower



4.2.2 MEASUREMENT INSTRUMENTS LIST AND SETTING

Item	Kind of Equipment	Manufacturer	Type No.	Serial No.	Calibrated until
1	Antenna	Schwarbeck	VULB9160	9160-3232	Apr. 25, 2014
2	Amplifier	HP	8447D	2944A09673	Apr. 25, 2014
3	Test Receiver	R&S	ESCI	100382	Apr. 25, 2014
4	Test Cable	N/A	C-01_CB03	N/A	Jun.30.2014
5	Antenna	ETS	3115	00075789	Apr. 25, 2014
6	Amplifier	Agilent	8449B	3008A02274	Apr. 25, 2014
7	Spectrum	Agilent	E4408B	US39240143	Nov. 16.2013
8	Test Cable	HUBER+SUHNER	C-45	N/A	Apr. 30, 2014
9	Controller	CT	SC100	N/A	N/A
10	Active Loop Antenna	R&S	HFH2-Z2	830749/020	Apr. 25, 2014
11	Broad-Band Horn Antenna	Schwarzbeck	BBHA 9170	9170319	Oct.12.2013
12	Horn Antenna	EMCO	3115	9605-4803	Apr. 25, 2014

Remark: "N/A" denotes no model name, serial no. or calibration specified.
 All calibration period of Equipment List is One Year.

Spectrum Parameter	Setting
Attenuation	Auto
Start Frequency	1000 MHz
Stop Frequency	10th carrier harmonic

Receiver Parameter	Setting
Attenuation	Auto
Start ~ Stop Frequency	9kHz~90kHz for PK/AVG detector
Start ~ Stop Frequency	90kHz~110kHz for QP detector
Start ~ Stop Frequency	110kHz~490kHz for PK/AVG detector
Start ~ Stop Frequency	490kHz~30MHz for QP detector
Start ~ Stop Frequency	30MHz~1000MHz for QP detector



4.2.3 TEST PROCEDURE

- a. The EUT was placed on the top of a rotating table 0.8 meters above the ground at a 3 meter semi-anechoic chamber. The table was rotated 360 degrees to determine the position of the highest radiation.(below 1GHz)
- b. The EUT was placed on the top of a rotating table 0.8 meters above the ground at a 3 meter semi-anechoic chamber. The table was rotated 360 degrees to determine the position of the highest radiation.(above 1GHz)
- c. The height of the equipment or of the substitution antenna shall be 0.8 m; the height of the test antenna shall vary between 1 m to 4 m. Both horizontal and vertical polarizations of the antenna are set to make the measurement.
- d. The initial step in collecting conducted emission data is a spectrum analyzer peak detector mode pre-scanning the measurement frequency range. Significant peaks are then marked and then Quasi Peak detector mode re-measured.
- e. If the Peak Mode measured value compliance with and lower than Quasi Peak Mode Limit, the EUT shall be deemed to meet QP Limits and then no additional QP Mode measurement performed.
- f. For the actual test configuration, please refer to the related Item –EUT Test Photos.

4.2.4 DEVIATION FROM TEST STANDARD

No deviation

4.2.5 TEST SETUP

(A) Radiated Emission Test Set-Up Frequency Below 1 GHz

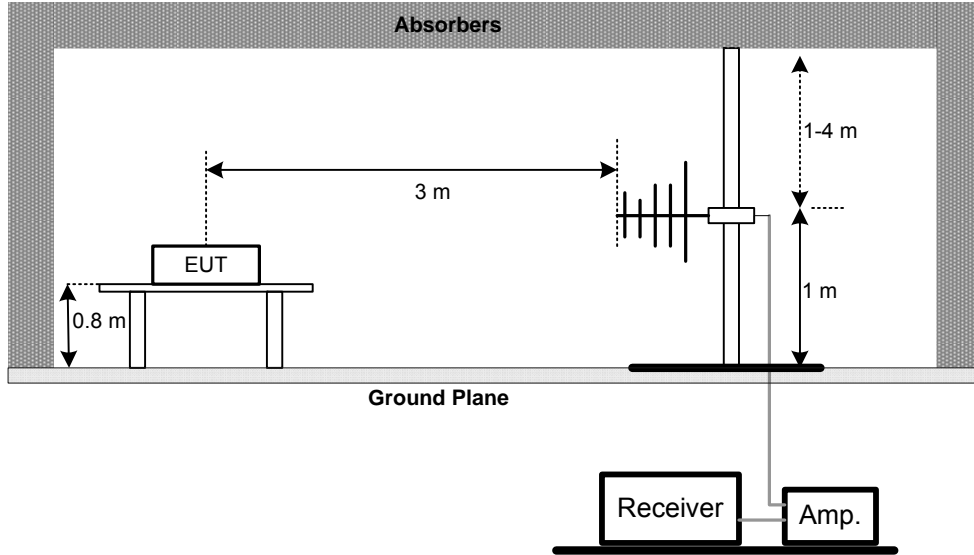

(B) Radiated Emission Test Set-Up Frequency Above 1 GHz

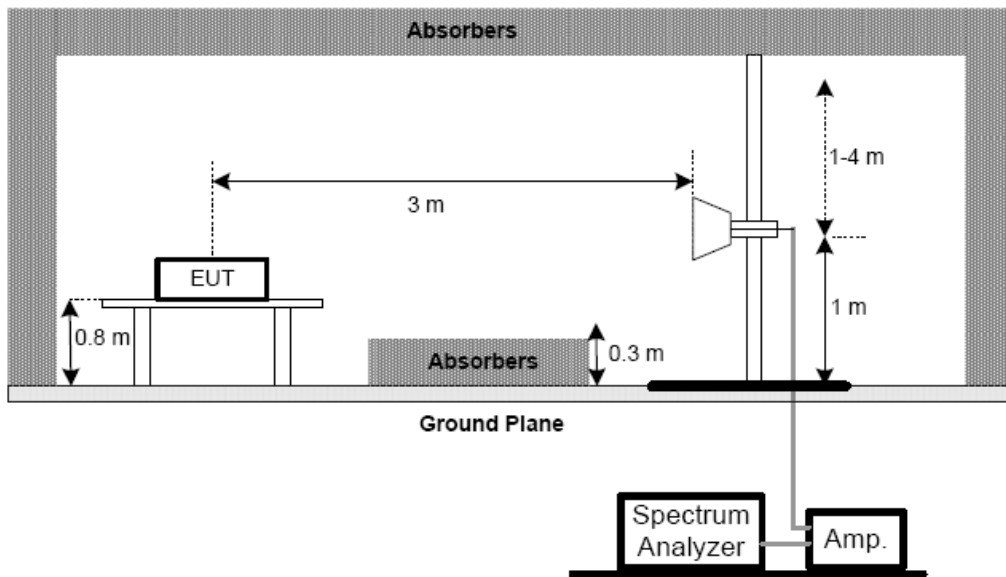

(C) For radiated emissions below 30MHz

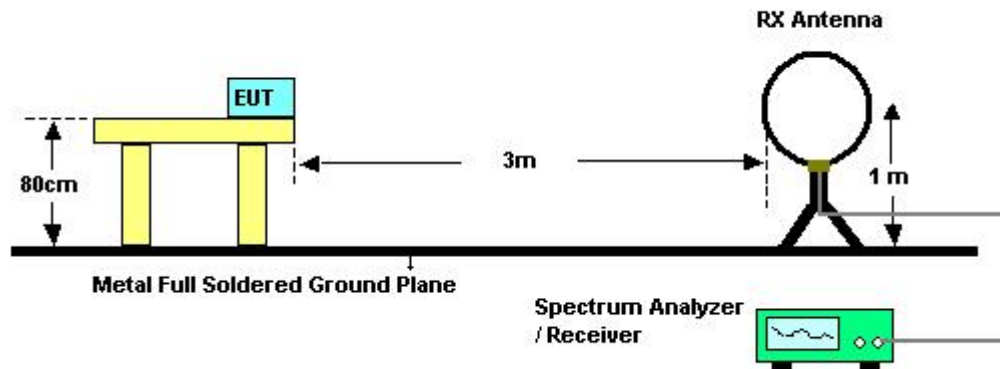

4.2.6 EUT OPERATING CONDITIONS

The EUT tested system was configured as the statements of 4.1.6 Unless otherwise a special operating condition is specified in the follows during the testing.



4.2.7 TEST RESULTS (9K~ 30MHZ)

EUT :	AFTERGLOW PS3 WIRELESS DONGLE	Model Name :	PL-6422A
Temperature :	25 °C	Relative Humidity :	58 %
Test Voltage :	AC 120V/60Hz		
Test Mode :	TX Mode		

Freq. (MHz)	Ant. 0°/90°	Reading(RA) (dBuV)	Corr.Factor(CF) (dB)	Measured(FS) (dBuV/m)	Limits(QP) (dBuV/m)	Margin (dB)	Note
0.0075	0°	25.74	24.30	50.04	130.10	-80.06	AV
0.0075	0°	29.22	24.30	53.52	150.10	-96.58	PK
0.0257	0°	21.37	23.94	45.31	119.42	-74.10	AV
0.0257	0°	24.27	23.94	48.21	139.42	-91.20	PK
0.0389	0°	21.84	23.11	44.95	115.82	-70.87	AV
0.0389	0°	24.34	23.11	47.45	135.82	-88.37	PK
0.0651	0°	18.19	22.10	40.29	111.33	-71.04	AV
0.0651	0°	23.04	22.10	45.14	131.33	-86.19	PK
0.2642	0°	20.43	20.37	40.80	99.17	-58.37	AVG
0.2642	0°	22.74	20.37	43.11	119.17	-76.06	PK
1.4624	0°	27.37	19.55	46.92	64.30	-17.38	QP

Freq. (MHz)	Ant. 0°/90°	Reading(RA) (dBuV)	Corr.Factor(CF) (dB)	Measured(FS) (dBuV/m)	Limits(QP) (dBuV/m)	Margin (dB)	Note
0.00917	90°	19.03	24.30	43.33	128.36	-85.03	AVG
0.00917	90°	20.25	24.30	44.55	148.36	-103.81	PK
0.02234	90°	15.36	24.15	39.51	120.62	-81.11	AVG
0.02234	90°	17.42	24.15	41.57	140.62	-99.05	PK
0.04627	90°	18.74	22.64	41.38	114.30	-72.92	AVG
0.04627	90°	21.86	22.64	44.50	134.30	-89.80	PK
0.07751	90°	21.18	21.85	43.03	109.82	-66.79	AVG
0.07751	90°	22.52	21.85	44.37	129.82	-85.45	PK
0.37454	90°	21.36	20.10	41.46	96.13	-54.67	AVG
0.37454	90°	24.17	20.10	44.27	116.13	-71.86	PK
1.6765	90°	25.37	19.53	44.90	63.12	-18.21	QP

Remark :

- (1) The amplitude of spurious emissions which are attenuated by more than 20 dB below the permissible value has no need to be reported.
- (2) Distance extrapolation factor = 40 log (specific distance / test distance) (dB);
- (3) Limit line = specific limits (dBuV) + distance extrapolation factor..



4.2.8 TEST RESULTS (BETWEEN 30 – 1000 MHZ)

Remark :

- (1) Reading in which marked as QP or Peak means measurements by using are Quasi-Peak Mode or Peak Mode with Detector BW=120KHz ; SPA setting in RBW=120KHz, VBW =120KHz, Swp. Time = 0.3 sec./MHz.
- (2) All readings are Peak unless otherwise stated QP in column of 『Note』 . Peak denotes that the Peak reading compliance with the QP Limits and then QP Mode measurement didn't perform.
- (3) Measuring frequency range from 30MHz to 1000MHz.
- (4) If the peak scan value lower limit more than 20dB, then this signal data does not show in table.



EUT :	AFTERGLOW PS3 WIRELESS DONGLE	Model Name :	PL-6422A
Temperature :	25 °C	Relative Humidity :	58 %
Pressure :	1010 hPa	Test Voltage :	AC 120V/60Hz
Test Mode :	TX Mode 2409MHz	Polarization:	Vertical

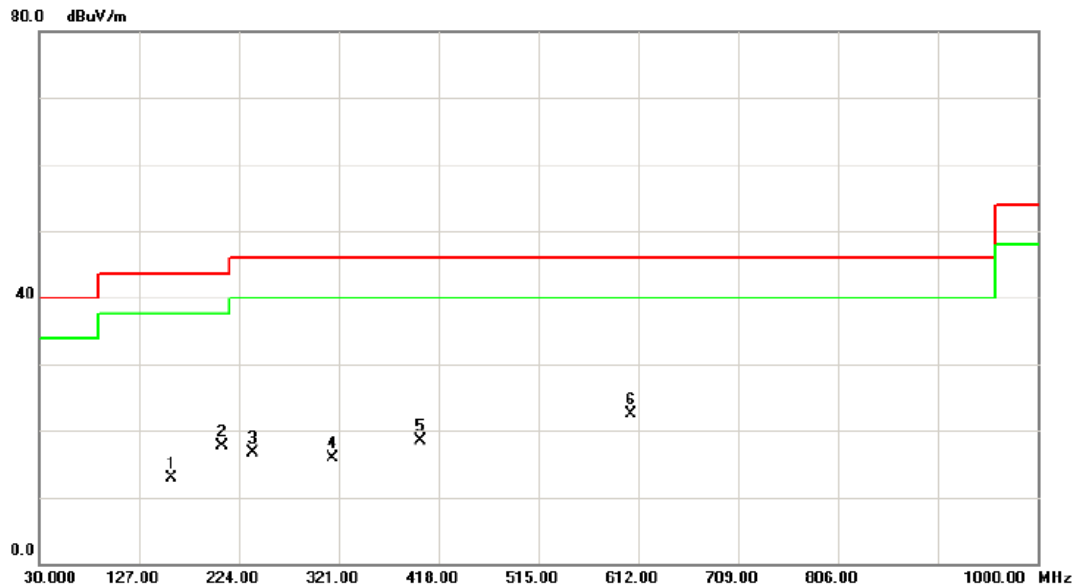

No. Mk.	Freq. MHz	Reading Level dBuV	Correct Factor dB	Measurement dBuV/m	Limit dBuV/m	Over dB	Detector	Comment
1	159.0100	32.06	-19.19	12.87	43.50	-30.63	peak	
2	207.5100	35.90	-18.17	17.73	43.50	-25.77	peak	
3	237.5800	34.02	-17.22	16.80	46.00	-29.20	peak	
4	315.1800	29.77	-13.94	15.83	46.00	-30.17	peak	
5	400.5400	30.05	-11.63	18.42	46.00	-27.58	peak	
6 *	604.2400	30.16	-7.66	22.50	46.00	-23.50	peak	



EUT :	AFTERGLOW PS3 WIRELESS DONGLE	Model Name :	PL-6422A
Temperature :	25 °C	Relative Humidity :	58 %
Pressure :	1010 hPa	Test Voltage :	AC 120V/60Hz
Test Mode :	TX Mode 2409MHz	Polarization:	Horizontal

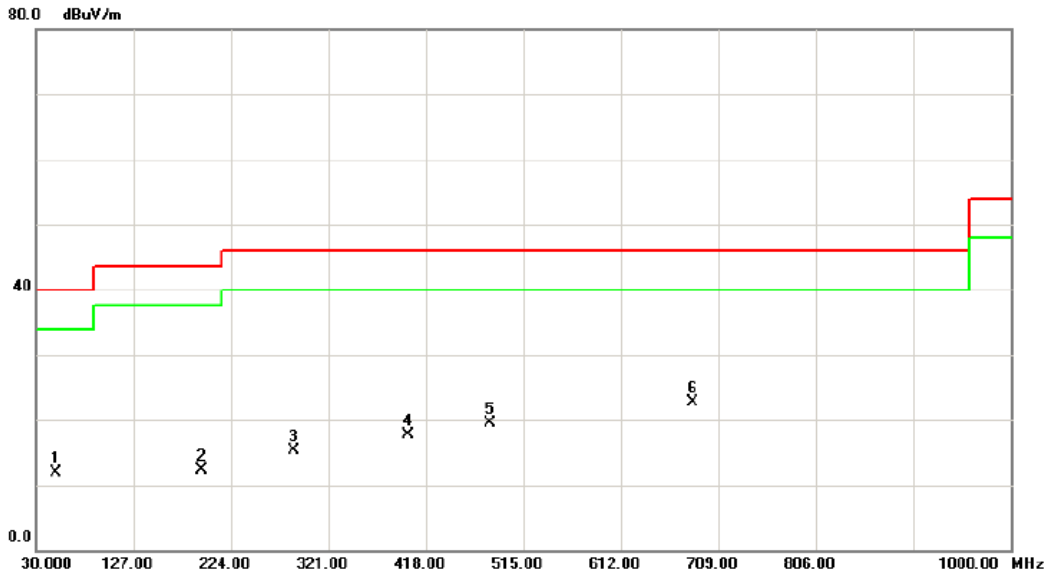

No. Mk.	Freq. MHz	Reading Level dBuV	Correct Factor dB	Measurement dBuV/m	Limit dBuV/m	Over dB	Detector	Comment
1	49.4000	30.09	-18.20	11.89	40.00	-28.11	peak	
2	194.9000	30.74	-18.34	12.40	43.50	-31.10	peak	
3	286.0800	29.72	-14.39	15.33	46.00	-30.67	peak	
4	400.5400	29.35	-11.63	17.72	46.00	-28.28	peak	
5	482.0200	30.02	-10.61	19.41	46.00	-26.59	peak	
6 *	683.7800	29.70	-7.04	22.66	46.00	-23.34	peak	



EUT :	AFTERGLOW PS3 WIRELESS DONGLE	Model Name :	PL-6422A
Temperature :	25 °C	Relative Humidity :	58 %
Pressure :	1010 hPa	Test Voltage :	AC 120V/60Hz
Test Mode :	TX Mode 2440MHz	Polarization:	Vertical

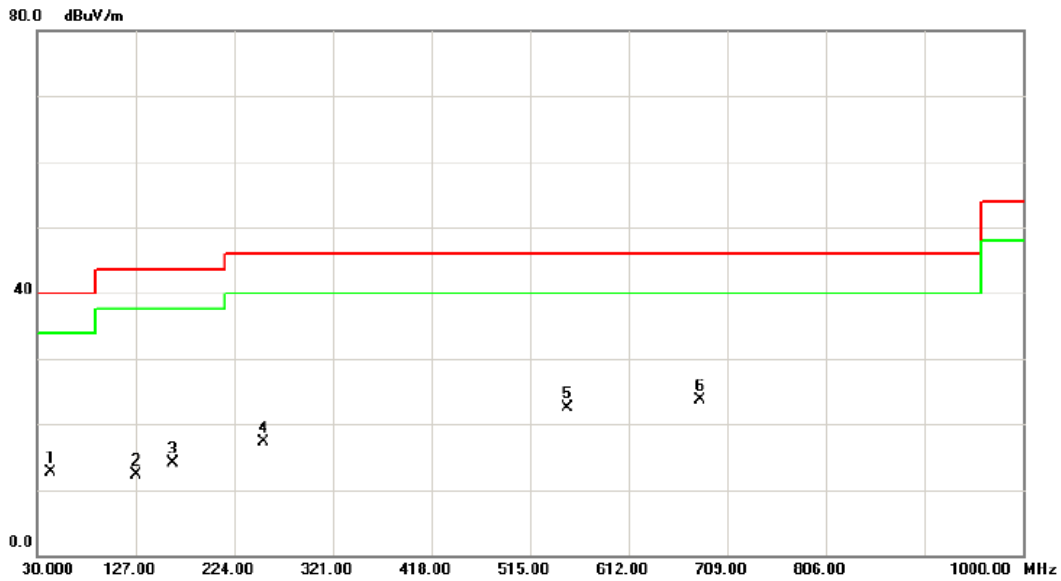

No. Mk.	Freq. MHz	Reading Level dBuV	Correct Factor dB	Measurement dBuV/m	Limit dBuV/m	Over dB	Detector	Comment
1	43.5800	30.45	-17.75	12.70	40.00	-27.30	peak	
2	127.9700	31.78	-19.53	12.25	43.50	-31.25	peak	
3	163.8600	33.18	-19.07	14.11	43.50	-29.39	peak	
4	253.1000	33.57	-16.30	17.27	46.00	-28.73	peak	
5	551.8600	31.12	-8.69	22.43	46.00	-23.57	peak	
6 *	682.8100	30.71	-7.04	23.67	46.00	-22.33	peak	



EUT :	AFTERGLOW PS3 WIRELESS DONGLE	Model Name :	PL-6422A
Temperature :	25 °C	Relative Humidity :	58 %
Pressure :	1010 hPa	Test Voltage :	AC 120V/60Hz
Test Mode :	TX Mode 2440MHz	Polarization:	Horizontal

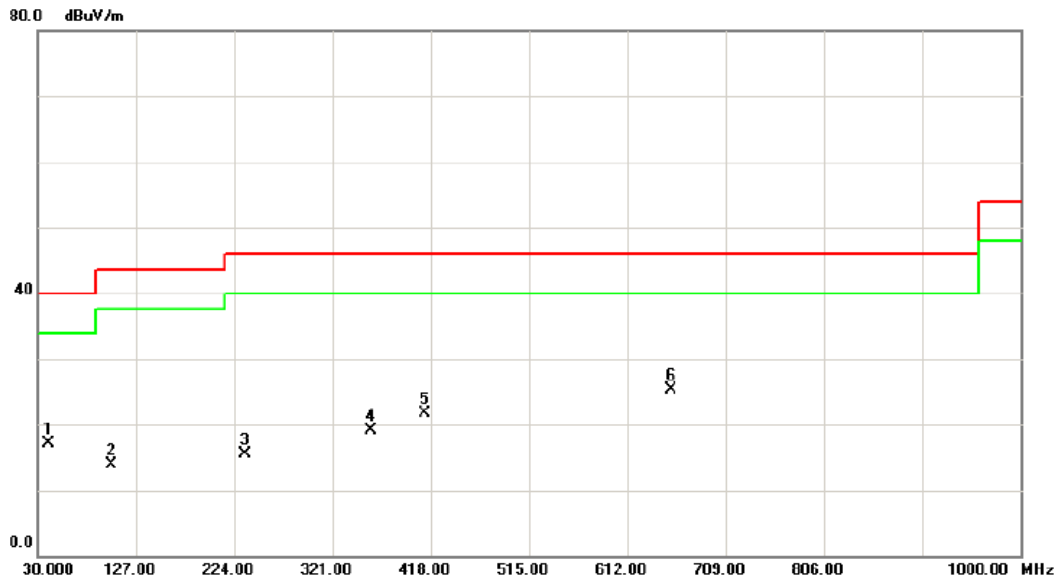

No. Mk.	Freq. MHz	Reading Level dBuV	Correct Factor dB	Measurement dBuV/m	Limit dBuV/m	Over dB	Detector	Comment
1	40.6700	34.75	-17.59	17.16	40.00	-22.84	peak	
2	102.7500	33.69	-19.69	14.00	43.50	-29.50	peak	
3	234.6700	32.85	-17.32	15.53	46.00	-30.47	peak	
4	358.8300	31.99	-12.96	19.03	46.00	-26.97	peak	
5	412.1800	33.08	-11.47	21.61	46.00	-24.39	peak	
6 *	654.6800	32.22	-7.00	25.22	46.00	-20.78	peak	



EUT :	AFTERGLOW PS3 WIRELESS DONGLE	Model Name :	PL-6422A
Temperature :	25 °C	Relative Humidity :	58 %
Pressure :	1010 hPa	Test Voltage :	AC 120V/60Hz
Test Mode :	TX Mode 2476MHz	Polarization:	Vertical



No. Mk.	Freq. MHz	Reading Level dBuV	Correct Factor dB	Measurement dBuV/m	Limit dBuV/m	Over dB	Detector	Comment
1	42.6100	28.07	-17.61	10.46	40.00	-29.54	peak	
2	143.4900	28.60	-19.13	9.47	43.50	-34.03	peak	
3	323.9100	27.49	-13.76	13.73	46.00	-32.27	peak	
4	474.2600	26.68	-10.69	15.99	46.00	-30.01	peak	
5	565.4400	27.56	-8.42	19.14	46.00	-26.86	peak	
6 *	693.4800	27.91	-7.05	20.86	46.00	-25.14	peak	



EUT :	AFTERGLOW PS3 WIRELESS DONGLE	Model Name :	PL-6422A
Temperature :	25 °C	Relative Humidity :	58 %
Pressure :	1010 hPa	Test Voltage :	AC 120V/60Hz
Test Mode :	TX Mode 2476MHz	Polarization:	Horizontal

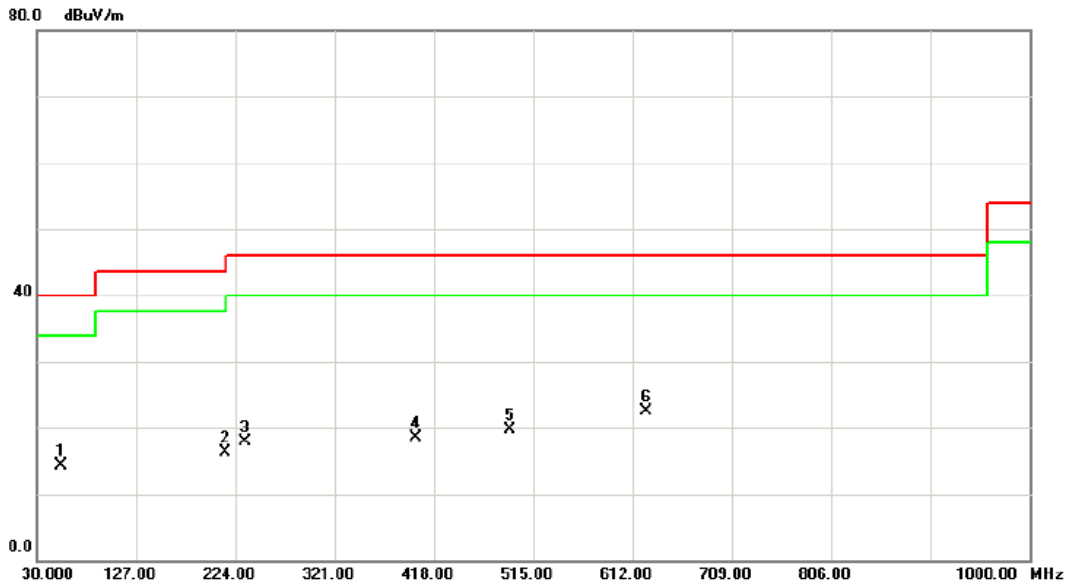

No. Mk.	Freq. MHz	Reading Level dBuV	Correct Factor dB	Measurement dBuV/m	Limit dBuV/m	Over dB	Detector	Comment
1	54.2500	32.78	-18.48	14.30	40.00	-25.70	peak	
2	214.3000	34.17	-17.95	16.22	43.50	-27.28	peak	
3	233.7000	35.16	-17.35	17.81	46.00	-28.19	peak	
4	400.5400	30.04	-11.63	18.41	46.00	-27.59	peak	
5	492.6900	30.19	-10.50	19.69	46.00	-26.31	peak	
6 *	625.5800	29.88	-7.36	22.52	46.00	-23.48	peak	



4.2.9 TEST RESULTS (ABOVE 1000 MHZ)

EUT :	AFTERGLOW PS3 WIRELESS DONGLE	Model Name :	PL-6422A
Temperature :	25 °C	Relative Humidity :	58 %
Pressure :	1010 hPa	Test Voltage :	AC 120V/60Hz
Test Mode :	TX 2409MHz		

Freq. (MHz)	Ant.Pol. H/V	Reading		Ant./CF CF(dB)	Act.		Limit		Margin		Note
		Peak (dBuV)	AV (dBuV)		Peak (dBuV/m)	AV (dBuV/m)	Peak (dBuV/m)	AV (dBuV/m)	Peak (dBuV/m)	AV (dBuV/m)	
2390.00	V	23.38	13.50	32.28	55.66	45.78	74.00	54.00	-18.34	-8.22	X/E
2408.85	V	52.27	49.89	32.26	84.53	82.15					X/F
4818.05	V	53.46	41.20	6.17	59.63	47.37	74.00	54.00	-14.37	-6.63	X/H

Remark :

- (1) All readings are Peak unless otherwise stated QP in column of 『Note』 . Peak denotes that the Peak reading compliance with the QP Limits and then QP Mode measurement didn't perform.
- (2) Measuring frequency range from 30MHz to 1000MHz or the 10th harmonic of highest fundamental frequency. "F" denotes fundamental frequency; "H" denotes spurious frequency. "E" denotes band edge frequency. (This judgment method includes the Band Edge Requirement.)
- (3) Radiated emissions measured in frequency range above 1000MHz were made with an instrument using Peak detector mode and AV detector mode of the emission .
- (4) Data of measurement within this frequency range shown " * " in the table above means the reading of emissions are attenuated more than 20dB below the permissible limits or the field strength is too small to be measured.
- (5) A preamp and high pass filter were used for this test in order to provide sufficient measurement sensitivity.
- (6) EUT Orthogonal Axis :
"X" - denotes Laid on Table ; "Y" - denotes Vertical Stand ; "Z" - denotes Side Stand
- (7) During the measurements above 1 GHz it is taken care of that the EUT is always within the 3 dB cone of radiation BW of the used antenna
- (8) Peak setting: RBW=1MHz, VBW=1MHz.
AVG setting: RBW=1MHz, VBW=10KHz.



TX 2409MHz(Above 1000 MHz, Vertical)

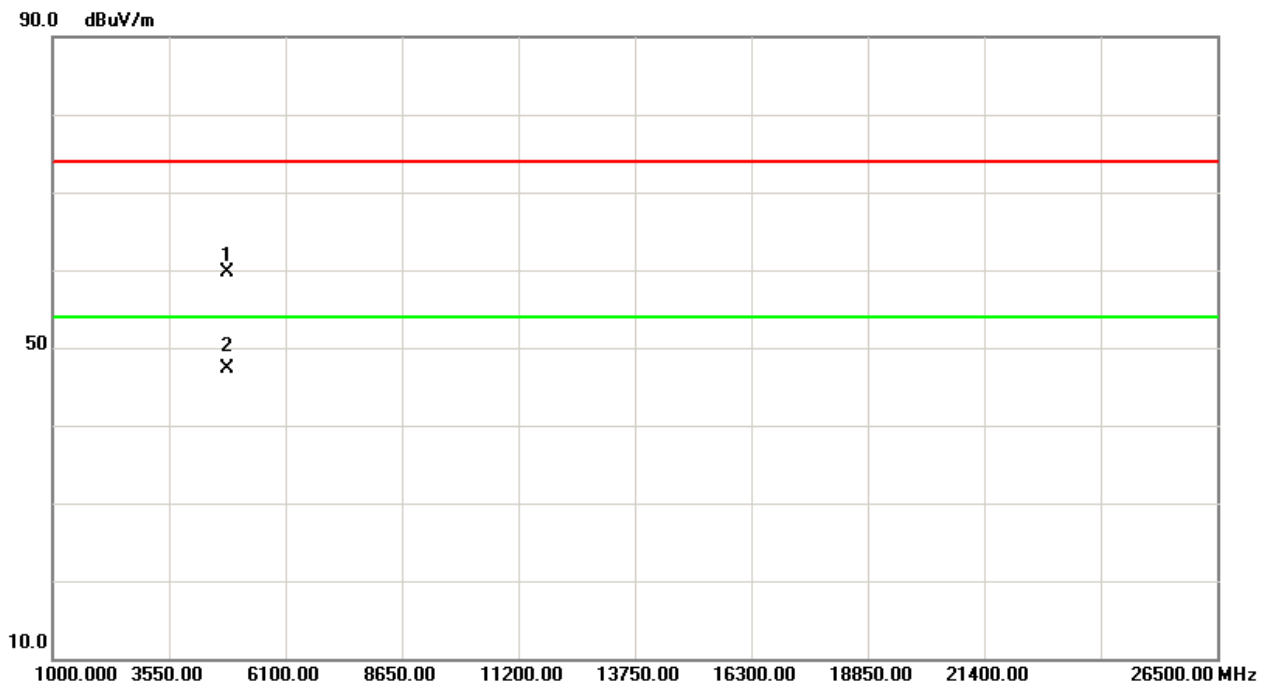
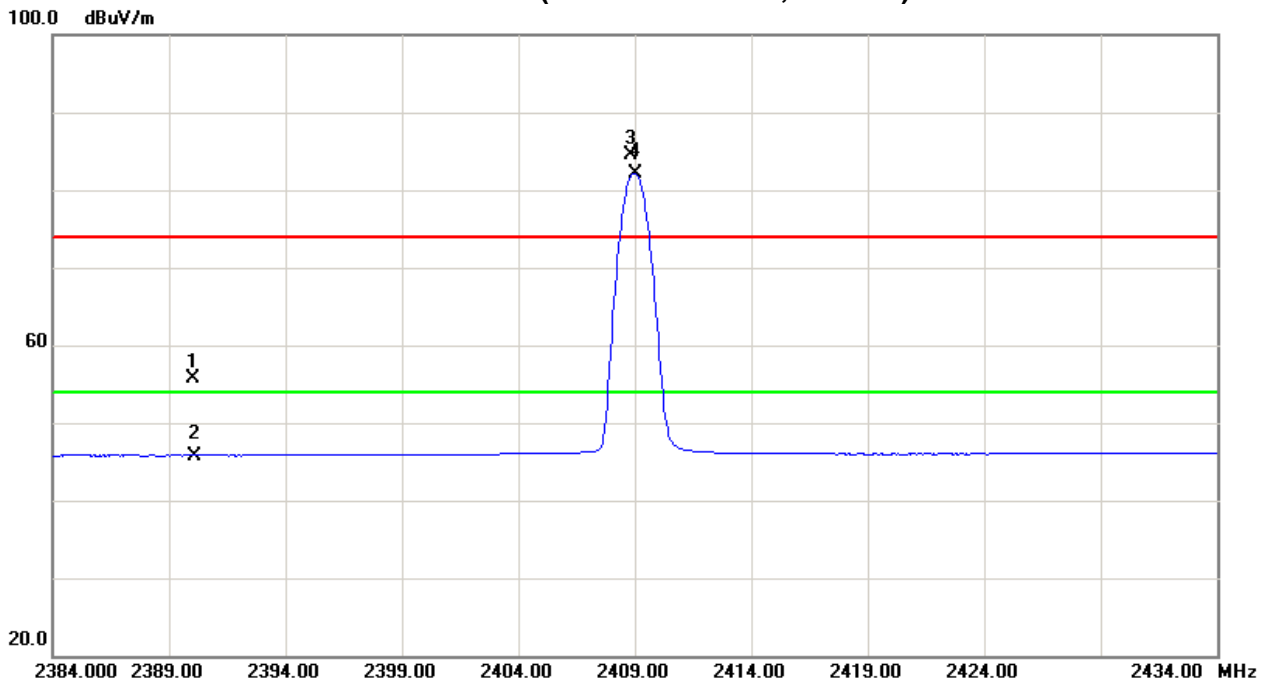



EUT :	AFTERGLOW PS3 WIRELESS DONGLE	Model Name :	PL-6422A
Temperature :	25 °C	Relative Humidity :	58 %
Pressure :	1010hPa	Test Voltage :	AC 120V/60Hz
Test Mode :	TX 2409MHz		

Freq. (MHz)	Ant.Pol. H/V	Reading		Ant./CF CF(dB)	Act.		Limit		Margin		Note
		Peak (dBuV)	AV (dBuV)		Peak (dBuV/m)	AV (dBuV/m)	Peak (dBuV/m)	AV (dBuV/m)	Peak (dBuV/m)	AV (dBuV/m)	
2390.00	H	23.20	13.52	32.28	55.48	45.80	74.00	54.00	-18.52	-8.20	X/E
2409.00	H	49.76	47.42	32.26	82.02	79.68					X/F
4818.08	H	51.31	40.29	6.17	57.48	46.46	74.00	54.00	-16.52	-7.54	X/H

Remark :

- (1) All readings are Peak unless otherwise stated QP in column of 『Note』 . Peak denotes that the Peak reading compliance with the QP Limits and then QP Mode measurement didn't perform.
- (2) Measuring frequency range from 30MHz to 1000MHz or the 10th harmonic of highest fundamental frequency. "F" denotes fundamental frequency; "H" denotes spurious frequency. "E" denotes band edge frequency. (This judgment method includes the Band Edge Requirement.)
- (3) Radiated emissions measured in frequency range above 1000MHz were made with an instrument using Peak detector mode and AV detector mode of the emission .
- (4) Data of measurement within this frequency range shown " * " in the table above means the reading of emissions are attenuated more than 20dB below the permissible limits or the field strength is too small to be measured.
- (5) A preamp and high pass filter were used for this test in order to provide sufficient measurement sensitivity.
- (6) EUT Orthogonal Axis :
"X" - denotes Laid on Table ; "Y" - denotes Vertical Stand ; "Z" - denotes Side Stand
- (7) During the measurements above 1 GHz it is taken care of that the EUT is always within the 3 dB cone of radiation BW of the used antenna
- (8) Peak setting: RBW=1MHz, VBW=1MHz.
AVG setting: RBW=1MHz, VBW=10KHz.



TX 2409MHz(Above 1000 MHz, Horizontal)

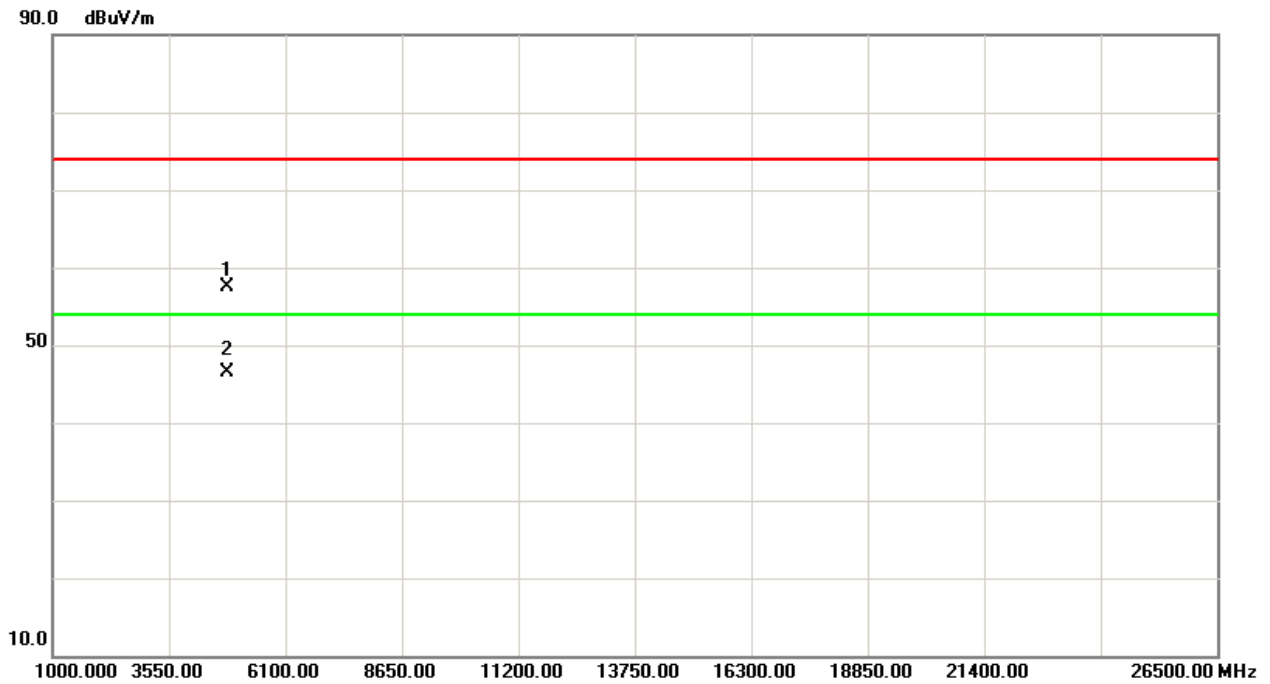
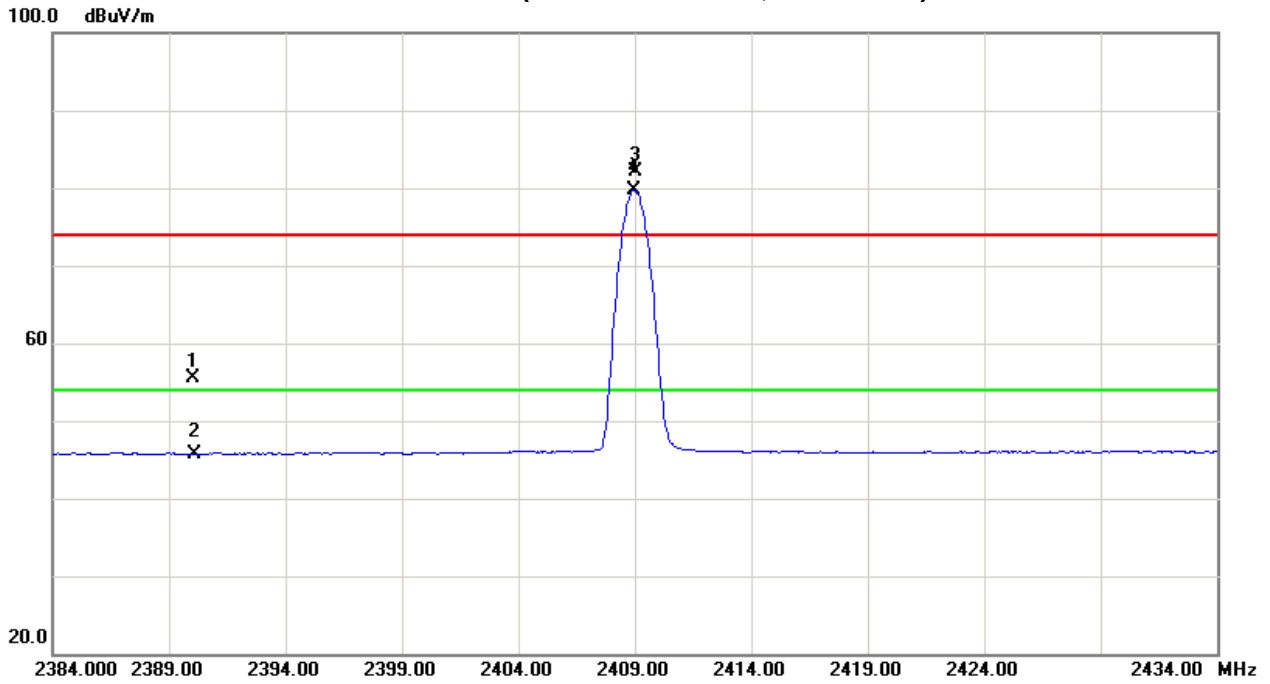



EUT :	AFTERGLOW PS3 WIRELESS DONGLE	Model Name :	PL-6422A
Temperature :	25 °C	Relative Humidity :	58 %
Pressure :	1010 hPa	Test Voltage :	AC 120V/60Hz
Test Mode :	TX 2440MHz		

Freq. (MHz)	Ant.Pol.	Reading		Ant./CF CF(dB)	Act.		Limit		Margin		Note
		Peak (dBuV)	AV (dBuV)		Peak (dBuV/m)	AV (dBuV/m)	Peak (dBuV/m)	AV (dBuV/m)	Peak (dBuV/m)	AV (dBuV/m)	
2439.80	V	52.76	50.38	32.22	84.98	82.60					X/F
4879.86	V	52.68	41.73	6.42	59.10	48.15	74.00	54.00	-14.90	-5.85	X/H

Remark :

- (1) All readings are Peak unless otherwise stated QP in column of 『Note』 . Peak denotes that the Peak reading compliance with the QP Limits and then QP Mode measurement didn't perform.
- (2) Measuring frequency range from 30MHz to 1000MHz or the 10th harmonic of highest fundamental frequency. "F" denotes fundamental frequency; "H" denotes spurious frequency. "E" denotes band edge frequency. (This judgment method includes the Band Edge Requirement.)
- (3) Radiated emissions measured in frequency range above 1000MHz were made with an instrument using Peak detector mode and AV detector mode of the emission .
- (4) Data of measurement within this frequency range shown " * " in the table above means the reading of emissions are attenuated more than 20dB below the permissible limits or the field strength is too small to be measured.
- (5) A preamp and high pass filter were used for this test in order to provide sufficient measurement sensitivity.
- (6) EUT Orthogonal Axis :
"X" - denotes Laid on Table ; "Y" - denotes Vertical Stand ; "Z" - denotes Side Stand
- (7) During the measurements above 1 GHz it is taken care of that the EUT is always within the 3 dB cone of radiation BW of the used antenna
- (8) Peak setting: RBW=1MHz, VBW=1MHz.
AVG setting: RBW=1MHz, VBW=10KHz.



TX 2440MHz (Above 1000 MHz, Vertical)

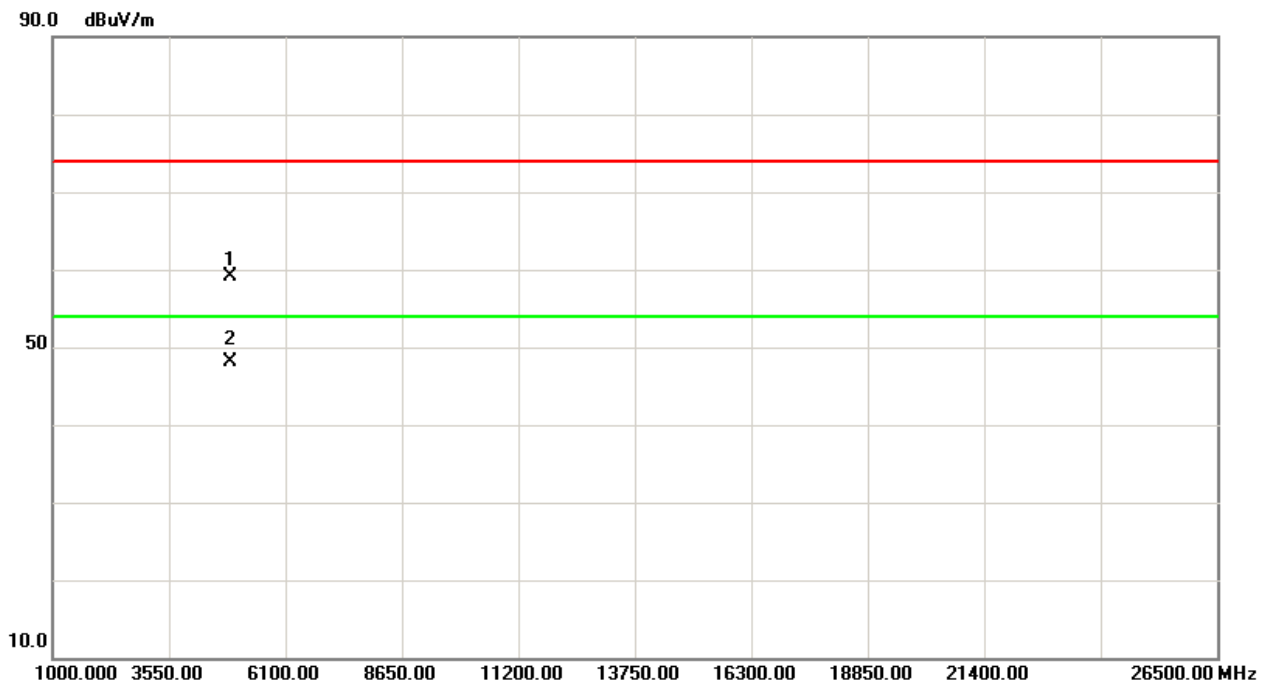
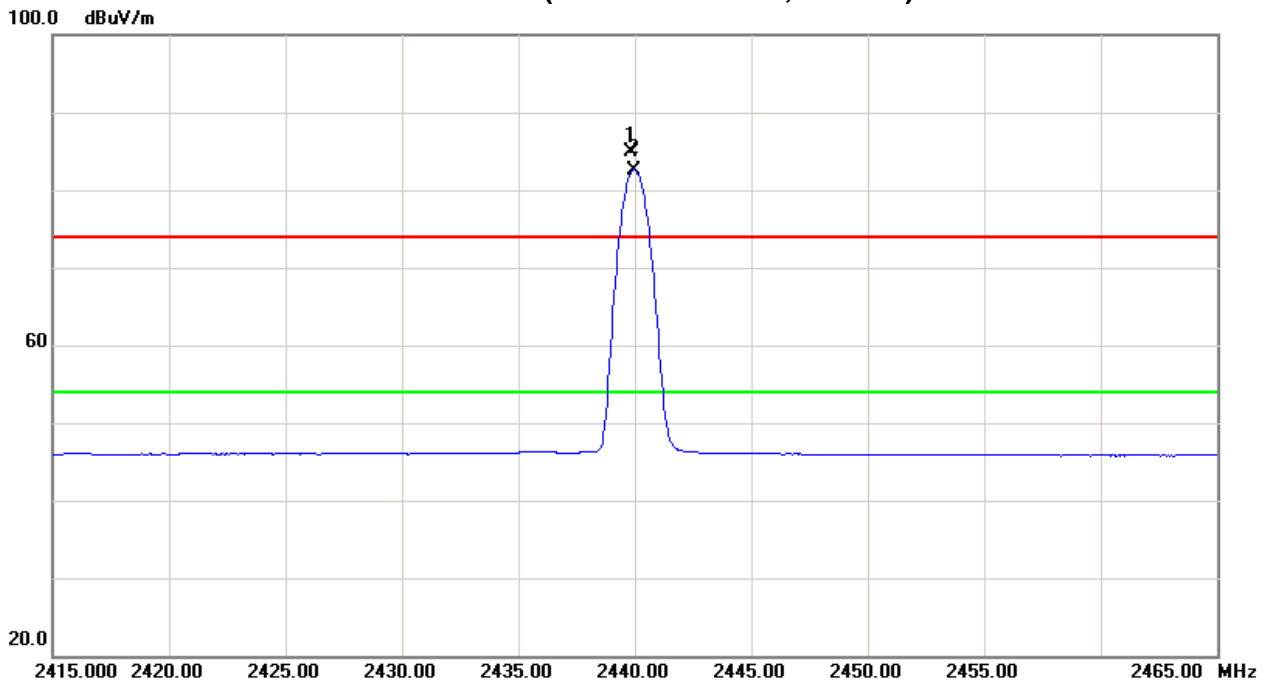



EUT :	AFTERGLOW PS3 WIRELESS DONGLE	Model Name :	PL-6422A
Temperature :	25 °C	Relative Humidity :	58 %
Pressure :	1010 hPa	Test Voltage :	AC 120V/60Hz
Test Mode :	TX 2440MHz		

Freq. (MHz)	Ant. Pol. H/V	Reading		Ant./CF CF(dB)	Act.		Limit		Margin		Note
		Peak (dBuV)	AV (dBuV)		Peak (dBuV/m)	AV (dBuV/m)	Peak (dBuV/m)	AV (dBuV/m)	Peak (dBuV/m)	AV (dBuV/m)	
2440.00	H	48.73	46.34	32.22	80.95	78.56					X/F
4880.10	H	49.13	38.24	6.42	55.55	44.66	74.00	54.00	-18.45	-9.34	X/H

Remark :

- (1) All readings are Peak unless otherwise stated QP in column of 『Note』 . Peak denotes that the Peak reading compliance with the QP Limits and then QP Mode measurement didn't perform.
- (2) Measuring frequency range from 30MHz to 1000MHz or the 10th harmonic of highest fundamental frequency. "F" denotes fundamental frequency; "H" denotes spurious frequency. "E" denotes band edge frequency. (This judgment method includes the Band Edge Requirement.)
- (3) Radiated emissions measured in frequency range above 1000MHz were made with an instrument using Peak detector mode and AV detector mode of the emission .
- (4) Data of measurement within this frequency range shown " * " in the table above means the reading of emissions are attenuated more than 20dB below the permissible limits or the field strength is too small to be measured.
- (5) A preamp and high pass filter were used for this test in order to provide sufficient measurement sensitivity.
- (6) EUT Orthogonal Axis :
"X" - denotes Laid on Table ; "Y" - denotes Vertical Stand ; "Z" - denotes Side Stand
- (7) During the measurements above 1 GHz it is taken care of that the EUT is always within the 3 dB cone of radiation BW of the used antenna
- (8) Peak setting: RBW=1MHz, VBW=1MHz.
AVG setting: RBW=1MHz, VBW=10KHz.



TX 2440MHz (Above 1000 MHz, Horizontal)

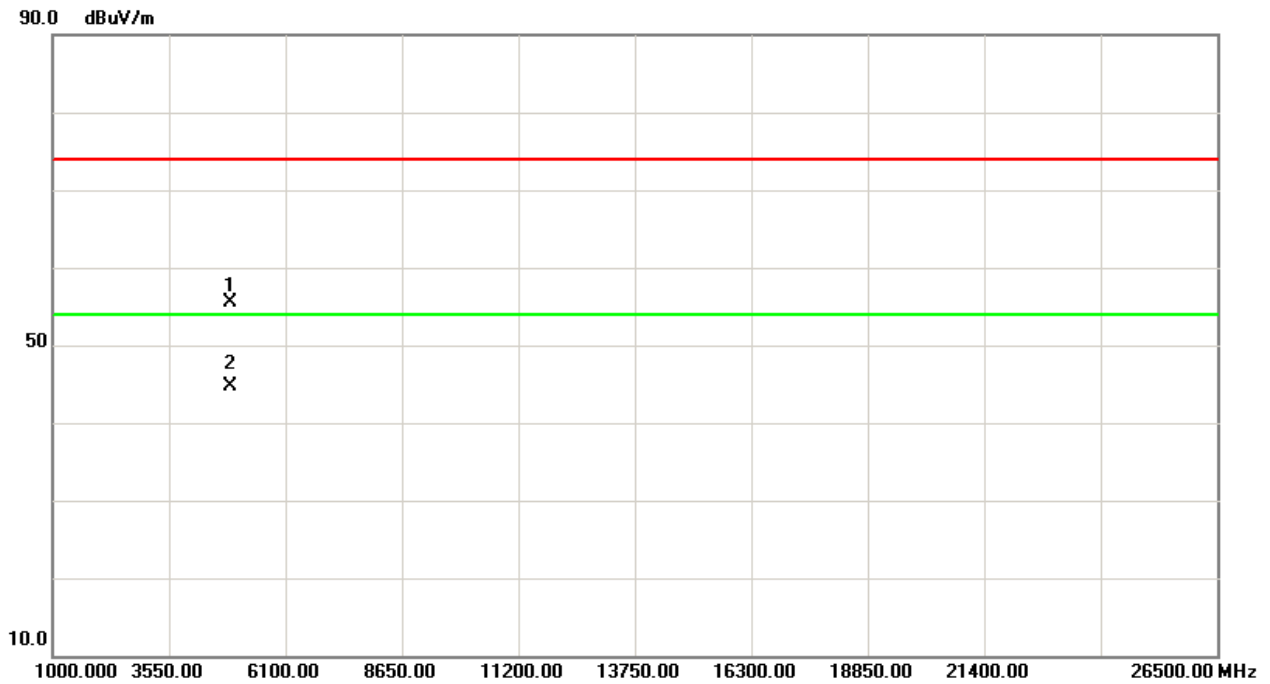
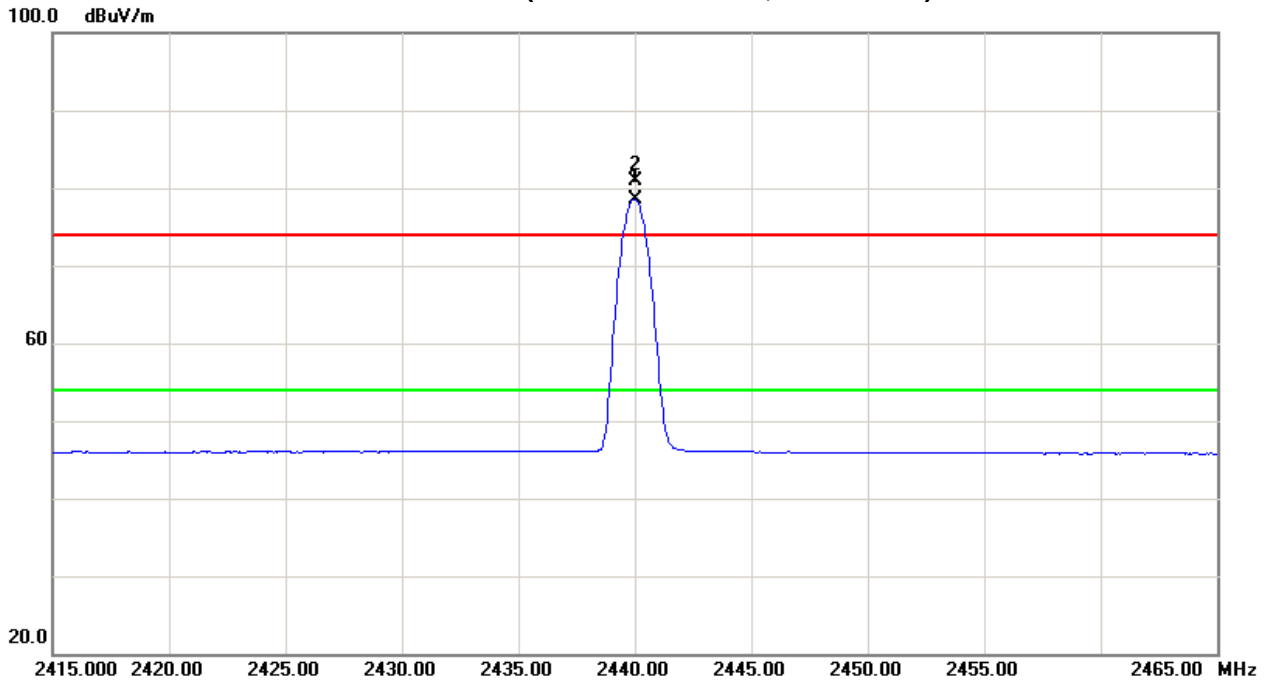



EUT :	AFTERGLOW PS3 WIRELESS DONGLE	Model Name :	PL-6422A
Temperature :	25 °C	Relative Humidity :	58 %
Pressure :	1010hPa	Test Voltage :	AC 120V/60Hz
Test Mode :	TX 2476MHz		

Freq.	Ant.Pol.	Reading		Ant./CF	Act.		Limit		Margin		Note
		Peak	AV		Peak	AV	Peak	AV	Peak	AV	
(MHz)	H/V	(dBuV)	(dBuV)	CF(dB)	(dBuV/m)	(dBuV/m)	(dBuV/m)	(dBuV/m)	(dBuV/m)	(dBuV/m)	
2476.15	V	51.88	49.59	32.19	84.07	81.78					X/F
2483.50	V	24.26	13.58	32.17	56.43	45.75	74.00	54.00	-17.57	-8.25	X/E
4952.05	V	53.26	43.17	6.70	59.96	49.87	74.00	54.00	-14.04	-4.13	X/H

Remark :

- (1) All readings are Peak unless otherwise stated QP in column of 『Note』 . Peak denotes that the Peak reading compliance with the QP Limits and then QP Mode measurement didn't perform.
- (2) Measuring frequency range from 30MHz to 1000MHz or the 10th harmonic of highest fundamental frequency. "F" denotes fundamental frequency; "H" denotes spurious frequency. "E" denotes band edge frequency. (This judgment method includes the Band Edge Requirement.)
- (3) Radiated emissions measured in frequency range above 1000MHz were made with an instrument using Peak detector mode and AV detector mode of the emission .
- (4) Data of measurement within this frequency range shown " * " in the table above means the reading of emissions are attenuated more than 20dB below the permissible limits or the field strength is too small to be measured.
- (5) A preamp and high pass filter were used for this test in order to provide sufficient measurement sensitivity.
- (6) EUT Orthogonal Axis :
"X" - denotes Laid on Table ; "Y" - denotes Vertical Stand ; "Z" - denotes Side Stand
- (7) During the measurements above 1 GHz it is taken care of that the EUT is always within the 3 dB cone of radiation BW of the used antenna
- (8) Peak setting: RBW=1MHz, VBW=1MHz.
AVG setting: RBW=1MHz, VBW=10KHz.



TX 2476MHz(Above 1000 MHz, Vertical)

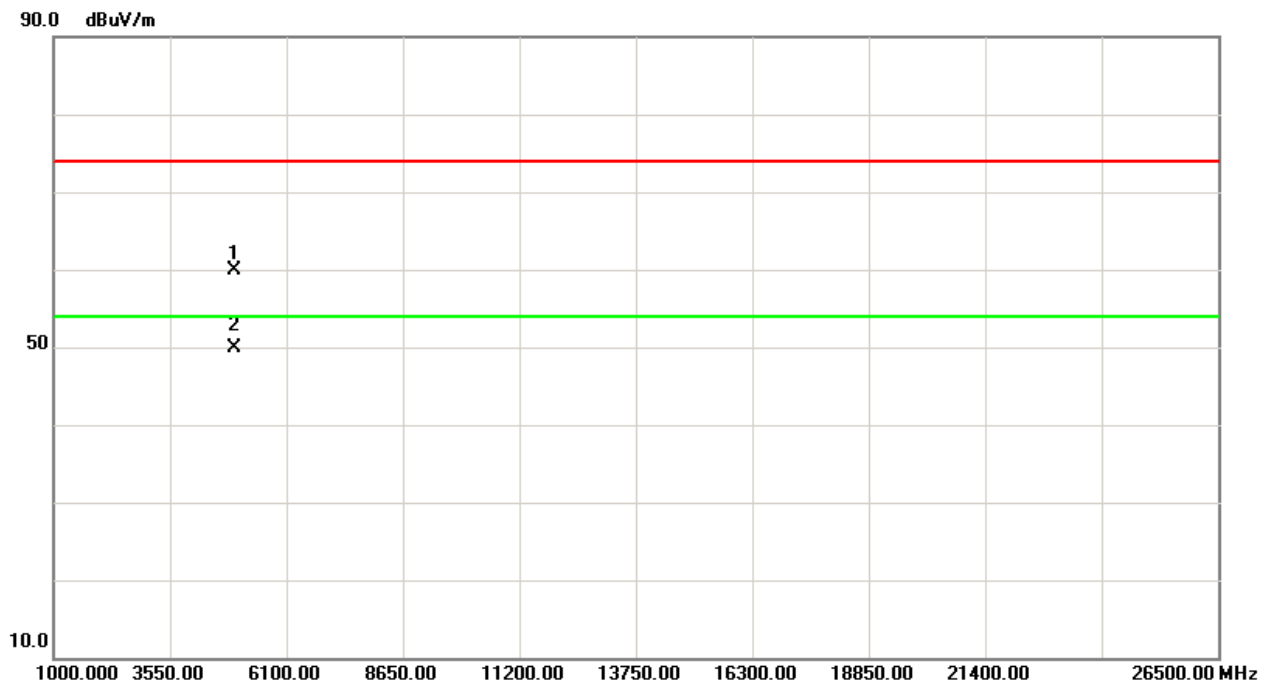
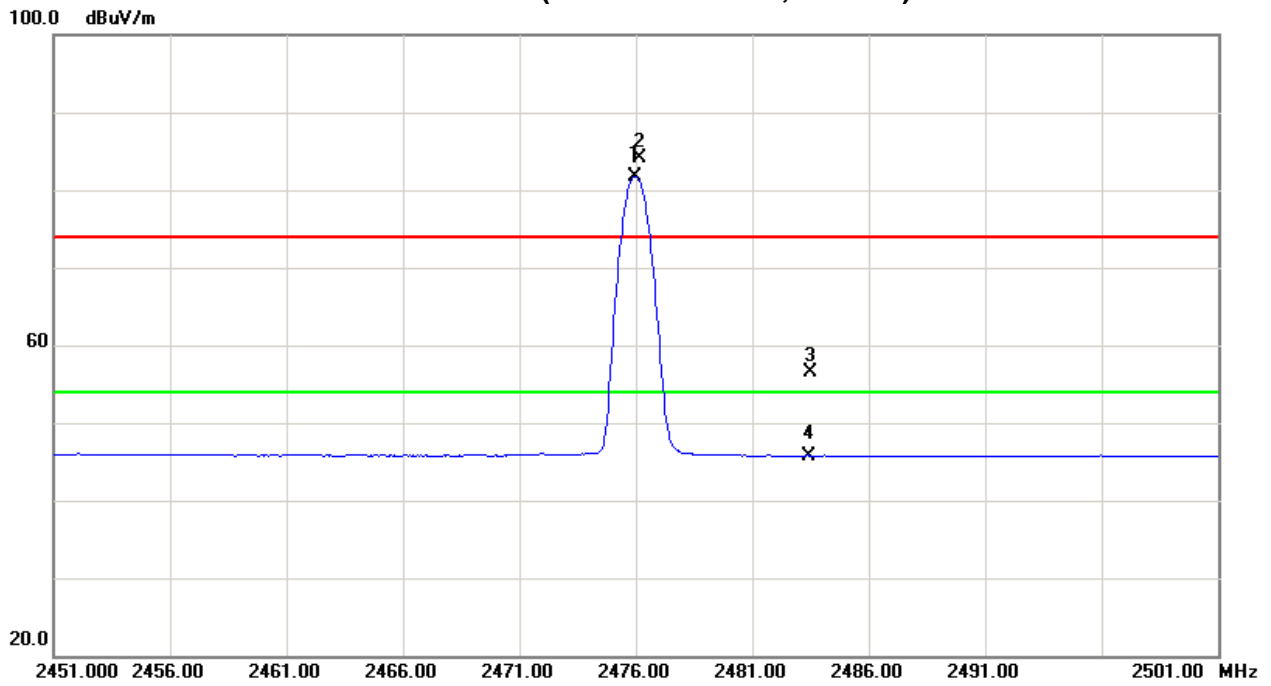



EUT :	AFTERGLOW PS3 WIRELESS DONGLE	Model Name :	PL-6422A
Temperature :	25 °C	Relative Humidity :	58 %
Pressure :	1010 hPa	Test Voltage :	AC 120V/60Hz
Test Mode :	TX 2476MHz		

Freq.	Ant.Pol.	Reading		Ant./CF	Act.		Limit		Margin		Note
		Peak	AV		Peak	AV	Peak	AV	Peak	AV	
(MHz)	H/V	(dBuV)	(dBuV)	CF(dB)	(dBuV/m)	(dBuV/m)	(dBuV/m)	(dBuV/m)	(dBuV/m)	(dBuV/m)	
2476.15	H	48.76	46.40	32.19	80.95	78.59					X/F
2483.50	H	23.19	13.58	32.17	55.36	45.75	74.00	54.00	-18.64	-8.25	X/E
4952.10	H	49.76	40.25	6.71	56.47	46.96	74.00	54.00	-17.53	-7.04	X/H

Remark :

- (1) All readings are Peak unless otherwise stated QP in column of 『Note』 . Peak denotes that the Peak reading compliance with the QP Limits and then QP Mode measurement didn't perform.
- (2) Measuring frequency range from 30MHz to 1000MHz or the 10th harmonic of highest fundamental frequency. "F" denotes fundamental frequency; "H" denotes spurious frequency. "E" denotes band edge frequency. (This judgment method includes the Band Edge Requirement.)
- (3) Radiated emissions measured in frequency range above 1000MHz were made with an instrument using Peak detector mode and AV detector mode of the emission .
- (4) Data of measurement within this frequency range shown " * " in the table above means the reading of emissions are attenuated more than 20dB below the permissible limits or the field strength is too small to be measured.
- (5) A preamp and high pass filter were used for this test in order to provide sufficient measurement sensitivity.
- (6) EUT Orthogonal Axis :
"X" - denotes Laid on Table ; "Y" - denotes Vertical Stand ; "Z" - denotes Side Stand
- (7) During the measurements above 1 GHz it is taken care of that the EUT is always within the 3 dB cone of radiation BW of the used antenna
- (8) Peak setting: RBW=1MHz, VBW=1MHz.
AVG setting: RBW=1MHz, VBW=10KHz.



TX 2476MHz(Above 1000 MHz, Horizontal)

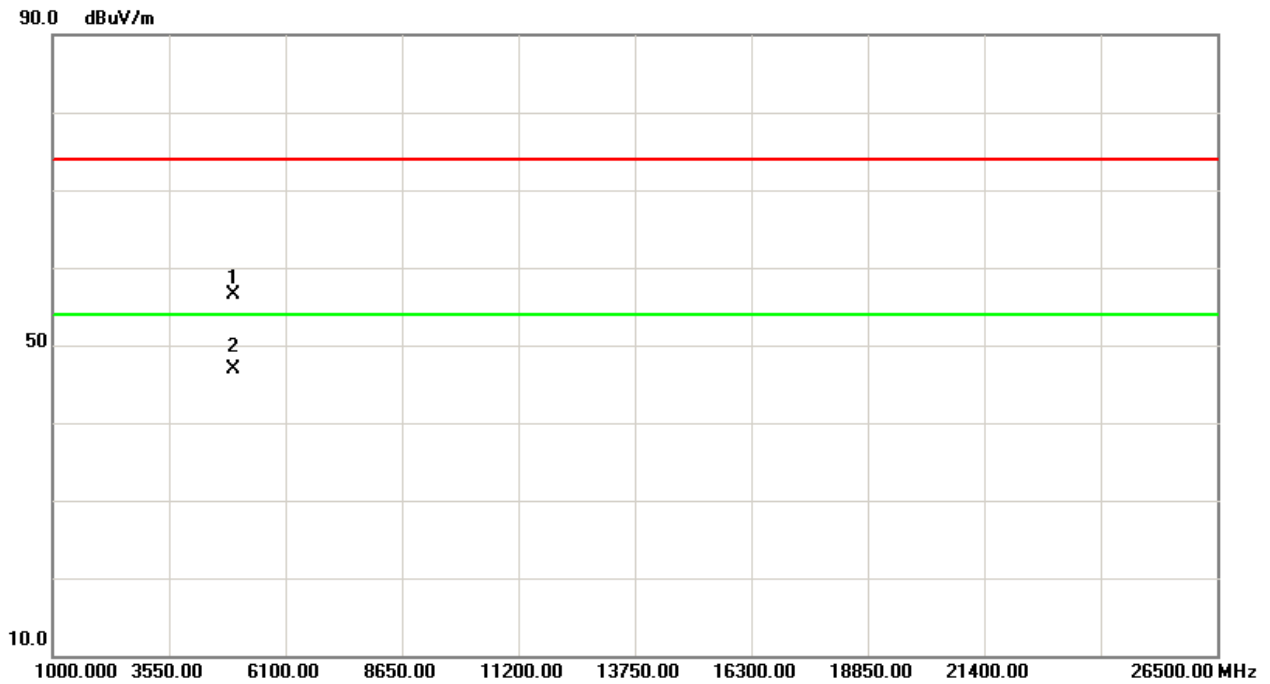
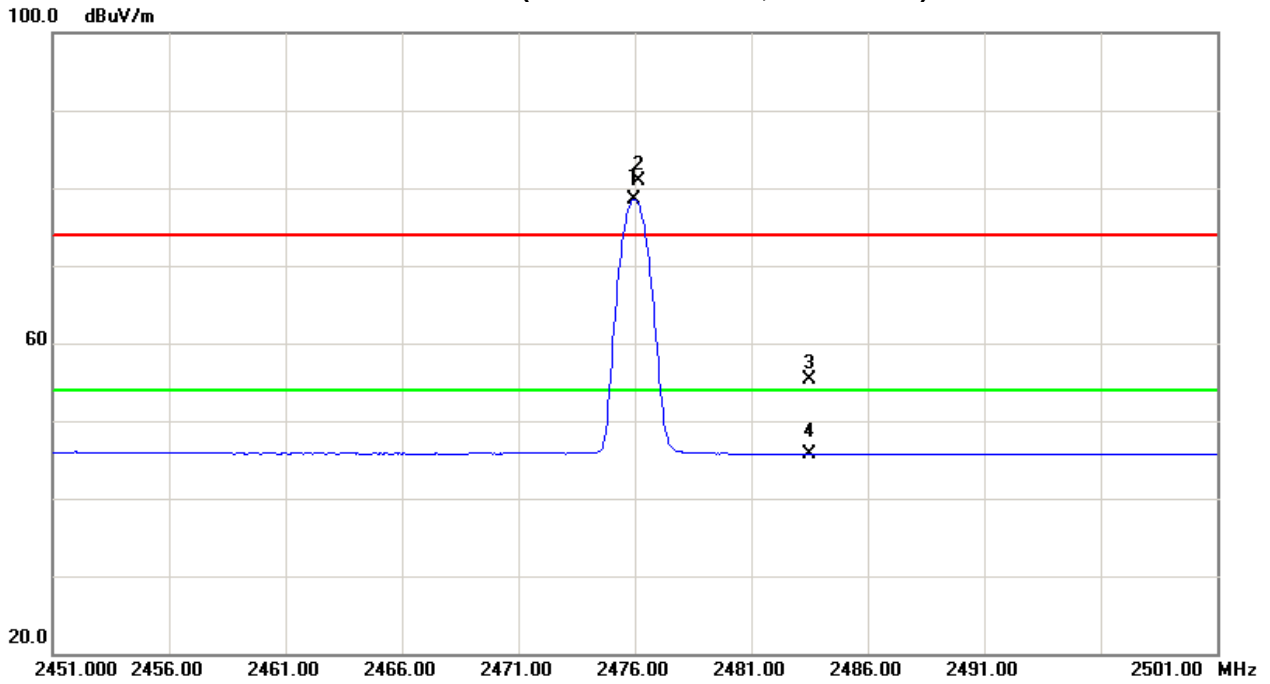



5. NUMBER OF HOPPING CHANNEL

5.1 APPLIED PROCEDURES / LIMIT

FCC Part15 (15.247) , Subpart C			
Section	Test Item	Frequency Range (MHz)	Result
15.247 (a)(1)(iii)	Number of Hopping Channel	2400-2483.5	PASS

5.1.1 MEASUREMENT INSTRUMENTS LIST AND SETTING

Item	Kind of Equipment	Manufacturer	Type No.	Serial No.	Calibrated until
1	Spectrum Analyzer	R&S	FSP 40	100185	Nov.25.2013

Remark: "N/A" denotes no model name, serial no. or calibration specified.

All calibration period of Equipment List is One Year.

Spectrum Parameters	Setting
Attenuation	Auto
Span Frequency	> Operating Frequency Range
RB	100 kHz
VB	100 kHz
Detector	Peak
Trace	Max Hold
Sweep Time	Auto

5.1.2 TEST PROCEDURE

- a. The EUT was directly connected to the spectrum analyzer and antenna output port as show in the block diagram below,
- b. Spectrum Setting : RBW= 100KHz, VBW=100KHz, Sweep time = Auto.

5.1.3 DEVIATION FROM STANDARD

No deviation.

5.1.4 TEST SETUP

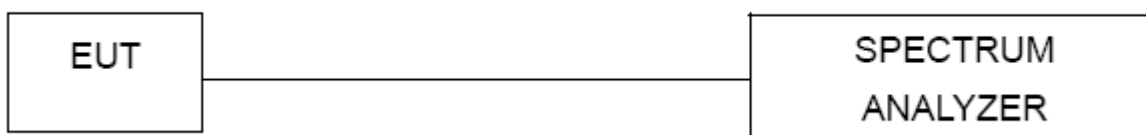

5.1.5 EUT OPERATION CONDITIONS

The EUT tested system was configured as the statements of 4.1.6 Unless otherwise a special operating condition is specified in the follows during the testing.



5.1.6 TEST RESULTS

EUT :	AFTERGLOW PS3 WIRELESS DONGLE	Model Name :	PL-6422A
Temperature :	25 °C	Relative Humidity :	58 %
Pressure :	1009 hPa	Test Voltage :	AC 120V/60Hz
Test Mode :	Hopping Mode		

Number of Hopping Channel	23
---------------------------	----

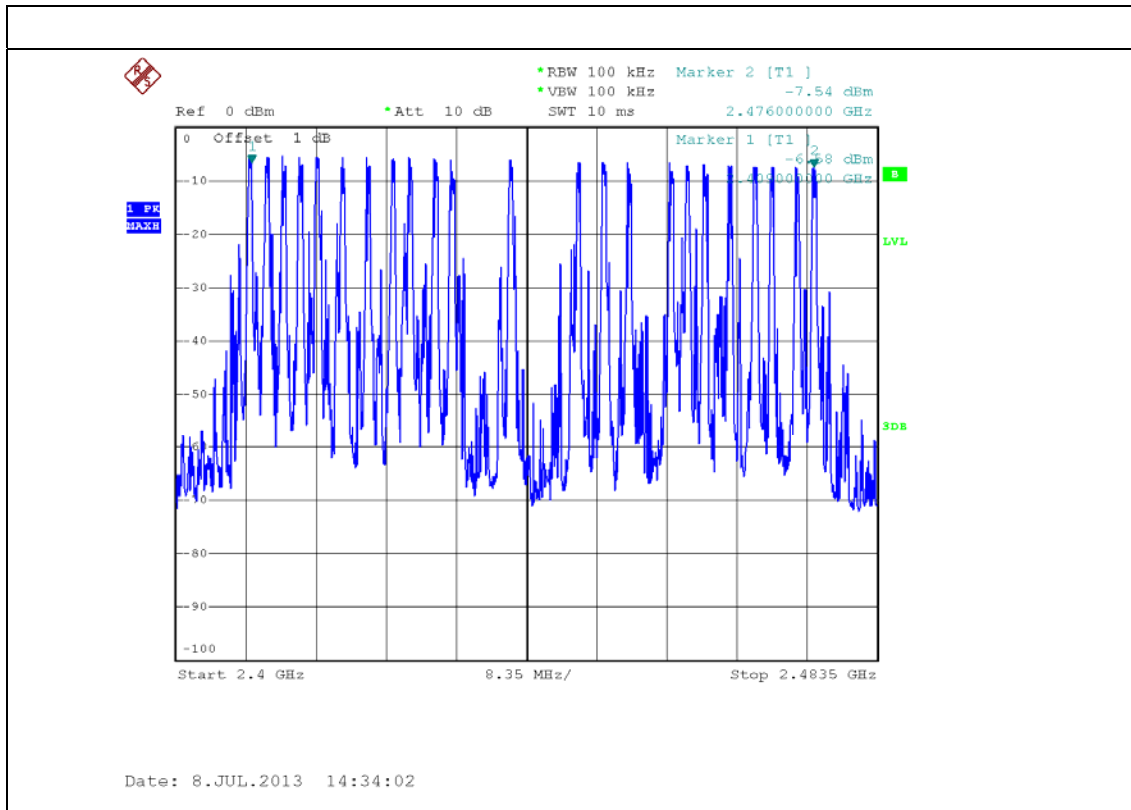

6. AVERAGE TIME OF OCCUPANCY

6.1 APPLIED PROCEDURES / LIMIT

FCC Part15 (15.247) , Subpart C				
Section	Test Item	Limit	Frequency Range (MHz)	Result
15.247 (a)(1)(iii)	Average Time of Occupancy	0.4sec	2400-2483.5	PASS

6.1.1 MEASUREMENT INSTRUMENTS LIST

Item	Kind of Equipment	Manufacturer	Type No.	Serial No.	Calibrated until
1	Spectrum Analyzer	R&S	FSP 40	100185	Nov.25.2013

Remark: "N/A" denotes no model name, serial no. or calibration specified.
All calibration period of Equipment List is One Year.

6.1.2 TEST PROCEDURE

- The transmitter output (antenna port) was connected to the spectrum analyzer
- Set RBW of spectrum analyzer to 1MHz and VBW to 1MHz.
- Use a video trigger with the trigger level set to enable triggering only on full pulses.
- Sweep Time is more than once pulse time.
- Set the center frequency on any frequency would be measure and set the frequency span to zero span.
- Measure the maximum time duration of one single pulse.
- Set the EUT for packet transmitting.
- Measure the maximum time duration of one single pulse.
- Dwell time = [spreading rate/16] x duty-cycle x 0.4 seconds

6.1.3. TEST SETUP LAYOUT

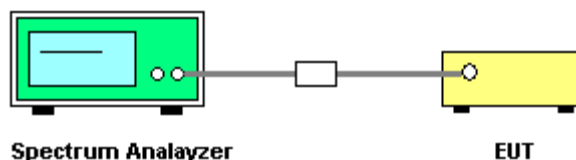

6.1.4. TEST DEVIATION

There is no deviation with the original standard.

6.1.5. EUT OPERATION DURING TEST

The EUT was programmed to be in continuously transmitting/Hopping mode.



6.1.6. TEST RESULTS

EUT :	AFTERGLOW PS3 WIRELESS DONGLE	Model Name :	PL-6422A
Temperature :	25 °C	Relative Humidity :	58 %
Pressure :	1009 hPa	Test Voltage :	AC 120V/60Hz
Test Mode :	Hopping Mode		

Mode	Number of transmission in a 9.2 (23Hopping*0.4)	Length of transmission time (msec)	Result (msec)	Limit (msec)
2476 MHz	(5/1) *9.2=46 times Note1	1.48	68.08	400

Note1: 5 times of occupied channels per 1 second.

	Results
Measured cycle (sec)	23 CH*0.4=9.2
The total number of frequency-hopping per second	((5/1)*9.2)=46
The number of occupied channels per second	46/9.2=5(number/sec)
occupied time for each channel(1)	1.48ms
The total number of channels occupied within one cycle (2)	(5/1) *9.2=46 times
The average time of occupancy within one cycle(1)*(2)	68.08msec
LIMIT (msec)	400msec

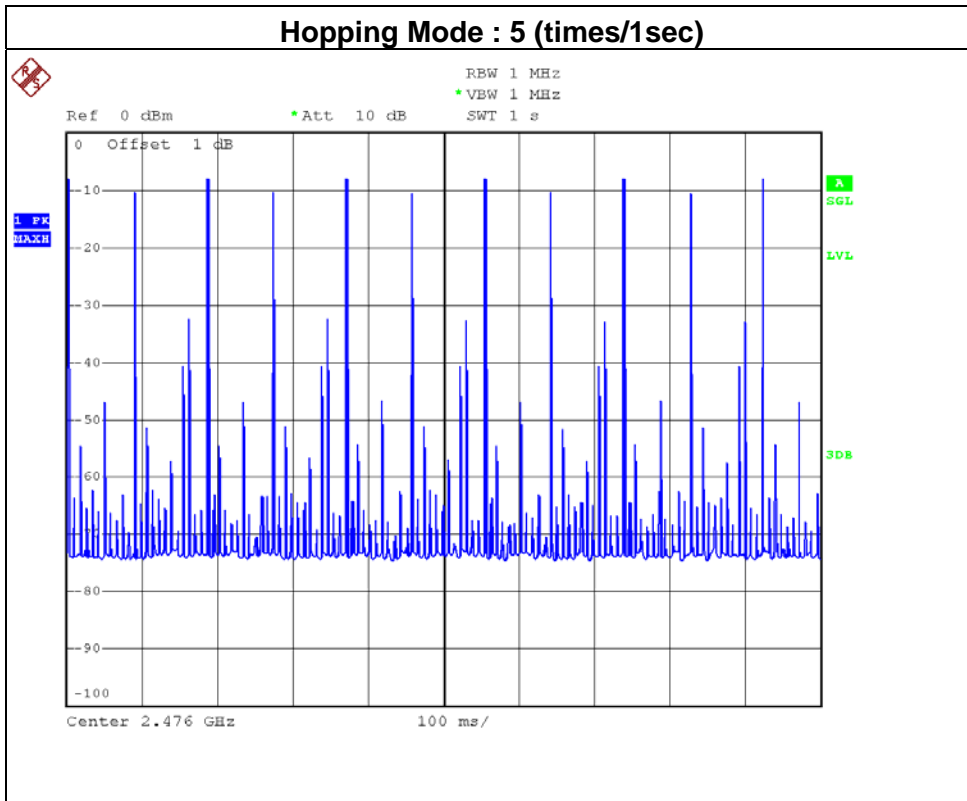

Date: 8.JUL.2013 15:34:35

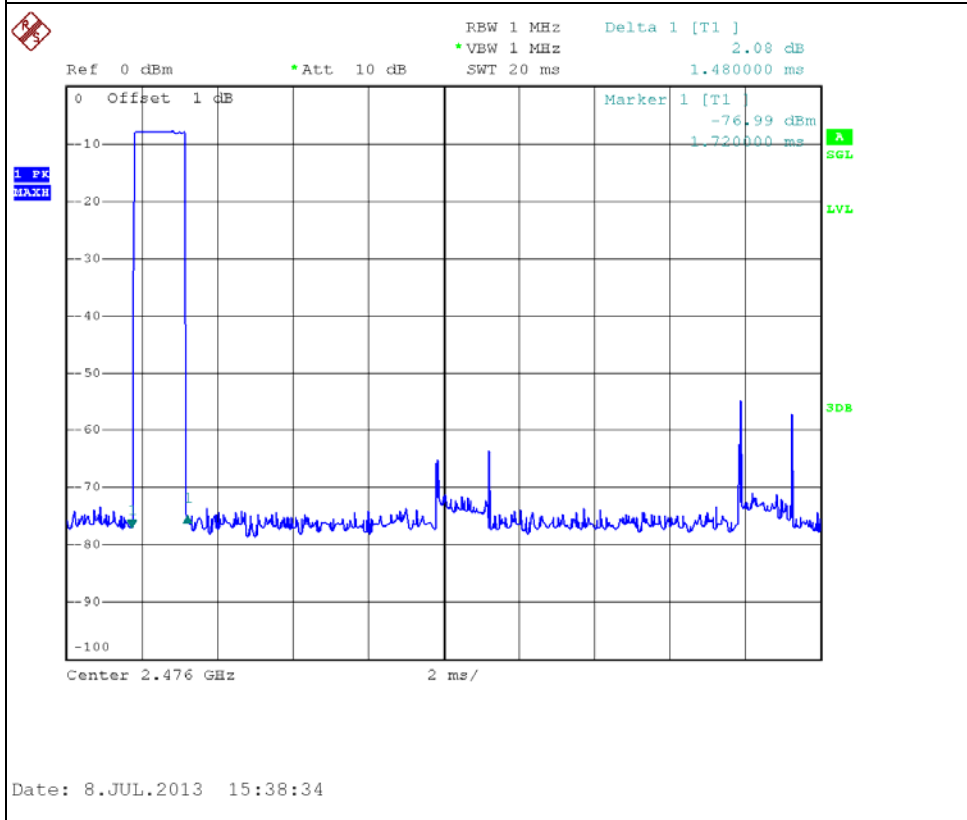

Date: 8.JUL.2013 15:38:34

7. HOPPING CHANNEL SEPARATION MEASUREMENT

7.1 APPLIED PROCEDURES / LIMIT

Frequency hopping systems operating in the 2400-2483.5 MHz band may have hopping channel carrier frequencies that are separated by 25 kHz or two-thirds of the 20 dB bandwidth of the hopping channel, whichever is greater.

7.1.1 MEASUREMENT INSTRUMENTS LIST AND SETTING

Item	Kind of Equipment	Manufacturer	Type No.	Serial No.	Calibrated until
1	Spectrum Analyzer	R&S	FSP 40	100185	Nov.25.2013

Remark: "N/A" denotes no model name, serial no. or calibration specified.

All calibration period of Equipment List is One Year.

Spectrum Parameter	Setting
Attenuation	Auto
Span Frequency	> Measurement Bandwidth or Channel Separation
RB	30 kHz
VB	100 kHz
Detector	Peak
Trace	Max Hold
Sweep Time	Auto

7.1.2 TEST PROCEDURE

- a. The EUT must have its hopping function enabled
- b. Span = wide enough to capture the peaks of two adjacent channels
 Resolution (or IF) Bandwidth (RBW) \geq 1% of the span
 Video (or Average) Bandwidth (VBW) \geq RBW
 Sweep = auto
 Detector function = peak
 Trace = max hold

7.1.3 DEVIATION FROM STANDARD

No deviation.

7.1.4 TEST SETUP

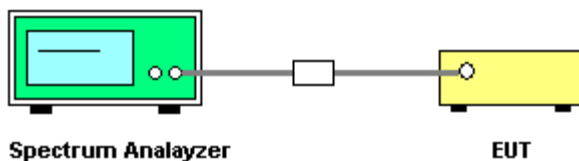

7.1.5 EUT OPERATION CONDITIONS

The EUT was programmed to be in hopping mode.



7.1.6 TEST RESULTS

EUT :	AFTERGLOW PS3 WIRELESS DONGLE	Model Name :	PL-6422A
Temperature :	25 °C	Relative Humidity :	58 %
Pressure :	1009 hPa	Test Voltage :	AC 120V/60Hz
Test Mode :	CH01		

Frequency (MHz)	Ch. Separation (MHz)	20dB Bandwidth (MHz)	Result
2409	1.993	2.570	Complies

Ch. Separation Limits: >20dB bandwidth or >2/3 of 20dB bandwidth

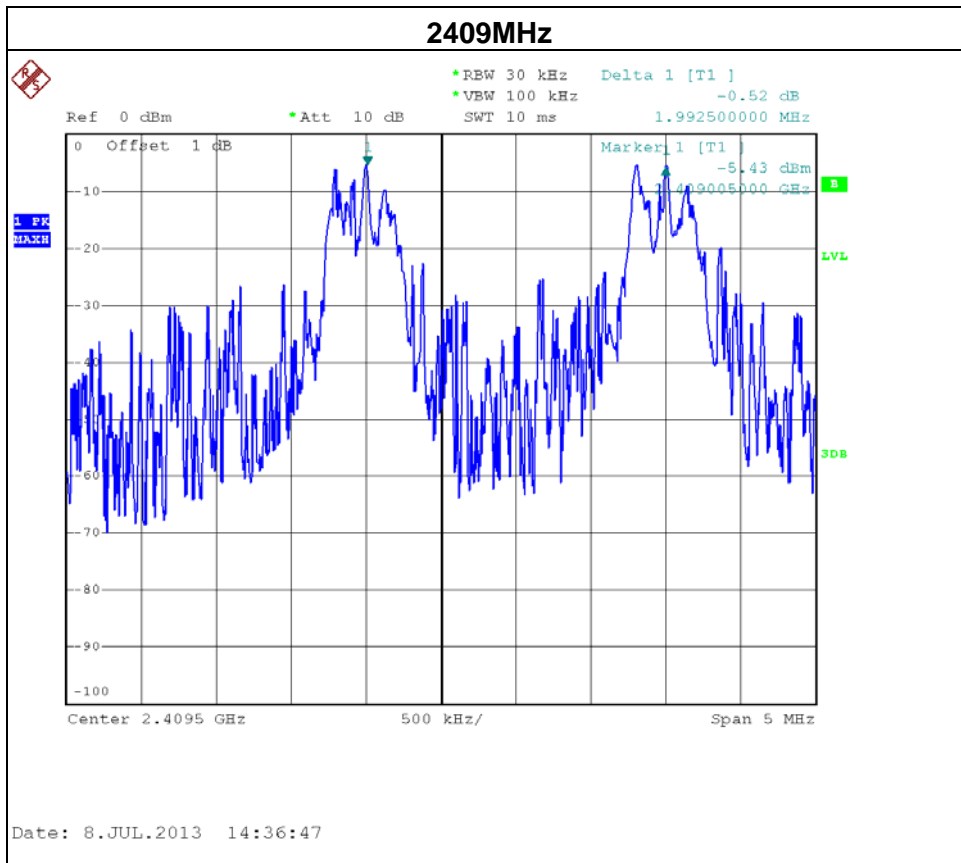



8. BANDWIDTH TEST

8.1 APPLIED PROCEDURES / LIMIT

FCC Part15 (15.247) , Subpart C			
Section	Test Item	Frequency Range (MHz)	Result
15.247 (a)(1)	Bandwidth	2400-2483.5	PASS

8.1.1 MEASUREMENT INSTRUMENTS LIST AND SETTING

Item	Kind of Equipment	Manufacturer	Type No.	Serial No.	Calibrated until
1	Spectrum Analyzer	R&S	FSP 40	100185	Nov.25.2013

Remark: "N/A" denotes no model name, serial no. or calibration specified.
All calibration period of Equipment List is One Year.

Spectrum Parameter	Setting
Attenuation	Auto
Span Frequency	> Measurement Bandwidth or Channel Separation
RB	30 kHz (20dB Bandwidth) / 30 kHz (Channel Separation)
VB	100 kHz (20dB Bandwidth) / 100 kHz (Channel Separation)
Detector	Peak
Trace	Max Hold
Sweep Time	Auto

8.1.2 TEST PROCEDURE

- a. The EUT was directly connected to the spectrum analyzer and antenna output port as show in the block diagram below,
- b. Spectrum Setting : RBW= 30KHz, VBW=100KHz, Sweep time = Auto.

8.1.3 DEVIATION FROM STANDARD

No deviation.

8.1.4 TEST SETUP



8.1.5 EUT OPERATION CONDITIONS

The EUT tested system was configured as the statements of 4.1.6 Unless otherwise a special operating condition is specified in the follows during the testing.



8.1.6 TEST RESULTS

EUT :	AFTERGLOW PS3 WIRELESS DONGLE	Model Name :	PL-6422A
Temperature :	25 °C	Relative Humidity :	58 %
Pressure :	1009 hPa	Test Voltage :	AC 120V/60Hz
Test Mode :	CH01 / CH30 / CH63		

Frequency (MHz)	20dB Bandwidth (MHz)	99% Occupied Bandwidth (MHz)	Result
2409	2.570	2.998	PASS
2440	2.730	2.978	PASS
2476	2.453	2.910	PASS

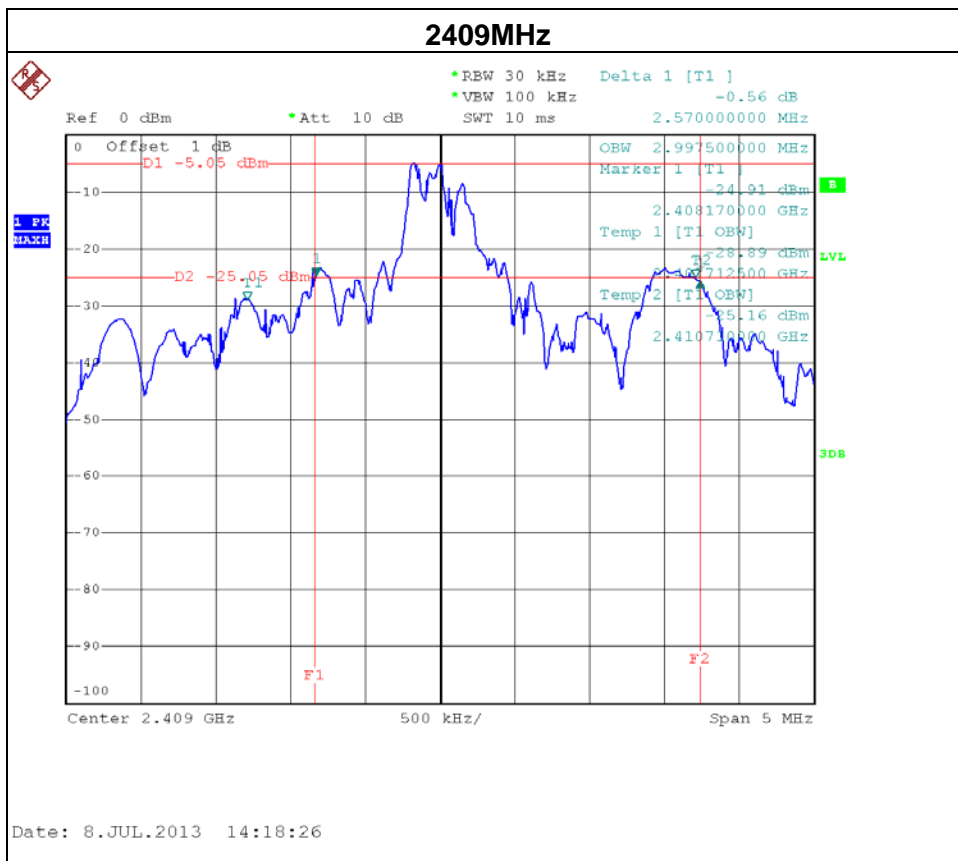

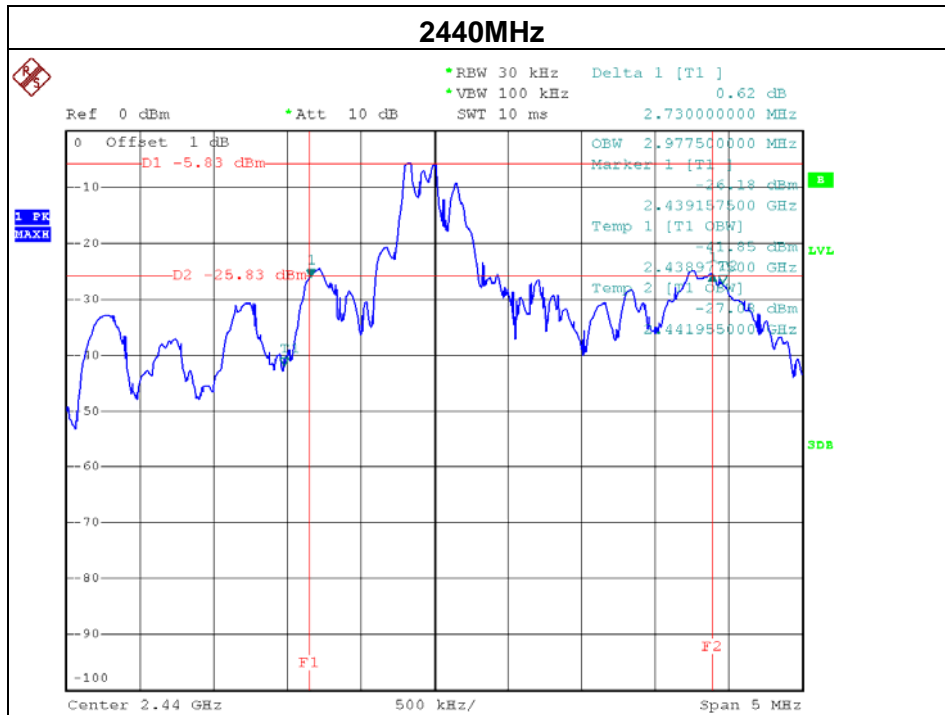

Date: 8.JUL.2013 14:20:18

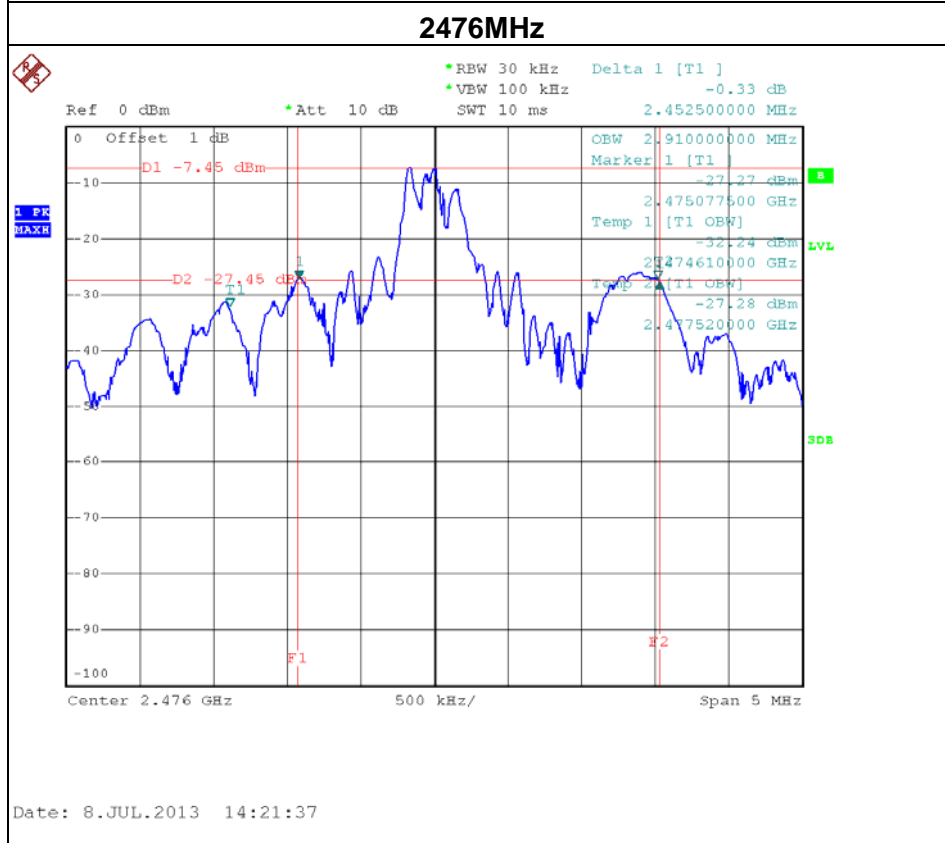

Date: 8.JUL.2013 14:21:37



9. PEAK OUTPUT POWER TEST

9.1 APPLIED PROCEDURES / LIMIT

FCC Part15 (15.247) , Subpart C				
Section	Test Item	Limit	Frequency Range (MHz)	Result
15.247 (b)(1)	Peak Output Power	0.125 watt or 21dBm	2400-2483.5	PASS

9.1.1 MEASUREMENT INSTRUMENTS LIST AND SETTING

Item	Kind of Equipment	Manufacturer	Type No.	Serial No.	Calibrated until
1	Spectrum Analyzer	R&S	FSP 40	100185	Nov.25.2013

Remark: "N/A" denotes no model name, serial no. or calibration specified.
 All calibration period of Equipment List is One Year.

9.1.2 TEST PROCEDURE

- a. The EUT was directly connected to the Spectrum Analyzer and antenna output port as show in the block diagram below,

9.1.3 DEVIATION FROM STANDARD

No deviation.

9.1.4 TEST SETUP



9.1.5 EUT OPERATION CONDITIONS

The EUT tested system was configured as the statements of 4.1.6 Unless otherwise a special operating condition is specified in the follows during the testing.



9.1.6 TEST RESULTS

EUT :	AFTERGLOW PS3 WIRELESS DONGLE	Model Name :	PL-6422A
Temperature :	25 °C	Relative Humidity :	58 %
Pressure :	1009 hPa	Test Voltage :	AC 120V/60Hz
Test Mode :	CH01 / CH30 / CH63		

Frequency (MHz)	Peak Output Power (dBm)	LIMIT (dBm)	LIMIT (W)
2409	-5.26	21	0.125
2440	-6.46	21	0.125
2476	-7.98	21	0.125

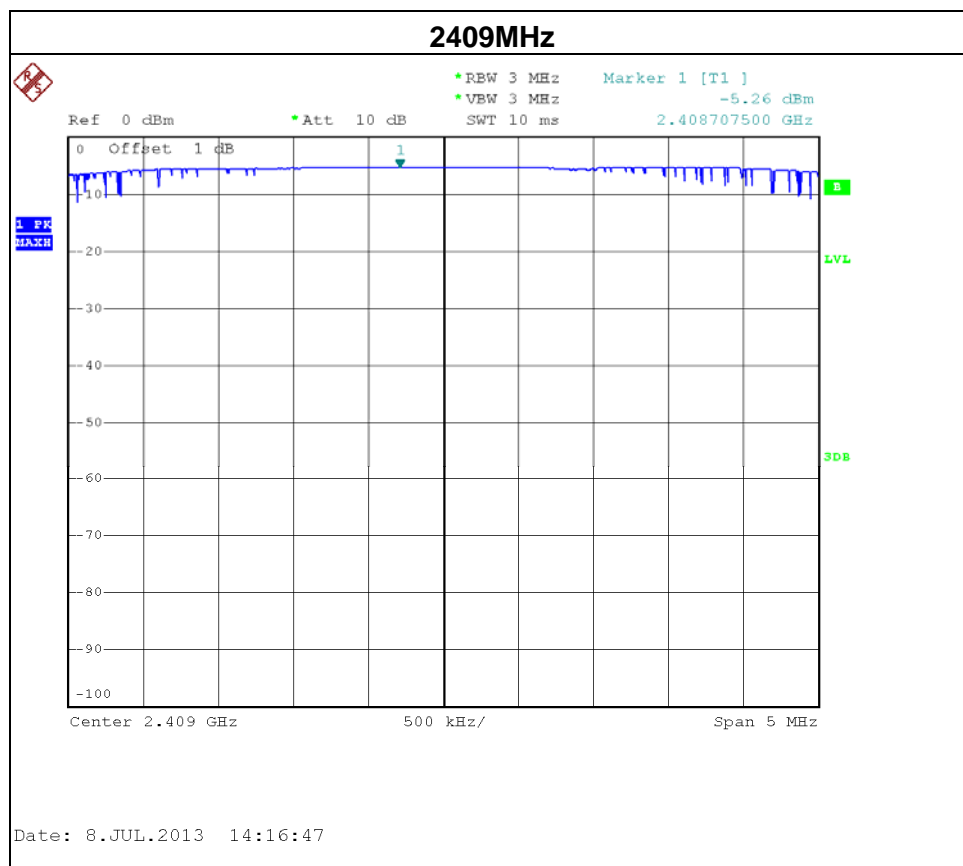

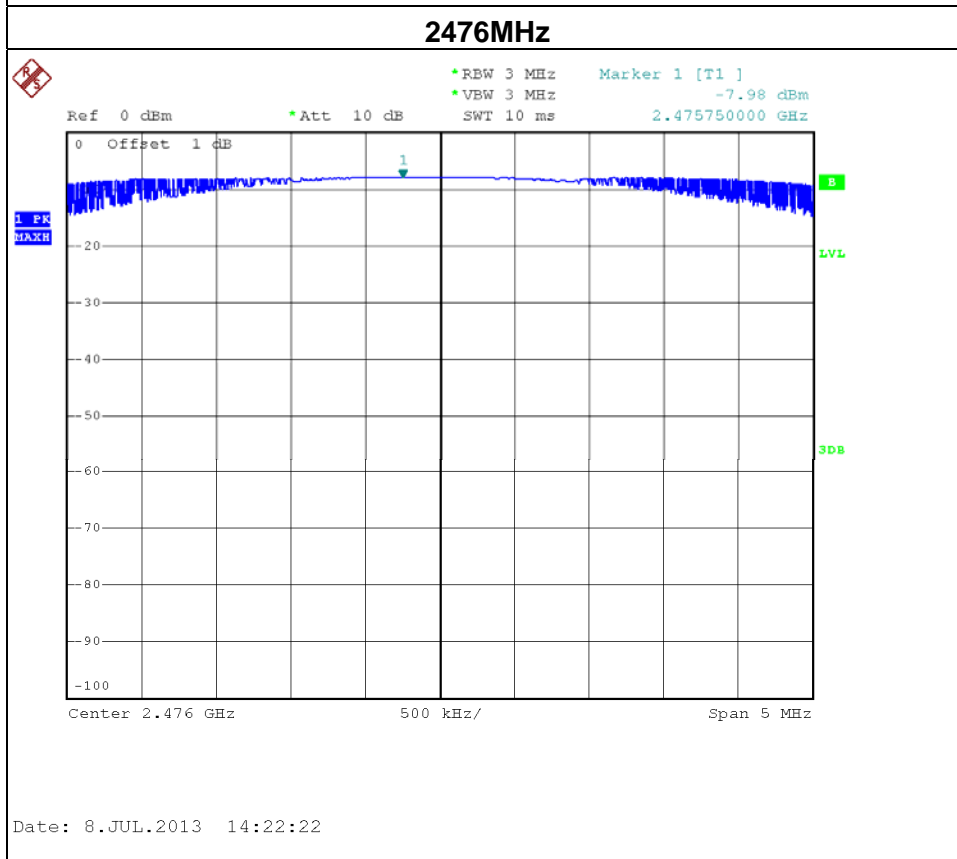
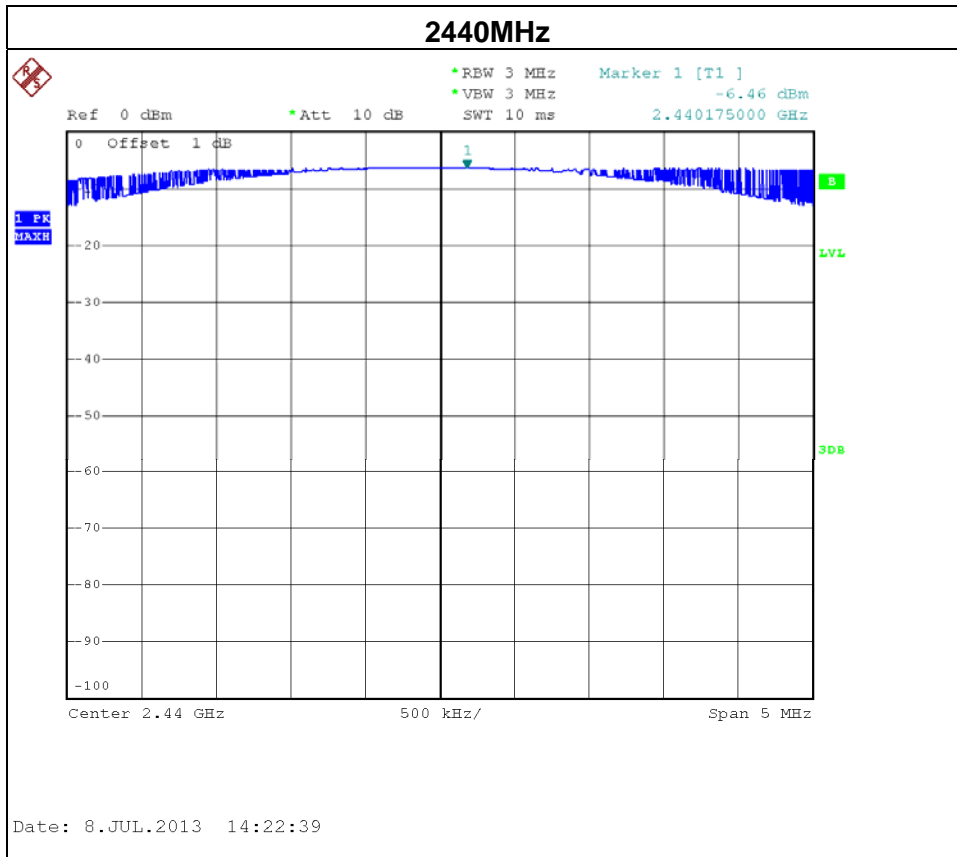



10. ANTENNA CONDUCTED SPURIOUS EMISSION

10.1 APPLIED PROCEDURES / LIMIT

20dBc in any 100 kHz bandwidth outside the operating frequency band. In case the emission fall within the restricted band specified on 15.205(a), then the 15.209(a) limit in the table below has to be followed.

Frequencies (MHz)	Field Strength (micorvolts/meter)	Measurement Distance (meters)
0.009~0.490	2400/F(KHz)	300
0.490~1.705	24000/F(KHz)	30
1.705~30.0	30	30
30~88	100	3
88~216	150	3
216~960	200	3
Above 960	500	3

10.1.1 MEASUREMENT INSTRUMENTS LIST AND SETTING

Item	Kind of Equipment	Manufacturer	Type No.	Serial No.	Calibrated until
1	Spectrum Analyzer	R&S	FSP 40	100185	Nov.25.2013

Remark: "N/A" denotes no model name, serial no. or calibration specified.
All calibration period of Equipment List is One Year.

10.1.2 TEST PROCEDURE

- a. The EUT was directly connected to the spectrum analyzer and antenna output port as show in the block diagram below,
- b. Spectrum Setting : RBW= 100KHz, VBW=100KHz, Sweep time = Auto.

10.1.3 DEVIATION FROM STANDARD

No deviation.

10.1.4 TEST SETUP



10.1.5 EUT OPERATION CONDITIONS

The EUT tested system was configured as the statements of 4.1.6 Unless otherwise a special operating condition is specified in the follows during the testing.



10.1.6 TEST RESULTS

EUT :	AFTERGLOW PS3 WIRELESS DONGLE	Model Name :	PL-6422A
Temperature :	25 °C	Relative Humidity :	58 %
Pressure :	1009 hPa	Test Voltage :	AC 120V/60Hz
Test Mode :	CH01 / CH09 / CH19 & Hopping on mode		

The max. radio frequency power in any 100kHz bandwidth outside the frequency band		The max. radio frequency power in any 100 kHz bandwidth within the frequency band.	
FREQUENCY(MHz)	POWER(dBm)	FREQUENCY(MHz)	POWER(dBm)
2324.45	-50.14	2483.50	-60.08

Result

In any 100kHz bandwidth outside the frequency band, the radio frequency power is at least 20dB below that in the 100kHz bandwidth within the band that contains the highest level of the desired power.

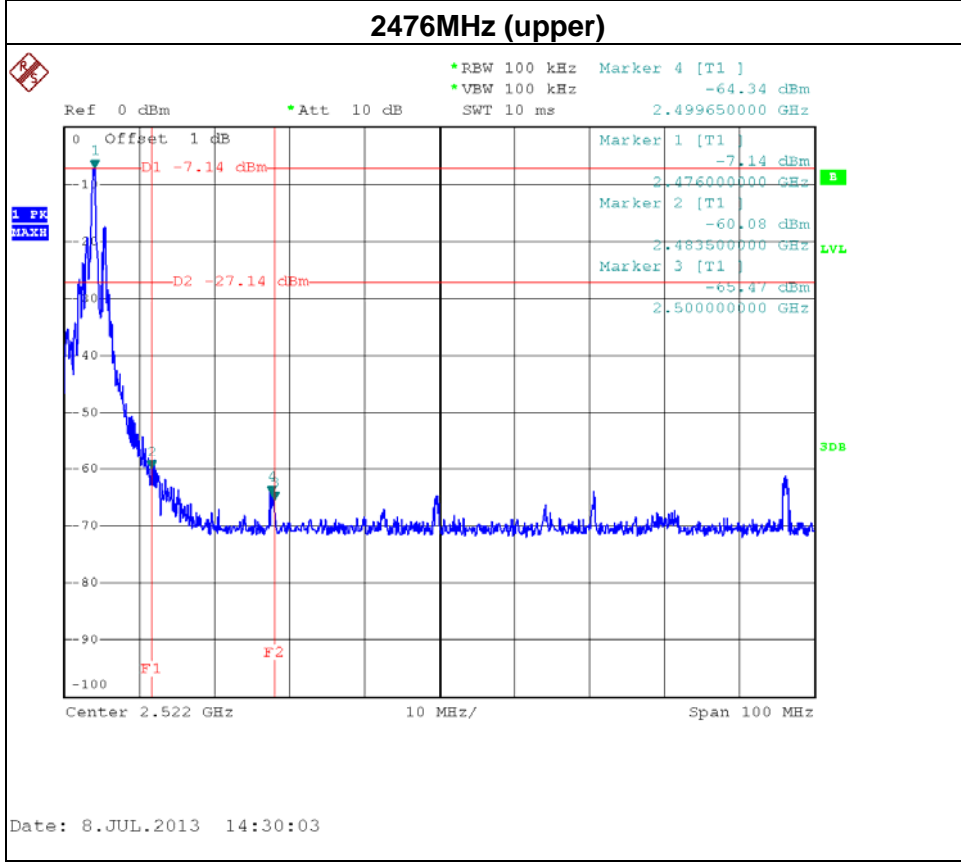
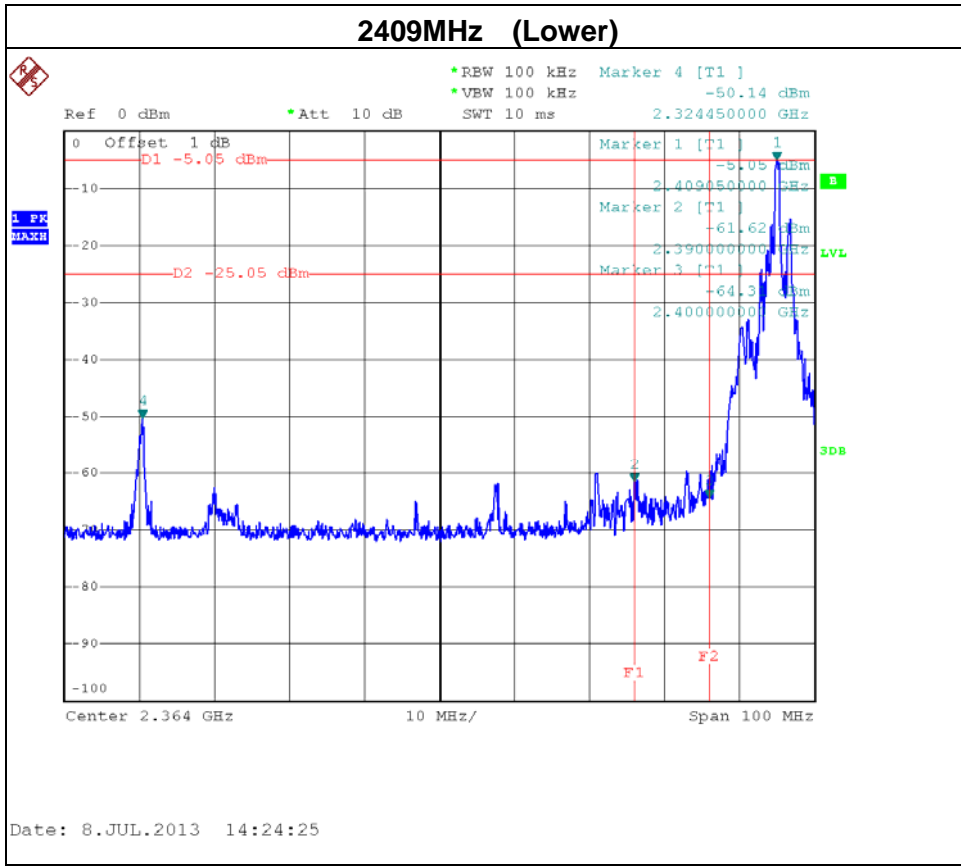



Hopping on mode (Lower)

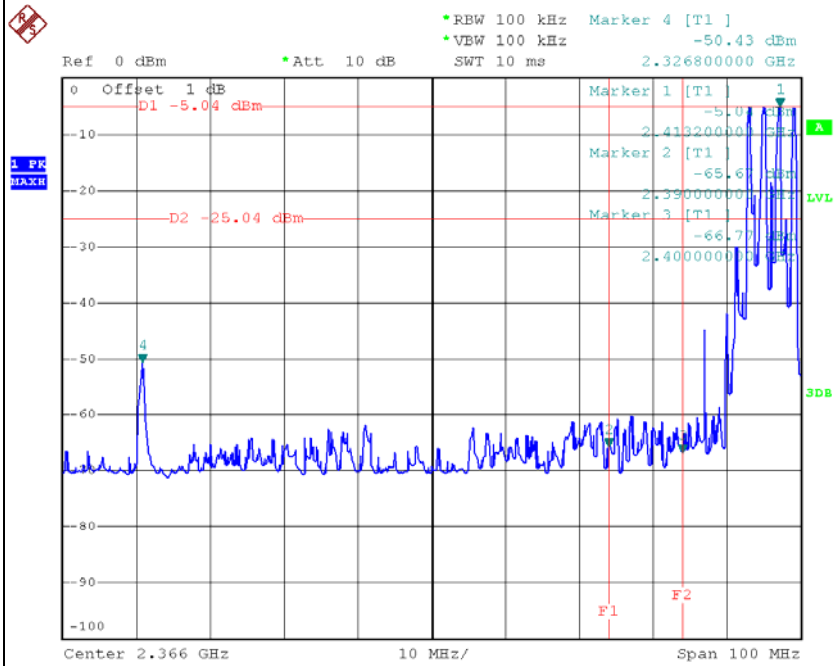

Date: 8.JUL.2013 14:48:34

Hopping on mode (upper)

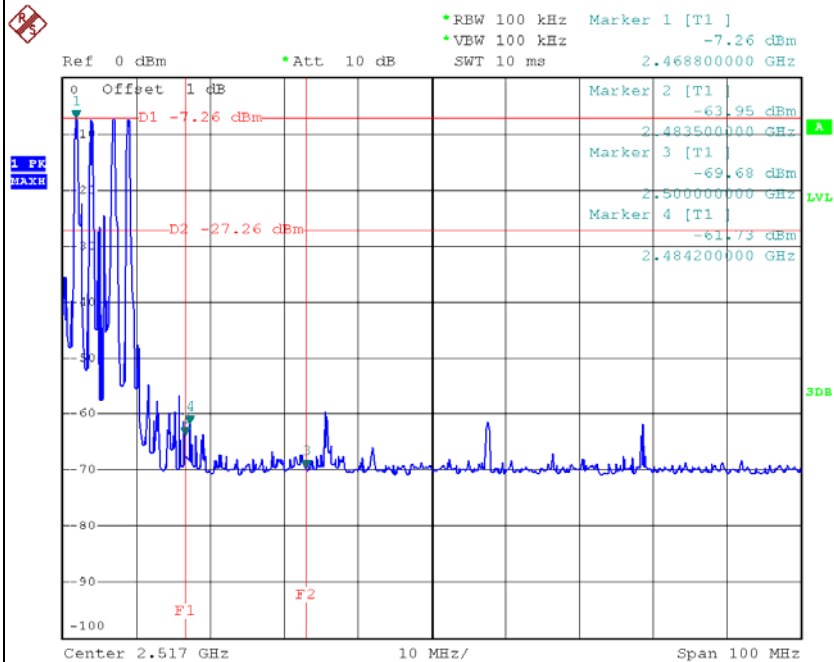

Date: 8.JUL.2013 14:46:54

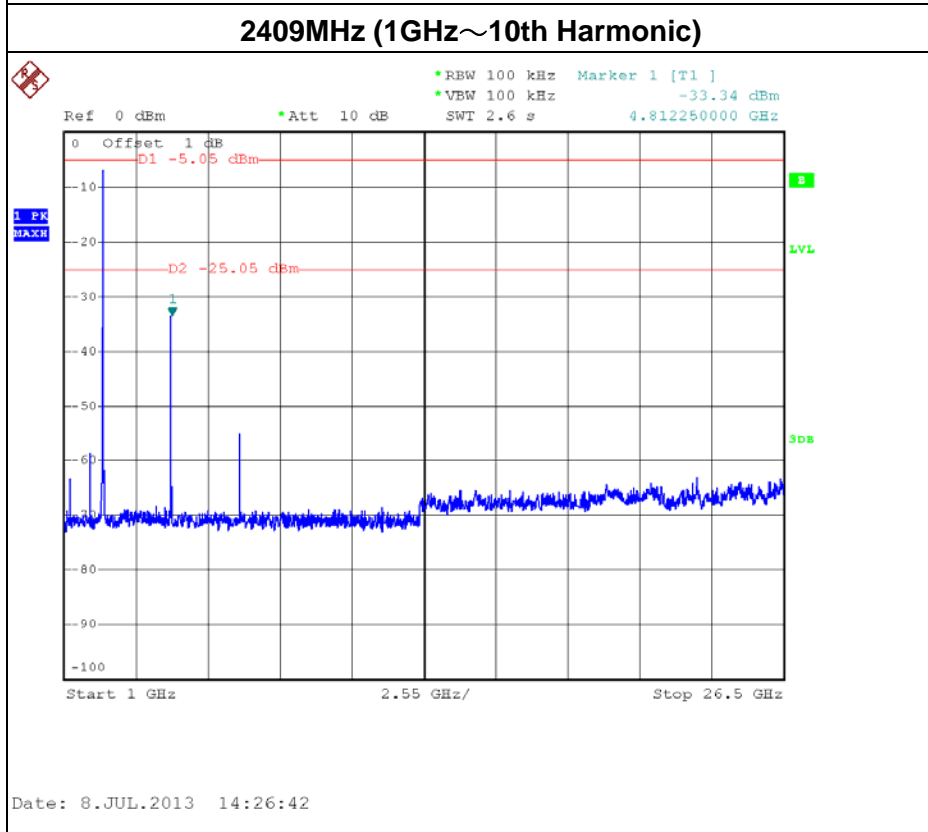
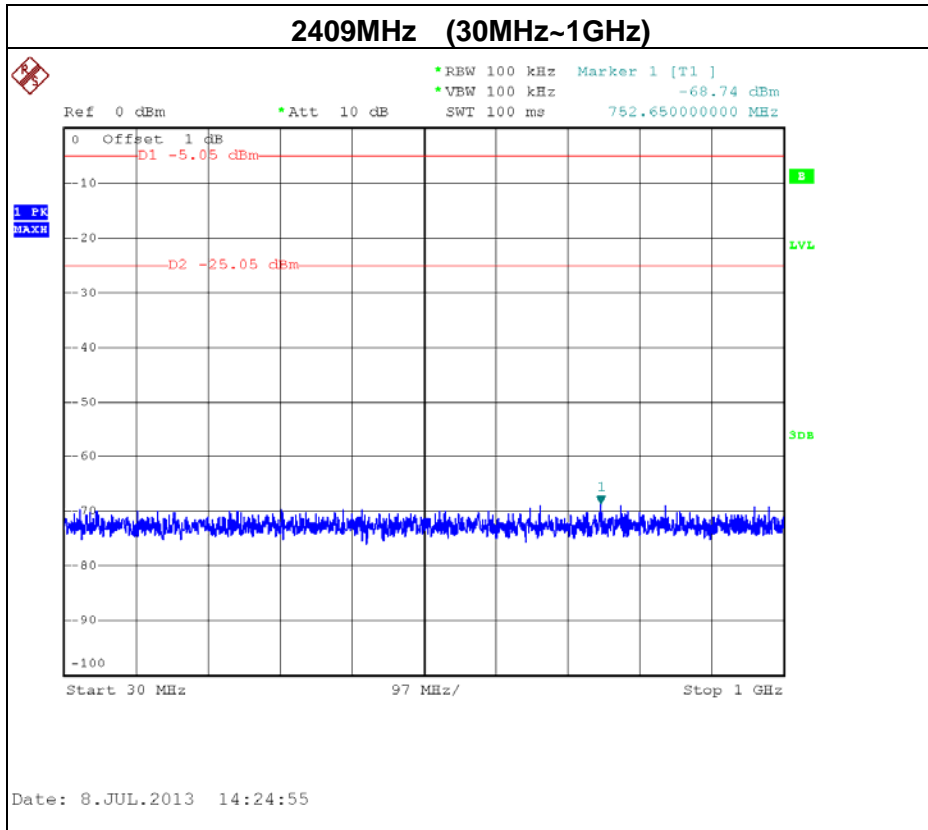

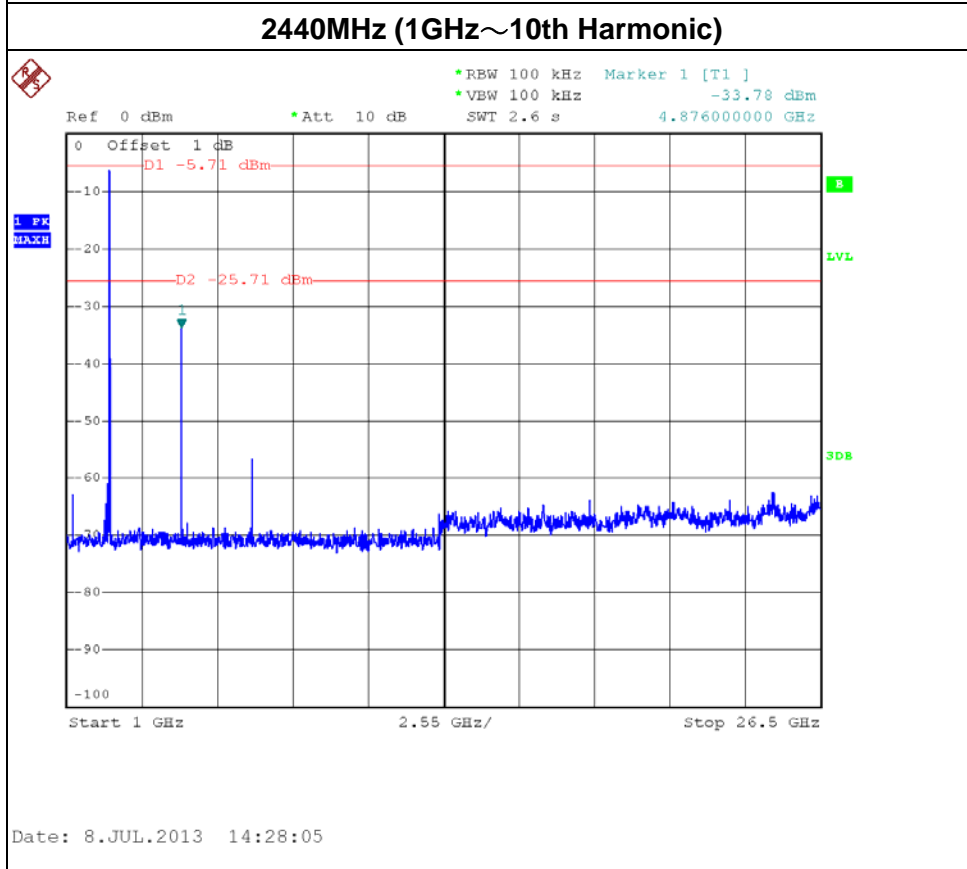
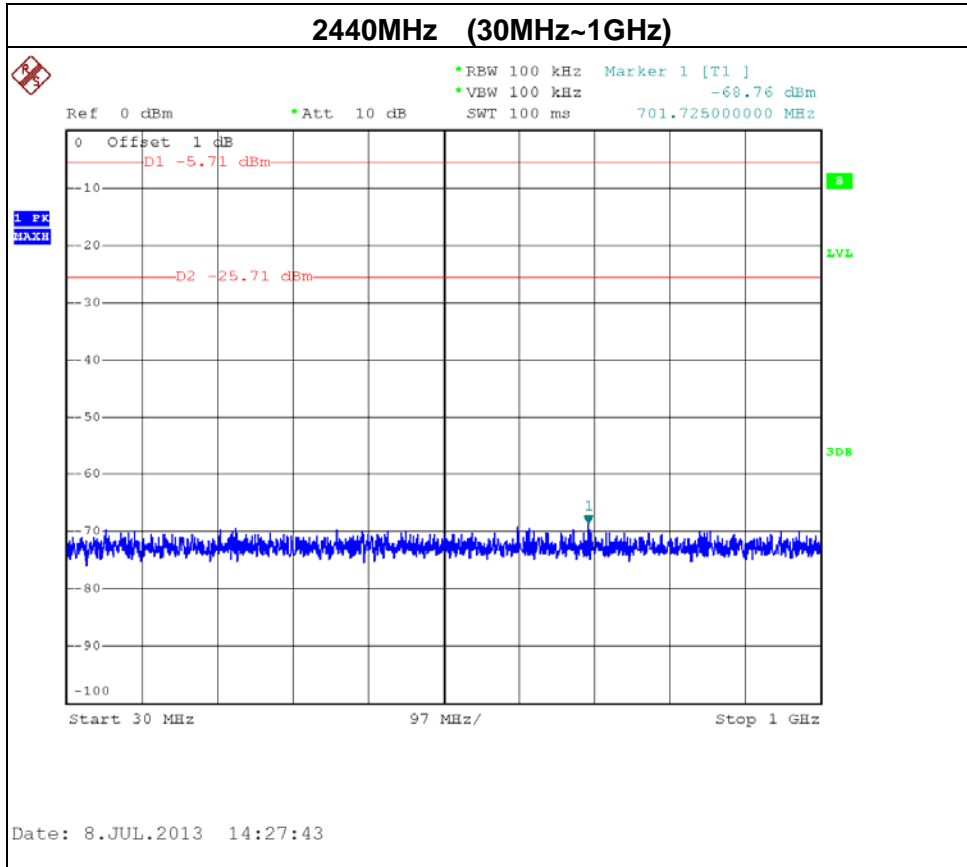

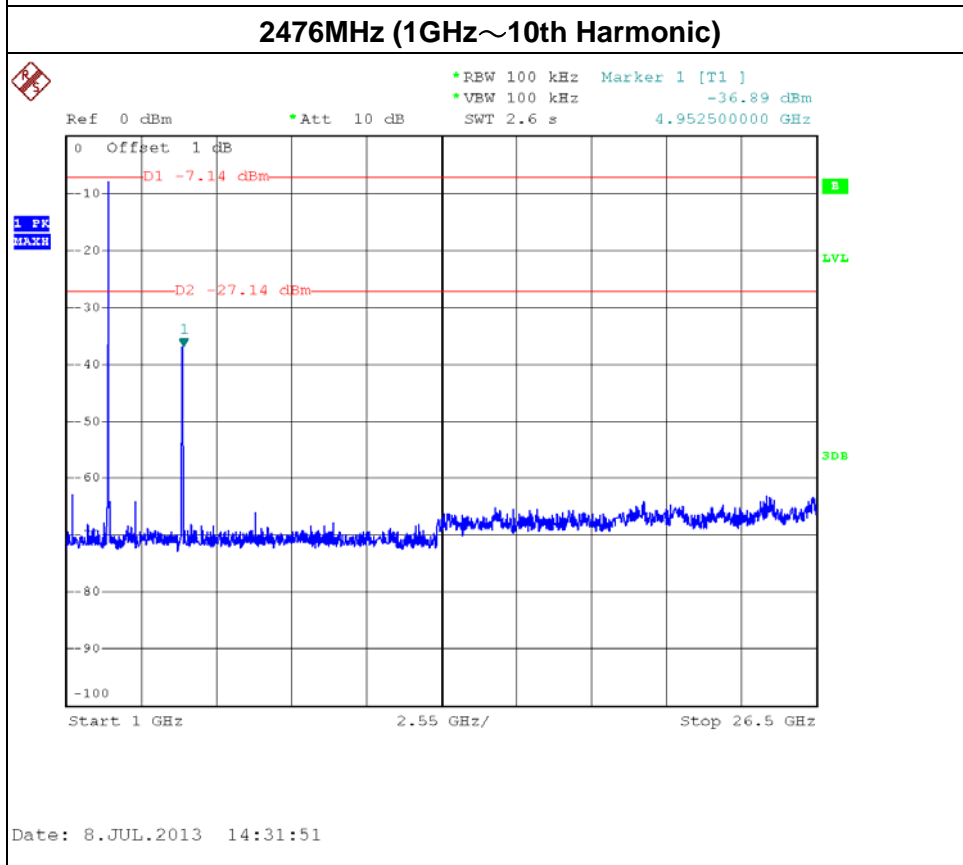
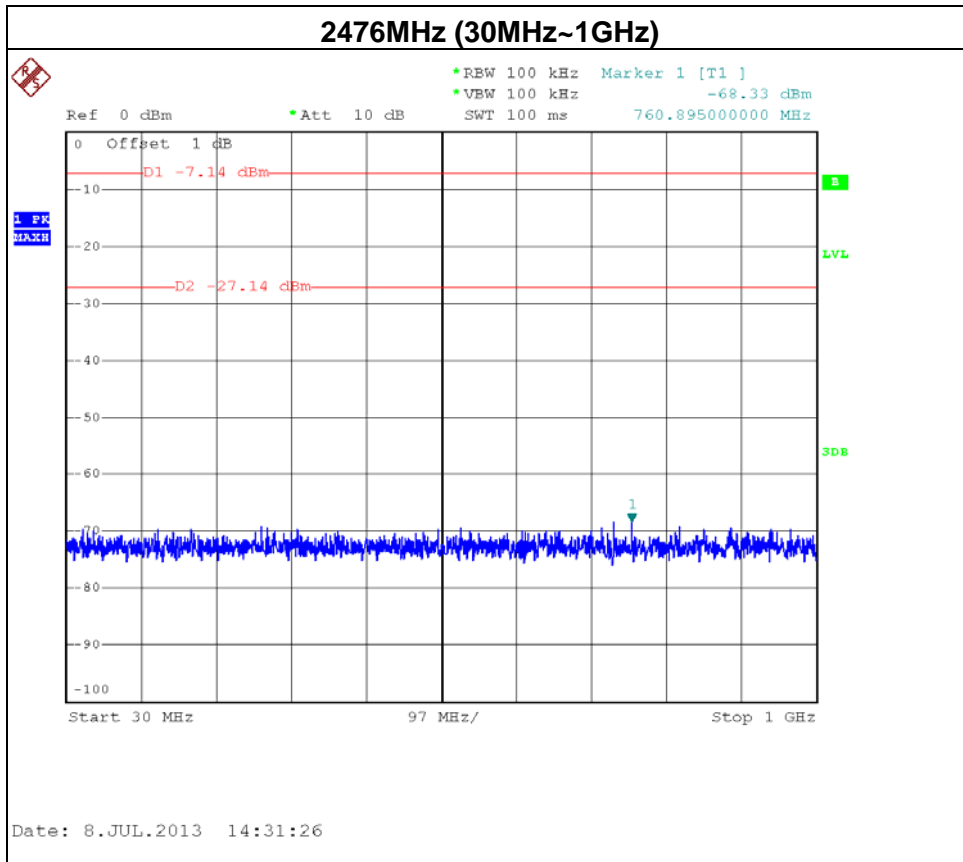



11. EUT PHOTOS

Conducted Measurement Photos





**Radiated Measurement Photos
9K~30MHz**





**Radiated Measurement Photos
30~1000MHz**

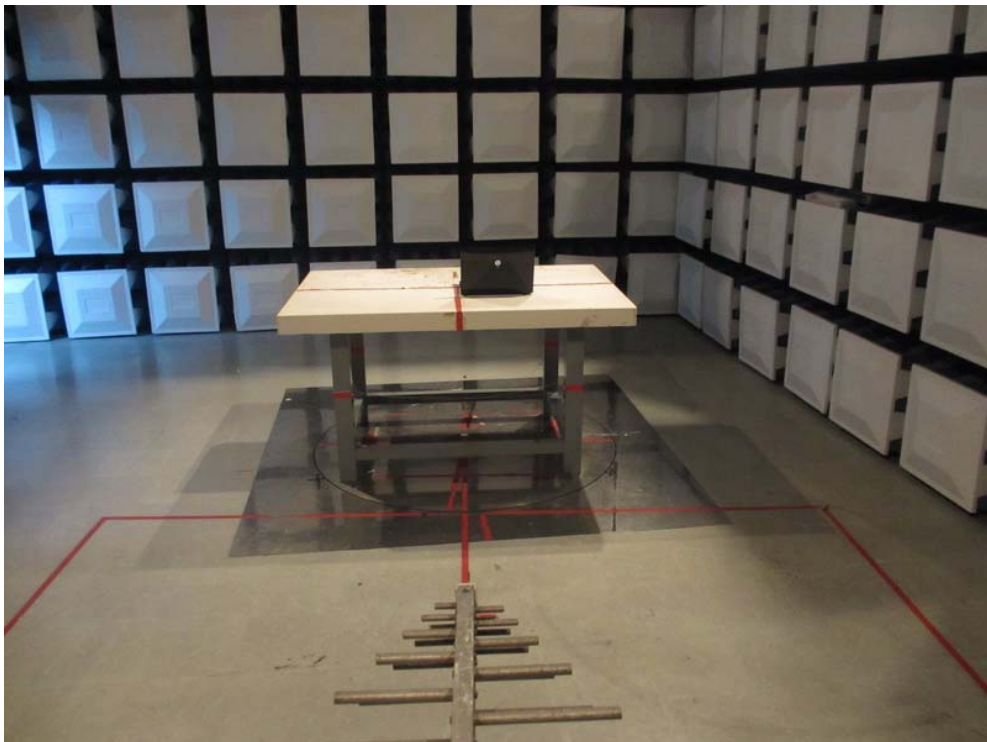
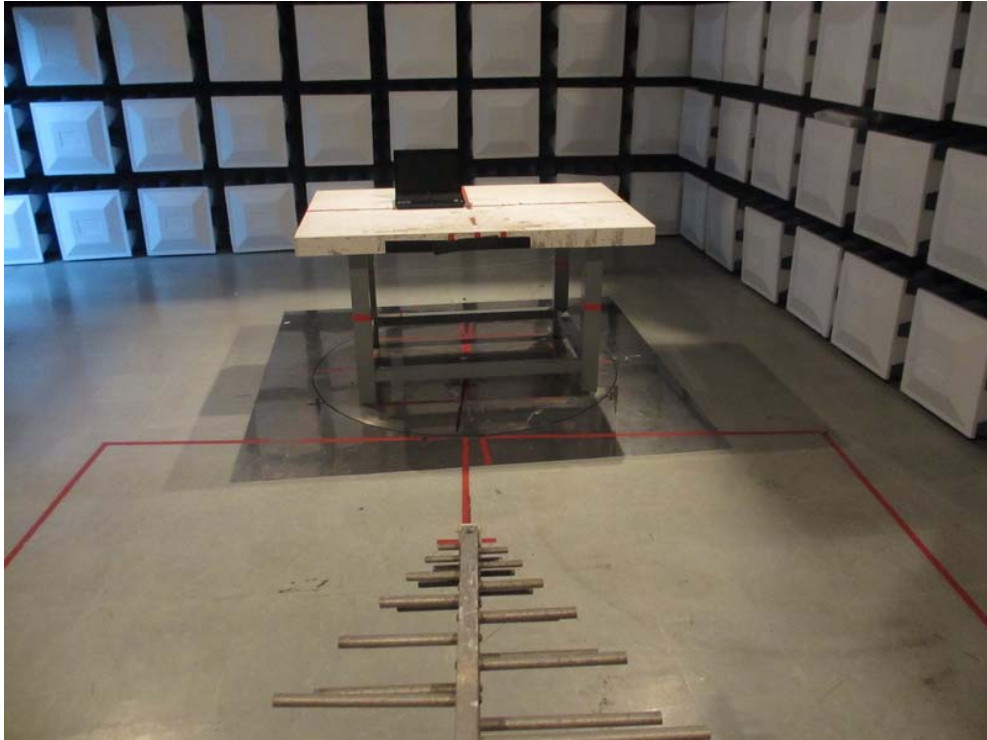



**Radiated Measurement Photos
Above 1000MHz**

