



# FCC Radio Test Report

## FCC ID: X5B-BB6308A

This report concerns (check one) :  Original Grant  Class II Change

**Issued Date** : Sep. 01, 2010  
**Project No.** : 1006C327A  
**Equipment** : Wireless Game Pad Dongle for PS3  
**Model Name** : BB-6308A  
**Applicant** : Performance Designed Products, LLC  
**Address** : 14144 Ventura Blvd. Suite 200 Sherman Oaks, CA 91423

**Tested by:**  
Neutron Engineering Inc. EMC Laboratory

**Date of Receipt:** Jun. 29, 2010

**Date of Test:**  
Jun. 29, 2010 ~ Aug. 31, 2010

Testing Engineer : Jeff Yang  
(Jeff Yang)

Technical Manager : Vic Chiu  
(Vic Chiu)

Authorized Signatory : Steven Lu  
(Steven Lu)

**Neutron Engineering Inc.**

**No.3, Jinshagang 1st Road, ShiXia, Dalang  
Town, Dong Guan, China.  
TEL : (0769) 8318-3000 FAX : (0769) 8319-6000**



### **Declaration**

**Neutron** represents to the client that testing is done in accordance with standard procedures as applicable and that test instruments used has been calibrated with the standards traceable to National Measurement Laboratory (**NML**) of **R.O.C.**, or National Institute of Standards and Technology (**NIST**) of **U.S.A.**

**Neutron's** reports apply only to the specific samples tested under conditions. It is manufacture's responsibility to ensure that additional production units of this model are manufactured with the identical electrical and mechanical components. **Neutron** shall have no liability for any declarations, inferences or generalizations drawn by the client or others from **Neutron** issued reports.

**Neutron's** reports must not be used by the client to claim product endorsement by the authorities or any agency of the Government.

This report is the confidential property of the client. As a mutual protection to the clients, the public and **Neutron-self**, extracts from the test report shall not be reproduced except in full with **Neutron's** authorized written approval.

**Neutron's** laboratory quality assurance procedures are in compliance with the **ISO Guide 17025** requirements, and accredited by the conformity assessment authorities listed in this test report.

### **Limitation**

For the use of the authority's logo is limited unless the Test Standard(s)/Scope(s)/Item(s) mentioned in this test report is (are) included in the conformity assessment authorities acceptance respective.



<b>Table of Contents</b>	<b>Page</b>
<b>1 . CERTIFICATION</b>	<b>6</b>
<b>2 . SUMMARY OF TEST RESULTS</b>	<b>7</b>
2.1 TEST FACILITY	8
2.2 MEASUREMENT UNCERTAINTY	8
<b>3 . GENERAL INFORMATION</b>	<b>9</b>
3.1 GENERAL DESCRIPTION OF EUT	9
3.2 DESCRIPTION OF TEST MODES	12
3.3 TABLE OF PARAMETERS OF TEXT SOFTWARE SETTING	12
3.4 BLOCK DIGRAM SHOWING THE CONFIGURATION OF SYSTEM TESTED	13
3.5 DESCRIPTION OF SUPPORT UNITS(CONDUCTED MODE)	14
<b>4 . EMC EMISSION TEST</b>	<b>15</b>
4.1 CONDUCTED EMISSION MEASUREMENT	15
4.1.1 POWER LINE CONDUCTED EMISSION LIMITS	15
4.1.2 MEASUREMENT INSTRUMENTS LIST AND SETTING	15
4.1.3 TEST PROCEDURE	16
4.1.4 DEVIATION FROM TEST STANDARD	16
4.1.5 TEST SETUP	16
4.1.6 EUT OPERATING CONDITIONS	16
4.1.7 TEST RESULTS	17
4.2 RADIATED EMISSION MEASUREMENT	19
4.2.1 RADIATED EMISSION LIMITS	19
4.2.2 MEASUREMENT INSTRUMENTS LIST ANS SETTING	20
4.2.3 TEST PROCEDURE	22
4.2.4 DEVIATION FROM TEST STANDARD	22
4.2.5 TEST SETUP	23
4.2.6 EUT OPERATING CONDITIONS	23
4.2.7 TEST RESULTS (BETWEEN30 – 1000 MHZ)	24
4.2.8 TEST RESULTS (ABOVE 1000 MHZ)	26
<b>5 . NUMBER OF HOPPING CHANNEL</b>	<b>38</b>
5.1 APPLIED PROCEDURES / LIMIT	38
5.1.1 MEASUREMENT INSTRUMENTS LIST AND SETTING	38
5.1.2 TEST PROCEDURE	38
5.1.3 DEVIATION FROM STANDARD	38
5.1.4 TEST SETUP	38
5.1.5 EUT OPERATION CONDITIONS	38
5.1.6 TEST RESULTS	39



<b>Table of Contents</b>	<b>Page</b>
<b>6 . AVERAGE TIME OF OCCUPANCY</b>	<b>40</b>
<b>6.1 APPLIED PROCEDURES / LIMIT</b>	<b>40</b>
6.1.1 MEASUREMENT INSTRUMENTS LIST	40
6.1.2. TEST PROCEDURES	40
6.1.3. TEST SETUP LAYOUT	40
6.1.4. TEST DEVIATION	40
6.1.5. EUT OPERATION DURING TEST	40
6.1.6. TEST RESULTS	41
<b>7 . HOPPING CHANNEL SEPARATION MEASUREMENT</b>	<b>43</b>
<b>7.1 APPLIED PROCEDURES / LIMIT</b>	<b>43</b>
7.1.1 MEASUREMENT INSTRUMENTS LIST AND SETTING	43
7.1.2 TEST PROCEDURE	43
7.1.3 DEVIATION FROM STANDARD	43
7.1.4 TEST SETUP	43
7.1.5 EUT OPERATION CONDITIONS	43
7.1.6 TEST RESULTS	44
<b>8 . BANDWIDTH TEST</b>	<b>46</b>
<b>8.1 APPLIED PROCEDURES / LIMIT</b>	<b>46</b>
8.1.1 MEASUREMENT INSTRUMENTS LIST AND SETTING	46
8.1.2 TEST PROCEDURE	46
8.1.3 DEVIATION FROM STANDARD	46
8.1.4 TEST SETUP	46
8.1.5 EUT OPERATION CONDITIONS	46
8.1.6 TEST RESULTS	47
<b>9 . PEAK OUTPUT POWER TEST</b>	<b>49</b>
<b>9.1 APPLIED PROCEDURES / LIMIT</b>	<b>49</b>
9.1.1 MEASUREMENT INSTRUMENTS LIST AND SETTING	49
9.1.2 TEST PROCEDURE	49
9.1.3 DEVIATION FROM STANDARD	49
9.1.4 TEST SETUP	49
9.1.5 EUT OPERATION CONDITIONS	49
9.1.6 TEST RESULTS	50
<b>10 . ANTENNA CONDUCTED SPURIOUS EMISSION</b>	<b>52</b>
<b>10.1 APPLIED PROCEDURES / LIMIT</b>	<b>52</b>
10.1.1 MEASUREMENT INSTRUMENTS LIST AND SETTING	52
10.1.2 TEST PROCEDURE	52
10.1.3 DEVIATION FROM STANDARD	52
10.1.4 TEST SETUP	52
10.1.5 EUT OPERATION CONDITIONS	52



	<b>Table of Contents</b>	<b>Page</b>
	<b>10.1.6 TEST RESULTS</b>	<b>53</b>
	<b>11 . EUT TEST PHOTO</b>	<b>58</b>



## 1. CERTIFICATION

Equipment : Wireless Game Pad Dongle for PS3  
Brand Name : N/A  
Model Name : BB-6308A  
Applicant : Performance Designed Products,LLC  
Date of Test: Jun. 29, 2010 ~ Aug. 31, 2010  
Test Item : ENGINEERING SAMPLE  
Standards : FCC Part15, Subpart C(15.247) / ANSI C63.4 : 2003

The above equipment has been tested and found compliance with the requirement of the relative standards by Neutron Engineering Inc. EMC Laboratory.

The test data, data evaluation, and equipment configuration contained in our test report (Ref No. NEI-FCCP-1-1006C327A) were obtained utilizing the test procedures, test instruments, test sites that has been accredited by the Authority of NVLAP and TAF according to the ISO-17025 quality assessment standard and technical standard(s).



**2. SUMMARY OF TEST RESULTS**

Test procedures according to the technical standards:

<b>FCC Part15 (15.247) , Subpart C</b>			
<b>Standard Section</b>	<b>Test Item</b>	<b>Judgment</b>	<b>Remark</b>
15.207	Conducted Emission	PASS	
15.247(d)	Antenna conducted Spurious Emission	PASS	
15.247 (a)(1)	Hopping Channel Separation	PASS	
15.247 (b)(1)	Peak Output Power	PASS	
15.247(d)/15.209	Radiated Spurious Emission	PASS	
15.247 (a)(1)(iii)	Number of Hopping Frequency	PASS	
15.247 (a)(1)(iii)	Dwell Time	PASS	
15.205	Restricted Bands	PASS	
15.203	Antenna Requirement	PASS	
1.1307 1.1310 2.1091 2.1093	RF Exposure Compliance	PASS	

**NOTE:**

(1) "N/A" denotes test is not applicable in this Test Report



**2.1 TEST FACILITY**

The test facilities used to collect the test data in this report is **DG-C03/CB03** at the location of No.3,Jinshagang 1st Road, ShiXia, Dalang Town, Dong Guan, China.523792  
Neutron's test firm number is 319330

**2.2 MEASUREMENT UNCERTAINTY**

Where relevant, the following measurement uncertainty levels have been estimated for tests performed on the EUT as specified in CISPR 16-4-2:

The reported uncertainty of measurement  $y \pm U$ , where expanded uncertainty **U** is based on a standard uncertainty multiplied by a coverage factor of **k=2**, providing a level of confidence of approximately **95 %**.

A. Conducted Measurement :

Test Site	Method	Measurement Frequency Range	U , (dB)	NOTE
DG-C03	CISPR	150 KHz ~ 30MHz	1.94	

B. Radiated Measurement :

Test Site	Method	Measurement Frequency Range	Ant. H / V	U , (dB)	NOTE
CB03	CISPR	30MHz ~ 200MHz	V	3.82	
		30MHz ~ 200MHz	H	3.60	
		200MHz ~ 1,000MHz	V	3.86	
		200MHz ~ 1,000MHz	H	3.94	





**3. GENERAL INFORMATION**

**3.1 GENERAL DESCRIPTION OF EUT**

Equipment	Wireless Game Pad Dongle for PS3
Trade Name	N/A
Model Name	BB-6308A
OEM Brand/Model Name	N/A
Model Difference	N/A
Product Description	The EUT is a Wireless Game Pad Dongle for PS3
	Operation Frequency: 2402~2480 MHz
	Modulation Type: GFSK
	Number Of Channel 64CH .Please see Note 2.
	Antenna Designation: Please see Note 3.
	Antenna Gain(Peak) Please see Note 3.
	Output Power: -7.09 dBm
	Based on the application, features, or specification exhibited in User's Manual, the EUT is considered as an ITE/Computing Device. More details of EUT technical specification, please refer to the User's Manual.
Channel List	Please refer to the Note 2.
Power Source	DC Voltage supplied from Host system (Dongle Sample)
Power Rating	I/P AC 120V/60Hz O/P DC 5V (Dongle Sample)
Connecting I/O Port(s)	Please refer to the User's Manual
Products Covered	N/A
EUT Modification(s)	N/A

**Note:**

1. For a more detailed features description, please refer to the manufacturer's specifications or the User's Manual.



2.

Channel List					
Channel	Frequency (MHz)	Channel	Frequency (MHz)	Channel	Frequency (MHz)
<b>01</b>	<b>2402</b>	27	2432	53	2466
02	2403	28	2433	54	2467
03	2404	29	2434	55	2468
04	2405	30	2435	56	2469
05	2406	31	2436	57	2470
06	2407	32	2437	58	2471
07	2408	33	2438	59	2472
08	2409	34	2439	60	2473
09	2411	35	2440	61	2474
10	2413	<b>36</b>	<b>2441</b>	62	2476
11	2415	37	2443	63	2478
12	2417	38	2445	<b>64</b>	<b>2480</b>
13	2418	39	2447		
14	2419	40	2449		
15	2420	41	2450		
16	2421	42	2451		
17	2422	43	2452		
18	2423	44	2453		
19	2424	45	2454		
20	2425	46	2455		
21	2426	47	2456		
22	2427	48	2457		
23	2428	49	2459		
24	2429	50	2461		
25	2430	51	2463		
26	2431	52	2465		



2. Frequency Hopping Table of 64 Channels hopping with 4 Group listing below:

Group 1		Group 2	
Channel	Frequency (MHz)	Channel	Frequency (MHz)
1	2402	1	2404
2	2467	2	2469
3	2434	3	2436
4	2450	4	2452
5	2466	5	2468
6	2403	6	2405
7	2419	7	2421
8	2435	8	2437
9	2451	9	2453
10	2418	10	2420
11	2474	11	2476
12	2411	12	2413
13	2427	13	2429
14	2443	14	2445
15	2459	15	2461
16	2426	16	2428
Group 3		Group 4	
Channel	Frequency (MHz)	Channel	Frequency (MHz)
1	2406	1	2408
2	2471	2	2473
3	2438	3	2440
4	2454	4	2456
5	2470	5	2472
6	2407	6	2409
7	2423	7	2425
8	2439	8	2441
9	2455	9	2457
10	2422	10	2424
11	2478	11	2480
12	2415	12	2417
13	2431	13	2433
14	2447	14	2449
15	2463	15	2465
16	2430	16	2432

3. Table for Filed Antenna

**Dongle Sample:**

Ant.	Brand	Model Name	Antenna Type	Connector	Gain (dBi)
1	N/A	N/A	Printed Antenna	N/A	1.12



**3.2 DESCRIPTION OF TEST MODES**

To investigate the maximum EMI emission characteristics generates from EUT, the test system was pre-scanning tested base on the consideration of following EUT operation mode or test configuration mode which possible have effect on EMI emission level. Each of these EUT operation mode(s) or test configuration mode(s) mentioned above was evaluated respectively.

Pretest Mode	Description
Mode 1	Tx CH01
Mode 2	TX CH36
Mode 3	TX CH64
Mode 3	Normal Link

For Conducted Emission	
Final Test Mode	Description
Mode 3	Normal Link

For Radiated Emission	
Final Test Mode	Description
Mode 1	Tx CH01
Mode 2	TX CH36
Mode 3	TX CH64

Note:

- (1) The measurements are performed at the highest, middle, lowest available channels.

**3.3 TABLE OF PARAMETERS OF TEXT SOFTWARE SETTING**

During testing channel & power controlling software provided by the customer was used to control the operating channel as well as the output power level. The RF output power selection is for the setting of RF output power expected by the customer and is going to be fixed on the firmware of the final end product power parameters of FHSS

Test software Version	Test program: Hardware control		
Frequency	2402 MHz	2441MHz	2480MHz
Parameters(1Mbps)	N/A	N/A	N/A



### 3.4 BLOCK DIGRAM SHOWING THE CONFIGURATION OF SYSTEM TESTED

Conducted:

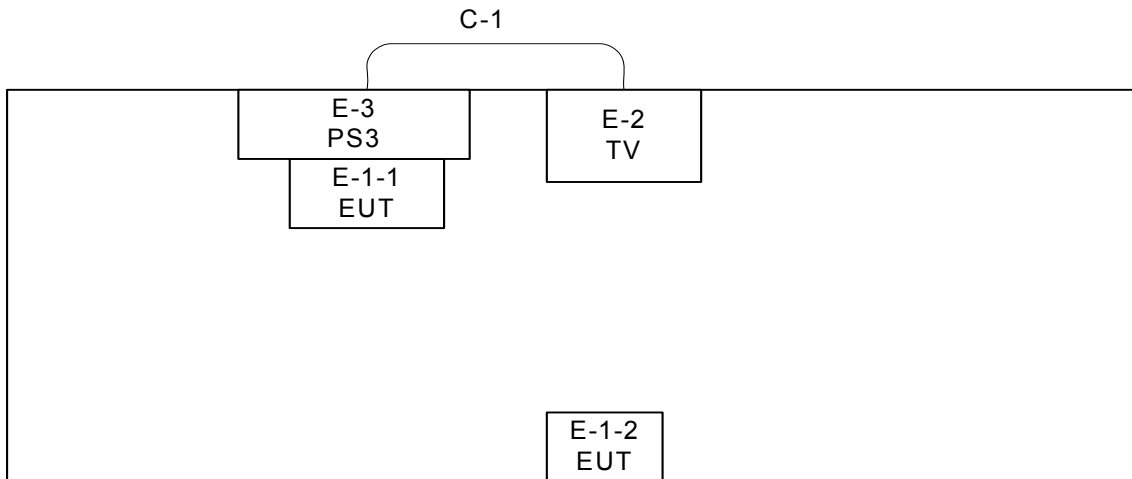

C-1: AV Cable

Radiated:

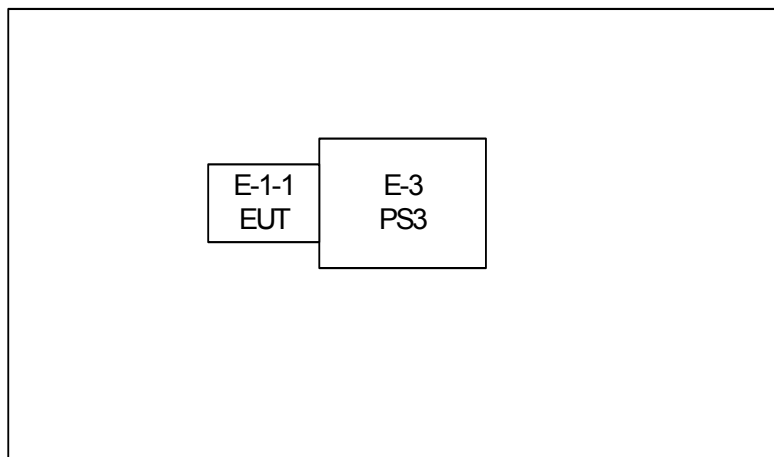



**3.4 DESCRIPTION OF SUPPORT UNITS(CONDUCTED MODE)**

The EUT has been tested as an independent unit together with other necessary accessories or support units. The following support units or accessories were used to form a representative test configuration during the tests.

Item	Equipment	Mfr/Brand	Model/Type No.	FCC ID	Series No.	Note
E-1-1	Wireless Game Pad Dongle for PS3	N/A	BB-6308A	X5B-BB6308A	N/A	EUT
E-1-2	Wireless Controller for PS3	GameStop	BB-6308	X5B-BB6308	N/A	
E-2	TV	TechniSat	HD-Vision	N/A	019103	
E-3	Playstation 3	SONY	CECHH12	DOC	02-27432691-8924521-CECHH12 CW	

Item	Shielded Type	Ferrite Core	Length	Note
C-1	NO	NO	2.3M	

Note:

- (1) The support equipment was authorized by Declaration of Confirmation.
- (2) For detachable type I/O cable should be specified the length in cm in 『Length』 column.



**4. EMC EMISSION TEST**

**4.1 CONDUCTED EMISSION MEASUREMENT**

**4.1.1 POWER LINE CONDUCTED EMISSION Limits (Frequency Range 150KHz-30MHz)**

FREQUENCY (MHz)	Class A (dBuV)		Class B (dBuV)		Standard
	Quasi-peak	Average	Quasi-peak	Average	
0.15 -0.5	79.00	66.00	66 - 56 *	56 - 46 *	CISPR
0.50 -5.0	73.00	60.00	56.00	46.00	CISPR
5.0 -30.0	73.00	60.00	60.00	50.00	CISPR

0.15 -0.5	79.00	66.00	66 - 56 *	56 - 46 *	FCC
0.50 -5.0	73.00	60.00	56.00	46.00	FCC
5.0 -30.0	73.00	60.00	60.00	50.00	FCC

Note:

- (1) The tighter limit applies at the band edges.
- (2) The limit of " \* " marked band means the limitation decreases linearly with the logarithm of the frequency in the range.

**4.1.2 MEASUREMENT INSTRUMENTS LIST AND SETTING**

Item	Kind of Equipment	Manufacturer	Type No.	Serial No.	Calibrated until
1	LISN	EMCO	3816/2	00052765	May.26.2011
2	LISN	Rolf Heine	NNB-2-16Z	99044	May.26.2011
3	50Ω Terminator	SHX	TF2-3G-A	08122901	May.26.2011
4	Transient Limiter	Agilent	11947A	3107A03668	May.26.2011
5	Test Cable	N/A	C-06_C03	N/A	Nov.16.2010
6	EMI TEST RECEIVER	R&S	ESCS30	8333641017	May.26.2011

Remark: " N/A" denotes No Model No. , Serial No. or No Calibration specified.

The following table is the setting of the receiver

Receiver Parameters	Setting
Attenuation	10 dB
Start Frequency	0.15 MHz
Stop Frequency	30 MHz
IF Bandwidth	9 kHz

#### 4.1.3 TEST PROCEDURE

- The EUT was placed 0.8 meters from the horizontal ground plane with EUT being connected to the power mains through a line impedance stabilization network (LISN). All other support equipments powered from additional LISN(s). The LISN provide 50 Ohm/ 50uH of coupling impedance for the measuring instrument.
- Interconnecting cables that hang closer than 40 cm to the ground plane shall be folded back and forth in the center forming a bundle 30 to 40 cm long.
- I/O cables that are not connected to a peripheral shall be bundled in the center. The end of the cable may be terminated, if required, using the correct terminating impedance. The overall length shall not exceed 1 m.
- LISN at least 80 cm from nearest part of EUT chassis.
- For the actual test configuration, please refer to the related Item –EUT Test Photos.

#### 4.1.4 DEVIATION FROM TEST STANDARD

No deviation

#### 4.1.5 TEST SETUP

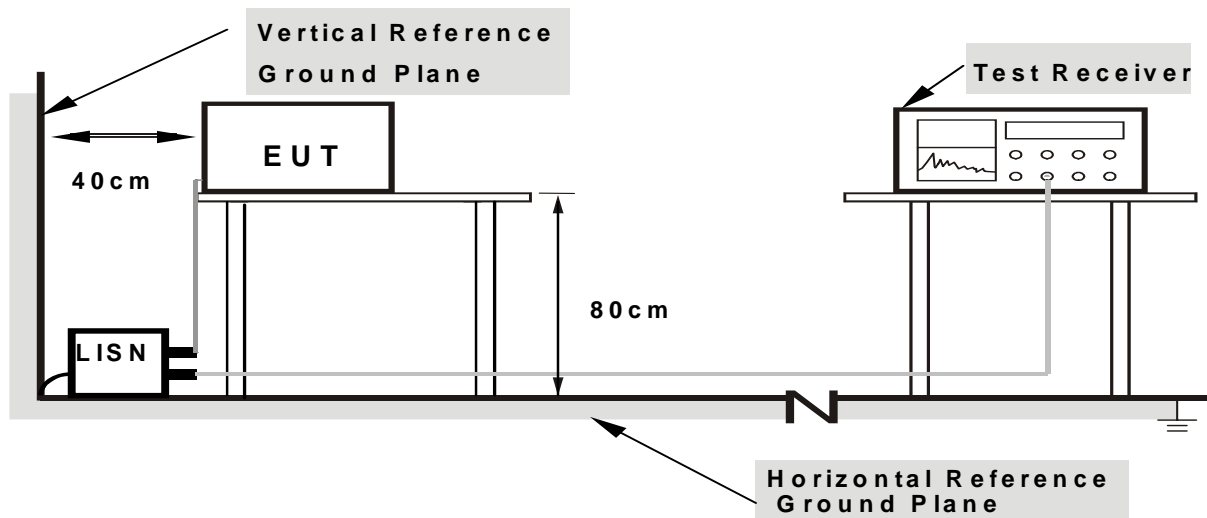

**Note: 1. Support units were connected to second LISN.**

**2. Both of LISNs (AMN) are 80 cm from EUT and at least 80 cm from other units and other metal planes**

#### 4.1.6 EUT OPERATING CONDITIONS

The EUT was configured for testing in a typical fashion (as a customer would normally use it). The EUT has been programmed to continuously transmit during test. This operating condition was tested and used to collect the included data.





**4.1.7 TEST RESULTS**

EUT :	Wireless Game Pad Dongle for PS3	Model Name :	BB-6308A
Temperature :	23 °C	Relative Humidity :	50 %
Pressure :	1010hPa	Test Power :	AC 120V/60Hz
Test Mode :	Normal Link		

Freq. (MHz)	Terminal L/N	Measured(dBuV)		Limits(dBuV)		Margin (dB)	Note
		QP-Mode	AV-Mode	QP-Mode	AV-Mode		
0.41	Line	40.63	*	57.63	47.63	-17.00	(QP)
0.74	Line	36.93	*	56.00	46.00	-19.07	(QP)
1.81	Line	38.80	*	56.00	46.00	-17.20	(QP)
2.15	Line	37.10	*	56.00	46.00	-18.90	(QP)
2.53	Line	36.71	*	56.00	46.00	-19.29	(QP)
27.56	Line	39.02	*	60.00	50.00	-20.98	(QP)

**Remark**

- (1) All readings are QP Mode value unless otherwise stated AVG in column of Note. If the QP Mode Measured value compliance with the QP Limits and lower than AVG Limits, the EUT shall be deemed to meet both QP & AVG Limits and then only QP Mode was measured, but AVG Mode didn't perform. In this case, a " \* " marked in AVG Mode column of Interference Voltage Measured.
- (2) Measuring frequency range from 150KHz to 30MHz.

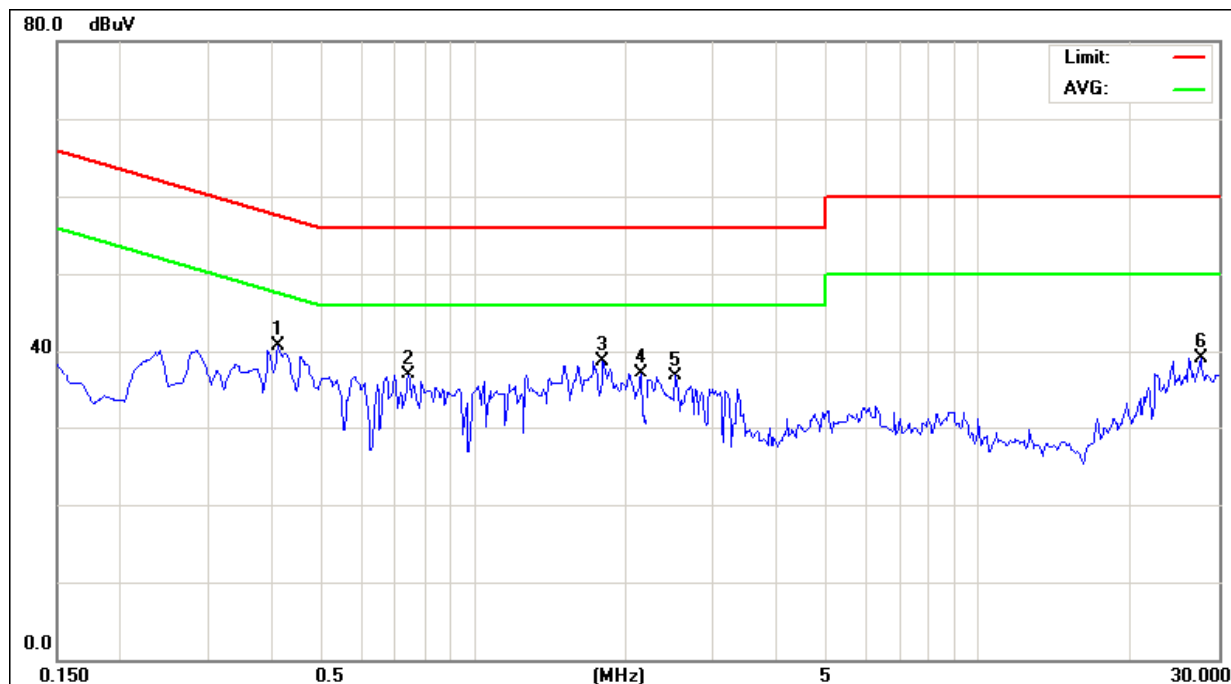



EUT :	Wireless Game Pad Dongle for PS3	Model Name :	BB-6308A
Temperature :	23 °C	Relative Humidity :	50 %
Pressure :	1010hPa	Test Power :	AC 120V/60Hz
Test Mode :	Normal Link		

Freq. (MHz)	Terminal L/N	Measured(dBuV)		Limits(dBuV)		Margin (dB)	Note
		QP-Mode	AV-Mode	QP-Mode	AV-Mode		
0.30	Neutral	36.93	*	60.16	50.16	-23.23	(QP)
0.45	Neutral	37.81	*	56.85	46.85	-19.04	(QP)
0.77	Neutral	38.18	*	56.00	46.00	-17.82	(QP)
1.51	Neutral	38.42	*	56.00	46.00	-17.58	(QP)
2.44	Neutral	35.35	*	56.00	46.00	-20.65	(QP)
24.18	Neutral	38.96	*	60.00	50.00	-21.04	(QP)

**Remark**

- (1) All readings are QP Mode value unless otherwise stated AVG in column of Note. If the QP Mode Measured value compliance with the QP Limits and lower than AVG Limits, the EUT shall be deemed to meet both QP & AVG Limits and then only QP Mode was measured, but AVG Mode didn't perform. In this case, a "\*" marked in AVG Mode column of Interference Voltage Measured.
- (2) Measuring frequency range from 150KHz to 30MHz.

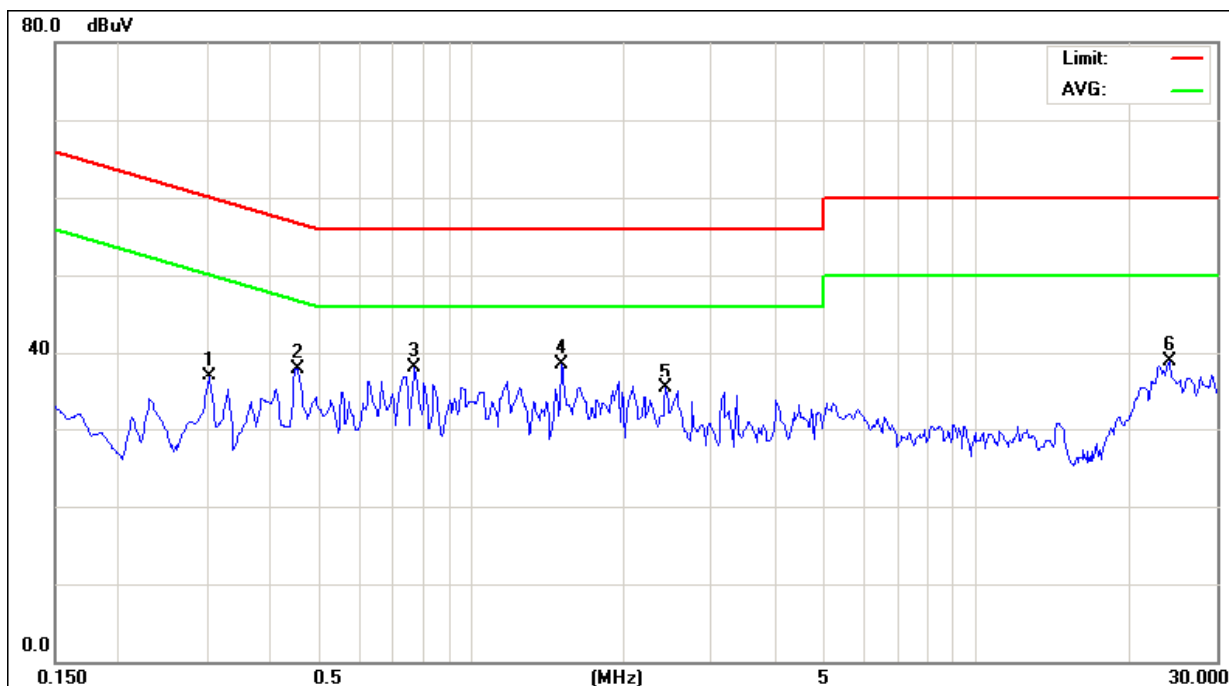



**4.2 RADIATED EMISSION MEASUREMENT**

**4.2.1 RADIATED EMISSION LIMITS (Frequency Range 9kHz-1000MHz)**

20dBc in any 100 kHz bandwidth outside the operating frequency band. In case the emission fall within the restricted band specified on 15.205(a), then the 15.209(a) limit in the table below has to be followed.

Frequencies (MHz)	Field Strength (micorvolts/meter)	Measurement Distance (meters)
0.009~0.490	2400/F(KHz)	300
0.490~1.705	24000/F(KHz)	30
1.705~30.0	30	30
30~88	100	3
88~216	150	3
216~960	200	3
Above 960	500	3

LIMITS OF RADIATED EMISSION MEASUREMENT (Above 1000MHz)

FREQUENCY (MHz)	(dBuV/m) (at 3M)	
	PEAK	AVERAGE
Above 1000	74	54

Notes:

- (1) The limit for radiated test was performed according to FCC PART 15C.
- (2) The tighter limit applies at the band edges.
- (3) Emission level (dBuV/m)=20log Emission level (uV/m).

FREQUENCY RANGE OF RADIATED MEASUREMENT (For unintentional radiators)

Highest frequency generated or Upper frequency of measurement used in the device or on which the device operates or tunes (MHz)	Range (MHz)
Below 1.705	30
1.705 – 108	1000
108 – 500	2000
500 – 1000	5000
Above 1000	5 <sup>th</sup> harmonic of the highest frequency or 40 GHz, whichever is lower



**4.2.2 MEASUREMENT INSTRUMENTS LIST AND SETTING**

Item	Kind of Equipment	Manufacturer	Type No.	Serial No.	Calibrated until
1	Antenna	ETS	3115	00075789	May.12.2011
2	Amplifier	Agilent	8449B	3008A02274	May.26.2011
3	Spectrum	Agilent	E4408B	US39240143	Nov.16.2010
4	Test Cable	HUBER+SUHNER	CB03 High Fre	N/A	May.03.2011
5	Antenna	Schwarbeck	VULB9160	9160-3232	May.26.2011
6	Amplifier	HP	8447D	2944A09673	May.26.2011
7	Test Receiver	R&S	ESCI	100895	May.26.2011
8	Test Cable	N/A	C-01_CB03	N/A	Jul.05.2011
9	Controller	CT	SC100	N/A	N/A

Remark: " N/A" denotes No Model Name / Serial No. and No Calibration specified.

Spectrum Parameter	Setting
Attenuation	Auto
Start Frequency	1000 MHz
Stop Frequency	10th carrier harmonic
RB / VB (emission in restricted band)	1 MHz / 1 MHz for Peak, Average=PK-dycty cycle

Receiver Parameter	Setting
Attenuation	Auto
Start ~ Stop Frequency	9kHz~150kHz / RB 200Hz for QP
Start ~ Stop Frequency	150kHz~30MHz / RB 9kHz for QP
Start ~ Stop Frequency	30MHz~1000MHz / RB 120kHz for QP

DUTY CYCLE : TX 2402MHz (1Mbps)

Dwell time=ON/ON+OFF

ON:0.252msec

ON+OFF:(total time):16.1msec

Dwell time:1.56%

AV=PK+20 log(Dwell time)

AV=PK-36.11

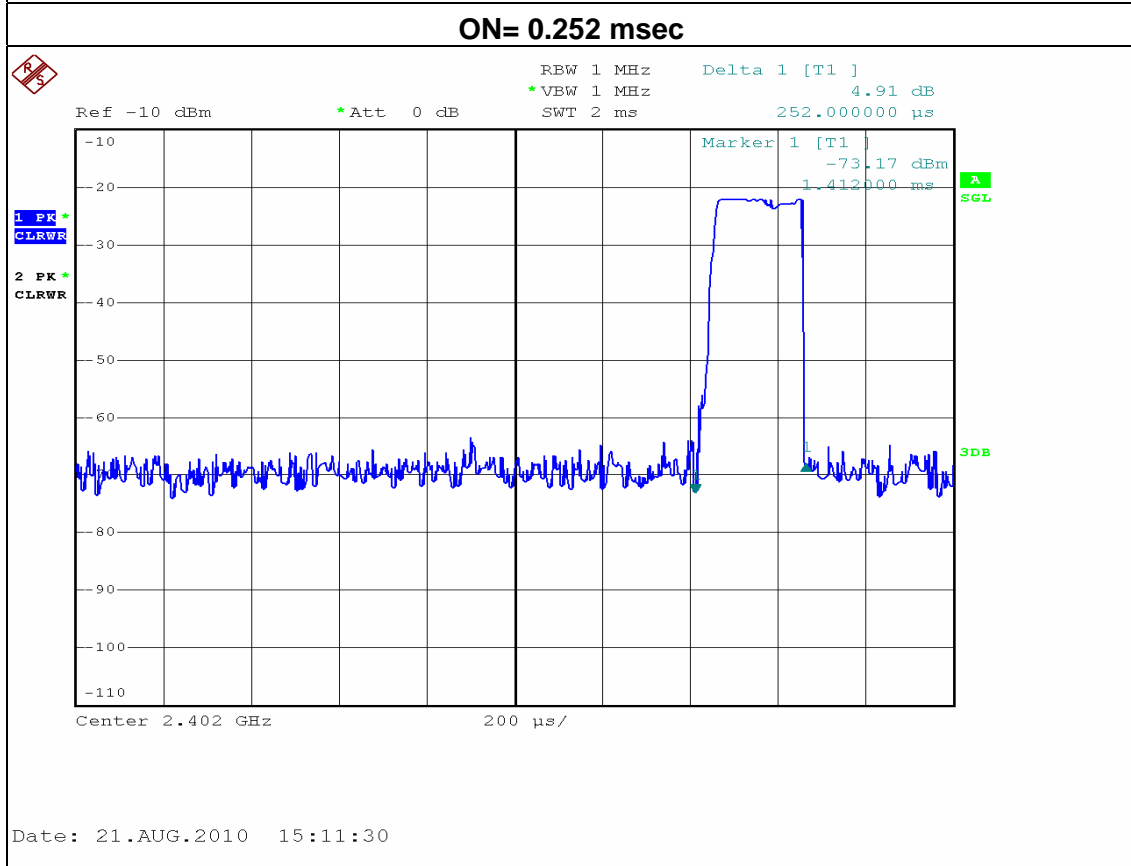
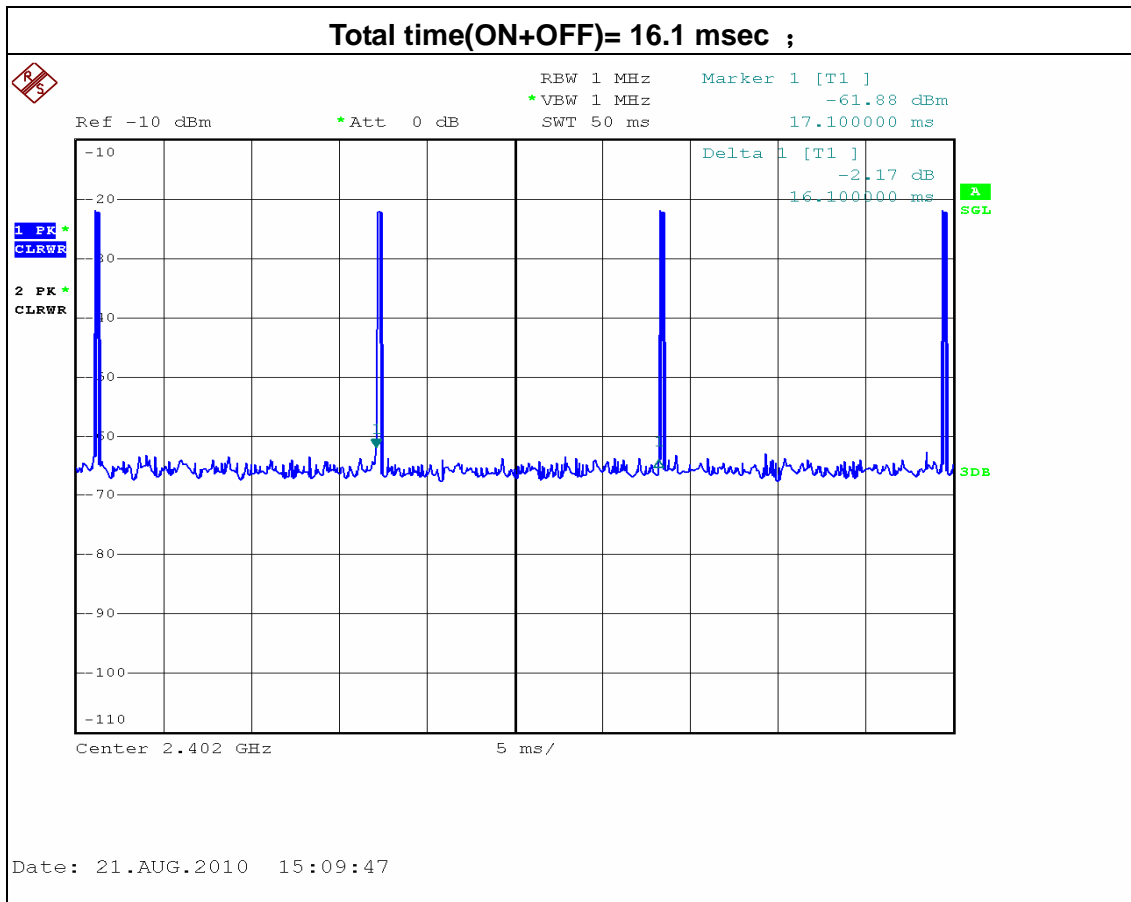



#### **4.2.3 TEST PROCEDURE**

- a. The measuring distance of at 3 m shall be used for measurements at frequency up to 1GHz. For frequencies above 1GHz, any suitable measuring distance may be used.
- b. The EUT was placed on the top of a rotating table 0.8 meters above the ground at a 3 meter semi-anechoic chamber. The table was rotated 360 degrees to determine the position of the highest radiation.
- c. The height of the equipment or of the substitution antenna shall be 0.8 m; the height of the test antenna shall vary between 1 m to 4 m. Both horizontal and vertical polarizations of the antenna are set to make the measurement.
- d. The initial step in collecting conducted emission data is a spectrum analyzer peak detector mode pre-scanning the measurement frequency range. Significant peaks are then marked and then Quasi Peak detector mode re-measured.
- e. If the Peak Mode measured value compliance with and lower than Quasi Peak Mode Limit, the EUT shall be deemed to meet QP Limits and then no additional QP Mode measurement performed.
- f. For the actual test configuration, please refer to the related Item –EUT Test Photos.

#### **4.2.4 DEVIATION FROM TEST STANDARD**

No deviation

**4.2.5 TEST SETUP**

(A) Radiated Emission Test Set-Up Frequency Below 1 GHz

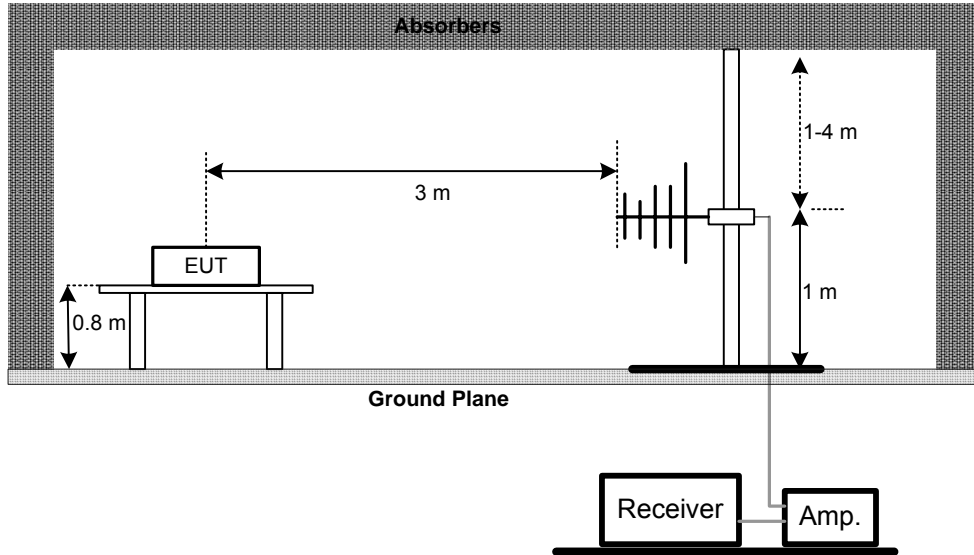

(B) Radiated Emission Test Set-Up Frequency Above 1 GHz

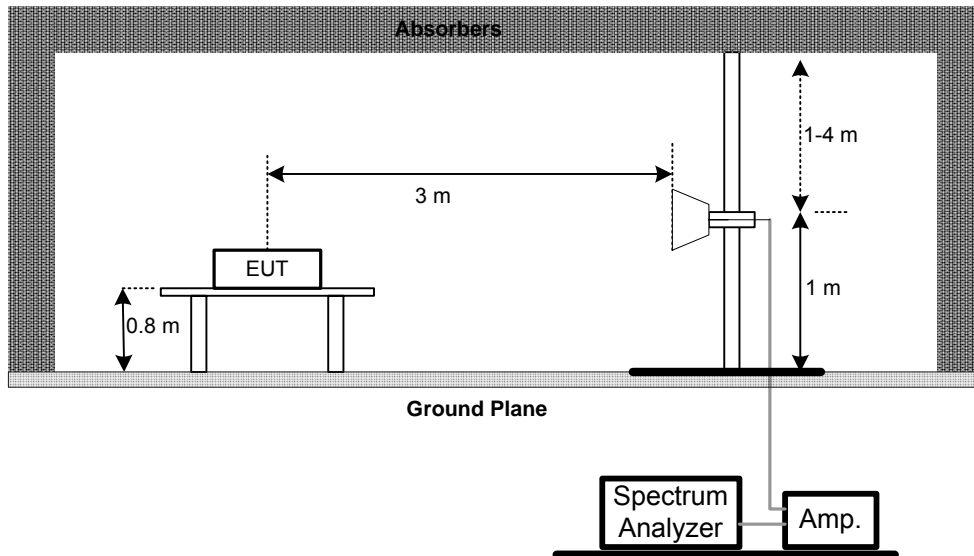

**4.2.6 EUT OPERATING CONDITIONS**

The EUT tested system was configured as the statements of 4.1.6 Unless otherwise a special operating condition is specified in the follows during the testing.



**4.2.7 TEST RESULTS (BETWEEN 30 – 1000 MHZ)**

EUT :	Wireless Game Pad Dongle for PS3	Model Name :	BB-6308A
Temperature :	20 °C	Relative Humidity :	51 %
Pressure :	1010 hPa	Test Voltage :	AC 120V/60Hz
Test Mode :	TX Mode 2402MHz		

Freq. (MHz)	Ant. H/V	Reading(RA) (dBuV)	Corr.Factor(CF) (dB)	Measured(FS) (dBuV/m)	Limits(QP) (dBuV/m)	Margin (dB)	Note
78.21	V	52.88	-23.97	28.91	40.00	- 11.09	
125.66	V	52.69	-22.53	30.16	43.50	- 13.34	
168.47	V	54.11	-19.03	35.08	43.50	- 8.42	
239.67	V	52.87	-17.28	35.59	46.00	- 10.41	
287.94	V	47.98	-15.00	32.98	46.00	- 13.02	
324.55	V	48.97	-15.24	33.73	46.00	- 12.27	

**Remark :**

- (1) Reading in which marked as QP or Peak means measurements by using are Quasi-Peak Mode or Peak Mode with Detector BW=120KHz ; SPA setting in RBW=120KHz, VBW =120KHz, Swp. Time = 0.3 sec./MHz ◦
- (2) All readings are Peak unless otherwise stated QP in column of 『 Note 』 . Peak denotes that the Peak reading compliance with the QP Limits and then QP Mode measurement didn't perform ◦
- (3) Measuring frequency range from 30MHz to 1000MHz ◦
- (4) If the peak scan value lower limit more than 20dB, then this signal data does not show in table ◦

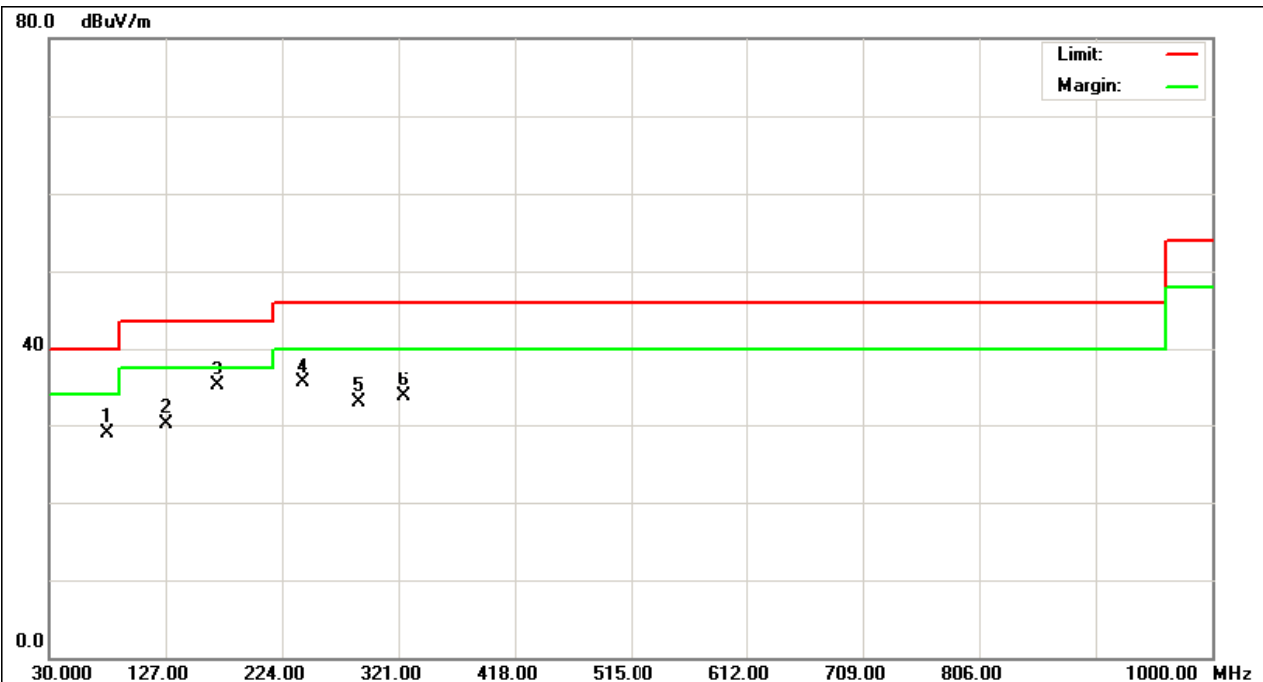





EUT :	Wireless Game Pad Dongle for PS3	Model Name :	BB-6308A
Temperature :	20 °C	Relative Humidity :	51 %
Pressure :	1010 hPa	Test Voltage :	AC 120V/60Hz
Test Mode :	TX Mode 2402MHz		

Freq. (MHz)	Ant. H/V	Reading(RA) (dBuV)	Corr.Factor(CF) (dB)	Measured(FS) (dBuV/m)	Limits(QP) (dBuV/m)	Margin (dB)	Note
65.32	H	54.32	-24.36	29.96	40.00	- 10.04	
142.21	H	52.47	-21.27	31.20	43.50	- 12.30	
198.44	H	56.98	-21.84	35.14	43.50	- 8.36	
245.33	H	53.26	-17.04	36.22	46.00	- 9.78	
287.69	H	51.03	-15.00	36.03	46.00	- 9.97	
345.14	H	50.64	-15.27	35.37	46.00	- 10.63	

**Remark :**

- (1) Reading in which marked as QP or Peak means measurements by using are Quasi-Peak Mode or Peak Mode with Detector BW=120KHz ; SPA setting in RBW=120KHz, VBW =120KHz, Swp. Time = 0.3 sec./MHz ◦
- (2) All readings are Peak unless otherwise stated QP in column of 『Note』 . Peak denotes that the Peak reading compliance with the QP Limits and then QP Mode measurement didn't perform ◦
- (3) Measuring frequency range from 30MHz to 1000MHz ◦
- (4) If the peak scan value lower limit more than 20dB, then this signal data does not show in table ◦

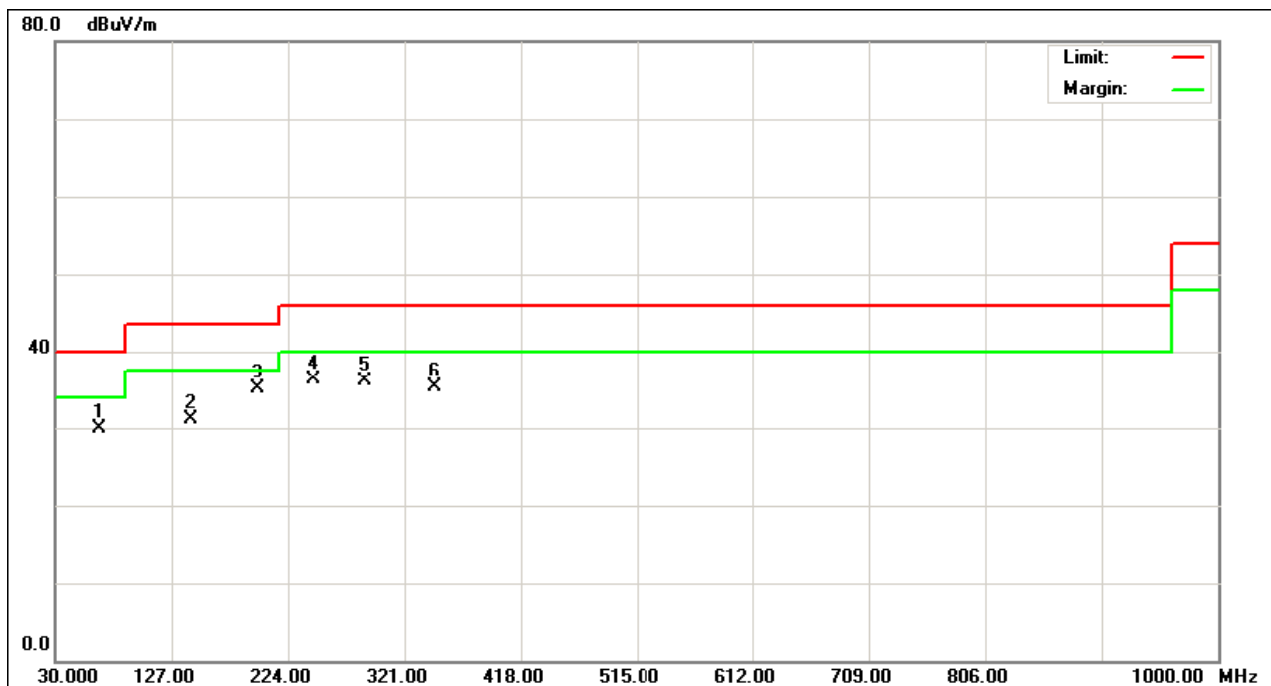



**4.2.8 TEST RESULTS (ABOVE 1000 MHZ)**

EUT :	Wireless Game Pad Dongle for PS3	Model Name :	BB-6308A
Temperature :	20 °C	Relative Humidity :	51 %
Pressure :	1010 hPa	Test Voltage :	AC 120V/60Hz
Test Mode :	TX 2402MHz		

Freq. (MHz)	Ant.Pol. H/V	Reading		Ant./CF CF(dB)	Act.		Limit		Note
		Peak (dBuV)	AV (dBuV)		Peak (dBuV/m)	AV (dBuV/m)	Peak (dBuV/m)	AV (dBuV/m)	
2390.00	V	33.15	-2.91	31.54	64.69	28.63	74.00	54.00	X/E
<b>2401.90</b>	<b>V</b>	<b>53.72</b>	<b>17.61</b>	<b>31.56</b>	<b>85.28</b>	<b>49.17</b>			<b>X/F</b>
4803.44	V	57.40	21.29	5.94	63.34	27.23	74.00	54.00	X/H

Remark :

- (1) All readings are Peak unless otherwise stated QP in column of 『Note』 . Peak denotes that the Peak reading compliance with the QP Limits and then QP Mode measurement didn't perform .
- (2) Measuring frequency range from 30MHz to 1000MHz or the 10th harmonic of highest fundamental frequency .“F” denotes fundamental frequency; “H” denotes spurious frequency. “E” denotes band edge frequency. (This judgment method includes the Band Edge Requirement.)
- (3) Radiated emissions measured in frequency range above 1000MHz were made with an instrument using Peak detector mode and AV detector mode of the emission .
- (4) Data of measurement within this frequency range shown “ \* ” in the table above means the reading of emissions are attenuated more than 20dB below the permissible limits or the field strength is too small to be measured.
- (5) A preamp and high pass filter were used for this test in order to provide sufficient measurement sensitivity.
- (6) EUT Orthogonal Axis :  
“X” - denotes Laid on Table ; “Y” - denotes Vertical Stand ; “Z” - denotes Side Stand
- (7) During the measurements above 1 GHz it is taken care of that the EUT is always within the 3 dB cone of radiation BW of the used antenna
- (8) The average value of fundamental frequency is:  
Average = Peak value + 20log(Duty cycle) · Final AV=PK-36.11



TX CH01(Above 1000 MHz, Vertical)

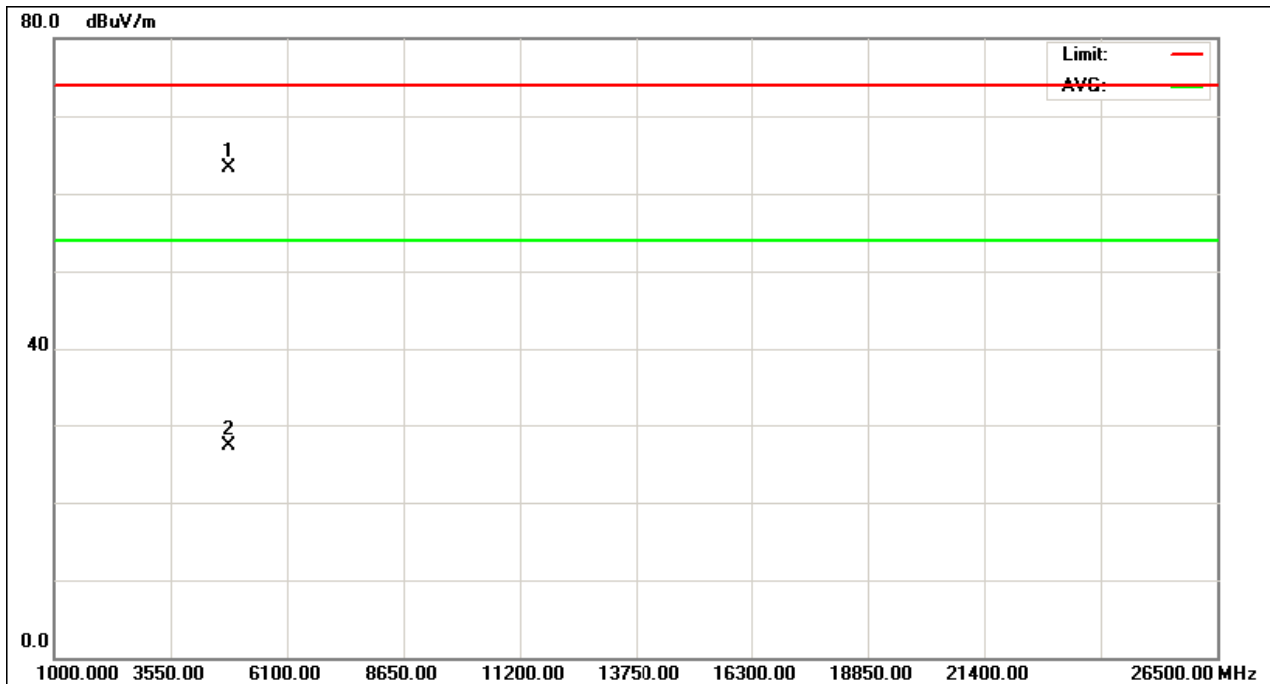
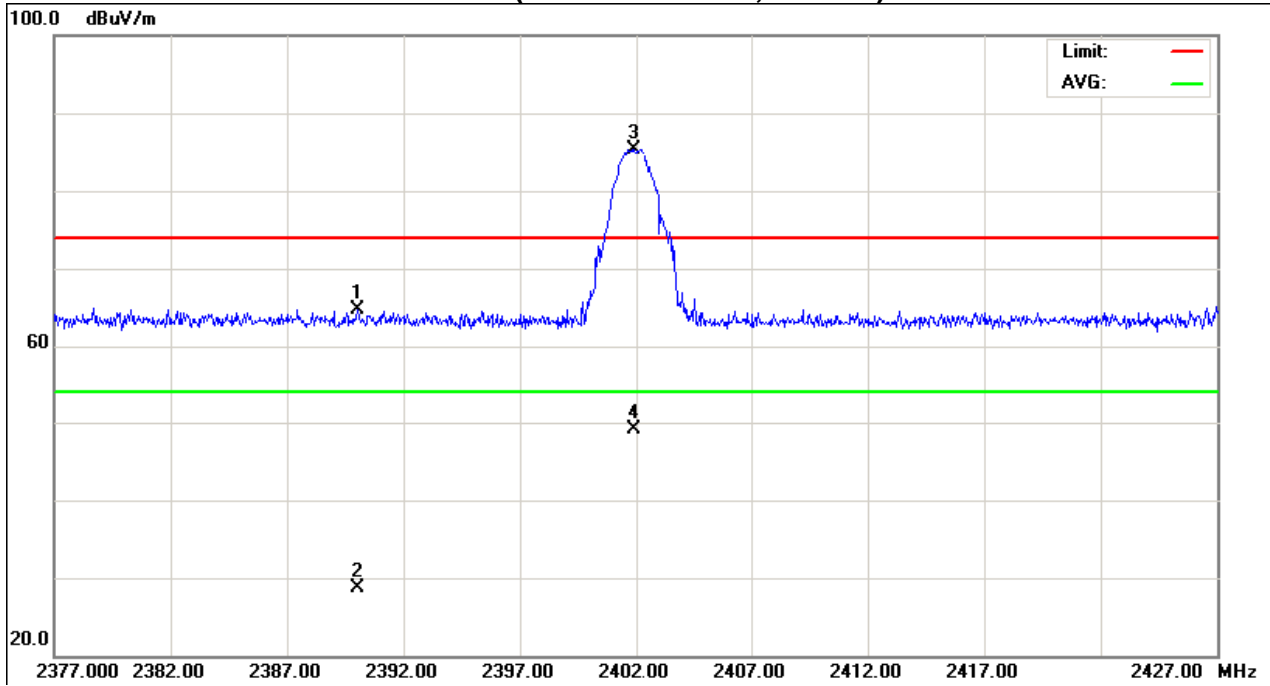



EUT :	Wireless Game Pad Dongle for PS3	Model Name :	BB-6308A
Temperature :	20 °C	Relative Humidity :	51 %
Pressure :	1010hPa	Test Voltage :	AC 120V/60Hz
Test Mode :	TX 2402MHz		

Freq. (MHz)	Ant.Pol. H/V	Reading		Ant./CF CF(dB)	Act.		Limit		Note
		Peak (dBuV)	AV (dBuV)		Peak (dBuV/m)	AV (dBuV/m)	Peak (dBuV/m)	AV (dBuV/m)	
2390.00	H	31.55	-4.56	31.54	63.09	26.98	74.00	54.00	X/E
<b>2401.90</b>	<b>H</b>	<b>58.46</b>	<b>22.35</b>	<b>31.56</b>	<b>90.02</b>	<b>53.91</b>			<b>X/F</b>
4803.12	H	56.79	20.68	5.94	62.73	26.62	74.00	54.00	X/H

Remark :

- (1) All readings are Peak unless otherwise stated QP in column of 『Note』 . Peak denotes that the Peak reading compliance with the QP Limits and then QP Mode measurement didn't perform ◦
- (2) Measuring frequency range from 30MHz to 1000MHz or the 10th harmonic of highest fundamental frequency ◦ "F" denotes fundamental frequency; "H" denotes spurious frequency. "E" denotes band edge frequency. (This judgment method includes the Band Edge Requirement.)
- (3) Radiated emissions measured in frequency range above 1000MHz were made with an instrument using Peak detector mode and AV detector mode of the emission ◦
- (4) Data of measurement within this frequency range shown " \* " in the table above means the reading of emissions are attenuated more than 20dB below the permissible limits or the field strength is too small to be measured.
- (5) A preamp and high pass filter were used for this test in order to provide sufficient measurement sensitivity.
- (6) EUT Orthogonal Axis :  
"X" - denotes Laid on Table ; "Y" - denotes Vertical Stand ; "Z" - denotes Side Stand
- (7) During the measurements above 1 GHz it is taken care of that the EUT is always within the 3 dB cone of radiation BW of the used antenna
- (8) The average value of fundamental frequency is:  
Average = Peak value + 20log(Duty cycle) ◦ Final AV=PK-36.11



TX CH01(Above 1000 MHz, Horizontal)

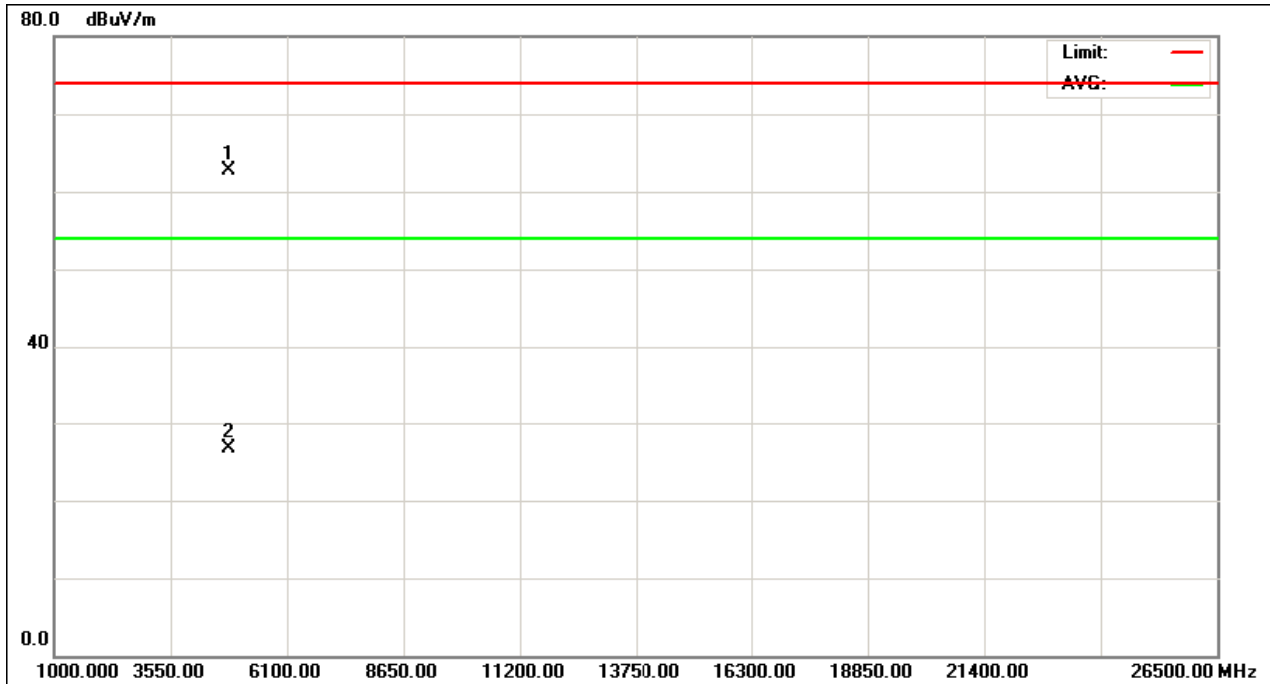
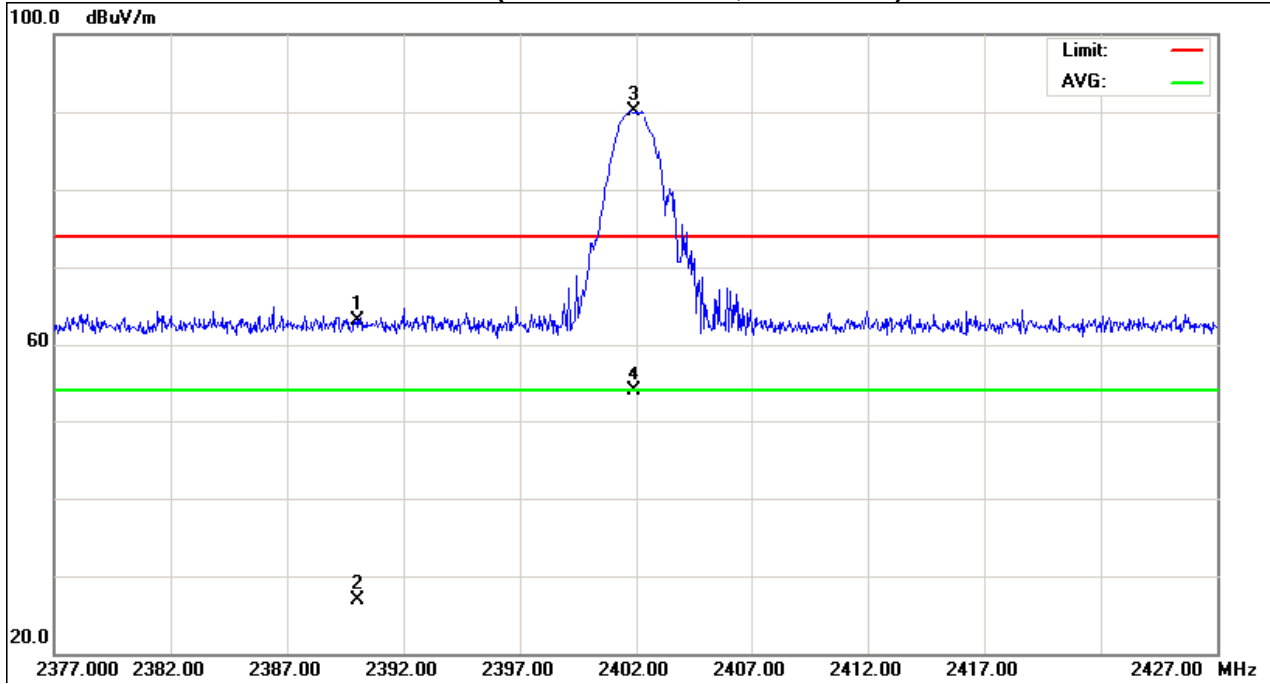



EUT :	Wireless Game Pad Dongle for PS3	Model Name :	BB-6308A
Temperature :	20 °C	Relative Humidity :	51 %
Pressure :	1010 hPa	Test Voltage :	AC 120V/60Hz
Test Mode :	TX 2441MHz		

Freq.	Ant.Pol.	Reading		Ant./CF	Act.		Limit		Note
		Peak	AV		Peak	AV	Peak	AV	
(MHz)	H/V	(dBuV)	(dBuV)	CF(dB)	(dBuV/m)	(dBuV/m)	(dBuV/m)	(dBuV/m)	
<b>2440.70</b>	<b>V</b>	<b>55.22</b>	<b>19.11</b>	<b>31.62</b>	<b>86.84</b>	<b>50.73</b>			<b>X/F</b>
4881.36	V	56.43	20.32	6.17	62.60	26.49	74.00	54.00	X/H

Remark :

- (1) All readings are Peak unless otherwise stated QP in column of 『Note』 . Peak denotes that the Peak reading compliance with the QP Limits and then QP Mode measurement didn't perform ◦
- (2) Measuring frequency range from 30MHz to 1000MHz or the 10th harmonic of highest fundamental frequency ◦ "F" denotes fundamental frequency; "H" denotes spurious frequency. "E" denotes band edge frequency. (This judgment method includes the Band Edge Requirement.)
- (3) Radiated emissions measured in frequency range above 1000MHz were made with an instrument using Peak detector mode and AV detector mode of the emission ◦
- (4) Data of measurement within this frequency range shown " \* " in the table above means the reading of emissions are attenuated more than 20dB below the permissible limits or the field strength is too small to be measured.
- (5) A preamp and high pass filter were used for this test in order to provide sufficient measurement sensitivity.
- (6) EUT Orthogonal Axis :  
 "X" - denotes Laid on Table ; "Y" - denotes Vertical Stand ; "Z" - denotes Side Stand
- (7) During the measurements above 1 GHz it is taken care of that the EUT is always within the 3 dB cone of radiation BW of the used antenna
- (8) The average value of fundamental frequency is:  
 Average = Peak value + 20log(Duty cycle) ◦ Final AV=PK-36.11



TX CH36 (Above 1000 MHz, Vertical)

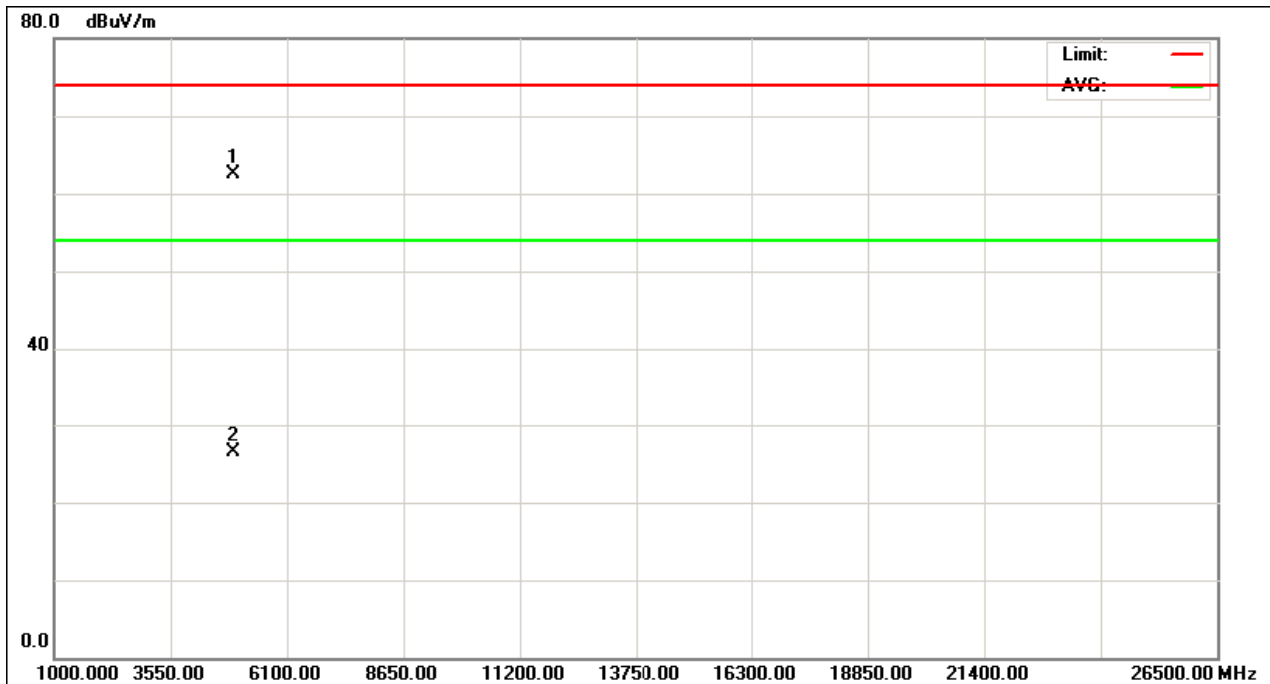
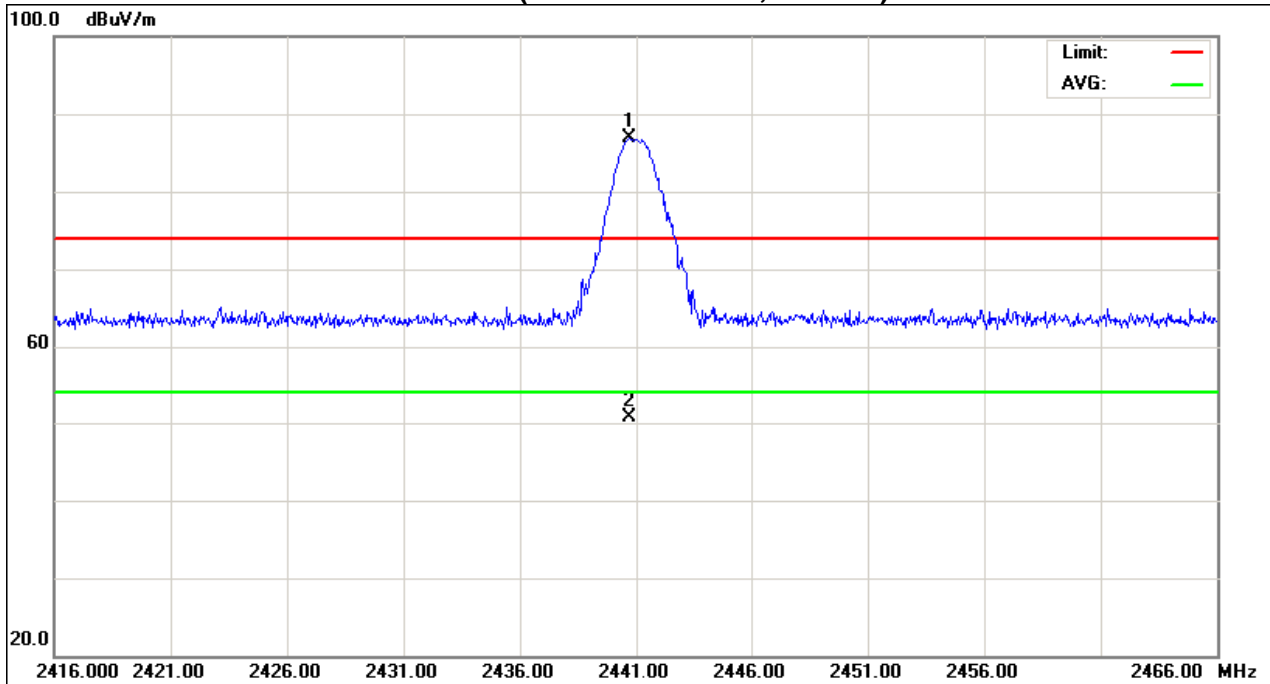



EUT :	Wireless Game Pad Dongle for PS3	Model Name :	BB-6308A
Temperature :	20 °C	Relative Humidity :	51 %
Pressure :	1010 hPa	Test Voltage :	AC 120V/60Hz
Test Mode :	TX 2441MHz		

Freq.	Ant.Pol.	Reading		Ant./CF	Act.		Limit		Note
		Peak	AV		Peak	AV	Peak	AV	
(MHz)	H/V	(dBuV)	(dBuV)	CF(dB)	(dBuV/m)	(dBuV/m)	(dBuV/m)	(dBuV/m)	
<b>2441.35</b>	<b>H</b>	<b>59.58</b>	<b>23.47</b>	<b>31.63</b>	<b>91.21</b>	<b>55.10</b>			<b>X/F</b>
4879.96	H	52.01	15.90	6.17	58.18	22.07	74.00	54.00	X/H

**Remark :**

- (1) All readings are Peak unless otherwise stated QP in column of 『Note』 . Peak denotes that the Peak reading compliance with the QP Limits and then QP Mode measurement didn't perform .
- (2) Measuring frequency range from 30MHz to 1000MHz or the 10th harmonic of highest fundamental frequency .“F” denotes fundamental frequency; “H” denotes spurious frequency. “E” denotes band edge frequency. (This judgment method includes the Band Edge Requirement.)
- (3) Radiated emissions measured in frequency range above 1000MHz were made with an instrument using Peak detector mode and AV detector mode of the emission .
- (4) Data of measurement within this frequency range shown “ \* ” in the table above means the reading of emissions are attenuated more than 20dB below the permissible limits or the field strength is too small to be measured.
- (5) A preamp and high pass filter were used for this test in order to provide sufficient measurement sensitivity.
- (6) EUT Orthogonal Axis :  
 “X” - denotes Laid on Table ; “Y” - denotes Vertical Stand ; “Z” - denotes Side Stand
- (7) During the measurements above 1 GHz it is taken care of that the EUT is always within the 3 dB cone of radiation BW of the used antenna
- (8) The average value of fundamental frequency is:  
 Average = Peak value + 20log(Duty cycle) · Final AV=PK-36.11





TX CH36 (Above 1000 MHz, Horizontal)

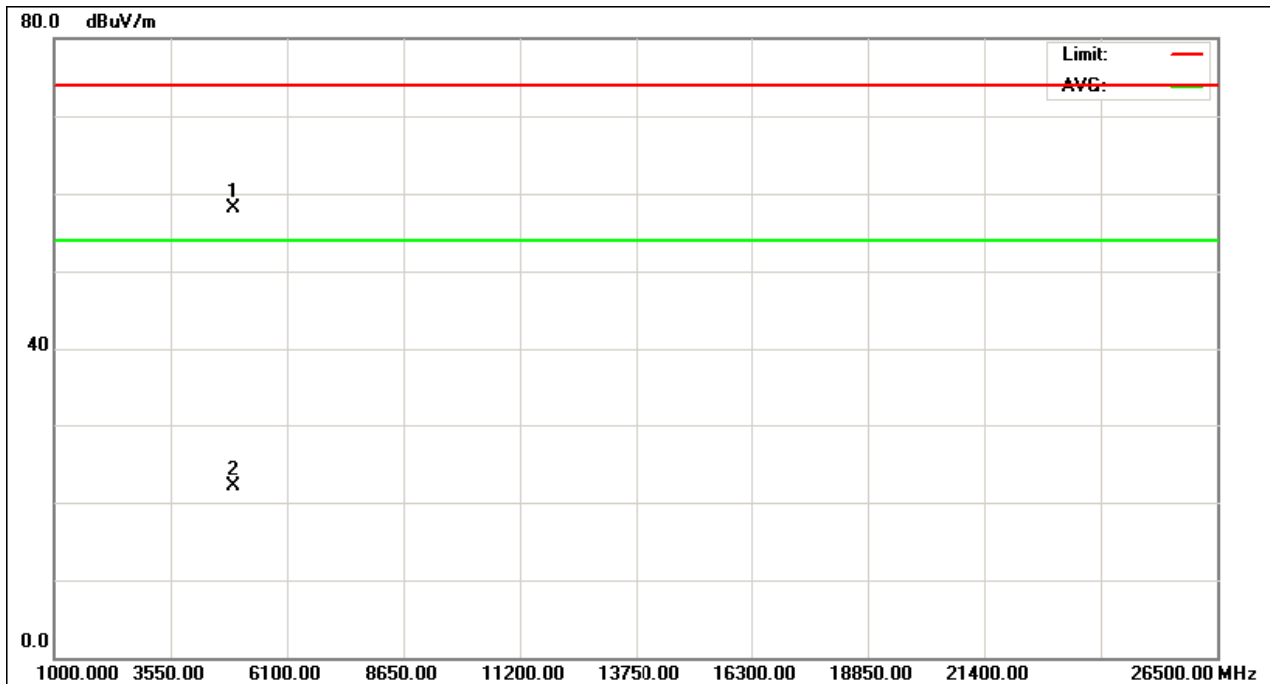
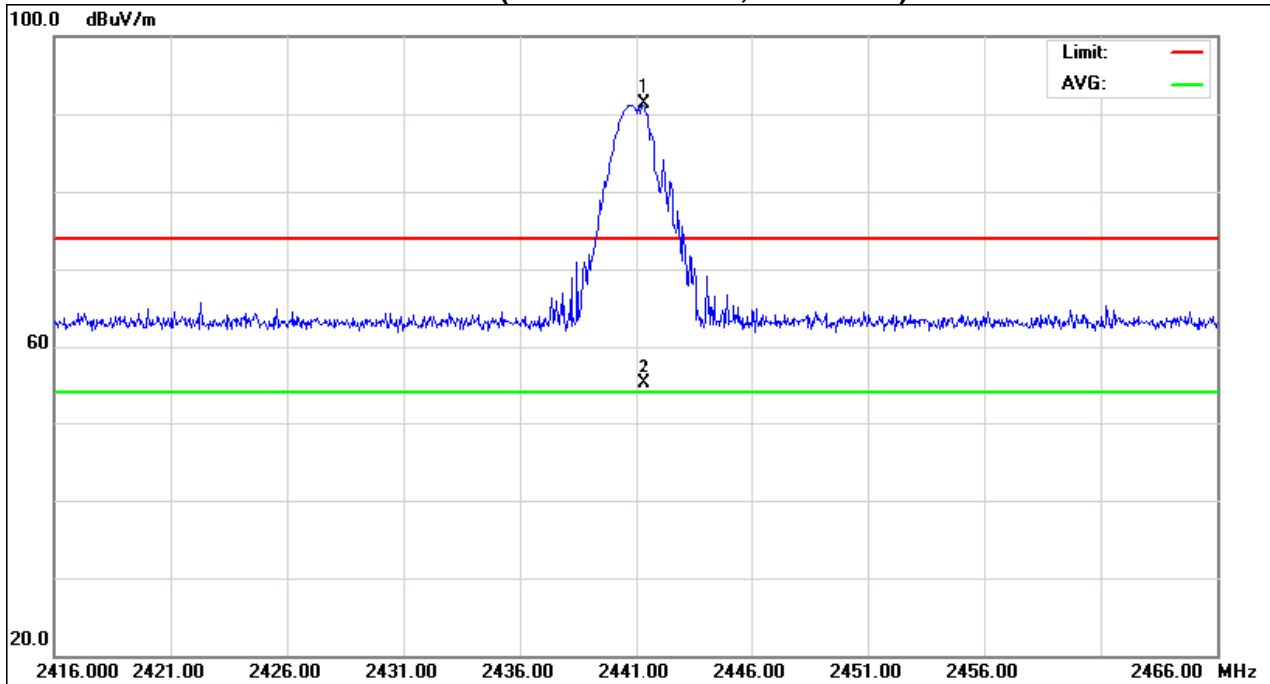



EUT :	Wireless Game Pad Dongle for PS3	Model Name :	BB-6308A
Temperature :	20 °C	Relative Humidity :	51 %
Pressure :	1010hPa	Test Voltage :	AC 120V/60Hz
Test Mode :	TX 2480MHz		

Freq.	Ant.Pol.	Reading		Ant./CF	Act.		Limit		Note
		Peak	AV		Peak	AV	Peak	AV	
(MHz)	H/V	(dBuV)	(dBuV)	CF(dB)	(dBuV/m)	(dBuV/m)	(dBuV/m)	(dBuV/m)	
<b>2480.05</b>	<b>V</b>	<b>53.55</b>	<b>17.44</b>	<b>31.69</b>	<b>85.24</b>	<b>49.13</b>			<b>X/F</b>
2483.50	V	31.21	-4.84	31.70	62.91	26.86	74.00	54.00	X/E
4960.16	V	55.47	19.36	6.40	61.87	6.11	74.00	54.00	X/H

Remark :

- (1) All readings are Peak unless otherwise stated QP in column of 『Note』 . Peak denotes that the Peak reading compliance with the QP Limits and then QP Mode measurement didn't perform ◦
- (2) Measuring frequency range from 30MHz to 1000MHz or the 10th harmonic of highest fundamental frequency ◦ "F" denotes fundamental frequency; "H" denotes spurious frequency. "E" denotes band edge frequency. (This judgment method includes the Band Edge Requirement.)
- (3) Radiated emissions measured in frequency range above 1000MHz were made with an instrument using Peak detector mode and AV detector mode of the emission ◦
- (4) Data of measurement within this frequency range shown " \* " in the table above means the reading of emissions are attenuated more than 20dB below the permissible limits or the field strength is too small to be measured.
- (5) A preamp and high pass filter were used for this test in order to provide sufficient measurement sensitivity.
- (6) EUT Orthogonal Axis :  
 "X" - denotes Laid on Table ; "Y" - denotes Vertical Stand ; "Z" - denotes Side Stand
- (7) During the measurements above 1 GHz it is taken care of that the EUT is always within the 3 dB cone of radiation BW of the used antenna
- (8) The average value of fundamental frequency is:  
 Average = Peak value + 20log(Duty cycle) ◦ Final AV=PK-36.11



TX CH64 (Above 1000 MHz, Vertical)

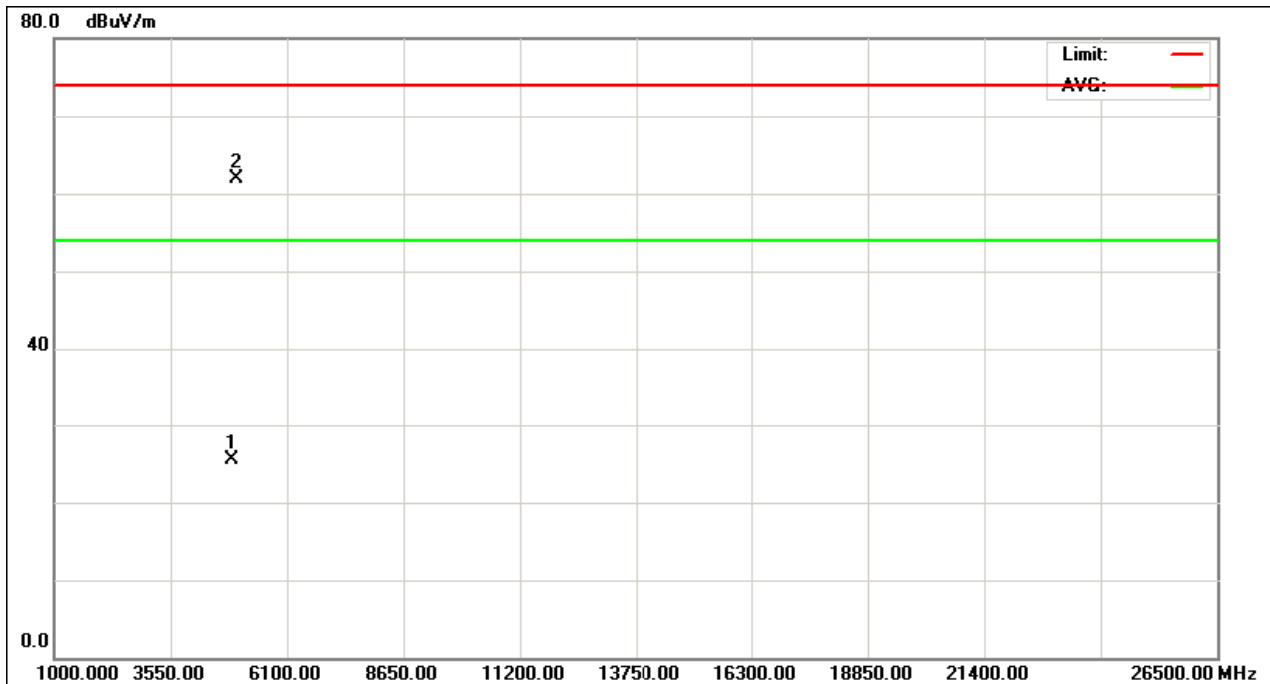
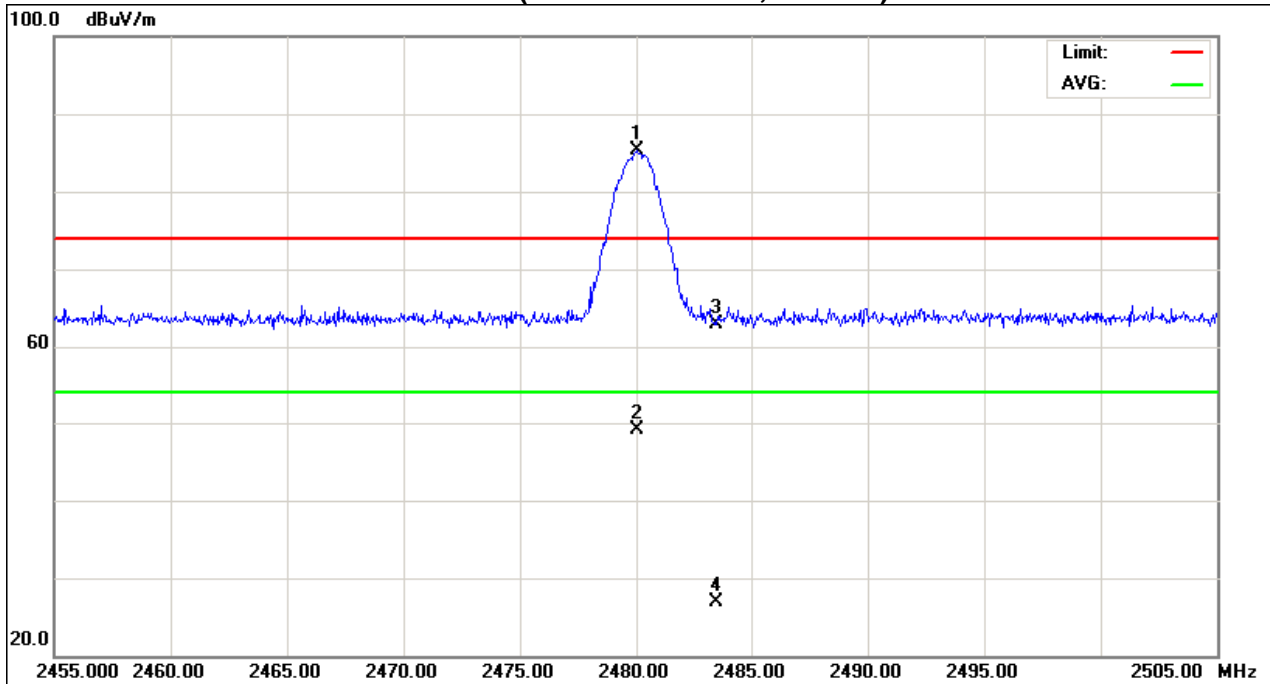



EUT :	Wireless Game Pad Dongle for PS3	Model Name :	BB-6308A
Temperature :	20 °C	Relative Humidity :	51 %
Pressure :	1010 hPa	Test Voltage :	AC 120V/60Hz
Test Mode :	TX 2480MHz		

Freq.	Ant.Pol.	Reading		Ant./CF	Act.		Limit		Note
		Peak	AV		Peak	AV	Peak	AV	
(MHz)	H/V	(dBuV)	(dBuV)	CF(dB)	(dBuV/m)	(dBuV/m)	(dBuV/m)	(dBuV/m)	
<b>2479.95</b>	<b>H</b>	<b>56.78</b>	<b>20.67</b>	<b>31.69</b>	<b>88.47</b>	<b>52.36</b>			<b>X/F</b>
2483.50	H	31.20	-4.91	31.70	62.90	26.79	74.00	54.00	X/E
4967.27	H	52.28	16.17	6.42	58.70	22.59	74.00	54.00	X/H

Remark :

- (1) All readings are Peak unless otherwise stated QP in column of 『Note』 . Peak denotes that the Peak reading compliance with the QP Limits and then QP Mode measurement didn't perform .
- (2) Measuring frequency range from 30MHz to 1000MHz or the 10th harmonic of highest fundamental frequency . "F" denotes fundamental frequency; "H" denotes spurious frequency. "E" denotes band edge frequency. (This judgment method includes the Band Edge Requirement.)
- (3) Radiated emissions measured in frequency range above 1000MHz were made with an instrument using Peak detector mode and AV detector mode of the emission .
- (4) Data of measurement within this frequency range shown " \* " in the table above means the reading of emissions are attenuated more than 20dB below the permissible limits or the field strength is too small to be measured.
- (5) A preamp and high pass filter were used for this test in order to provide sufficient measurement sensitivity.
- (6) EUT Orthogonal Axis :  
 "X" - denotes Laid on Table ; "Y" - denotes Vertical Stand ; "Z" - denotes Side Stand
- (7) During the measurements above 1 GHz it is taken care of that the EUT is always within the 3 dB cone of radiation BW of the used antenna
- (8) The average value of fundamental frequency is:  
 Average = Peak value + 20log(Duty cycle) · Final AV=PK-36.11



TX CH64 (Above 1000 MHz, Horizontal)

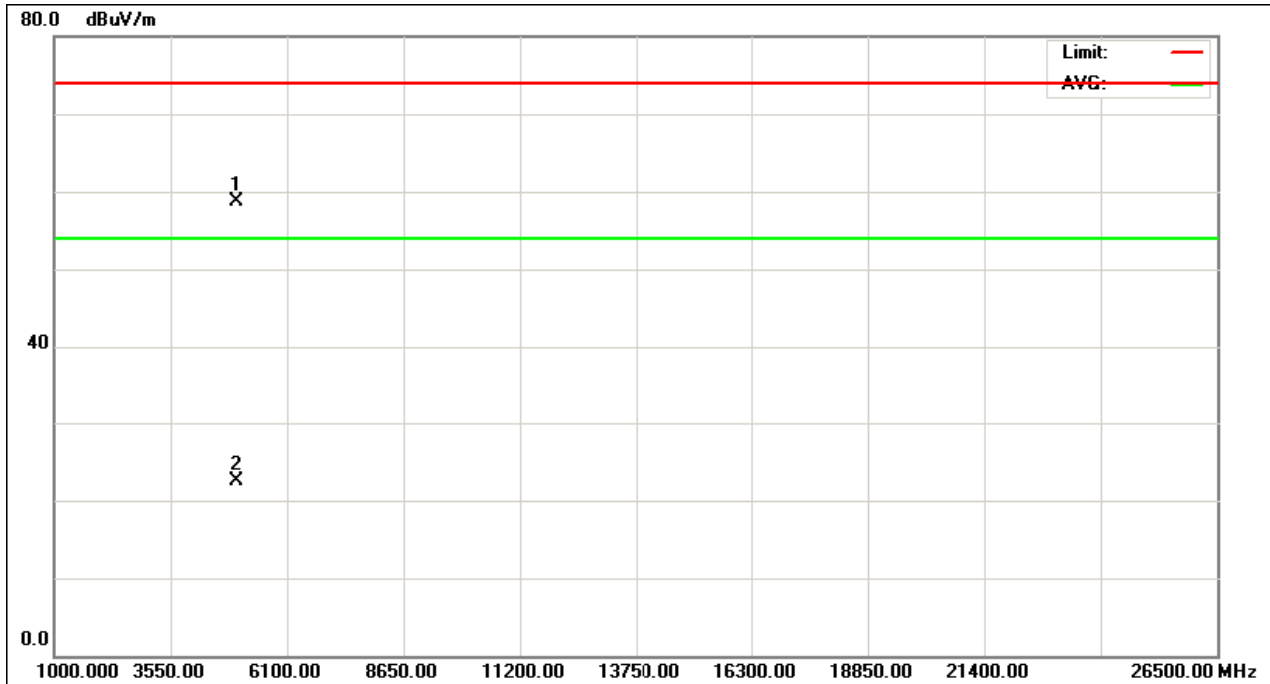
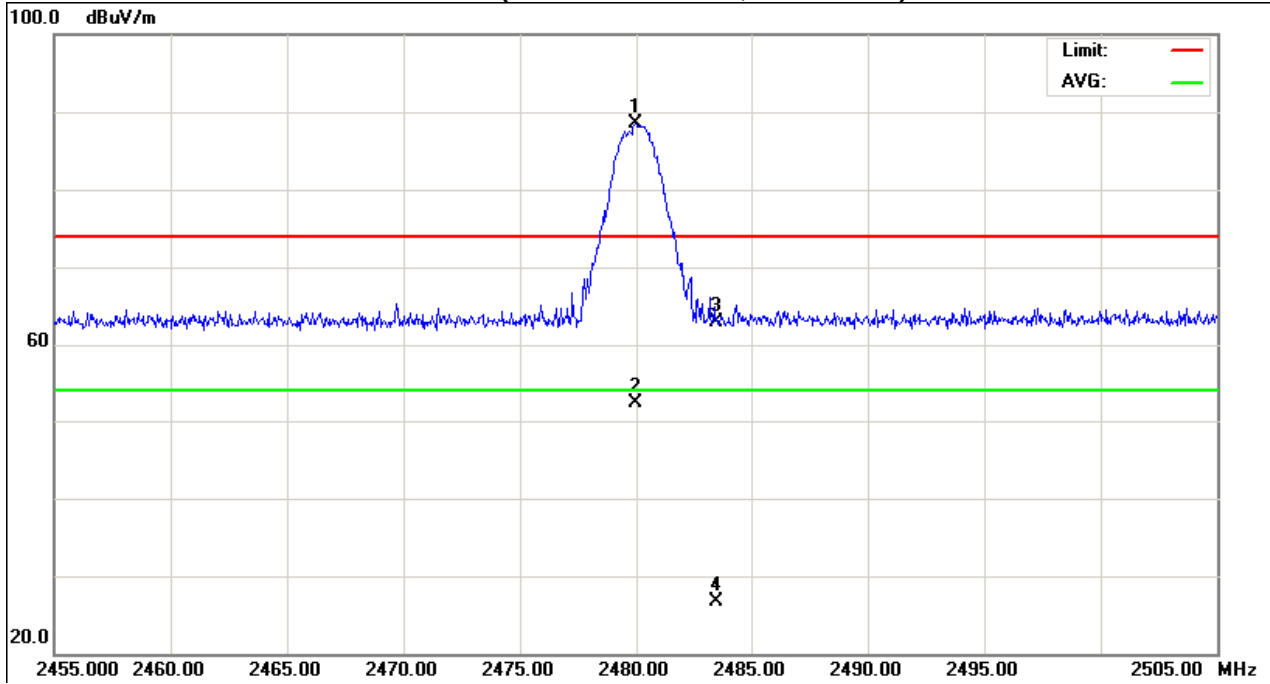



**5. NUMBER OF HOPPING CHANNEL**

**5.1 APPLIED PROCEDURES / LIMIT**

FCC Part15 (15.247) , Subpart C			
Section	Test Item	Frequency Range (MHz)	Result
15.247 (a)(1)(iii)	Number of Hopping Channel	2400-2483.5	PASS

**5.1.1 MEASUREMENT INSTRUMENTS LIST AND SETTING**

Item	Kind of Equipment	Manufacturer	Type No.	Serial No.	Calibrated until
1	Spectrum Analyzer	R&S	FSP 40	100185	Nov.27.2010

Remark: " N/A" denotes No Model Name , Serial No. or No Calibration specified.

Spectrum Parameters	Setting
Attenuation	Auto
Span Frequency	> Operating Frequency Range
RB	100 kHz
VB	100 kHz
Detector	Peak
Trace	Max Hold
Sweep Time	Auto

**5.1.2 TEST PROCEDURE**

- a. The EUT was directly connected to the spectrum analyzer and antenna output port as show in the block diagram below,
- b. Spectrum Setting : RBW= 100KHz, VBW=100KHz, Sweep time = Auto.

**5.1.3 DEVIATION FROM STANDARD**

No deviation.

**5.1.4 TEST SETUP**



**5.1.5 EUT OPERATION CONDITIONS**

The EUT tested system was configured as the statements of 4.1.6 Unless otherwise a special operating condition is specified in the follows during the testing.



**5.1.6 TEST RESULTS**

EUT :	Wireless Game Pad Dongle for PS3	Model Name :	BB-6308A
Temperature :	20 °C	Relative Humidity :	60 %
Pressure :	1010 hPa	Test Voltage :	AC 120V/60Hz
Test Mode :	Hopping Mode -Group 1		

Number of Hopping Channel	16
---------------------------	----

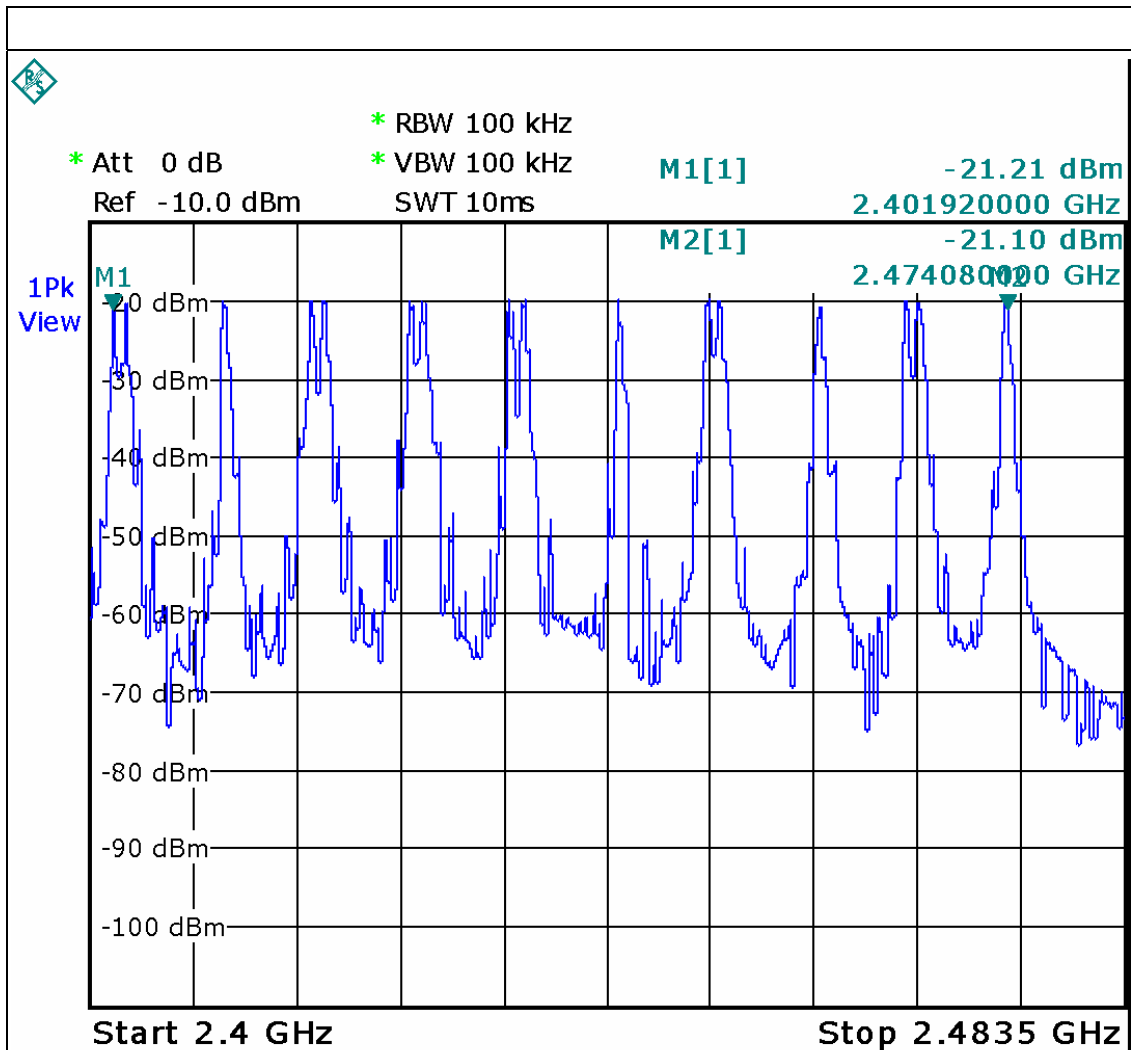

Date: 2.SEP.2010 13:23:39

**6. AVERAGE TIME OF OCCUPANCY**

**6.1 APPLIED PROCEDURES / LIMIT**

FCC Part15 (15.247) , Subpart C				
Section	Test Item	Limit	Frequency Range (MHz)	Result
15.247 (a)(1)(iii)	Average Time of Occupancy	0.4sec	2400-2483.5	PASS

**6.1.1 MEASUREMENT INSTRUMENTS LIST**

Item	Kind of Equipment	Manufacturer	Type No.	Serial No.	Calibrated until
1	Spectrum Analyzer	R&S	FSP 40	100185	Nov.27.2010

Remark: " N/A" denotes No Model Name , Serial No. or No Calibration specified.

**6.1.2. TEST PROCEDURES**

- a. The transmitter output (antenna port) was connected to the spectrum analyzer
- b. Set RBW of spectrum analyzer to 1MHz and VBW to 1MHz.
- c. Use a video trigger with the trigger level set to enable triggering only on full pulses.
- d. Sweep Time is more than once pulse time.
- e. Set the center frequency on any frequency would be measure and set the frequency span to zero span.
- f. Measure the maximum time duration of one single pulse.
- g. Set the EUT for packet transmitting.
- h. Measure the maximum time duration of one single pulse.
- i. Dwell time = [spreading rate/16] x duty-cycle x 0.4 seconds

**6.1.3. TEST SETUP LAYOUT**

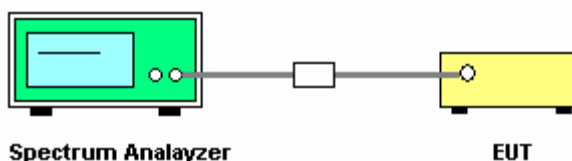

**6.1.4. TEST DEVIATION**

There is no deviation with the original standard.

**6.1.5. EUT OPERATION DURING TEST**

The EUT was programmed to be in continuously transmitting/Hopping mode.





**6.1.6. TEST RESULTS**

EUT :	Wireless Game Pad Dongle for PS3	Model Name :	BB-6308A
Temperature :	23 °C	Relative Humidity :	60%
Pressure :	1015 hPa	Test Voltage :	AC 120V/60Hz
Test Mode :	Hopping Mode		

Mode	Number of transmission in a 6.4 (16Hopping*0.4)	Length of transmission time (msec)	Result (msec)	Limit (msec)
2402 MHz	(25/5) *6.4=32 times <b>Note1</b>	0.3	9.6	400

**Note1:** 25 times of occupied channels per 5 second

	Results
Measured cycle (sec)	16 CH*0.4=6.4
The total number of frequency-hopping per second	((25/5)*16)=80
The number of occupied channels per second	80/16=5(number/sec)
occupied time for each channel(1)	0.3ms
The total number of channels occupied within one cycle (2)	(25 /5) *6.4=32 times
The average time of occupancy within one cycle(1)*(2)	9.6msec
LIMIT (msec)	400msec

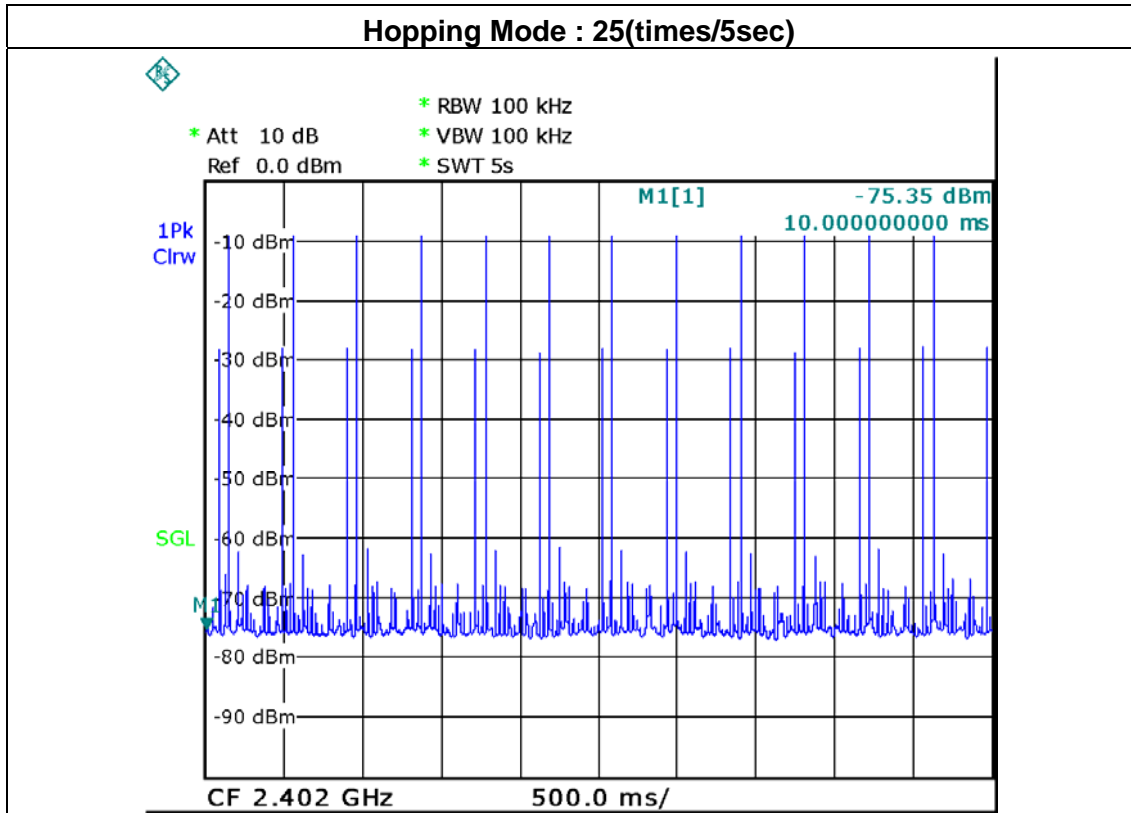

Date: 25.AUG.2010 15:45:39

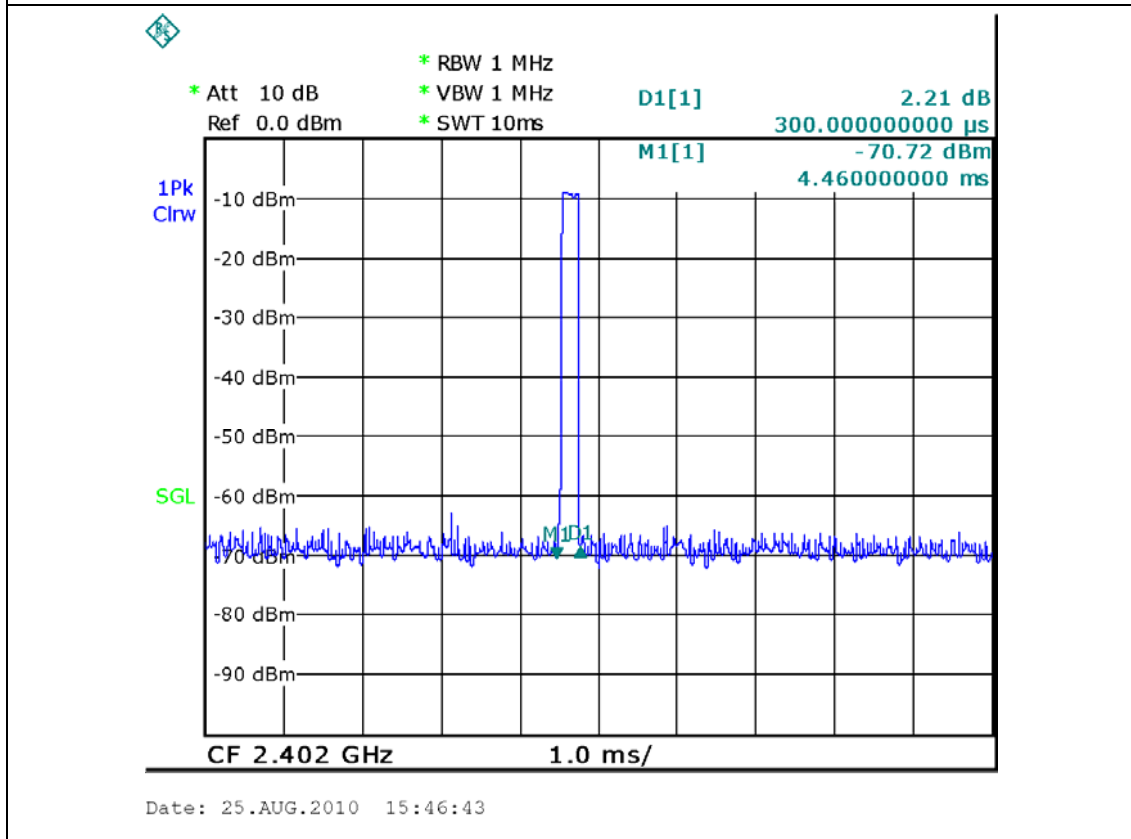

Date: 25.AUG.2010 15:46:43

## 7. HOPPING CHANNEL SEPARATION MEASUREMENT

### 7.1 APPLIED PROCEDURES / LIMIT

Frequency hopping systems operating in the 2400-2483.5 MHz band may have hopping channel carrier frequencies that are separated by 25 kHz or two-thirds of the 20 dB bandwidth of the hopping channel, whichever is greater.

#### 7.1.1 MEASUREMENT INSTRUMENTS LIST AND SETTING

Item	Kind of Equipment	Manufacturer	Type No.	Serial No.	Calibrated until
1	Spectrum Analyzer	R&S	FSP 40	100185	Nov.27.2010

Remark: " N/A" denotes No Model Name , Serial No. or No Calibration specified.

Spectrum Parameter	Setting
Attenuation	Auto
Span Frequency	> Measurement Bandwidth or Channel Separation
RB	30 kHz (20dB Bandwidth) / 100 kHz (Channel Separation)
VB	100 kHz (20dB Bandwidth) / 300 kHz (Channel Separation)
Detector	Peak
Trace	Max Hold
Sweep Time	Auto

#### 7.1.2 TEST PROCEDURE

- The transmitter output (antenna port) was connected to the spectrum analyser in peak hold mode.
- The resolution bandwidth of 30 kHz and the video bandwidth of 100 kHz were utilised for 20 dB bandwidth measurement.
- The resolution bandwidth of 100 kHz and the video bandwidth of 300 kHz were utilised for channel separation measurement.

#### 7.1.3 DEVIATION FROM STANDARD

No deviation.

#### 7.1.4 TEST SETUP

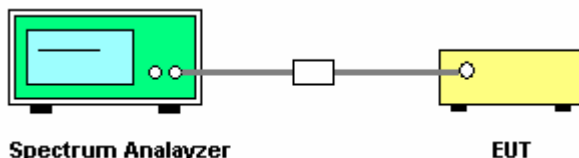

#### 7.1.5 EUT OPERATION CONDITIONS

The EUT was programmed to be in continuously transmitting mode.



**7.1.6 TEST RESULTS**

EUT :	Wireless Game Pad Dongle for PS3	Model Name :	BB-6308A
Temperature :	20 °C	Relative Humidity :	60%
Pressure :	1010 hPa	Test Voltage :	AC 120V/60Hz
Test Mode :	CH01 / CH36/ CH64		

Frequency	Ch. Separation (MHz)	20d Bandwidth B (MHz)	Result
2402 MHz	1	0.998	<b>Complies</b>
2441 MHz	1	0.998	<b>Complies</b>
2480 MHz	1	0.998	<b>Complies</b>

Ch. Separation Limits: >20dB bandwidth or >2/3 of 20dB bandwidth

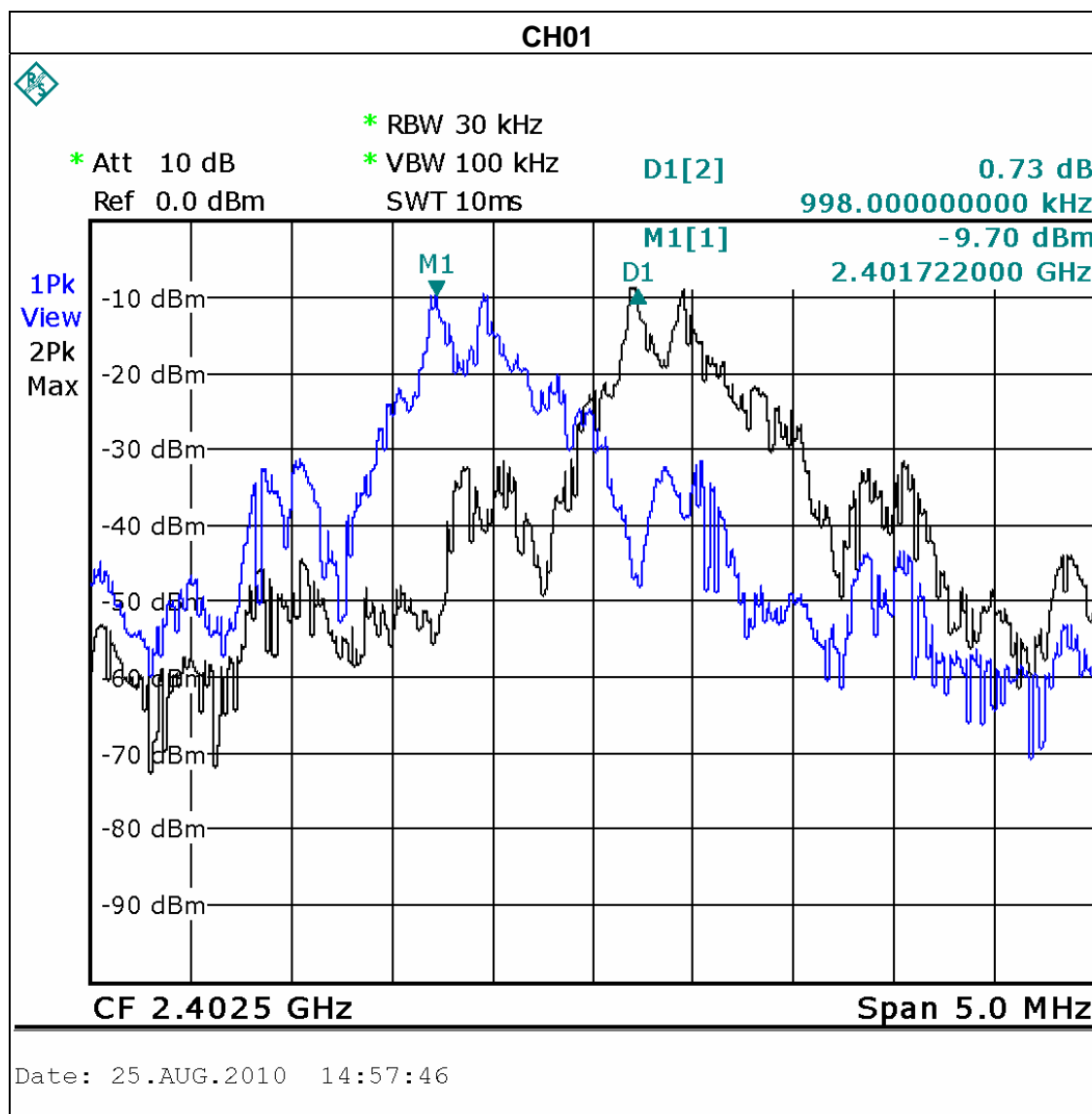

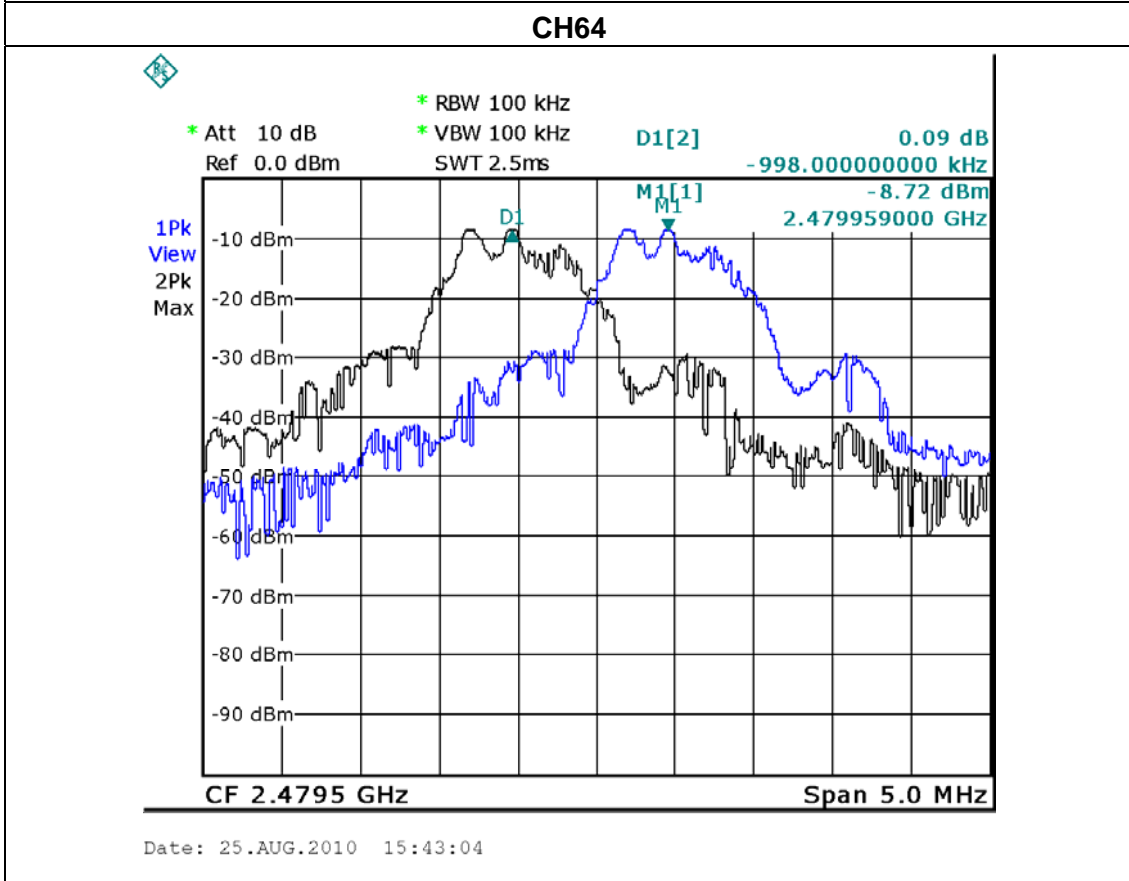
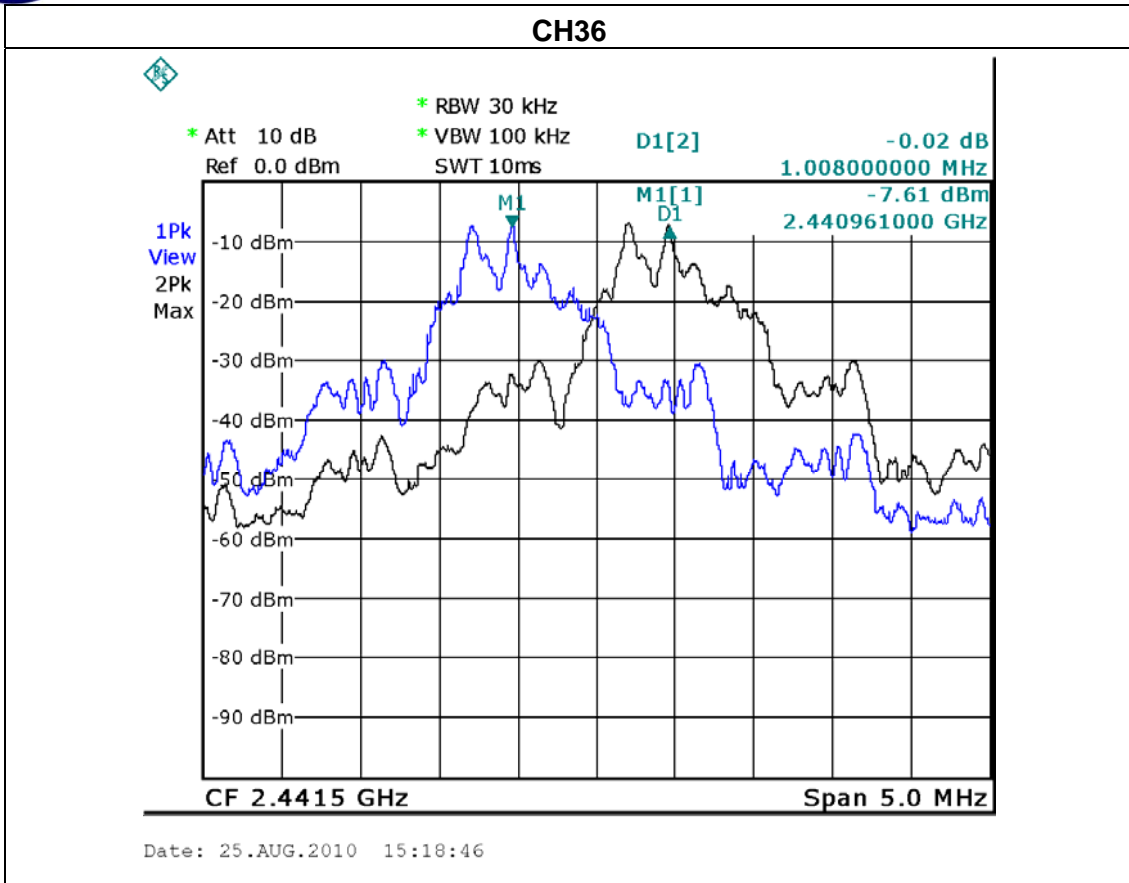



**8. BANDWIDTH TEST**

**8.1 APPLIED PROCEDURES / LIMIT**

FCC Part15 (15.247) , Subpart C				
Section	Test Item	Limit	Frequency Range (MHz)	Result
15.247 (a)(2)	Bandwidth	<= 1 MHz (20dB bandwidth)	2400-2483.5	PASS

**8.1.1 MEASUREMENT INSTRUMENTS LIST AND SETTING**

Item	Kind of Equipment	Manufacturer	Type No.	Serial No.	Calibrated until
1	Spectrum Analyzer	R&S	FSP 40	100185	Nov.27.2010

Remark: " N/A" denotes No Model Name , Serial No. or No Calibration specified.

Spectrum Parameter	Setting
Attenuation	Auto
Span Frequency	> Measurement Bandwidth or Channel Separation
RB	30 kHz (20dB Bandwidth) / 100 kHz (Channel Separation)
VB	100 kHz (20dB Bandwidth) / 300 kHz (Channel Separation)
Detector	Peak
Trace	Max Hold
Sweep Time	Auto

**8.1.2 TEST PROCEDURE**

- a. The EUT was directly connected to the spectrum analyzer and antenna output port as show in the block diagram below,
- b. Spectrum Setting : RBW= 10KHz, VBW=100KHz, Sweep time = Auto.

**8.1.3 DEVIATION FROM STANDARD**

No deviation.

**8.1.4 TEST SETUP**



**8.1.5 EUT OPERATION CONDITIONS**

The EUT tested system was configured as the statements of 4.1.6 Unless otherwise a special operating condition is specified in the follows during the testing.



**8.1.6 TEST RESULTS**

EUT :	Wireless Game Pad Dongle for PS3	Model Name :	BB-6308A
Temperature :	20 °C	Relative Humidity :	60%
Pressure :	1010 hPa	Test Voltage :	AC 120V/60Hz
Test Mode :	CH01 / CH36/ CH64		

Frequency	20dB Bandwidth (MHz)	Channel Separation (MHz)	Result
2402 MHz	0.998	<= 1MHz	<b>PASS</b>
2441 MHz	0.998	<= 1MHz	<b>PASS</b>
2480 MHz	0.998	<= 1MHz	<b>PASS</b>

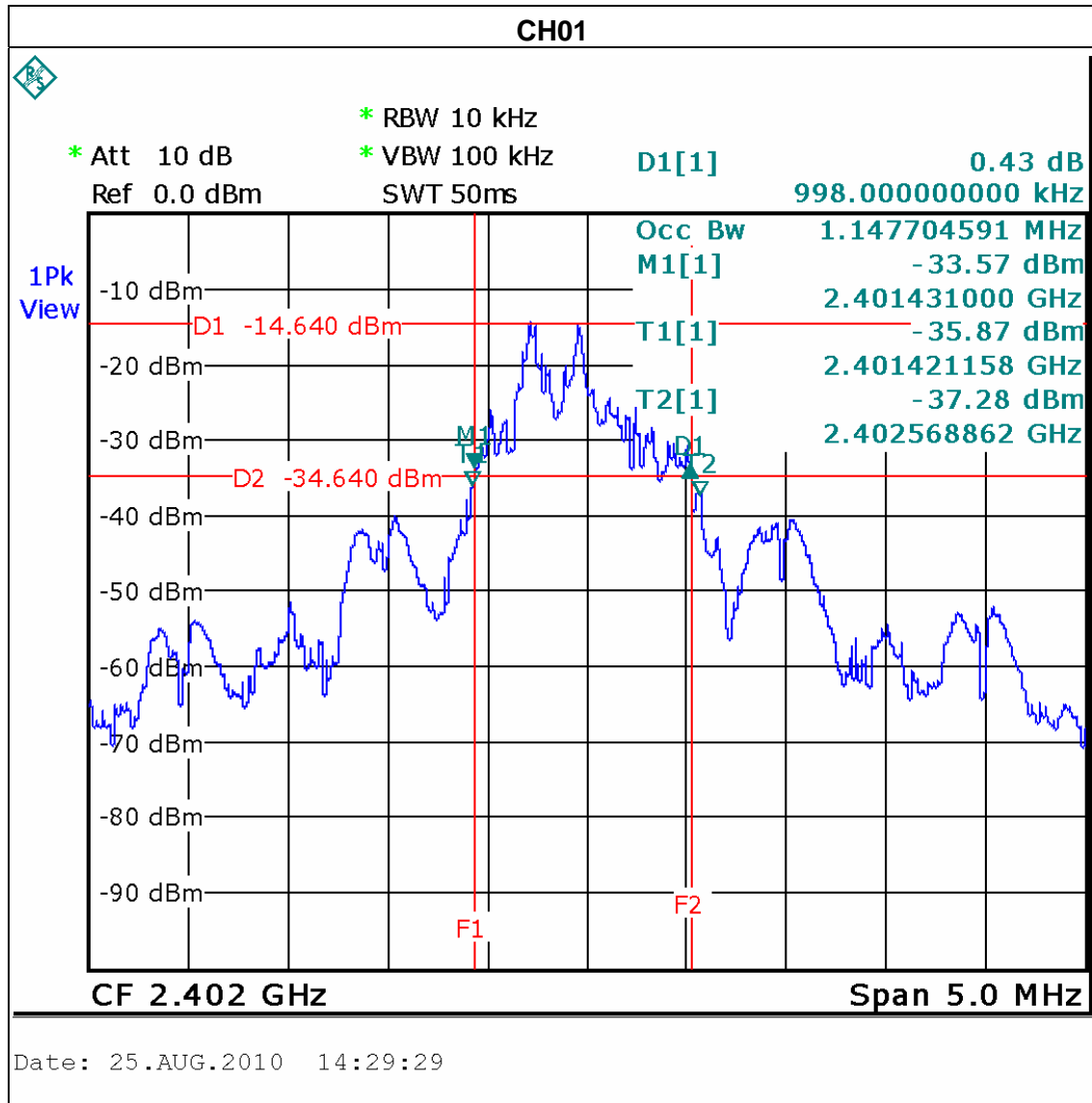

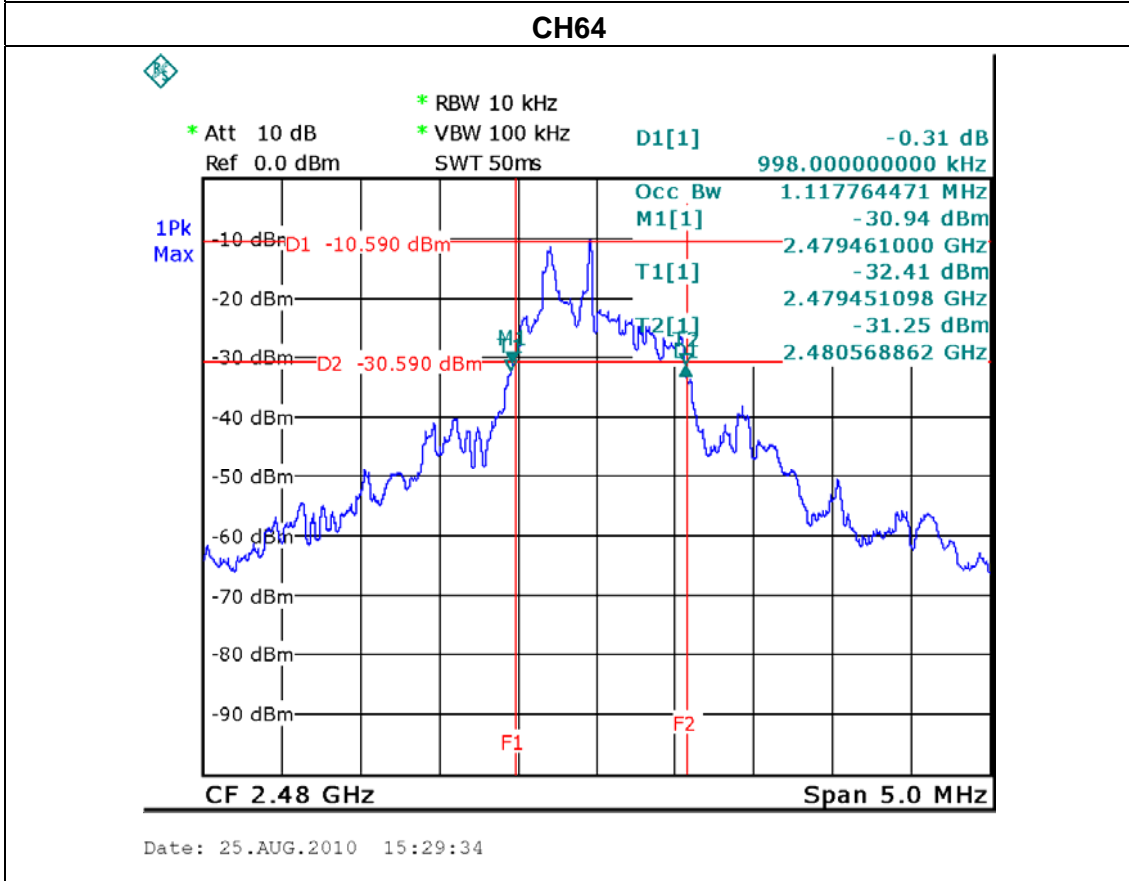
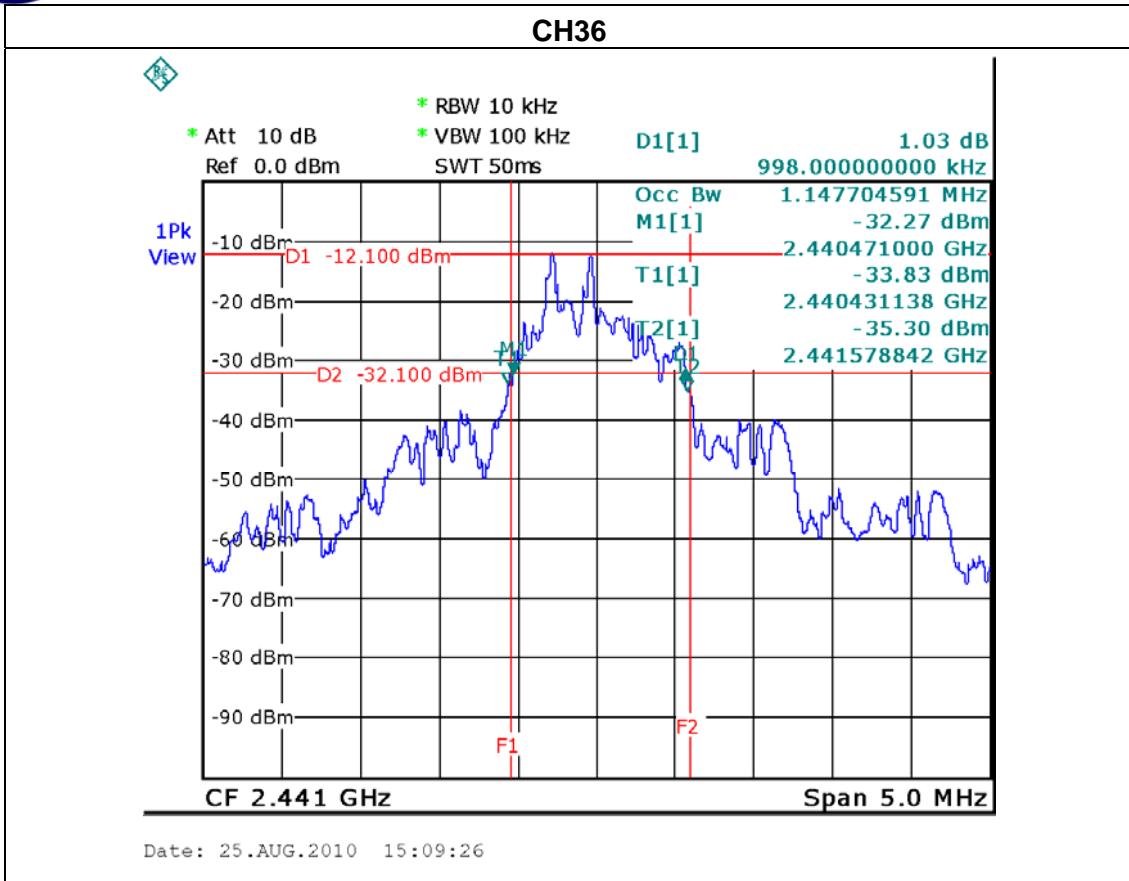





**9. PEAK OUTPUT POWER TEST**

**9.1 APPLIED PROCEDURES / LIMIT**

FCC Part15 (15.247) , Subpart C				
Section	Test Item	Limit	Frequency Range (MHz)	Result
15.247 (b)(1)	Peak Output Power	0.125 watt or 21dBm	2400-2483.5	PASS

**9.1.1 MEASUREMENT INSTRUMENTS LIST AND SETTING**

Item	Kind of Equipment	Manufacturer	Type No.	Serial No.	Calibrated until
1	Spectrum Analyzer	R&S	FSP 40	100185	Nov.27.2010

Remark: " N/A" denotes No Model Name , Serial No. or No Calibration specified.

**9.1.2 TEST PROCEDURE**

- a. The EUT was directly connected to the spectrum analyzer and antenna output port as show in the block diagram below,
- b. Spectrum Setting : RBW= 1MHz, VBW= 1MHz, Sweep time = Auto.

**9.1.3 DEVIATION FROM STANDARD**

No deviation.

**9.1.4 TEST SETUP**



**9.1.5 EUT OPERATION CONDITIONS**

The EUT tested system was configured as the statements of 4.1.6 Unless otherwise a special operating condition is specified in the follows during the testing.



**9.1.6 TEST RESULTS**

EUT :	Wireless Game Pad Dongle for PS3	Model Name :	BB-6308A
Temperature :	20 °C	Relative Humidity :	60%
Pressure :	1010 hPa	Test Voltage :	AC 120V/60Hz
Test Mode :	CH01 / CH36/ CH64		

Test Channel	Frequency (MHz)	Peak Output Power (dBm)	LIMIT (dBm)	LIMIT (W)
CH01	2402	-8.28	21	0.125
CH36	2441	-7.09	21	0.125
CH64	2480	-7.63	21	0.125

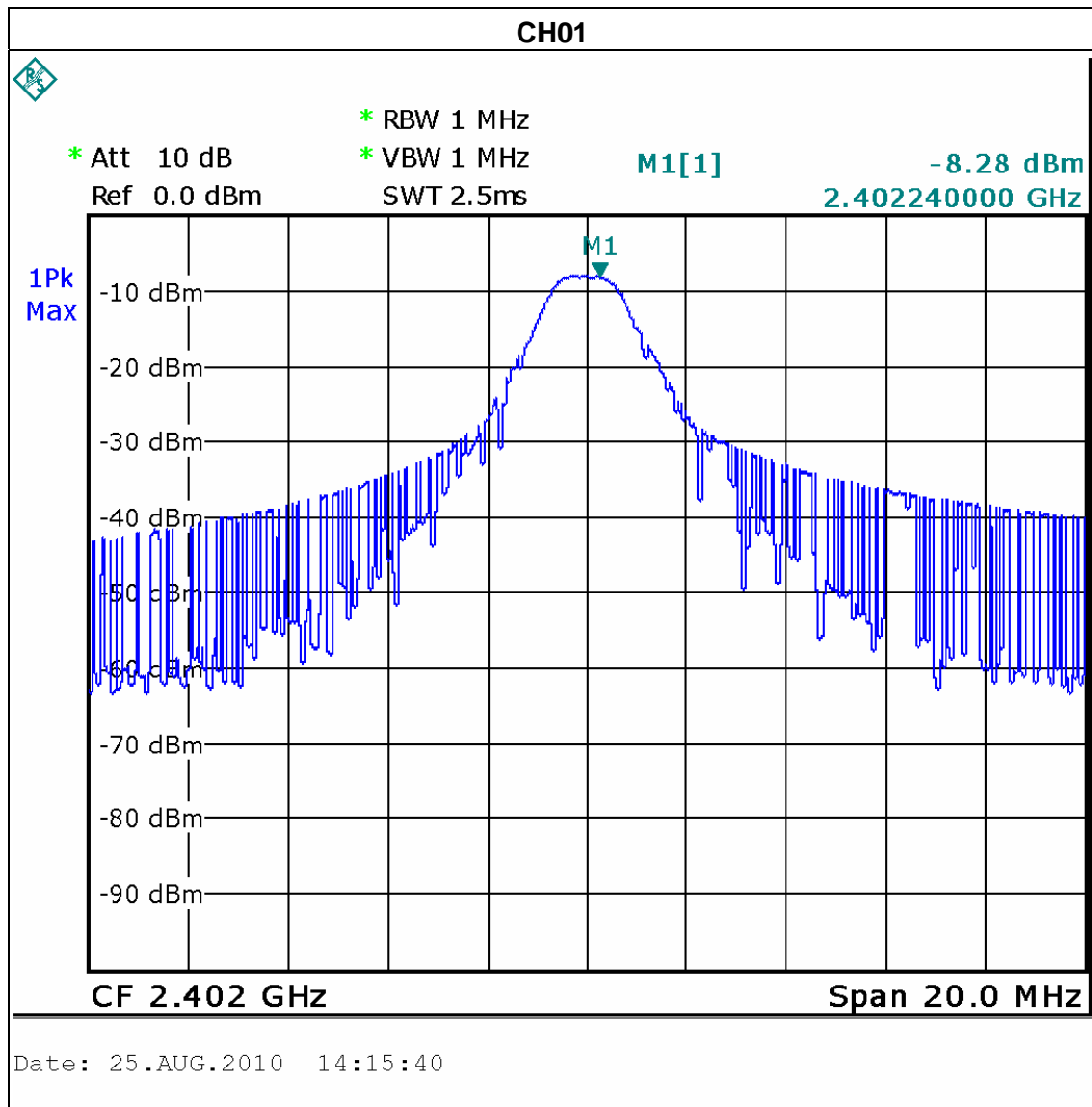



### CH36

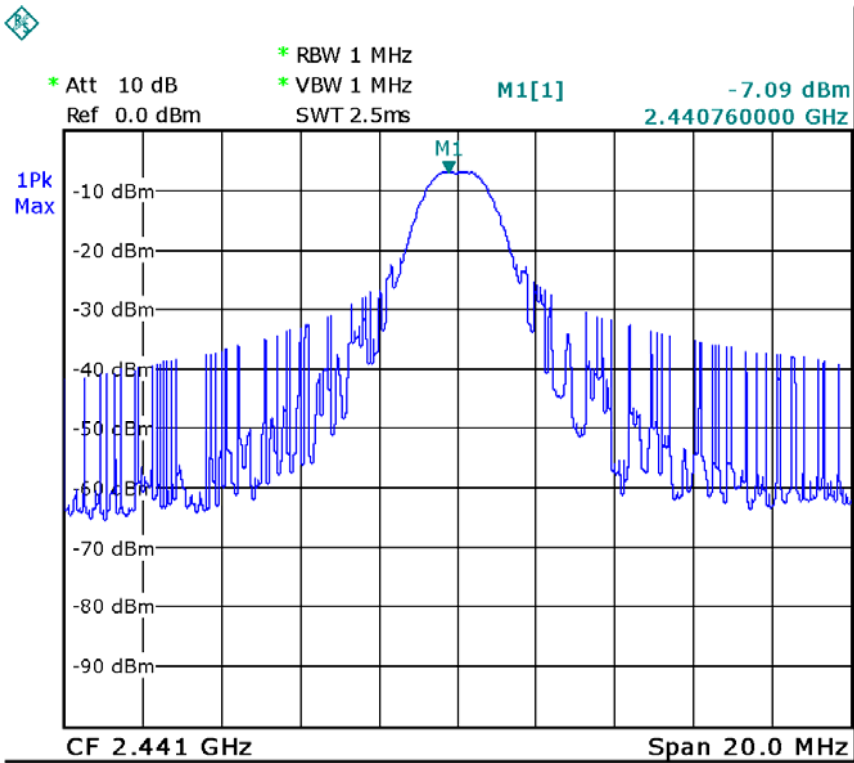

Date: 25.AUG.2010 15:01:43

### CH64

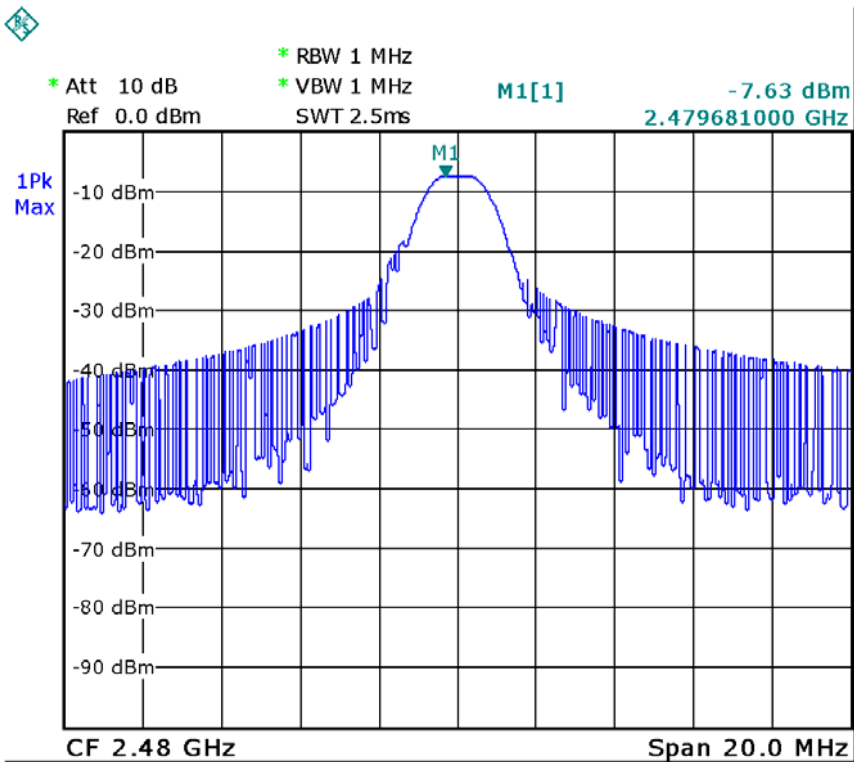

Date: 25.AUG.2010 15:21:38



**10. ANTENNA CONDUCTED SPURIOUS EMISSION**

**10.1 APPLIED PROCEDURES / LIMIT**

20dBc in any 100 kHz bandwidth outside the operating frequency band. In case the emission fall within the restricted band specified on 15.205(a), then the 15.209(a) limit in the table below has to be followed.

Frequencies (MHz)	Field Strength (micorvolts/meter)	Measurement Distance (meters)
0.009~0.490	2400/F(KHz)	300
0.490~1.705	24000/F(KHz)	30
1.705~30.0	30	30
30~88	100	3
88~216	150	3
216~960	200	3
Above 960	500	3

**10.1.1 MEASUREMENT INSTRUMENTS LIST AND SETTING**

Item	Kind of Equipment	Manufacturer	Type No.	Serial No.	Calibrated until
1	Spectrum Analyzer	R&S	FSP 40	100185	Nov.27.2010

Remark: " N/A" denotes No Model Name , Serial No. or No Calibration specified.

**10.1.2 TEST PROCEDURE**

- a. The EUT was directly connected to the spectrum analyzer and antenna output port as show in the block diagram below,
- b. Spectrum Setting : RBW= 100KHz, VBW=100KHz, Sweep time = Auto.

**10.1.3 DEVIATION FROM STANDARD**

No deviation.

**10.1.4 TEST SETUP**



**10.1.5 EUT OPERATION CONDITIONS**

The EUT tested system was configured as the statements of 4.1.6 Unless otherwise a special operating condition is specified in the follows during the testing.



**10.1.6 TEST RESULTS**

EUT :	Wireless Game Pad Dongle for PS3	Model Name :	BB-6308A
Temperature :	20 °C	Relative Humidity :	60 %
Pressure :	1010 hPa	Test Voltage :	AC 120V/60Hz
Test Mode :	CH01 / CH64		

The max. radio frequency power in any 100kHz bandwidth outside the frequency band		The max. radio frequency power in any 100 kHz bandwidth within the frequency band.	
FREQUENCY(MHz)	POWER(dBm)	FREQUENCY(MHz)	POWER(dBm)
2385.14	-66.24	2486.08	-57.79

**Result**

In any 100kHz bandwidth outside the frequency band, the radio frequency power is at least 20dB below that in the 100kHz bandwidth within the band that contains the highest level of the desired power.

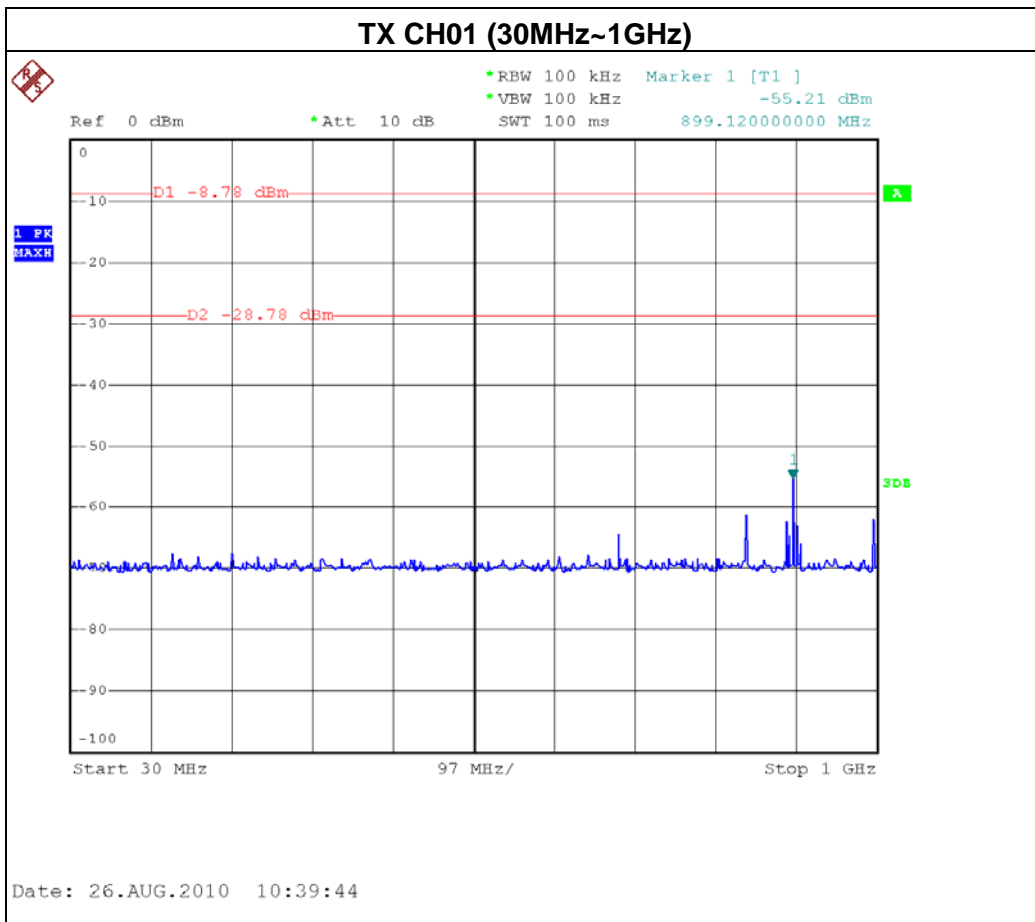
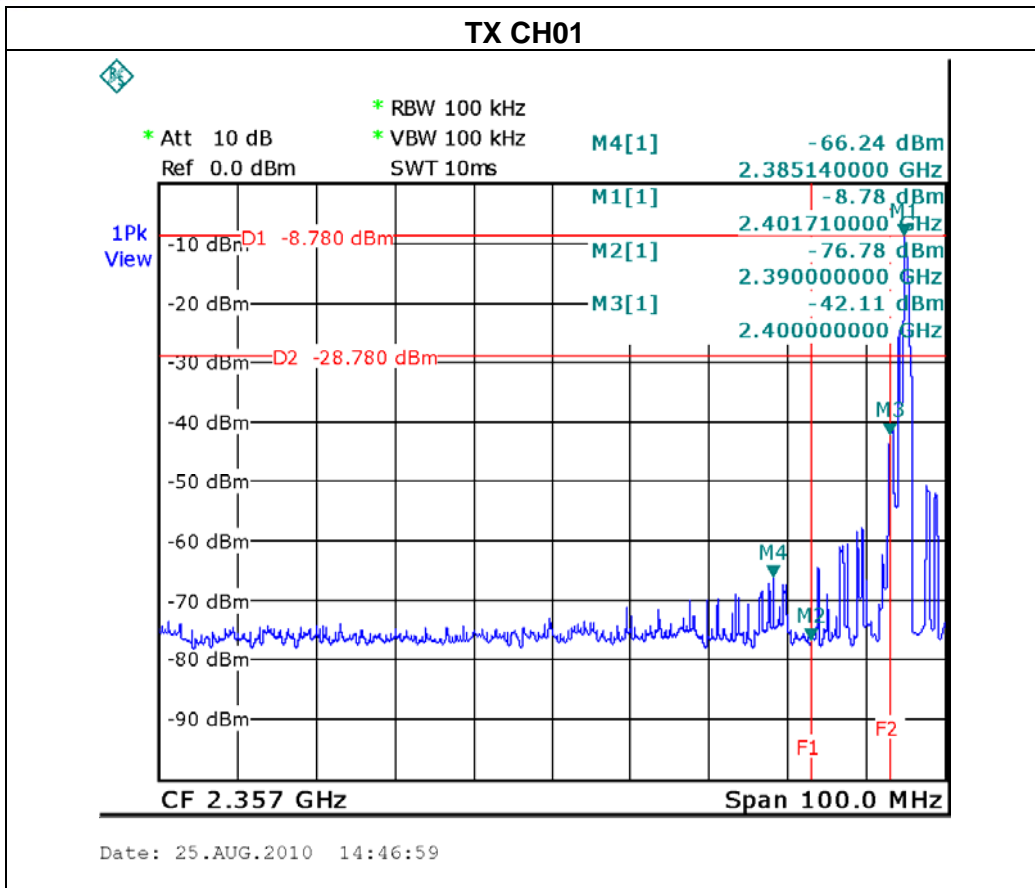

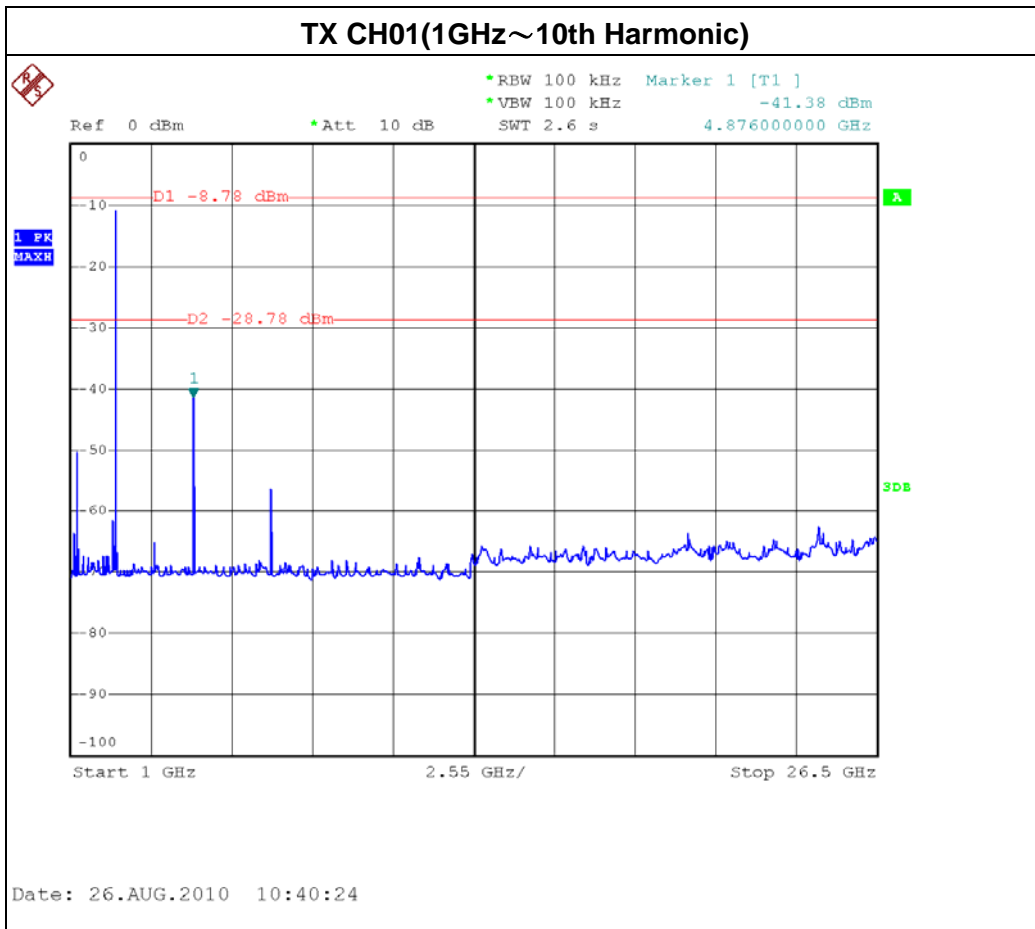

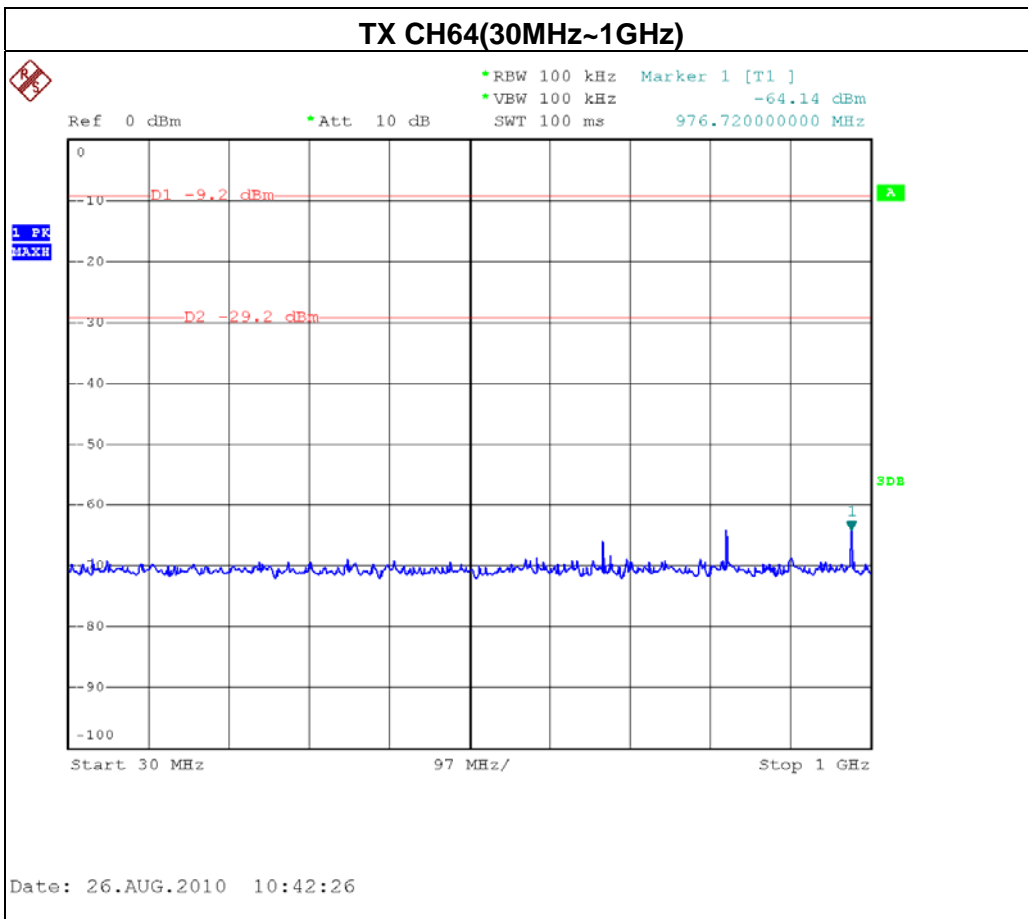
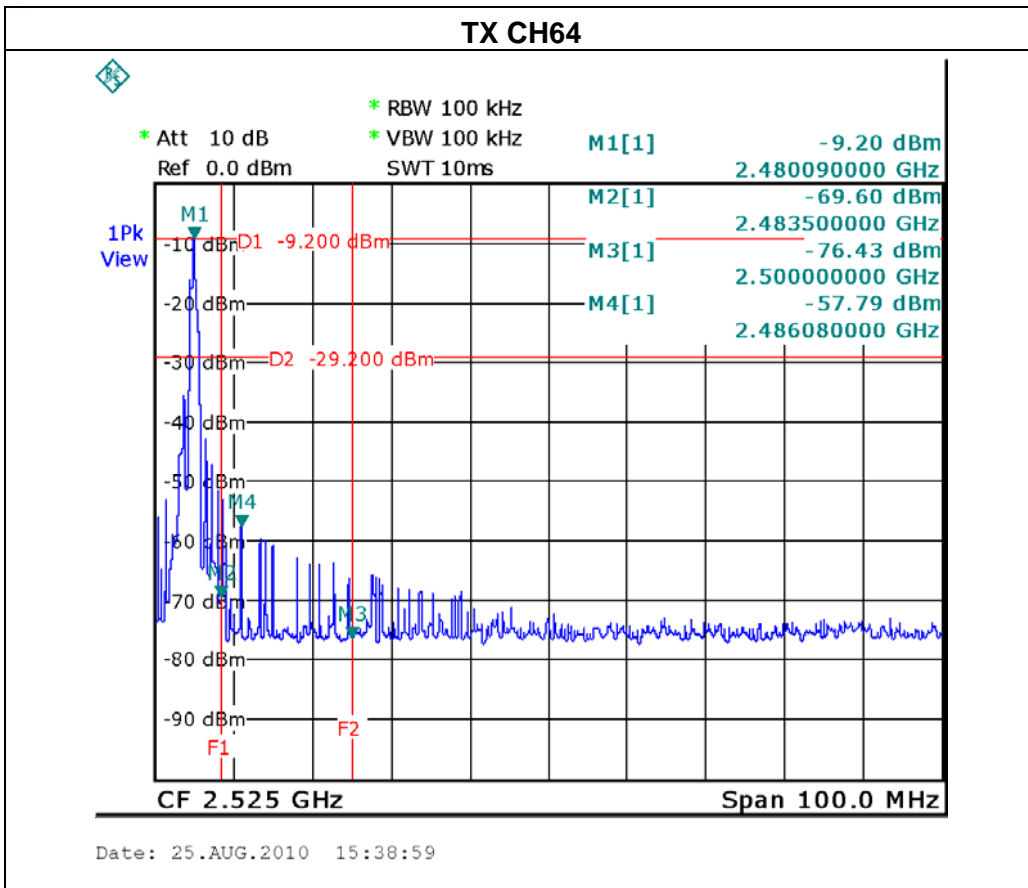



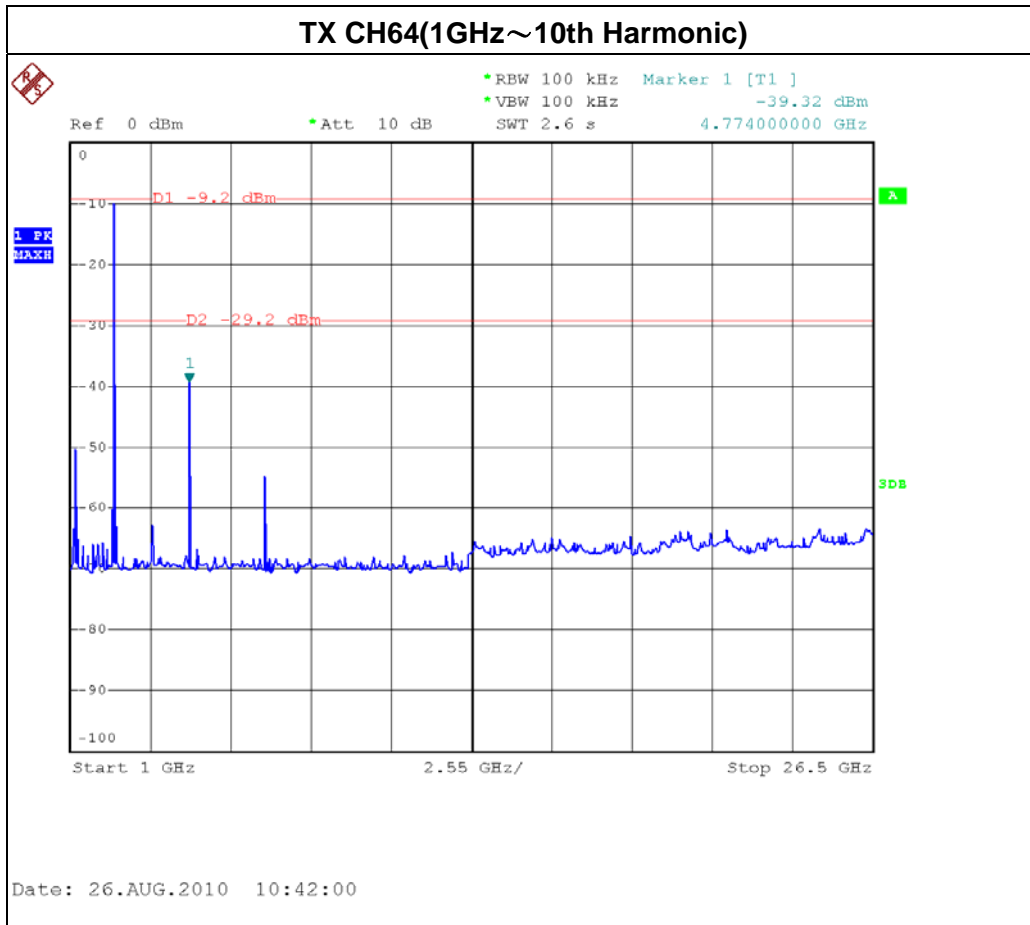



**11. EUT TEST PHOTO**

**Conducted Measurement Photos**

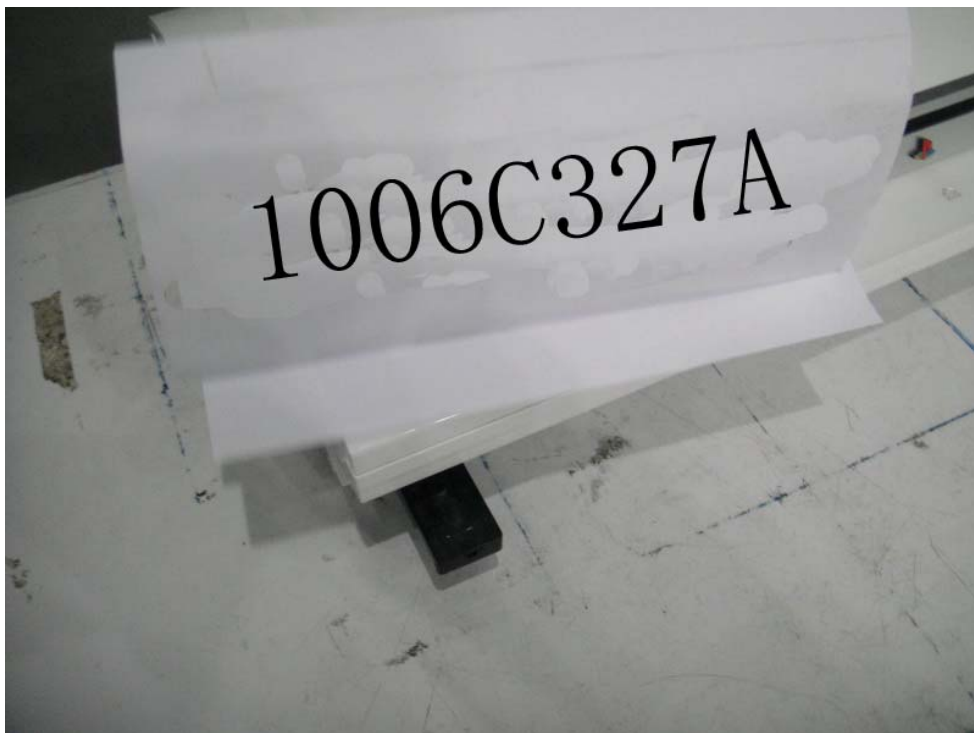



Radiated Measurement Photos

