

FCC &ISED Radio Test Report

FCC ID: X5B-500238
IC: 8814A-500238

The report concerns: Original Grant

Report Reference No.....: 23EFSS04011 02481

Date Sample(s) Received.....: 2023-04-11

Date of Tested.....: From 2023-04-11 to 2023-04-25

Date of issue.....: 2023-04-25

Testing Laboratory: DongGuanShuoXin Electronic Technology Co., Ltd.
Zone A, 1F, No. 6, XinGang Road YuanGang Street,
Address: XinAn District, ChangAn Town, DongGuan City,
GuangDong, China

Applicant's name: PERFORMANCE DESIGNED PRODUCTS, LLC
Address for: 14144 Ventura Blvd, Suite 200 Sherman. Oaks CA
91423 United States Of America

Manufacturer.....: PERFORMANCE DESIGNED PRODUCTS, LLC

Equipment.....: AFTERGLOW WAVE WIRELESS CONTROLLER
FOR Nintendo Switch

Trade Mark: /

Model: 500-238

Ratings: I/P: DC 5V Charged
DC 3.7V Li-ion Battery

Test Engineer:

Blue Qiu

Responsible Engineer :

Smile Wang

Authorized Signatory:

King Wang

Table of Contents	Page
1. TEST REPORT DECLARE	5
2. SUMMARY OF TEST RESULTS	6
2.1. MEASUREMENT UNCERTAINTY	7
3. GENERAL INFORMATION	8
3.1. GENERAL DESCRIPTION OF EUT	8
3.2. DESCRIPTION OF TEST MODES	10
3.3. PARAMETERS OF TEST SOFTWARE	11
3.4. BLOCKDIAGRAMSHOWINGTHECONFIGURATIONOFSYSTEMTESTED	11
3.5. SUPPORT UNITS	11
3.6. TEST ENVIRONMENT CONDITIONS	12
4. AC POWER LINE CONDUCTED EMISSIONS TEST	13
4.1. LIMIT	13
4.2. TEST PROCEDURE	13
4.3. MEASUREMENT INSTRUMENTS LIST	13
4.4. TESTSETUP	14
4.5. EUT OPERATING CONDITIONS	14
4.6. TEST RESULTS	15
5. RADIATED EMISSION TEST	17
5.1. LIMIT	17
5.2. TEST PROCEDURE AND SETTING	18
5.3. MEASUREMENT INSTRUMENTS LIST	19
5.4. TESTSETUP	19
5.5. EUT OPERATING CONDITIONS	20
5.6. TEST RESULTS - 9 KHZ TO 30MHZ	21
5.7. TEST RESULTS- 30 MHZ TO 1000MHZ	22
5.8. TEST RESULTS - ABOVE 1000MHZ(BAND EDGE)	24
5.9. TEST RESULTS - ABOVE 1000MHZ(HARMONIC)	32
6. NUMBER OF HOPPING FREQUENCY	44
6.1. LIMIT	44
6.2. TEST PROCEDURE AND SETTING	44
6.3. MEASUREMENT INSTRUMENTS LIST	44
6.4. TEST SETUP	44

Table of Contents	Page
6.5. EUT OPERATION CONDITIONS	44
6.6. TEST RESULTS	45
7. AVERAGE TIME OF OCCUPANCY	46
7.1. LIMIT	46
7.2. TEST PROCEDURE AND SETTING	46
7.3. MEASUREMENT INSTRUMENTS LIST	46
7.4. TEST SETUP	46
7.5. EUT OPERATION CONDITIONS	46
7.6. TEST RESULTS	47
8. HOPPING CHANNEL SEPARATION MEASUREMENT	49
8.1. LIMIT	49
8.2. TEST PROCEDURE AND SETTING	49
8.3. MEASUREMENT INSTRUMENTS LIST	49
8.4. TEST SETUP	49
8.5. EUT OPERATION CONDITIONS	49
8.6. TEST RESULTS	50
9. BANDWIDTH TEST	52
9.1. LIMIT	52
9.2. TEST PROCEDURE AND SETTING	52
9.3. MEASUREMENT INSTRUMENTS LIST	52
9.4. TEST SETUP	52
9.5. EUT OPERATION CONDITIONS	52
9.6. TEST RESULTS	53
10. MAXIMUM OUTPUT POWER	55
10.1. LIMIT	55
10.2. TEST PROCEDURE AND SETTING	55
10.3. MEASUREMENT INSTRUMENTS LIST	55
10.4. TEST SETUP	55
10.5. EUT OPERATION CONDITIONS	55
10.6. TEST RESULTS	56
11. CONDUCTED SPURIOUS EMISSION	59
11.1. LIMIT	59
11.2. TEST PROCEDURE AND SETTING	59
11.3. MEASUREMENT INSTRUMENTS LIST	59

Table of Contents	Page
11.4. TEST SETUP	59
11.5. EUT OPERATION CONDITIONS	59
11.6. TEST RESULTS	60
12. FREQUENCY STABILITY MEASUREMENT	62
12.1. LIMIT	62
12.2. TEST PROCEDURE	62
12.3. MEASUREMENT INSTRUMENTS LIST	62
12.4. TEST SETUP	62
12.5. EUT OPERATION CONDITIONS	62
12.6. TEST RESULTS	63

1TEST REPORT DECLARE

Applicant for FCC	PERFORMANCE DESIGNED PRODUCTS, LLC
Address for FCC	14144 Ventura Blvd, Suite 200 Sherman. Oaks CA 91423 United States Of America
Manufacturer	PERFORMANCE DESIGNED PRODUCTS, LLC
Address	14144 Ventura Blvd, Suite 200 Sherman. Oaks CA 91423 United States Of America
Factory	PERFORMANCE DESIGNED PRODUCTS, LLC
Address	14144 Ventura Blvd, Suite 200 Sherman. Oaks CA 91423 United States Of America
Equipment	AFTERGLOW WAVE WIRELESS CONTROLLER FOR Nintendo Switch
Model No.	500-238
Trade Mark	/
Standard	FCC Part15, Subpart C (15.247) RSS-247 Issue 2, Feb. 2017 RSS-Gen Issue 5, Apr. 2018 ANSI C63.10-2013

We Declare:

The equipment described above is tested by DongGuanShuoXin Electronic Technology Co., Ltd(ATT). and in the configuration tested the equipment complied with the standards specified above. The test results are contained in this test report and DongGuanShuoXin Electronic Technology Co., Ltd.(ATT) is assumed of full responsibility for the accuracy and completeness of these tests.

ATT is not responsible for the sampling stage, so the results only apply to the sample as received.

ATT's reports apply only to the specific samples tested under conditions. It is manufacture's responsibility to ensure that additional production units of this model are manufactured with the identical electrical and mechanical components. ATT shall have no liability for any declarations, inferences or generalizations drawn by the client or others from ATT issued reports.

2SUMMARY OF TEST RESULTS

The EUT have been tested according to the applicable standards as referenced below:

Standard(s) Section		Test Item	Judgment	Remark
FCC	ISED			
15.207	RSS-Gen8.8	AC Power Line Conducted Emissions	PASS	-----
15.247(d) 15.205(a) 15.209(a)	RSS-247 5.5 RSS-Gen 8.9 RSS-Gen 8.10	Radiated Emission	PASS	-----
15.247(a)(1)(iii)	RSS-247 5.1 (d)	Number of Hopping Frequency	PASS	-----
15.247(a)(1)(iii)	RSS-247 5.1 (d)	Average Time Of Occupancy	PASS	-----
15.247(a)(1)	RSS-247 5.1 (b)	Hopping Channel Separation	PASS	-----
15.247(a)(1)	RSS-247 5.1 (a) RSS-Gen 6.7	Bandwidth	PASS	-----
15.247(a)(1)	RSS-247 5.1 (b)	Maximum Output Power	PASS	-----
15.247(d)	RSS-247 5.5	Conducted Spurious Emission	PASS	-----
-	RSS-Gen6.11	Frequency Stability	PASS	-----
15.203	-	Antenna Requirement	PASS	Note(2)

Note:

- (1) "N/A" denotes test is not applicable in this test report
- (2) The device what use a permanently attached antenna were considered sufficient to comply with the provisions of 15.203.

2.1 MEASUREMENT UNCERTAINTY

Test Item	Uncertainty
Uncertainty for Conduction emission test (9kHz-150kHz)	3.7 dB
Uncertainty for Conduction emission test (150kHz-30MHz)	3.3 dB
Uncertainty for Radiation Emission test (30MHz-200MHz)	4.60 dB (Polarize: V)
	4.60 dB (Polarize: H)
Uncertainty for Radiation Emission test (200MHz-1GHz)	6.10 dB (Polarize: V)
	5.08 dB (Polarize: H)
Uncertainty for Radiation Emission test (1GHz-6GHz)	5.01 dB (Polarize: V)
	5.01 dB (Polarize: H)
Uncertainty for Radiation Emission test (6GHz-18GHz)	5.26 dB (Polarize: V)
	5.26 dB (Polarize: H)
Uncertainty for Radiation Emission test (18GHz-40GHz)	5.06 dB (Polarize: V)
	5.06 dB (Polarize: H)
Uncertainty for radio frequency	±0.048kHz
Uncertainty for conducted RF Power	±0.32dB

Note:

This uncertainty represents an expanded uncertainty expressed at approximately the 95% confidence level using a coverage factor of k=2.

Test Facility:

The Test site used by DongGuanShuoXin Electronic Technology Co., Ltd. to collect test data is located on the Zone A, 1F, No. 6, XinGang Road YuanGang Street, XinAn District, ChangAn Town, DongGuan City, GuangDong, China

The test facility is recognized, certified, or accredited by the following organizations:

Item	Registration No.	Expiration Date
CNAS	L3098	2024-08-27
A2LA	4893.01	2024-06-30
Innovation, Science and Economic Development Canada (ISED)	11033A CAB identifier:CN0083	2024-06-30
Federal Communications Commission (FCC)	171688 Designation No.:CN1235	2024-06-30

3 GENERAL INFORMATION

3.1 GENERAL DESCRIPTION OF EUT

Equipment	AFTERGLOW WAVE WIRELESS CONTROLLER FOR Nintendo Switch	
Brand Name	/	
Test Model	500-238	
Series Model	N/A	
Model Difference(s)	N/A	
Hardware Version	1.0	
Software Version	1.0	
Power Source	Battery	
Power Rating	DC 5V Charger DC 3.7V Li-ion Battery	
Operation Frequency	2402 MHz ~ 2480 MHz	
Modulation Technology	GFSK, $\pi/4$ -DQPSK, 8-DPSK	
Bit Rate of Transmitter	1Mbps /2Mbps /3Mbps	
Antenna Information	Antenna Type: PCB	Maximum Peak Gain:1.63dBi
Max. Output Power	1Mbps: 0.640dBm (0.00116W) 2Mbps: 2.666dBm (0.00185W) 3Mbps: 3.073dBm (0.00203W)	

Note:

1. For a more detailed features description, please refer to the manufacturer’s specifications or the user’s manual.

2. Channel List:

Channel	Frequency (MHz)	Channel	Frequency (MHz)	Channel	Frequency (MHz)
00	2402	27	2429	54	2456
01	2403	28	2430	55	2457
02	2404	29	2431	56	2458
03	2405	30	2432	57	2459
04	2406	31	2433	58	2460
05	2407	32	2434	59	2461
06	2408	33	2435	60	2462
07	2409	34	2436	61	2463
08	2410	35	2437	62	2464
09	2411	36	2438	63	2465
10	2412	37	2439	64	2466
11	2413	38	2440	65	2467
12	2414	39	2441	66	2468
13	2415	40	2442	67	2469
14	2416	41	2443	68	2470
15	2417	42	2444	69	2471
16	2418	43	2445	70	2472
17	2419	44	2446	71	2473
18	2420	45	2447	72	2474
19	2421	46	2448	73	2475
20	2422	47	2449	74	2476
21	2423	48	2450	75	2477
22	2424	49	2451	76	2478
23	2425	50	2452	77	2479
24	2426	51	2453	78	2480
25	2427	52	2454		
26	2428	53	2455		

3.2 DESCRIPTION OF TEST MODES

The test system was pre-tested based on the consideration of all possible combinations of EUT operation mode.

Prestest Mode	Description
Mode 1	TX Mode NOTE (1)
Mode 2	TX Mode Channel 01_3Mbps

Following mode(s) was (were) found to be the worst case(s) and selected for the final test.

AC power line conducted emissions test	
Final Test Mode	Description
Mode 2	TX Mode Channel 01_3Mbps

Radiated emissions test - Below 1GHz	
Final Test Mode	Description
Mode 2	TX Mode Channel 01_3Mbps

Radiated emissions test - Above 1GHz	
Final Test Mode	Description
Mode 1	TX Mode NOTE (1)

Conducted test	
Final Test Mode	Description
Mode 1	TX Mode NOTE (1)

Note:

- (1) The measurements are performed at the high, middle, low available channels.
- (2) The measurements for Hopping Channel Separation, Bandwidth and Maximum Output Power were tested during 1Mbps, 2Mbps and 3Mbps, the worst case are 1Mbps and 3Mbps, only worst case was documented.

3.3PARAMETERS OF TEST SOFTWARE

During testing, channel & power controlling software provided by the customer was used to control the operating channel as well as the output power level. The RF output power selection is for the setting of RF output power expected by the customer and is going to be fixed on the firmware of the final end product power parameters of FHSS

Test Software	N/A		
Frequency (MHz)	2402	2441	2480
Parameters(1Mbps)	Default	Default	Default
Parameters(3Mbps)	Default	Default	Default

3.4BLOCKDIAGRAMSHOWINGTHECONFIGURATIONOFSYSTEMTESTED

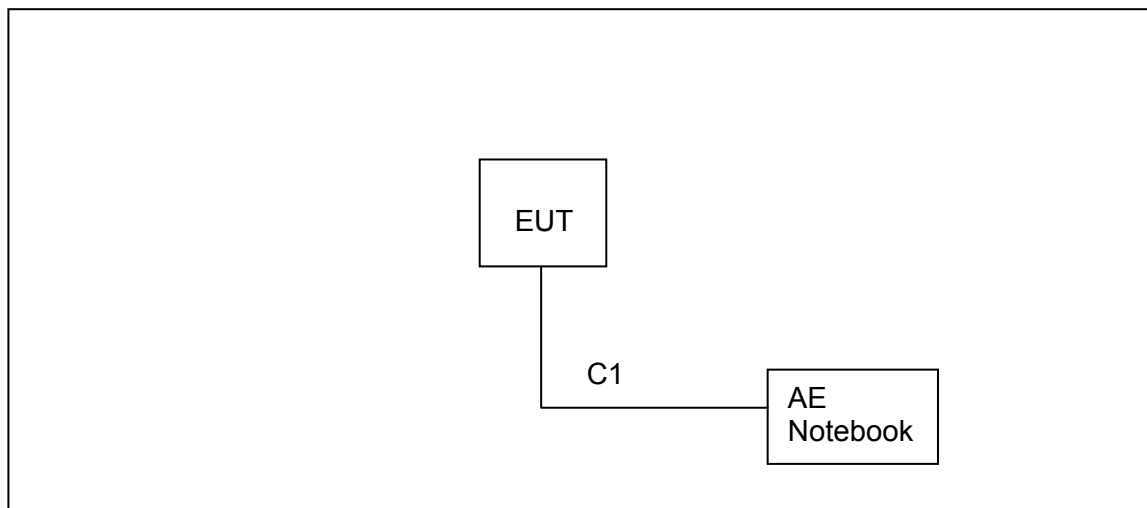

3.5SUPPORT UNITS

Item	Equipment	Brand	Model No.	Series No.
AE	Notebook	Lenovo	/	/

Item	Cable Type	Shielded Type	Ferrite Core	Length
C1	DC Cable	NO	NO	0.8m

3.6 TEST ENVIRONMENT CONDITIONS

Test Item	Temperature	Humidity	Test Voltage
AC Power Line Conducted Emissions	25°C	53%	DC 5V
Radiated Emissions-9K-30MHz	25°C	60%	DC 5V
Radiated Emissions-30 MHz to 1GHz	24°C	68%	DC 5V
Radiated Emissions-Above 1000 MHz	24°C	68%	DC 5V
Number of Hopping Frequency	24.8°C	40.9%	DC 5V
Average Time Of Occupancy	24.8°C	40.9%	DC 5V
Hopping Channel Separation	24.8°C	40.9%	DC 5V
Bandwidth	24.8°C	40.9%	DC 5V
Maximum Output Power	24.8°C	40.9%	DC 5V
Conducted Spurious Emission	24.8°C	40.9%	DC 5V

4AC POWER LINE CONDUCTED EMISSIONS TEST

4.1LIMIT

Frequency of Emission (MHz)	Limit (dBµV)	
	Quasi-peak	Average
0.15 - 0.50	66 to 56*	56 to 46*
0.50 - 5.0	56	46
5.0 - 30.0	60	50

Note:

- (1) The tighter limit applies at the band edges.
- (2) The limit of " * " marked band means the limitation decreases linearly with the logarithm of the frequency in the range.

The following table is the setting of the receiver

Receiver Parameters	Setting
Attenuation	10 dB
Start Frequency	0.15 MHz
Stop Frequency	30 MHz
IF Bandwidth	9 kHz

4.2TEST PROCEDURE

- a. The EUT was placed 0.8 meters from the horizontal ground plane with EUT being connected to the power mains through a line impedance stabilization network (LISN). All other support equipment powered from additional LISN(s). The LISN provide 50 Ohm/ 50uH of coupling impedance for the measuring instrument.
- b. Interconnecting cables that hang closer than 40 cm to the ground plane shall be folded back and forth in the center forming a bundle 30 to 40 cm long.
- c. I/O cables that are not connected to a peripheral shall be bundled in the center. The end of the cable may be terminated, if required, using the correct terminating impedance. The overall length shall not exceed 1 m.
- d. LISN at least 80 cm from nearest part of EUT chassis.

4.3MEASUREMENT INSTRUMENTS LIST

Item	Kind of Equipment	Manufacturer	Type No.	Serial No.	Calibrated until
1	Pulse Limiter	MTS-systemtechnik	MTS-IMP-136	261115-010-0024	12/11/2023
2	EMI Test Receiver	R&S	ESCI	101308	12/12/2023
3	LISN	AFJ	LS16	16011103219	05/26/2023
4	LISN	Schwarzbeck	NSLK 8127	8127-432	12/11/2023
5	Measurement Software	Farad	EZ-EMC (Ver.ATT-03A)	N/A	N/A

4.4 TEST SETUP

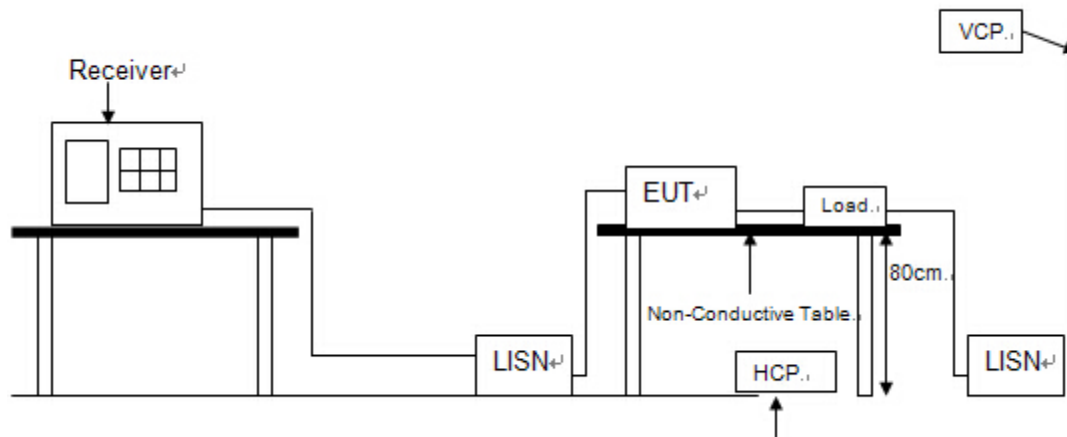

4.5 EUT OPERATING CONDITIONS

The EUT was configured for testing in a typical function (as a customer would normally use it), EUT was programmed to be in continuously transmitting data or hopping on mode.

4.6 TEST RESULTS

Test Mode: TX Mode Channel 01 _3Mbps

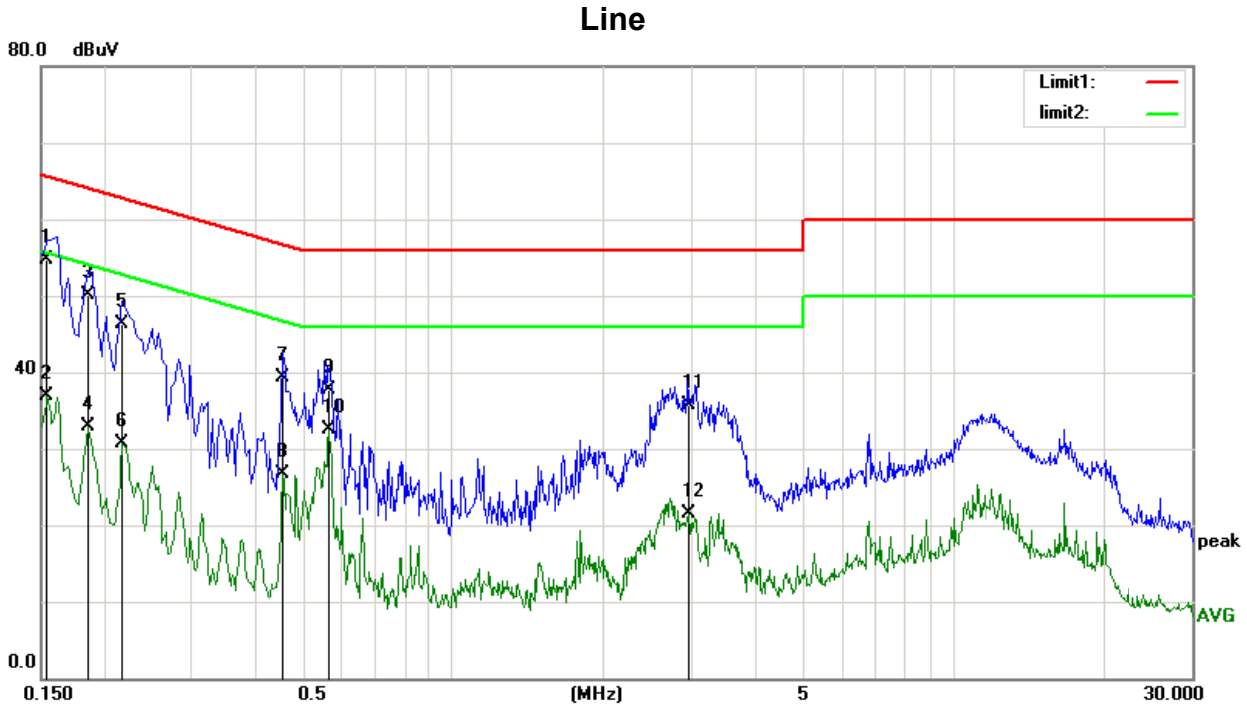

No.	Frequency (MHz)	Reading (dBuV)	Correct Factor(dB)	Result (dBuV)	Limit (dBuV)	Margin (dB)	Remark
1	0.1539	43.30	11.50	54.80	65.78	-10.98	QP
2	0.1539	25.48	11.50	36.98	55.78	-18.80	AVG
3	0.1860	38.91	11.29	50.20	64.21	-14.01	QP
4	0.1860	21.56	11.29	32.85	54.21	-21.36	AVG
5	0.2180	35.29	11.07	46.36	62.89	-16.53	QP
6	0.2180	19.56	11.07	30.63	52.89	-22.26	AVG
7	0.4580	29.02	10.32	39.34	56.73	-17.39	QP
8	0.4580	16.33	10.32	26.65	46.73	-20.08	AVG
9	0.5660	27.53	10.25	37.78	56.00	-18.22	QP
10	0.5660	22.19	10.25	32.44	46.00	-13.56	AVG
11	2.9500	25.43	10.20	35.63	56.00	-20.37	QP
12	2.9500	11.32	10.20	21.52	46.00	-24.48	AVG

Remarks:

- (1) Measurement Value = Reading Level + Correct Factor.
- (2) Margin Level = Measurement Value - Limit Value.

Test Mode: TX Mode Channel 01 _3Mbps

Neutral

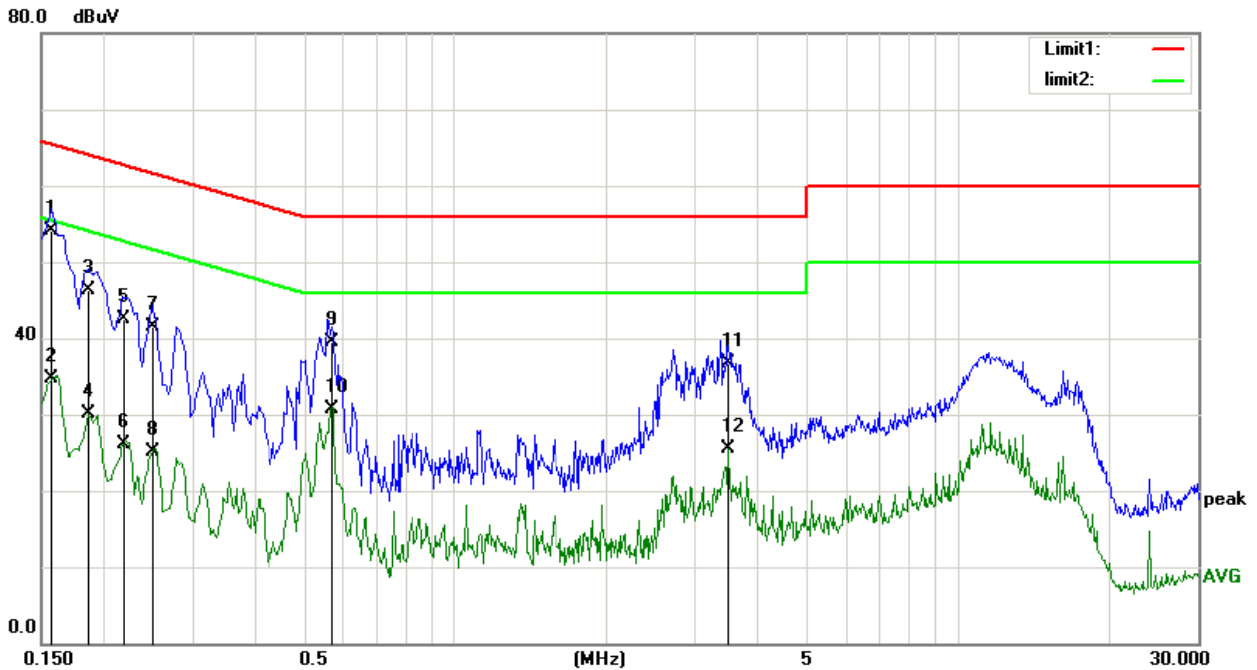

No.	Frequency (MHz)	Reading (dBuV)	Correct Factor(dB)	Result (dBuV)	Limit (dBuV)	Margin (dB)	Remark
1	0.1580	42.57	11.47	54.04	65.56	-11.52	QP
2	0.1580	23.28	11.47	34.75	55.56	-20.81	AVG
3	0.1860	35.11	11.29	46.40	64.21	-17.81	QP
4	0.1860	18.83	11.29	30.12	54.21	-24.09	AVG
5	0.2184	31.37	11.07	42.44	62.88	-20.44	QP
6	0.2184	15.11	11.07	26.18	52.88	-26.70	AVG
7	0.2500	30.69	10.85	41.54	61.75	-20.21	QP
8	0.2500	14.16	10.85	25.01	51.75	-26.74	AVG
9	0.5660	29.28	10.25	39.53	56.00	-16.47	QP
10	0.5660	20.36	10.25	30.61	46.00	-15.39	AVG
11	3.4980	26.42	10.21	36.63	56.00	-19.37	QP
12	3.4980	15.33	10.21	25.54	46.00	-20.46	AVG

Remarks:

(1) Measurement Value = Reading Level + Correct Factor.

(2) Margin Level = Measurement Value - Limit Value.

5 RADIATED EMISSION TEST

5.1 LIMIT

In case the emission fall within the restricted band specified on 15.205(a) & RSS-Gen 8.10, then the 15.209(a) & RSS-Gen 8.9 limit in the table below has to be followed.

LIMITS OF RADIATED EMISSION MEASUREMENT (9 kHz-1000MHz)

Frequency (MHz)	Field Strength (microvolts/meter)	Measurement Distance (meters)
0.009-0.490	2400/F(kHz)	300
0.490-1.705	24000/F(kHz)	30
1.705-30.0	30	30
30-88	100	3
88-216	150	3
216-960	200	3
Above 960	500	3

LIMITS OF RADIATED EMISSION MEASUREMENT (9 kHz-30 MHz)

Frequency (MHz)	Magnetic field strength (H-Field) ($\mu\text{A/m}$)	Measurement Distance (meters)
0.009-0.490	6.37/F(kHz)	300
0.490-1.705	6.37/F(kHz)	30
1.705-30.0	0.08	30

LIMITS OF RADIATED EMISSION MEASUREMENT (30 MHz-1000MHz)

Frequency (MHz)	Field Strength ($\mu\text{V/m}$ at 3m)
30-88	100
88-216	150
216-960	200
Above 960	500

LIMITS OF RADIATED EMISSION MEASUREMENT (Above 1000MHz)

Frequency (MHz)	(dBuV/m at 3 m)	
	Peak	Average
Above 1000	74	54

Note:

- (1) The limit for radiated test was performed according to FCC PART 15C and RSS-247.
- (2) The tighter limit applies at the band edges.
- (3) Emission level (dBuV/m) = $20 \log$ Emission level ($\mu\text{V/m}$).

5.2 TEST PROCEDURE AND SETTING

- a. The measuring distance of 3 m shall be used for measurements. The EUT was placed on the top of a rotating table 0.8 meter above the ground at a 3 meter semi-anechoic chamber. The table was rotated 360 degrees to determine the position of the highest radiation.(below 1GHz)
- b. The measuring distance of 3 m shall be used for measurements. The EUT was placed on the top of a rotating table 1.5 meter above the ground at a 3 meter semi-anechoic chamber. The table was rotated 360 degrees to determine the position of the highest radiation.(above 1GHz)
- c. The height of the equipment or of the substitution antenna shall be 0.8m or 1.5m; the height of the test antenna shall vary between 1 m to 4 m. Both horizontal and vertical polarizations of the antenna are set to make the measurement.
- d. For each suspected emission, the EUT was arranged to its worst case and then the antenna was tuned to heights find the maximum reading (used Bore sight function).
- e. The receiver system was set to peak and average detect function and specified bandwidth with maximum hold mode when the test frequency is above 1GHz.
- f. The initial step in collecting radiated emission data is a receiver peak detector mode pre-scanning the measurement frequency range. Significant peaks are then marked and then Quasi Peak detector mode re-measured.
- g. All readings are Peak unless otherwise stated QP in column of Note. Peak denotes that the Peak reading compliance with the QP Limits and then QP Mode measurement didn't perform. (below 1GHz)
- h. All readings are Peak Mode value unless otherwise stated AVG in column of Note. If the Peak Mode Measured value compliance with the Peak Limits and lower than AVG Limits, the EUT shall be deemed to meet both Peak & AVG Limits and then only Peak Mode was measured, but AVG Mode didn't perform. (above 1GHz)
- i. The test result is calculated as the following:
 - (1) Result = Reading + Correct Factor
 - (2) Correct Factor = Antenna Factor + Cable Loss – Amplifier Gain + Attenuator
 - (3) Margin = Result - Limit

Spectrum Parameter	Setting
Attenuation	Auto
Start Frequency	1000 MHz
Stop Frequency	10th carrier harmonic
RBW / VBW (Emission in restricted band)	RBW 1MHz VBW 3MHz peak detector for Pk value RMS detector for AV value

Receiver Parameter	Setting
Attenuation	Auto
Start ~ Stop Frequency	9 kHz~90 kHz for PK/AVG detector
Start ~ Stop Frequency	90 kHz~110 kHz for QP detector
Start ~ Stop Frequency	110 kHz~490 kHz for PK/AVG detector
Start ~ Stop Frequency	490 kHz~30 MHz for QP detector
Start ~ Stop Frequency	30MHz~1000MHz for QP detector

5.3 MEASUREMENT INSTRUMENTS LIST

Item	Equipment	Manufacturer	Model No.	Serial No.	Calibrated until
1	EMI Test Receiver	R&S	ESCI	101307	12/11/2023
2	Spectrum Analyzer	Agilent	E4407B	US40240708	11/10/2023
3	Loop antenna	SCHWARZBECK K	FMZB1519	1519-062	01/15/2024
4	Broadband antenna	SCHWARZBECK	VULB9168	VULB9168-192	07/04/2023
5	HORN ANTENNA	SCHWARZBECK	BBHA9120D	9120D 1065	04/09/2024
6	Preamplifier Amplifier	HP	8447F	3113A05680	12/19/2023
7	PRE-AMPLIFIER	EMEC	EM01G26G	980136	04/05/2024
8	RF Cable	R&S	Test Cable 4	4	12/11/2023
9	RF Cable	R&S	Test Cable 5	5	12/11/2023
10	RF Cable	R&S	Test Cable 9	9	04/09/2024
11	RF Cable	R&S	Test Cable 10	10	04/09/2024
12	Measurement Software	Farad	EZ-EMC (Ver.ATT-03A)	N/A	N/A

5.4 TEST SETUP

9 kHz-30 MHz

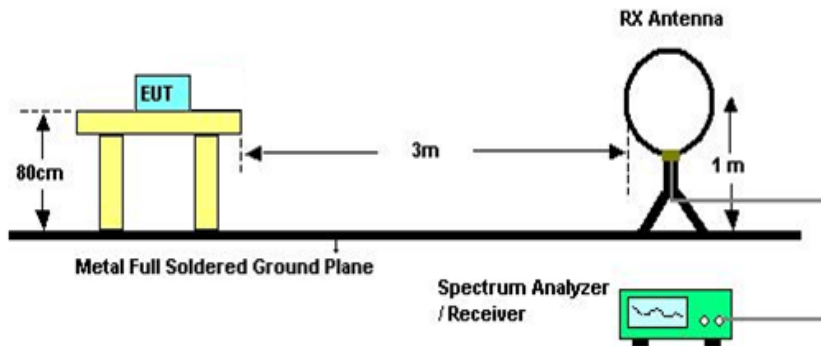

30 MHz to 1 GHz

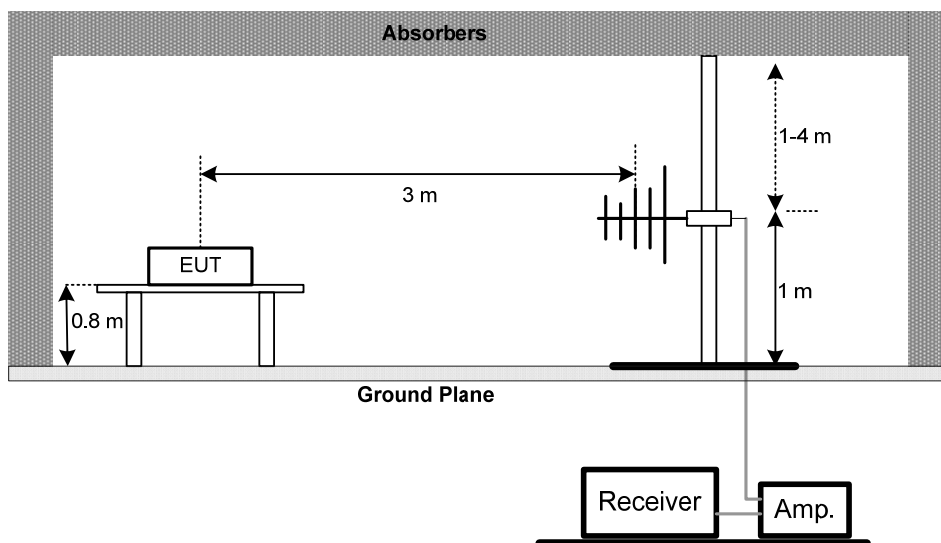

Above 1 GHz

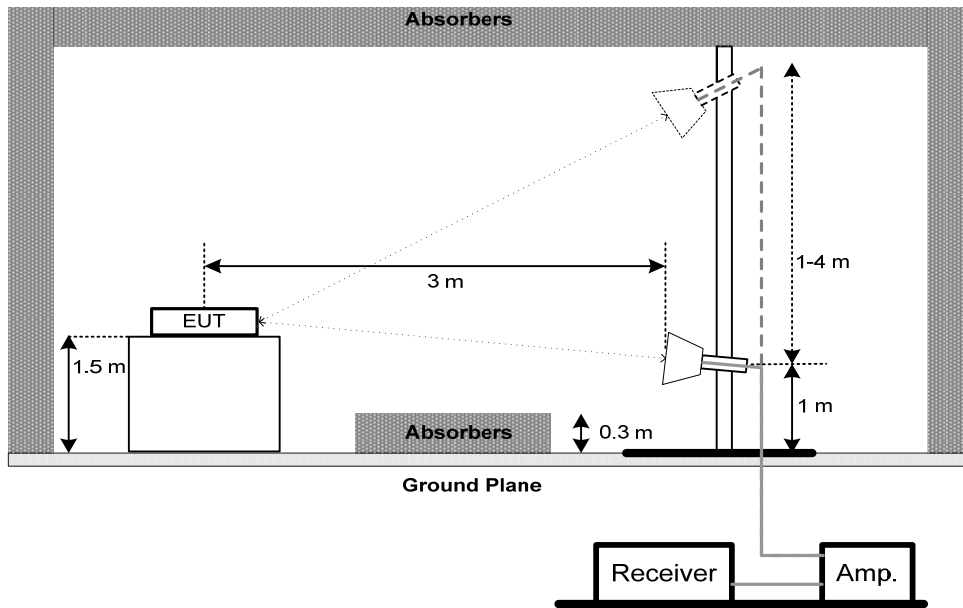

5.5 EUT OPERATING CONDITIONS

The EUT was programmed to be in continuously transmitting mode.

5.6 TEST RESULTS - 9 kHz TO 30MHz

Test Mode:	TX Mode Channel 01 _3Mbps
------------	---------------------------

Freq.	Reading	Limit	Margin	State
(MHz)	(dBuV/m)	(dBuV/m)	(dB)	P/F
--	--	--	--	P
--	--	--	--	P

Note:

The amplitude of spurious emissions which are attenuated by more than 20dB below the permissible value has no need to be reported.

Distance extrapolation factor = $20 \log (\text{specific distance}/\text{test distance})(\text{dB})$;

Limit line = specific limits(dBuv) + distance extrapolation factor

5.7 TEST RESULTS- 30 MHz TO 1000MHz

Test Mode: TX Mode Channel 01 _3Mbps

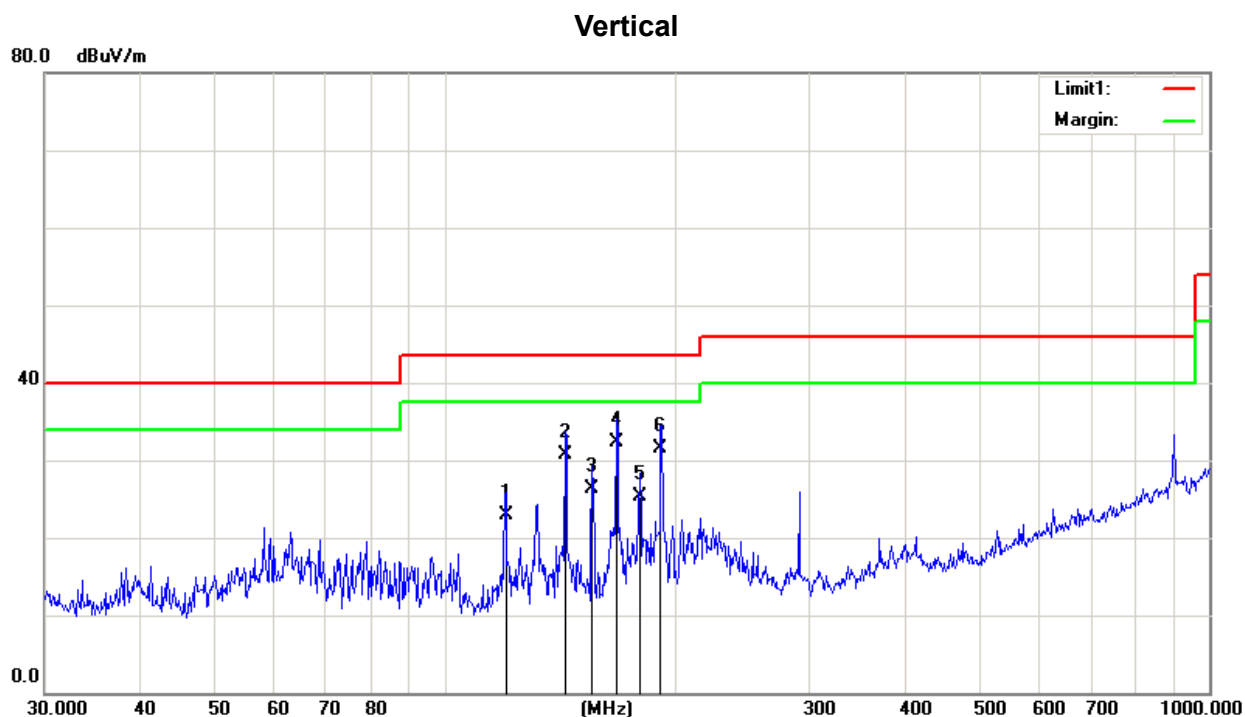

No.	Mk.	Freq.	Reading Level	Correct Factor	Measurement	Limit	Over	Antenna Height	Table Degree	
		MHz	dBuV	dB	dBuV/m	dB/m	dB	cm	degree	Comment
1		120.2766	37.31	-14.47	22.84	43.50	-20.66	300	39	
2		143.8292	44.93	-14.18	30.75	43.50	-12.75	100	46	
3		155.9098	40.26	-13.96	26.30	43.50	-17.20	200	69	
4	*	167.8240	44.77	-12.42	32.35	43.50	-11.15	200	255	
5		180.0165	38.85	-13.54	25.31	43.50	-18.19	100	298	
6		191.7450	45.22	-13.78	31.44	43.50	-12.06	100	311	

*:Maximum data x:Over limit !:over margin

(Reference Only)

Test Mode: TX Mode Channel 01 _3Mbps

Horizontal

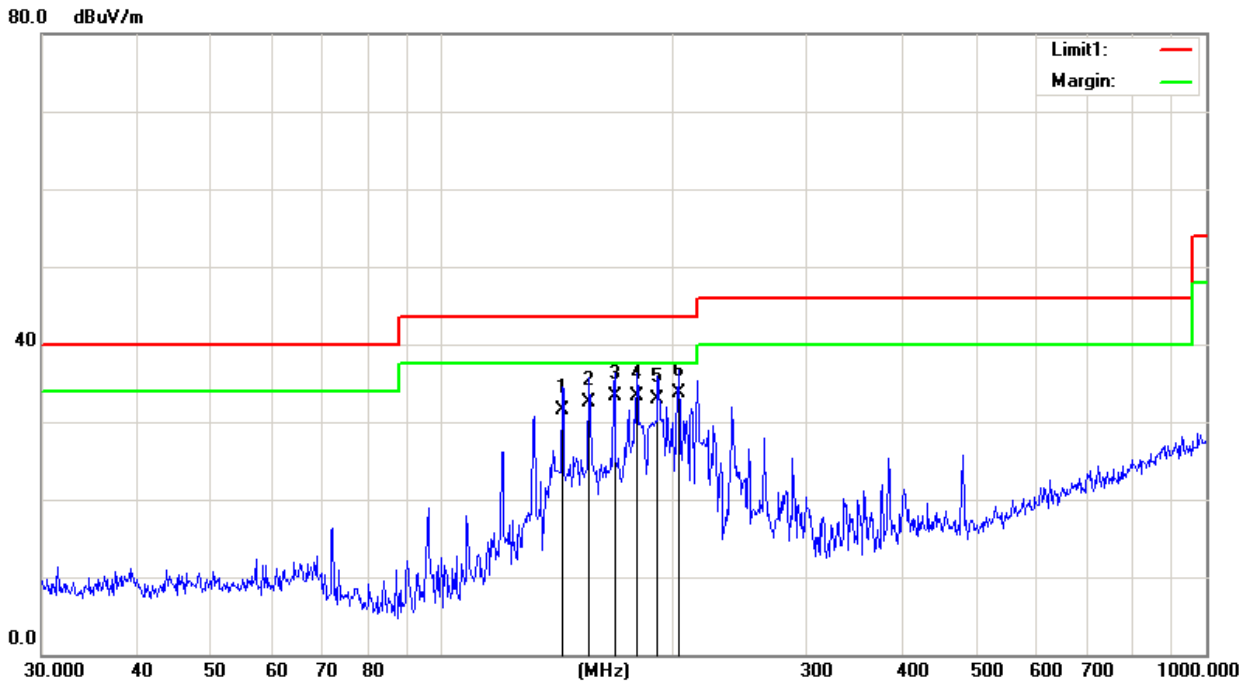

No.	Mk.	Freq. MHz	Reading Level dBuV	Correct Factor dB	Measure- ment dBuV/m	Limit dB/m	Over dB	Antenna Height cm	Table Degree degree	Comment
1		143.8293	46.41	-14.94	31.47	43.50	-12.03	QP	100	65
2		155.9099	46.71	-14.14	32.57	43.50	-10.93	QP	200	85
3		168.4138	45.97	-12.61	33.36	43.50	-10.14	QP	200	165
4		180.0165	44.89	-11.54	33.35	43.50	-10.15	QP	200	48
5		191.7450	44.60	-11.78	32.82	43.50	-10.68	QP	100	255
6	*	204.2377	45.08	-11.38	33.70	43.50	-9.80	QP	100	355

*:Maximum data x:Over limit !:over margin

(Reference Only)

5.8TEST RESULTS - ABOVE 1000MHz(BAND EDGE)

Test Mode: TX 2402 MHz_CH00_1Mbps

Vertical

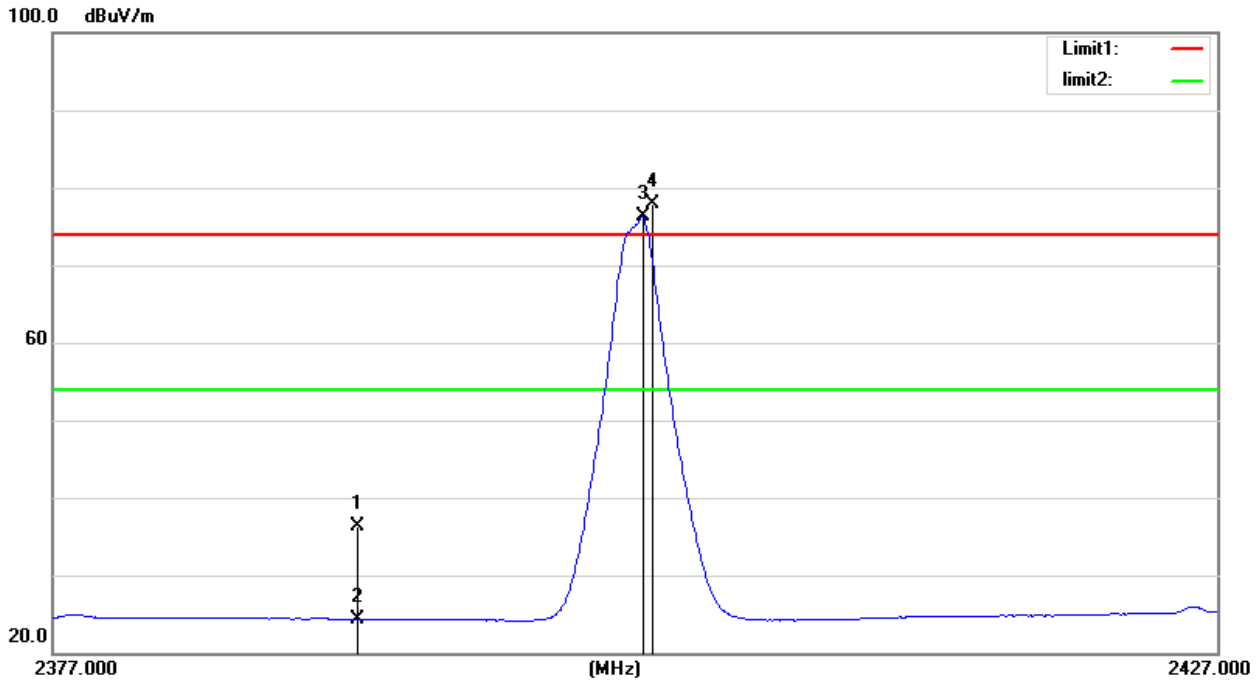

No.	Mk.	Freq.	Reading Level	Correct Factor	Measurement	Limit	Over	Antenna Height	Table Degree		
		MHz	dBuV	dB	dBuV/m	dB/m	dB	cm	degree	Comment	
1		2390.000	48.42	-12.03	36.39	74.00	-37.61	peak	150	342	
2		2390.000	36.33	-12.03	24.30	54.00	-29.70	AVG	150	342	
3	*	2402.250	88.38	-12.00	76.38	54.00	22.38	AVG	150	342	No Limit
4	X	2402.650	89.97	-11.99	77.98	74.00	3.98	peak	150	342	No Limit

*:Maximum data x:Over limit !:over margin

(Reference Only)

Test Mode: TX 2402 MHz_CH00_1Mbps

Horizontal

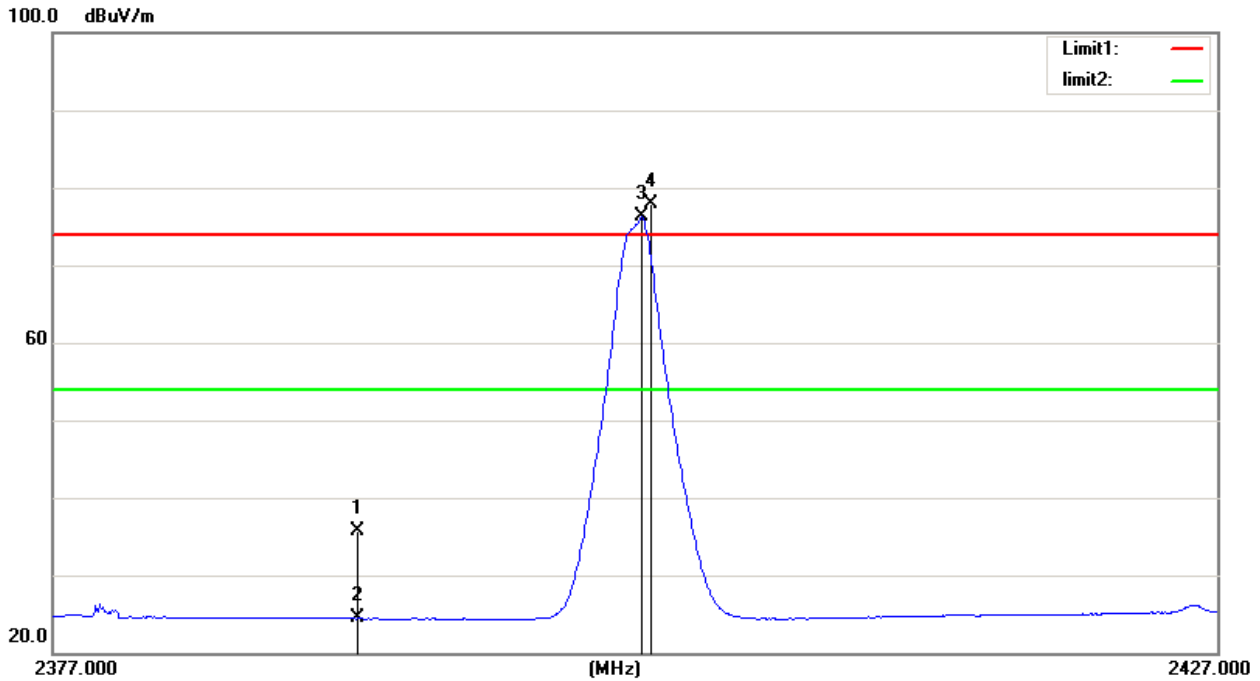

No.	Mk.	Freq.	Reading Level	Correct Factor	Measurement	Limit	Over	Antenna Height	Table Degree		
		MHz	dBuV	dB	dBuV/m	dB/m	dB	cm	degree	Comment	
1		2390.000	47.71	-12.03	35.68	74.00	-38.32	peak	150	296	
2		2390.000	36.44	-12.03	24.41	54.00	-29.59	AVG	150	296	
3	*	2402.200	88.23	-12.00	76.23	54.00	22.23	AVG	150	296	No Limit
4	X	2402.600	89.97	-11.99	77.98	74.00	3.98	peak	150	296	No Limit

*:Maximum data x:Over limit !:over margin

◁Reference Only

Test Mode: TX 2480 MHz_CH78_1Mbps

Vertical

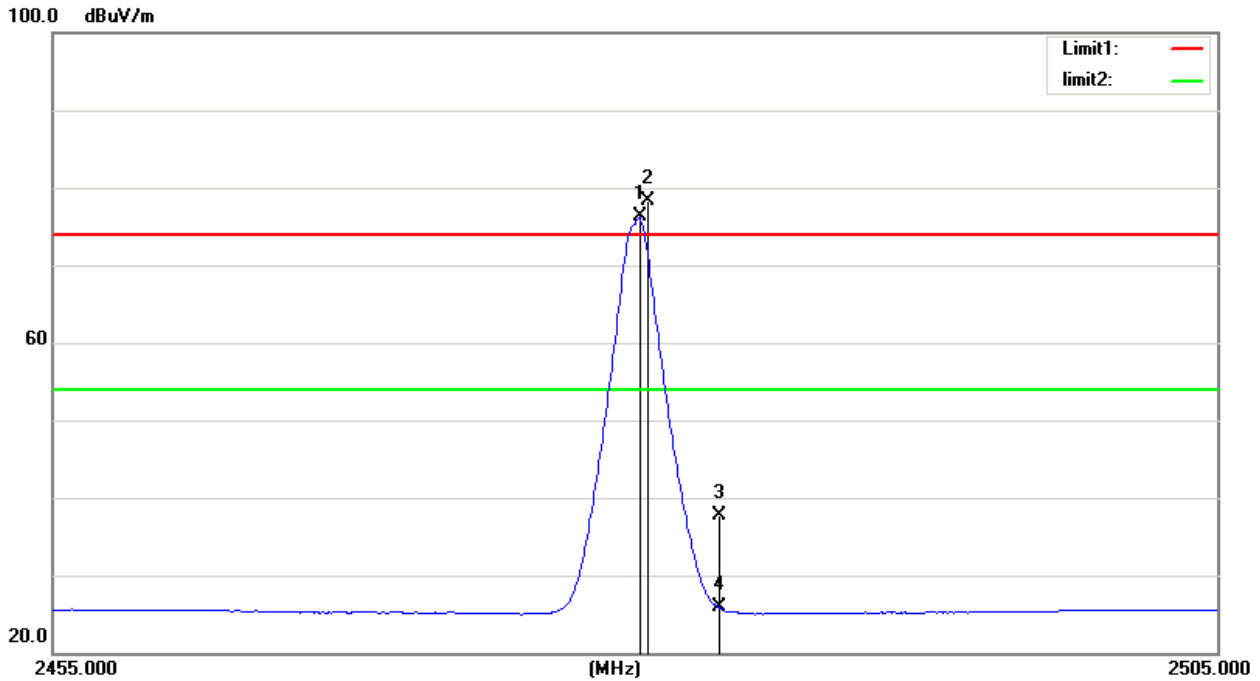

No.	Mk.	Freq.	Reading Level	Correct Factor	Measurement	Limit	Over	Antenna Height	Table Degree		
		MHz	dBuV	dB	dBuV/m	dB/m	dB	cm	degree	Comment	
1	*	2480.100	87.92	-11.71	76.21	54.00	22.21	AVG	150	349	No Limit
2	X	2480.450	89.97	-11.71	78.26	74.00	4.26	peak	150	349	No Limit
3		2483.500	49.40	-11.70	37.70	74.00	-36.30	peak	150	349	
4		2483.500	37.53	-11.70	25.83	54.00	-28.17	AVG	150	349	

*:Maximum data x:Over limit !:over margin

⟨Reference Only

Test Mode: TX 2480 MHz_CH78_1Mbps

Horizontal

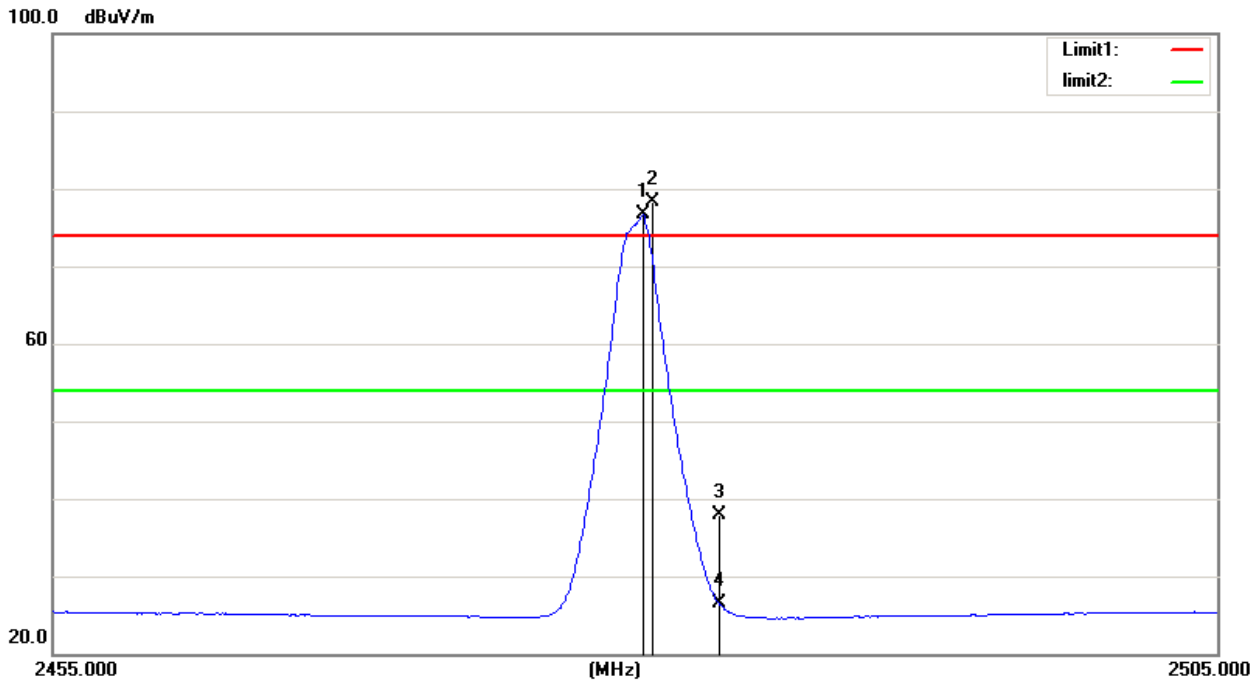

No.	Mk.	Freq.	Reading Level	Correct Factor	Measurement	Limit	Over	Antenna Height	Table Degree	Comment	
		MHz	dBuV	dB	dBuV/m	dB/m	dB	cm	degree		
1	*	2480.250	88.33	-11.71	76.62	54.00	22.62	AVG	150	309	No Limit
2	X	2480.650	89.97	-11.71	78.26	74.00	4.26	peak	150	309	No Limit
3		2483.500	49.57	-11.70	37.87	74.00	-36.13	peak	150	309	
4		2483.500	38.21	-11.70	26.51	54.00	-27.49	AVG	150	309	

*:Maximum data x:Over limit !:over margin

(Reference Only)

Test Mode: TX 2402 MHz_CH00_3Mbps

Vertical

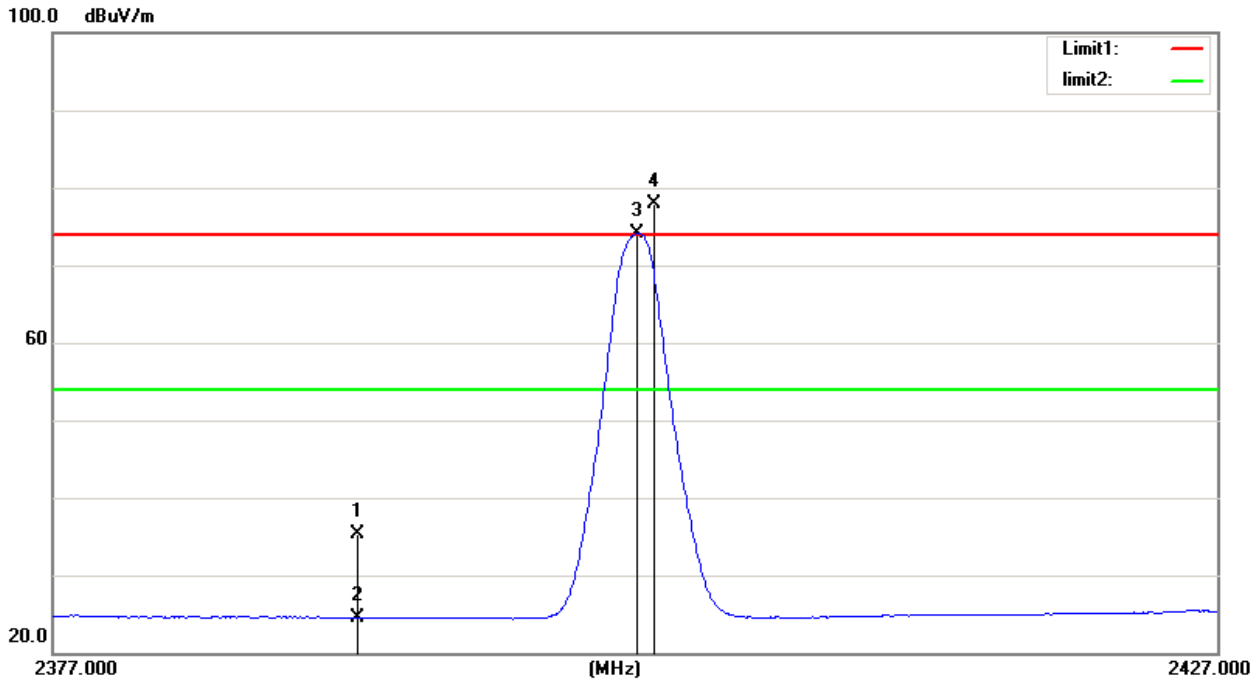

No.	Mk.	Freq.	Reading Level	Correct Factor	Measurement	Limit	Over	Antenna Height	Table Degree		
		MHz	dBuV	dB	dBuV/m	dB/m	dB	cm	degree	Comment	
1		2390.000	47.26	-12.03	35.23	74.00	-38.77	peak	150	359	
2		2390.000	36.54	-12.03	24.51	54.00	-29.49	AVG	150	359	
3	*	2402.000	86.19	-12.00	74.19	54.00	20.19	AVG	150	359	No Limit
4	X	2402.700	89.97	-11.99	77.98	74.00	3.98	peak	150	359	No Limit

*:Maximum data x:Over limit !:over margin

⟨Reference Only

Test Mode: TX 2402 MHz_CH00_3Mbps

Horizontal

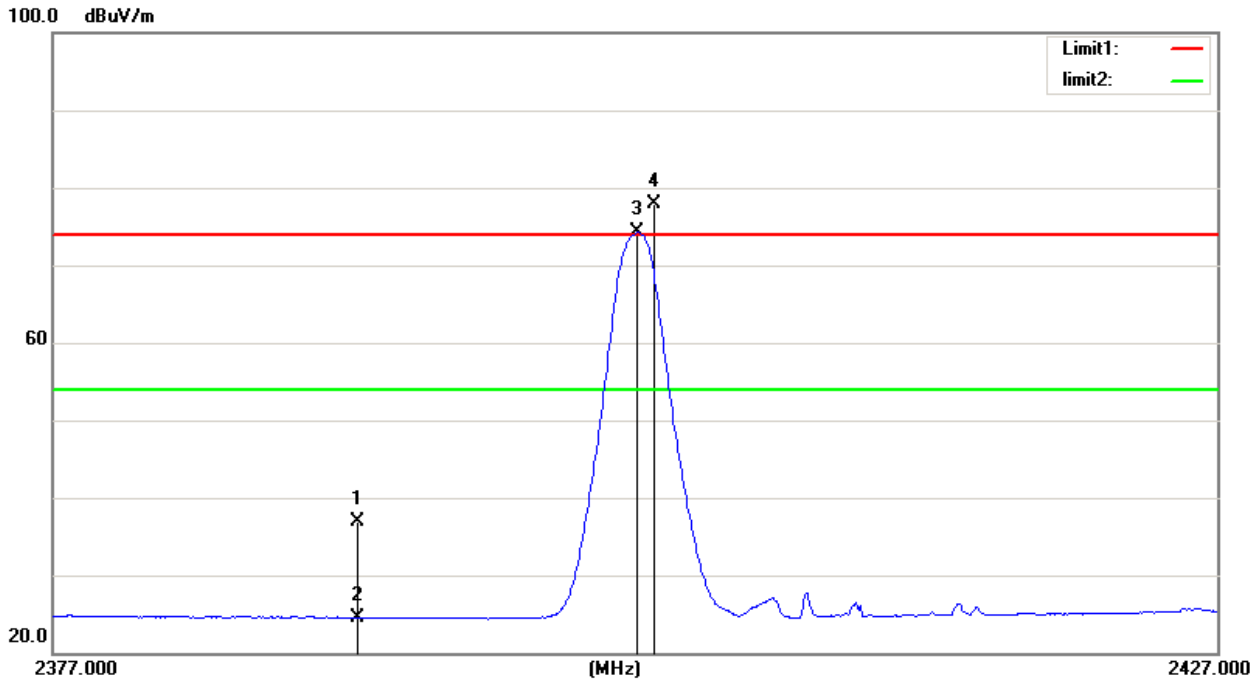

No.	Mk.	Freq.	Reading Level	Correct Factor	Measurement	Limit	Over	Antenna Height	Table Degree	
		MHz	dBuV	dB	dBuV/m	dB/m	dB	cm	degree	Comment
1		2390.000	48.92	-12.03	36.89	74.00	-37.11	peak	150	292
2		2390.000	36.55	-12.03	24.52	54.00	-29.48	AVG	150	292
3	*	2402.000	86.22	-12.00	74.22	54.00	20.22	AVG	150	292 No Limit
4	X	2402.700	89.97	-11.99	77.98	74.00	3.98	peak	150	292 No Limit

*:Maximum data x:Over limit !:over margin

⟨Reference Only

Test Mode: TX 2480 MHz_CH78_3Mbps

Vertical

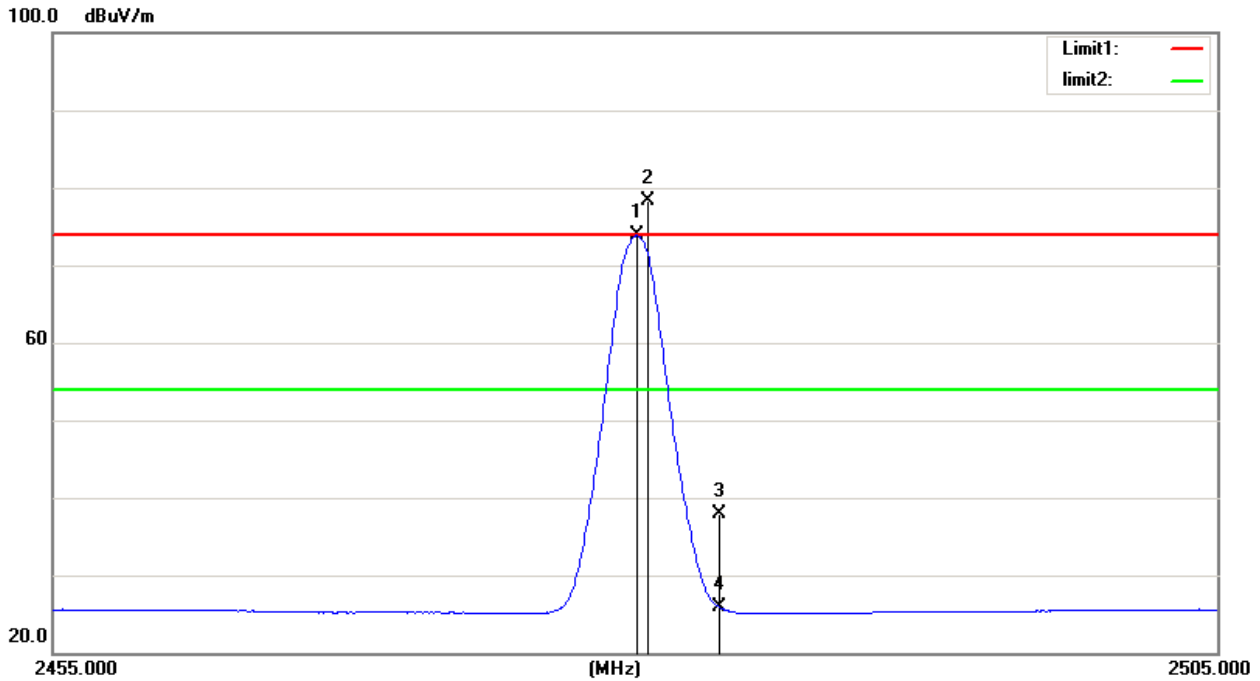

No.	Mk.	Freq.	Reading Level	Correct Factor	Measurement	Limit	Over	Antenna Height	Table Degree		
		MHz	dBuV	dB	dBuV/m	dB/m	dB	Detector	cm	degree	Comment
1	*	2480.000	85.53	-11.71	73.82	54.00	19.82	AVG	150	350	No Limit
2	X	2480.450	89.97	-11.71	78.26	74.00	4.26	peak	150	350	No Limit
3		2483.500	49.62	-11.70	37.92	74.00	-36.08	peak	150	350	
4		2483.500	37.62	-11.70	25.92	54.00	-28.08	AVG	150	350	

*:Maximum data x:Over limit !:over margin

(Reference Only)

Test Mode: TX 2480 MHz_CH78_3Mbps

Horizontal

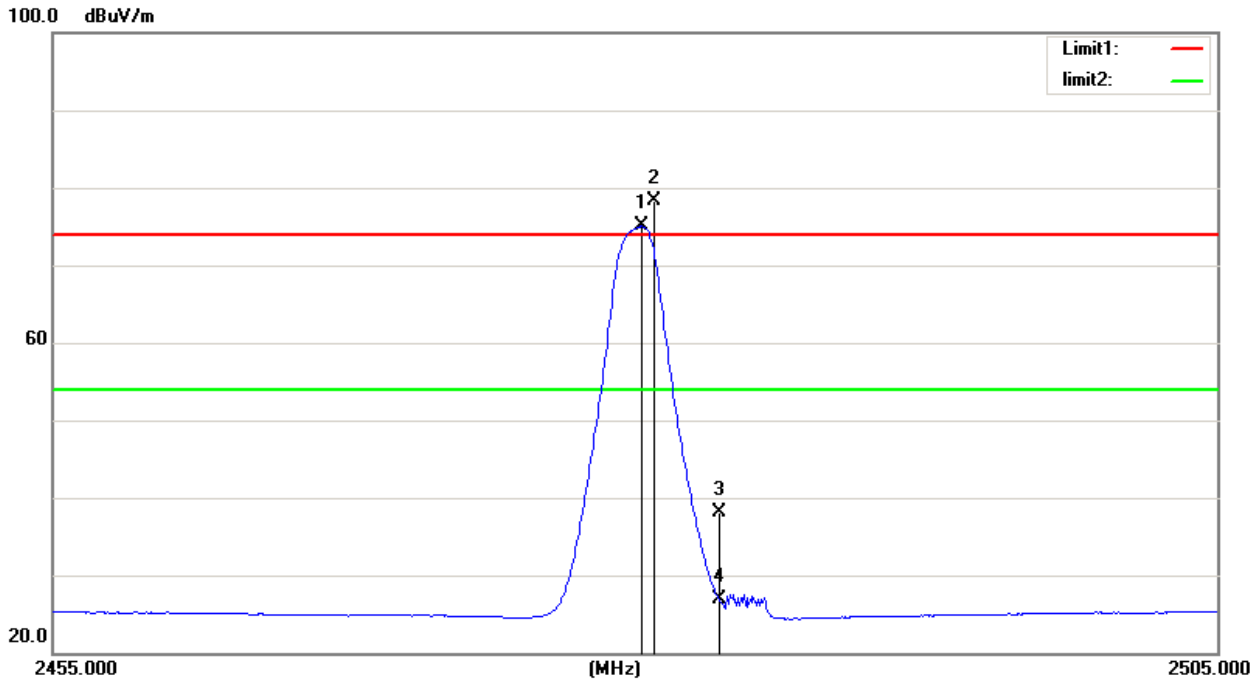

No.	Mk.	Freq.	Reading Level	Correct Factor	Measurement	Limit	Over	Antenna Height	Table Degree		
		MHz	dBuV	dB	dBuV/m	dB/m	dB	cm	degree	Comment	
1	*	2480.200	86.72	-11.71	75.01	54.00	21.01	AVG	150	297	No Limit
2	X	2480.750	89.97	-11.71	78.26	74.00	4.26	peak	150	297	No Limit
3		2483.500	49.82	-11.70	38.12	74.00	-35.88	peak	150	297	
4		2483.500	38.59	-11.70	26.89	54.00	-27.11	AVG	150	297	

*:Maximum data x:Over limit !:over margin

◁Reference Only

5.9 TEST RESULTS - ABOVE 1000MHz(HARMONIC)

Test Mode: TX 2402 MHz_CH00_1Mbps

Vertical

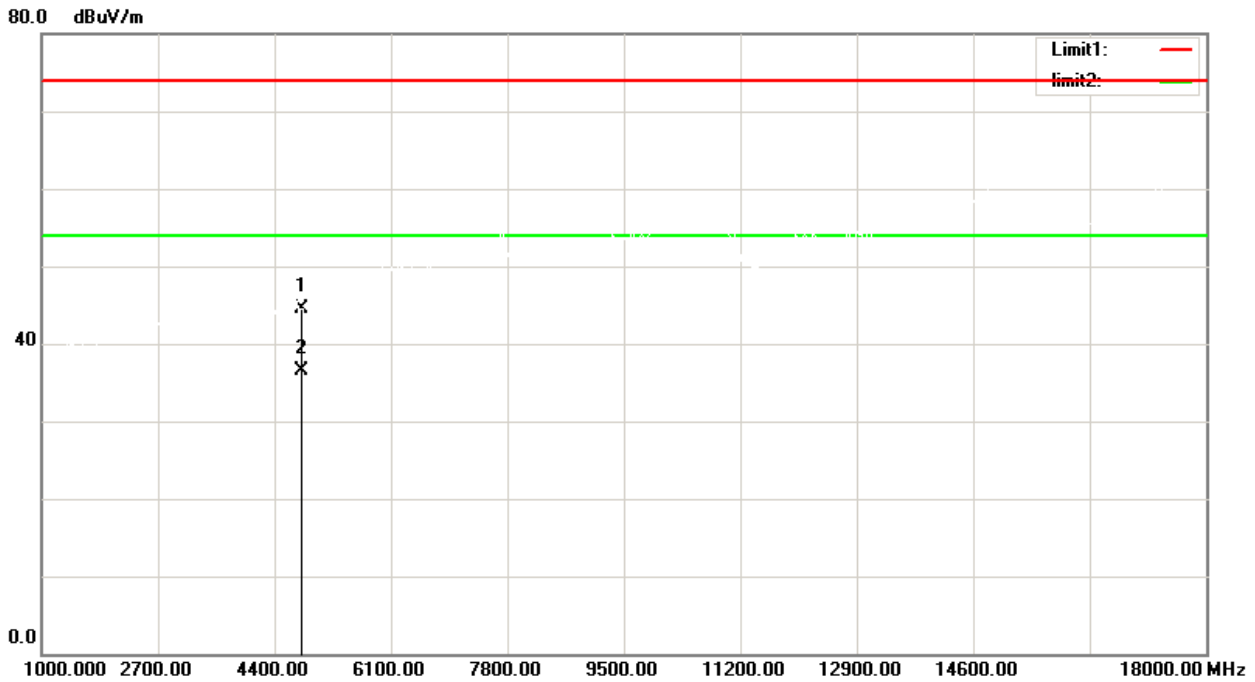

No.	Mk.	Freq. MHz	Reading Level dBuV	Correct Factor dB	Measure- ment dBuV/m	Limit dB/m	Over dB	Detector	Antenna Height cm	Table Degree	Comment
1		4804.000	52.13	-7.68	44.45	74.00	-29.55	peak	150	266	
2	*	4804.000	44.19	-7.68	36.51	54.00	-17.49	AVG	150	266	

*:Maximum data x:Over limit l:over margin

(Reference Only)

Test Mode: TX 2402 MHz_CH00_1Mbps

Horizontal

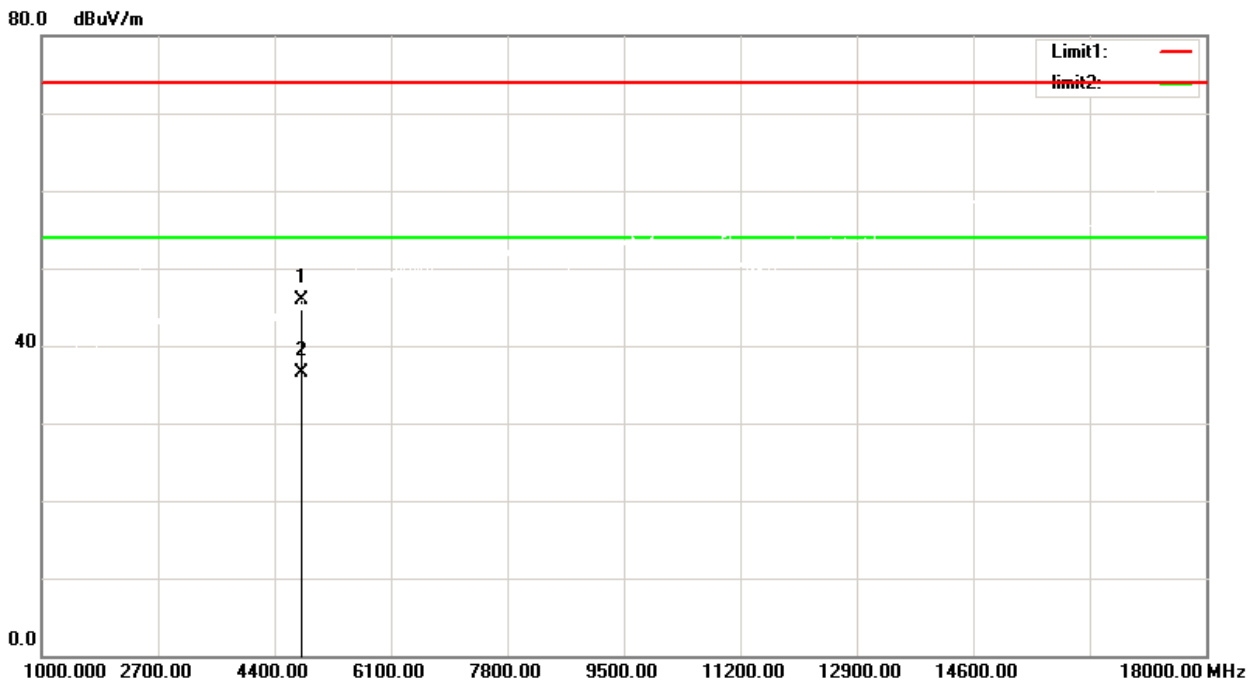

No.	Mk.	Freq. MHz	Reading Level dBuV	Correct Factor dB	Measure- ment dBuV/m	Limit dB/m	Over dB	Detector	Antenna Height cm	Table Degree	Comment
1		4804.000	53.63	-7.68	45.95	74.00	-28.05	peak	150	349	
2	*	4804.000	44.15	-7.68	36.47	54.00	-17.53	AVG	150	349	

*:Maximum data x:Over limit !:over margin

<Reference Only

Test Mode: TX 2441 MHz_CH39_1Mbps

Vertical

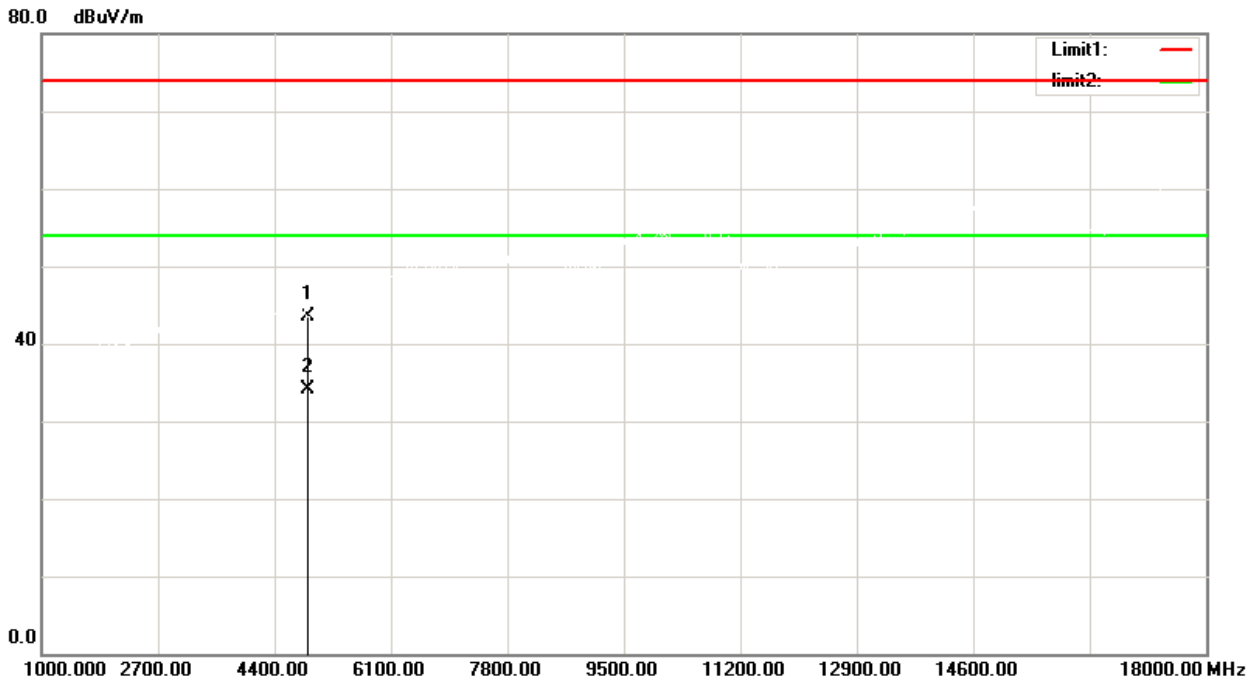

No.	Mk.	Freq. MHz	Reading Level dBuV	Correct Factor dB	Measure- ment dBuV/m	Limit dB/m	Over dB	Detector	Antenna Height cm	Table Degree	Comment
1		4882.000	51.03	-7.51	43.52	74.00	-30.48	peak	150	279	
2	*	4882.000	41.67	-7.51	34.16	54.00	-19.84	AVG	150	279	

*:Maximum data x:Over limit !:over margin

◁Reference Only

Test Mode: TX 2441 MHz_CH39_1Mbps

Horizontal

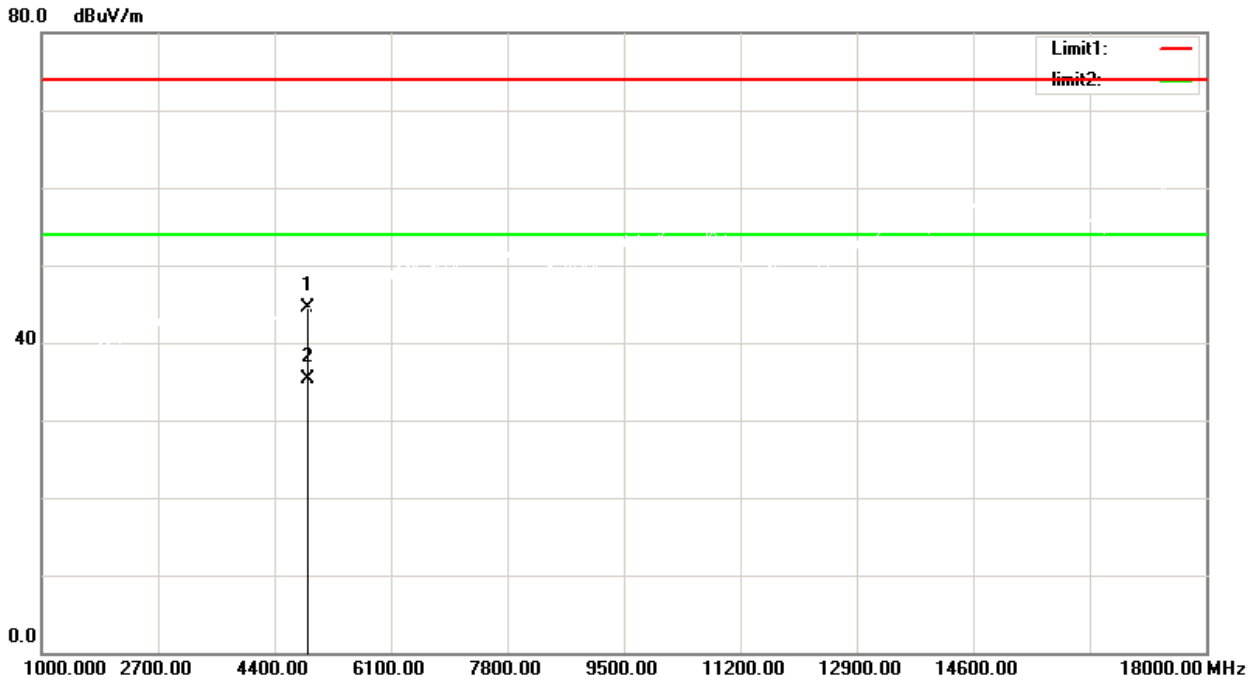

No.	Mk.	Freq. MHz	Reading Level dBuV	Correct Factor dB	Measure- ment dBuV/m	Limit dB/m	Over dB	Detector	Antenna Height cm	Table Degree	Comment
1		4882.000	51.98	-7.51	44.47	74.00	-29.53	peak	150	351	
2	*	4882.000	42.72	-7.51	35.21	54.00	-18.79	AVG	150	351	

*:Maximum data x:Over limit !:over margin

⟨Reference Only

Test Mode: TX 2480 MHz_CH78_1Mbps

Vertical

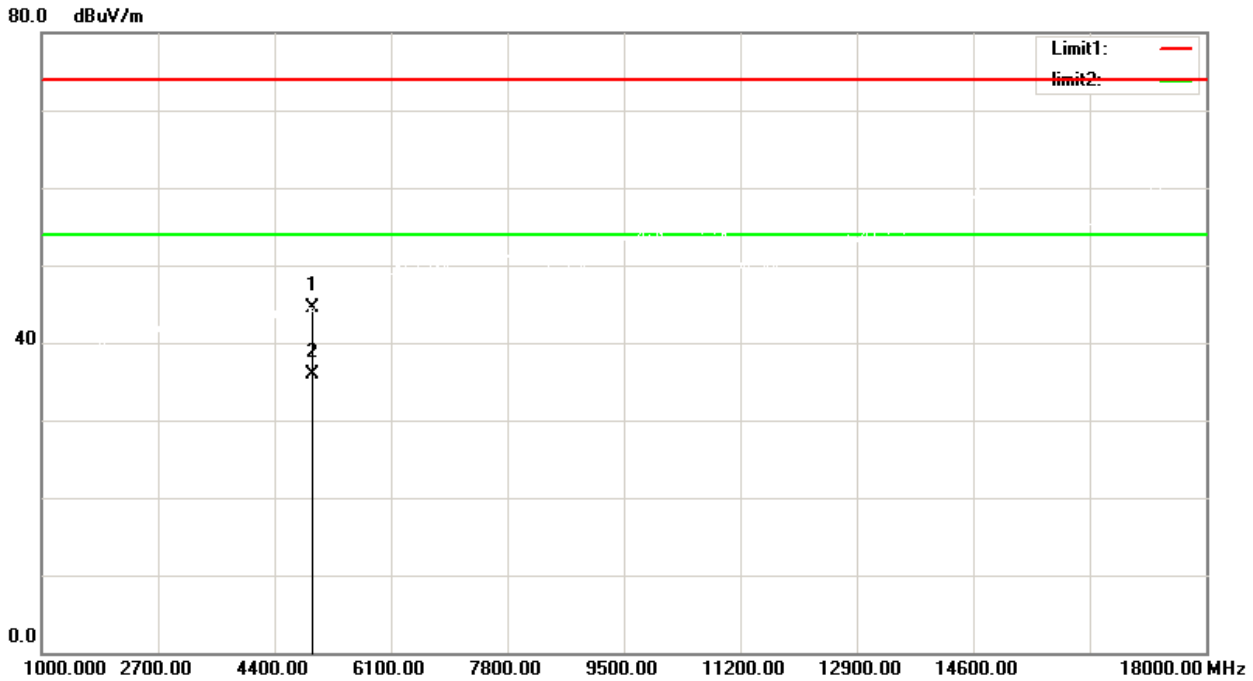

No.	Mk.	Freq. MHz	Reading Level dBuV	Correct Factor dB	Measure- ment dBuV/m	Limit dB/m	Over dB	Detector	Antenna Height cm	Table Degree	Comment
1		4960.000	51.78	-7.34	44.44	74.00	-29.56	peak	150	349	
2	*	4960.000	43.20	-7.34	35.86	54.00	-18.14	AVG	150	349	

*:Maximum data x:Over limit !:over margin

⟨Reference Only

Test Mode: TX 2480 MHz_CH78_1Mbps

Horizontal

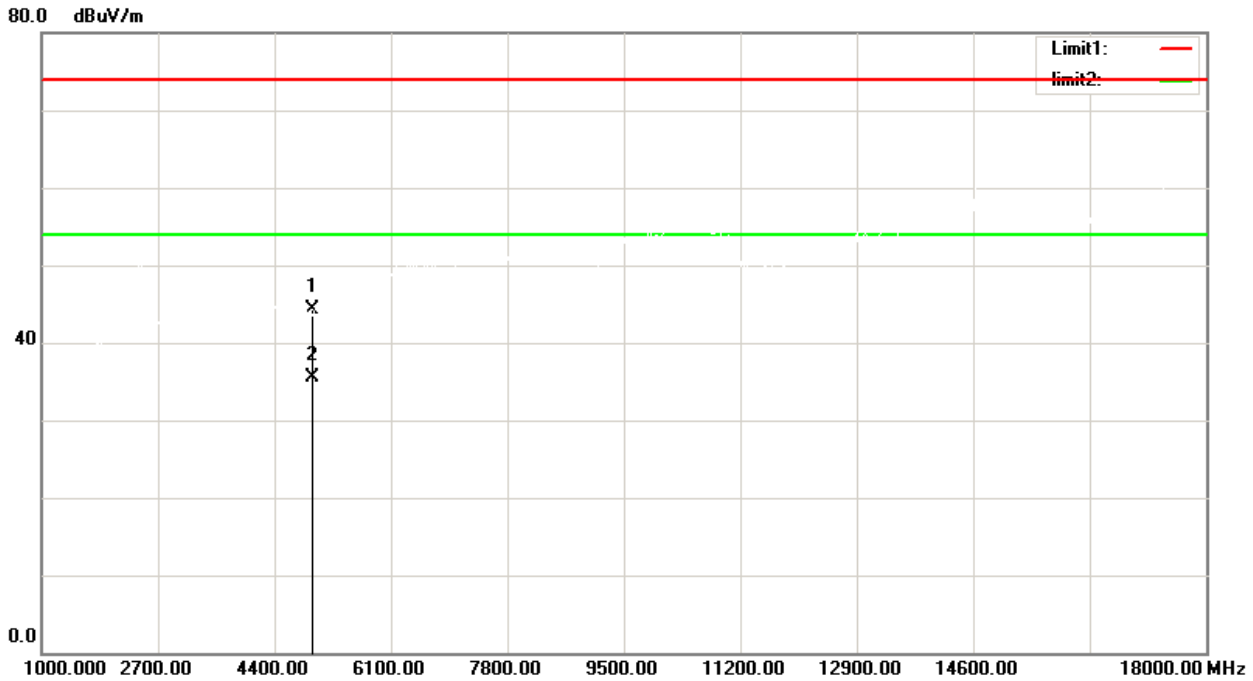

No.	Mk.	Freq. MHz	Reading Level dBuV	Correct Factor dB	Measure- ment dBuV/m	Limit dB/m	Over dB	Detector	Antenna Height cm	Table Degree	Comment
1		4960.000	51.70	-7.34	44.36	74.00	-29.64	peak	150	269	
2	*	4960.000	42.81	-7.34	35.47	54.00	-18.53	AVG	150	269	

*:Maximum data x:Over limit !:over margin

<Reference Only

Test Mode: TX 2402 MHz_CH00_3Mbps

Vertical

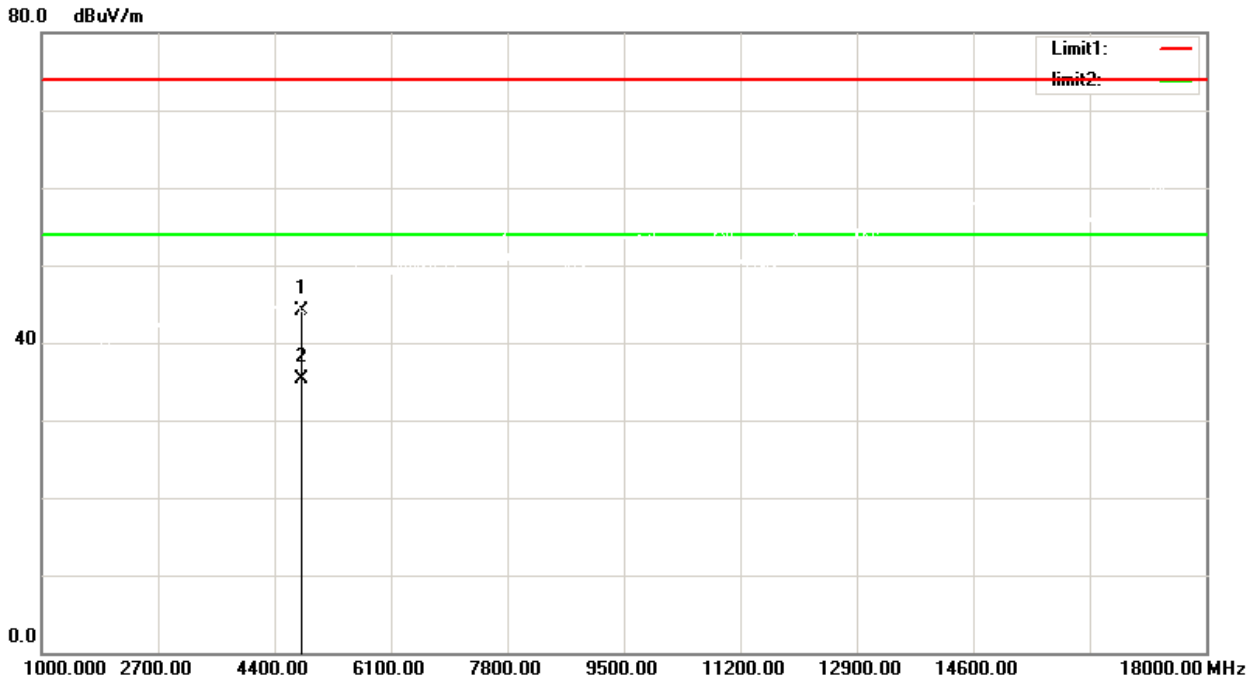

No.	Mk.	Freq. MHz	Reading Level dBuV	Correct Factor dB	Measure- ment dBuV/m	Limit dB/m	Over dB	Detector	Antenna Height cm	Table Degree degree	Comment
1		4804.000	51.70	-7.68	44.02	74.00	-29.98	peak	150	298	
2	*	4804.000	42.95	-7.68	35.27	54.00	-18.73	AVG	150	298	

*:Maximum data x:Over limit !:over margin

(Reference Only)

Test Mode: TX 2402 MHz_CH00_3Mbps

Horizontal

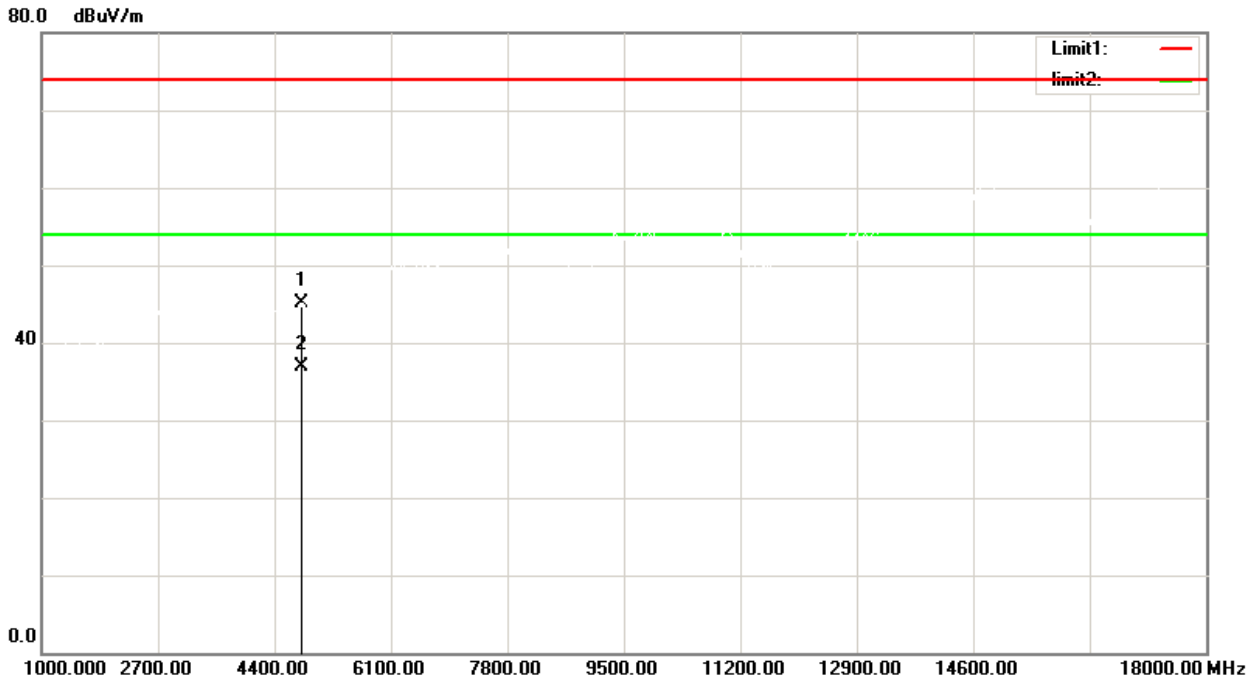

No.	Mk.	Freq. MHz	Reading Level dBuV	Correct Factor dB	Measure- ment dBuV/m	Limit dB/m	Over dB	Detector	Antenna Height cm	Table Degree degree	Comment
1		4804.000	52.87	-7.68	45.19	74.00	-28.81	peak	150	346	
2	*	4804.000	44.55	-7.68	36.87	54.00	-17.13	AVG	150	346	

*:Maximum data x:Over limit !:over margin

⟨Reference Only

Test Mode: TX 2441 MHz_CH39_3Mbps

Vertical

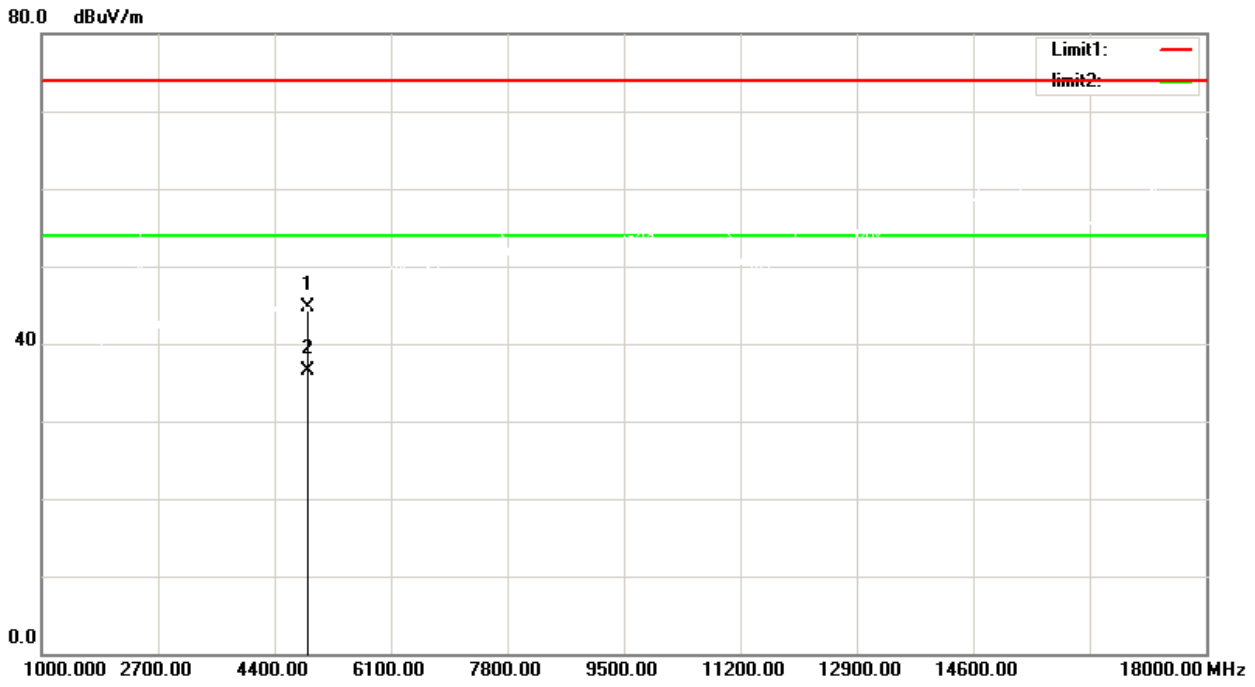

No.	Mk.	Freq. MHz	Reading Level dBuV	Correct Factor dB	Measure- ment dBuV/m	Limit dB/m	Over dB	Detector	Antenna Height cm	Table Degree	Comment
1		4882.000	52.14	-7.51	44.63	74.00	-29.37	peak	150	274	
2	*	4882.000	44.08	-7.51	36.57	54.00	-17.43	AVG	150	274	

*:Maximum data x:Over limit !:over margin

(Reference Only)

Test Mode: TX 2441 MHz_CH39_3Mbps

Horizontal

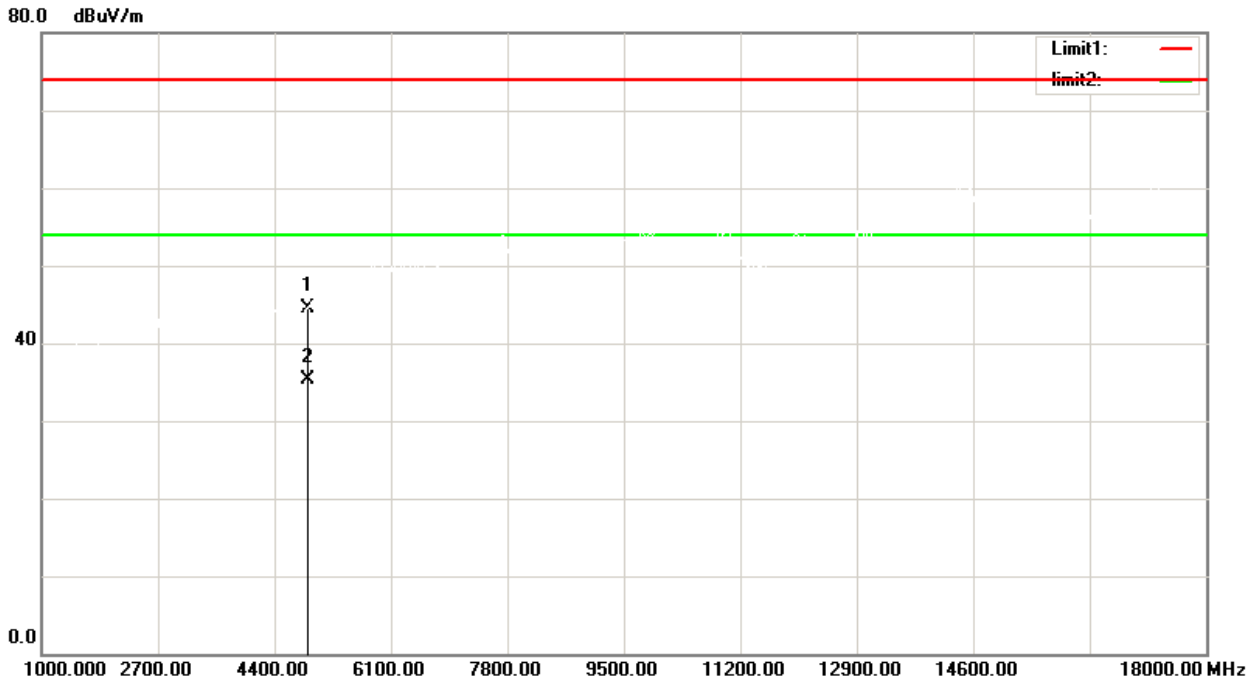

No.	Mk.	Freq. MHz	Reading Level dBuV	Correct Factor dB	Measure- ment dBuV/m	Limit dB/m	Over dB	Detector	Antenna Height cm	Table Degree	Comment
1		4882.000	52.11	-7.51	44.60	74.00	-29.40	peak	150	354	
2	*	4882.000	42.80	-7.51	35.29	54.00	-18.71	AVG	150	354	

*:Maximum data x:Over limit !:over margin

(Reference Only)

Test Mode: TX 2480 MHz_CH78_3Mbps

Vertical

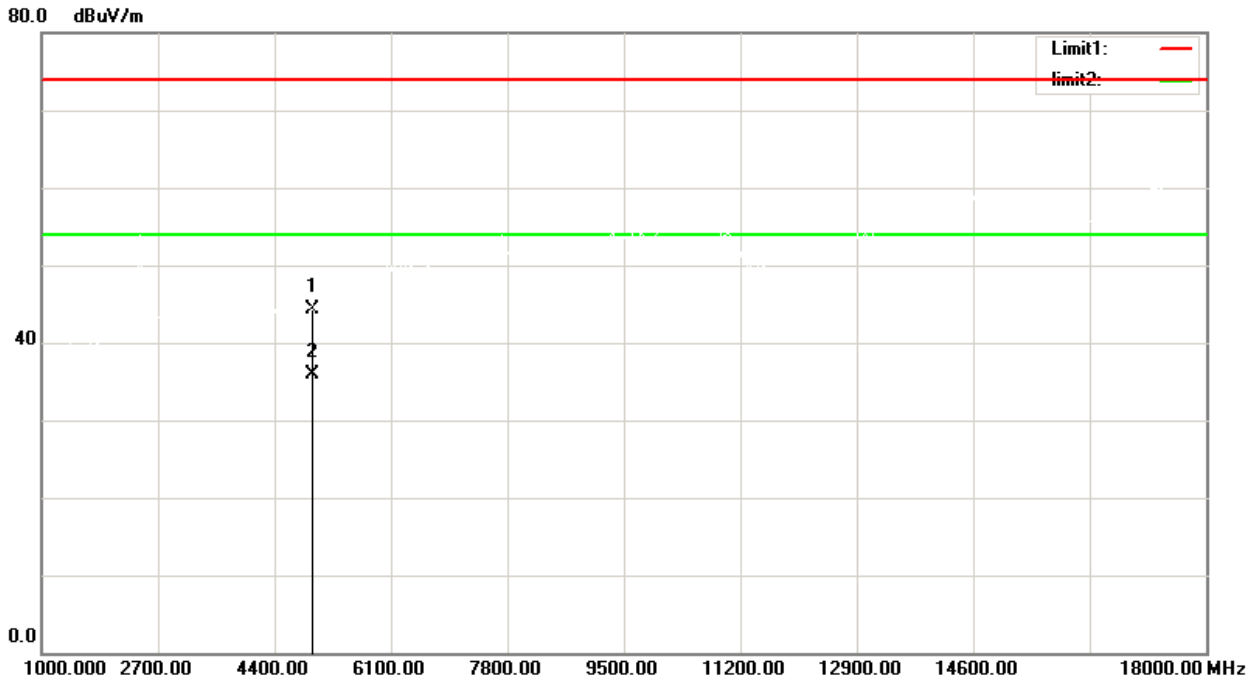

No.	Mk.	Freq. MHz	Reading Level dBuV	Correct Factor dB	Measure- ment dBuV/m	Limit dB/m	Over dB	Detector	Antenna Height cm	Table Degree	Comment
1		4960.000	51.59	-7.34	44.25	74.00	-29.75	peak	150	299	
2	*	4960.000	43.21	-7.34	35.87	54.00	-18.13	AVG	150	299	

*:Maximum data x:Over limit !:over margin

<Reference Only

Test Mode: TX 2480 MHz_CH78_3Mbps

Horizontal

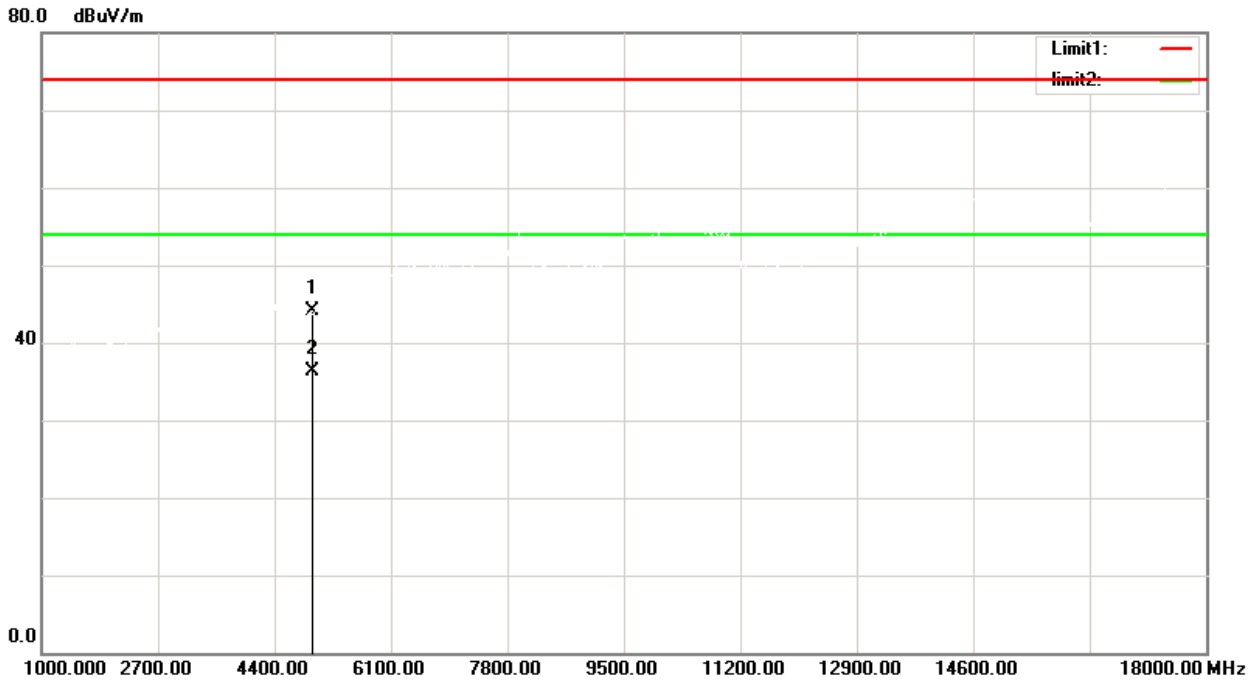

No.	Mk.	Freq. MHz	Reading Level dBuV	Correct Factor dB	Measure- ment dBuV/m	Limit dB/m	Over dB	Antenna Height cm	Table Degree	Comment
1		4960.000	51.36	-7.34	44.02	74.00	-29.98	peak	150	287
2	*	4960.000	43.58	-7.34	36.24	54.00	-17.76	AVG	150	287

*:Maximum data x:Over limit !:over margin

(Reference Only)

6NUMBER OF HOPPING FREQUENCY

6.1LIMIT

FCC Part15, Subpart C (15.247)&RSS-247	
Section	Test Item
15.247(a)(1)(iii) RSS-247 5.1 (d)	Number of Hopping Frequency

6.2TEST PROCEDURE AND SETTING

- a. The EUT was directly connected to the spectrum analyzer and antenna output port as show in the block diagram below.
- b. Spectrum Setting: RBW=100 kHz, VBW=300 kHz, Sweep time = Auto.

Spectrum Parameters	Setting
Attenuation	Auto
Span Frequency	> Operating Frequency Range
RBW	100kHz
VBW	300kHz
Detector	Peak
Trace	Max Hold
Sweep Time	Auto

6.3MEASUREMENT INSTRUMENTS LIST

Item	Kind of Equipment	Manufacturer	Type No.	Serial No.	Calibrated until
1	Spectrum analyzer	KEYSIGHT	N9010A	MY55150427	2023/05/26
2	Attenuator	Mini-Circuits	BW-S10W2	101109	N/A
3	RF Cable	Mi-cable	C10-01-01-1	100309	N/A

6.4TEST SETUP



6.5EUT OPERATION CONDITIONS

The EUT tested system was configured as the statements of 4.5 unless otherwise a special operating condition is specified in the follows during the testing.

6.6 TEST RESULTS

Hopping Mode_1Mbps		
Number of Hopping Frequency	Measurement result(CH)	Limit(CH)
	79	≥15

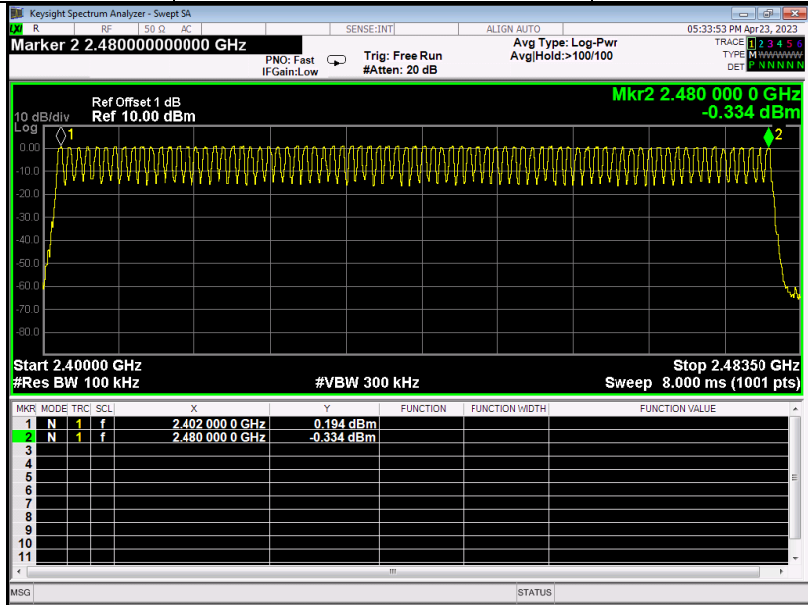

Hopping Mode_3Mbps		
Number of Hopping Frequency	Measurement result(CH)	Limit(CH)
	79	≥15

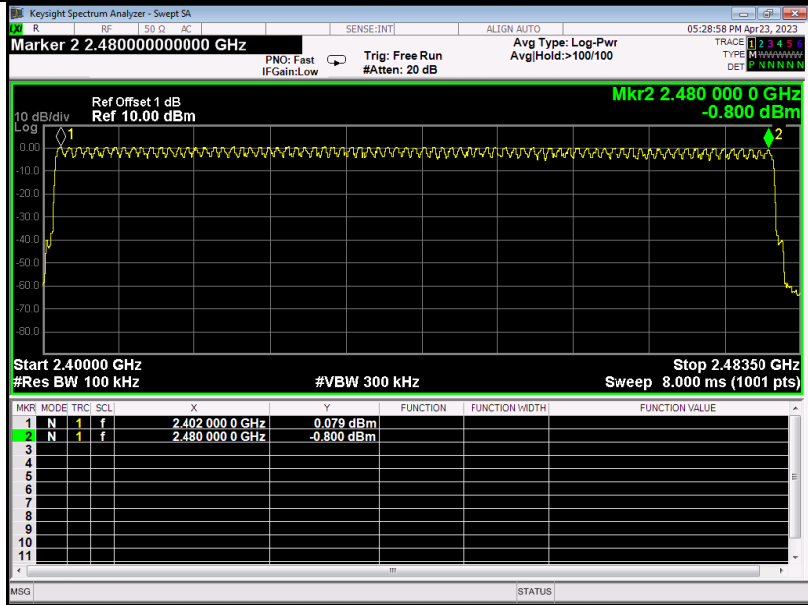

7 AVERAGE TIME OF OCCUPANCY

7.1 LIMIT

FCC Part15, Subpart C (15.247)&RSS-247		
Section	Test Item	Limit
15.247(a)(1)(iii) RSS-247 5.1 (d)	Average Time of Occupancy	0.4sec

7.2 TEST PROCEDURE AND SETTING

- a. The transmitter output (antenna port) was connected to the spectrum analyzer
- b. Set RBW of spectrum analyzer to 1MHz and VBW to 1MHz
- c. Use a video trigger with the trigger level set to enable triggering only on full pulses
- d. Sweep Time is more than once pulse time
- e. Set the center frequency on any frequency would be measure and set the frequency span to zero span
- f. Measure the maximum time duration of one single pulse
- g. Set the EUT for DH1, DH3 and DH5 packet transmitting
- h. Measure the maximum time duration of one single pulse
- i. DH1 Packet permit maximum $1600 / 79 / 2 = 10.12$ hops per second in each channel (1 time slot TX, 1 time slot RX). So, the dwell time is the time duration of the pulse times $10.12 \times 31.6 = 320$ within 31.6 seconds
- j. DH3 Packet permit maximum $1600 / 79 / 4 = 5.06$ hops per second in each channel (3 time slots TX, 1 time slot RX). So, the dwell time is the time duration of the pulse times $5.06 \times 31.6 = 160$ within 31.6 seconds
- k. DH5 Packet permit maximum $1600 / 79 / 6 = 3.37$ hops per second in each channel (5 time slots TX, 1 time slot RX). So, the dwell time is the time duration of the pulse times $3.37 \times 31.6 = 106.6$ within 31.6 seconds

7.3 MEASUREMENT INSTRUMENTS LIST

Item	Kind of Equipment	Manufacturer	Type No.	Serial No.	Calibrated until
1	Spectrum analyzer	KEYSIGHT	N9010A	MY55150427	2023/05/26
2	Attenuator	Mini-Circuits	BW-S10W2	101109	N/A
3	RF Cable	Mi-cable	C10-01-01-1	100309	N/A

7.4 TEST SETUP



7.5 EUT OPERATION CONDITIONS

The EUT tested system was configured as the statements of 4.5 unless otherwise a special operating condition is specified in the follows during the testing.

7.6 TEST RESULTS

TX Mode_1Mbps				
Mode	Channel Frequency (MHz)	Pulse Time (ms)	Dwell Time (ms)	Limit (ms)
DH1	2441	0.423	135.4	400
DH3	2441	1.687	269.9	400
DH5	2441	313.5	400	

DH1

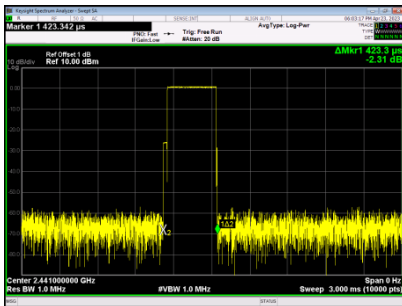

DH3

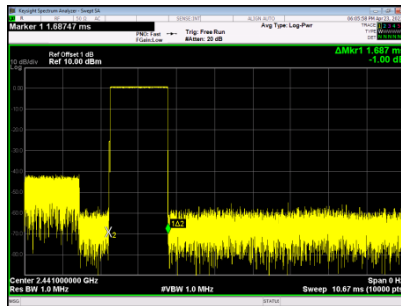

DH5

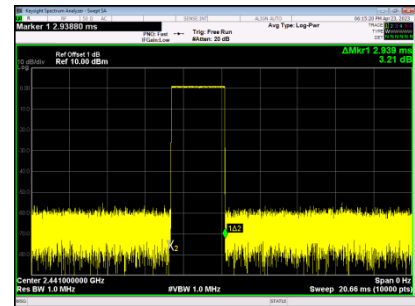

TX Mode_3Mbps				
Mode	Channel Frequency (MHz)	Pulse Time (ms)	Dwell Time (ms)	Limit (ms)
DH1	2441	0.431	137.9	400
DH3	2441	1.679	268.6	400
DH5	2441	2.935	313.1	400

2441MHzDH1

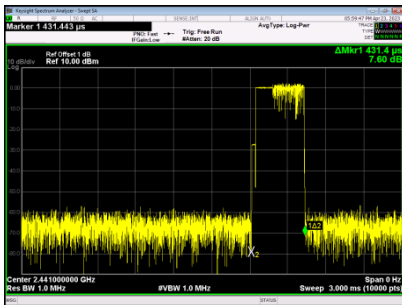

2441MHzDH3

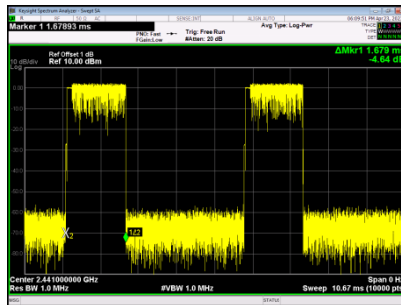

2441MHzDH5



8 HOPPING CHANNEL SEPARATION MEASUREMENT

8.1 LIMIT

Frequency hopping systems operating in the 2400-2483.5 MHz band may have hopping channel carrier frequencies that are separated by 25 kHz or two-thirds of the 20 dB bandwidth of the hopping channel, whichever is greater, provided the systems operate with an output power no greater than 125 mW.

8.2 TEST PROCEDURE AND SETTING

- a. The EUT was directly connected to the spectrum analyzer and antenna output port as show in the block diagram below.
- b. Span = wide enough to capture the peaks of two adjacent channels
 Resolution (or IF) Bandwidth (RBW) \geq 1% of the span
 Video (or Average) Bandwidth (VBW) \geq RBW
 Sweep = Auto
 Detector function = Peak
 Trace = Max Hold

Spectrum Parameter	Setting
Attenuation	Auto
Span Frequency	> Measurement Bandwidth or Channel Separation
RBW	10 kHz
VBW	30 kHz
Detector	Peak
Trace	Max Hold
Sweep Time	Auto

8.3 MEASUREMENT INSTRUMENTS LIST

Item	Kind of Equipment	Manufacturer	Type No.	Serial No.	Calibrated until
1	Spectrum analyzer	KEYSIGHT	N9010A	MY55150427	2023/05/26
2	Attenuator	Mini-Circuits	BW-S10W2	101109	N/A
3	RF Cable	Mi-cable	C10-01-01-1	100309	N/A

8.4 TEST SETUP

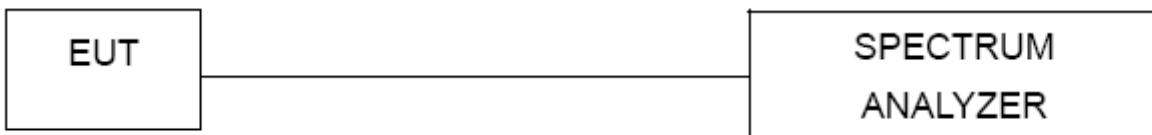

8.5 EUT OPERATION CONDITIONS

The EUT tested system was configured as the statements of 4.5 unless otherwise a special operating condition is specified in the follows during the testing.

8.6 TEST RESULTS

TX Mode_1Mbps				
Channel	Frequency (MHz)	Channel Separation(MHz)	Limit (MHz)	Result
CH00	2402	0.993	>(25KHz or 2/3*20dB Bandwidth)	PASS
CH39	2441	0.999	>(25KHz or 2/3*20dB Bandwidth)	PASS
CH78	2480	0.996	>(25KHz or 2/3*20dB Bandwidth)	PASS



TX Mode_3Mbps				
Channel	Frequency (MHz)	Channel Separation(MHz)	Limit (MHz)	Result
CH00	2402	1.002	>(25KHz or 2/3*20dB Bandwidth)	PASS
CH39	2441	1.002	>(25KHz or 2/3*20dB Bandwidth)	PASS
CH78	2480	0.999	>(25KHz or 2/3*20dB Bandwidth)	PASS

2402MHz

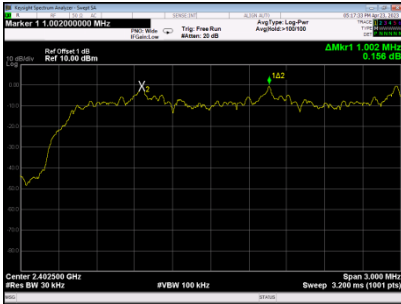

2441MHz

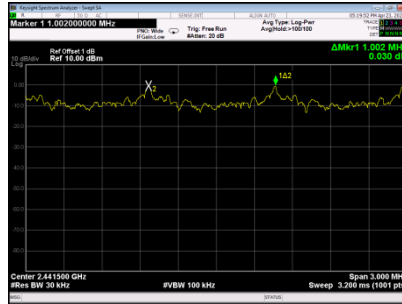

2480MHz



9 BANDWIDTH TEST

9.1 LIMIT

FCC Part15, Subpart C (15.247)&RSS-247	
Section	Test Item
15.247(a)(1) RSS-Gen 6.7 RSS-247 5.1 (a)	Bandwidth

9.2 TEST PROCEDURE AND SETTING

- a. The EUT was directly connected to the spectrum analyzer and antenna output port as show in the block diagram below.
- b. Spectrum Setting: RBW= 30 kHz, VBW=100 kHz, Sweep Time = Auto.

Spectrum Parameter	Setting
Attenuation	Auto
Span Frequency	> Measurement Bandwidth
RBW	30kHz
VBW	100kHz
Detector	Peak
Trace	Max Hold
Sweep Time	Auto

9.3 MEASUREMENT INSTRUMENTS LIST

Item	Kind of Equipment	Manufacturer	Type No.	Serial No.	Calibrated until
1	Spectrum analyzer	KEYSIGHT	N9010A	MY55150427	2023/05/26
2	Attenuator	Mini-Circuits	BW-S10W2	101109	N/A
3	RF Cable	Mi-cable	C10-01-01-1	100309	N/A

9.4 TEST SETUP



9.5 EUT OPERATION CONDITIONS

The EUT tested system was configured as the statements of 4.5 unless otherwise a special operating condition is specified in the follows during the testing.

9.6 TEST RESULTS

TX Mode_1Mbps				
Channel	Frequency (MHz)	20dB Bandwidth (MHz)	99 % Emission Bandwidth (MHz)	Result
CH00	2402	0.964	0.906	PASS
CH39	2441	0.967	0.906	PASS
CH78	2480	0.966	0.907	PASS

2402MHz

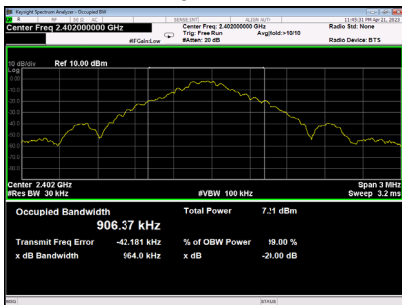

2441MHz

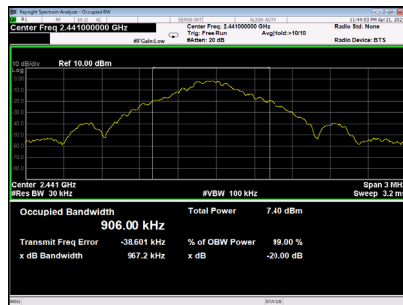

2480MHz

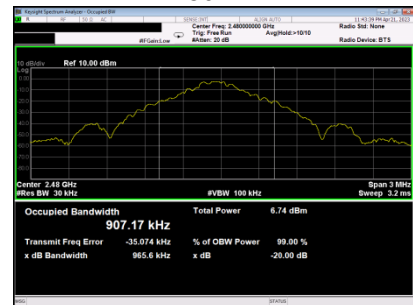

TX Mode_3Mbps				
Channel	Frequency (MHz)	20dB Bandwidth (MHz)	99 % Emission Bandwidth (MHz)	Result
CH00	2402	1.382	1.237	PASS
CH39	2441	1.386	1.238	PASS
CH78	2480	1.385	1.237	PASS

2402MHz

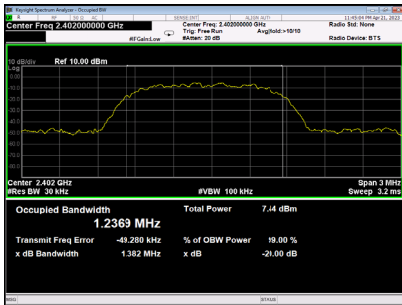

2441MHz

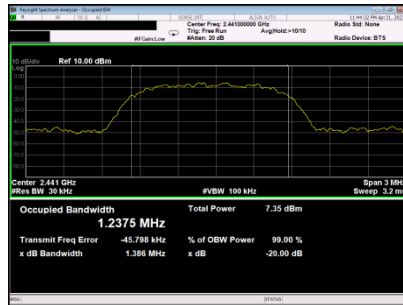

2480MHz

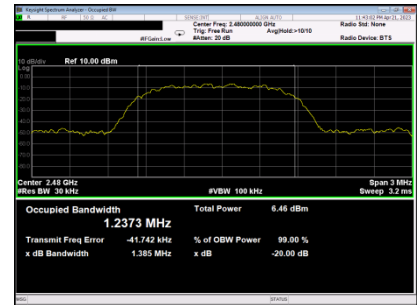

10 MAXIMUM OUTPUT POWER

10.1 LIMIT

FCC Part15 , Subpart C (15.247)&RSS-247		
Section	Test Item	Limit
15.247(a)(1) RSS-247 5.1 (b)	Maximum Output Power	0.125Watt or 21dBm

Note:

Frequency hopping systems shall have hopping channel carrier frequencies separated by a minimum of 25 kHz or the 20 dB bandwidth of the hopping channel, whichever is greater. Alternatively, frequency hopping systems operating in the 2400-2483.5 MHz band may have hopping channel carrier frequencies that are separated by 25 kHz or two-thirds of the 20 dB bandwidth of the hopping channel, whichever is greater, provided the systems operate with an output power no greater than 125 mW.

10.2 TEST PROCEDURE AND SETTING

- a. The EUT was directly connected to the spectrum analyzer and antenna output port as show in the block diagram below.
- b. Spectrum Setting: RBW= 1MHz/3MHz, VBW= 1MHz/3MHz, Sweep time = Auto.

10.3 MEASUREMENT INSTRUMENTS LIST

Item	Kind of Equipment	Manufacturer	Type No.	Serial No.	Calibrated until
1	Spectrum analyzer	KEYSIGHT	N9010A	MY55150427	2023/05/26
2	Attenuator	Mini-Circuits	BW-S10W2	101109	N/A
3	RF Cable	Mi-cable	C10-01-01-1	100309	N/A

10.4 TEST SETUP



10.5 EUT OPERATION CONDITIONS

The EUT tested system was configured as the statements of 4.5 unless otherwise a special operating condition is specified in the follows during the testing.

10.6 TEST RESULTS

TX Mode_1Mbps				
Channel	Frequency (MHz)	Output Power (dBm)	Output Power (W)	Result
CH00	2402	0.476	0.00112	PASS
CH39	2441	0.640	0.00116	PASS
CH78	2480	-0.029	0.00099	PASS
Limit	21dBm /0.125W			

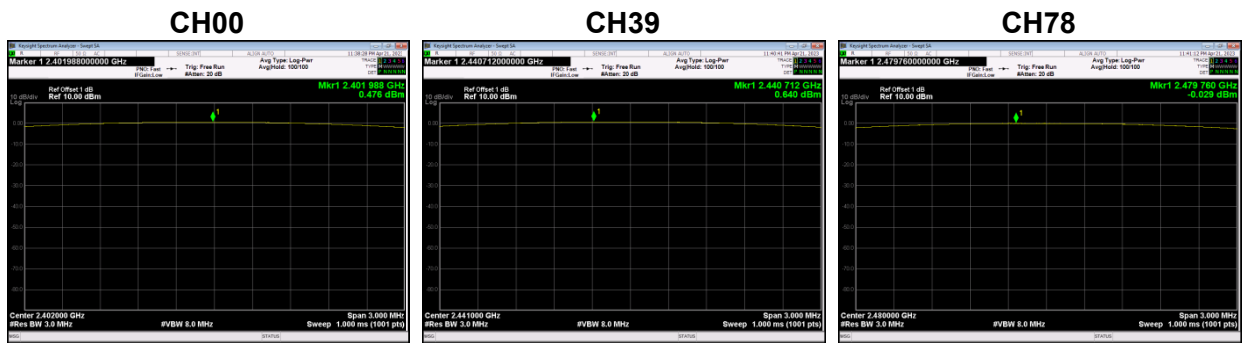

TX Mode_2Mbps				
Channel	Frequency (MHz)	Output Power (dBm)	Output Power (W)	Result
CH00	2402	2.666	0.00185	PASS
CH39	2441	2.574	0.00181	PASS
CH78	2480	1.691	0.00148	PASS
Limit	21dBm /0.125W			

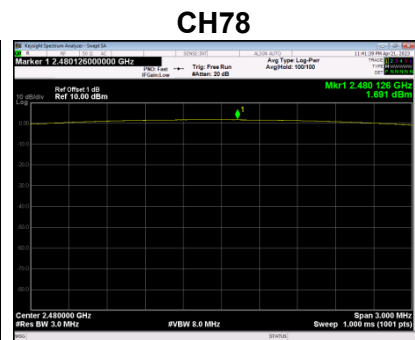
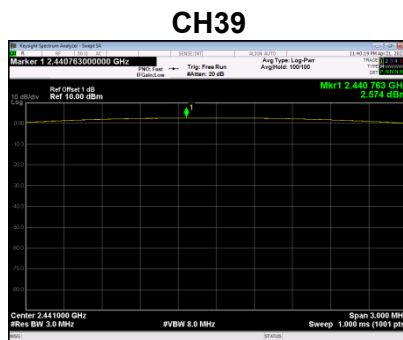
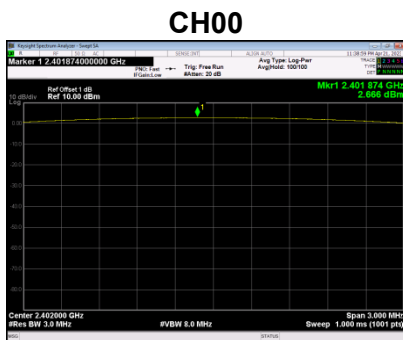

TX Mode_3Mbps				
Channel	Frequency (MHz)	Output Power (dBm)	Output Power (W)	Result
CH00	2402	3.073	0.00203	PASS
CH39	2441	2.989	0.00199	PASS
CH78	2480	2.115	0.00163	PASS
Limit	21dBm /0.125W			

CH00

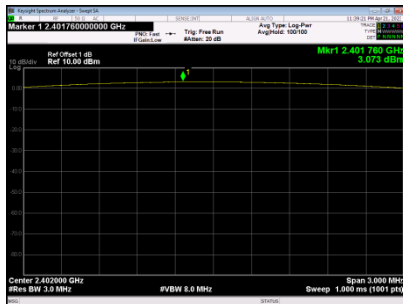

CH39

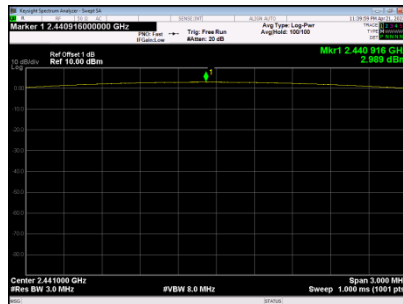

CH78

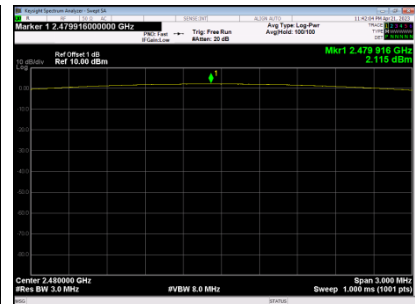

11 CONDUCTED SPURIOUS EMISSION

11.1 LIMIT

For FCC

In any 100 kHz bandwidth outside the frequency band in which the spread spectrum or digitally modulated intentional radiator is operating, the radio frequency power that is produced by the intentional radiator shall be at least 20 dB below that in the 100 kHz bandwidth within the band that contains the highest level of the desired power, based on either an RF conducted or a radiated measurement, provided the transmitter demonstrates compliance with the peak Output Power limits. If the transmitter complies with the Output Power limits based on the use of RMS averaging over a time interval, as permitted under paragraph (b)(3) of this section, the attenuation required under this paragraph shall be 30 dB instead of 20 dB. Attenuation below the general limits specified in Section 15.209(a) is not required.

For ISCED

In any 100 kHz bandwidth outside the frequency band in which the spread spectrum or digitally modulated device is operating, the RF power that is produced shall be at least 20 dB below that in the 100 kHz bandwidth within the band that contains the highest level of the desired power, based on either an RF conducted or a radiated measurement, provided that the transmitter demonstrates compliance with the peak Output Power limits. If the transmitter complies with the Output Power limits based on the use of root-mean-square averaging over a time interval, as permitted under section 5.4(d), the attenuation required shall be 30 dB instead of 20 dB. Attenuation below the general field strength limits specified in RSS-Gen is not required.

11.2 TEST PROCEDURE AND SETTING

- a. The EUT was directly connected to the spectrum analyzer and antenna output port as show in the block diagram below.
- b. Spectrum Setting: RBW= 100 kHz, VBW=300 kHz, Sweep time = Auto.

11.3 MEASUREMENT INSTRUMENTS LIST

Item	Kind of Equipment	Manufacturer	Type No.	Serial No.	Calibrated until
1	Spectrum analyzer	KEYSIGHT	N9010A	MY55150427	2023/05/26
2	Attenuator	Mini-Circuits	BW-S10W2	101109	N/A
3	RF Cable	Mi-cable	C10-01-01-1	100309	N/A

11.4 TEST SETUP



11.5 EUT OPERATION CONDITIONS

The EUT tested system was configured as the statements of 4.5 unless otherwise a special operating condition is specified in the follows during the testing.

11.6 TEST RESULTS

TX Mode_1Mbps

Bandedge- CH00 (Lower)

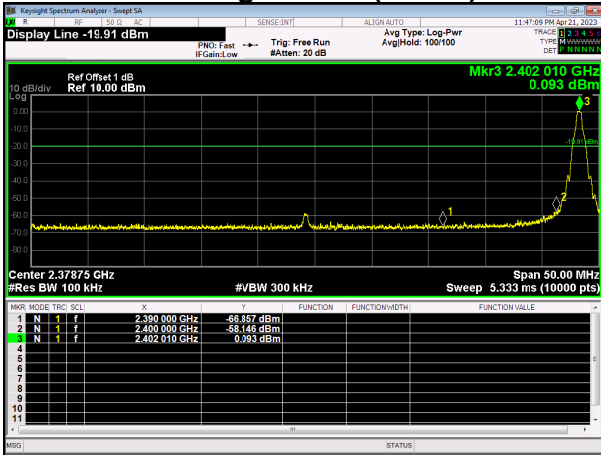

Bandedge CH78 (Upper)

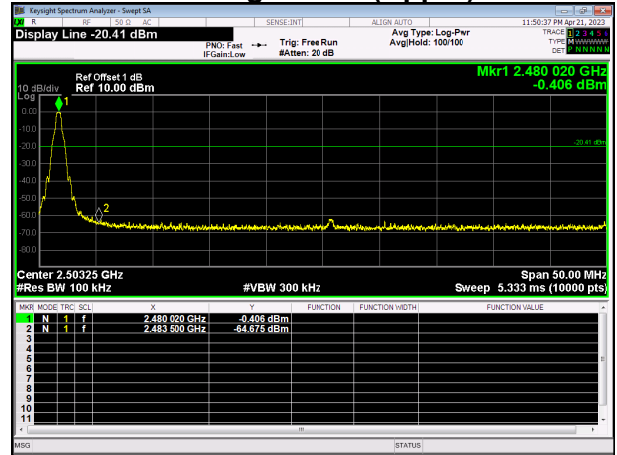

Bandedge- Hopping on (Lower)

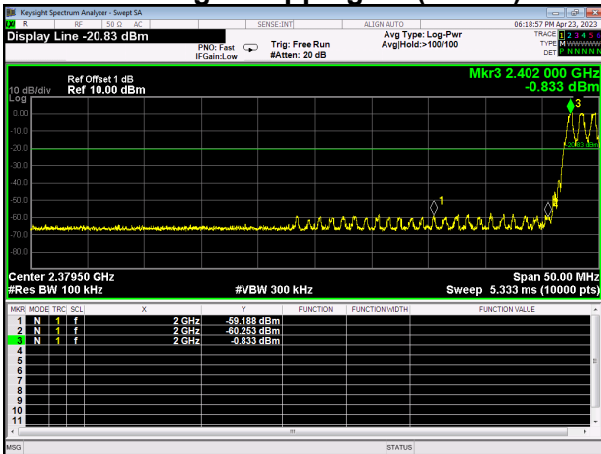

BandedgeHopping on (Upper)

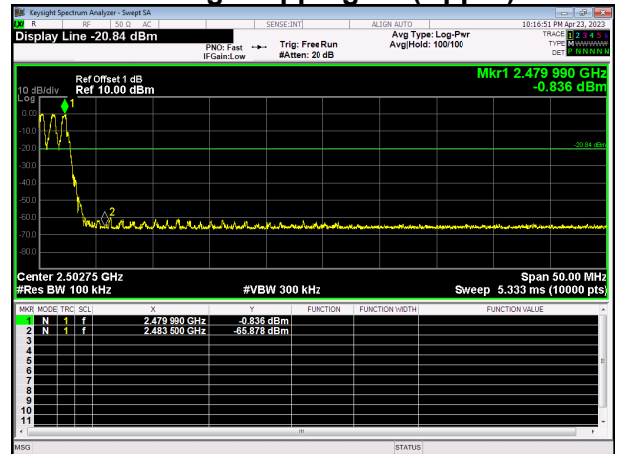

10th Harmonic of the fundamental frequency

CH00

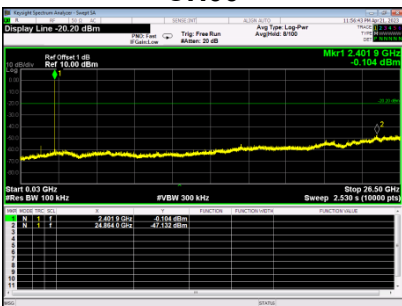

CH39

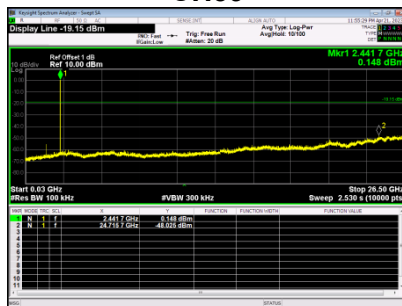

CH78

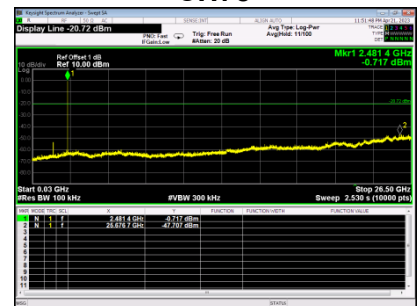

TX Mode_3Mbps

Bandedge- CH00 (Lower)

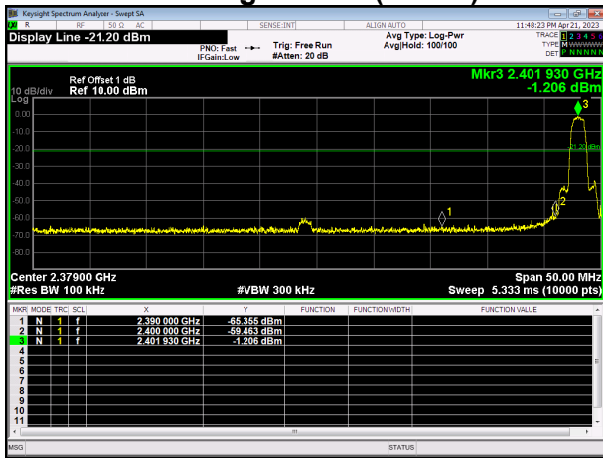

Bandedge CH78 (Upper)

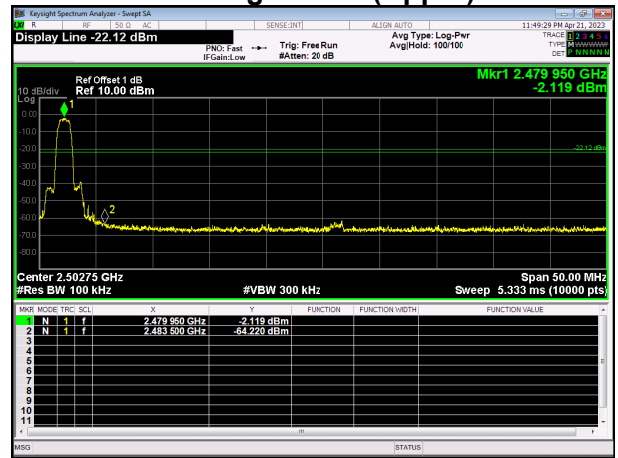

Bandedge- Hopping on (Lower)

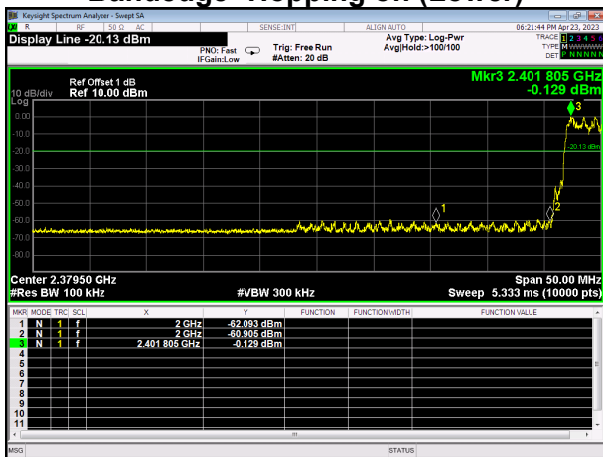

Bandedge- Hopping on (Upper)

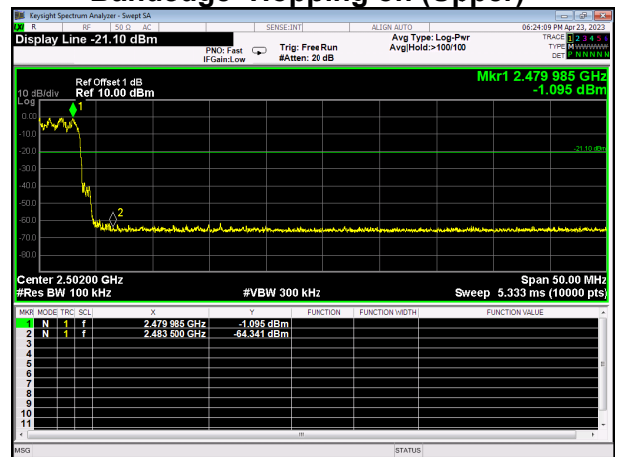

10th Harmonic of the fundamental frequency

CH00



CH39

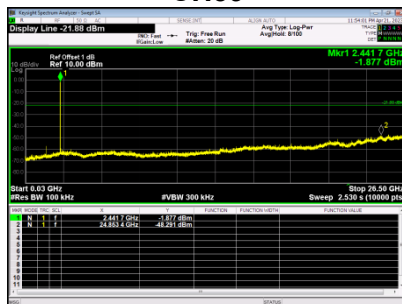

CH78

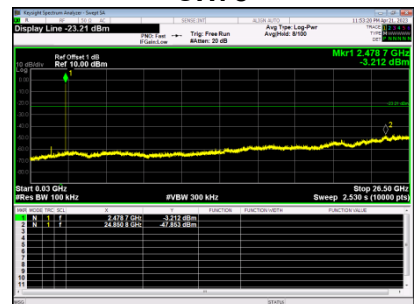

12 FREQUENCY STABILITY MEASUREMENT

12.1 LIMIT

RSS-Gen			
Section	Test Item	Limit	Frequency Range (MHz)
RSS-Gen 6.11	Frequency Stability	Specified in the user's manual	2402-2480

12.2 TEST PROCEDURE

- a. The EUT was directly connected to the spectrum analyzer and antenna output port as show in the block diagram below.
- b. Spectrum Setting:

Spectrum Parameter	Setting
Attenuation	Auto
Span Frequency	Entire absence of modulation emissions bandwidth
RBW	10 kHz
VBW	10kHz
Sweep Time	Auto

12.3 MEASUREMENT INSTRUMENTS LIST

Item	Kind of Equipment	Manufacturer	Type No.	Serial No.	Calibrated until
1	Spectrum analyzer	KEYSIGHT	N9010A	MY55150427	2023/05/26
2	Attenuator	Mini-Circuits	BW-S10W2	101109	N/A
3	RF Cable	Mi-cable	C10-01-01-1	100309	N/A
4	Temperature conditioning	Guan Jian.HTH1000	-20-130°C	GJ1000-10D001	N/A
5	DC Power Supply	G.KE	IPR-10010D	010931954	N/A

12.4 TEST SETUP

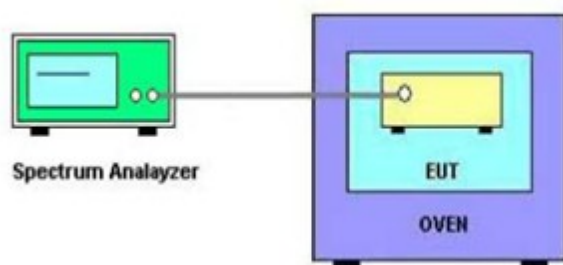

12.5 EUT OPERATION CONDITIONS

The EUT was programmed to be in continuously transmitting mode.

12.6 TEST RESULTS

	Temperature vs. Frequency Stability	
Voltage	Temperature	Measurement Frequency (MHz)
3.7V	(°C)	2402
	0	2401.954
	25	2401.954
	40	2401.954
2.9V	25	2401.954
Max. Deviation (MHz)		-0.046
Max. Deviation (ppm)		-19.15

Note:2.9V is the end point voltage, and products below 2.9V will cease working.

END OF TEST REPORT