

# FCC &ISED Radio Test Report

**FCC ID:X5B-500202**  
**IC:8814A-500202**

**The report concerns: Original Grant**

Report Reference No.....: 20EFCB04023 3081

Date Sample(s) Received.....: 2020-04-28

Date of Tested.....: 2020-04-28 to 2020-05-13

Date of issue.....: 2020-05-11

Testing Laboratory .....: DongGuan ShuoXin Electronic Technology Co., Ltd.  
Zone A, 1F, No. 6, XinGang Road YuanGang Street,  
Address .....: XinAn District, ChangAn Town, DongGuan City,  
GuangDong, China

Applicant's name .....: PERFORMANCE DESIGNED PRODUCTS, LLC

Address .....: 2300 West Empire Avenue Suite 600 Burbank CA  
91504

Manufacturer.....: PERFORMANCE DESIGNED PRODUCTS, LLC

Equipment.....: Faceoff Wireless Deluxe Controller for  
Nintendo Switch

Trade Mark .....: --

Model .....: 500-202

Ratings .....: I/P: DC 5V By USB Charged  
DC 3.7V Li-ion Battery

Responsible Engineer :

*Smile Wang*  
Smile Wang

Authorized Signatory:

*King Wang*  
King Wang

<b>Table of Contents</b>	<b>Page</b>
<b>1 . TEST REPORT DECLARE</b>	<b>5</b>
<b>2 . SUMMARY OF TEST RESULTS</b>	<b>6</b>
2.1 MEASUREMENT UNCERTAINTY	7
<b>3 . GENERAL INFORMATION</b>	<b>8</b>
3.1 GENERAL DESCRIPTION OF EUT	8
3.2 DESCRIPTION OF TEST MODES	10
3.3 PARAMETERS OF TEST SOFTWARE	11
3.4 BLOCK DIAGRAM SHOWING THE CONFIGURATION OF SYSTEM TESTED	11
3.5 SUPPORT UNITS	11
3.6 TEST ENVIRONMENT CONDITIONS	12
<b>4 . AC POWER LINE CONDUCTED EMISSIONS TEST</b>	<b>13</b>
4.1 LIMIT	13
4.2 TEST PROCEDURE	13
4.3 MEASUREMENT INSTRUMENTS LIST	13
4.4 TESTSETUP	14
4.5 EUT OPERATING CONDITIONS	14
4.6 TEST RESULTS	15
<b>5 . RADIATED EMISSION TEST</b>	<b>17</b>
5.1 LIMIT	17
5.2 TEST PROCEDURE AND SETTING	18
5.3 MEASUREMENT INSTRUMENTS LIST	19
5.4 TESTSETUP	19
5.5 EUT OPERATING CONDITIONS	20
5.6 TEST RESULTS - 9 KHZ TO 30MHZ	21
5.7 TEST RESULTS- 30 MHZ TO 1000MHZ	22
5.8 TEST RESULTS - ABOVE 1000MHZ(BAND EDGE)	24
5.9 TEST RESULTS - ABOVE 1000MHZ(HARMONIC)	32
<b>6 . NUMBER OF HOPPING FREQUENCY</b>	<b>44</b>
6.1 LIMIT	44
6.2 TEST PROCEDURE AND SETTING	44
6.3 MEASUREMENT INSTRUMENTS LIST	44
6.4 TEST SETUP	44

<b>Table of Contents</b>	<b>Page</b>
6.5 EUT OPERATION CONDITIONS	44
6.6 TEST RESULTS	45
<b>7 . AVERAGE TIME OF OCCUPANCY</b>	<b>46</b>
7.1 LIMIT	46
7.2 TEST PROCEDURE AND SETTING	46
7.3 MEASUREMENT INSTRUMENTS LIST	46
7.4 TEST SETUP	46
7.5 EUT OPERATION CONDITIONS	46
7.6 TEST RESULTS	47
<b>8 . HOPPING CHANNEL SEPARATION MEASUREMENT</b>	<b>49</b>
8.1 LIMIT	49
8.2 TEST PROCEDURE AND SETTING	49
8.3 MEASUREMENT INSTRUMENTS LIST	49
8.4 TEST SETUP	49
8.5 EUT OPERATION CONDITIONS	49
8.6 TEST RESULTS	50
<b>9 . BANDWIDTH TEST</b>	<b>52</b>
9.1 LIMIT	52
9.2 TEST PROCEDURE AND SETTING	52
9.3 MEASUREMENT INSTRUMENTS LIST	52
9.4 TEST SETUP	52
9.5 EUT OPERATION CONDITIONS	52
9.6 TEST RESULTS	53
<b>10 . MAXIMUM OUTPUT POWER</b>	<b>55</b>
10.1 LIMIT	55
10.2 TEST PROCEDURE AND SETTING	55
10.3 MEASUREMENT INSTRUMENTS LIST	55
10.4 TEST SETUP	55
10.5 EUT OPERATION CONDITIONS	55
10.6 TEST RESULTS	56
<b>11 . CONDUCTED SPURIOUS EMISSION</b>	<b>59</b>
11.1 LIMIT	59
11.2 TEST PROCEDURE AND SETTING	59
11.3 MEASUREMENT INSTRUMENTS LIST	59

<b>Table of Contents</b>	<b>Page</b>
<b>11.4 TEST SETUP</b>	<b>59</b>
<b>11.5 EUT OPERATION CONDITIONS</b>	<b>59</b>
<b>11.6 TEST RESULTS</b>	<b>60</b>
<b>12 . FREQUENCY STABILITY MEASUREMENT</b>	<b>62</b>
<b>12.1 LIMIT</b>	<b>62</b>
<b>12.2 TEST PROCEDURE</b>	<b>62</b>
<b>12.3 MEASUREMENT INSTRUMENTS LIST</b>	<b>62</b>
<b>12.4 TEST SETUP</b>	<b>62</b>
<b>12.5 EUT OPERATION CONDITIONS</b>	<b>62</b>
<b>12.6 TEST RESULTS</b>	<b>63</b>

## 1. TEST REPORT DECLARE

Applicant	PERFORMANCE DESIGNED PRODUCTS, LLC
Address	2300 West Empire Avenue Suite 600 Burbank CA 91504
Manufacturer	PERFORMANCE DESIGNED PRODUCTS, LLC
Address	2300 West Empire Avenue Suite 600 Burbank CA 91504
Factory	PERFORMANCE DESIGNED PRODUCTS, LLC
Address	2300 West Empire Avenue Suite 600 Burbank CA 91504
Equipment	Faceoff Wireless Deluxe Controller for Nintendo Switch
Model No.	500-202
Trade Mark	--
Standard	FCC Part15, Subpart C (15.247) RSS-247 Issue 2, Feb. 2017 RSS-Gen Issue 5, March 2019 ANSI C63.10-2013

### We Declare:

The equipment described above is tested by DongGuanShuoXin Electronic Technology Co., Ltd. and in the configuration tested the equipment complied with the standards specified above. The test results are contained in this test report and DongGuanShuoXin Electronic Technology Co., Ltd. is assumed of full responsibility for the accuracy and completeness of these tests.

## 2. SUMMARY OF TEST RESULTS

The EUT have been tested according to the applicable standards as referenced below:

Standard(s) Section		Test Item	Judgment	Remark
FCC	ISED			
15.207	RSS-Gen 8.8	AC Power Line Conducted Emissions	PASS	-----
15.247(d) 15.205(a) 15.209(a)	RSS-247 5.5 RSS-Gen 8.9 RSS-Gen 8.10	Radiated Emission	PASS	-----
15.247(a)(1)(iii)	RSS-247 5.1 (d)	Number of Hopping Frequency	PASS	-----
15.247(a)(1)(iii)	RSS-247 5.1 (d)	Average Time Of Occupancy	PASS	-----
15.247(a)(1)	RSS-247 5.1 (b)	Hopping Channel Separation	PASS	-----
15.247(a)(1)	RSS-247 5.1 (a) RSS-Gen 6.7	Bandwidth	PASS	-----
15.247(b)(1)	RSS-247 5.1 (b)	Maximum Output Power	PASS	-----
15.247(d)	RSS-247 5.5	Conducted Spurious Emission	PASS	-----
-	RSS-Gen 6.11	Frequency Stability	PASS	-----
15.203	-	Antenna Requirement	PASS	Note(2)

Note:

- (1) "N/A" denotes test is not applicable in this test report
- (2) The device what use a permanently attached antenna were considered sufficient to comply with the provisions of 15.203.

**2.1 MEASUREMENT UNCERTAINTY**

Test Item	Uncertainty
Uncertainty for Conduction emission test (9kHz-150kHz)	3.7 dB
Uncertainty for Conduction emission test (150kHz-30MHz)	3.3 dB
Uncertainty for Radiation Emission test (30MHz-200MHz)	4.60 dB (Polarize: V)
	4.60 dB (Polarize: H)
Uncertainty for Radiation Emission test (200MHz-1GHz)	6.10 dB (Polarize: V)
	5.08 dB (Polarize: H)
Uncertainty for Radiation Emission test (1GHz-6GHz)	5.01 dB (Polarize: V)
	5.01 dB (Polarize: H)
Uncertainty for Radiation Emission test (6GHz-18GHz)	5.26 dB (Polarize: V)
	5.26 dB (Polarize: H)
Uncertainty for Radiation Emission test (18GHz-40GHz)	5.06 dB (Polarize: V)
	5.06 dB (Polarize: H)
Uncertainty for radio frequency	±0.048kHz
Uncertainty for conducted RF Power	±0.32dB

**Note:**

This uncertainty represents an expanded uncertainty expressed at approximately the 95% confidence level using a coverage factor of k=2.

### 3. GENERAL INFORMATION

#### 3.1 GENERAL DESCRIPTION OF EUT

Equipment	Faceoff Wireless Deluxe Controller for Nintendo Switch	
Brand Name	--	
Test Model	500-202	
Series Model	N/A	
Model Difference(s)	N/A	
Hardware Version	V1.0	
Software Version	V1.0	
PowerSource	Supplied from USB.	
Power Rating	DC 5V By USB Charged, DC 3.7V Li-ion Battery	
Operation Frequency	2402 MHz ~ 2480 MHz	
Modulation Technology	GFSK, $\pi/4$ -DQPSK, 8-DPSK	
Bit Rate of Transmitter	1Mbps /2Mbps /3Mbps	
Antenna Information	Antenna Type: PCB	Maximum Peak Gain:1.6dBi
Max. Output Power	1Mbps: 0.342dBm (0.001082W) 2Mbps: -0.809dBm (0.000830W) 3Mbps: -0.702dBm (0.000851W)	

Note:

1. For a more detailed features description, please refer to the manufacturer’s specifications or the user’s manual.



## 2. Channel List:

Channel	Frequency (MHz)	Channel	Frequency (MHz)	Channel	Frequency (MHz)
00	2402	27	2429	54	2456
01	2403	28	2430	55	2457
02	2404	29	2431	56	2458
03	2405	30	2432	57	2459
04	2406	31	2433	58	2460
05	2407	32	2434	59	2461
06	2408	33	2435	60	2462
07	2409	34	2436	61	2463
08	2410	35	2437	62	2464
09	2411	36	2438	63	2465
10	2412	37	2439	64	2466
11	2413	38	2440	65	2467
12	2414	39	2441	66	2468
13	2415	40	2442	67	2469
14	2416	41	2443	68	2470
15	2417	42	2444	69	2471
16	2418	43	2445	70	2472
17	2419	44	2446	71	2473
18	2420	45	2447	72	2474
19	2421	46	2448	73	2475
20	2422	47	2449	74	2476
21	2423	48	2450	75	2477
22	2424	49	2451	76	2478
23	2425	50	2452	77	2479
24	2426	51	2453	78	2480
25	2427	52	2454		
26	2428	53	2455		

### 3.2 DESCRIPTION OF TEST MODES

The test system was pre-tested based on the consideration of all possible combinations of EUT operation mode.

Prefest Mode	Description
Mode 1	TX Mode <b>NOTE (1)</b>
Mode 2	TX Mode Channel 78 _1Mbps

Following mode(s) was (were) found to be the worst case(s) and selected for the final test.

<b>AC power line conducted emissions test</b>	
Final Test Mode	Description
Mode 2	TX Mode Channel 78 _1Mbps

<b>Radiated emissions test - Below 1GHz</b>	
Final Test Mode	Description
Mode 2	TX Mode Channel 78 _1Mbps

<b>Radiated emissions test - Above 1GHz</b>	
Final Test Mode	Description
Mode 1	TX Mode <b>NOTE (1)</b>

<b>Conducted test</b>	
Final Test Mode	Description
Mode 1	TX Mode <b>NOTE (1)</b>

Note:

- (1) The measurements are performed at the high, middle, low available channels.
- (2) The measurements for Hopping Channel Separation, Bandwidth and Maximum Output Power were tested during 1Mbps, 2Mbps and 3Mbps, the worst case are 1Mbps and 3Mbps, only worst case was documented.

**3.3 PARAMETERS OF TEST SOFTWARE**

During testing, channel & power controlling software provided by the customer was used to control the operating channel as well as the output power level. The RF output power selection is for the setting of RF output power expected by the customer and is going to be fixed on the firmware of the final end product power parameters of FHSS

Test Software	cybluetool_ 0.1.55.1		
Frequency (MHz)	2402	2441	2480
Parameters(1Mbps)	Default	Default	Default
Parameters(2Mbps)	Default	Default	Default
Parameters(3Mbps)	Default	Default	Default

**3.4 BLOCK DIAGRAM SHOWING THE CONFIGURATION OF SYSTEM TESTED**

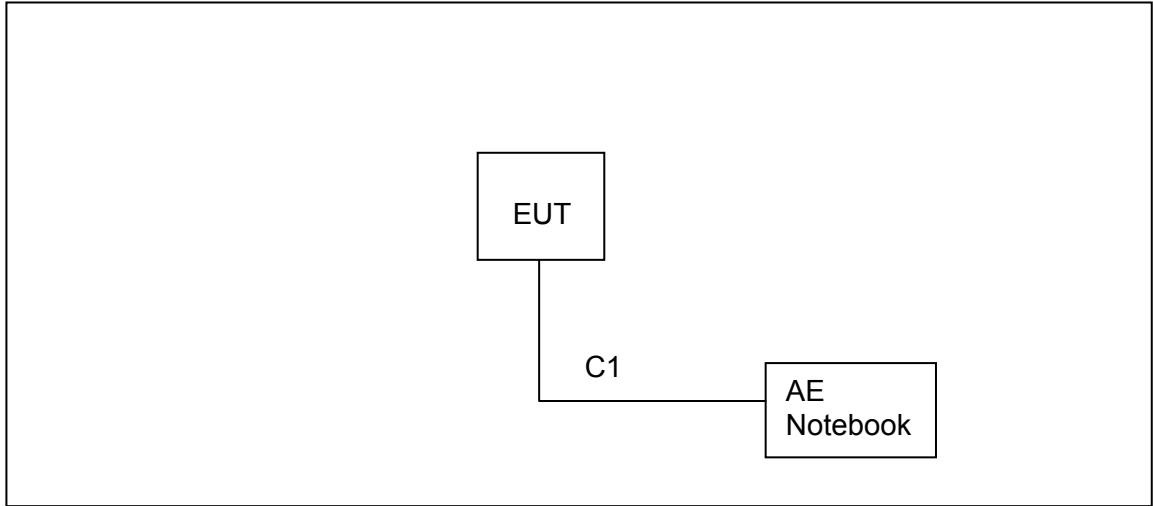

**3.5 SUPPORT UNITS**

Item	Equipment	Brand	Model No.	Series No.
AE	Notebook	ACER	MS2367	32807810766

Item	Cable Type	Shielded Type	Ferrite Core	Length
C1	DC Cable	NO	NO	0.8m

**3.6 TEST ENVIRONMENT CONDITIONS**

Test Item	Temperature	Humidity	Test Voltage
AC Power Line Conducted Emissions	25°C	53%	DC 3.7V
Radiated Emissions-9K-30MHz	25°C	60%	DC 3.7V
Radiated Emissions-30 MHz to 1GHz	24°C	68%	DC 3.7V
Radiated Emissions-Above 1000 MHz	24°C	68%	DC 3.7V
Number of Hopping Frequency	24.8°C	40.9%	DC 3.7V
Average Time Of Occupancy	24.8°C	40.9%	DC 3.7V
Hopping Channel Separation	24.8°C	40.9%	DC 3.7V
Bandwidth	24.8°C	40.9%	DC 3.7V
Maximum Output Power	24.8°C	40.9%	DC 3.7V
Conducted Spurious Emission	24.8°C	40.9%	DC 3.7V

#### 4. AC POWER LINE CONDUCTED EMISSIONS TEST

##### 4.1 LIMIT

Frequency of Emission (MHz)	Limit (dB $\mu$ V)	
	Quasi-peak	Average
0.15 - 0.50	66 to 56*	56 to 46*
0.50 - 5.0	56	46
5.0 - 30.0	60	50

Note:

- (1) The tighter limit applies at the band edges.
- (2) The limit of " \* " marked band means the limitation decreases linearly with the logarithm of the frequency in the range.

The following table is the setting of the receiver

Receiver Parameters	Setting
Attenuation	10 dB
Start Frequency	0.15 MHz
Stop Frequency	30 MHz
IF Bandwidth	9 kHz

##### 4.2 TEST PROCEDURE

- a. The EUT was placed 0.8 meters from the horizontal ground plane with EUT being connected to the power mains through a line impedance stabilization network (LISN). All other support equipment powered from additional LISN(s). The LISN provide 50 Ohm/ 50uH of coupling impedance for the measuring instrument.
- b. Interconnecting cables that hang closer than 40 cm to the groundplane shall be folded back and forth in the center forming a bundle 30 to 40 cm long.
- c. I/O cables that are not connected to a peripheral shall be bundled in the center. The end of the cable may be terminated, if required, using the correct terminating impedance. The overall length shall not exceed 1 m.
- d. LISN at least 80 cm from nearest part of EUT chassis.

##### 4.3 MEASUREMENT INSTRUMENTS LIST

Item	Kind of Equipment	Manufacturer	Type No.	Serial No.	Calibrated until
1	Pulse Limiter	MTS-systemtechnik	MTS-IMP-136	261115-010-0024	12/11/2020
2	EMI Test Receiver	R&S	ESCI	101308	12/11/2020
3	LISN	AFJ	LS16	16011103219	06/09/2020
4	LISN	Schwarzbeck	NSLK 8127	8127-432	12/11/2020
5	Measurement Software	Farad	EZ-EMC (Ver.ATT-03A)	N/A	N/A

#### 4.4 TESTSETUP

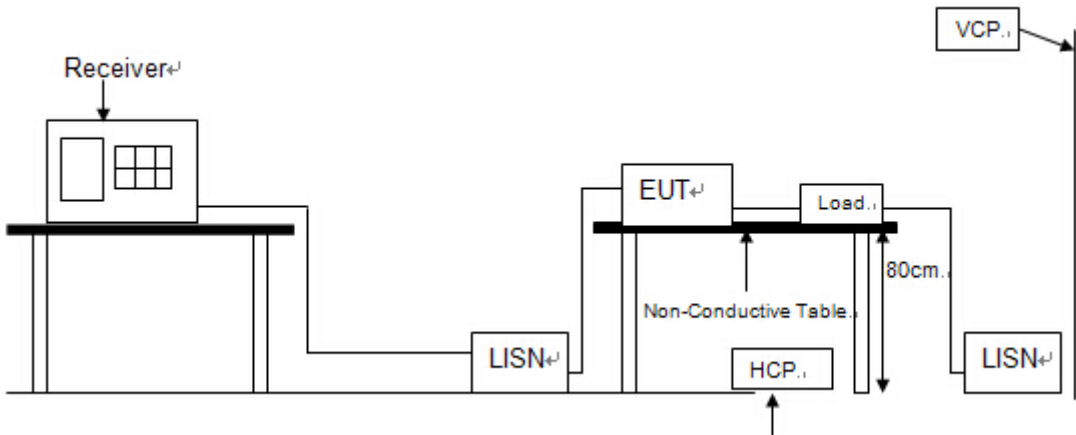

#### 4.5 EUT OPERATING CONDITIONS

The EUT was configured for testing in a typical function (as a customer would normally use it), EUT was programmed to be in continuously transmitting data or hopping on mode.

### 4.6 TEST RESULTS

Test Mode: TX Mode Channel 78 \_1Mbps

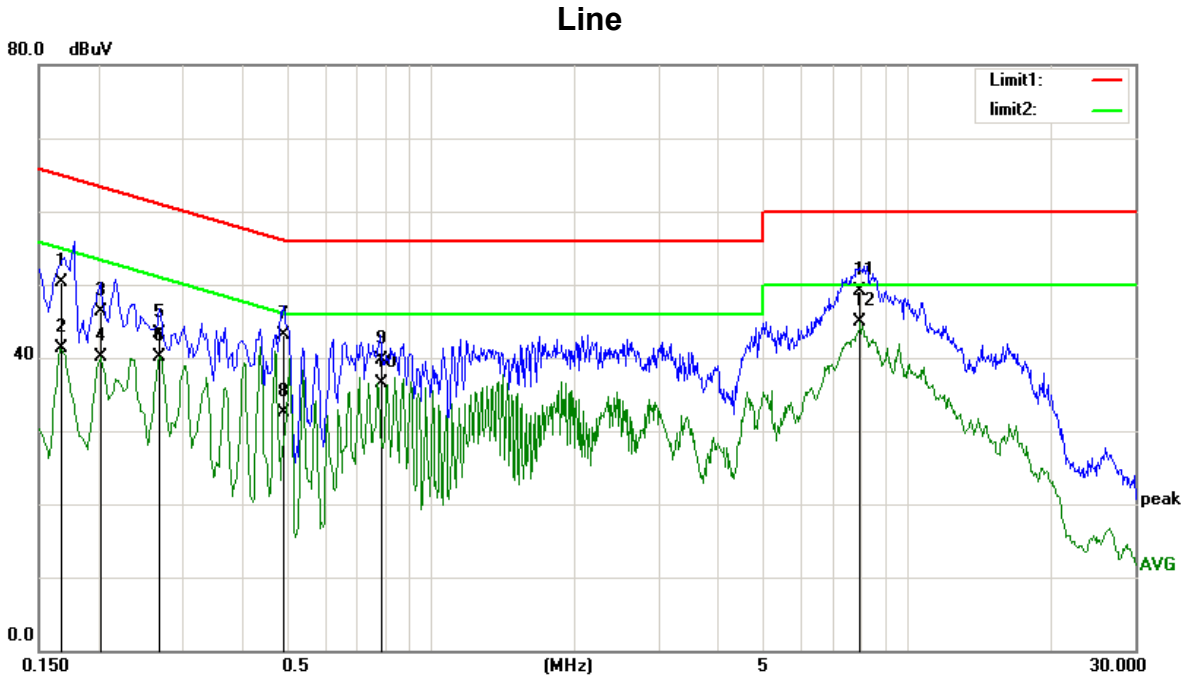

No.	Frequency (MHz)	Reading (dBuV)	Correct Factor(dB)	Result (dBuV)	Limit (dBuV)	Margin (dB)	Remark
1	0.1666	38.99	11.35	50.34	65.12	-14.78	QP
2	0.1666	29.97	11.35	41.32	55.12	-13.80	AVG
3	0.2020	35.12	11.11	46.23	63.52	-17.29	QP
4	0.2020	29.07	11.11	40.18	53.52	-13.34	AVG
5	0.2700	32.59	10.64	43.23	61.12	-17.89	QP
6	0.2700	29.50	10.64	40.14	51.12	-10.98	AVG
7	0.4900	32.83	10.19	43.02	56.17	-13.15	QP
8	0.4900	22.37	10.19	32.56	46.17	-13.61	AVG
9	0.7900	29.59	10.09	39.68	56.00	-16.32	QP
10	0.7900	26.41	10.09	36.50	46.00	-9.50	AVG
11	7.9499	38.89	10.13	49.02	60.00	-10.98	QP
12	7.9499	34.80	10.13	44.93	50.00	-5.07	AVG

Remarks:

- (1) Measurement Value = Reading Level + Correct Factor.
- (2) Margin Level = Measurement Value - Limit Value.
- (3) AC120V 60Hz

Test Mode: TX Mode Channel 78 \_1Mbps

**Neutral**

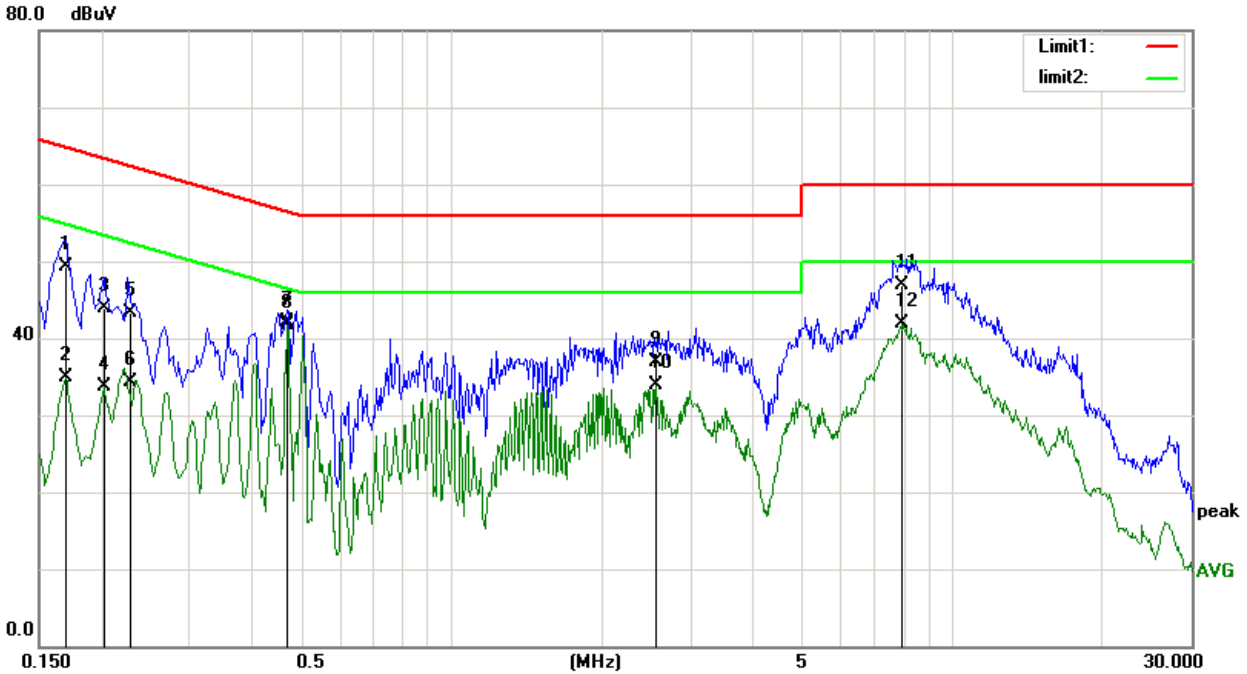

No.	Frequency (MHz)	Reading (dBuV)	Correct Factor(dB)	Result (dBuV)	Limit (dBuV)	Margin (dB)	Remark
1	0.1700	37.90	11.33	49.23	64.96	-15.73	QP
2	0.1700	23.54	11.33	34.87	54.96	-20.09	AVG
3	0.2020	32.85	11.11	43.96	63.52	-19.56	QP
4	0.2020	22.51	11.11	33.62	53.52	-19.90	AVG
5	0.2280	32.33	10.93	43.26	62.52	-19.26	QP
6	0.2280	23.33	10.93	34.26	52.52	-18.26	AVG
7	0.4700	31.81	10.22	42.03	56.51	-14.48	QP
8	0.4700	31.42	10.22	41.64	46.51	-4.87	AVG
9	2.5579	26.72	10.13	36.85	56.00	-19.15	QP
10	2.5579	23.77	10.13	33.90	46.00	-12.10	AVG
11	7.9139	36.85	10.13	46.98	60.00	-13.02	QP
12	7.9139	31.76	10.13	41.89	50.00	-8.11	AVG

**Remarks:**

- (1) Measurement Value = Reading Level + Correct Factor.
- (2) Margin Level = Measurement Value - Limit Value.
- (3) AC120V 60Hz



## 5. RADIATED EMISSION TEST

### 5.1 LIMIT

In case the emission fall within the restricted band specified on 15.205(a) & RSS-Gen 8.10, then the 15.209(a) & RSS-Gen 8.9 limit in the table below has to be followed.

#### LIMITS OF RADIATED EMISSION MEASUREMENT (9 kHz-1000MHz)

Frequency (MHz)	Field Strength (microvolts/meter)	Measurement Distance (meters)
0.009-0.490	2400/F(kHz)	300
0.490-1.705	24000/F(kHz)	30
1.705-30.0	30	30
30-88	100	3
88-216	150	3
216-960	200	3
Above 960	500	3

#### LIMITS OF RADIATED EMISSION MEASUREMENT (9 kHz-30 MHz)

Frequency (MHz)	Magnetic field strength (H-Field) (μA/m)	Measurement Distance (meters)
0.009-0.490	6.37/F(kHz)	300
0.490-1.705	6.37/F(kHz)	30
1.705-30.0	0.08	30

#### LIMITS OF RADIATED EMISSION MEASUREMENT (30 MHz-1000MHz)

Frequency (MHz)	Field Strength (μV/m at 3m)
30-88	100
88-216	150
216-960	200
Above 960	500

#### LIMITS OF RADIATED EMISSION MEASUREMENT (Above 1000MHz)

Frequency (MHz)	(dBuV/m at 3 m)	
	Peak	Average
Above 1000	74	54

**Note:**

- (1) The limit for radiated test was performed according to FCC PART 15C and RSS-247.
- (2) The tighter limit applies at the band edges.
- (3) Emission level (dBuV/m)=20log Emission level (uV/m).

**5.2 TEST PROCEDURE AND SETTING**

- a. The measuring distance of 3 m shall be used for measurements. The EUT was placed on the top of a rotating table 0.8 meter above the ground at a 3 meter semi-anechoic chamber. The table was rotated 360 degrees to determine the position of the highest radiation.(below 1GHz)
- b. The measuring distance of 3 m shall be used for measurements. The EUT was placed on the top of a rotating table 1.5 meter above the ground at a 3 meter semi-anechoic chamber. The table was rotated 360 degrees to determine the position of the highest radiation.(above 1GHz)
- c. The height of the equipment or of the substitution antenna shall be 0.8m or 1.5m; the height of the test antenna shall vary between 1 m to 4 m. Both horizontal and vertical polarizations of the antenna are set to make the measurement.
- d. For each suspected emission, the EUT was arranged to its worst case and then the antenna was tuned to heights find the maximum reading (used Bore sight function).
- e. The receiver system was set to peak and average detect function and specified bandwidth with maximum hold mode when the test frequency is above 1GHz.
- f. The initial step in collecting radiated emission data is a receiver peak detector mode pre-scanning the measurement frequency range. Significant peaks are then marked and then Quasi Peak detector mode re-measured.
- g. All readings are Peak unless otherwise stated QP in column of Note. Peak denotes that the Peak reading compliance with the QP Limits and then QP Mode measurement didn't perform. (below 1GHz)
- h. All readings are Peak Mode value unless otherwise stated AVG in column of Note. If the Peak Mode Measured value compliance with the Peak Limits and lower than AVG Limits, the EUT shall be deemed to meet both Peak & AVG Limits and then only Peak Mode was measured, but AVG Mode didn't perform. (above 1GHz)
- i. The test result is calculated as the following:
  - (1) Result = Reading + Correct Factor
  - (2) Correct Factor = Antenna Factor + Cable Loss – Amplifier Gain + Attenuator
  - (3) Margin = Result - Limit

Spectrum Parameter	Setting
Attenuation	Auto
Start Frequency	1000 MHz
Stop Frequency	10th carrier harmonic
RBW / VBW (Emission in restricted band)	RBW 1MHz VBW 3MHz peak detector for Pk value RMS detector for AV value

Receiver Parameter	Setting
Attenuation	Auto
Start ~ Stop Frequency	9 kHz~90 kHz for PK/AVG detector
Start ~ Stop Frequency	90 kHz~110 kHz for QP detector
Start ~ Stop Frequency	110 kHz~490 kHz for PK/AVG detector
Start ~ Stop Frequency	490 kHz~30 MHz for QP detector
Start ~ Stop Frequency	30MHz~1000MHz for QP detector

### 5.3 MEASUREMENT INSTRUMENTS LIST

Item	Equipment	Manufacturer	Model No.	Serial No.	Calibrated until
1	EMI Test Receiver	R&S	ESCI	101307	12/12/2020
2	Spectrum Analyzer	Agilent	E4407B	US40240708	11/17/2020
3	Loop antenna	SCHWARZBECK K	FMZB1519	1519-062	12/14/2020
4	Broadband antenna	SCHWARZBECK	VULB9168	VULB9168-192	03/22/2021
5	HORN ANTENNA	SCHWARZBECK	BBHA9120D	9120D 1065	04/21/2021
6	Preamplifier Amplifier	HP	8447F	3113A05680	12/11/2020
7	PRE-AMPLIFIER	CY	EMC011830	980136	12/11/2020
8	RF Cable	R&S	Test Cable 4	4	12/11/2020
9	RF Cable	R&S	Test Cable 5	5	12/11/2020
10	RF Cable	R&S	Test Cable 9	9	04/22/2021
11	RF Cable	R&S	Test Cable 10	10	12/11/2020
12	Measurement Software	Farad	EZ-EMC (Ver.ATT-03A)	N/A	N/A

### 5.4 TESTSETUP

#### 9 kHz-30 MHz

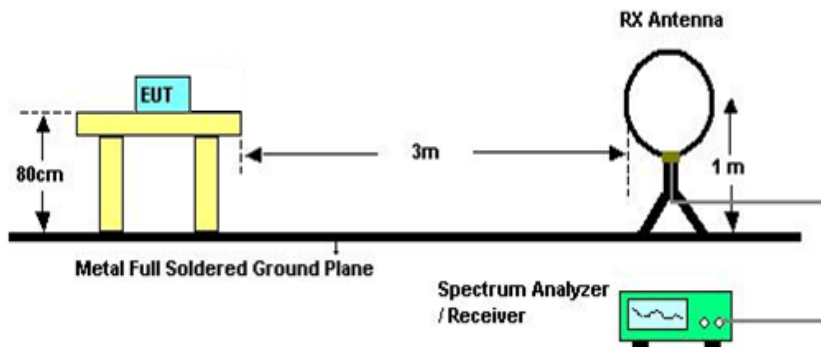

#### 30 MHz to 1 GHz

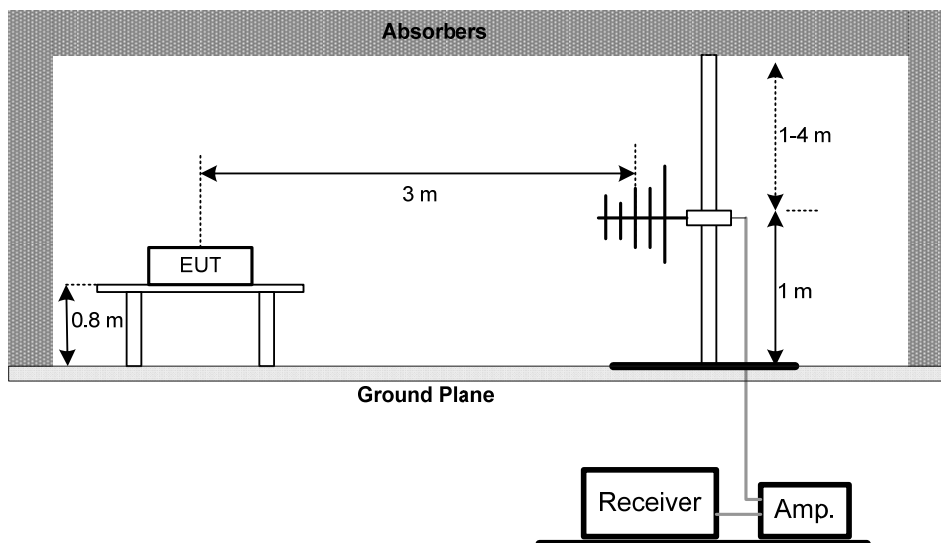

**Above 1 GHz**

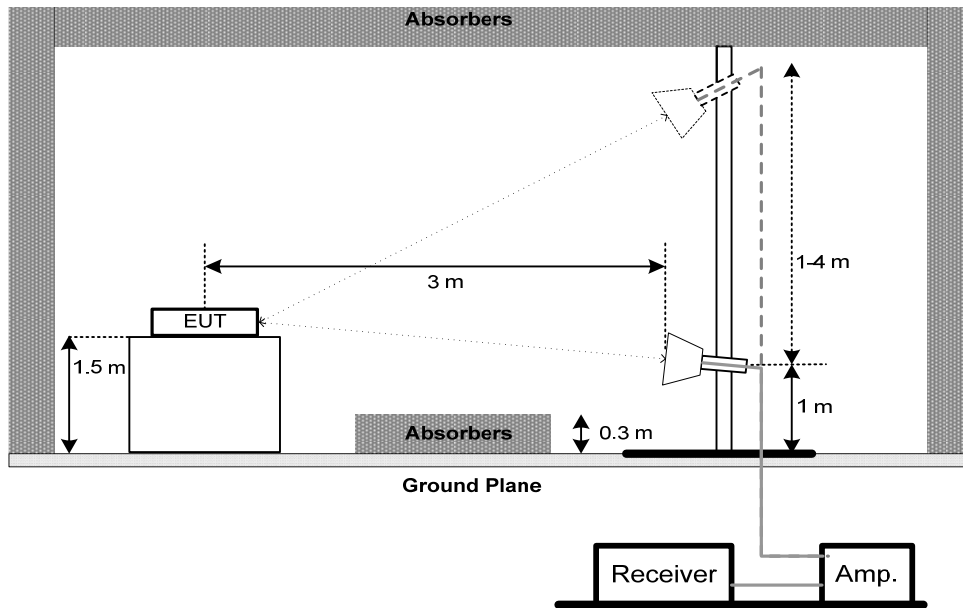

**5.5 EUT OPERATING CONDITIONS**

The EUT was programmed to be in continuously transmitting mode.

**5.6 TEST RESULTS - 9 kHz TO 30MHz**

Test Mode:	TX Mode Channel 78 _1Mbps
------------	---------------------------

Freq.	Reading	Limit	Margin	State
(MHz)	(dBuV/m)	(dBuV/m)	(dB)	P/F
--	--	--	--	P
--	--	--	--	P

**Note:**

The amplitude of spurious emissions which are attenuated by more than 20dB below the permissible value has no need to be reported.

Distance extrapolation factor =  $20 \log (\text{specific distance}/\text{test distance})(\text{dB})$ ;

Limit line = specific limits(dBuv) + distance extrapolation factor

**5.7 TEST RESULTS- 30 MHz TO 1000MHz**

Test Mode: TX Mode Channel 78 \_1Mbps

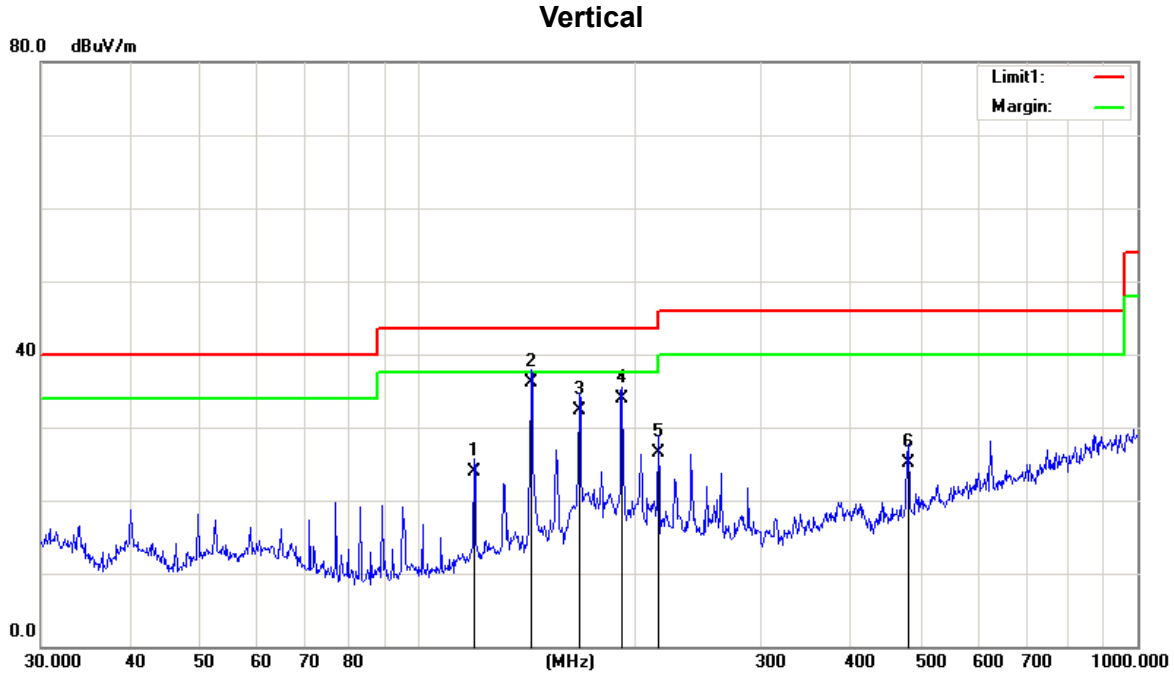

No.	Frequency (MHz)	Reading (dBuV/m)	Correct Factor(dB/m)	Result (dBuV/m)	Limit (dBuV/m)	Margin (dB)	Remark
1	119.8556	36.77	-12.89	23.88	43.50	-19.62	QP
2	143.8295	47.99	-11.97	36.02	43.50	-7.48	QP
3	167.8243	42.72	-10.48	32.24	43.50	-11.26	QP
4	192.4186	45.39	-11.53	33.86	43.50	-9.64	QP
5	216.0240	37.04	-10.58	26.46	46.00	-19.54	QP
6	480.5276	30.52	-5.46	25.06	46.00	-20.94	QP

Test Mode: TX Mode Channel 78 \_1Mbps

### Horizontal

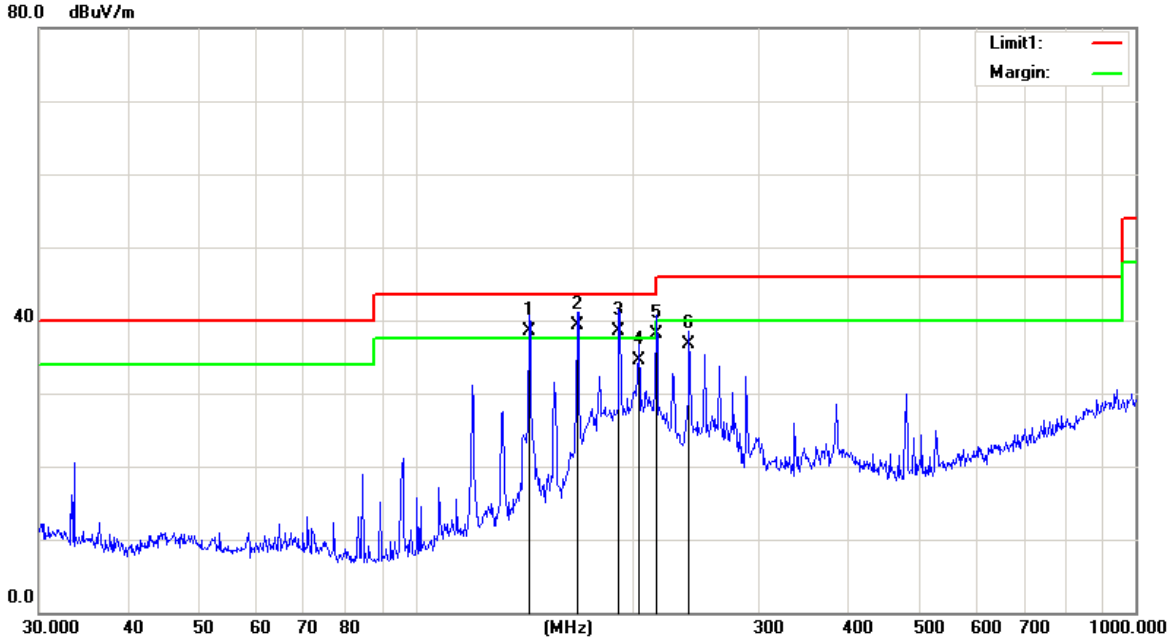

No.	Frequency (MHz)	Reading (dBuV/m)	Correct Factor(dB/m)	Result (dBuV/m)	Limit (dBuV/m)	Margin (dB)	Remark
1	143.8294	51.33	-12.73	38.60	43.50	-4.90	QP
2	167.8242	50.15	-10.91	39.24	43.50	-4.26	QP
3	191.7450	47.98	-9.49	38.49	43.50	-5.01	QP
4	204.2376	44.31	-9.76	34.55	43.50	-8.95	QP
5	216.0240	47.43	-9.38	38.05	46.00	-7.95	QP
6	239.9874	42.86	-6.20	36.66	46.00	-9.34	QP

**5.8 TEST RESULTS - ABOVE 1000MHz(BAND EDGE)**

Test Mode: TX 2402 MHz\_CH00\_1Mbps

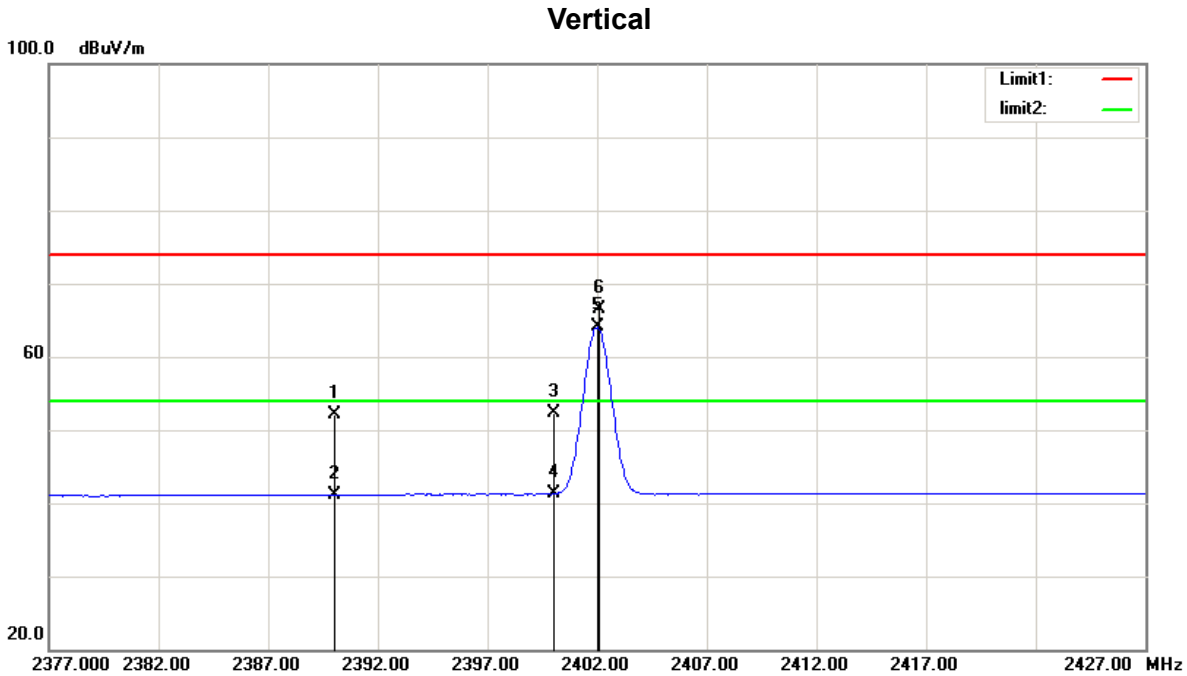

No.	Frequency (MHz)	Reading (dBuV/m)	Correct Factor(dB/m)	Result (dBuV/m)	Limit (dBuV/m)	Margin (dB)	Remark
1	2390.000	20.42	31.62	52.04	74.00	-21.96	peak
2	2390.000	9.54	31.62	41.16	54.00	-12.84	AVG
3	2400.000	20.64	31.64	52.28	74.00	-21.72	peak
4	2400.000	9.61	31.64	41.25	54.00	-12.75	AVG
5	2402.000	32.39	31.64	64.03	/	/	AVG
6	2402.100	34.94	31.64	66.58	/	/	peak



Test Mode: TX 2402 MHz\_CH00\_1Mbps

### Horizontal

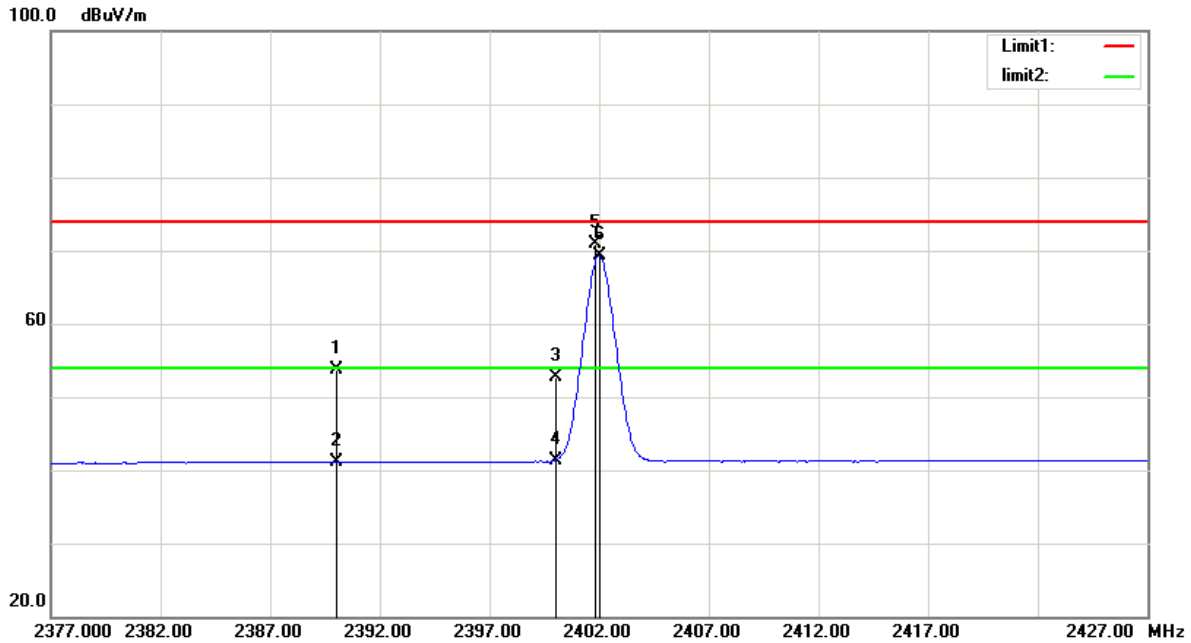

No.	Frequency (MHz)	Reading (dBuV/m)	Correct Factor(dB/m)	Result (dBuV/m)	Limit (dBuV/m)	Margin (dB)	Remark
1	2390.000	22.11	31.62	53.73	74.00	-20.27	peak
2	2390.000	9.50	31.62	41.12	54.00	-12.88	AVG
3	2400.000	21.08	31.64	52.72	74.00	-21.28	peak
4	2400.000	9.71	31.64	41.35	54.00	-12.65	AVG
5	2401.800	39.30	31.64	70.94	/	/	peak
6	2402.000	37.68	31.64	69.32	/	/	AVG

Test Mode: TX 2480 MHz\_CH78\_1Mbps

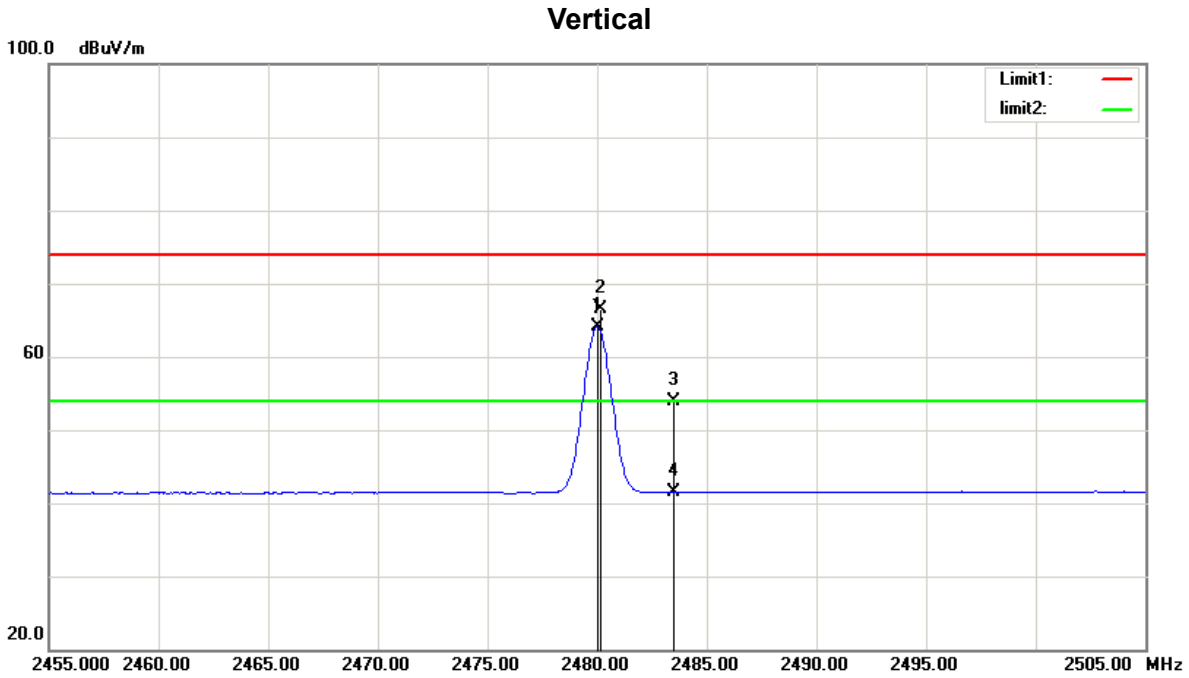

No.	Frequency (MHz)	Reading (dBuV/m)	Correct Factor(dB/m)	Result (dBuV/m)	Limit (dBuV/m)	Margin (dB)	Remark
1	2480.000	32.21	31.88	64.09	/	/	AVG
2	2480.200	34.61	31.88	66.49	/	/	peak
3	2483.500	21.94	31.89	53.83	74.00	-20.17	peak
4	2483.500	9.56	31.89	41.45	54.00	-12.55	AVG

Test Mode: TX 2480 MHz\_CH78\_1Mbps

### Horizontal

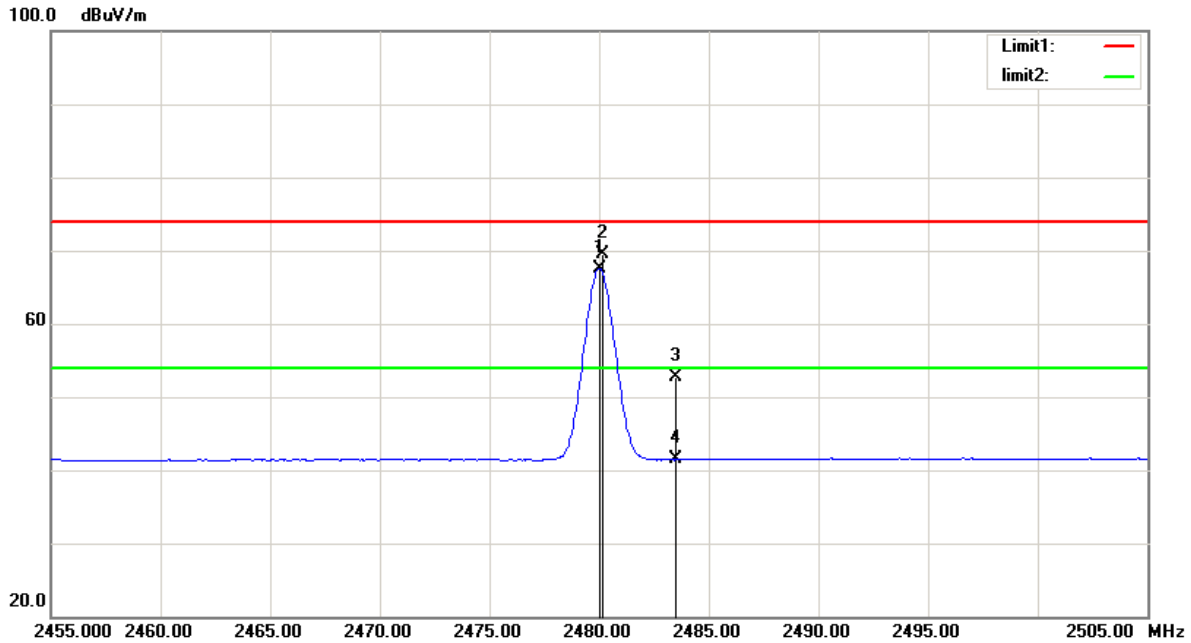

No.	Frequency (MHz)	Reading (dBuV/m)	Correct Factor(dB/m)	Result (dBuV/m)	Limit (dBuV/m)	Margin (dB)	Remark
1	2480.000	35.70	31.88	67.58	/	/	AVG
2	2480.200	37.67	31.88	69.55	/	/	peak
3	2483.500	20.78	31.89	52.67	74.00	-21.33	peak
4	2483.500	9.53	31.89	41.42	54.00	-12.58	AVG

Test Mode: TX 2402 MHz\_CH00\_3Mbps

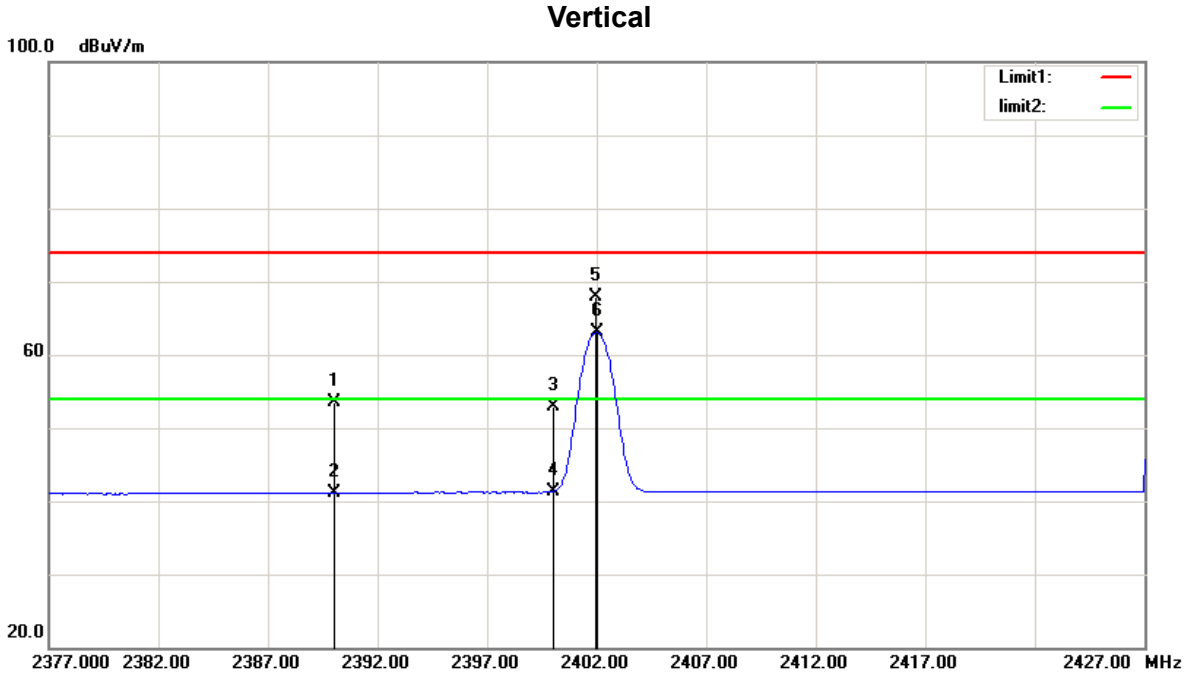

No.	Frequency (MHz)	Reading (dBuV/m)	Correct Factor(dB/m)	Result (dBuV/m)	Limit (dBuV/m)	Margin (dB)	Remark
1	2390.000	21.88	31.62	53.50	74.00	-20.50	peak
2	2390.000	9.56	31.62	41.18	54.00	-12.82	AVG
3	2400.000	21.33	31.64	52.97	74.00	-21.03	peak
4	2400.000	9.68	31.64	41.32	54.00	-12.68	AVG
5	2401.950	36.18	31.64	67.82	/	/	peak
6	2402.000	31.43	31.64	63.07	/	/	AVG

Test Mode: TX 2402 MHz\_CH00\_3Mbps

### Horizontal

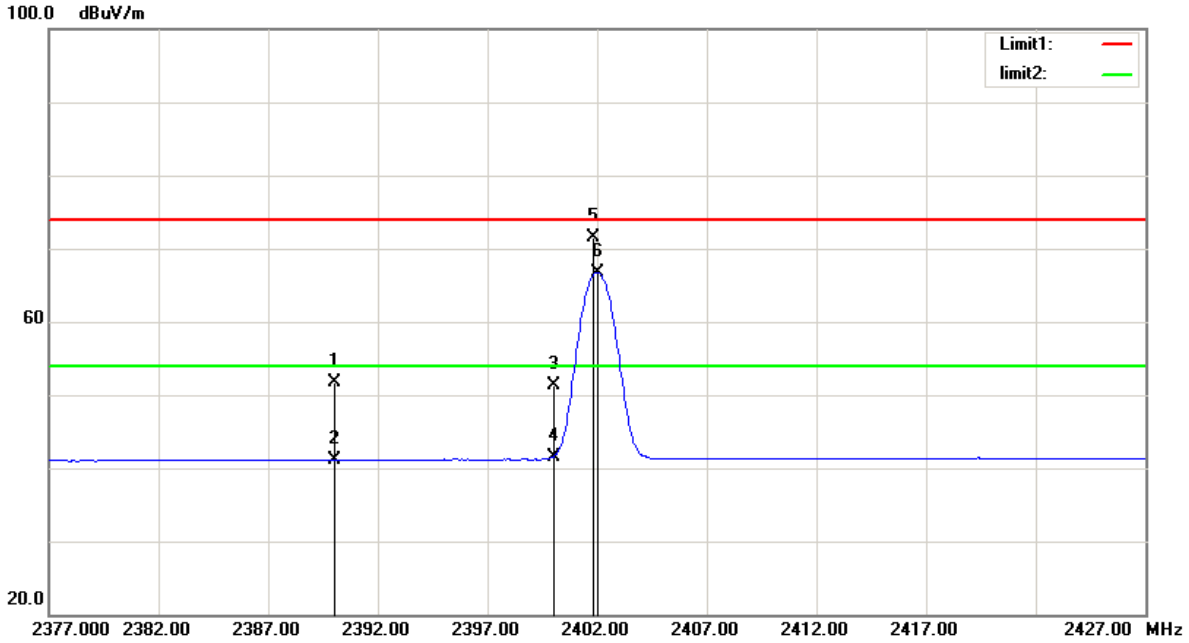

No.	Frequency (MHz)	Reading (dBuV/m)	Correct Factor(dB/m)	Result (dBuV/m)	Limit (dBuV/m)	Margin (dB)	Remark
1	2390.000	20.13	31.62	51.75	74.00	-22.25	peak
2	2390.000	9.48	31.62	41.10	54.00	-12.90	AVG
3	2400.000	19.60	31.64	51.24	74.00	-22.76	peak
4	2400.000	9.93	31.64	41.57	54.00	-12.43	AVG
5	2401.850	39.85	31.64	71.49	/	/	peak
6	2402.000	35.09	31.64	66.73	/	/	AVG

Test Mode: TX 2480 MHz\_CH78\_3Mbps

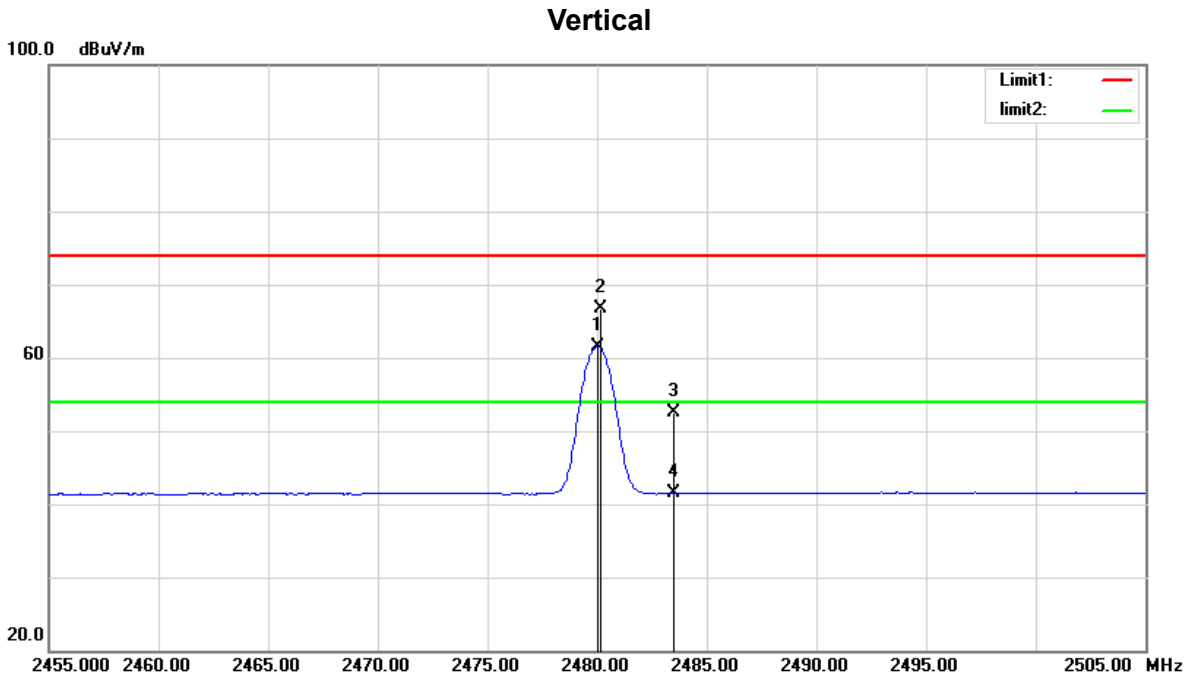

No.	Frequency (MHz)	Reading (dBuV/m)	Correct Factor(dB/m)	Result (dBuV/m)	Limit (dBuV/m)	Margin (dB)	Remark
1	2480.000	29.63	31.88	61.51	/	/	AVG
2	2480.200	34.77	31.88	66.65	/	/	peak
3	2483.500	20.60	31.89	52.49	74.00	-21.51	peak
4	2483.500	9.57	31.89	41.46	54.00	-12.54	AVG

Test Mode: TX 2480 MHz\_CH78\_3Mbps

### Horizontal

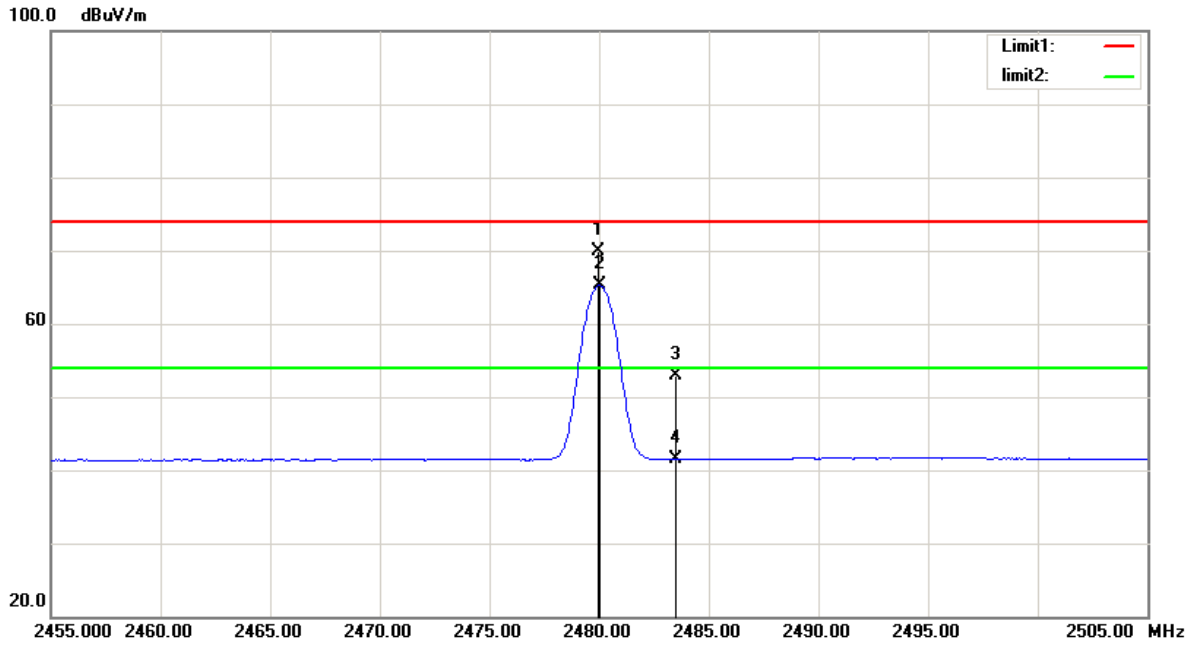

No.	Frequency (MHz)	Reading (dBuV/m)	Correct Factor(dB/m)	Result (dBuV/m)	Limit (dBuV/m)	Margin (dB)	Remark
1	2479.950	37.98	31.88	69.86	/	/	peak
2	2480.000	33.34	31.88	65.22	/	/	AVG
3	2483.500	21.01	31.89	52.90	74.00	-21.10	peak
4	2483.500	9.55	31.89	41.44	54.00	-12.56	AVG

**5.9 TEST RESULTS - ABOVE 1000MHz(HARMONIC)**

Test Mode: TX 2402 MHz\_CH00\_1Mbps

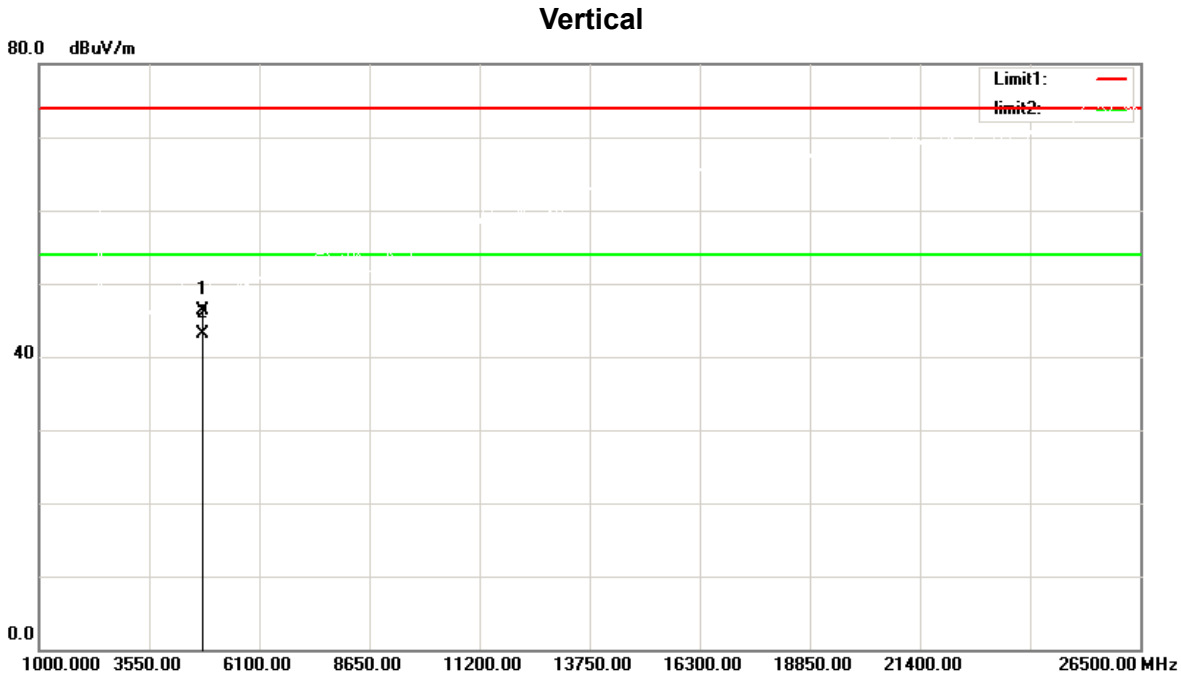

No.	Frequency (MHz)	Reading (dBuV/m)	Correct Factor(dB/m)	Result (dBuV/m)	Limit (dBuV/m)	Margin (dB)	Remark
1	4804.000	49.70	-3.33	46.37	74.00	-27.63	peak
2	4804.000	46.35	-3.33	43.02	54.00	-10.98	AVG



Test Mode: TX 2402 MHz\_CH00\_1Mbps

### Horizontal

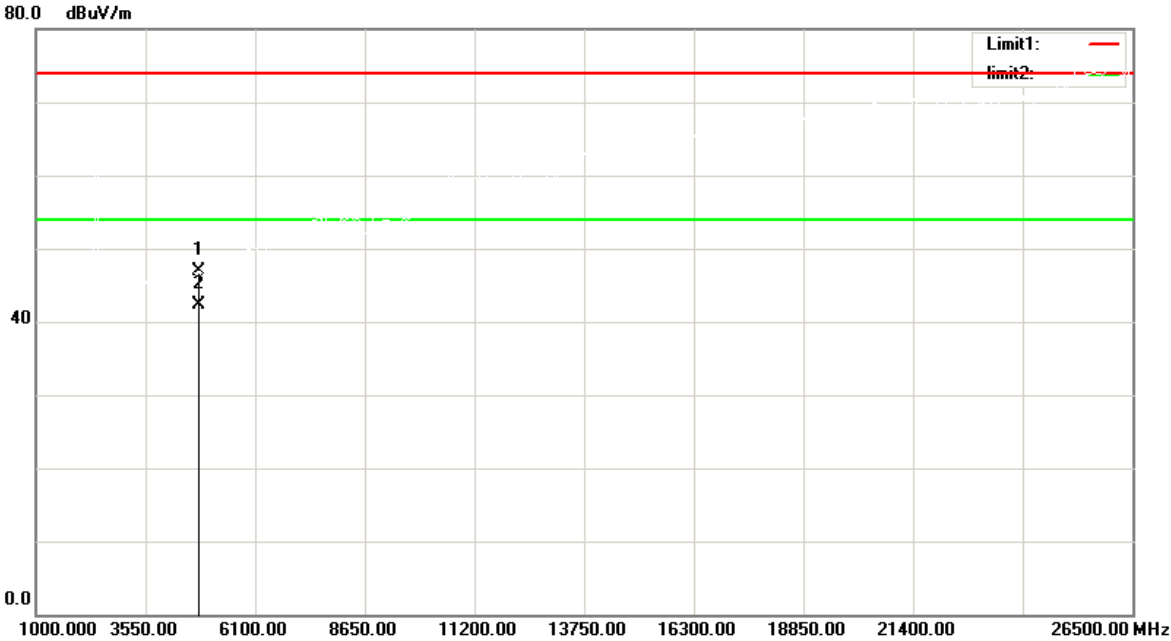

No.	Frequency (MHz)	Reading (dBuV/m)	Correct Factor(dB/m)	Result (dBuV/m)	Limit (dBuV/m)	Margin (dB)	Remark
1	4804.000	50.31	-3.33	46.98	74.00	-27.02	peak
2	4804.000	45.68	-3.33	42.35	74.00	-31.65	peak

Test Mode: TX 2441 MHz\_CH39\_1Mbps

### Vertical

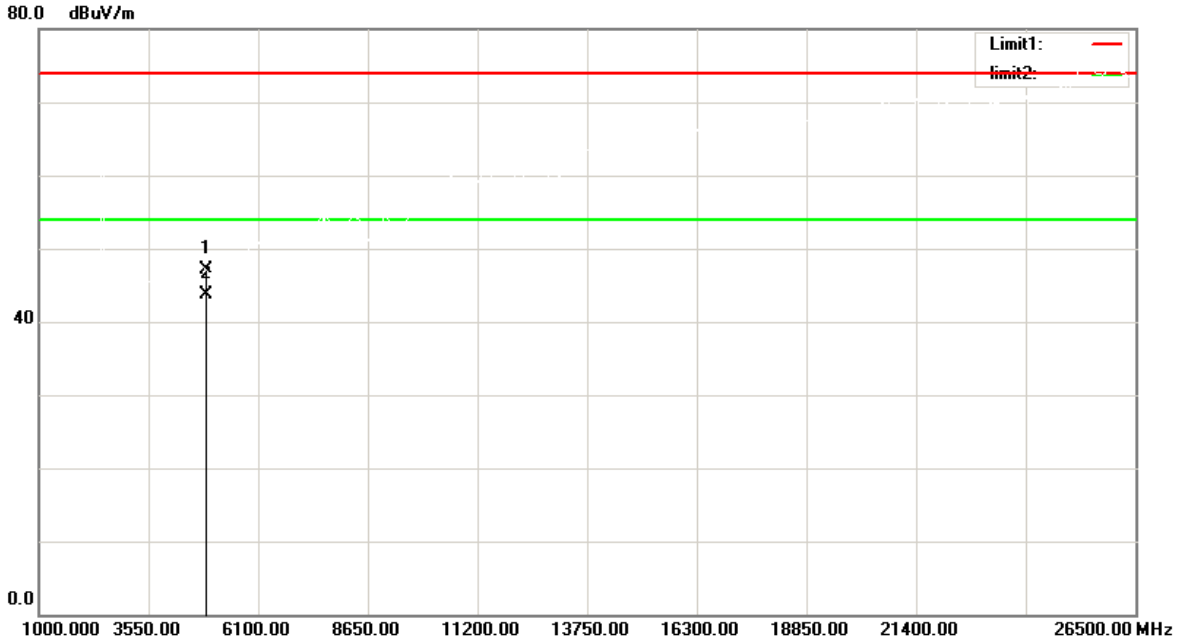

No.	Frequency (MHz)	Reading (dBuV/m)	Correct Factor(dB/m)	Result (dBuV/m)	Limit (dBuV/m)	Margin (dB)	Remark
1	4882.100	50.16	-3.03	47.13	74.00	-26.87	peak
2	4882.100	46.72	-3.03	43.69	54.00	-10.31	AVG

Test Mode: TX 2441 MHz\_CH39\_1Mbps

### Horizontal

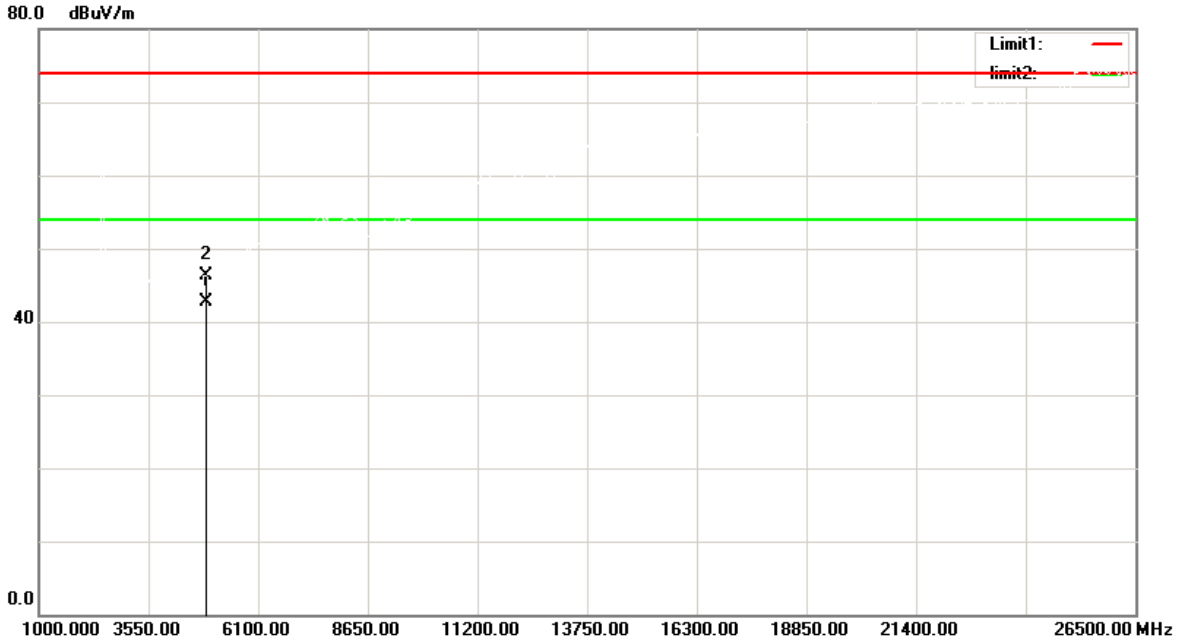

No.	Frequency (MHz)	Reading (dBuV/m)	Correct Factor(dB/m)	Result (dBuV/m)	Limit (dBuV/m)	Margin (dB)	Remark
1	4882.000	45.70	-3.03	42.67	54.00	-11.33	AVG
2	4882.488	49.43	-3.03	46.40	74.00	-27.60	peak

Test Mode: TX 2480 MHz\_CH78\_1Mbps

### Vertical

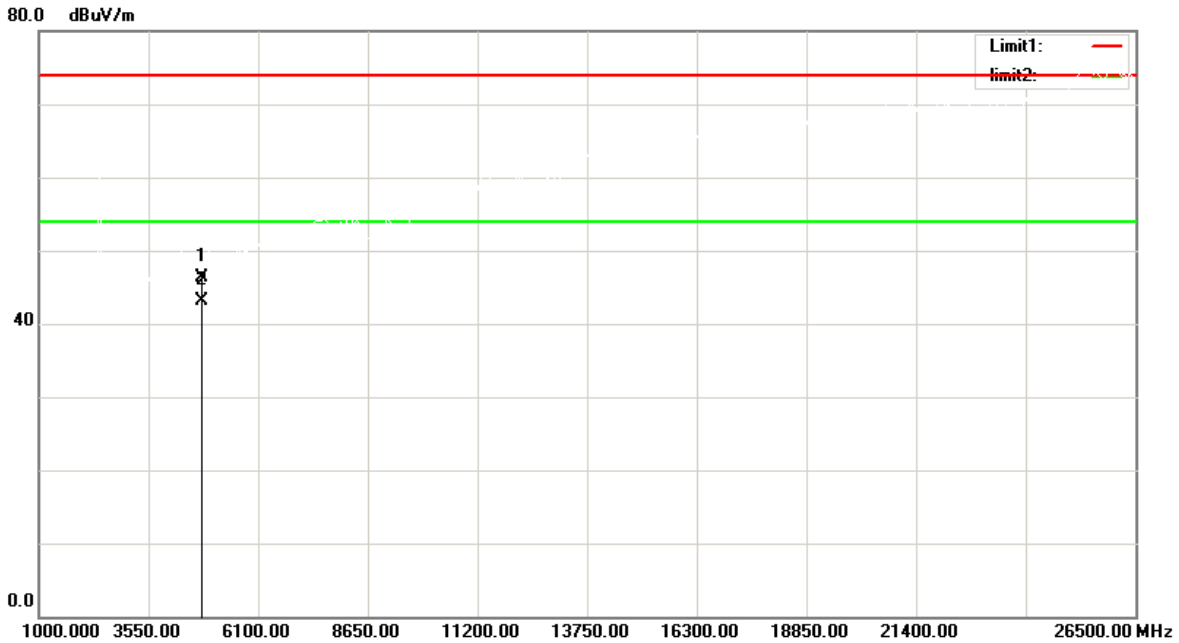

No.	Frequency (MHz)	Reading (dBuV/m)	Correct Factor(dB/m)	Result (dBuV/m)	Limit (dBuV/m)	Margin (dB)	Remark
1	4804.000	49.70	-3.33	46.37	74.00	-27.63	peak
2	4804.000	46.35	-3.33	43.02	54.00	-10.98	AVG

Test Mode: TX 2480 MHz\_CH78\_1Mbps

**Horizontal**

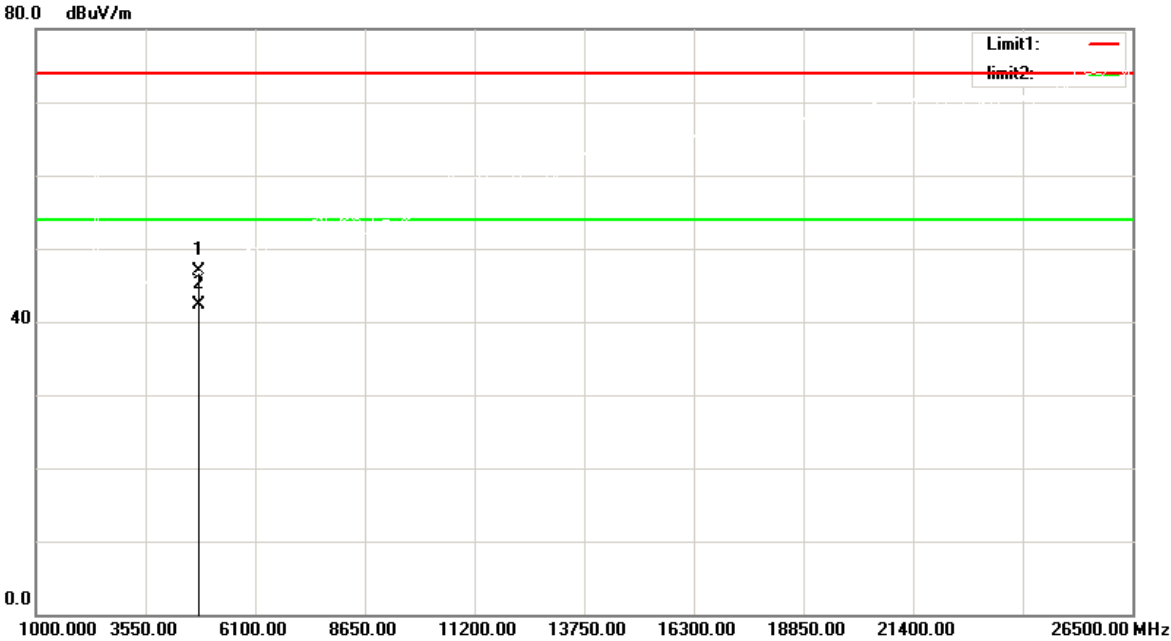

No.	Frequency (MHz)	Reading (dBuV/m)	Correct Factor(dB/m)	Result (dBuV/m)	Limit (dBuV/m)	Margin (dB)	Remark
1	4804.000	50.31	-3.33	46.98	74.00	-27.02	peak
2	4804.000	45.68	-3.33	42.35	74.00	-31.65	peak

Test Mode: TX 2402 MHz\_CH00\_3Mbps

**Vertical**

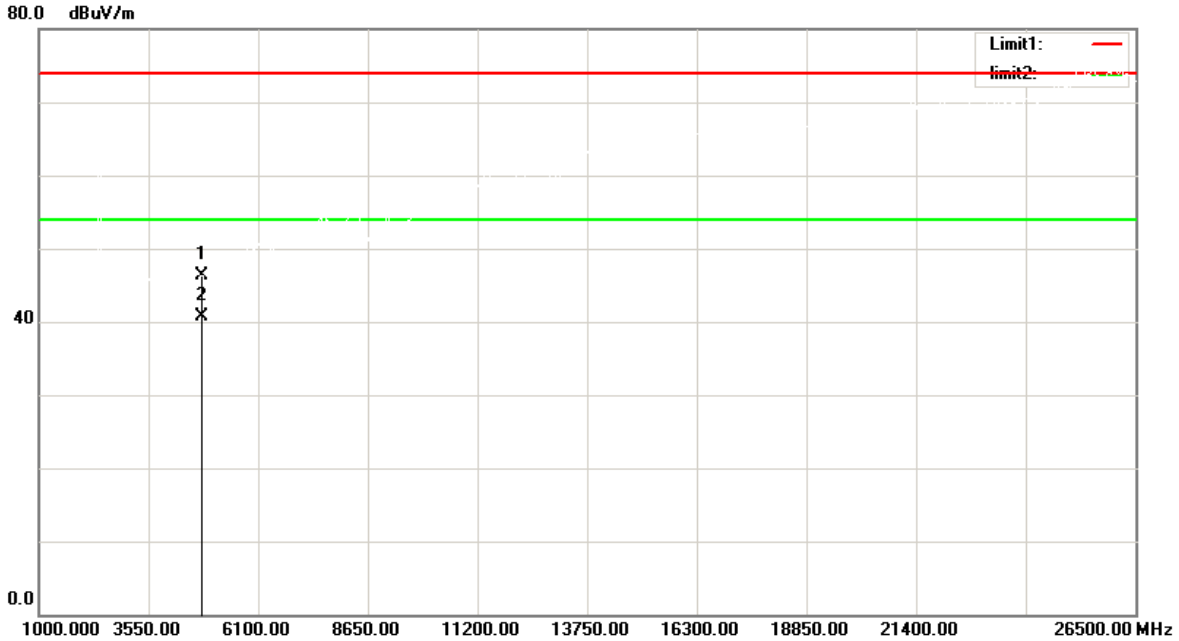

No.	Frequency (MHz)	Reading (dBuV/m)	Correct Factor(dB/m)	Result (dBuV/m)	Limit (dBuV/m)	Margin (dB)	Remark
1	4804.000	49.64	-3.33	46.31	74.00	-27.69	peak
2	4804.000	44.07	-3.33	40.74	54.00	-13.26	AVG

Test Mode: TX 2402 MHz\_CH00\_3Mbps

### Horizontal

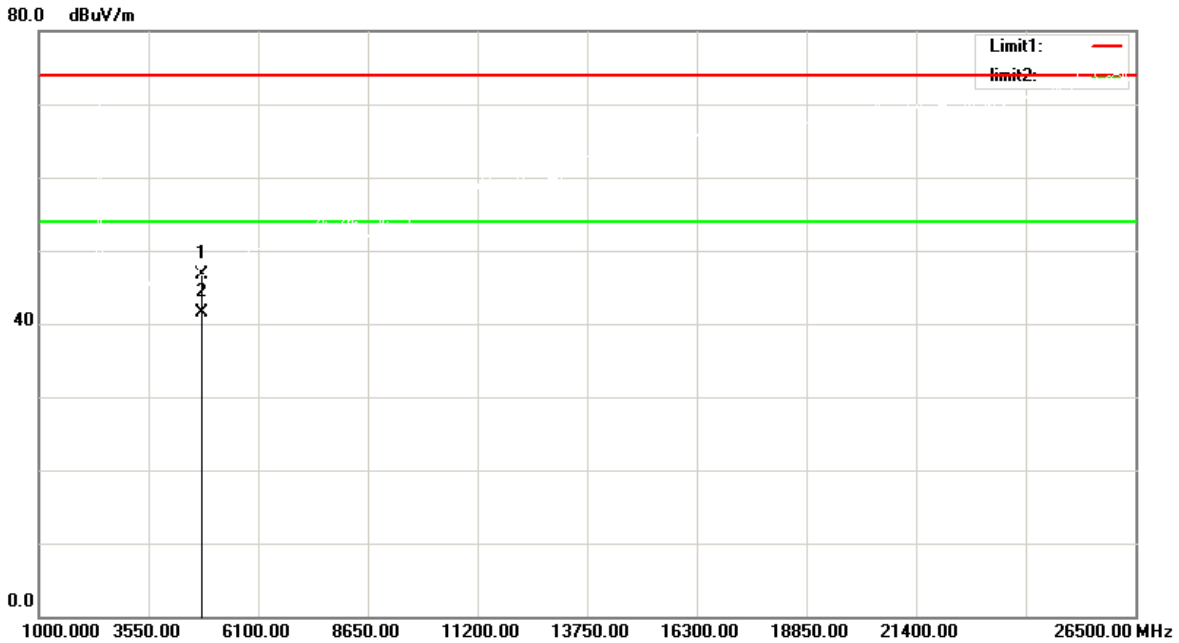

No.	Frequency (MHz)	Reading (dBuV/m)	Correct Factor(dB/m)	Result (dBuV/m)	Limit (dBuV/m)	Margin (dB)	Remark
1	4804.200	50.00	-3.33	46.67	74.00	-27.33	peak
2	4804.200	44.92	-3.33	41.59	54.00	-12.41	AVG

Test Mode: TX 2441 MHz\_CH39\_3Mbps

**Vertical**

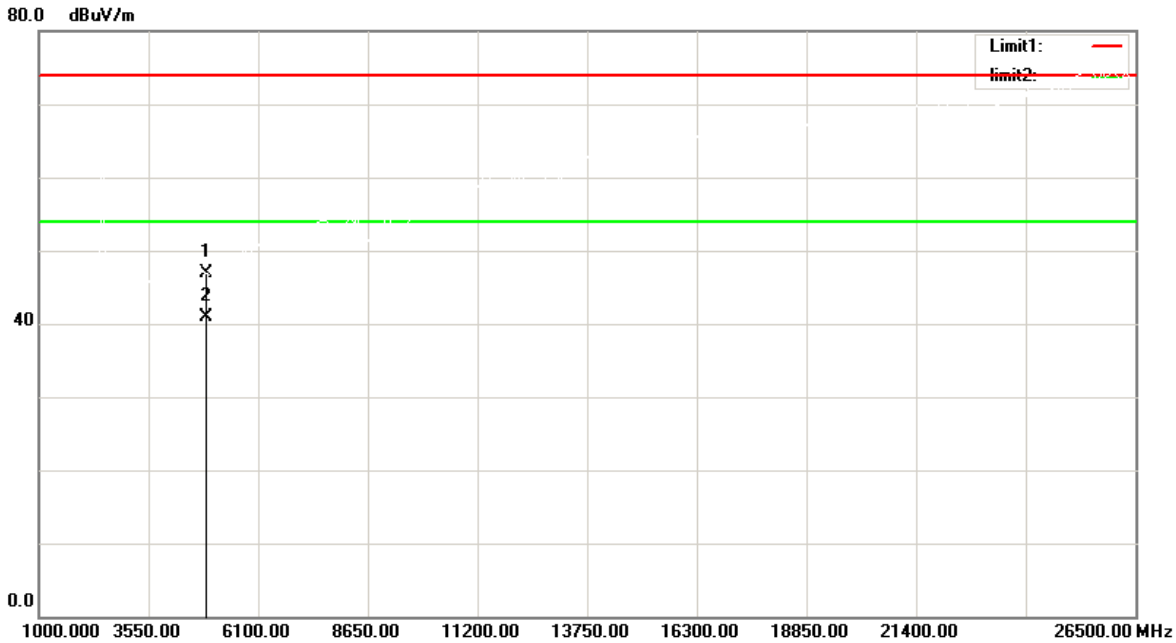

No.	Frequency (MHz)	Reading (dBuV/m)	Correct Factor(dB/m)	Result (dBuV/m)	Limit (dBuV/m)	Margin (dB)	Remark
1	4882.050	49.94	-3.03	46.91	74.00	-27.09	peak
2	4882.050	43.95	-3.03	40.92	54.00	-13.08	AVG



Test Mode: TX 2441 MHz\_CH39\_3Mbps

### Horizontal

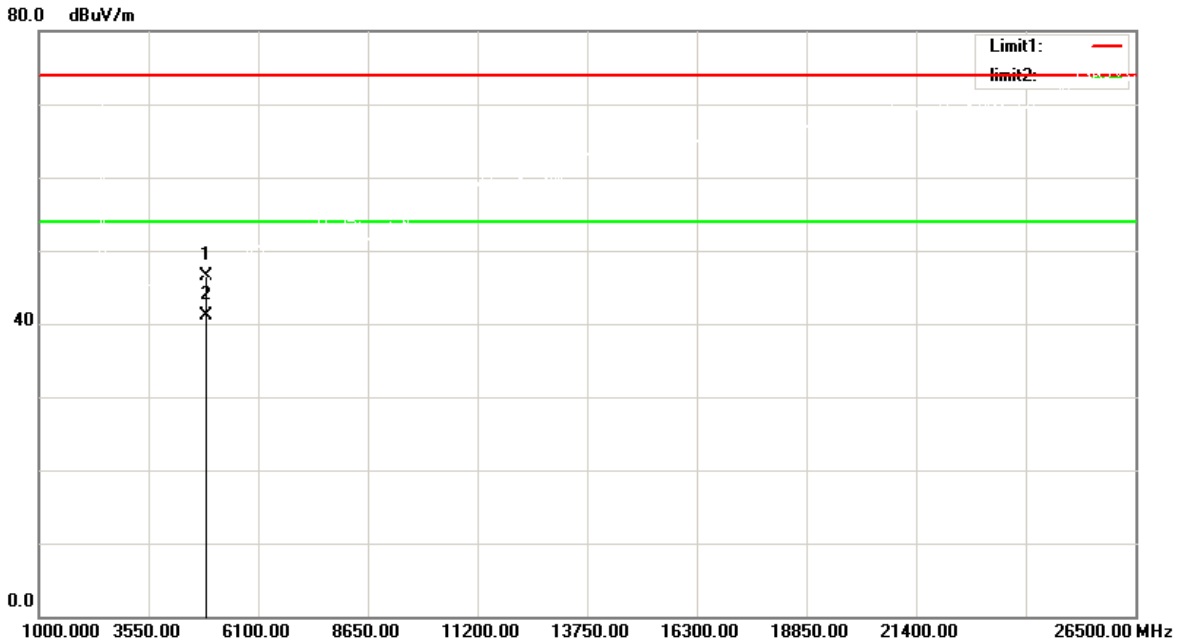

No.	Frequency (MHz)	Reading (dBuV/m)	Correct Factor(dB/m)	Result (dBuV/m)	Limit (dBuV/m)	Margin (dB)	Remark
1	4882.100	49.55	-3.03	46.52	74.00	-27.48	peak
2	4882.100	44.20	-3.03	41.17	54.00	-12.83	AVG

Test Mode: TX 2480 MHz\_CH78\_3Mbps

### Vertical

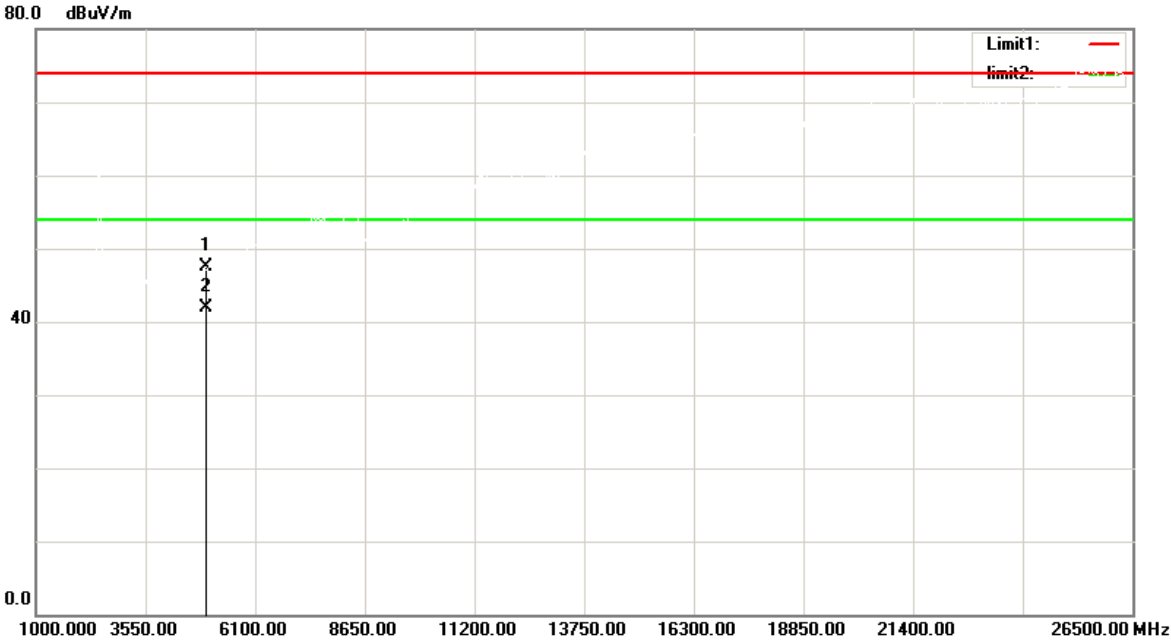

No.	Frequency (MHz)	Reading (dBuV/m)	Correct Factor(dB/m)	Result (dBuV/m)	Limit (dBuV/m)	Margin (dB)	Remark
1	4960.000	50.24	-2.74	47.50	74.00	-26.50	peak
2	4960.000	44.67	-2.74	41.93	54.00	-12.07	AVG

Test Mode: TX 2480 MHz\_CH78\_3Mbps

### Horizontal

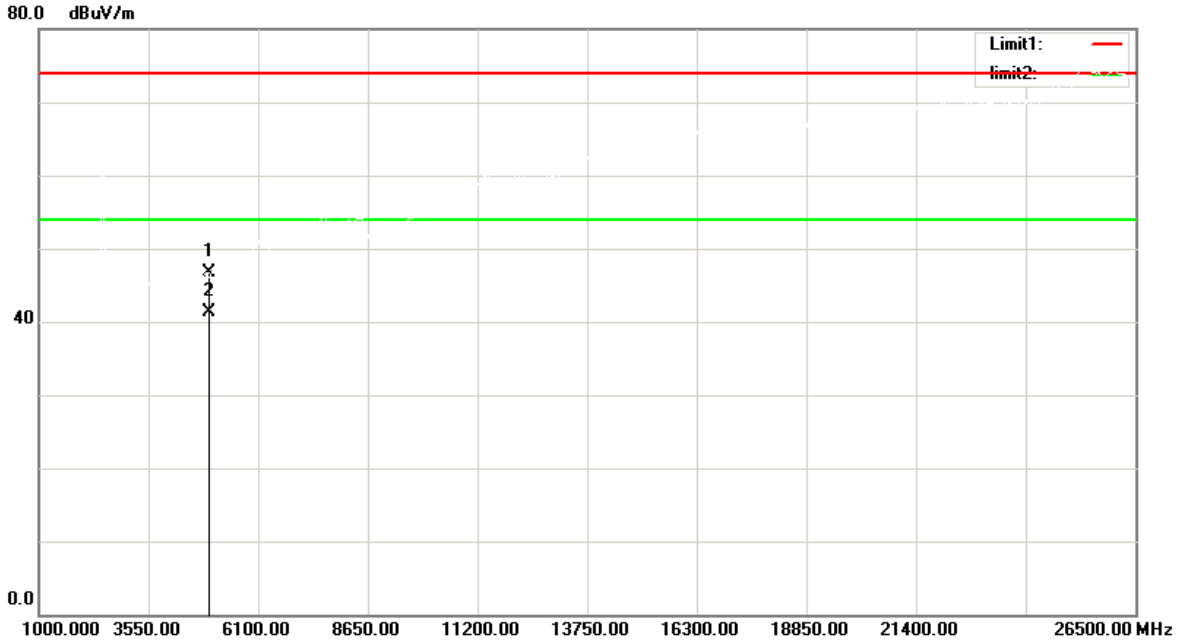

No.	Frequency (MHz)	Reading (dBuV/m)	Correct Factor(dB/m)	Result (dBuV/m)	Limit (dBuV/m)	Margin (dB)	Remark
1	4960.000	49.47	-2.74	46.73	74.00	-27.27	peak
2	4960.000	44.08	-2.74	41.34	54.00	-12.66	AVG

**6. NUMBER OF HOPPING FREQUENCY**

**6.1 LIMIT**

FCC Part15, Subpart C (15.247)&RSS-247	
Section	Test Item
15.247(a)(1)(iii) RSS-247 5.1 (d)	Number of Hopping Frequency

**6.2 TEST PROCEDURE AND SETTING**

- a. The EUT was directly connected to the spectrum analyzer and antenna output port as show in the block diagram below.
- b. Spectrum Setting: RBW=100 kHz, VBW=300 kHz, Sweep time = Auto.

Spectrum Parameters	Setting
Attenuation	Auto
Span Frequency	> Operating Frequency Range
RBW	100kHz
VBW	300kHz
Detector	Peak
Trace	Max Hold
Sweep Time	Auto

**6.3 MEASUREMENT INSTRUMENTS LIST**

Item	Kind of Equipment	Manufacturer	Type No.	Serial No.	Calibrated until
1	Spectrum analyzer	KEYSIGHT	N9010A	MY55150427	2020/05/27
2	Attenuator	Mini-Circuits	BW-S10W2	101109	N/A
3	RF Cable	Mi-cable	C10-01-01-1	100309	N/A

**6.4 TEST SETUP**



**6.5 EUT OPERATION CONDITIONS**

The EUT tested system was configured as the statements of 4.5 unless otherwise a special operating condition is specified in the follows during the testing.

6.6 TEST RESULTS

Hopping Mode_1Mbps		
Number of Hopping Frequency	Measurement result(CH)	Limit(CH)
		79

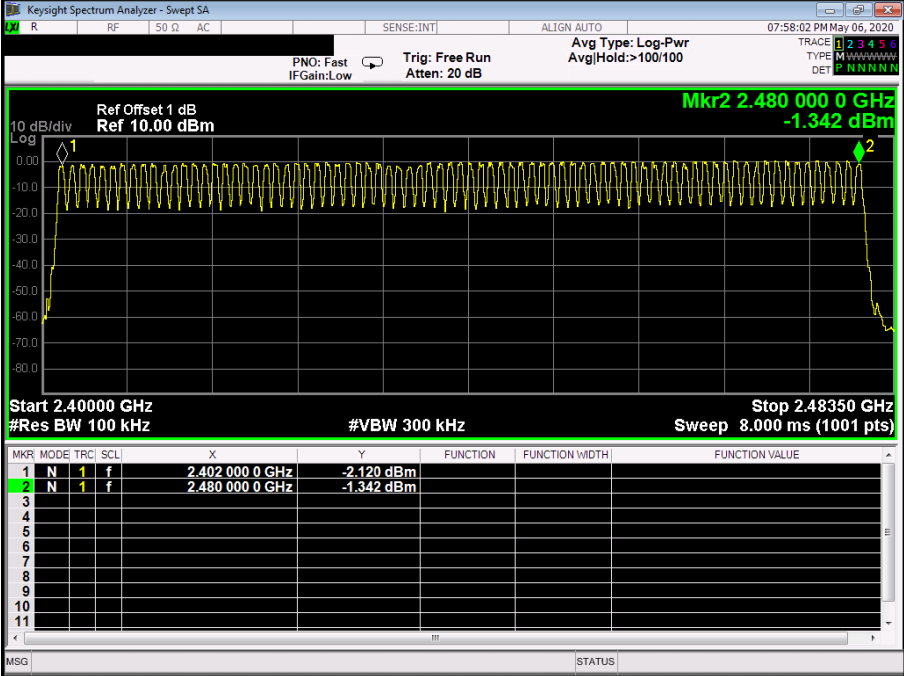

Hopping Mode_3Mbps		
Number of Hopping Frequency	Measurement result(CH)	Limit(CH)
		79

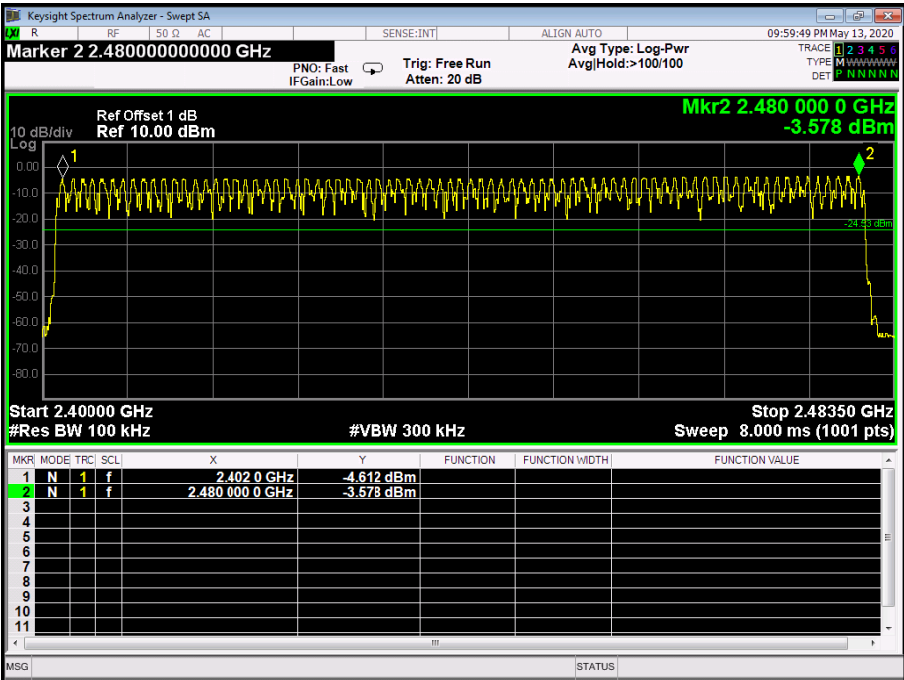

## 7. AVERAGE TIME OF OCCUPANCY

### 7.1 LIMIT

FCC Part15, Subpart C (15.247)&RSS-247		
Section	Test Item	Limit
15.247(a)(1)(iii) RSS-247 5.1 (d)	Average Time of Occupancy	0.4sec

### 7.2 TEST PROCEDURE AND SETTING

- a. The transmitter output (antenna port) was connected to the spectrum analyzer
- b. Set RBW of spectrum analyzer to 1MHz and VBW to 1MHz
- c. Use a video trigger with the trigger level set to enable triggering only on full pulses
- d. Sweep Time is more than once pulse time
- e. Set the center frequency on any frequency would be measure and set the frequency span to zero span
- f. Measure the maximum time duration of one single pulse
- g. Set the EUT for DH1, DH3 and DH5 packet transmitting
- h. Measure the maximum time duration of one single pulse
- i. DH1 Packet permit maximum  $1600 / 79 / 2 = 10.12$  hops per second in each channel (1 time slot TX, 1 time slot RX). So, the dwell time is the time duration of the pulse times  $10.12 \times 31.6 = 320$  within 31.6 seconds
- j. DH3 Packet permit maximum  $1600 / 79 / 4 = 5.06$  hops per second in each channel (3 time slots TX, 1 time slot RX). So, the dwell time is the time duration of the pulse times  $5.06 \times 31.6 = 160$  within 31.6 seconds
- k. DH5 Packet permit maximum  $1600 / 79 / 6 = 3.37$  hops per second in each channel (5 time slots TX, 1 time slot RX). So, the dwell time is the time duration of the pulse times  $3.37 \times 31.6 = 106.6$  within 31.6 seconds

### 7.3 MEASUREMENT INSTRUMENTS LIST

Item	Kind of Equipment	Manufacturer	Type No.	Serial No.	Calibrated until
1	Spectrum analyzer	KEYSIGHT	N9010A	MY55150427	2020/05/27
2	Attenuator	Mini-Circuits	BW-S10W2	101109	N/A
3	RF Cable	Mi-cable	C10-01-01-1	100309	N/A

### 7.4 TEST SETUP



### 7.5 EUT OPERATION CONDITIONS

The EUT tested system was configured as the statements of 4.5 unless otherwise a special operating condition is specified in the follows during the testing.

### 7.6 TEST RESULTS

TX Mode_1Mbps				
Mode	Channel Frequency (MHz)	Pulse Time (ms)	Dwell Time (ms)	Limit (ms)
DH1	2441	0.384	122.9	400
DH3	2441	1.640	262.4	400
DH5	2441	2.960	315.7	400

DH1

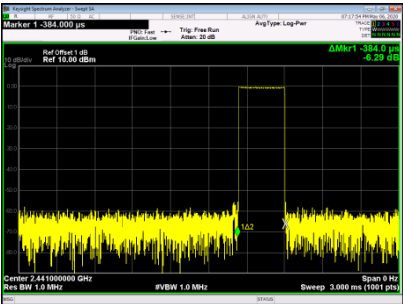

DH3



DH5

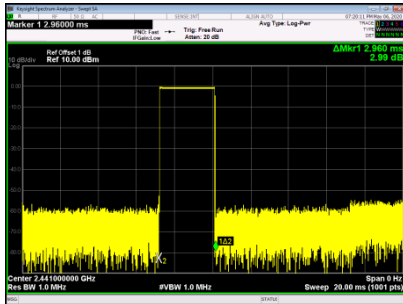

TX Mode_3Mbps				
Mode	Channel Frequency (MHz)	Pulse Time (ms)	Dwell Time (ms)	Limit (ms)
DH1	2441	0.396	126.1	400
DH3	2441	1.660	265.6	400
DH5	2441	2.920	311.5	400

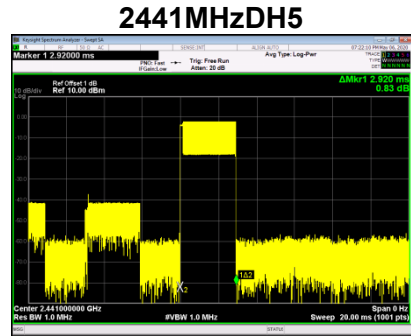
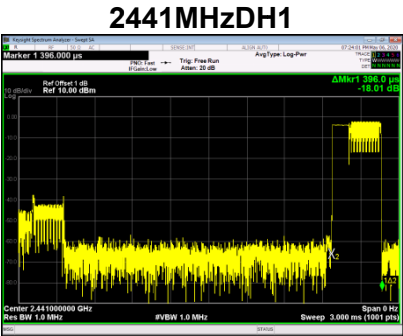



**8. HOPPING CHANNEL SEPARATION MEASUREMENT****8.1 LIMIT**

Frequency hopping systems operating in the 2400-2483.5 MHz band may have hopping channel carrier frequencies that are separated by 25 kHz or two-thirds of the 20 dB bandwidth of the hopping channel, whichever is greater, provided the systems operate with an output power no greater than 125 mW.

**8.2 TEST PROCEDURE AND SETTING**

- a. The EUT was directly connected to the spectrum analyzer and antenna output port as show in the block diagram below.
- b. Span = wide enough to capture the peaks of two adjacent channels  
 Resolution (or IF) Bandwidth (RBW)  $\geq$  1% of the span  
 Video (or Average) Bandwidth (VBW)  $\geq$  RBW  
 Sweep = Auto  
 Detector function = Peak  
 Trace = Max Hold

Spectrum Parameter	Setting
Attenuation	Auto
Span Frequency	> Measurement Bandwidth or Channel Separation
RBW	10 kHz
VBW	30 kHz
Detector	Peak
Trace	Max Hold
Sweep Time	Auto

**8.3 MEASUREMENT INSTRUMENTS LIST**

Item	Kind of Equipment	Manufacturer	Type No.	Serial No.	Calibrated until
1	Spectrum analyzer	KEYSIGHT	N9010A	MY55150427	2020/05/27
2	Attenuator	Mini-Circuits	BW-S10W2	101109	N/A
3	RF Cable	Mi-cable	C10-01-01-1	100309	N/A

**8.4 TEST SETUP****8.5 EUT OPERATION CONDITIONS**

The EUT tested system was configured as the statements of 4.5 unless otherwise a special operating condition is specified in the follows during the testing.

### 8.6 TEST RESULTS

TX Mode_1Mbps				
Channel	Frequency (MHz)	Channel Separation(MHz)	Limit (MHz)	Result
CH00	2402	0.999	>(25KHz or 2/3*20dB Bandwidth)	PASS
CH39	2441	0.999	>(25KHz or 2/3*20dB Bandwidth)	PASS
CH78	2480	0.999	>(25KHz or 2/3*20dB Bandwidth)	PASS

2402MHz



2441MHz



2480MHz



TX Mode_3Mbps				
Channel	Frequency (MHz)	Channel Separation(MHz)	Limit (MHz)	Result
CH00	2402	1.002	>(25KHz or 2/3*20dB Bandwidth)	PASS
CH39	2441	1.002	>(25KHz or 2/3*20dB Bandwidth)	PASS
CH78	2480	0.999	>(25KHz or 2/3*20dB Bandwidth)	PASS

2402MHz



2441MHz



2480MHz



**9. BANDWIDTH TEST**

**9.1 LIMIT**

FCC Part15, Subpart C (15.247)&RSS-247	
Section	Test Item
15.247(a)(1) RSS-Gen 6.7 RSS-247 5.1 (a)	Bandwidth

**9.2 TEST PROCEDURE AND SETTING**

- a. The EUT was directly connected to the spectrum analyzer and antenna output port as show in the block diagram below.
- b. Spectrum Setting: RBW= 30 kHz, VBW=100 kHz, Sweep Time = Auto.

Spectrum Parameter	Setting
Attenuation	Auto
Span Frequency	> Measurement Bandwidth
RBW	30kHz
VBW	100kHz
Detector	Peak
Trace	Max Hold
Sweep Time	Auto

**9.3 MEASUREMENT INSTRUMENTS LIST**

Item	Kind of Equipment	Manufacturer	Type No.	Serial No.	Calibrated until
1	Spectrum analyzer	KEYSIGHT	N9010A	MY55150427	2020/05/27
2	Attenuator	Mini-Circuits	BW-S10W2	101109	N/A
3	RF Cable	Mi-cable	C10-01-01-1	100309	N/A

**9.4 TEST SETUP**



**9.5 EUT OPERATION CONDITIONS**

The EUT tested system was configured as the statements of 4.5 unless otherwise a special operating condition is specified in the follows during the testing.

### 9.6 TEST RESULTS

TX Mode_1Mbps				
Channel	Frequency (MHz)	20dB Bandwidth (MHz)	99 % Emission Bandwidth (MHz)	Result
CH00	2402	0.8176	0.8207	PASS
CH39	2441	0.7346	0.8179	PASS
CH78	2480	0.8213	0.8187	PASS

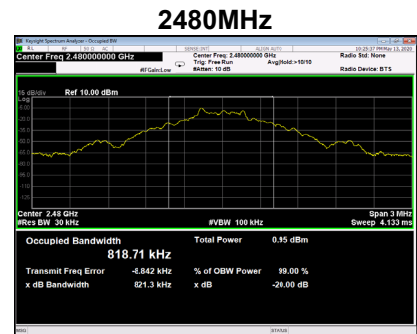
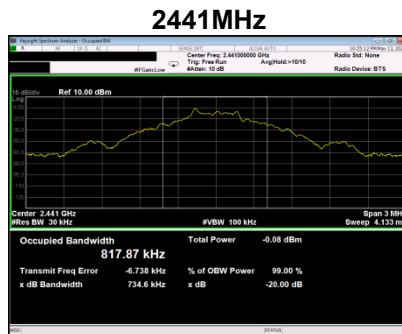
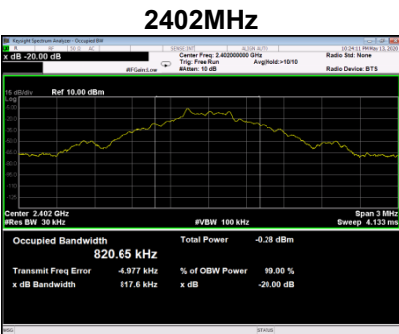

TX Mode_3Mbps				
Channel	Frequency (MHz)	20dB Bandwidth (MHz)	99 % Emission Bandwidth (MHz)	Result
CH00	2402	1.157	1.1074	PASS
CH39	2441	1.157	1.1067	PASS
CH78	2480	1.153	1.1073	PASS

**2402MHz**

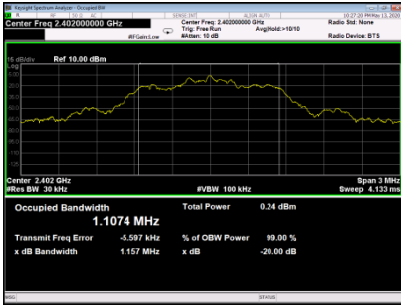

**2441MHz**

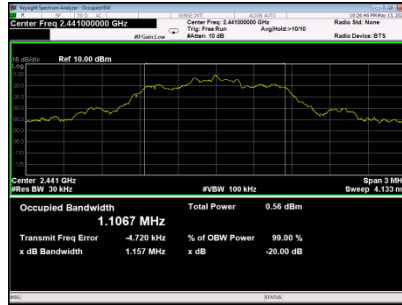

**2480MHz**

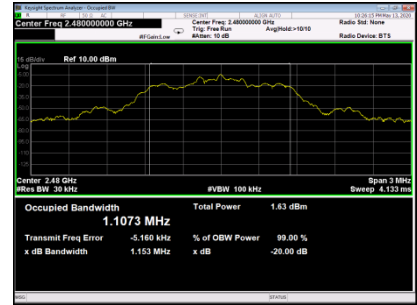

**10. MAXIMUM OUTPUT POWER**

**10.1 LIMIT**

FCC Part15 , Subpart C (15.247)&RSS-247		
Section	Test Item	Limit
15.247(a)(1) RSS-247 5.1 (b)	Maximum Output Power	0.125Watt or 21dBm

**Note:**

Frequency hopping systems shall have hopping channel carrier frequencies separated by a minimum of 25 kHz or the 20 dB bandwidth of the hopping channel, whichever is greater. Alternatively, frequency hopping systems operating in the 2400-2483.5 MHz band may have hopping channel carrier frequencies that are separated by 25 kHz or two-thirds of the 20 dB band width of the hopping channel, whichever is greater, provided the systems operate with an output power no greater than 125 mW.

**10.2 TEST PROCEDURE AND SETTING**

- a. The EUT was directly connected to the spectrum analyzer and antenna output port as show in the block diagram below.
- b. Spectrum Setting: RBW= 1MHz/3MHz, VBW= 1MHz/3MHz, Sweep time = Auto.

**10.3 MEASUREMENT INSTRUMENTS LIST**

Item	Kind of Equipment	Manufacturer	Type No.	Serial No.	Calibrated until
1	Spectrum analyzer	KEYSIGHT	N9010A	MY55150427	2020/05/27
2	Attenuator	Mini-Circuits	BW-S10W2	101109	N/A
3	RF Cable	Mi-cable	C10-01-01-1	100309	N/A

**10.4 TEST SETUP**



**10.5 EUT OPERATION CONDITIONS**

The EUT tested system was configured as the statements of 4.5 unless otherwise a special operating condition is specified in the follows during the testing.

### 10.6 TEST RESULTS

TX Mode_1Mbps				
Channel	Frequency (MHz)	Output Power (dBm)	Output Power (W)	Result
CH00	2402	-0.910	0.000811	PASS
CH39	2441	-0.283	0.000937	PASS
CH78	2480	0.342	0.001082	PASS
Limit	21dBm /0.125W			

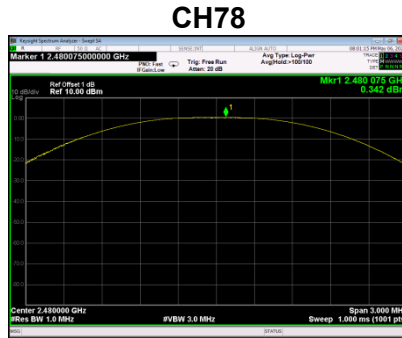
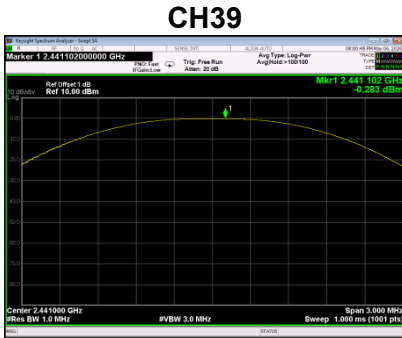
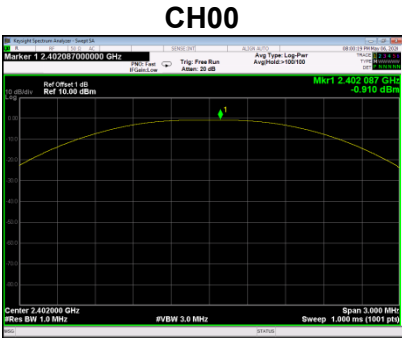



TX Mode_2Mbps				
Channel	Frequency (MHz)	Output Power (dBm)	Output Power (W)	Result
CH00	2402	-1.514	0.000706	PASS
CH39	2441	-1.218	0.000755	PASS
CH78	2480	-0.809	0.000830	PASS
Limit	21dBm /0.125W			

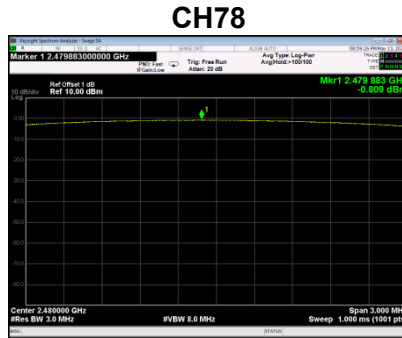
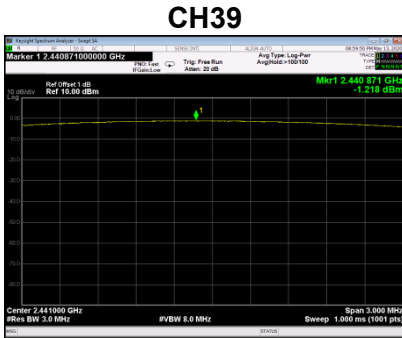
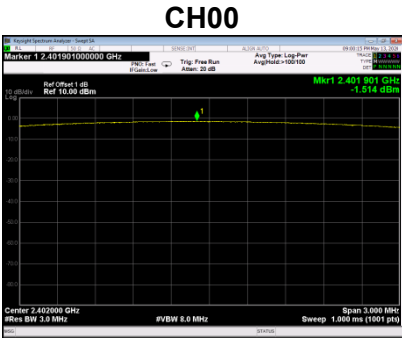

TX Mode_3Mbps				
Channel	Frequency (MHz)	Output Power (dBm)	Output Power (W)	Result
CH00	2402	-1.861	0.000651	PASS
CH39	2441	-1.268	0.000747	PASS
CH78	2480	-0.702	0.000851	PASS
Limit	21dBm /0.125W			

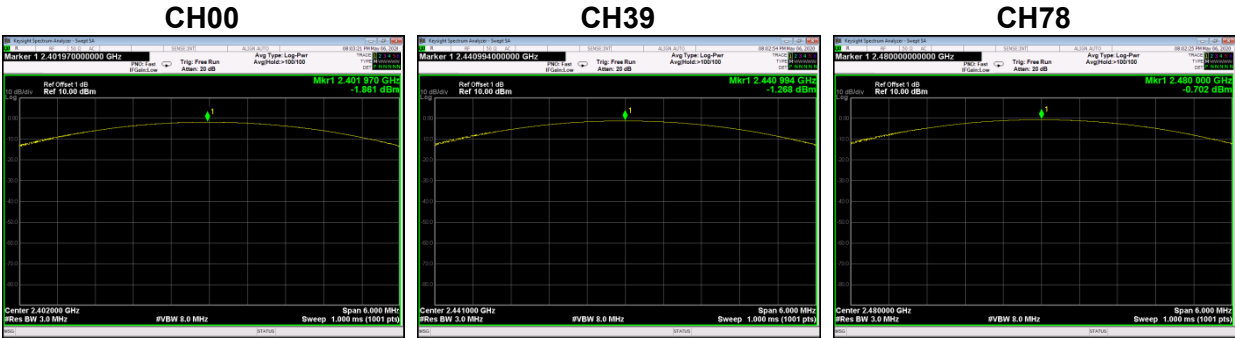

## 11. CONDUCTED SPURIOUS EMISSION

### 11.1 LIMIT

For FCC

In any 100 kHz bandwidth outside the frequency band in which the spread spectrum or digitally modulated intentional radiator is operating, the radio frequency power that is produced by the intentional radiator shall be at least 20 dB below that in the 100 kHz bandwidth within the band that contains the highest level of the desired power, based on either an RF conducted or a radiated measurement, provided the transmitter demonstrates compliance with the peak Output Power limits. If the transmitter complies with the Output Power limits based on the use of RMS averaging over a time interval, as permitted under paragraph (b)(3) of this section, the attenuation required under this paragraph shall be 30 dB instead of 20 dB. Attenuation below the general limits specified in Section 15.209(a) is not required.

For ISED

In any 100 kHz bandwidth outside the frequency band in which the spread spectrum or digitally modulated device is operating, the RF power that is produced shall be at least 20 dB below that in the 100 kHz bandwidth within the band that contains the highest level of the desired power, based on either an RF conducted or a radiated measurement, provided that the transmitter demonstrates compliance with the peak Output Power limits. If the transmitter complies with the Output Power limits based on the use of root-mean-square averaging over a time interval, as permitted under section 5.4(d), the attenuation required shall be 30 dB instead of 20 dB. Attenuation below the general field strength limits specified in RSS-Gen is not required.

### 11.2 TEST PROCEDURE AND SETTING

- a. The EUT was directly connected to the spectrum analyzer and antenna output port as show in the block diagram below.
- b. Spectrum Setting: RBW= 100 kHz, VBW=300 kHz, Sweep time = Auto.

### 11.3 MEASUREMENT INSTRUMENTS LIST

Item	Kind of Equipment	Manufacturer	Type No.	Serial No.	Calibrated until
1	Spectrum analyzer	KEYSIGHT	N9010A	MY55150427	2020/05/27
2	Attenuator	Mini-Circuits	BW-S10W2	101109	N/A
3	RF Cable	Mi-cable	C10-01-01-1	100309	N/A

### 11.4 TEST SETUP



### 11.5 EUT OPERATION CONDITIONS

The EUT tested system was configured as the statements of 4.5 unless otherwise a special operating condition is specified in the follows during the testing.

### 11.6 TEST RESULTS

#### TX Mode\_1Mbps

##### Bandedge- CH00 (Lower)

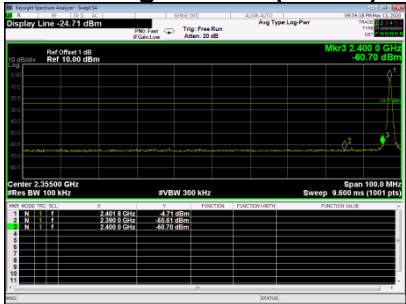

##### Bandedge CH78 (Upper)

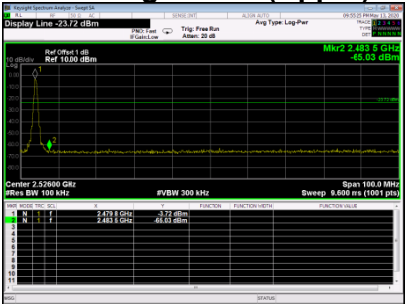

##### Bandedge- Hopping on (Lower)

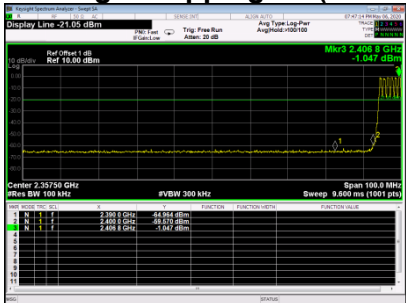

##### Bandedge Hopping on (Upper)

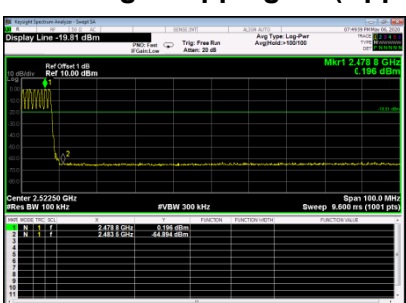

#### 10th Harmonic of the fundamental frequency

##### CH00

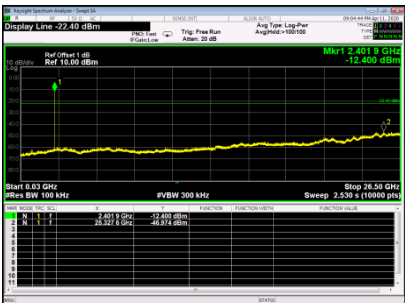

##### CH39

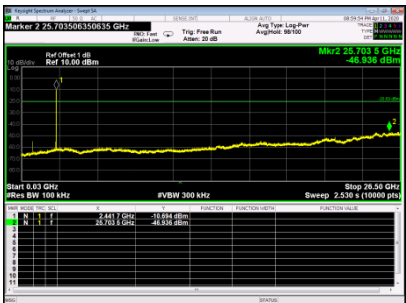

##### CH78

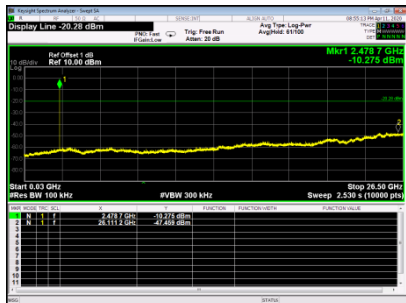

**TX Mode\_3Mbps**

**Bandedge- CH00 (Lower)**

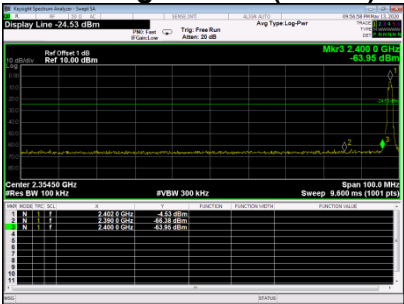

**Bandedge CH78 (Upper)**

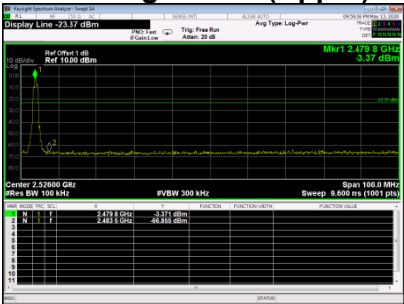

**Bandedge- Hopping on (Lower)**

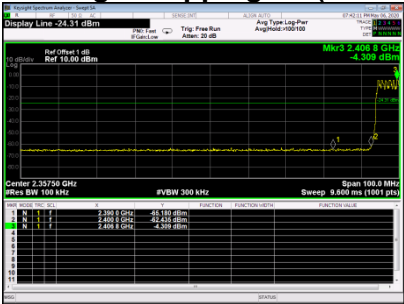

**Bandedge- Hopping on (Upper)**

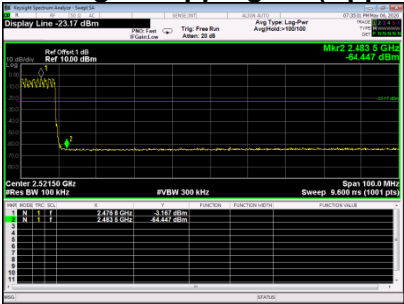

**10th Harmonic of the fundamental frequency**

**CH00**

**CH39**

**CH78**

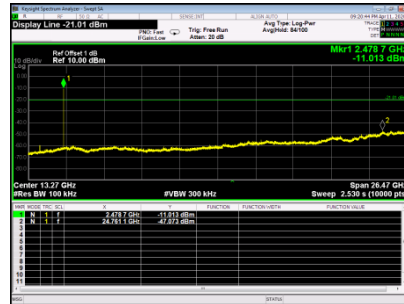
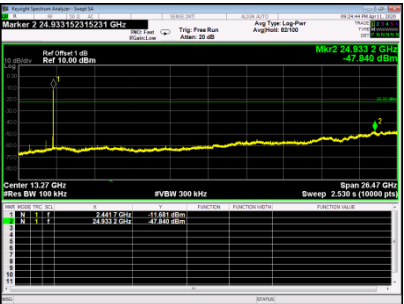
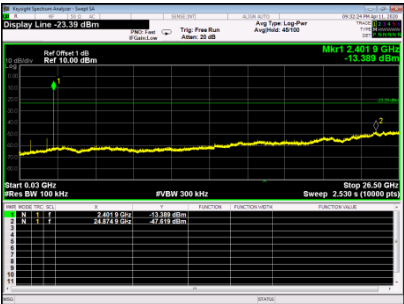

**12. FREQUENCY STABILITY MEASUREMENT**

**12.1 LIMIT**

RSS-Gen			
Section	Test Item	Limit	Frequency Range (MHz)
RSS-Gen 6.11	Frequency Stability	Specified in the user's manual	2402-2480

**12.2 TEST PROCEDURE**

- a. The EUT was directly connected to the spectrum analyzer and antenna output port as show in the block diagram below.
- b. Spectrum Setting:

Spectrum Parameter	Setting
Attenuation	Auto
Span Frequency	Entire absence of modulation emissionsbandwidth
RBW	10 kHz
VBW	10kHz
Sweep Time	Auto

**12.3 MEASUREMENT INSTRUMENTS LIST**

Item	Kind of Equipment	Manufacturer	Type No.	Serial No.	Calibrated until
1	Spectrum analyzer	KEYSIGHT	N9010A	MY55150427	2020/05/27
2	Attenuator	Mini-Circuits	BW-S10W2	101109	N/A
3	RF Cable	Mi-cable	C10-01-01-1	100309	N/A
4	Temperature conditioning	Guan Jian.HTH1000	-20-130°C	GJ1000-10D001	N/A
5	DC Power Supply	G.KE	IPR-10010D	010931954	N/A

**12.4 TEST SETUP**

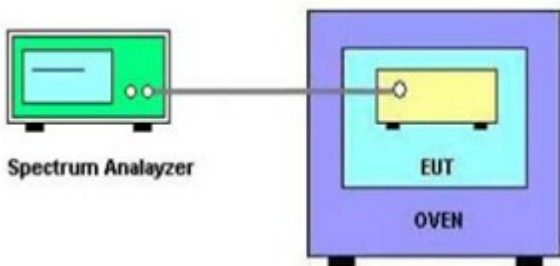

**12.5 EUT OPERATION CONDITIONS**

The EUT was programmed to be in continuously transmitting mode.

**12.6 TEST RESULTS**

	Temperature vs. Frequency Stability	
Voltage	Temperature	Measurement Frequency (MHz)
3.3V	(°C)	2402
	-20	2401.983
	25	2401.991
	50	2401.985
2.3V	25	2401.981
Max. Deviation (MHz)		-0.019
Max. Deviation (ppm)		-7.91

Note: 2.3V is the end point voltage, and products below 2.3V will cease working.

**END OF TEST REPORT**