



SAR TEST REPORT

Applicant : PERFORMANCE DESIGNED PRODUCTS, LLC
Address : 14144 Ventura Blvd, Suite 200 Sherman. Oaks CA
91423 United States Of America
Manufacturer : PERFORMANCE DESIGNED PRODUCTS, LLC
Address : 14144 Ventura Blvd, Suite 200 Sherman. Oaks CA
91423 United States Of America
Equipment : Airlite Pro Wireless Headset for PlayStation
Model No. : 052-017
Trade Name : PDP
FCC ID. : X5B-052017

I HEREBY CERTIFY THAT:

The sample was received on Jun. 20, 2022 and the testing was completed on Jul. 07, 2022 at CerpPASS Technology Corp. The test result refers exclusively to the test presented test model / sample. Without written approval of CerpPASS Technology Corp., the test report shall not be reproduced except in full.

Approved by:

Vic Hsiao / Supervisor

Laboratory Accreditation:

CerpPASS Technology Corporation Test Laboratory





Contents

1. Summary of Maximum SAR Value.....	4
2. Test Configuration of Equipment under Test.....	5
3. General Information of Test	6
4. Basic restrictions and Standards.....	7
4.1 Test Standards	7
4.2 Reference Standards	7
4.3 Environment Condition.....	7
4.4 RF Exposure Limits	7
5. DASY5 Measurement System.....	8
5.1 Uncertainty of Inter-/Extrapolation and Averaging	9
5.2 DASY5 E-Field Probe	9
5.3 Data Acquisition Electronics (DAE).....	10
5.4 Robot.....	10
5.5 Measurement Server.....	11
5.6 Measurement Server.....	11
5.7 SAM Phantom	12
5.8 Device Holder.....	13
5.9 Test Equipment and Ancillaries Used for Tests	14
6. The SAR Measurement Procedure	15
6.1 System Performance Check	15
6.2 Test Requirements	19
6.3 RF Exposure Positions.....	21
7. SRD SAR Exclusion and Results	23
7.1 Measured Conducted Average Power	23
7.2 Antenna Location	24
7.3 SAR Test Results Summary.....	25
7.4 SAR Measurement Variability	26
8. Simultaneous Transmission Analysis	27
8.1 Co-location	27
8.2 SPLSR Evaluation.....	27
9. Measurement Uncertainty	28
Appendix A. DASY Calibration Certificate	
Appendix B. System Performance Check	
Appendix C. Measured Conducted Power	
Appendix D. SAR Measurement Data	
Appendix E. Photographs of EUT Set up	



History of this test report

Attachment No.	Issued Date	Description
22060154-TRFCC02	Aug. 22, 2022	Original



1. Summary of Maximum SAR Value

Results for highest reported SAR values for each frequency band and mode are as below:

Headset		
Band	Mode	Highest Head standalone SAR 1g (W/kg)
SRD	PI/4 DQPSK	0.01

Note *The lab has reduced the uncertainty risk factor from test equipment, environment and staff technicians which according to the standard on contract. Therefore, the test result will only be determined by standard requirement.



2. Test Configuration of Equipment under Test

Operation Frequency Range	2400MHz -2483.5MHz
Center Frequency Range	2403.35MHz-2477.35MHz
Modulation Type	π /4-DQPSK
Data Rate	π /4-DQPSK
Antenna Type	PCB Antenna
Antenna Gain	ANT A:5.48 dBi , ANT B: 2.08dBi
Type-C USB Cable	Brand: ADJ Model: #1
Dongle	Brand: PDP Model: 052-017T

Note:

1. The EUT is 1TX diversity , Only use one of them at a time
2. For more details, please refer to the User's manual of the EUT.



3. General Information of Test

Test Site	CerpPASS Technology Corporation Test Laboratory Address: No.10, Ln. 2, Lianfu St., Luzhu Dist., Taoyuan City 33848, Taiwan (R.O.C.) Tel:+886-3-3226-888 Fax:+886-3-3226-881
-----------	--

Test Item	Test Site	Test Period	Tested By
SAR	RFSAR01-NK	2022/07/7	Angelo Chang

Test Site	Test Period	Temp.	Humi.
RFSAR01-NK	2022/7/7	24.1	52%



4. Basic restrictions and Standards

4.1 Test Standards

FCC 47 CFR Part 2 (2.1093)

4.2 Reference Standards

FCC KDB Publication 447498 D01 General RF Exposure Guidance v06
FCC KDB Publication 865664 D01 SAR Measurement 100 MHz to 6 GHz v01r04
FCC KDB Publication 248227 D01 802.11 Wi-Fi SAR v02r02
FCC KDB Publication 941225D06 Hot Spot SAR v02r01
IEEE 62209-1528

4.3 Environment Condition

Item	Target
Ambient Temperature(°C)	18~25
Temperature of Simulant(°C)	20~22
Relative Humidity(%RH)	30~70

4.4 RF Exposure Limits

Human Exposure	Basic restrictions for electric, magnetic and electromagnetic fields. (Unit in mW/g or W/kg)
Spatial Peak SAR ¹ (Head and Body)	1.6
Spatial Average SAR ² (Whole Body)	0.08
Spatial Peak SAR ³ (Arms and Legs)	4

Notes:

1. The Spatial Peak value of the SAR averaged over any 1gram of tissue (defined as a tissue volume in the shape of a cube) and over the appropriate averaging time.
2. The Spatial Average value of the SAR averaged over the whole body.
3. The Spatial Peak value of the SAR averaged over any 1 gram of tissue (defined as a tissue volume in the shape of a cube) and over appropriate averaging time.

5. DASY5 Measurement System

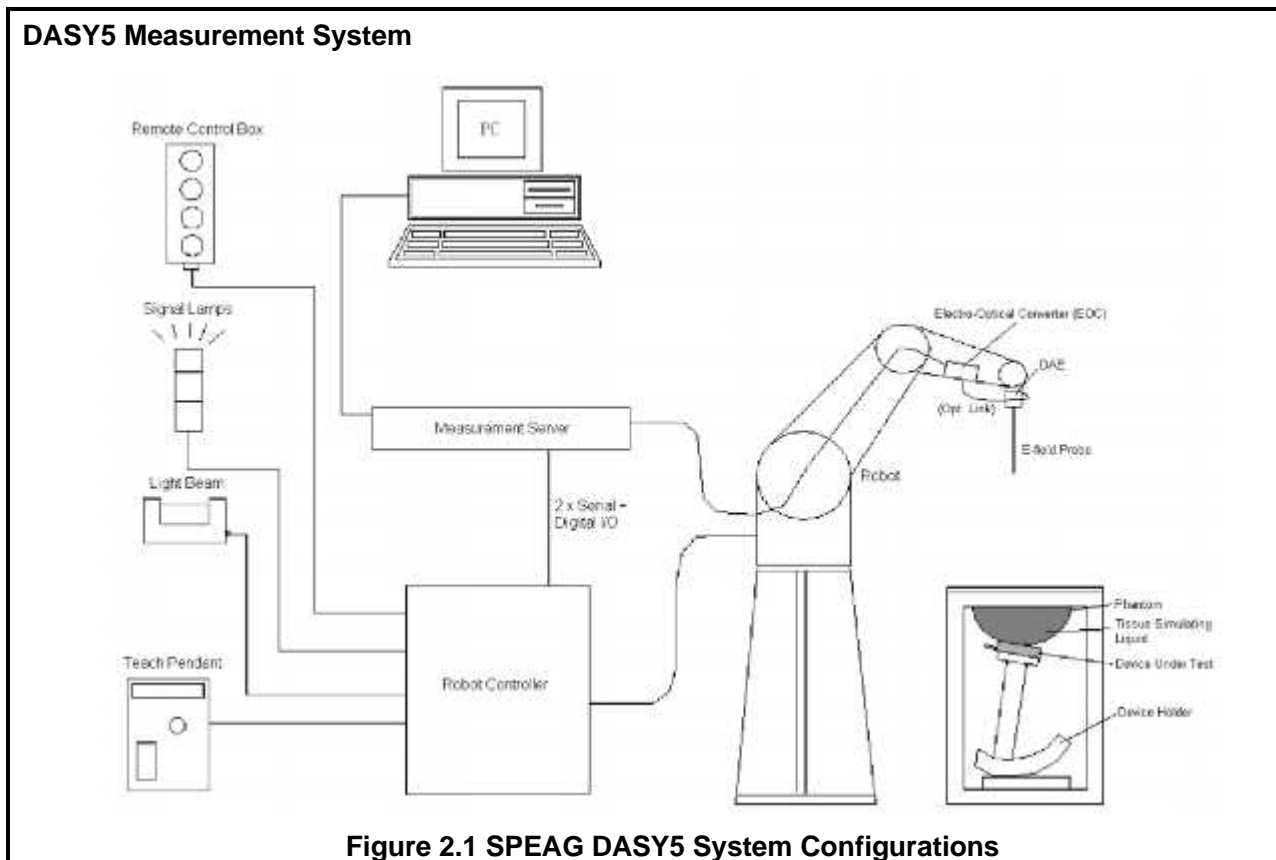

Figure 2.1 SPEAG DASY5 System Configurations

The DASY5 system for performance compliance tests is illustrated above graphically. This system consists of the following items:

- A standard high precision 6-axis robot with controller, a teach pendant and software
- A data acquisition electronic(DAE)attached to the robot arm extension
- A dosimetric probe equipped with an optical surface detector system
- The electro-optical converter(ECO)performs the conversion between optical and electrical signals
- A measurement server performs the time critical tasks such as signal filtering, control of the robot operation and fast movement interrupts.
- A probe alignment unit which improves the accuracy of the probe positioning
- A computer operating Windows 7
- DASY5 software
- Remove control with teach pendant additional circuitry for robot safety such as warning lamps, etc.
- The SAM twin phantom
- A device holder
- Tissue simulating liquid
- Dipole for evaluating the proper functioning of the system



5.1 Uncertainty of Inter-/Extrapolation and Averaging

In order to evaluate the uncertainty of the interpolation, extrapolation and averaged SAR calculation algorithms of the Postprocessor, DASY5 allows the generation of measurement grids which are artificially predefined by analytically based test functions. Therefore, the grids of area scans and zoom scans can be filled with uncertainty test data, according to the SAR benchmark functions of IEEE 1528. The three analytical functions shown in equations as below are used to describe the possible range of the expected SAR distributions for the tested handsets. The field gradients are covered by the spatially flat distribution f1, the spatially steep distribution f3 and f2 accounts for H-field cancellation on the phantom/tissue surface.

$$f_1(x, y, z) = Ae^{-\frac{z}{5a}} \cos^2\left(\frac{\pi}{2} \frac{\sqrt{x'^2 + y'^2}}{5a}\right)$$

$$f_2(x, y, z) = Ae^{-\frac{z}{a}} \frac{a^2}{a^2 + x'^2} \left(3 - e^{-\frac{2z}{a}}\right) \cos^2\left(\frac{\pi}{2} \frac{y'}{3a}\right)$$

$$f_3(x, y, z) = A \frac{a^2}{\frac{a^2}{4} + x'^2 + y'^2} \left(e^{-\frac{2z}{a}} + \frac{a^2}{2(a + 2z)^2}\right)$$

5.2 DASY5 E-Field Probe

The SAR measurement is conducted with the dosimetric probe manufactured by SPEAG. The probe is specially designed and calibrated for use in liquid with high permittivity. The dosimetric probe has special calibration in liquid at different frequency.

SPEAG conducts the probe calibration in compliance with international and national standards (e.g. IEEE 1528, EN 62209-1, IEC 62209, etc.) under ISO 17025. The calibration data are in Appendix D.

Model	EX3DV4	
Construction	Symmetrical design with triangular core Built-in shielding against static charges PEEK enclosure material (resistant to organic solvents, e.g., DGBE)	
Frequency	10 MHz to 6 GHz Linearity: ± 0.2 dB (30 MHz to 6 GHz)	
Directivity	± 0.3 dB in HSL (rotation around probe axis) ± 0.5 dB in tissue material (rotation normal to probe axis)	
Dynamic Range	10 µW/g to 100 mW/g Linearity: ± 0.2 dB (noise: typically < 1 µW/g)	
Dimensions	Overall length: 330 mm (Tip: 20 mm) Tip diameter: 2.5 mm (Body: 12 mm) Typical distance from probe tip to dipole centers: 1 mm	
Application	High precision dosimetric measurements in any exposure scenario (e.g., very strong gradient fields). Only probe which enables compliance testing for frequencies up to 6 GHz with precision of better 30%.	



5.3 Data Acquisition Electronics (DAE)

The data acquisition electronics (DAE) consists of a highly sensitive electrometer-grade preamplifier with auto-zeroing, a channel and gain-switching multiplexer, a fast 16 bit AD-converter and a command decoder and control logic unit. Transmission to the measurement server is accomplished through an optical downlink for data and status information as well as an optical uplink for commands and the clock. The input impedance of the DAE4 is 200M Ohm; the inputs are symmetrical and floating. Common mode rejection is above 80dB.

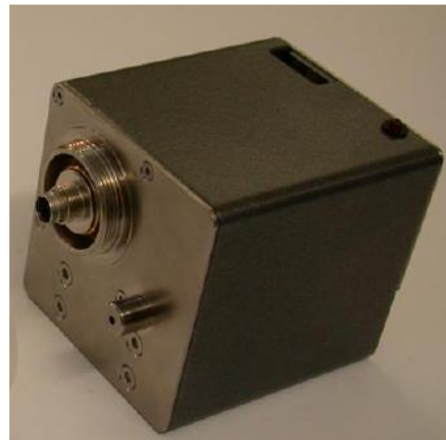

5.4 Robot

The DASY5 system uses the high precision robots TX90 XL type out of the newer series from Stäubli SA (France). For the 6-axis controller DASY5 system, the CS8C robot controller version from Stäubli is used. The XL robot series have many features that are important for our application:

- High precision (repeatability 0.02 mm)
- High reliability (industrial design)
- Jerk-free straight movements
- Low ELF interference (the closed metallic construction shields against motor control fields)
- 6-axis controller





5.5 Measurement Server

The light beam switch allows automatic "tooling" of the probe. During the process, the actual position of the probe tip with respect to the robot arm is measured, as well as the probe length and the horizontal probe offset. The software then corrects all movements, such that the robot coordinates are valid for the probe tip.

The repeatability of this process is better than 0.1 mm. If a position has been taught with an aligned probe, the same position will be reached with another aligned probe within 0.1 mm, even if the other probe has different dimensions. During probe rotations, the probe tip will keep its actual position.





5.6 Measurement Server

The DASY5 measurement server is based on a PC/104 CPU board with a 400MHz intel ULV Celeron, 112MB chipdisk and 112MB RAM. The necessary circuits for communication with the DAE electronics box, as well as the 16 bit AD converter system for optical detection and digital I/O interface are contained on the DASY5 I/O board, which is directly connected to the PC/104 bus of the CPU board.





5.7 SAM Phantom

<p>The SAM twin phantom is a fiberglass shell phantom with 2mm shell thickness (except the ear region where shell thickness increases to 6mm). It has three measurement areas:</p> <ul style="list-style-type: none">■ Left head■ Right head■ Flat phantom	
<p>The ELI4 Phantom also is a fiberglass shell phantom with 2mm shell thickness. It has 30 liters filling volume, and with a dimension of 600mm for major ellipse axis, 400mm for minor axis. It is intended for compliance testing of handheld and body-mounted wireless devices in frequency range of 30 MHz to 6GHz. ELI4 is fully compatible with standard and all known tissue simulating liquids.</p>	
<p>The bottom plate contains three pair of bolts for locking the device holder. The device holder positions are adjusted to the standard measurement positions in the three sections. A white cover is provided to tap the phantom during off-periods to prevent water evaporation and changes in the liquid parameters. On the phantom top, three reference markers are provided to identify the phantom position with respect to the robot.</p>	



5.8 Device Holder

The DASY5 device holder is designed to cope with different positions given in the standard. It has two scales for the device rotation (with respect to the body axis) and the device inclination (with respect to the line between the ear reference points). The rotation center for both scales is the ear reference point (EPR). Thus the device needs no repositioning when changing the angles. The DASY5 device holder has been made out of low-loss POM material having the following dielectric parameters: relative permittivity $\epsilon_r = 3$ and loss tangent $\delta = 0.02$. The amount of dielectric material has been reduced in the closest vicinity of the device, since measurements have suggested that the influence of the clamp on the test results could thus be lowered.



The laptop extension is lightweight and made of POM, acrylic glass and foam. It fits easily on upper part of the mounting device in place of the phone positioned. The extension is fully compatible with the SAM Twin and ELI phantoms.

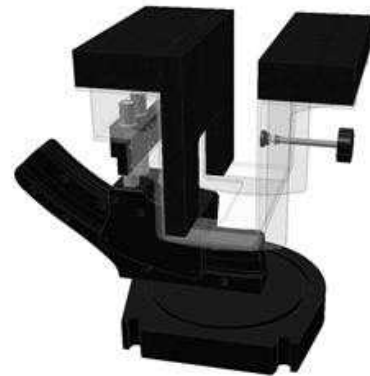



5.9 Test Equipment and Ancillaries Used for Tests

Name of Equipment	Manufacturer	Type/Model	Serial Number	Calibration Cycle(year)	Calibration Period
Robot	Staubli	TX60L Lspeag	F13/5P6VA1/A/01	/	NCR
DASY5 Test Software	Staubli	DASY5.2	14.6.14.7483	/	NCR
Signal Grenerator	Agilent	N5183A	MY50142931	1	2023/4/1
S-Parameter Network Analyzer	Agilent	E5071C	70045-459-220-350	1	2022/8/3
Dielectric parameter probes	SPEAG	DAKS-3.5	1121	N/A	NCR
Power Meter	Anritsu	ML2495A	1224005	1	2023/4/11
Power Sensor	Anritsu	MA2411B	1207295	1	2023/4/11
Power Meter	Anritsu	ML2495A	2034001	1	2022/9/22
Power Sensor	Anritsu	MA2411B	1911175	1	2022/9/22
Data Acquisition Electronics	SPEAG	DAE3	528	1	2023/5/18
Dosimetric E-Field Probe	SPEAG	EX3DV4	7375	1	2022/12/19
2450MHz System Validation Dipole	SPEAG	D2450V2	914	3	2024/8/26
Amplifier	Mini-Circuits	ZVE-8G+	70501814	/	NCR
Thermometer	Hi Sun	TH05A	11442	1	2023/7/11

*Please Refer to the Appendix A. DASY Calibration Certificate.

Note:

1. Prior to system verification and validation, the path loss from the signal generator to the system check source and the power meter, which includes the amplifier, cable, attenuator and directional coupler, was measured by the network analyzer. The reading of the power meter was offset by the path loss difference between the path to the power meter and the path to the system check source to monitor the actual power level fed to the system check source.
2. Referring to KDB 865664 D01v01r04, the dipole calibration interval can be extended to 3 years with justification. The dipoles are also not physically damaged, or repaired during the interval.
3. The justification data of dipole can be found in Appendix B. The return loss is < -20dB, within 20% of prior calibration, the impedance is within 5 ohm of prior calibration



6. The SAR Measurement Procedure

6.1 System Performance Check

6.1.1 Purpose

1. To verify the simulating liquids are valid for testing.
2. To verify the performance of testing system is valid for testing.

6.1.2 Tissue Dielectric Parameters for Head and Body Phantoms

Target Frequency (MHz)	Head		Body	
	ϵ_r	σ (S/m)	ϵ_r	σ (S/m)
150	52.3	0.76	61.9	0.8
300	45.3	0.87	58.2	0.92
450	43.5	0.87	56.7	0.94
835	41.5	0.9	55.2	0.97
850	41.5	0.92	55.2	0.99
900	41.5	0.97	55	1.05
915	41.5	0.98	55	1.06
1450	40.5	1.2	54	1.3
1610	40.3	1.29	53.8	1.4
1800 – 2000	40	1.4	53.3	1.52
2450	39.2	1.8	52.7	1.95
3000	38.5	2.4	52	2.73
5200	36	4.66	49	5.3
5250	35.95	4.71	48.9	5.4
5300	35.87	4.76	48.9	5.4
5600	35.5	5.07	48.5	5.8
5750	35.35	5.22	48.3	5.9
5800	35.3	5.27	48.2	6

(ϵ_r = relative permittivity, σ = conductivity and $\rho = 1000 \text{ kg/m}^3$)

According to April 2019 TCB workshop, Effective February 19,2019,FCC has permitted the use of single head-tissue simulating liquid specified in IEC 62209-1 for all SAR tests.



6.1.3 Tissue Calibration Result

- The dielectric parameters of the liquids were verified prior to the SAR evaluation using DASY5 Dielectric Assessment Kit and Agilent Vector Network Analyzer E5071C.

Please Refer to the Appendix B System Performance Check.

Note:

1. The Delta Permittivity% and Delta Conductivity% should be both within $\pm 5\%$ limit of target values.
2. Refer to KDB 865664 D01 v01r04, The depth of body tissue-equivalent liquid in a phantom must be ≥ 15.0 cm with $\leq \pm 0.5$ cm variation for SAR measurements ≤ 3 GHz and ≥ 10.0 cm with $\leq \pm 0.5$ cm variation for measurements > 3 GHz.



6.1.4 System Performance Check Procedure

The DASY5 installation includes predefined files with recommended procedures for measurements and the system performance check. They are read-only document files and destined as fully defined but unmeasured masks, so the finished system performance check must be saved under a different name. The system performance check document requires the SAM Twin Phantom or ELI4 Phantom, so the phantom must be properly installed in your system. (User defined measurement procedures can be created by opening a new document or editing an existing document file). Before you start the system performance check, you need only to tell the system with which components (probe, medium, and device) you are performing the system performance check; the system will take care of all parameters.

■ **The Power Reference Measurement and Power Drift Measurement** jobs are located at the beginning and end of the batch process. They measure the field drift at one single point in the liquid over the complete procedure. The indicated drift is mainly the variation of the Dipole output power. If it is too high (above ± 0.2 dB), the system performance check should be repeated;

■ **The Surface Check** job tests the optical surface detection system of the DASY5 system by repeatedly detecting the surface with the optical and mechanical surface detector and comparing the results. The output gives the detecting heights of both systems, the difference between the two systems and the standard deviation of the detection repeatability. Air bubbles or refraction in the liquid due to separation of the sugar-water mixture gives poor repeatability (above ± 0.1 mm). In that case it is better to abort the system performance check and stir the liquid;

■ **The Area Scan** job measures the SAR above the dipole on a plane parallel to the surface. It is used to locate the approximate location of the peak SAR. The proposed scan uses large grid spacing for faster measurement; due to the symmetric field, the peak detection is reliable;

■ **The Zoom Scan** job measures the field in a volume around the peak SAR value assessed in the previous Area Scan job (for more information see the application note on SAR evaluation). If the system performance check gives reasonable results. The dipole input power (forward power) was 250 mW, 1 g and 10 g spatial average SAR values normalized to 1 W dipole input power give reference data for comparisons and it's equal to $10 \times$ (dipole forward power). The next sections analyze the expected uncertainties of these values, as well as additional checks for further information or troubleshooting.



6.1.5 System Performance Check Setup

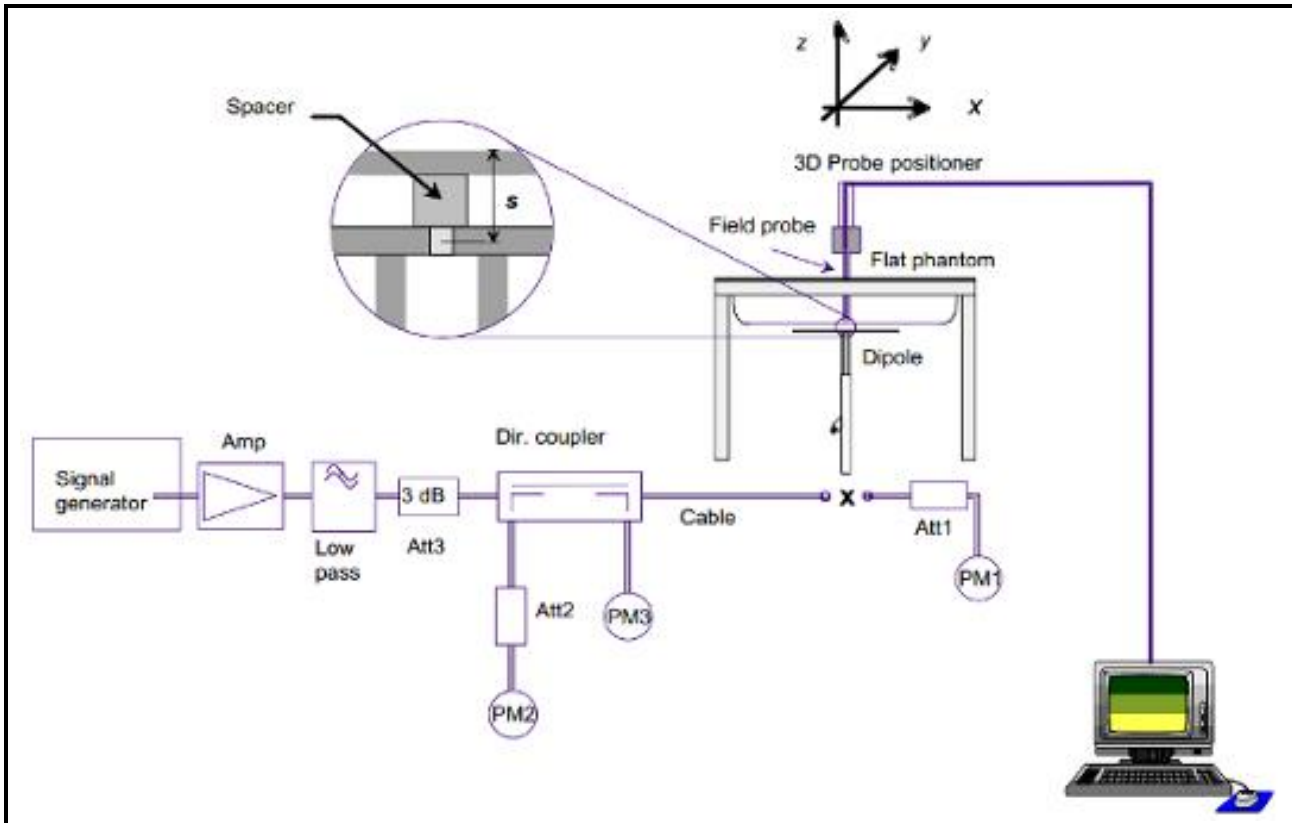

6.1.6 Validation Dipoles

The dipoles use is based on the IEEE Std.1528-2013 and FCC KDB 865664 D01 SAR Measurement 100 MHz to 6 GHz v01r04 standard, and is complied with mechanical and electrical specifications in line with the requirements of both EN62209-1 and EN62209-2. The table below provides details for the mechanical and electrical specifications for the dipoles.

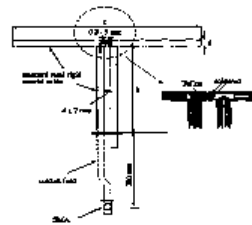

6.1.7 Result of System Performance Check: Valid Result

Please Refer to the Appendix B System Performance Check.



6.2 Test Requirements

6.2.1 Test Procedures

Step 1 Setup a Connection

First, engineer should record the conducted power before the test. Then establish a call in handset at the maximum power level with a base station simulator via air interface, or make the EUT estimate by itself in testing band. Place the EUT to the specific test location. After the testing, must export SAR test data by SEMCAD. Then writing down the conducted power of the EUT into the report, also the SAR values tested.

Step 2 Power Reference Measurements

To measure the local E-field value at a fixed location which value will be taken as a reference value for calculating a possible power drift.

Step 3 Area Scan

The Area Scan is used as a fast scan in two dimensions to find the area of high field values, before doing a fine measurement around the hot spot. The sophisticated interpolation routines implemented in DASY software can find the maximum locations even in relatively coarse grids. When an Area Scan has measured all reachable points, it computes the field maximal found in the scanned area, within a range of the global maximum. The range (in dB) is specified in the standards for compliance testing. For example, a 2 dB range is required in IEEE Standard 1528 and IEC 62209 standards, whereby 3 dB is a requirement when compliance is assessed in accordance with the ARIB standard (Japan). If only one Zoom Scan follows the Area Scan, then only the absolute maximum will be taken as reference. For cases where multiple maximums are detected, the number of Zoom Scans has to be increased accordingly.

Area Scan Parameters extracted from KDB 865664 D01v01r04

	≤ 3 GHz	> 3 GHz
Maximum distance from closest measurement point (geometric center of probe sensors) to phantom surface	5 ± 1 mm	$\frac{1}{2} \cdot \delta \cdot \ln(2) \pm 0.5$ mm
Maximum probe angle from probe axis to phantom surface normal at the measurement location	30° ± 1°	20° ± 1°
Maximum area scan spatial resolution: Δx_{Area} , Δy_{Area}	≤ 2 GHz: ≤ 15 mm 2 – 3 GHz: ≤ 12 mm	3 – 4 GHz: ≤ 12 mm 4 – 6 GHz: ≤ 10 mm
	When the x or y dimension of the test device, in the measurement plane orientation, is smaller than the above, the measurement resolution must be ≤ the corresponding x or y dimension of the test device with at least one measurement point on the test device.	



Step 4 Zoom Scan

Zoom Scans are used to assess the peak spatial SAR values within a cubic averaging volume containing 1 g and 10 g of simulated tissue. The Zoom Scan measures points (refer to table below) within a cube whose base faces are centered on the maxima found in a preceding area scan job within the same procedure. When the measurement is done, the Zoom Scan evaluates the averaged SAR for 1 g and 10 g and displays these values next to the job’s label.

Zoom Scan Parameters extracted from KDB 865664 D01 v01r04

			≤ 3 GHz	> 3 GHz
Maximum zoom scan spatial resolution: Δx_{Zoom} , Δy_{Zoom}			≤ 2 GHz: ≤ 8 mm $2 - 3$ GHz: ≤ 5 mm*	$3 - 4$ GHz: ≤ 5 mm* $4 - 6$ GHz: ≤ 4 mm*
Maximum zoom scan spatial resolution, normal to phantom surface	uniform grid: $\Delta z_{Zoom}(n)$		≤ 5 mm	$3 - 4$ GHz: ≤ 4 mm $4 - 5$ GHz: ≤ 3 mm $5 - 6$ GHz: ≤ 2 mm
	graded grid	$\Delta z_{Zoom}(1)$: between 1 st two points closest to phantom surface	≤ 4 mm	$3 - 4$ GHz: ≤ 3 mm $4 - 5$ GHz: ≤ 2.5 mm $5 - 6$ GHz: ≤ 2 mm
		$\Delta z_{Zoom}(n>1)$: between subsequent points	$\leq 1.5 \cdot \Delta z_{Zoom}(n-1)$	
Minimum zoom scan volume	x, y, z	≥ 30 mm	$3 - 4$ GHz: ≥ 28 mm $4 - 5$ GHz: ≥ 25 mm $5 - 6$ GHz: ≥ 22 mm	
Note: δ is the penetration depth of a plane-wave at normal incidence to the tissue medium; see draft standard IEEE P1528-2011 for details. * When zoom scan is required and the <i>reported</i> SAR from the <i>area scan based 1-g SAR estimation</i> procedures of KDB 447498 is ≤ 1.4 W/kg, ≤ 8 mm, ≤ 7 mm and ≤ 5 mm zoom scan resolution may be applied, respectively, for 2 GHz to 3 GHz, 3 GHz to 4 GHz and 4 GHz to 6 GHz.				

Step 5 Power Drift Measurements

Repetition of the E-field measurement at the fixed location mentioned in Step 1 to make sure the two results differ by less than ± 0.2 dB.



6.3 RF Exposure Positions

6.3.1 Ear and handset reference point

Figure 9.1.1 shows the front, back, and side views of the SAM phantom. The center-of-mouth reference point is labeled “M,” the left ear reference point (ERP) is marked “LE,” and the right ERP is marked “RE.” Each ERP is 15 mm along the B-M (back-mouth) line behind the entrance-to-ear-canal (EEC) point, as shown in Figure 9.1.2 The Reference Plane is defined as passing through the two ear reference points and point M. The line N-F (neck-front), also called the reference pivoting line, is normal to the Reference Plane and perpendicular to both a line passing through RE and LE and the B-M line (see Figure 9.1.3). Both N-F and B-M lines should be marked on the exterior of the phantom shell to facilitate handset positioning. Posterior to the N-F line the ear shape is a flat surface with 6 mm thickness at each ERP, and forward of the N-F line the ear is truncated, as illustrated in Figure 9.1.2. The ear truncation is introduced to preclude the ear lobe from interfering with handset tilt, which could lead to unstable positioning at the cheek.

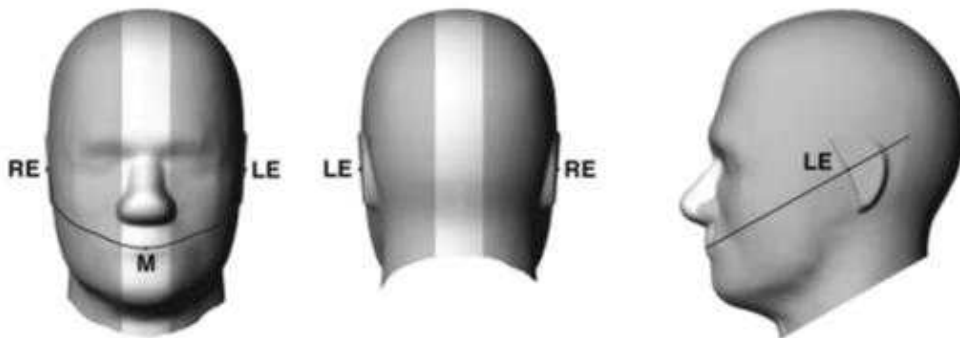

Fig 9.1.1 Front, back, and side views of SAM twin phantom

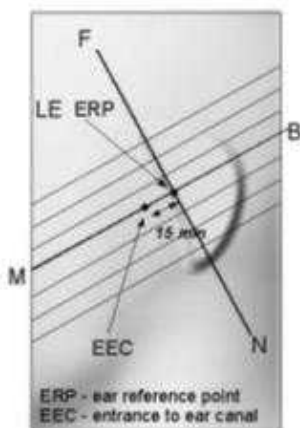

Fig 9.1.2 Close-up side view of phantom showing the ear region.

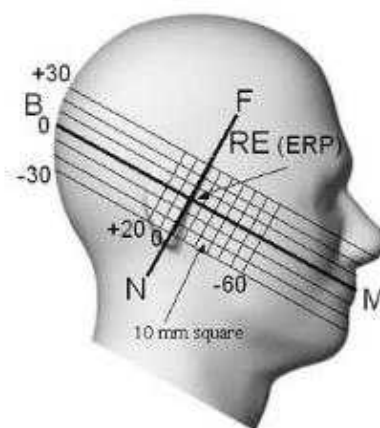

Fig 9.1.3 Side view of the phantom showing relevant markings and seven cross-sectional plane locations



6.3.2 Measurement Evaluation

Per KDB248227 D01 v02r02, channel selection procedures below apply to both the initial test configuration and subsequent test configuration(s):

- 1) 802.11a is chosen over 802.11n then 802.11ac or 802.11g is chosen over 802.11n.
- 2) The largest channel bandwidth configuration is selected among the multiple configurations in a frequency band with the same specified maximum output power.
- 3) If multiple configurations have the same specified maximum output power and largest channel bandwidth, the lowest order modulation among the largest channel bandwidth configurations is selected.
- 4) If multiple configurations have the same specified maximum output power, largest channel bandwidth and lowest order modulation, the lowest data rate configuration among these configurations is selected.
- 5) The same procedures also apply to subsequent highest output power channel(s) selection.
 - a> The channel closest to mid-band frequency is selected for SAR measurement.
 - b> For channels with equal separation from mid-band frequency; for example, high and low channels or two mid-band channels, the higher frequency (number) channel is selected for SAR measurement.



7. SRD SAR Exclusion and Results

7.1 Measured Conducted Average Power

Please Refer to the Appendix C Measured Conducted Power.



7.2 Antenna Location

Headset

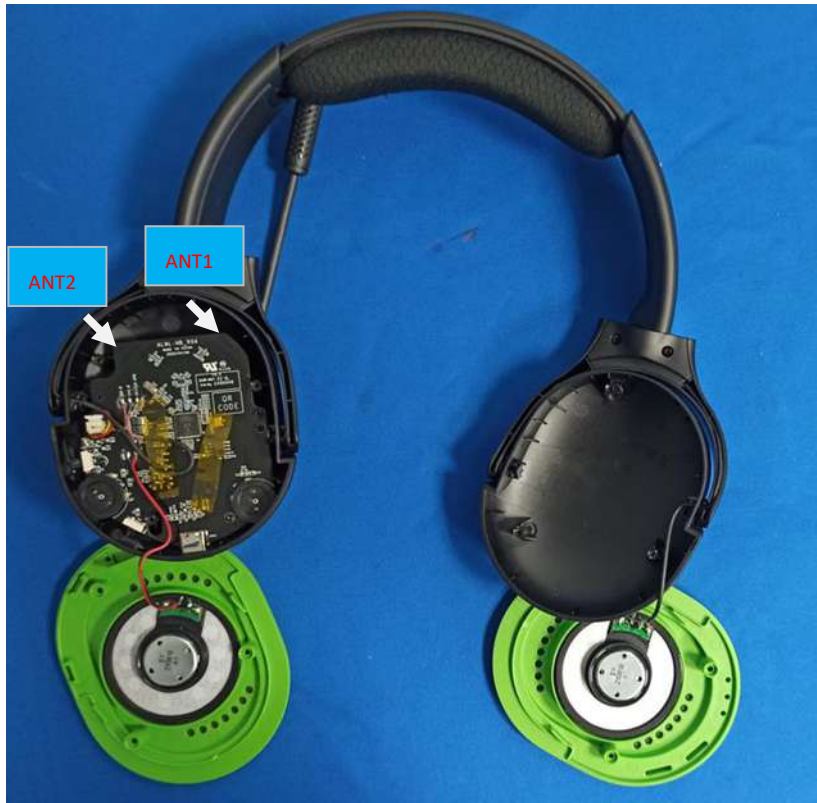

Antennas	Wireless Interface
Main Ant 1	SRD
Aux Ant 2	SRD



7.3 SAR Test Results Summary

Please Refer to the Appendix D SAR measurement data.

General Note:

1. Per KDB 447498 D01v06, the reported SAR is the measured SAR value adjusted for maximum tune-up tolerance.
 - a. Tune-up scaling Factor = tune-up limit power (mW) / EUT RF power (mW), where tune-up limit is the maximum rated power among all production units.
 - b. For SAR testing of WLAN signal with non-100% duty cycle, the measured SAR is scaled-up by the duty cycle scaling factor which is equal to "1/(duty cycle)"
 - c. For WWAN: Reported SAR(W/kg)= Measured SAR(W/kg)*Tune-up Scaling Factor
 - d. For WLAN/Bluetooth: Reported SAR(W/kg)= Measured SAR(W/kg)* Duty Cycle scaling factor
* Tune-up scaling factor
2. Per KDB 447498 D01v06, for each exposure position, testing of other required channels within the operating mode of a frequency band is not required when the reported 1-g or 10-g SAR for the mid-band or highest output power channel is:
 - ≤ 0.8 W/kg or 2.0 W/kg, for 1-g or 10-g respectively, when the transmission band is ≤ 100 MHz
 - ≤ 0.6 W/kg or 1.5 W/kg, for 1-g or 10-g respectively, when the transmission band is between 100 MHz and 200 MHz
 - ≤ 0.4 W/kg or 1.0 W/kg, for 1-g or 10-g respectively, when the transmission band is ≥ 200 MHz
3. Per KDB 865664 D01v01r04, for each frequency band, repeated SAR measurement is required only when the measured SAR is ≥ 0.8 W/kg.

WLAN Note:

1. Per KDB248227 D01 v02r02 section 5.2.1 2), when the reported SAR is > 0.8 W/kg, SAR is required for that exposure configuration using the next highest measured output power channel. When any reported SAR is > 1.2 W/kg, SAR is required for the third channel; i.e., all channels require testing.
2. When the highest reported SAR for DSSS is adjusted by the ratio of OFDM to DSSS specified maximum output power and the adjusted SAR is ≤ 1.2 W/kg, 802.11g/n OFDM SAR is not required, per KDB248227 D01 v02r01 section 5.2.2 2).



7.4 SAR Measurement Variability

According to KDB 865664 D01v01r04, SAR measurement variability must be assessed for each frequency band, which is determined by the SAR probe calibration point and tissue-equivalent medium used for the device measurements. When both head and body tissue-equivalent media are required for SAR measurements in a frequency band, the variability measurement procedures should be applied to the tissue medium with the highest measured SAR, using the highest measured SAR configuration for that tissue-equivalent medium. The following procedures are applied to determine if repeated measurements are required:

1. The original highest measured Reported SAR 1-g is ≥ 0.80 W/kg, repeated that measurement once.
2. Perform a second repeated measurement the ratio of the largest to the smallest SAR for the original and first repeated measurements is <1.2 W/kg, or when the original or repeated measurement is ≥ 1.45 W/kg (~10% from the 1-g SAR limit).

N/A



8. Simultaneous Transmission Analysis

1. The reported SAR summation is calculated based on the same configuration and test position.
8. Per KDB 447498 D01v06, simultaneous transmission SAR is compliant if,
 - i) Scalar SAR summation $< 1.6\text{W/kg}$.
 - ii) $\text{SPLSR} = (\text{SAR1} + \text{SAR2})^{1.5} / (\text{min. separation distance, mm})$, and the peak separation distance is determined from the square root of $[(x1-x2)^2 + (y1-y2)^2 + (z1-z2)^2]$, where $(x1, y1, z1)$ and $(x2, y2, z2)$ are the coordinates of the extrapolated peak SAR locations in the zoom scan.
 - iii) If $\text{SPLSR} \leq 0.04$, simultaneously transmission SAR measurement is not necessary.
 - iv) Simultaneously transmission SAR measurement, and the reported multi-band SAR $< 1.6\text{W/kg}$.
 - v) The SPLSR calculated results please refer to section 8.2.

8.1 Co-location

N/A

8.2 SPLSR Evaluation

N/A



9. Measurement Uncertainty

DASY5 Uncertainty Budget According to IEEE 1528-2013 and IEC 62209-1/201x (3 - 6 GHz range)								
Error Description	Uncertainty Value (±%)	Probability	Divisor	(Ci) 1g	(Ci) 10g	Standard Uncertainty (1g) (±%)	Standard Uncertainty (10g) (±%)	(Vi) Veff
Measurement System								
Probe Calibration	6.55	N	1	1	1	6.6	6.6	∞
Axial Isotropy	4.70	R	1.732	0.7	0.7	1.9	1.9	∞
Hemispherical Isotropy	9.60	R	1.732	0.7	0.7	3.9	3.9	∞
Boundary Effects	2.00	R	1.732	1	1	1.2	1.2	∞
Linearity	4.70	R	1.732	1	1	2.7	2.7	∞
System Detection Limits	0.25	R	1.732	1	1	0.1	0.1	∞
Modulation Response	2.40	R	1.732	1	1	1.4	1.4	∞
Readout Electronics	0.30	N	1	1	1	0.3	0.3	∞
Response Time	0.00	R	1.732	1	1	0.0	0.0	∞
Integration Time	2.60	R	1.732	1	1	1.5	1.5	∞
RF Ambient Noise	3.00	R	1.732	1	1	1.7	1.7	∞
RF Ambient Reflections	3.00	R	1.732	1	1	1.7	1.7	∞
Probe Positioner	0.80	R	1.732	1	1	0.5	0.5	∞
Probe Positioning	6.70	R	1.732	1	1	3.9	3.9	∞
Max. SAR Eval.	2.00	R	1.732	1	1	1.2	1.2	∞
Test Sample Related								
Device Positioning	2.90	N	1	1	1	2.9	2.9	145
Device Holder	3.60	N	1	1	1	3.6	3.6	5
Power Drift	5.00	R	1.732	1	1	2.9	2.9	∞
Power Scaling	0.00	R	1.732	1	1	0.0	0.0	∞
Phantom and Setup								
Phantom Uncertainty	6.60	R	1.732	1	1	3.8	3.8	∞
SAR correction	1.90	R	1.732	1	0.84	1.1	0.9	∞
Liquid Conductivity (mea.)	2.50	R	1.732	0.78	0.71	1.1	1.0	∞
Temp. unc. - Conductivity	3.36	R	1.732	0.78	0.71	1.5	1.4	∞
Liquid Permittivity (mea.)	2.50	R	1.732	0.23	0.26	0.3	0.4	∞
Temp. unc. - Permittivity	0.40	R	1.732	0.23	0.26	0.1	0.1	∞
Combined Std. Uncertainty						12.1%	12.1%	614
Coverage Factor for 95 %						K=2	K=2	
Expanded STD Uncertainty						24.2%	24.1%	

-----THE END OF REPORT-----