



中国认可
国际互认
检测
TESTING
CNAS L3098



FCC CERTIFICATION TEST REPORT

For
FCC ID:X5B-051064
IC: 8814A-051064

Report Reference No..... : 16FAB05024 11

FCC 2.948 No..... : 923232

Date of issue..... : 2016-06-15

Testing Laboratory..... : ATT Product Service Co., Ltd.

Address..... : No. 3, ChangLianShan Industrial Park, ChangAn Town,
DongGuan City, GuangDong, China.

Applicant's name : Performance Designed Products, LLC

Address..... : 14144 Ventura Blvd, Suite 200 Sherman
Oaks,CA 91423 U.S.A

Manufacturer..... : Performance Designed Products, LLC

Test specification:

Test item description..... : Wireless Fender Jaguar Guitar Controller for PlayStation 4

Trade Mark : --

Model/Type reference : 051-064

Ratings..... : I/P: Battery 1.5Vdc*2

Responsible Engineer :

Smile Wang

Approved by:

Brown Lu

Authorized Signatory:

King Wang



中国认可
国际互认
检测
TESTING
CNAS L3098



TABLE OF CONTENTS

1.	Summary of test results	5
2.	General test information	6
2.1.	Description of EUT	6
2.2.	Accessories of EUT	6
2.3.	Assistant equipment used for test	6
2.4.	Block diagram of EUT configuration for test	7
2.5.	Test environment conditions	7
2.6.	Measurement uncertainty	8
3.	20dB Bandwidth & 99% Bandwidth	9
3.1.	Test equipment	9
3.2.	Block diagram of test setup	9
3.3.	Limits	9
3.4.	Test Procedure	9
3.5.	Test Result	10
3.6.	Original test data	10
4.	CARRIER FREQUENCY SEPARATION TEST	15
4.1.	Test equipment	15
4.2.	The Requirement For Section 15.247(a)(1)	15
4.3.	EUT Configuration on Measurement	15
4.4.	Operating Condition of EUT	15
4.5.	Test Procedure	15
4.6.	Test Result	16
5.	NUMBER OF HOPPING FREQUENCY TEST	22
5.1.	Test equipment	22
5.2.	The Requirement For Section 15.247(a)(1)(iii)	22
5.3.	EUT Configuration on Measurement	22
5.4.	Operating Condition of EUT	22
5.5.	Test Procedure	22
5.6.	Test Result	23
6.	DWELL TIME TEST	24
6.1.	Test equipment	24
6.2.	The Requirement For Section 15.247(a)(1)(iii)	24
6.3.	EUT Configuration on Measurement	24
6.4.	Operating Condition of EUT	24
6.5.	Test Procedure	24
6.6.	Test Result	25



中国认可
国际互认
检测
TESTING
CNAS L3098



7.	Maxmum Output Power	31
7.1.	Test equipment.....	31
7.2.	Block diagram of test setup	31
7.3.	Limits.....	31
7.4.	Test Procedure	32
7.5.	Test Result	32
7.6.	Original test data	33
8.	Spurious Emission	38
8.1.	Test equipment.....	38
8.2.	Block diagram of test setup	38
8.3.	Limit.....	40
8.4.	Test Procedure	41
8.5.	Test Result	43
9.	100 kHz BANDWIDTH OF FREQUENCY BAND EDGE	50
9.1.	Test Equipment	50
9.2.	Limit.....	50
9.3.	Test Procedure	50
9.4.	Test result.....	51
10.	Antenna Requirements.....	58
10.1.	Limit.....	58
10.2.	EUT ANTENNA.....	58



中国认可
国际互认
检测
TESTING
CNAS L3098



TEST REPORT DECLARE

Applicant	:	Performance Designed Products, LLC
Address	:	14144 Ventura Blvd, Suite 200 Sherman Oaks, CA 91423 U.S.A
Equipment under Test	:	Wireless Fender Jaguar Guitar Controller for PlayStation 4
Test Model No	:	051-064
Manufacturer	:	Performance Designed Products, LLC
Address	:	2300 West Empire Avenue Suite 600 Burbank CA 91504

Test Standard Used: RSS-247 ISSUE 1 May 28,2015; RSS-GEN ISSUE 4 NOV 2014
FCC Part 15 Subpart C: 2015.

Test procedure used: ANSI C63.4: 2014, ANSI C63.10-2013 , DA 00-705.

We Declare:

The equipment described above is tested by ATT Product Service Co., Ltd. and in the configuration tested the equipment complied with the standards specified above. The test results are contained in this test report and ATT Product Service Co., Ltd., Ltd. is assumed of full responsibility for the accuracy and completeness of these tests.

After test and evaluation, our opinion is that the equipment provided for test compliance with the requirement of the above FCC standards.

Report No:	16FAB05024 11		
Date of Test:	2016-05-13 To 2016-06-15	Date of Report:	2016-06-15

Note: This report applies to above tested sample only. This report shall not be reproduced in parts without written approval of ATT Product Service Co., Ltd.



中国认可
国际互认
检测
TESTING
CNAS L3098



1. SUMMARY OF TEST RESULTS

The EUT have been tested according to the applicable standards as referenced below.		
Description of Test Item	Standard	Results
Bandwidth	FCC Part 15: 15.247(a)(1) RSS 247 § 5.1.1	PASS
Carrier Frequency Separation Test	FCC Part 15: 15.247(a)(1) RSS 247 § 5.1.4	PASS
Number Of Hopping Frequency	FCC Part 15: 15.247(a)(1)(iii) RSS 247 § 5.1.4	PASS
Dwell Time Test	FCC Part 15: 15.247(a)(1)(iii) RSS 247 § 5.1.4	PASS
Maximum Output Power	FCC Part 15: 15.247(b)(1) RSS 247 § 5.4.2	PASS
Band Edge Emission	FCC Part 15: 15.247(c) RSS 247 § 5.5	N/A
Radiated Spurious Emissions	FCC Part 15.205 / 15.209 RSS 247 § 5.5	PASS
Antenna requirement	FCC Part 15: 15.203 RSS-Gen § 7.1.2	PASS
Conducted Emission	FCC Part 15.207 RSS 247 § 6.2	N/A



2. GENERAL TEST INFORMATION

2.1. DESCRIPTION OF EUT

EUT* Name	:	Wireless Fender Jaguar Guitar Controller for PlayStation 4
Model Number	:	051-064
EUT function description	:	Please reference user manual of this device
Power supply	:	Battery 1.5Vdc*2
Radio Technology	:	V2.1+EDR
Operation frequency	:	2402-2480MHz
Modulation	:	GFSK, $\pi/4$ DQPSK,8DPSK
Antenna Type	:	PIFA antenna, maximum PK gain: 1.95 dBi
Date of Receipt	:	2016/05/13
Sample Type	:	Single production

2.2. ACCESSORIES OF EUT

Description of Accessories	Manufacturer	Model number or Type	Output.
/	/	/	/

2.3. ASSISTANT EQUIPMENT USED FOR TEST

Description of Assistant equipment	Manufacturer	Model number or Type	EMC Compliance	SN
Notebook	acer	Aspire E1-472G	FCC DoC	/

2.4. BLOCK DIAGRAM OF EUT CONFIGURATION FOR TEST

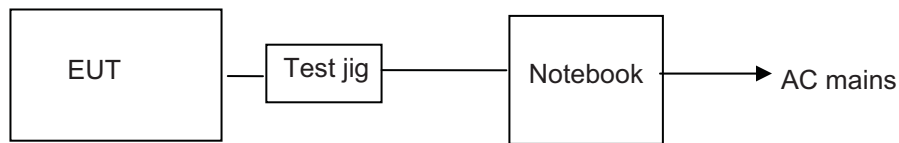

EUT was connected to control to a special test jig provided by manufacturer which has a Micro USB connector to connect to Notebook, and the Notebook will run a special test software to control EUT work in Continuous TX mode, and select test channel, wireless mode and data rate.

Remark: GFSK, 8DPSK, $\pi/4$ DQPSK all these modulation all have been tested, GFSK is found as worst case and only reported for radiated emission.

Tested mode, channel, and data rate information			
Mode	data rate (Mbps) (see Note)	Channel	Frequency (MHz)
GFSK	1	Low :CH0	2402
	1	Middle: CH39	2441
	1	High: CH78	2480
$\pi/4$ DQPSK	2	Low :CH0	2402
	2	Middle: CH39	2441
	2	High: CH78	2480
8DPSK	3	Low :CH0	2402
	3	Middle: CH39	2441
	3	High: CH78	2480

Note: According exploratory test, EUT will have maximum output power in those data rate, so those data rate were used for all test.

2.5. TEST ENVIRONMENT CONDITIONS

During the measurement the environmental conditions were within the listed ranges:

Temperature range:	21-25°C
Humidity range:	40-75%
Pressure range:	86-106kPa



2.6. MEASUREMENT UNCERTAINTY

Test Item	Uncertainty
Uncertainty for Conduction emission test	2.44dB
Uncertainty for Radiation Emission test (9KHz-30MHz)	3.21dB
Uncertainty for Radiation Emission test (30MHz-200MHz)	3.42 dB (Polarize: V)
	3.52 dB (Polarize: H)
Uncertainty for Radiation Emission test (200MHz-1GHz)	3.52 dB (Polarize: V)
	3.54 dB (Polarize: H)
Uncertainty for Radiation Emission test (1GHz to 25GHz)	4.20 dB (Polarize: V)
	4.20 dB (Polarize: H)
Uncertainty for radio frequency	1×10^{-9}
Uncertainty for conducted RF Power	0.65dB

Note: This uncertainty represents an expanded uncertainty expressed at approximately the 95% confidence level using a coverage factor of k=2.



3. 20dB BANDWIDTH & 99% BANDWIDTH

3.1. TEST EQUIPMENT

Item	Equipment	Manufacturer	Model No.	Serial No.	Cal Due.	Cal. Interval
1	Spectrum analyzer	KEYSIGHT	N9010A	MY55150427	2017/05/05	1 Year
2	Attenuator	Mini-Circuits	BW-S10W2	101109	2016/12/19	1 Year
3	RF Cable	Micable	C10-01-01-1	100309	2016/12/19	1 Year

3.2. BLOCK DIAGRAM OF TEST SETUP

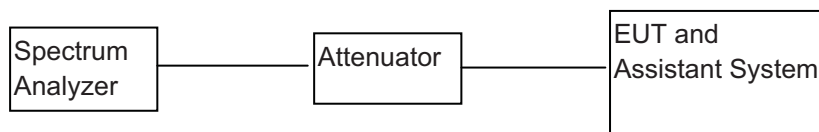

3.3. LIMITS

No limit requirement.

3.4. TEST PROCEDURE

- (1) Configure EUT and assistant system according clause 2.4 and 3.2.
- (2) Connect EUT's antenna output to spectrum analyzer by RF cable.
- (3) Configure EUT work in test mode as stated in clause 2.4.
- (4) Set the spectrum analyzer as follows:

RBW:	30KHz
VBW:	100KHz
Detector Mode:	Peak
Sweep time:	auto
Trace mode:	Max hold

- (5) Allow the trace to stabilize, measure the maximum width of the emission that is constrained by the frequencies associated with the two outermost amplitude points (upper and lower frequencies) that are attenuated by 20 dB and 99% bandwidth relative to the maximum level measured in the fundamental emission.



中国认可
国际互认
检测
TESTING
CNAS L3098



3.5. TEST RESULT

Mode	Freq	20dB	99%OBW	Conclusion
	(MHz)	(MHz)	(MHz)	
GFSK	2402	0.868	0.837	PASS
	2441	0.868	0.836	PASS
	2480	0.865	0.836	PASS
$\pi/4$ -DQPSK	2402	1.207	1.165	PASS
	2441	1.217	1.166	PASS
	2480	1.220	1.167	PASS
8DPSK	2402	1.203	1.148	PASS
	2441	1.206	1.144	PASS
	2480	1.205	1.145	PASS

3.6. ORIGINAL TEST DATA

GFSK

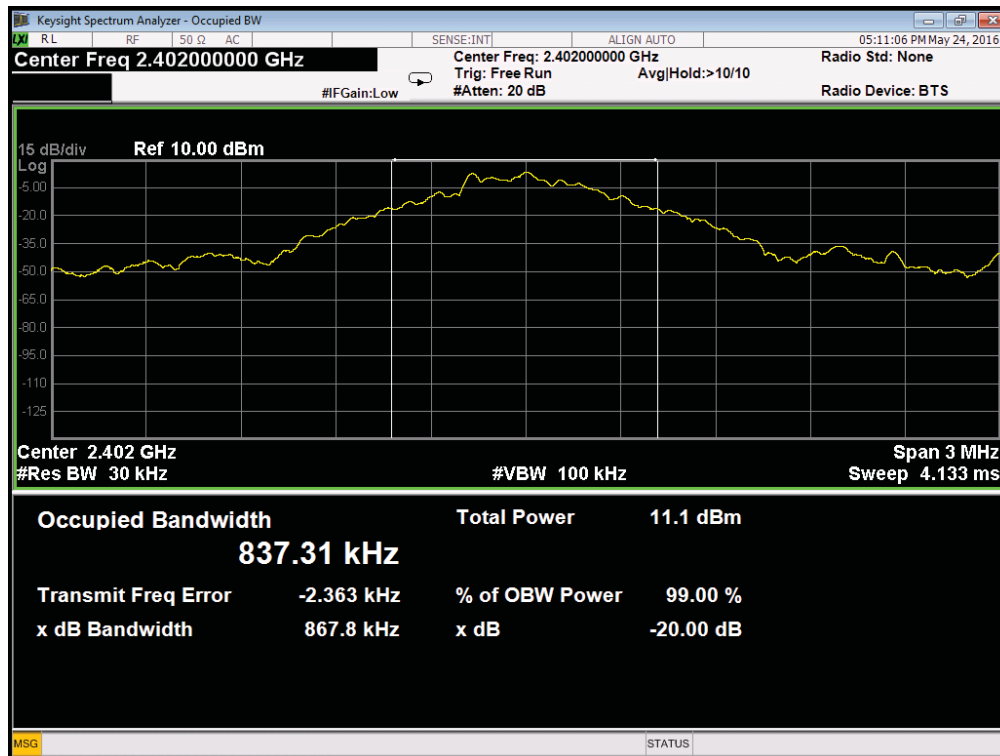



中国认可
国际互认
检测
TESTING
CNAS L3098

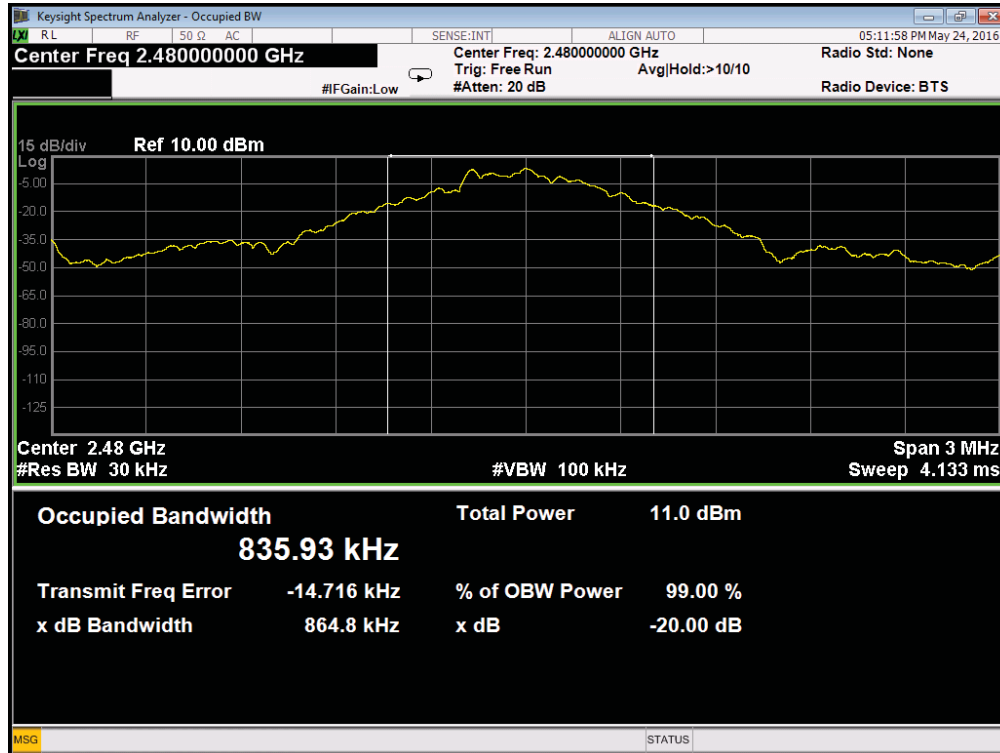
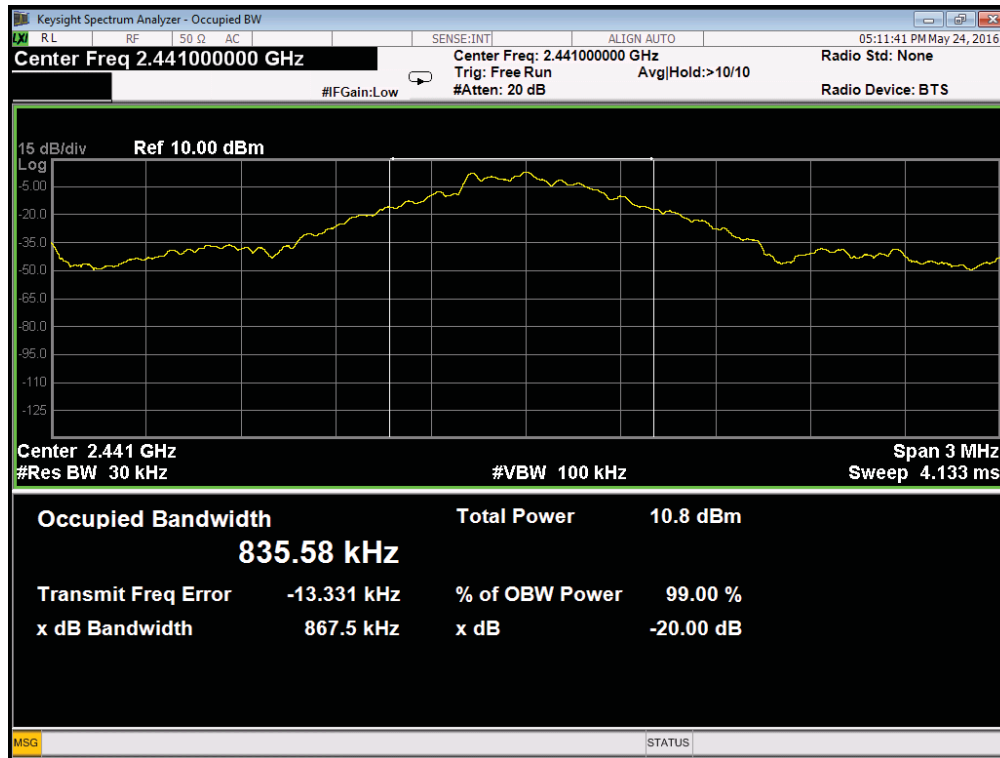



中国认可
国际互认
检测
TESTING
CNAS L3098



π /4DQPSK

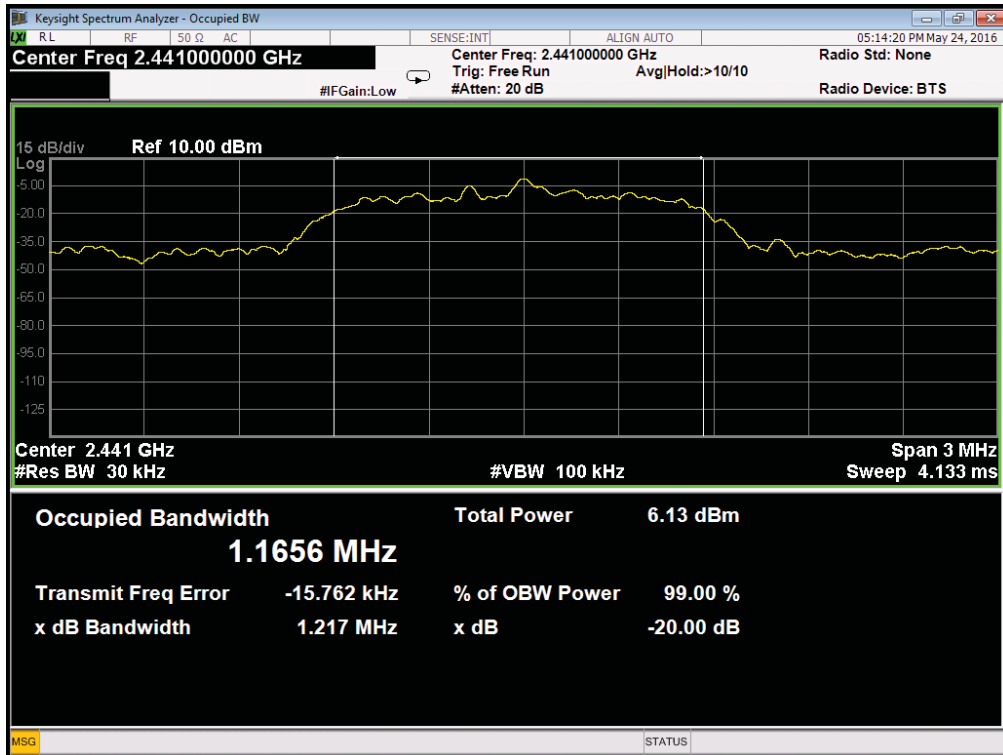
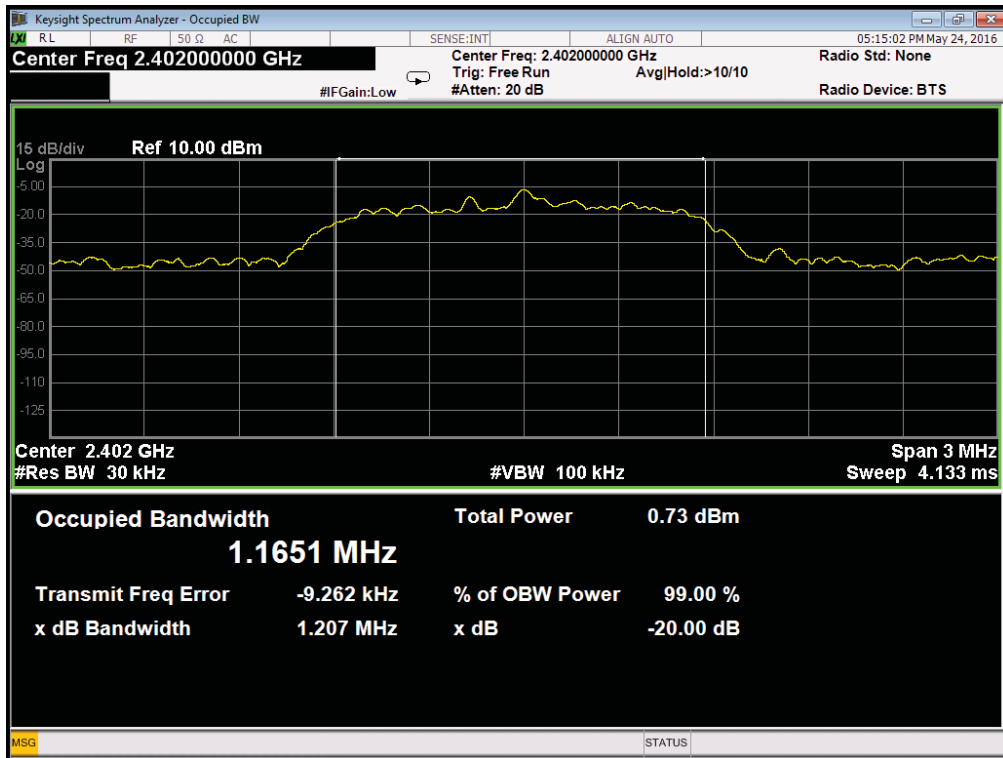



中国认可
国际互认
检测
TESTING
CNAS L3098

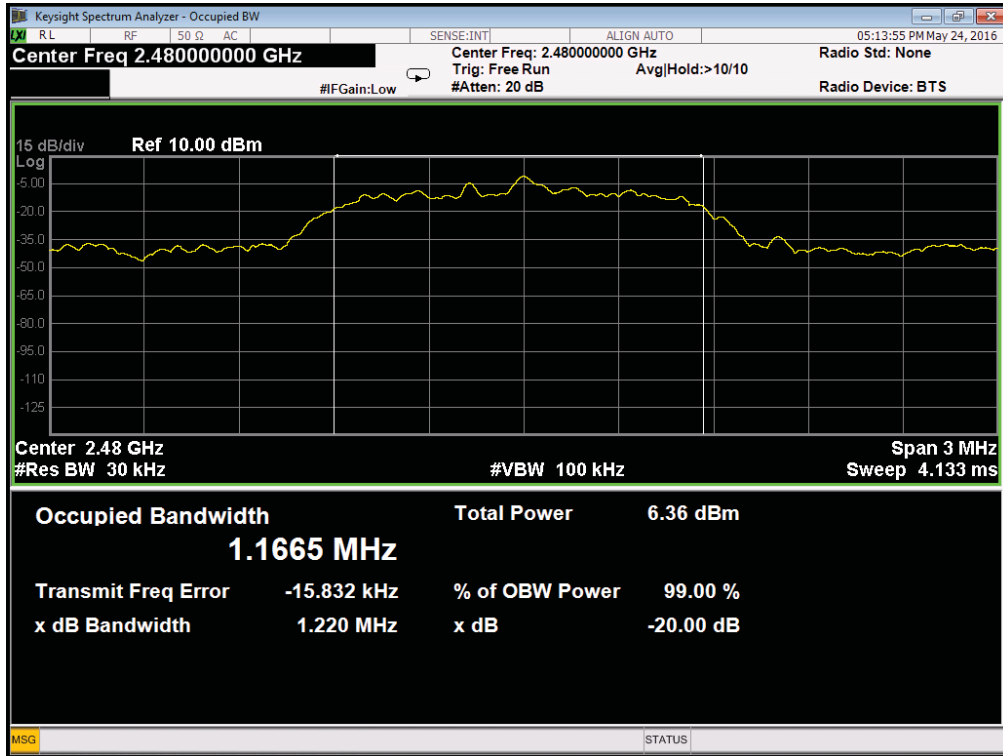

8DPSK

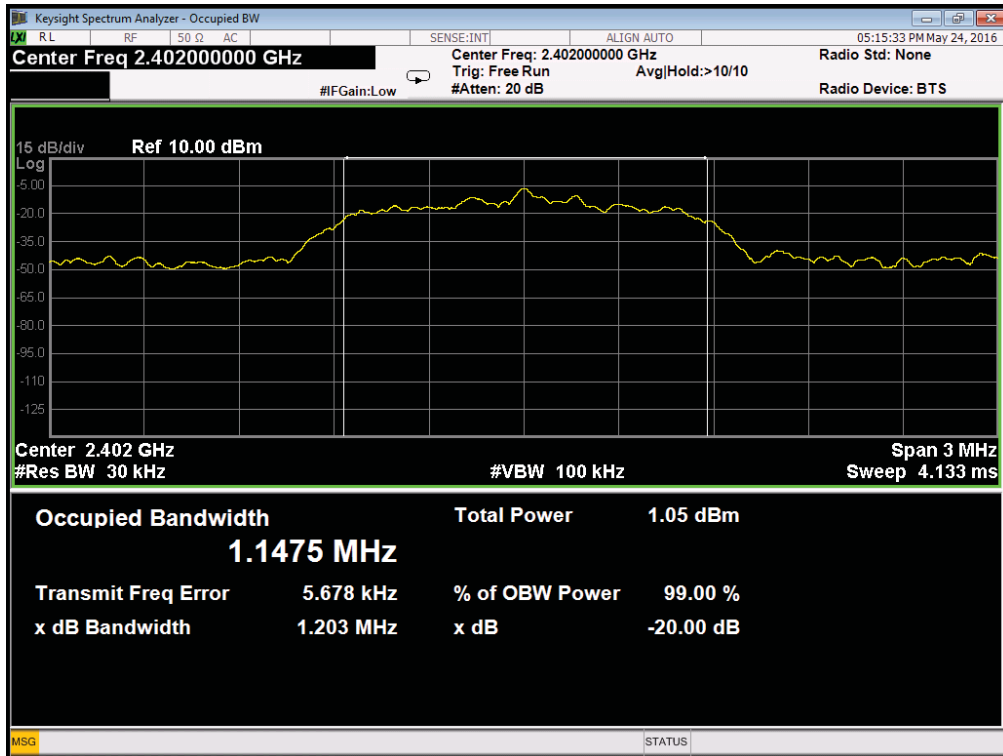



中国认可
国际互认
检测
TESTING
CNAS L3098

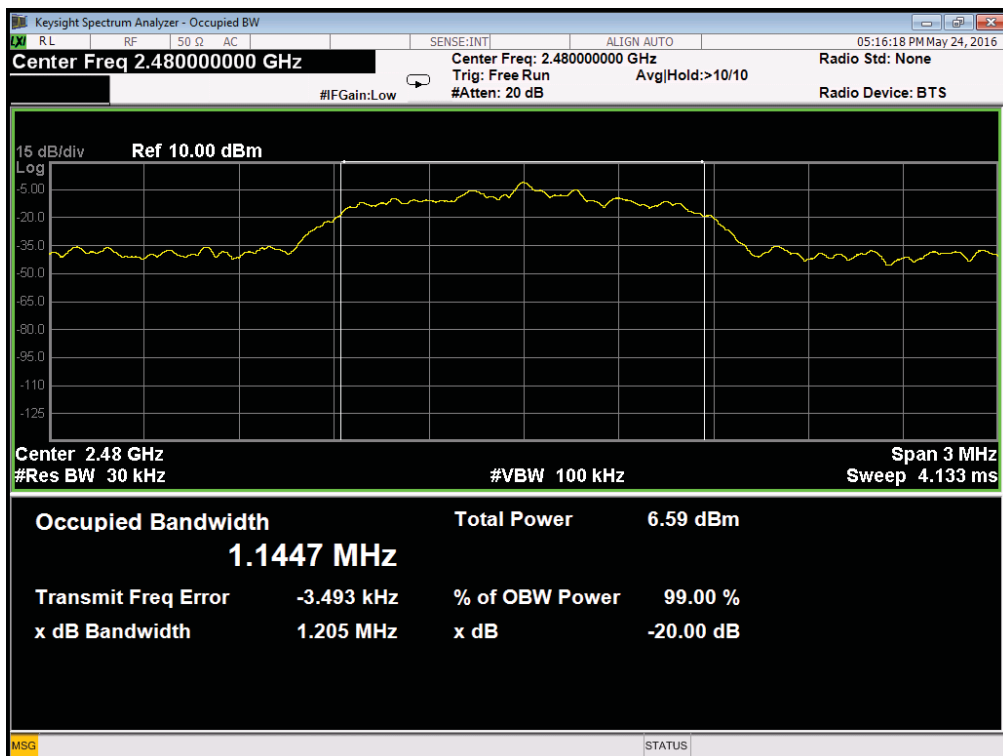
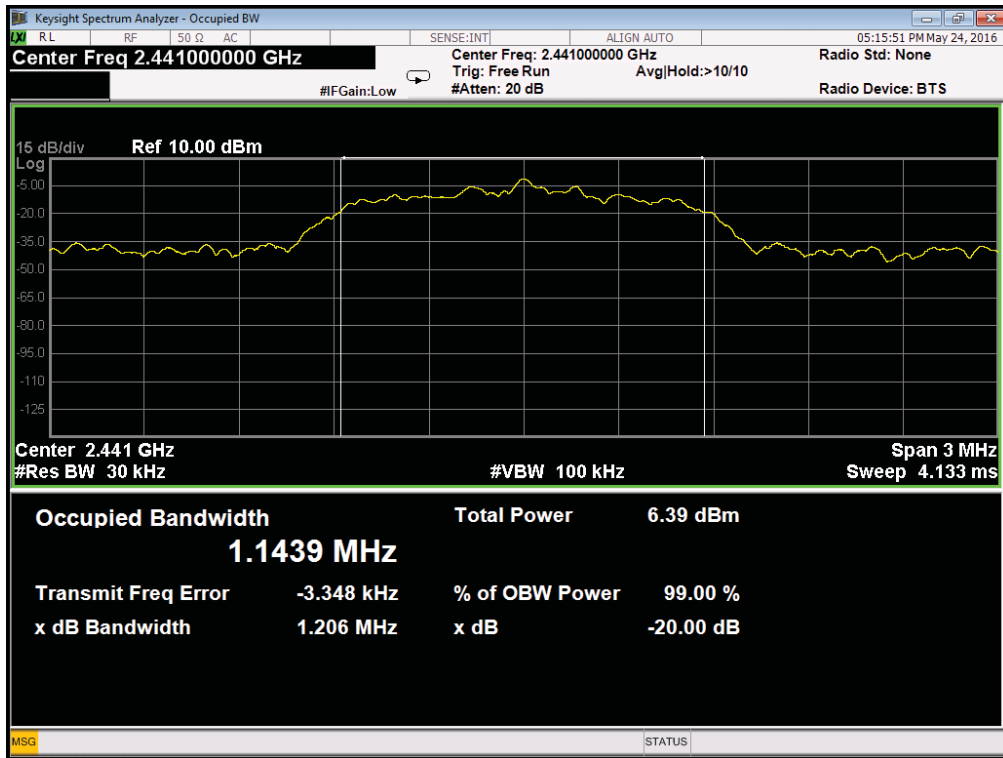



4. CARRIER FREQUENCY SEPARATION TEST

4.1. TEST EQUIPMENT

Item	Equipment	Manufacturer	Model No.	Serial No.	Cal Due.	Cal. Interval
1	Spectrum analyzer	KEYSIGHT	N9010A	MY55150427	2017/05/05	1 Year
2	Attenuator	Mini-Circuits	BW-S10W2	101109	2016/12/19	1 Year
3	RF Cable	Micable	C10-01-01-1	100309	2016/12/19	1 Year

4.2. THE REQUIREMENT FOR SECTION 15.247(A)(1)

Section 15.247(a)(1): Frequency hopping systems shall have hopping channel carrier frequencies separated by a minimum of 25 kHz or the 20 dB bandwidth of the hopping channel, whichever is greater. Alternatively, frequency hopping systems operating in the 2400-2483.5 MHz band may have hopping channel carrier frequencies that are separated by 25 kHz or two-thirds of the 20 dB bandwidth of the hopping channel, whichever is greater, provided the systems operate with an output power no greater than 125 mW. The system shall hop to channel frequencies that are selected at the system hopping rate from a pseudorandomly ordered list of hopping frequencies. Each frequency must be used equally on the average by each transmitter. The system receivers shall have input bandwidths that match the hopping channel bandwidths of their corresponding transmitters and shall shift frequencies in synchronization with the transmitted signals.

4.3. EUT CONFIGURATION ON MEASUREMENT

The equipment are installed on the emission measurement to meet the commission requirements and operating regulations in a manner which tends to maximize its emission characteristics in normal application.

4.4. OPERATING CONDITION OF EUT

- (1) Setup the EUT and simulator as shown as Section 6.1.
- (2) Turn on the power of all equipment.
- (3) Let the EUT work in TX (Hopping on) modes measure it. The transmit frequency are 2402-2480MHz.
We select 2402MHz, 2441MHz, and 2480MHz TX frequency to transmit.

4.5. TEST PROCEDURE

- (1) The transmitter output was connected to the spectrum analyzer through a low loss cable.
- (2) .Set RBW of spectrum analyzer to 30 kHz and VBW to 100 kHz. Adjust Span to 3 MHz.
- (3) Set the adjacent channel of the EUT maxhold another trace.
- (4) Measurement the channel separation



中国认可
国际互认
检测
TESTING
CNAS L3098



4.6. TEST RESULT

GFSK

Channel	Frequency (MHz)	Channel Separation(MHz)	Limit (MHz)	Result
Low	2402	1.005	>(25KHz or 2/3*20dB Bandwidth)	PASS
Middle	2441	1.011	>(25KHz or 2/3*20dB Bandwidth)	PASS
High	2479	0.981	>(25KHz or 2/3*20dB Bandwidth)	PASS

$\pi/4$ DQPSK

Channel	Frequency (MHz)	Channel Separation(MHz)	Limit (MHz)	Result
Low	2402	0.996	>(25KHz or 2/3*20dB Bandwidth)	PASS
Middle	2441	1.005	>(25KHz or 2/3*20dB Bandwidth)	PASS
High	2479	0.996	>(25KHz or 2/3*20dB Bandwidth)	PASS

8DPSK

Channel	Frequency (MHz)	Channel Separation(MHz)	Limit (MHz)	Result
Low	2402	1.002	>(25KHz or 2/3*20dB Bandwidth)	PASS
Middle	2441	1.011	>(25KHz or 2/3*20dB Bandwidth)	PASS
High	2479	0.993	>(25KHz or 2/3*20dB Bandwidth)	PASS

The spectrum analyzer plots are attached as below.



中国认可
国际互认
检测
TESTING
CNAS L3098



GFSK

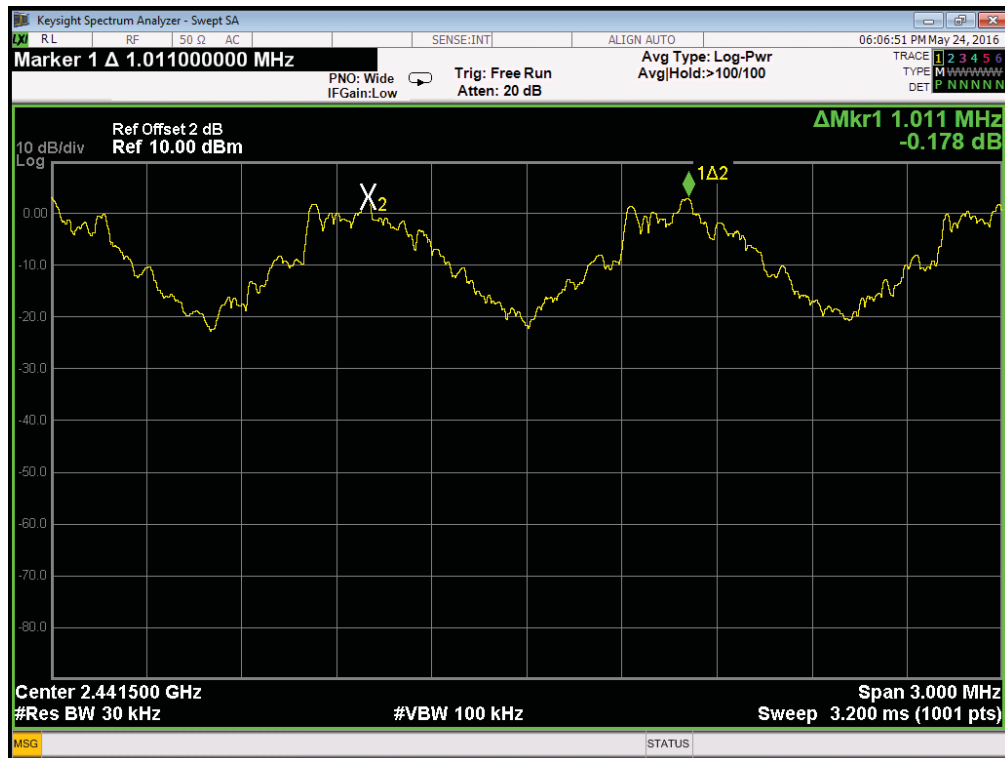



中国认可
国际互认
检测
TESTING
CNAS L3098

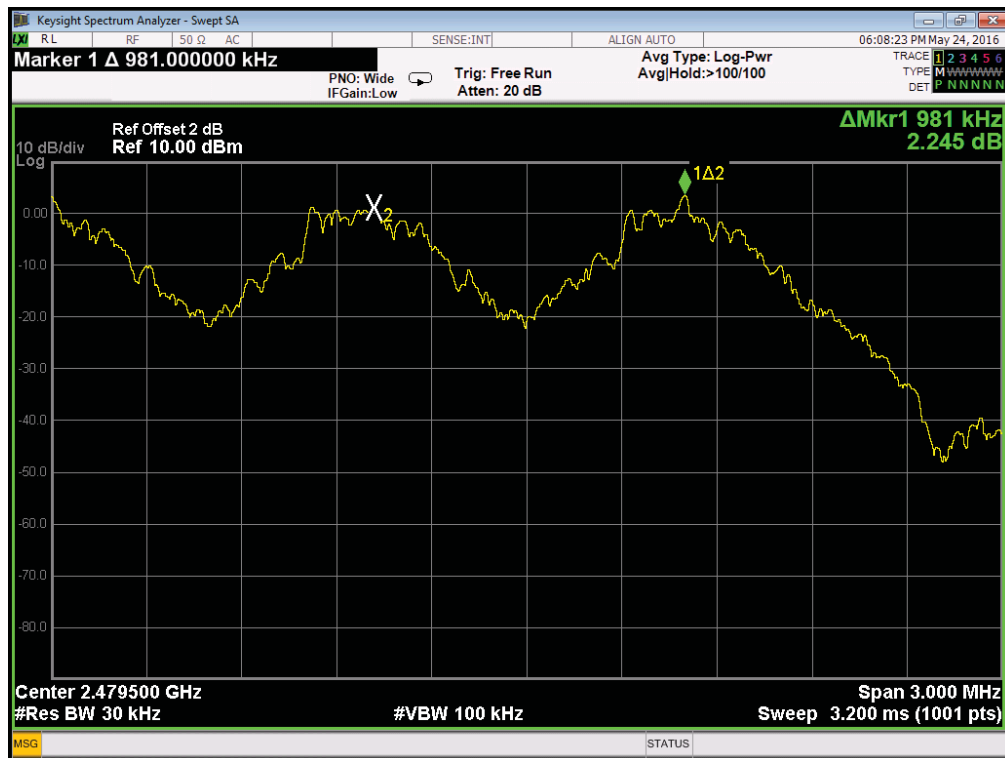

II /4-DQPSK

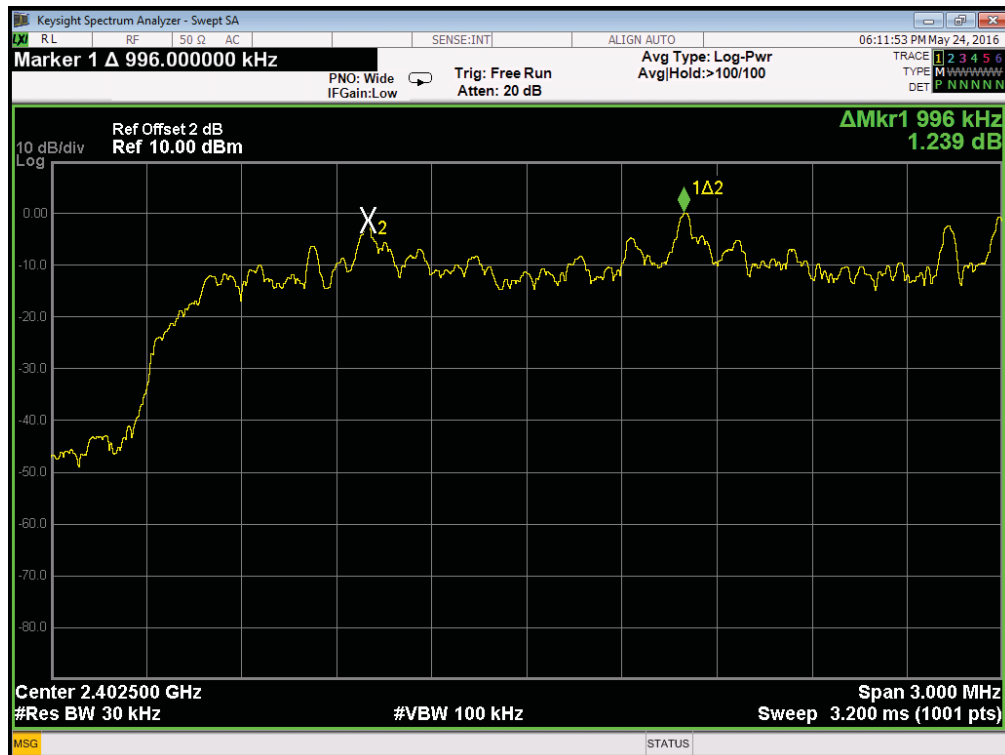



中国认可
国际互认
检测
TESTING
CNAS L3098

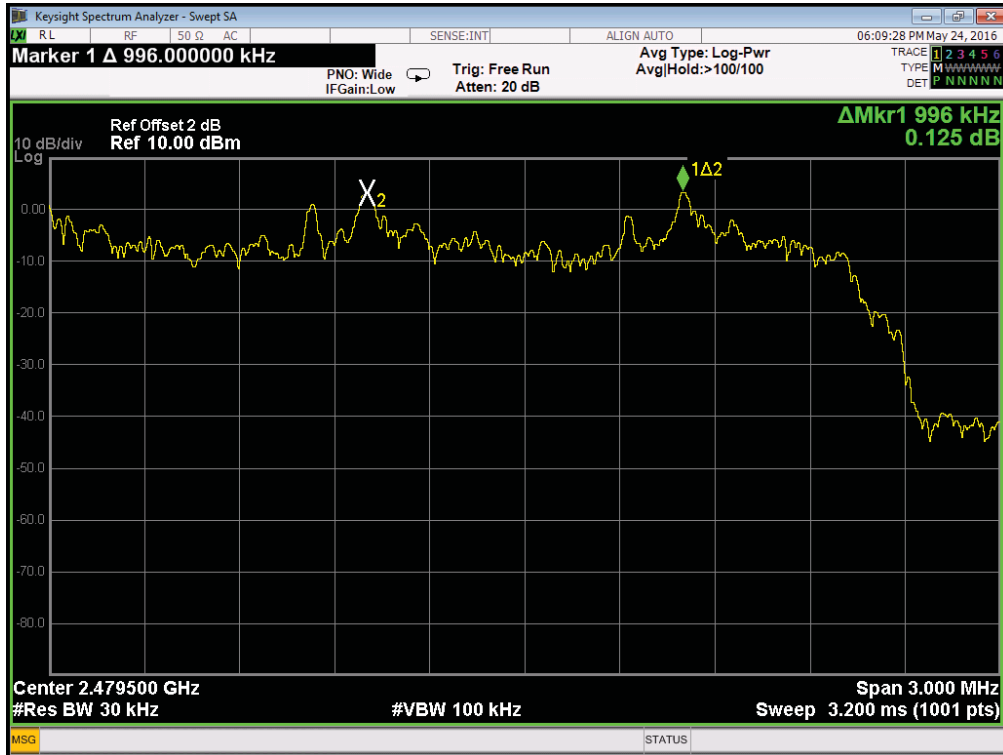
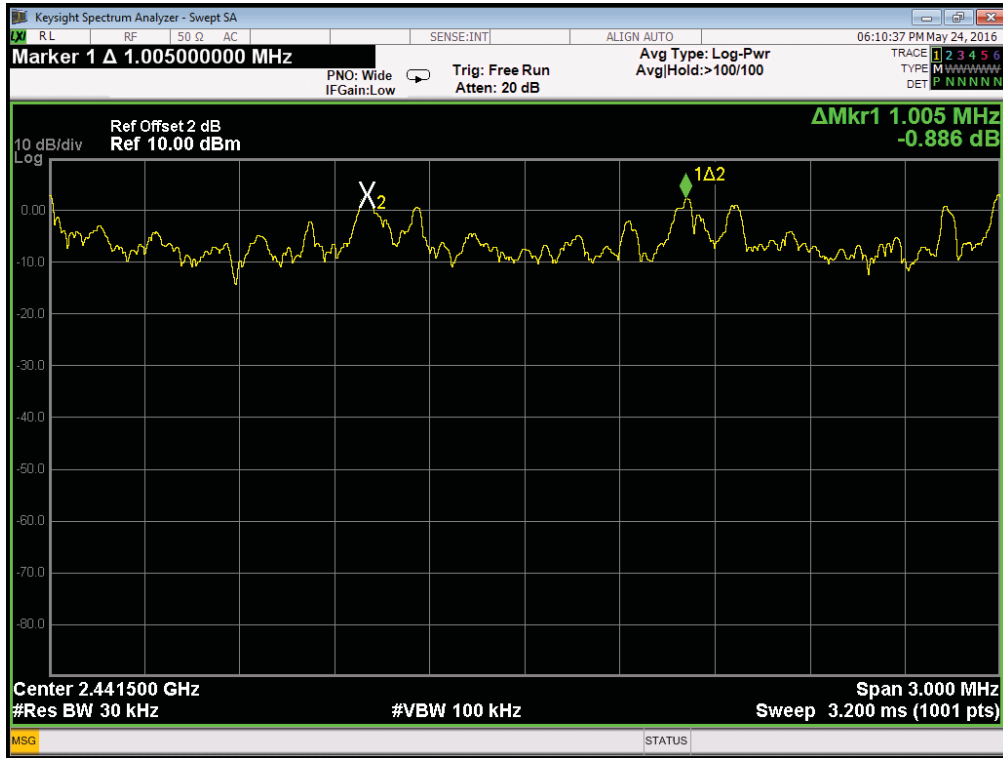



中国认可
国际互认
检测
TESTING
CNAS L3098



8DPSK

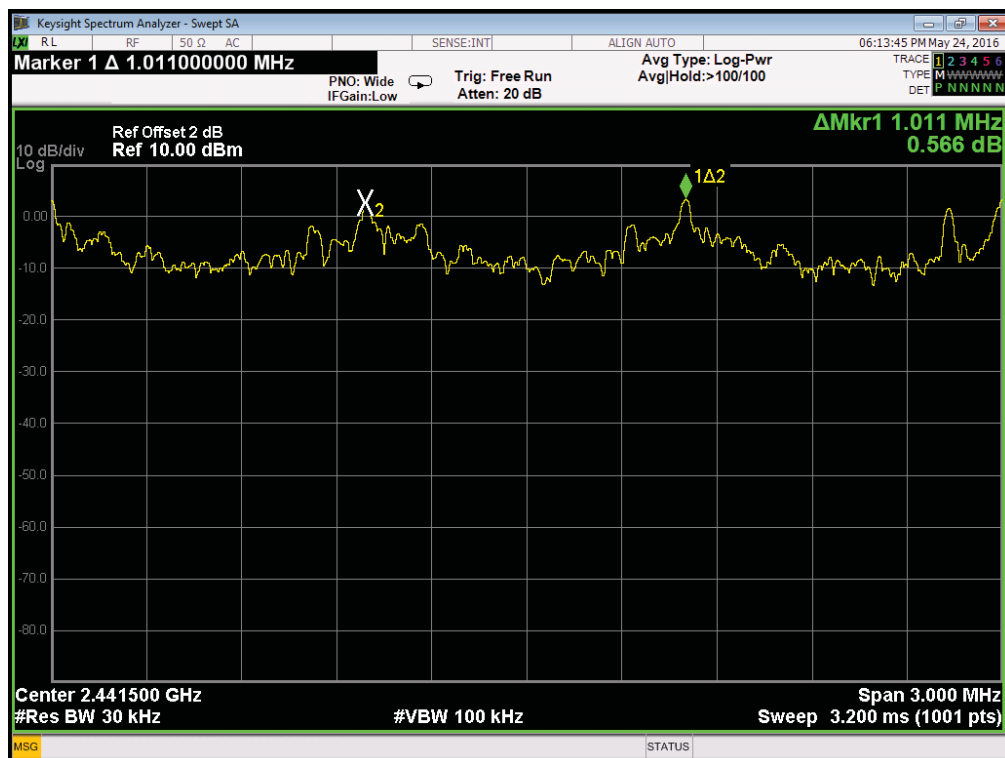
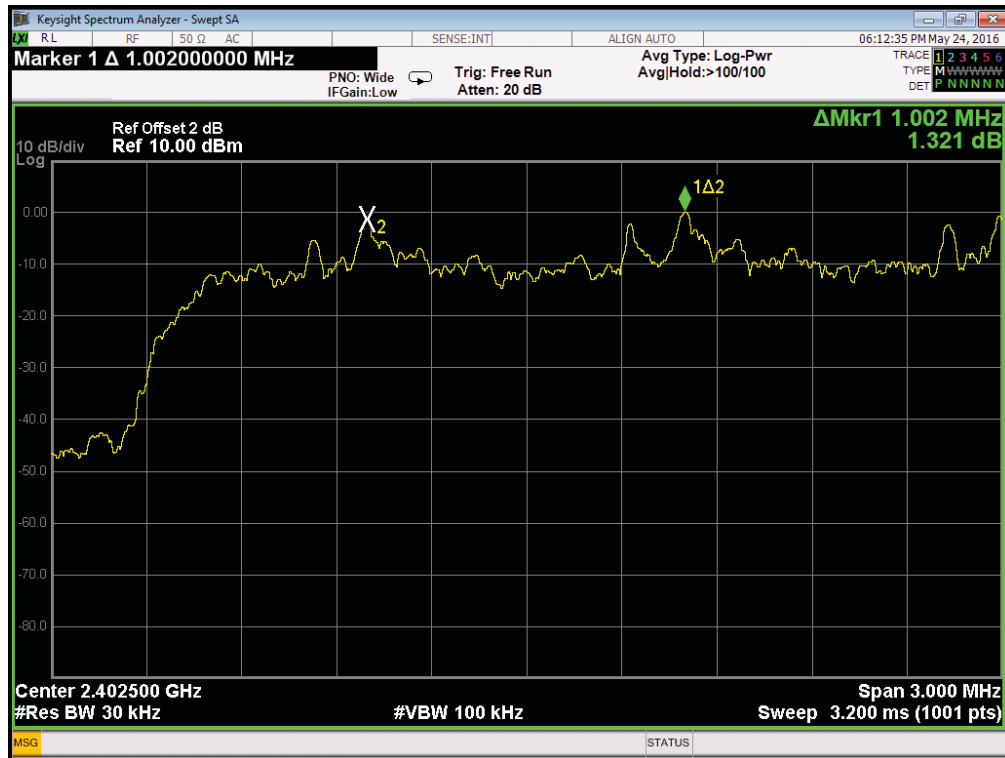



中国认可
国际互认
检测
TESTING
CNAS L3098





5. NUMBER OF HOPPING FREQUENCY TEST

5.1. TEST EQUIPMENT

Item	Equipment	Manufacturer	Model No.	Serial No.	Cal Due.	Cal. Interval
1	Spectrum analyzer	KEYSIGHT	N9010A	MY55150427	2017/05/05	1 Year
2	Attenuator	Mini-Circuits	BW-S10W2	101109	2016/12/19	1 Year
3	RF Cable	Micable	C10-01-01-1	100309	2016/12/19	1 Year

5.2. THE REQUIREMENT FOR SECTION 15.247(a)(1)(iii)

Section 15.247(a)(1)(iii): Frequency hopping systems in the 2400-2483.5 MHz band shall use at least 15 channels.

5.3. EUT CONFIGURATION ON MEASUREMENT

The equipment are installed on the emission measurement to meet the commission requirements and operating regulations in a manner which tends to maximize its emission characteristics in normal application.

5.4. OPERATING CONDITION OF EUT

- (1) Setup the EUT and simulator as shown as Section 7.1.
- (2) Turn on the power of all equipment.
- (3) Let the EUT work in TX (Hopping on) modes measure it.

5.5. TEST PROCEDURE

- (1) The transmitter output was connected to the spectrum analyzer through a low loss cable.
- (2) Set the spectrum analyzer as Span=83.5MHz, RBW=100 kHz, VBW=300 kHz.
- (3) Max hold, view and count how many channel in the band.



中国认可
国际互认
检测
TESTING
CNAS L3098



5.6. TEST RESULT

Total number of hopping channel	Measurement result(CH)	Limit(CH)
	79	≥15

The spectrum analyzer plots are attached as below

Number of hopping channels

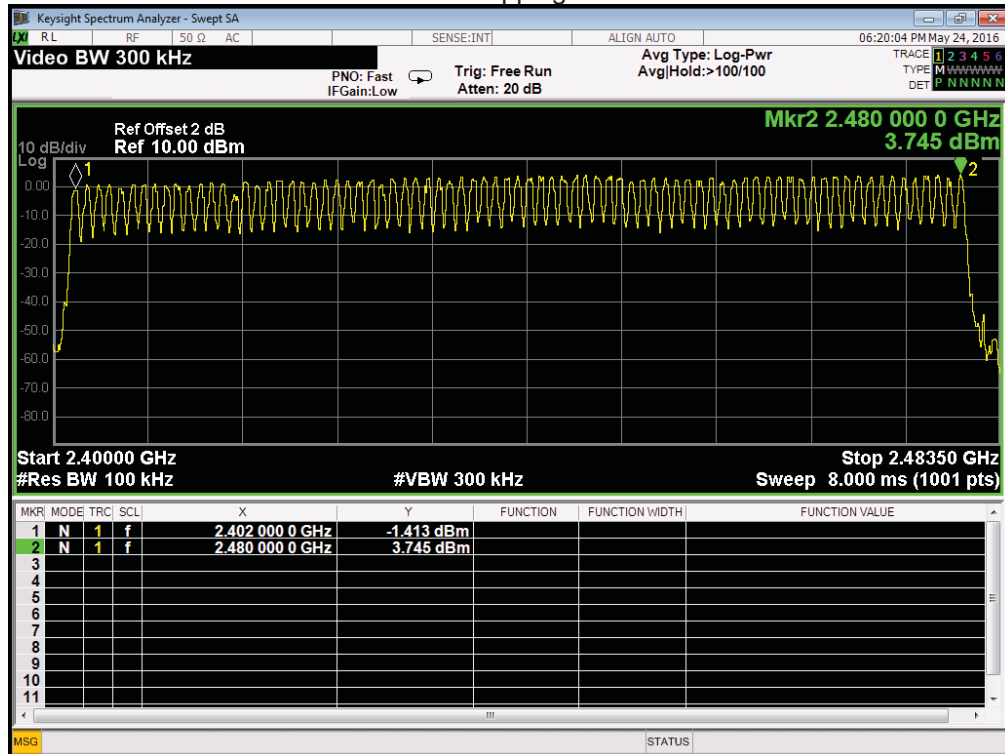

Channle information

CH	Frequency	CH	Frequency	CH	Frequency	CH	Frequency	CH	Frequency
0	2402	16	2418	32	2434	48	2450	64	2466
1	2403	17	2419	33	2435	49	2451	65	2467
2	2404	18	2420	34	2436	50	2452	66	2468
3	2405	19	2421	35	2437	51	2453	67	2469
4	2406	20	2422	36	2438	52	2454	68	2470
5	2407	21	2423	37	2439	53	2455	69	2471
6	2408	22	2424	38	2440	54	2456	70	2472
7	2409	23	2425	39	2441	55	2457	71	2473
8	2410	24	2426	40	2442	56	2458	72	2474
9	2411	25	2427	41	2443	57	2459	73	2475
10	2412	26	2428	42	2444	58	2460	74	2476
11	2413	27	2429	43	2445	59	2461	75	2477
12	2414	28	2430	44	2446	60	2462	76	2478
13	2415	29	2431	45	2447	61	2463	77	2479
14	2416	30	2432	46	2448	62	2464	78	2480
15	2417	31	2433	47	2449	63	2465	-	-



6. DWELL TIME TEST

6.1. TEST EQUIPMENT

Item	Equipment	Manufacturer	Model No.	Serial No.	Cal Due.	Cal. Interval
1	Spectrum analyzer	KEYSIGHT	N9010A	MY55150427	2017/05/05	1 Year
2	Attenuator	Mini-Circuits	BW-S10W2	101109	2016/12/19	1 Year
3	RF Cable	Micable	C10-01-01-1	100309	2016/12/19	1 Year

6.2. THE REQUIREMENT FOR SECTION 15.247(a)(1)(iii)

Section 15.247(a)(1)(iii): Frequency hopping systems in the 2400-2483.5 MHz band shall use at least 15 channels. The average time of occupancy on any channel shall not be greater than 0.4 seconds within a period of 0.4 seconds multiplied by the number of hopping channels employed. Frequency hopping systems may avoid or suppress transmissions on a particular hopping frequency provided that a minimum of 15 channels are used.

6.3. EUT CONFIGURATION ON MEASUREMENT

The equipment are installed on the emission measurement to meet the commission requirements and operating regulations in a manner which tends to maximize its emission characteristics in normal application.

6.4. OPERATING CONDITION OF EUT

- (1) Setup the EUT and simulator as shown as Section 8.1.
- (2) Turn on the power of all equipment.
- (3) Let the EUT work in TX (Hopping on) modes measure it. The transmit frequency are 2402-2480MHz.
We select 2402MHz, 2441MHz, and 2480MHz TX frequency to transmit.

6.5. TEST PROCEDURE

- (1) The transmitter output was connected to the spectrum analyzer through a low loss cable.
- (2) Set center frequency of spectrum analyzer = operating frequency.
- (3) Set the spectrum analyzer as RBW=1MHz, VBW=3MHz, Span=0Hz
 A Period Time = (channel number)*0.4
 DH1 Time Slot: Reading * (1600/2)*31.6/(channel number)
 DH3 Time Slot: Reading * (1600/4)*31.6/(channel number)
 DH5 Time Slot: Reading * (1600/6)*31.6/(channel number)



中国认可
国际互认
检测
TESTING
CNAS L3098



6.6. TEST RESULT

GFSK Mode

Mode	Channel Frequency (MHz)	Pulse Time (ms)	Dwell Time (ms)	Limit (ms)
DH1	2441	0.43	137.6	400
DH3	2441	1.71	273.6	400
DH5	2441	3.08	328.53	400

$\Pi/4$ -DQPSK Mode

Mode	Channel Frequency (MHz)	Pulse Time (ms)	Dwell Time (ms)	Limit (ms)
DH1	2441	0.444	140.8	400
DH3	2441	1.74	278.4	400
DH5	2441	3.04	324.27	400

8DPSK Mode

Mode	Channel Frequency (MHz)	Pulse Time (ms)	Dwell Time (ms)	Limit (ms)
DH1	2441	0.456	145.92	400
DH3	2441	1.74	278.4	400
DH5	2441	3.08	328.53	400

The spectrum analyzer plots are attached as below:



中国认可
国际互认
检测
TESTING
CNAS L3098



GFSK Mode

DH1

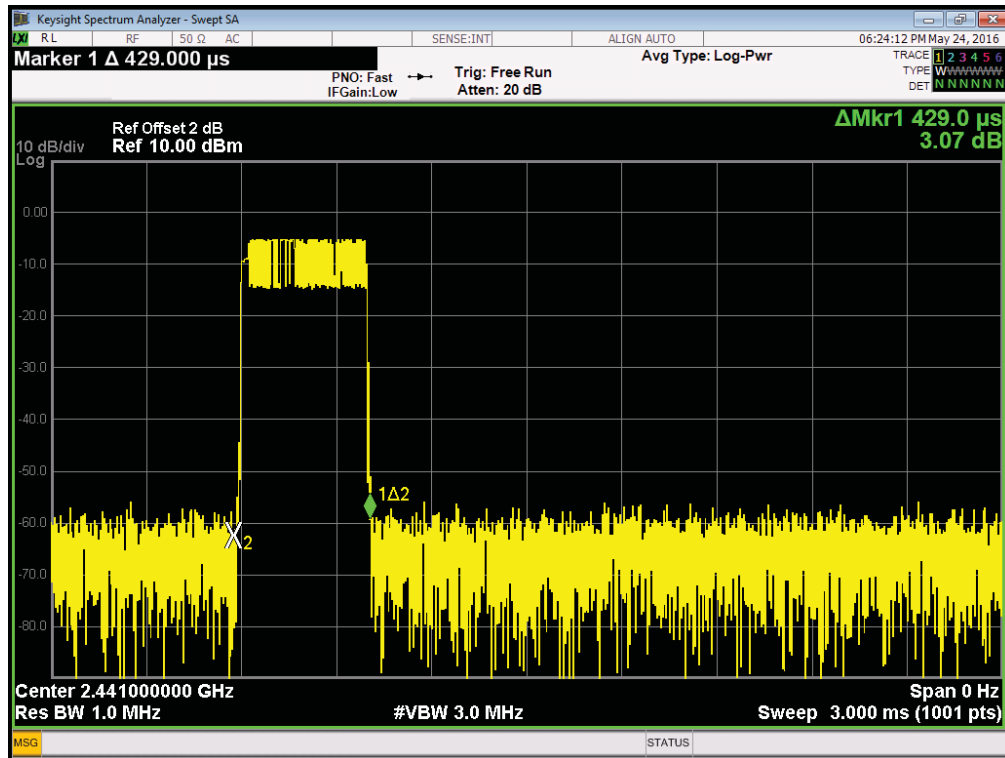

DH3

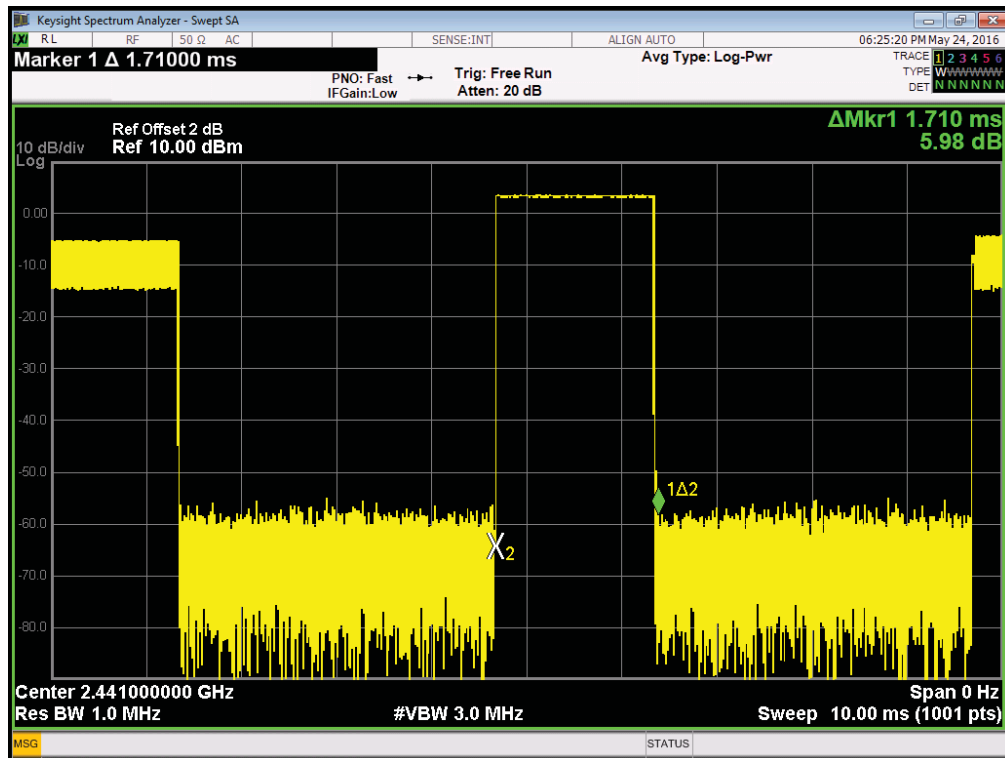



中国认可
国际互认
检测
TESTING
CNAS L3098



DH5

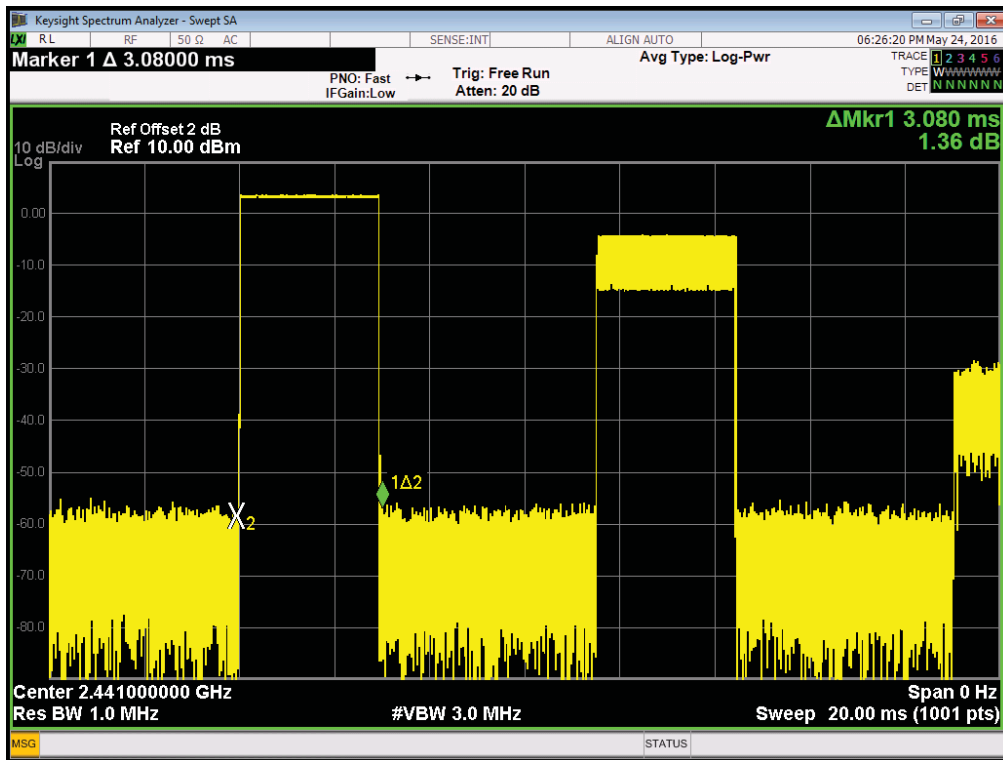

$\pi/4$ -DQPSK Mode

DH1

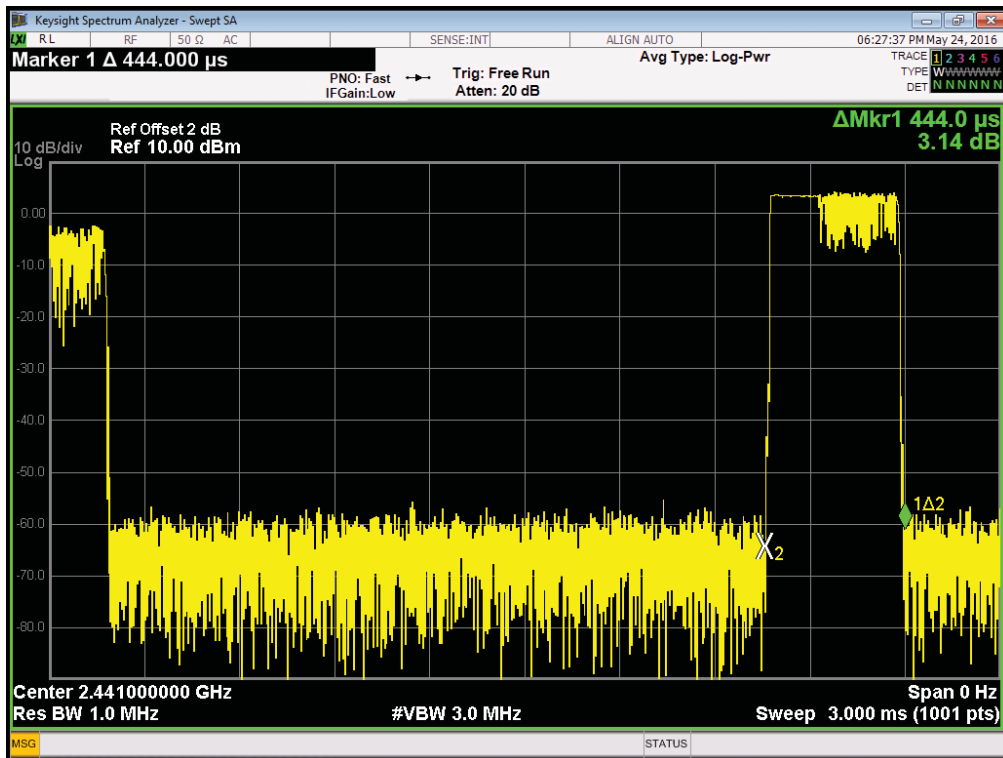



中国认可
国际互认
检测
TESTING
CNAS L3098



DH3

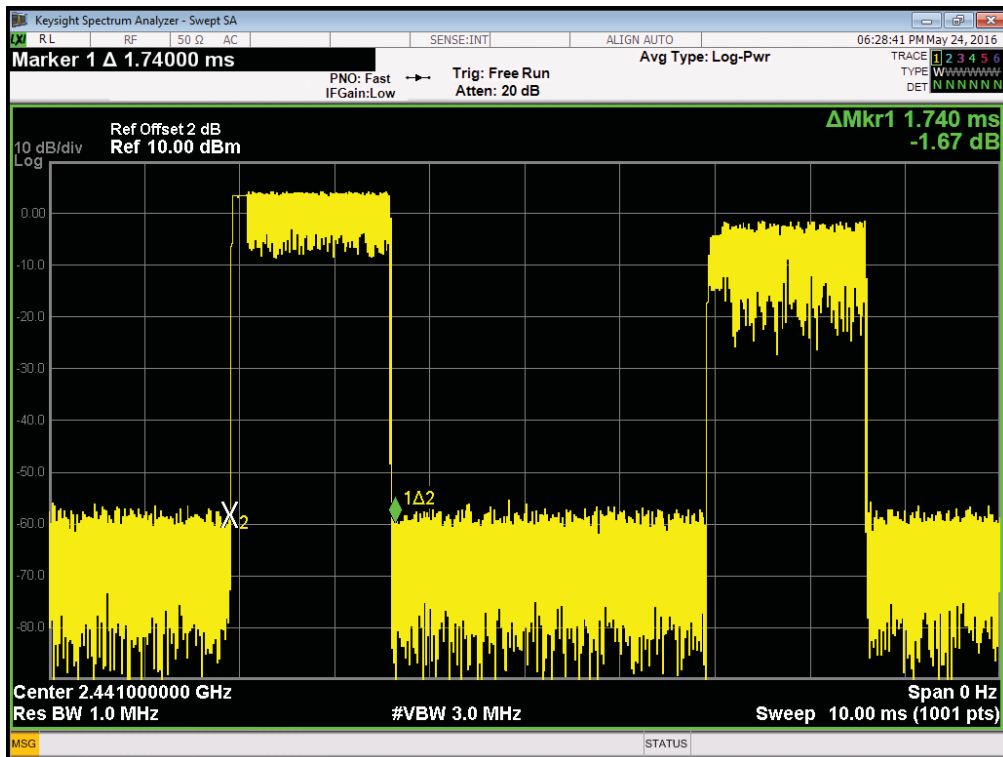

DH5





8DPSK Mode

DH1

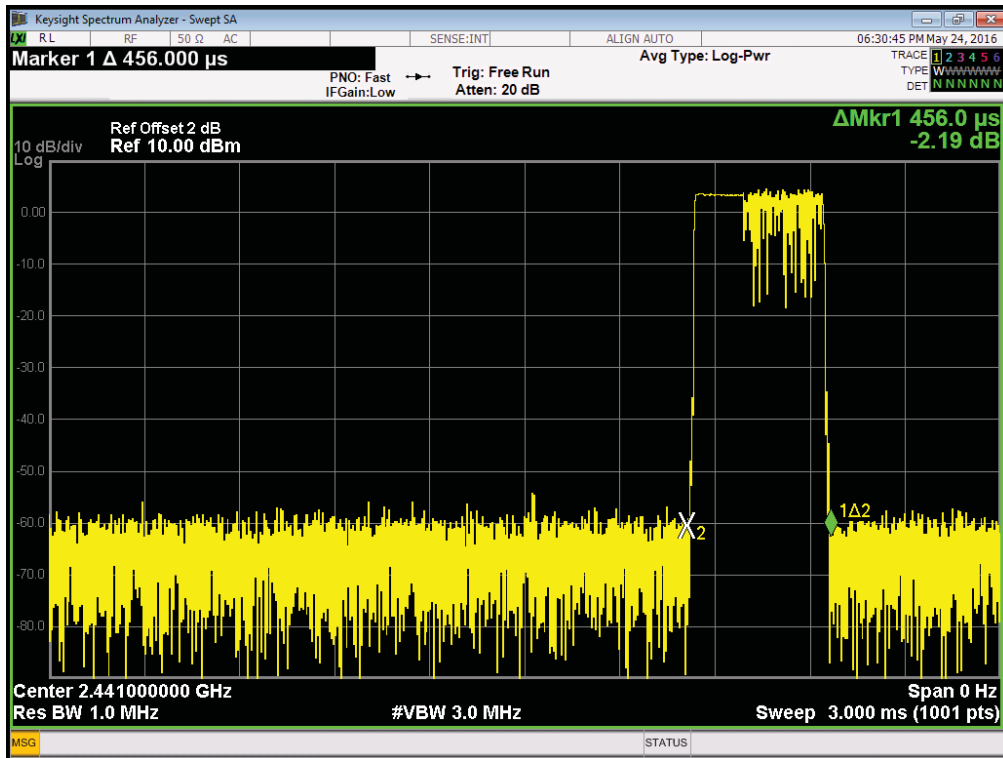

DH3

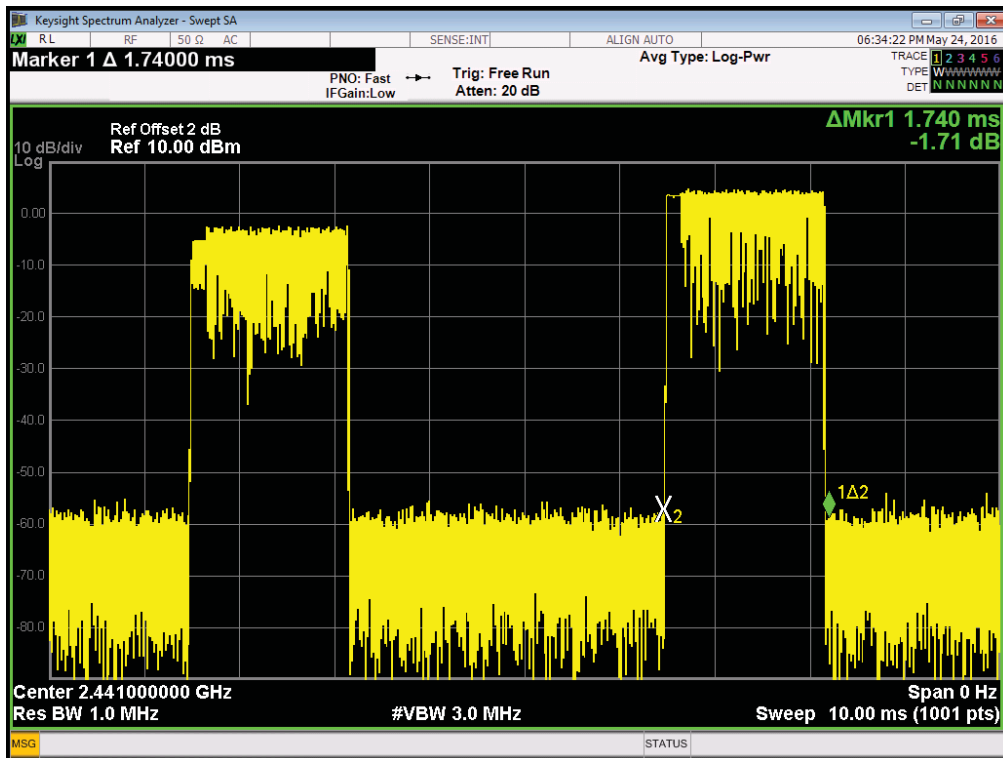



中国认可
国际互认
检测
TESTING
CNAS L3098



DH5

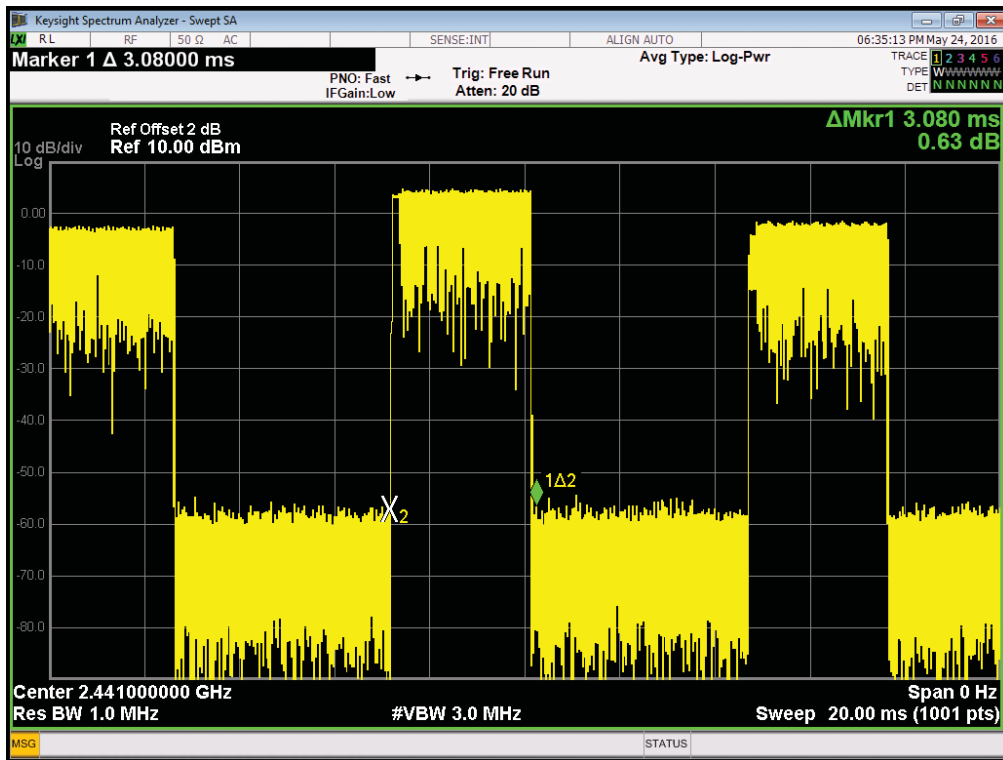



中国认可
国际互认
检测
TESTING
CNAS L3098



7. MAXMUM OUTPUT POWER

7.1. TEST EQUIPMENT

Item	Equipment	Manufacturer	Model No.	Serial No.	Cal Due.	Cal. Interval
1	Spectrum analyzer	KEYSIGHT	N9010A	MY55150427	2017/05/05	1 Year
2	Attenuator	Mini-Circuits	BW-S10W2	101109	2016/12/19	1 Year
3	RF Cable	Micable	C10-01-01-1	100309	2016/12/19	1 Year

7.2. BLOCK DIAGRAM OF TEST SETUP

Same with 3.2

7.3. LIMITS

For systems using digital modulation in the 902-928 MHz, 2400-2483.5 MHz bands: 0.125 Watt. If transmitting antennas of directional gain greater than 6 dBi are used, the conducted output power from the intentional radiator shall be reduced below the stated values as appropriate, by the amount in dB that the directional gain of the antenna exceeds 6 dBi.



中国认可
国际互认
检测
TESTING
CNAS L3098



7.4. TEST PROCEDURE

- (1) Configure EUT and assistant system according clause 2.4 and 3.2
- (2) Connect EUT's antenna output to spectrum analyzer by RF cable.
- (3) Configure EUT work in test mode as stated in clause 2.4.
- (4) Set the spectrum analyzer as follows:

GFSK	RBW:	1MHz
	VBW:	3MHz
$\pi/4$ DQPSK	RBW:	3MHz
	VBW:	3MHz
8DPSK	RBW:	3MHz
	VBW:	3MHz
Span		>1.5x 20dB bandwidth
Detector Mode:		Peak
Sweep time:		auto
Trace mode		Max hold

- (5) Allow the trace to stabilize, Use the instrument's band/channel power measurement function with the band limits set equal to the DTS bandwidth edges measure out the Average and PK output power.

7.5. TEST RESULT

EUT Set Mode	Data Rate (Mbps)	Frequency (MHz)	Result(dBm)
			Peak
GFSK	1	2402	4.464
		2441	4.057
		2480	4.437
$\pi/4$ DQPSK	2	2402	3.415
		2441	4.689
		2480	4.985
8DPSK	3	2402	3.652
		2441	5.075
		2480	4.02
Limit: 21dBm		Conclusion: PASS	

7.6. ORIGINAL TEST DATA

GFSK

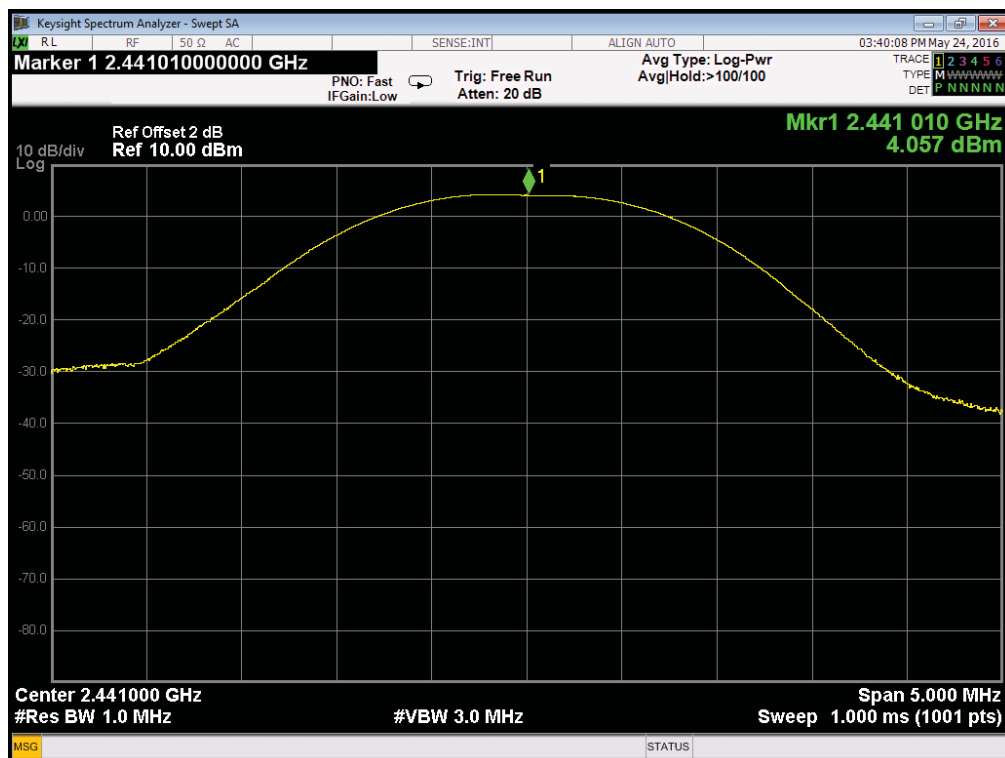
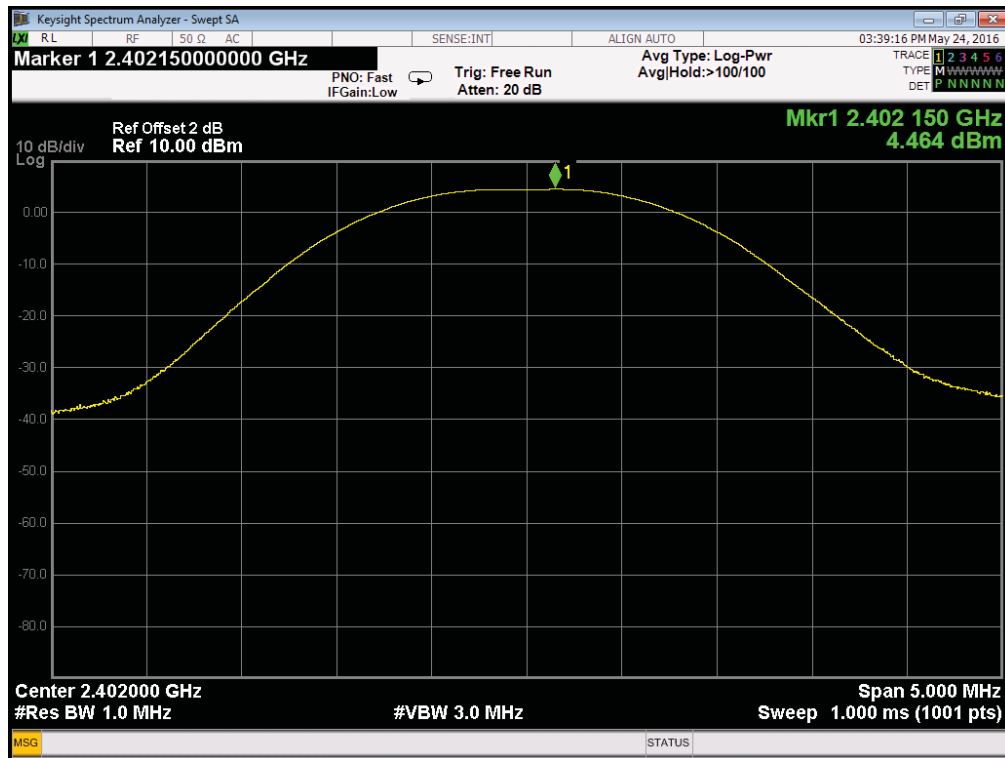



中国认可
国际互认
检测
TESTING
CNAS L3098

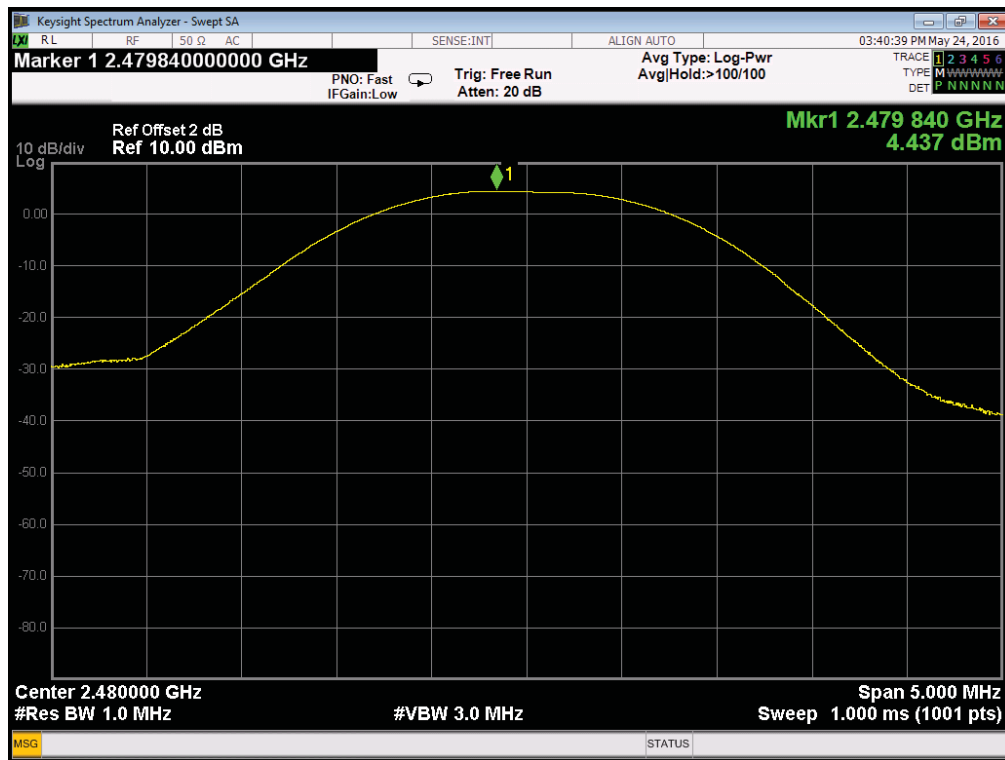

$\pi/4$ DQPSK

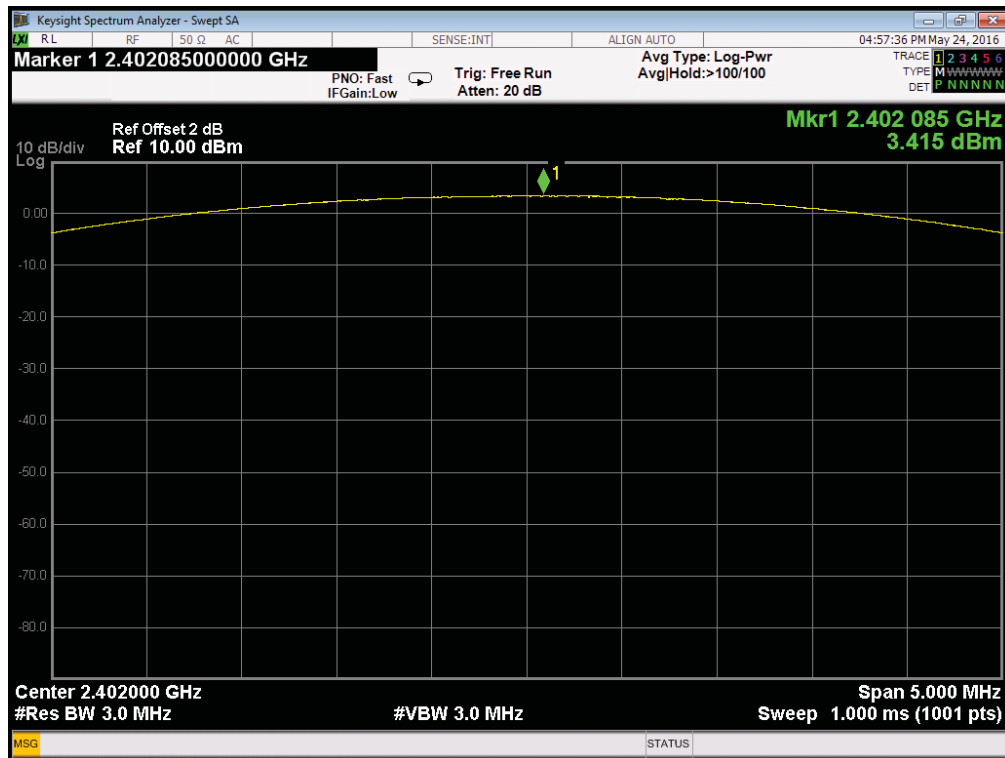



中国认可
国际互认
检测
TESTING
CNAS L3098

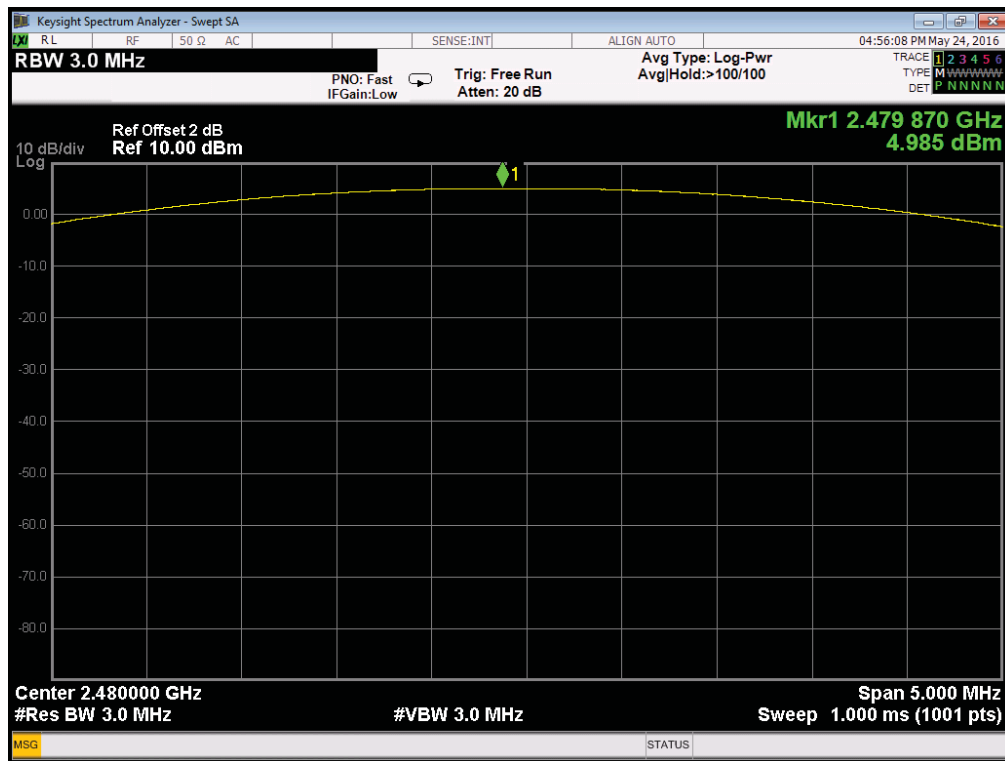
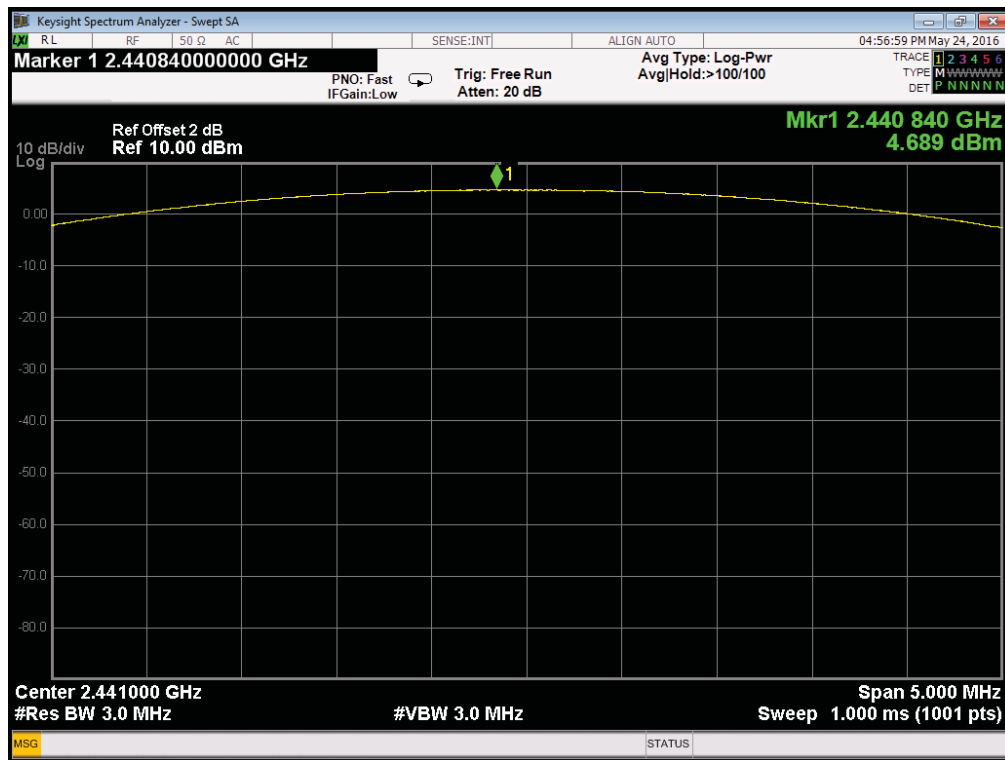



中国认可
国际互认
检测
TESTING
CNAS L3098



8DPSK

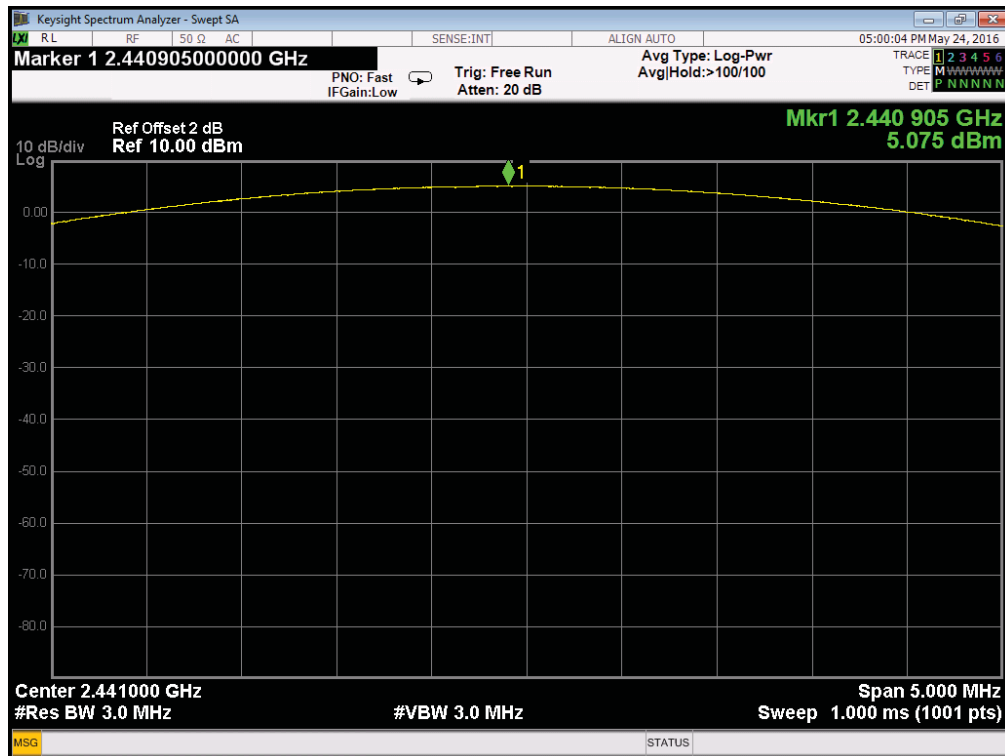
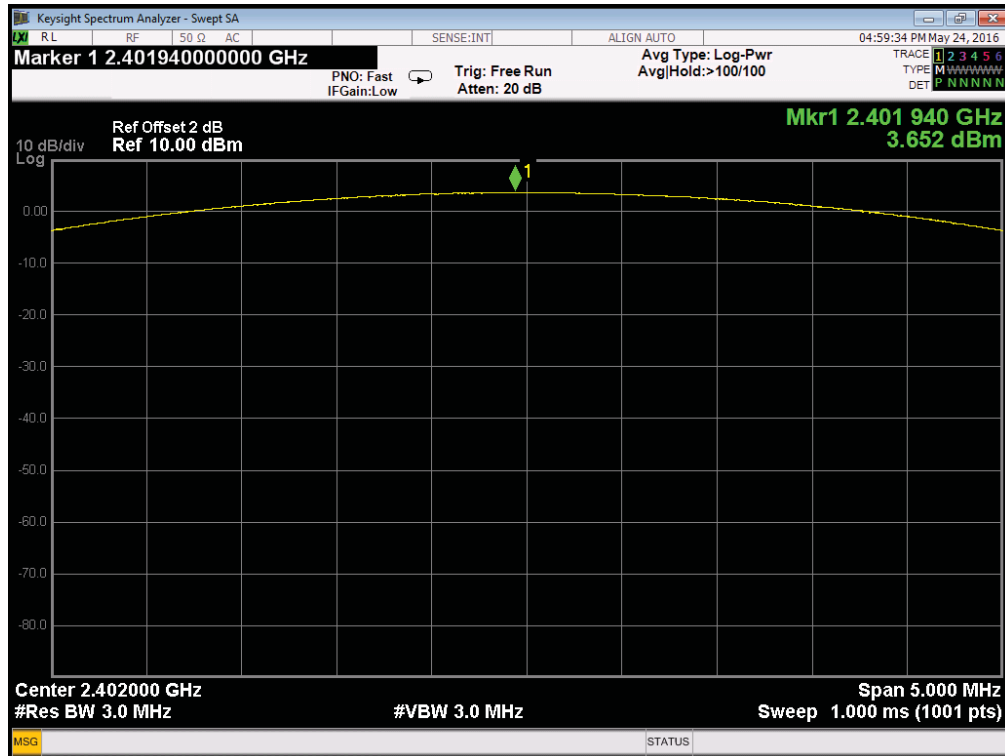



中国认可
国际互认
检测
TESTING
CNAS L3098

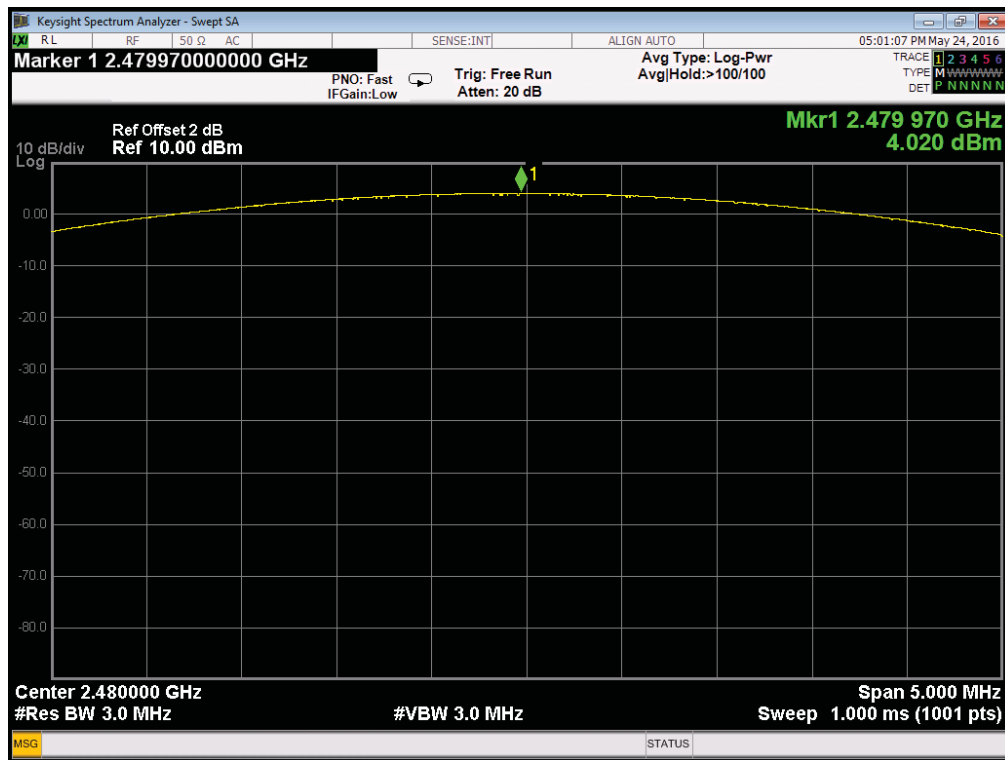

8. SPURIOUS EMISSION

8.1. Test equipment

Item	Equipment	Manufacturer	Model No.	Serial No.	Cal Due.	Cal. Interval
1	EMI Test Receiver	R&S	ESU8	100316	2016/12/19	1 Year
2	Spectrum analyzer	R&S	FSU	1166.1660.26	2016/12/19	1 Year
3	Loop antenna	TESEQ	HLA6120	20129	2016/12/19	1 Year
4	Trilog Broadband Antenna	Schwarzbeck	VULB9163	9163-462	2016/12/19	1 Year
5	Double Ridged Horn Antenna	Schwarzbeck	BBHA9120D	9120D 1065	2016/12/19	1 Year
6	Horn Antenna	Schwarzbeck	BBHA 9170	9170 1248	2016/12/19	1 Year
7	Pre-amplifier	A.H.	PAM-1840VH	562	2016/12/19	1 Year
8	Pre-amplifier	R&S	AFS33-18002 650-30-8P-44	SEL0080	2016/12/19	1 Year
9	Pre-Amplifier	HP	8449B	3274A06298	2016/12/19	1 Year
10	RF Cable	R&S	R01	10403	2016/12/19	1 Year
11	RF Cable	R&S	R02	10512	2016/12/19	1 Year

8.2. Block diagram of test setup

In 3m Anechoic Chamber Test Setup Diagram for 9KHz-30MHz

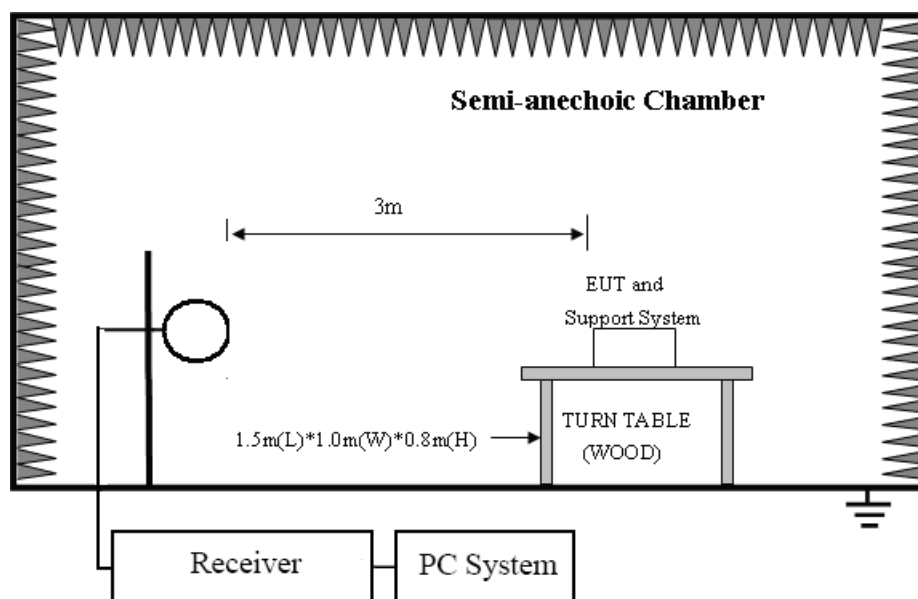

In 3m Anechoic Chamber Test Setup Diagram for 30MHz-1GHz

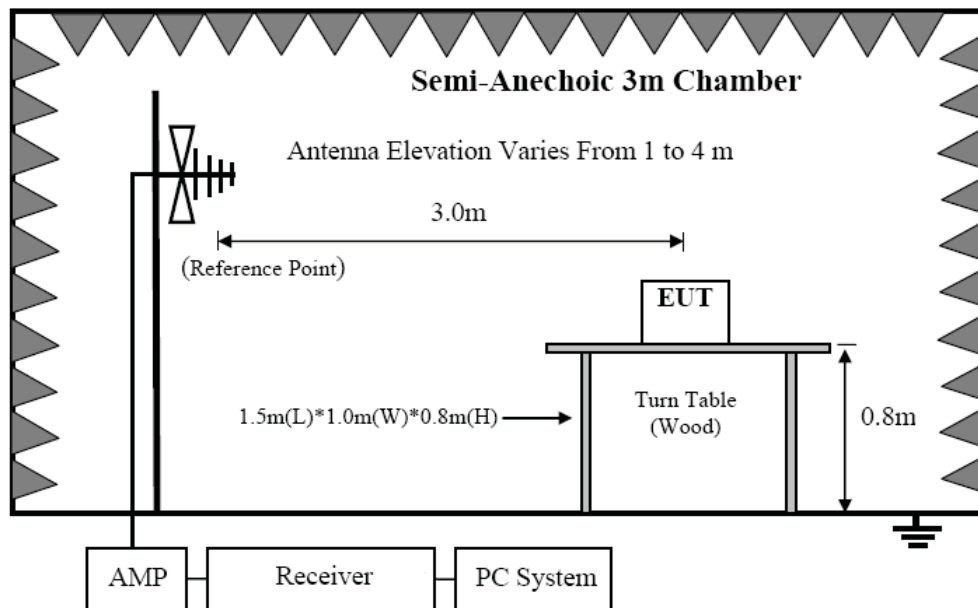

In 3m Anechoic Chamber Test Setup Diagram for frequency above 1GHz

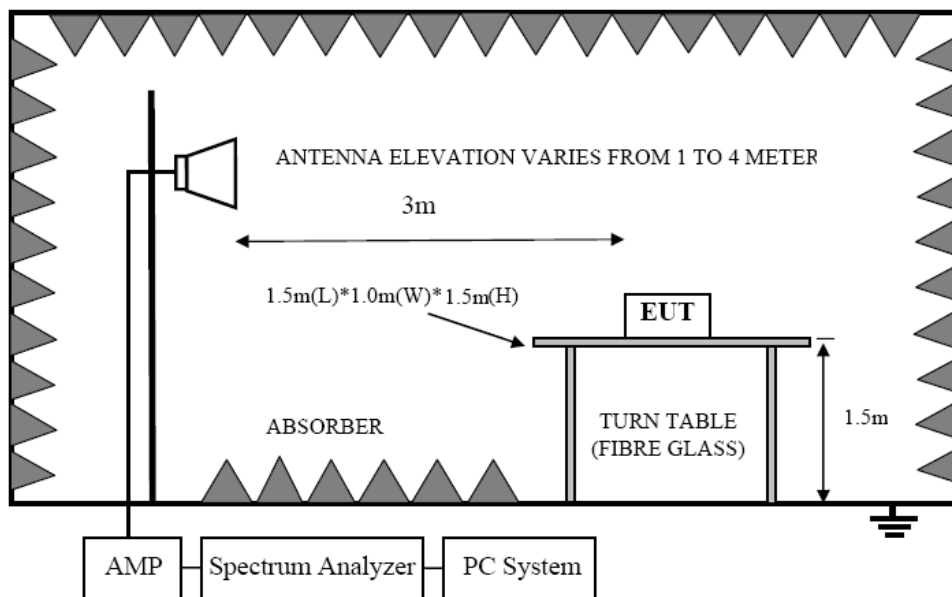

Note: For harmonic emissions test a appropriate high pass filter was inserted in the input port of AMP.



中国认可
国际互认
检测
TESTING
CNAS L3098



8.3. Limit

8.3.1 Restricted frequency band

MHz	MHz	MHz	GHz
0.090 - 0.110	16.42 - 16.423	399.9 - 410	4.5 - 5.15
¹ 0.495 - 0.505	16.69475 - 16.69525	608 - 614	5.35 - 5.46
2.1735 - 2.1905	16.80425 - 16.80475	960 - 1240	7.25 - 7.75
4.125 - 4.128	25.5 - 25.67	1300 - 1427	8.025 - 8.5
4.17725 - 4.17775	37.5 - 38.25	1435 - 1626.5	9.0 - 9.2
4.20725 - 4.20775	73 - 74.6	1645.5 - 1646.5	9.3 - 9.5
6.215 - 6.218	74.8 - 75.2	1660 - 1710	10.6 - 12.7
6.26775 - 6.26825	108 - 121.94	1718.8 - 1722.2	13.25 - 13.4
6.31175 - 6.31225	123 - 138	2200 - 2300	14.47 - 14.5
8.291 - 8.294	149.9 - 150.05	2310 - 2390	15.35 - 16.2
8.362 - 8.366	156.52475 - 156.52525	2483.5 - 2500	17.7 - 21.4
8.37625 - 8.38675	156.7 - 156.9	2690 - 2900	22.01 - 23.12
8.41425 - 8.41475	162.0125 - 167.17	3260 - 3267	23.6 - 24.0
12.29 - 12.293	167.72 - 173.2	3332 - 3339	31.2 - 31.8
12.51975 - 12.52025	240 - 285	3345.8 - 3358	36.43 - 36.5
12.57675 - 12.57725	322 - 335.4	3600 - 4400	(²)

8.3.2. Limit.

FREQUENCY MHz	DISTANCE Meters	FIELD STRENGTHS LIMIT	
		μV/m	dB(μV)/m
0.009 ~ 0.490	300	2400/F(KHz)	67.6-20log(F)
0.490 ~ 1.705	30	24000/F(KHz)	87.6-20log(F)
1.705 ~ 30.0	30	30	29.54
30 ~ 88	3	100	40.0
88 ~ 216	3	150	43.5
216 ~ 960	3	200	46.0
960 ~ 1000	3	500	54.0
Above 1000	3	74.0 dB(μV)/m (Peak) 54.0 dB(μV)/m (Average)	

Note: (1) The emission limits shown in the above table are based on measurements employing a CISPR QP detector except for the frequency bands 9-90KHz, 110-490KHz and above 1000MHz. Radiated emissions limits in these three bands are based on measurements employing an average detector.

(2) At frequencies below 30MHz, measurement may be performed at a distance closer then that specified, and the limit at closer measurement distance can be extrapolated by below formula:

$$\text{Limit}_{3m}(\text{dBuV}/\text{m}) = \text{Limit}_{30m}(\text{dBuV}/\text{m}) + 40\text{Log}(30\text{m}/3\text{m})$$

8.3.3. Limit for this EUT

All the emissions appearing within 15.205 restricted frequency bands shall not exceed the limits shown in 15.209, all the other emissions shall be at least 30dB below the fundamental emissions, or comply with 15.209 limits.

8.4. Test Procedure

- (1) EUT was placed on a non-metallic table, 80 cm above the ground plane inside a semi-anechoic chamber.
- (2) Setup EUT and assistant system according clause 2.4 and 7.2
- (3) Test antenna was located 3m from the EUT on an adjustable mast, and the antenna used as below table.

Test frequency range	Test antenna used
9KHz-30MHz	Active Loop antenna
30MHz-1GHz	Trilog Broadband Antenna
1GHz-26.5GHz	Double Ridged Horn Antenna(1GHz-26.5GHz)

According ANSI C63.10:2013 clause 6.4.4.2 and 6.5.3, for measurements below 30 MHz, the loop antenna was positioned with its plane vertical from the EUT and rotated about its vertical axis for maximum response at each azimuth position around the EUT. And the loop antenna also be positioned with its plane horizontal at the specified distance from the EUT. The center of the loop is 1 m above the ground. for measurement above 30MHz, the Trilog Broadband Antenna or Horn Antenna was located 3m from EUT, Measurements were made with the antenna positioned in both the horizontal and vertical planes of Polarization, and the measurement antenna was varied from 1 m to 4 m. in height above the reference ground plane to obtain the maximum signal strength.

- (4) Below pre-scan procedure was first performed in order to find prominent frequency spectrum radiated emissions from 9KHz to 25GHz:
 - (a) Scanning the peak frequency spectrum with the antenna specified in step (3), and the EUT was rotated 360 degree, the antenna height was varied from 1m to 4m(Except loop antenna, it's fixed 1m above ground.)
 - (b) Change work frequency or channel of device if practicable.
 - (c) Change modulation type of device if practicable.
 - (d) new battery is used during testing
 - (e) Rotated EUT though three orthogonal axes to determine the attitude of EUT arrangement produces highest emissions.



中国认可
国际互认
检测
TESTING
CNAS L3098



- (5) For final emissions measurements at each frequency of interest, the EUT was rotated and the antenna height was varied between 1m and 4m in order to maximize the emission. Measurements in both horizontal and vertical polarities were made and the data was recorded. In order to find the maximum emission, the relative positions of equipments and all of the interface cables were changed according to ANSI C63.10 2013 on Radiated Emission test.
- (6) The emissions from 9KHz to 1GHz were measured based on CISPR QP detector except for the frequency bands 9-90KHz, 110-490KHz, for emissions from 9KHz-90KHz, 110KHz-490KHz and above 1GHz were measured based on average detector, for emissions above 1GHz, peak emissions also be measured and need comply with Peak limit.
- (7) The emissions from 9KHz to 1GHz, QP or average values were measured with EMI receiver with below RBW

Frequency band	RBW
9KHz-150KHz	200Hz
150KHz-30MHz	9KHz
30MHz-1GHz	120KHz

- (8) For emissions above 1GHz, both Peak and Average level were measured with Spectrum Analyzer, and the RBW is set at 1MHz, VBW is set at 3MHz for Peak measure; RBW is set at 1MHz, VBW is set at 10Hz for Average measure (according ANSI C63.10:2013 clause 4.2.3.2.3 procedure for average measure). Peak detector is used for Peak and AV measurement both.



中国认可
国际互认
检测
TESTING
CNAS L3098



8.5. Test Result

Below 30M

EUT:	Wireless Fender Jaguar Guitar Controller for PlayStation 4	Model No.:	051-064
Temperature:	24°C	Relative Humidity:	55%
Distance:	3m	Test Power:	3 Vdc
Polarization:	--	Test Result:	Pass
Test Mode:	Keeping TX mode	Test By:	Smile

Freq. (MHz)	Reading (dBuV/m)	Limit (dBuV/m)	Margin (dB)	State P/F
--	--	--	--	P
--	--	--	--	P

Note:

The amplitude of spurious emissions which are attenuated by more than 20dB below the permissible value has no need to be reported.

Distance extrapolation factor = 20 log (specific distance/test distance)(dB);

Limit line = specific limits(dBuv) + distance extrapolation factor



中国认可
国际互认
检测
TESTING
CNAS L3098



Between 30M – 1000 MHz

EUT:	Wireless Fender Jaguar Guitar Controller for PlayStation 4	Model No.:	051-064
Temperature:	24	Relative Humidity:	55%
Distance:	3m	Test Power:	DC 3V
Polarization:	Vertical	Test Result:	Pass
Standard:	(RE)FCC PART 15	Test By:	Smile
Test Mode:	Keeping TX mode		

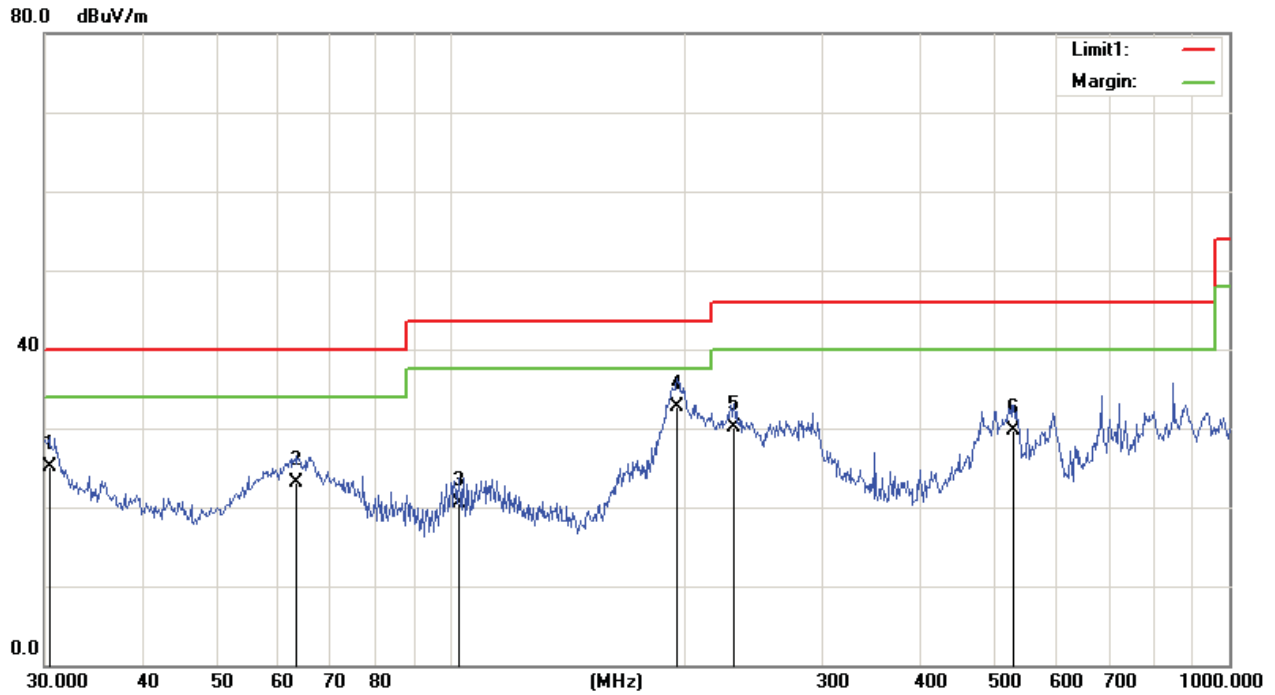

No.	Frequency (MHz)	Reading (dBuV/m)	Correct Factor (dB/m)	Result (dBuV/m)	Limit (dBuV/m)	Margin (dB)	Remark
1	30.4237	33.95	-8.92	25.03	40.00	-14.97	QP
2	63.3132	34.30	-11.12	23.18	40.00	-16.82	QP
3	102.3597	33.36	-12.82	20.54	43.50	-22.96	QP
4	195.1365	42.17	-9.38	32.79	43.50	-10.71	QP
5	230.9068	37.59	-7.54	30.05	46.00	-15.95	QP
6	528.2458	29.67	0.04	29.71	46.00	-16.29	QP



中国认可
国际互认
检测
TESTING
CNAS L3098



EUT:	Wireless Fender Jaguar Guitar Controller for PlayStation 4	Model No.:	051-064
Temperature:	24	Relative Humidity:	55%
Distance:	3m	Test Power:	DC 3V
Polarization:	Horizontal	Test Result:	Pass
Standard:	(RE)FCC PART 15	Test By:	Smile
Test Mode:	Keeping TX mode		

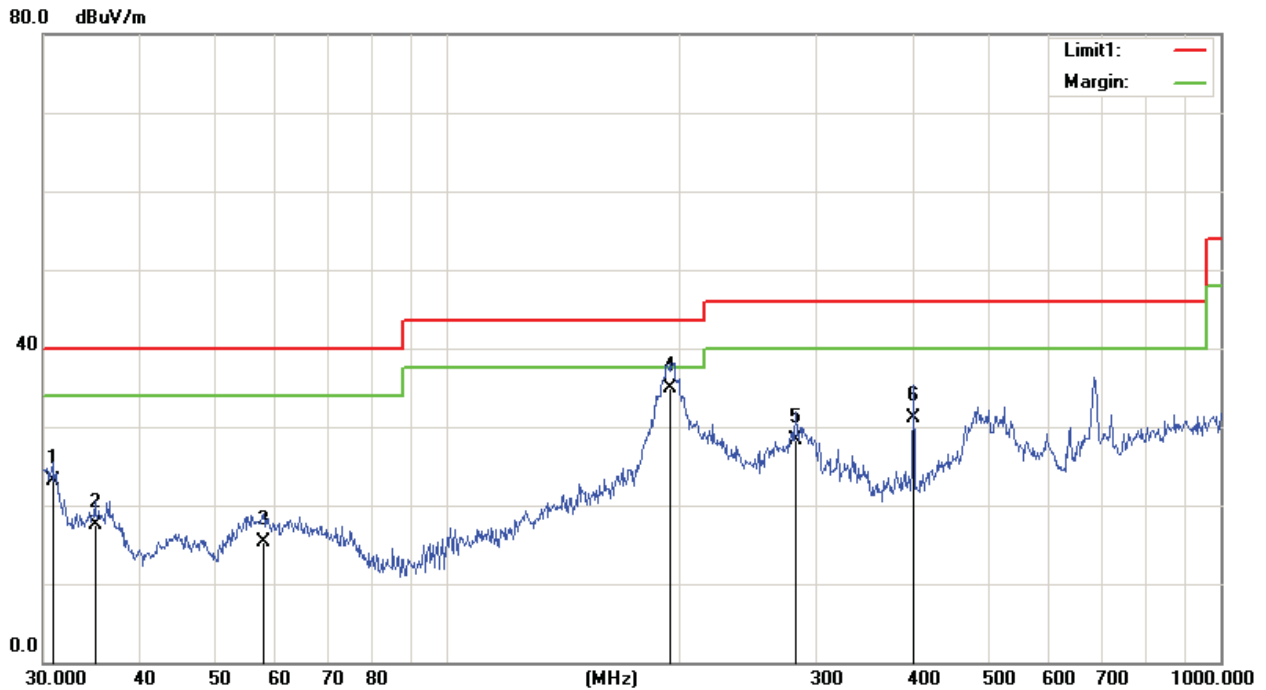

No.	Frequency (MHz)	Reading (dBuV/m)	Correct Factor(dB/m)	Result (dBuV/m)	Limit (dBuV/m)	Margin (dB)	Remark
1	30.8535	31.91	-8.86	23.05	40.00	-16.95	QP
2	35.0048	27.43	-9.91	17.52	40.00	-22.48	QP
3	57.7961	29.14	-13.81	15.33	40.00	-24.67	QP
4	194.4533	48.33	-13.37	34.96	43.50	-8.54	QP
5	281.9945	37.13	-8.82	28.31	46.00	-17.69	QP
6	400.4318	36.69	-5.61	31.08	46.00	-14.92	QP

Remark: "1Mbps" mode (Mid CH) is the worst mode.



中国认可
国际互认
检测
TESTING
CNAS L3098



Between 1000M – 25000 MHz

Test Site	: 3m Chamber		
EUT	: Wireless Fender Jaguar Guitar Controller for PlayStation 4	Tested By	: Smile
Power Supply	: Battery 1.5Vdc*2	Model Number	: 051-064
Condition	: Temp:24.5'C,Humi:55%, Press:100.1kPa	Test Mode	: Tx mode
Memo	: GFSK (worst case)	Antenna/Distance	: VULB 9163 /3m

Frequency (MHz)	Receiver		Rx Antenna		Cable loss (dB)	Amplifier Gain (dB)	Corrected Amplitude (dBμV/m)	FCC 15.247	
	Reading (dBμV)	PK/QP/AV	Polar (H/V)	Factor (dB)				Limit (dBμV/m)	Margin (dB)
Low Channel (2402)									
4804	56.28	PK	H	32.3	5.91	31.78	62.71	74	-11.29
4804	37.42	AV	H	32.3	5.91	31.78	43.85	54	-10.15
4804	39.06	PK	V	32.3	5.91	31.78	45.49	74	-28.51
4804	27.94	AV	V	32.3	5.91	31.78	34.37	54	-19.63
7206	51.13	PK	H	36.3	6.34	30.97	62.8	74	-11.2
7206	31.04	AV	H	36.3	6.34	30.97	42.71	54	-11.29
7206	52.33	PK	V	36.3	6.34	30.97	64	74	-10
7206	34.57	AV	V	36.3	6.34	30.97	46.24	54	-7.76
9608	50.63	PK	H	37.9	8.01	30.86	65.68	74	-8.32
9608	31.82	AV	H	37.9	8.01	30.86	46.87	54	-7.13
9608	51.73	PK	V	37.9	8.01	30.86	66.78	74	-7.22
9608	33.45	AV	V	37.9	8.01	30.86	48.5	54	-5.5
Middle Channel (2441)									
4882	53.14	PK	H	32.9	6.34	31.78	60.6	74	-13.4
4882	36.28	AV	H	32.9	6.34	31.78	43.74	54	-10.26
4882	55.02	PK	V	32.9	6.34	31.78	62.48	74	-11.52
4882	38.31	AV	V	32.9	6.34	31.78	45.77	54	-8.23
7323	50.76	PK	H	37.1	6.72	30.97	63.61	74	-10.39
7323	33.53	AV	H	37.1	6.72	30.97	46.38	54	-7.62
7323	52.62	PK	V	37.1	6.72	30.97	65.47	74	-8.53
7323	35.91	AV	V	37.1	6.72	30.97	48.76	54	-5.24
9764	47.25	PK	H	38.6	8.43	30.86	63.42	74	-10.58
9764	30.06	AV	H	38.6	8.43	30.86	46.23	54	-7.77
9764	48.79	PK	V	38.6	8.43	30.86	64.96	74	-9.04



中国认可
国际互认
检测
TESTING
CNAS L3098



9764	31.72	AV	V	38.6	8.43	30.86	47.89	54	-6.11
High Channel (2480)									
4960	53.94	PK	H	33.1	6.39	31.78	61.65	74	-12.35
4960	35.41	AV	H	33.1	6.39	31.78	43.12	54	-10.88
4960	55.76	PK	V	33.1	6.39	31.78	63.47	74	-10.53
4960	36.58	AV	V	33.1	6.39	31.78	44.29	54	-9.71
7440	50.19	PK	H	37.2	6.77	30.97	63.19	74	-10.81
7440	31.62	AV	H	37.2	6.77	30.97	44.62	54	-9.38
7440	51.13	PK	V	37.2	6.77	30.97	64.13	74	-9.87
7440	32.36	AV	V	37.2	6.77	30.97	45.36	54	-8.64
9920	48.67	PK	H	38.7	8.48	30.86	64.99	74	-9.01
9920	30.22	AV	H	38.7	8.48	30.86	46.54	54	-7.46
9920	49.45	PK	V	38.7	8.48	30.86	65.77	74	-8.23
9920	31.44	AV	V	38.7	8.48	30.86	47.76	54	-6.24

Note: 1. Result Level = Read Level + Antenna Factor + Cable loss



中国认可
国际互认
检测
TESTING
CNAS L3098



Radiated band edge:

Frequency	Receiver		Rx Antenna		Cable loss	Amplifier Gain	Corrected Amplitude	FCC 15.247	
(MHz)	Reading (dB μ V)	PK/QP/AV	Polar (H/V)	Factor (dB)	(dB)	(dB)	(dB μ V/m)	Limit (dB μ V/m)	Margin (dB)
Lowest Channel (GFSK)									
2390	31.27	PK	H	27.8	3.57	0	62.64	74	-11.36
2390	12.01	AV	H	27.8	3.57	0	43.38	54	-10.62
2390	32.13	PK	V	27.8	3.57	0	63.5	74	-10.5
2390	13.25	AV	V	27.8	3.57	0	44.62	54	-9.38
2400	32.69	PK	H	28	3.57	0	64.26	74	-9.74
2400	15.11	AV	H	28	3.57	0	46.68	54	-7.32
2400	35.23	PK	V	28	3.57	0	66.8	74	-7.2
2400	16.05	AV	V	28	3.57	0	47.62	54	-6.38
Highest Channel (GFSK)									
2483.5	29.76	PK	H	28.7	3.72	0	62.18	74	-11.82
2483.5	14.39	AV	H	28.7	3.72	0	46.81	54	-7.19
2483.5	31.05	PK	V	28.7	3.72	0	63.47	74	-10.53
2483.5	16.11	AV	V	28.7	3.72	0	48.53	54	-5.47
Lowest Channel ($\pi/4$ DQPSK)									
2390	30.15	PK	H	27.9	3.57	0	61.62	74	-12.38
2390	13.63	AV	H	27.9	3.57	0	45.1	54	-8.9
2390	31.12	PK	V	27.9	3.57	0	62.59	74	-11.41
2390	15.91	AV	V	27.9	3.57	0	47.38	54	-6.62
2400	31.29	PK	H	28	3.57	0	62.86	74	-11.14
2400	14.34	AV	H	28	3.57	0	45.91	54	-8.09
2400	32.04	PK	V	28	3.57	0	63.61	74	-10.39
2400	16.65	AV	V	28	3.57	0	48.22	54	-5.78



中国认可
国际互认
检测
TESTING
CNAS L3098



Highest Channel ($\pi/4$ DQPSK)									
2483.5	27.96	PK	H	28.7	3.72	0	60.38	74	-13.62
2483.5	12.57	AV	H	28.7	3.72	0	44.99	54	-9.01
2483.5	31.66	PK	V	28.7	3.72	0	64.08	74	-9.92
2483.5	15.43	AV	V	28.7	3.72	0	47.85	54	-6.15

Lowest Channel (8DBSK)									
2390	30.09	PK	H	27.9	3.57	0	61.56	74	-12.44
2390	12.35	AV	H	27.9	3.57	0	43.82	54	-10.18
2390	31.14	PK	V	27.9	3.57	0	62.61	74	-11.39
2390	15.67	AV	V	27.9	3.57	0	47.14	54	-6.86
2400	29.95	PK	H	28	3.57	0	61.52	74	-12.48
2400	12.37	AV	H	28	3.57	0	43.94	54	-10.06
2400	32.11	PK	V	28	3.57	0	63.68	74	-10.32
2400	14.51	AV	V	28	3.57	0	46.08	54	-7.92

Highest Channel (8DBSK)									
2483.5	28.74	PK	H	28.7	3.72	0	61.16	74	-12.84
2483.5	10.86	AV	H	28.7	3.72	0	43.28	54	-10.72
2483.5	30.15	PK	V	28.7	3.72	0	62.57	74	-11.43
2483.5	12.34	AV	V	28.7	3.72	0	44.76	54	-9.24

- Note: 1. Result Level = Read Level + Antenna Factor + Cable Loss- Amplifier Gain
 2. After test and evaluation hopping off mode and hopping on mode, will record worst case (hopping off mode) in this report.



9. 100 KHZ BANDWIDTH OF FREQUENCY BAND EDGE

9.1. Test Equipment

Item	Equipment	Manufacturer	Model No.	Serial No.	Cal Due.	Cal. Interval
1	Spectrum analyzer	KEYSIGHT	N9010A	MY55150427	2017/05/05	1 Year
2	Attenuator	Mini-Circuits	BW-S10W2	101109	2016/12/19	1 Year
3	RF Cable	Micable	C10-01-01-1	100309	2016/12/19	1 Year

9.2. Limit

In any 100 kHz bandwidth outside the frequency band in which the spread spectrum or digitally modulated intentional radiator is operating, the radio frequency power that is produced by the intentional radiator shall be at least 20 dB below that in the 100 kHz bandwidth within the band that contains the highest level of the desired power, based on either an RF conducted or a radiated measurement, provided the transmitter demonstrates compliance with the peak conducted power limits. If the transmitter complies with the conducted power limits based on the use of RMS averaging over a time interval, as permitted under paragraph (b)(3) of this section, the attenuation required under this paragraph shall be 30 dB instead of 20 dB. Attenuation below the general limits specified in §15.209(a) is not required. In addition, radiated emissions which fall in the restricted bands, as defined in §15.205(a), must also comply with the radiated emission limits specified in §15.209(a) (see §15.205(c)).

9.3. Test Procedure

- a) Check the calibration of the measuring instrument using either an internal calibrator or a known signal from an external generator.
- b) Position the EUT without connection to measurement instrument. Turn on the EUT and connect its antenna terminal to measurement instrument via a low loss cable. Then set it to any one measured frequency within its operating range, and make sure the instrument is operated in its linear range.
- c) Set RBW to 100 kHz and VBW of spectrum analyzer to 300 kHz with a convenient frequency span including 100 kHz bandwidth from band edge.
- d) Measure the highest amplitude appearing on spectral display and set it as a reference level. Plot the graph with marking the highest point and edge frequency.
- e) Repeat above procedures until all measured frequencies were complete.



中国认可
国际互认
检测
TESTING
CNAS L3098



9.4. Test result

PASS (See below detailed test result.)

Frequency Band	Delta Peak to band emission (dBc)	>Limit (dBc)	Result
1Mbps Non-hopping			
2400	44.27	20	Pass
2483.5	65.10	20	Pass
2Mbps Non-hopping			
2400	46.10	20	Pass
2483.5	61.28	20	Pass
3Mbps Non-hopping			
2400	46.13	20	Pass
2483.5	58.86	20	Pass

Frequency Band	Delta Peak to band emission (dBc)	>Limit (dBc)	Result
1Mbps hopping			
2400	56.87	20	Pass
2483.5	61.68	20	Pass
2Mbps hopping			
2400	50.31	20	Pass
2483.5	61.54	20	Pass
3Mbps hopping			
2400	50.79	20	Pass
2483.5	58.92	20	Pass



中国认可
国际互认
检测
TESTING
CNAS L3098



GFSK

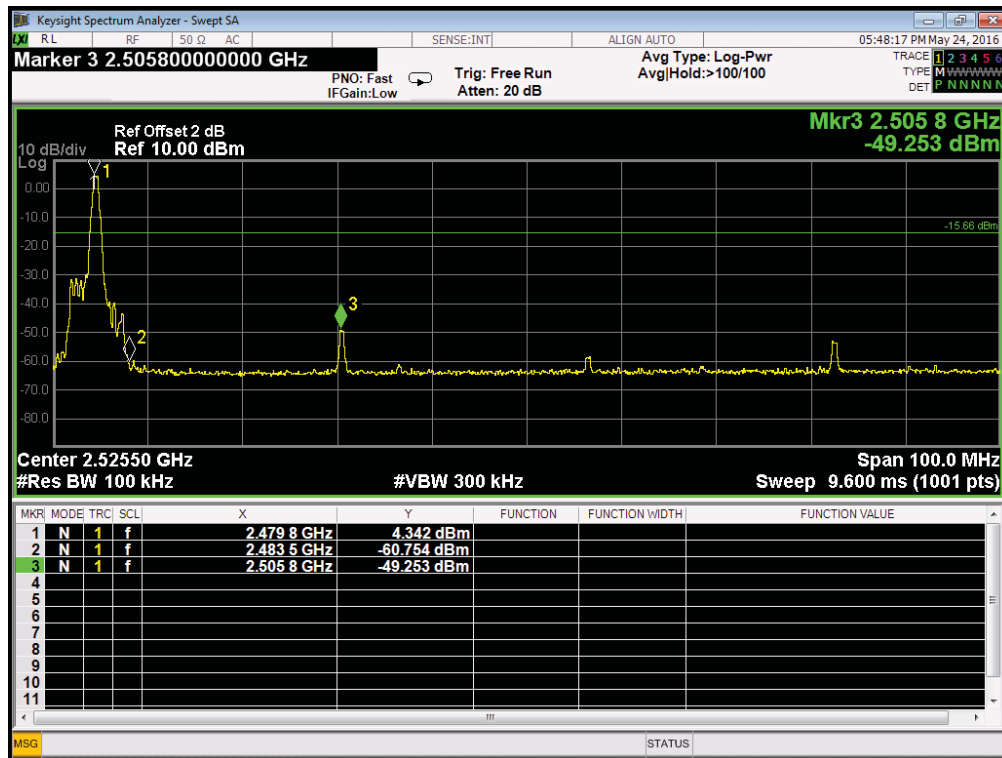
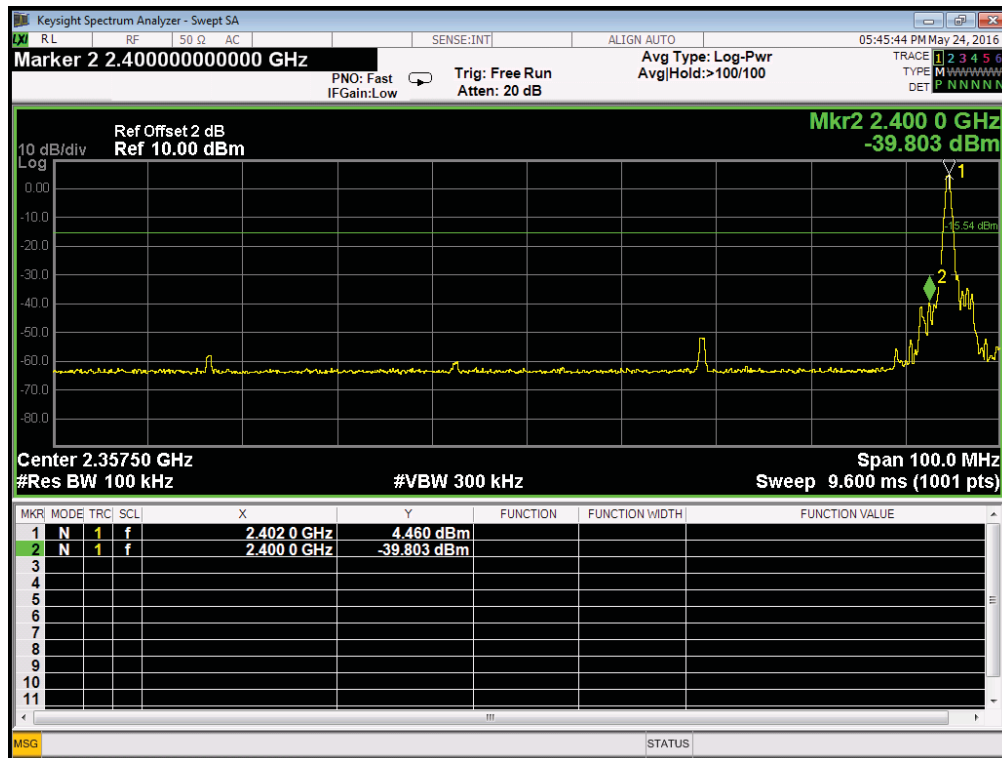



中国认可
国际互认
检测
TESTING
CNAS L3098



$\pi/4$ DQPSK

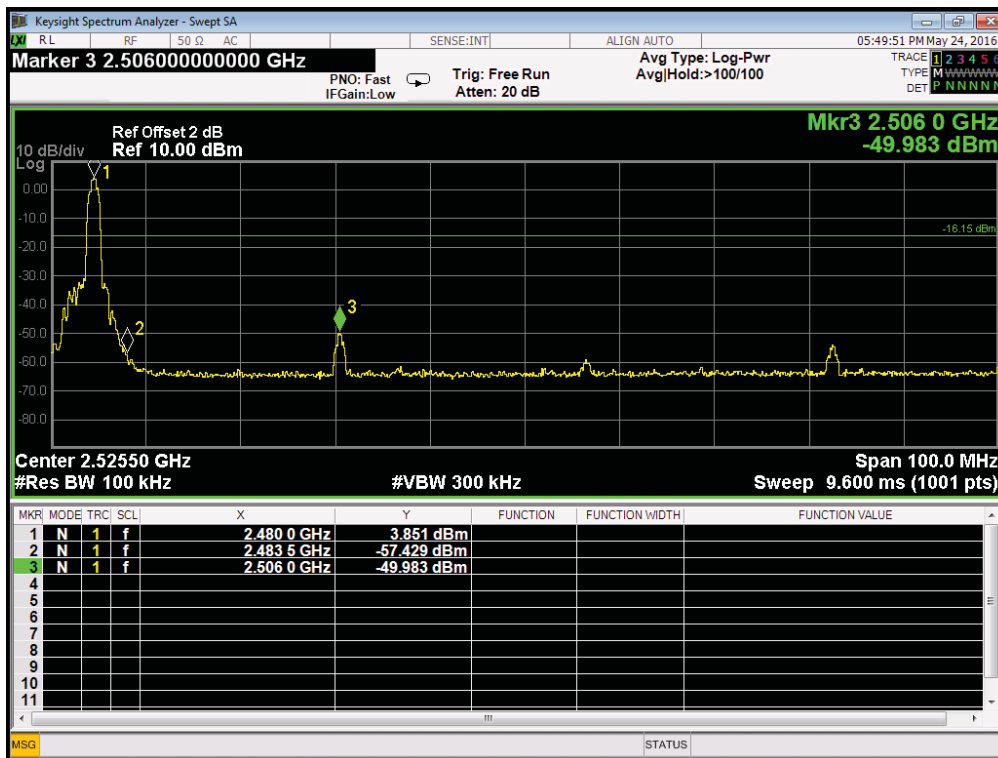
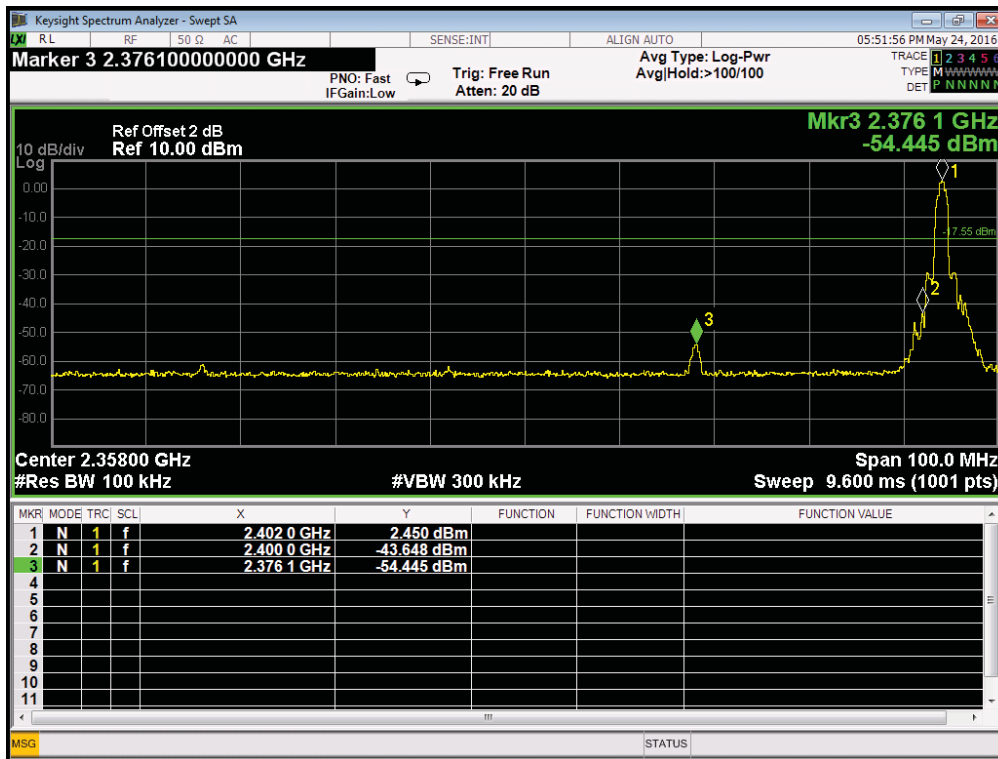



8DPSK

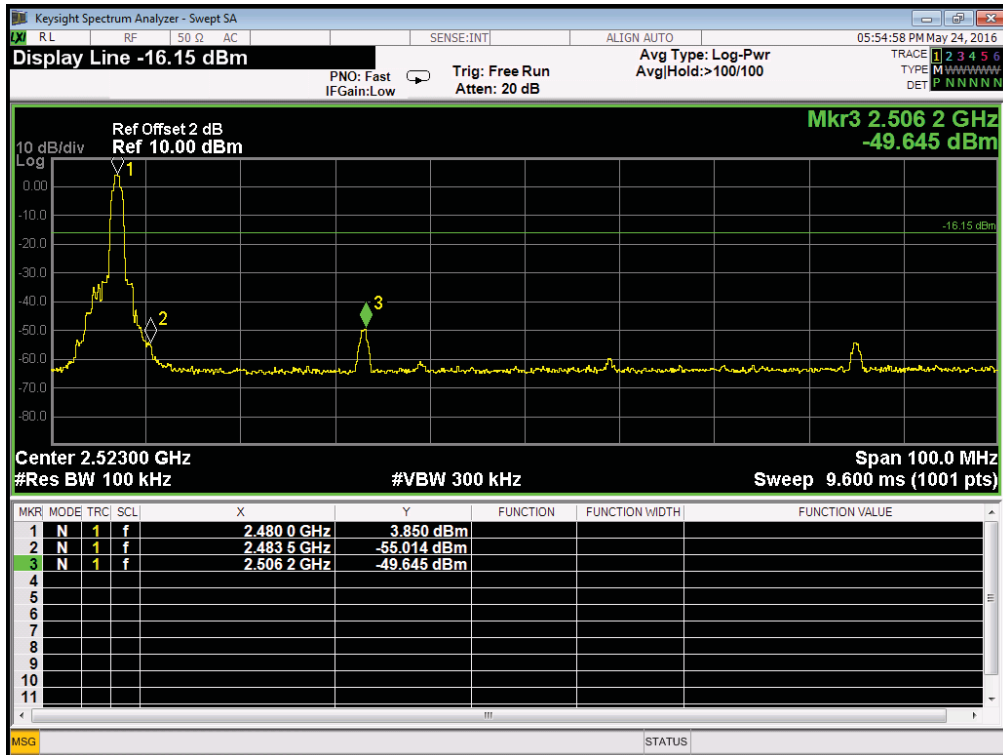
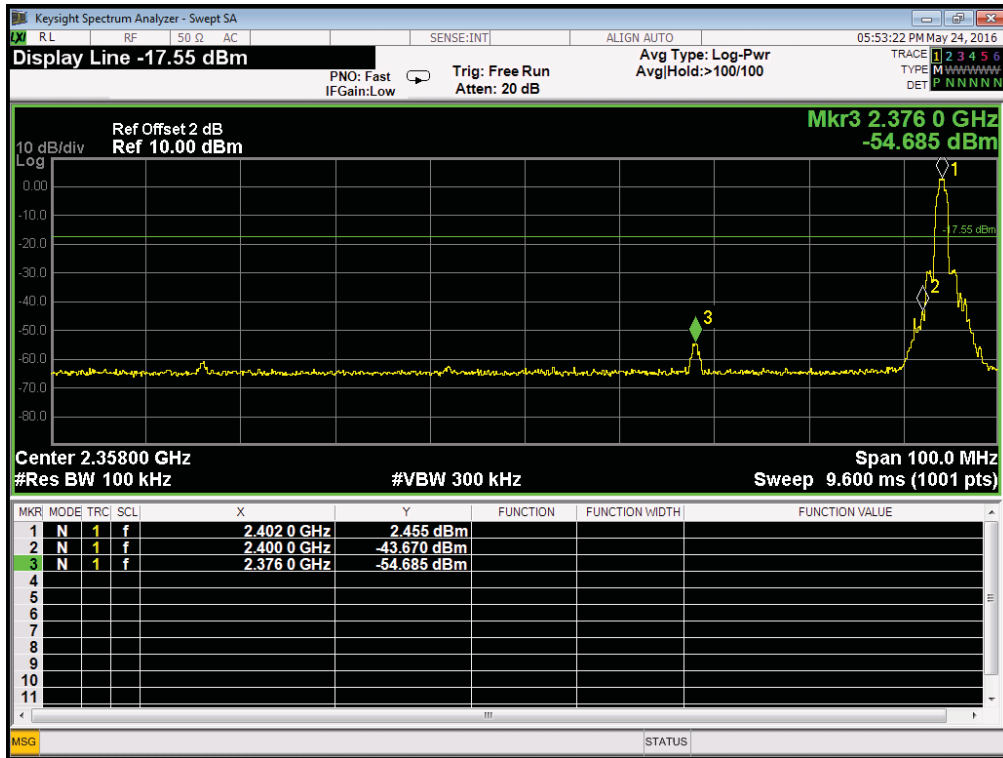



中国认可
国际互认
检测
TESTING
CNAS L3098



GFSK 2402MHz

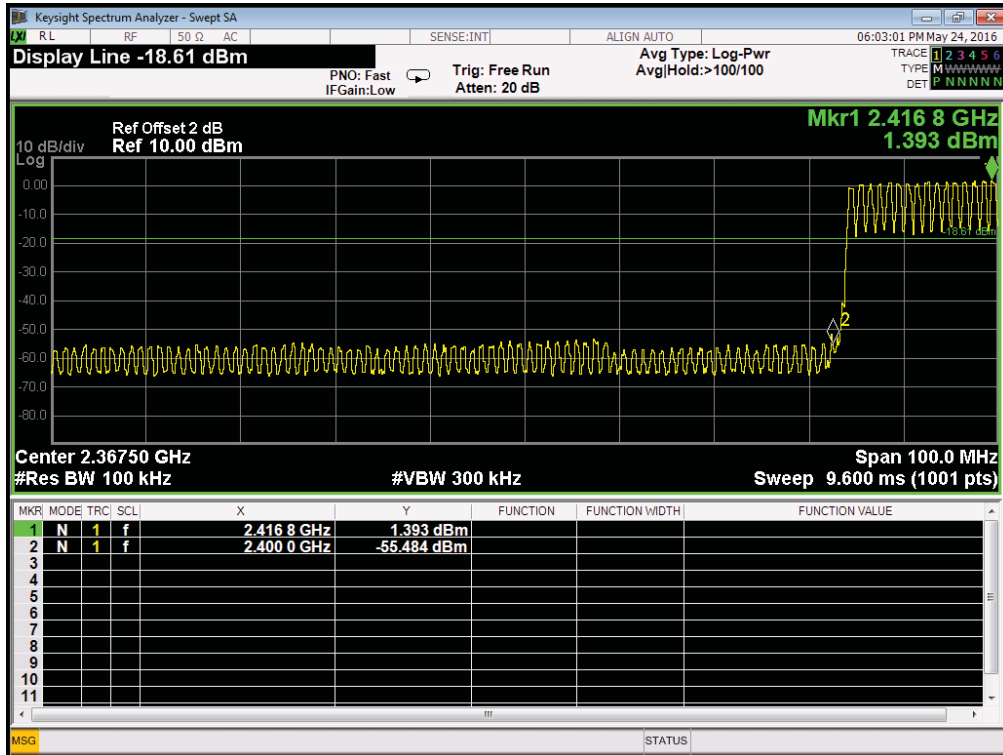

GFSK 2480MHz

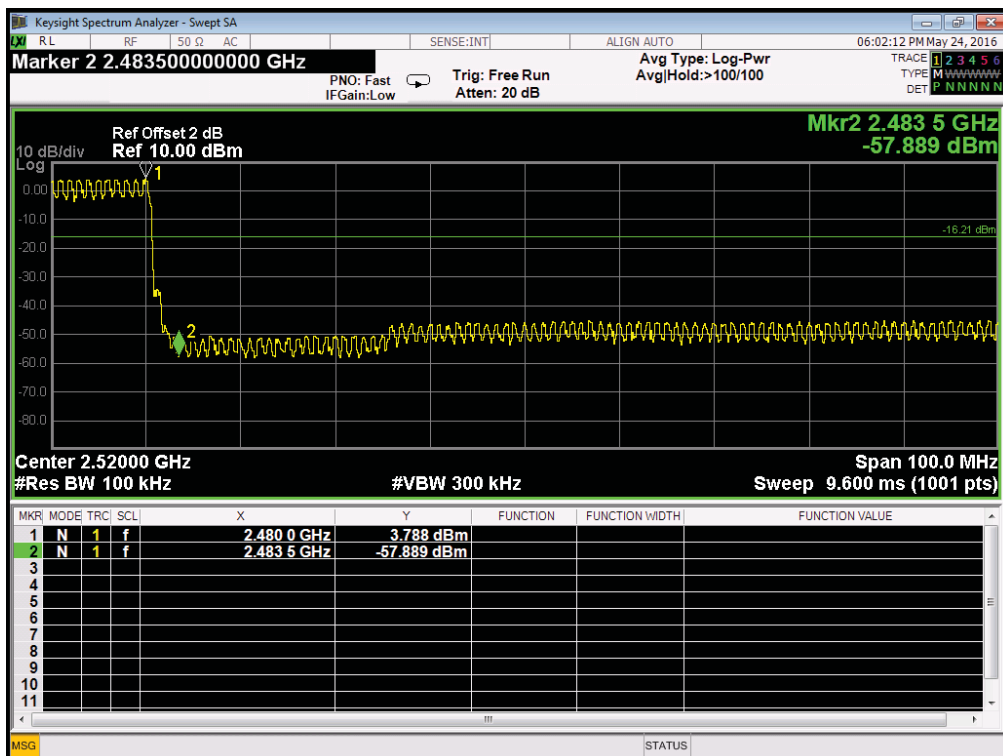



中国认可
国际互认
检测
TESTING
CNAS L3098



π /4DQPSK 2402MHz

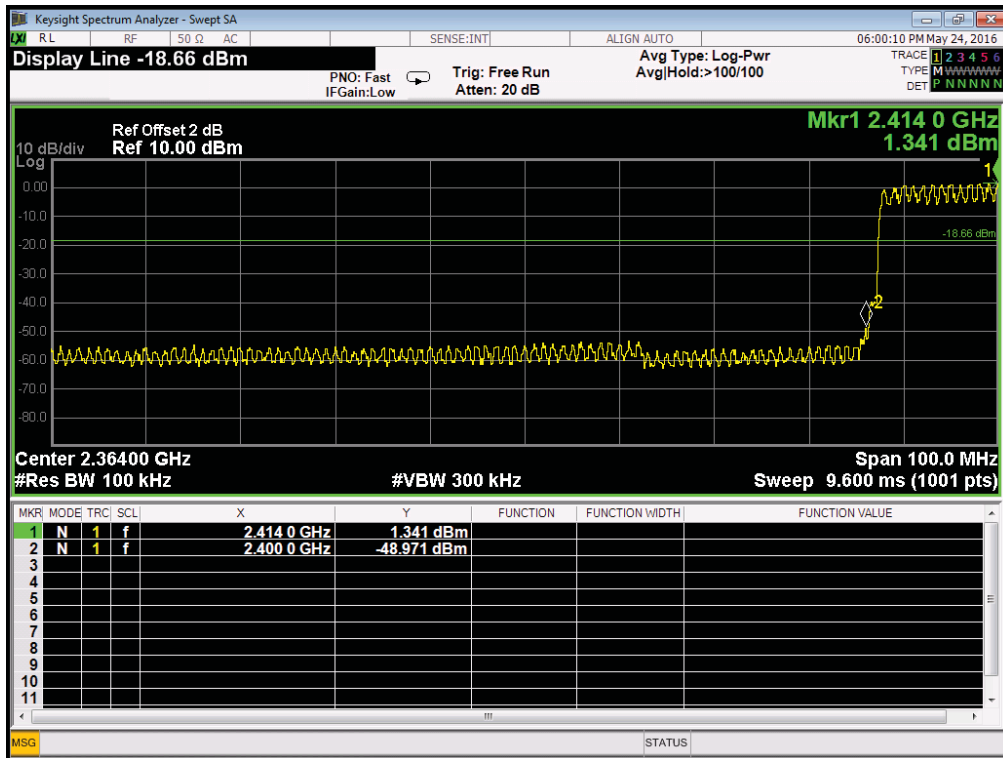

π /4DQPSK 2480MHz

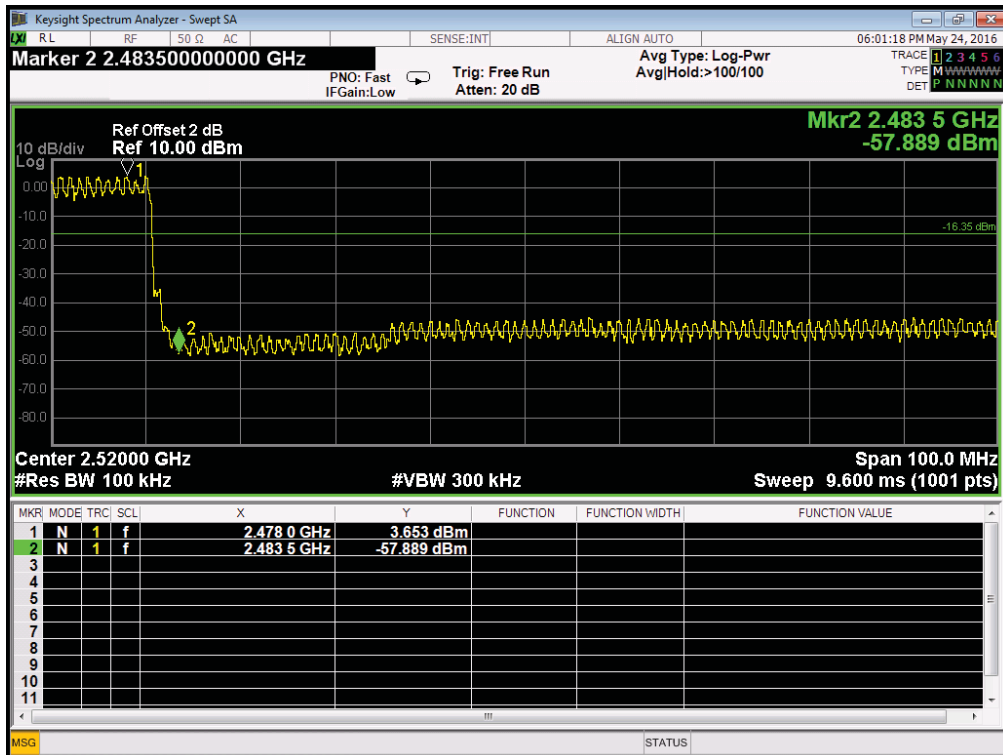



中国认可
国际互认
检测
TESTING
CNAS L3098



8DPSK 2402MHz

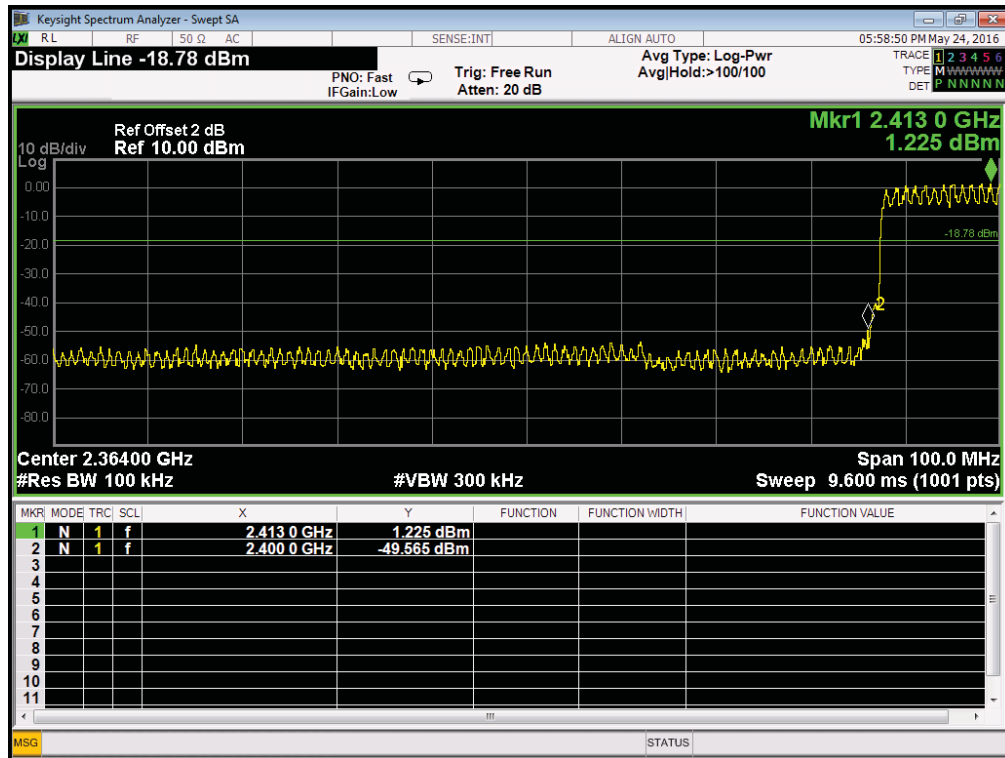

8DPSK 2480MHz

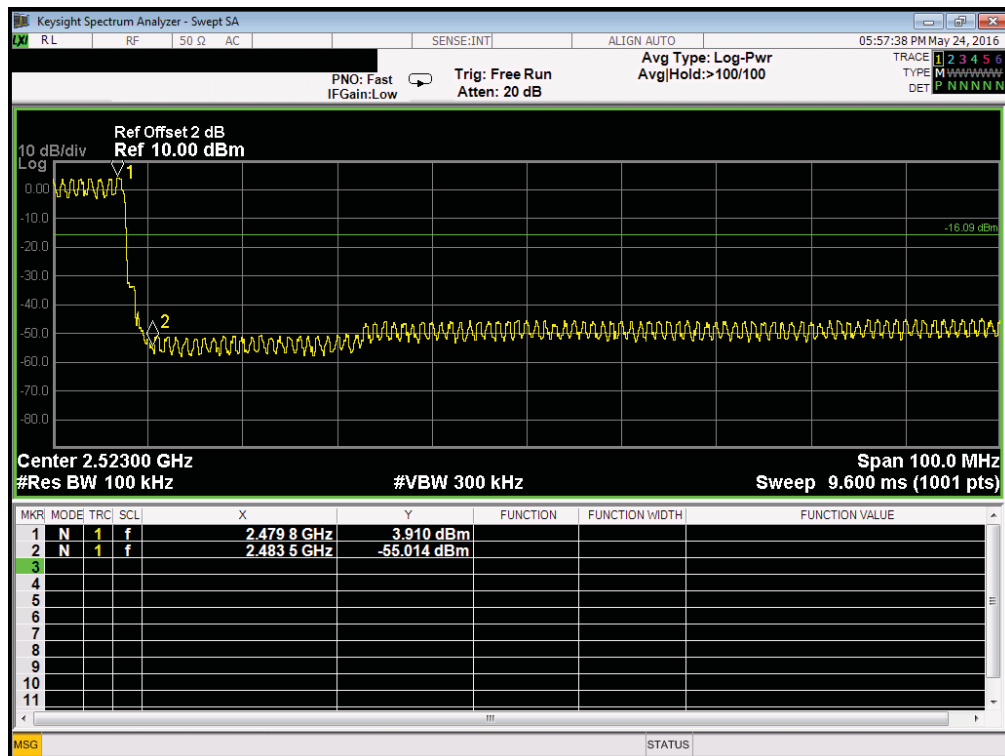



10. ANTENNA REQUIREMENTS

10.1. Limit

For intentional device, according to FCC 47 CFR Section 15.203, an intentional radiator shall be designed to ensure that no antenna other than that furnished by the responsible party shall be used with the device. And according to FCC 47 CFR Section 15.247 (b), if transmitting antennas of directional gain greater than 6dBi are used, the power shall be reduced by the amount in dB that the directional gain of the antenna exceeds 6dBi.

10.2. EUT ANTENNA

The EUT antenna is permanent attached antenna. It comply with the standard requirement.

END OF REPORT