

# FCC RADIO TEST REPORT

For

**FCC ID: X5B-048116**

**IC: 8814A-048116**

Report Reference No..... : 19EFAB05008 51  
Date of issue..... : 2019-08-19  
Testing Laboratory..... : DongGuan ShuoXin Electronic Technology Co., Ltd.  
Address..... : Zone A, 1F, No. 6, XinGang Road YuanGang Street, XinAn  
District, ChangAn Town, DongGuan City, GuangDong, China  
  
Applicant's name.....: Performance Designed Products, LLC  
Address.....: 14144 Ventura Blvd, Suite 200 Sherman Oaks, CA 91423 U.S.A  
Manufacturer.....: Performance Designed Products, LLC

**Test specification:**

Test item description..... : MARS IR STATION FOR XBOX ONE  
Trade Mark ..... : N/A  
Model/Type reference..... : 048-116  
Ratings..... : I/P: USB 5Vdc for XBOX ONE

Responsible Engineer :



Lake Hu

Authorized Signatory:

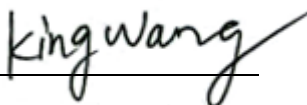

King Wang

## TABLE OF CONTENTS

1. Summary of test Standards and results.....	3
2. General test information .....	4
2.1. Description of EUT .....	4
2.2. Accessories of EUT .....	5
2.3. Assistant equipment used for test .....	5
2.4. Block diagram of EUT configuration for test .....	5
2.5. Test environment conditions .....	5
2.6. Measurement uncertainty .....	6
2.7. Table Of Parameters Of Test Software Setting.....	6
3. 99% Occupied Bandwidth.....	7
3.1. Test equipment.....	7
3.2. Block diagram of test setup .....	7
3.3. Limits.....	7
3.4. Test Procedure .....	7
3.5. Test Result.....	8
3.6. Original test data .....	8
4. Field Strength of Spurious Emissions And Field Strength of Fundamental .....	10
4.1. Test equipment.....	10
4.2. Block diagram of test setup .....	11
4.3. Limit.....	12
4.4. Test Procedure .....	13
4.5. Test result.....	14
5 Power Line Conducted Emission .....	29
5.1 Test equipment.....	29
5.2 Block diagram of test setup .....	29
5.3 Power Line Conducted Emission Limits(Class B).....	29
5.4 Test Procedure .....	30
5.5 Test Result .....	30
6 Frequency Stability.....	33
6.1. Test equipment.....	33
6.2. Block diagram of test setup .....	33
6.3 Test Result .....	34

**TEST REPORT DECLARE**

<b>Applicant</b>	:	Performance Designed Products, LLC
<b>Address</b>	:	14144 Ventura Blvd, Suite 200 Sherman Oaks, CA 91423 U.S.A
<b>Equipment under Test</b>	:	MARS IR STATION FOR XBOX ONE
<b>Test Model No</b>	:	048-116
<b>Manufacturer</b>	:	Performance Designed Products, LLC
<b>Address</b>	:	14144 Ventura Blvd, Suite 200 Sherman Oaks, CA 91423 U.S.A

**Test Standard Used:** FCC Rules and Regulations Part 15 Subpart C (15.249)

RSS-210 Issue 9 August 2016, RSS-GEN Issue 5, March 2019

**Test procedure used:** ANSI C63.10:2013, ANSI C63.4:2014

**We Declare:**

The equipment described above is tested by DongGuan ShuoXin Electronic Technology Co., Ltd. and in the configuration tested the equipment complied with the standards specified above. The test results are contained in this test report and DongGuan ShuoXin Electronic Technology Co., Ltd. is assumed of full responsibility for the accuracy and completeness of these tests.

**After test and evaluation, our opinion is that the equipment provided for test compliance with the requirement of the above FCC standards.**

<b>Report No:</b>	19EFAB05008 51		
<b>Date of Test:</b>	2019-04-30 To 2019-08-19	<b>Date of Report:</b>	2019-08-19

Note: This report applies to above tested sample only. This report shall not be reproduced in parts without written approval of DongGuan ShuoXin Electronic Technology Co., Ltd.

## 1. Summary of test Standards and results

The EUT have been tested according to the applicable standards as referenced below.

Description of Test Item	Standard	Results
Restricted bands of operation	FCC Part 15.205, RSS-GEN 8.10	PASS
AC Line Conducted Emissions	FCC Part 15.207 (a), RSS-GEN 8.8	PASS
20dB 99% Bandwidth	15.215(c), RSS-GEN 6.7	PASS
Radiated emission	FCC Part 15.209, 15.249 (a), RSS-GEN 8.9 8.10	PASS
Bandedge	15.249(d), RSS-210 B.10 (b)	PASS
Frequency Stability	RSS-GEN section 6.11	PASS

NOTE: "N/A" denotes test is not applicable in this Test Report

## 2. General test information

### 2.1. Description of EUT

EUT* Name	:	MARS IR STATION FOR XBOX ONE
Model Number	:	048-116
EUT function description	:	Please reference user manual of this device
Power supply	:	USB 5Vdc for XBOX ONE
Adaptor	:	N/A
Radio Technology	:	DTS
Operation frequency	:	2402-2480MHz
Modulation	:	GFSK
Antenna Type	:	Internal Antenna, maximum PK gain: -1.2dBi
Date of Receipt	:	2019/04/29
Sample Type	:	Single production
Hardware Version	:	Rev. C
Software Version	:	V2.14

Note: EUT is the ab. of equipment under test.

Channle information							
CH	Frequency	CH	Frequency	CH	Frequency	CH	Frequency
0	2402	10	2422	20	2442	30	2462
1	2404	11	2424	21	2444	31	2464
2	2406	12	2426	22	2446	32	2466
3	2408	13	2428	23	2448	33	2468
4	2410	14	2430	24	2450	34	2470
5	2412	15	2432	25	2452	35	2472
6	2414	16	2434	26	2454	36	2474
7	2416	17	2436	27	2456	37	2476
8	2418	18	2438	28	2458	38	2478
9	2420	19	2440	29	2460	39	2480

## 2.2. Accessories of EUT

Description of Accessories	Manufacturer	Model number or Type	Other
C1	/	EUT USB Cable	2.5m

## 2.3. Assistant equipment used for test

Description of Assistant equipment	Manufacturer	Model number or Type	Other
(AE) Notebook	Lenovo	B470e	EB05696916

## 2.4. Block diagram of EUT configuration for test

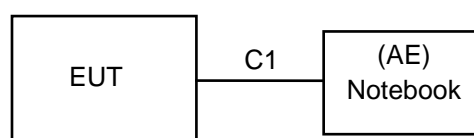

EUT enters the engineering interface by clicking the system version to control EUT work in test mode as blow table.

Tested mode, channel, and data rate information			
Mode	data rate (Mbps) (see Note)	Channel	Frequency (MHz)
DTS	1	Low: CH 0	2402
DTS	1	Medium: CH 20	2442
DTS	1	High: CH 39	2480

Note: According exploratory test, EUT will have maximum output power in those data rate, so those data rate were used for all test.

## 2.5. Test environment conditions

During the measurement the environmental conditions were within the listed ranges:

Temperature range:	21-25°C
Humidity range:	40-75%
Pressure range:	86-106kPa

## 2.6. Measurement uncertainty

Test Item	Uncertainty
Uncertainty for Conduction emission test (9kHz-150kHz)	3.7 dB
Uncertainty for Conduction emission test (150kHz-30MHz)	3.3 dB
Uncertainty for Radiation Emission test (30MHz-200MHz)	4.60 dB (Polarize: V)
	4.60 dB (Polarize: H)
Uncertainty for Radiation Emission test (200MHz-1GHz)	6.10 dB (Polarize: V)
	5.08 dB (Polarize: H)
Uncertainty for Radiation Emission test (1GHz-6GHz)	5.01 dB (Polarize: V)
	5.01 dB (Polarize: H)
Uncertainty for Radiation Emission test (6GHz-18GHz)	5.26 dB (Polarize: V)
	5.26 dB (Polarize: H)
Uncertainty for Radiation Emission test (18GHz-40GHz)	5.06 dB (Polarize: V)
	5.06 dB (Polarize: H)
Uncertainty for radio frequency	$\pm 0.048\text{kHz}$
Uncertainty for conducted RF Power	$\pm 0.32\text{dB}$

Note: This uncertainty represents an expanded uncertainty expressed at approximately the 95% confidence level using a coverage factor of k=2.

## 2.7. Table Of Parameters Of Test Software Setting

During testing channel & power controlling software provided by the customer was used to control the operating channel as well as the output power level. The RF output power selection is for the setting of RF output power expected by the customer and is going to be fixed on the firmware of the final end product.

Test Software Version	MARS USB Test Console(V1.03)		
Frequency (MHz)	2402	2442	2480
Power Parameters (GFSK)	default	default	default

### 3. 99% Occupied Bandwidth

#### 3.1. Test equipment

Item	Equipment	Manufacturer	Model No.	Serial No.	Calibrated until	Calibrated Date
1	Spectrum analyzer	KEYSIGHT	N9010A	MY55150427	05/27/2020	05/28/2019
2	Attenuator	Mini-Circuits	BW-S10W2	101109	12/16/2019	12/17/2018
3	RF Cable	Micable	C10-01-01-1	100309	12/16/2019	12/17/2018

#### 3.2. Block diagram of test setup

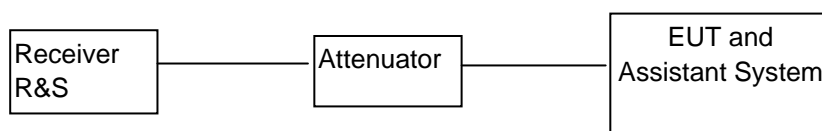

#### 3.3. Limits

N/A

#### 3.4. Test Procedure

- (1) Check the calibration of the measuring instrument using either an internal calibrator or a known signal from an external generator.
- (2) Position the EUT without connection to measurement instrument. Turn on the EUT and connect it to measurement instrument. Then set it to any one convenient frequency within its operating range. Set a reference level on the measuring instrument equal to the highest peak value.
- (3) Measure the frequency difference of two frequencies that were attenuated 6 dB from the reference level. Record the frequency difference as the emission bandwidth.
- (4) Repeat above procedures until all frequencies measured were complete.



### 3.5. Test Result

Frequency (MHz)	20dB Bandwidth (MHz)	99% dB bandwidth (MHz)
2402	1.189	1.0440
2442	1.178	1.0376
2480	1.127	1.0585

### 3.6. Original test data

CH 0

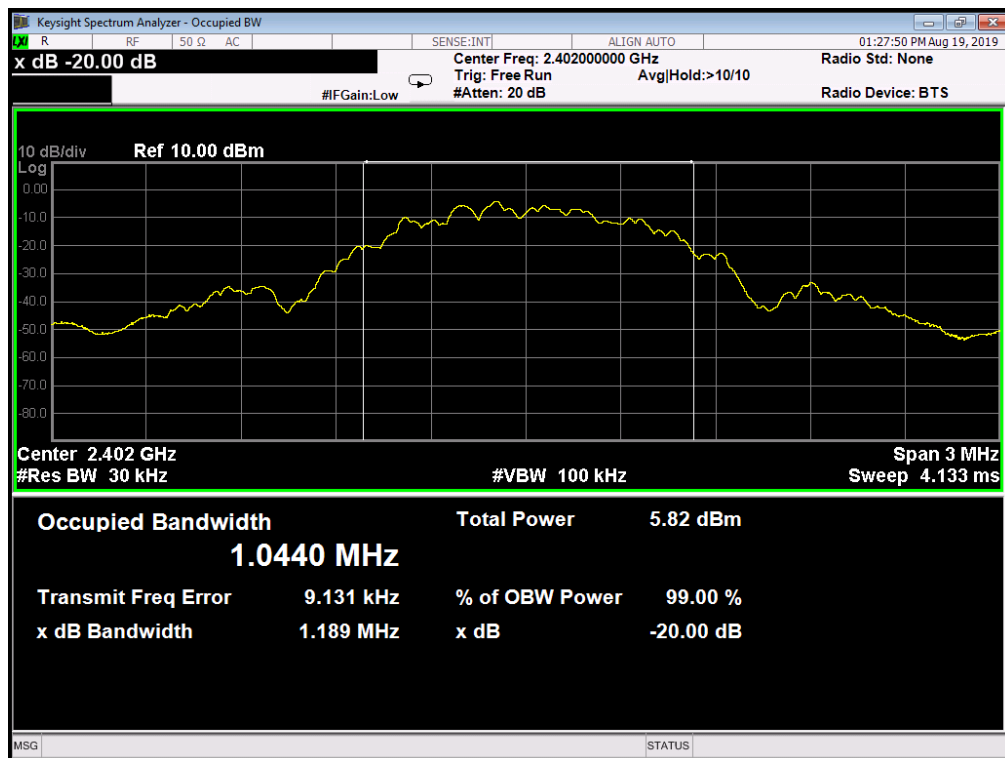

### CH 20

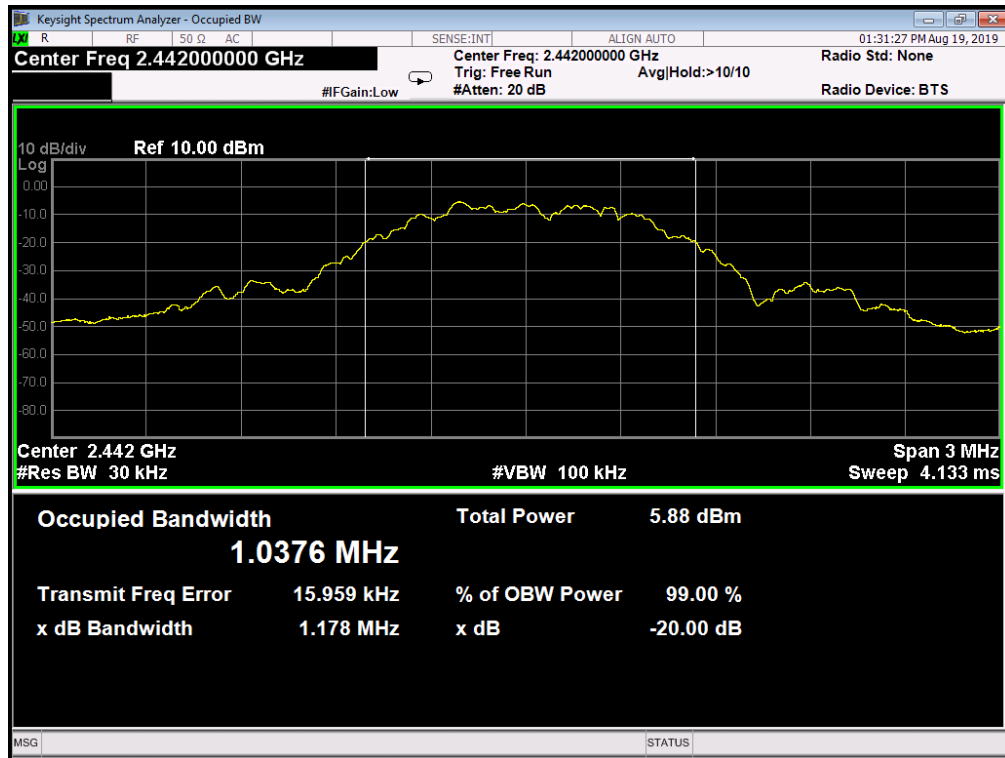

### CH 39

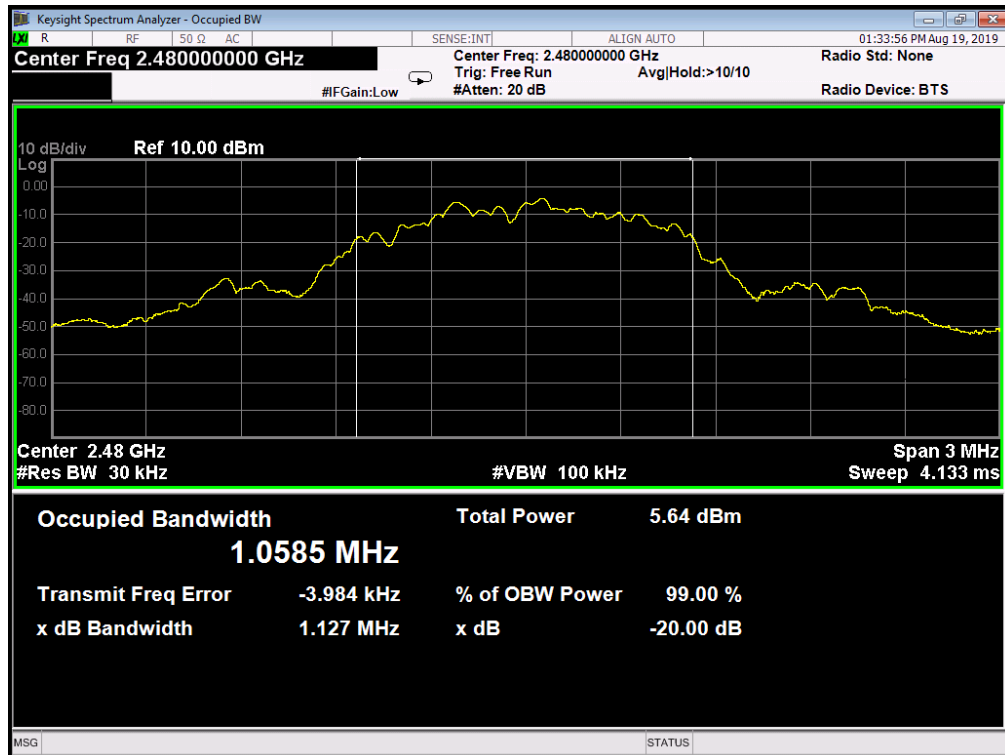

## 4. Field Strength of Spurious Emissions And Field Strength of Fundamental

### 4.1. Test equipment

Item	Equipment	Manufacturer	Model No.	Serial No.	Calibrated until	Calibrated Date
1	EMI Test Receiver	R&S	ESCI	101307	12/16/2019	12/17/2018
2	Spectrum analyzer	Agilent	E4407B	US40240708	11/20/2019	11/21/2018
3	Trilog Broadband Antenna	Schwarzbeck	VULB9168	VULB9168-192	03/22/2020	03/23/2019
4	Double Ridged Horn Antenna	SCHWARZBEC K	BBHA 9120D1065	100276	12/16/2019	12/17/2018
5	Double Ridged Horn Antenna	SCHWARZBEC K	BBHA 9120D1065	100546	12/16/2019	12/17/2018
6	Dipole antenna	Schwarzbeck	UHAP	1101	12/16/2019	12/17/2018
7	Dipole antenna	Schwarzbeck	VHAP	1118	12/16/2019	12/17/2018
8	Pre-Amplifier	CY	EMC011830	980136	12/19/2019	12/20/2018
9	Pre-amplifier	HP	8447F	3113A05680	12/16/2019	12/17/2018
10	RF Cable	R&S	R01	10403	12/16/2019	12/17/2018
11	RF Cable	R&S	R02	10512	12/16/2019	12/17/2018
12	RF Cable	R&S	R01	10454	12/16/2019	12/17/2018
13	RF Cable	R&S	R02	10343	12/16/2019	12/17/2018
14	6 dB Attenuator	EMEC	ATT6000-6-N N	N/A	12/16/2019	12/17/2018
15	Turn Table	UC	UC3000	N/A	N/A	N/A
16	Antenna Mast	UC	UC3000	N/A	N/A	N/A
17	Measurement Software	Farad	EZ-EMC (Ver.ATT-03 A)	N/A	N/A	N/A

## 4.2. Block diagram of test setup

In 3m Anechoic Chamber Test Setup Diagram for below 1GHz

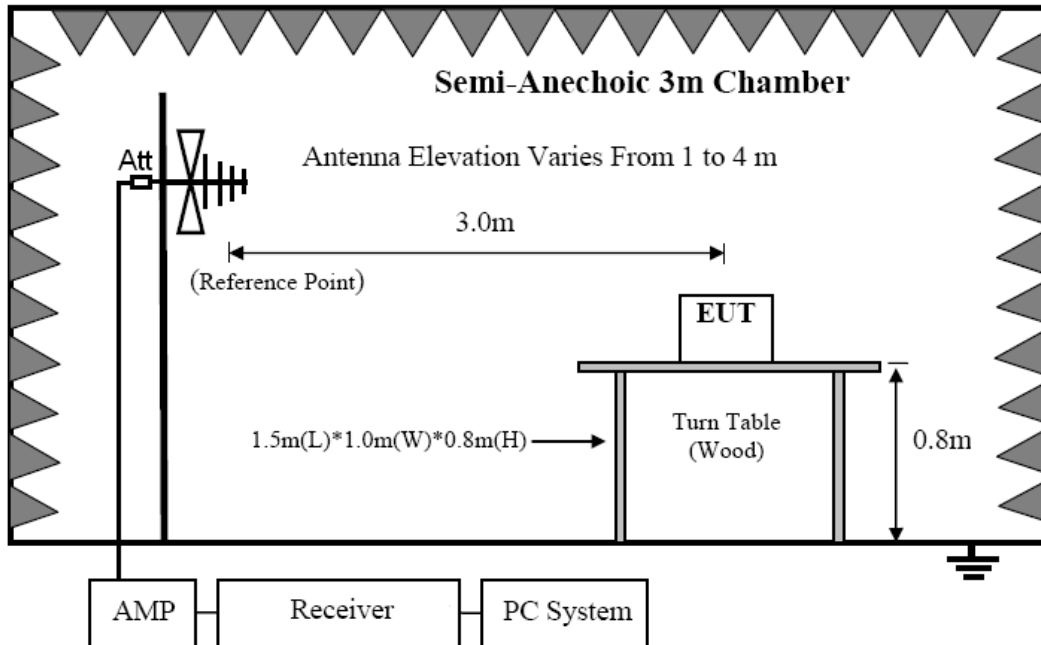

In 3m Anechoic Chamber Test Setup Diagram for frequency above 1GHz

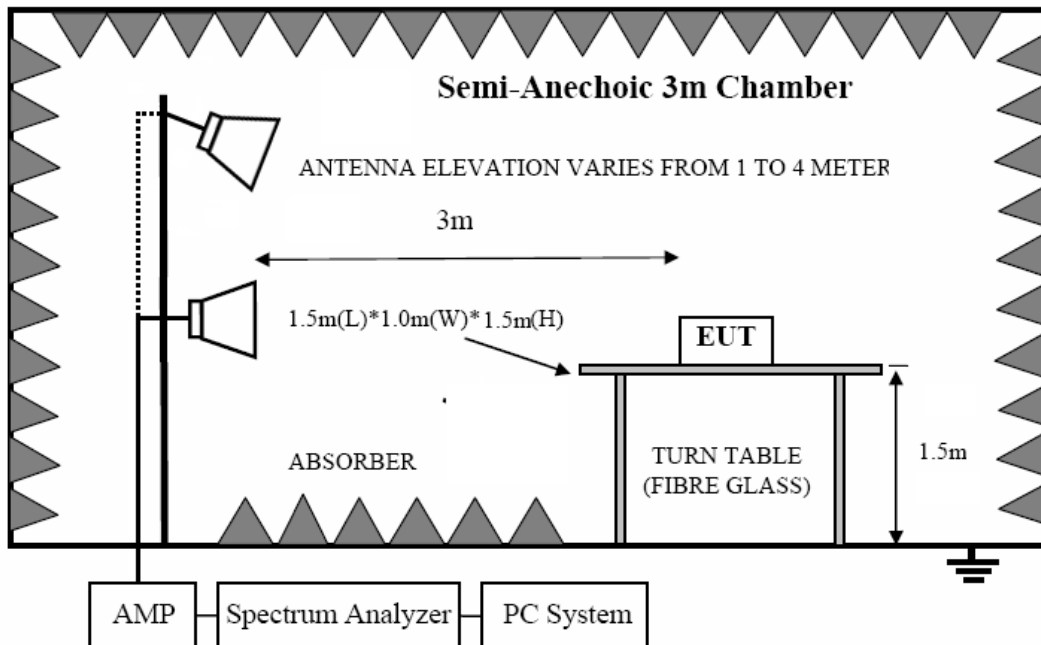

Note: For harmonic emissions test a appropriate high pass filter was inserted in the input port of AMP.

### 4.3. Limit

#### 6.3.1 FCC 15.205 Restricted frequency band

MHz	MHz	MHz	GHz
0.090 - 0.110	16.42 - 16.423	399.9 - 410	4.5 - 5.15
<sup>1</sup> 0.495 - 0.505	16.69475 - 16.69525	608 - 614	5.35 - 5.46
2.1735 - 2.1905	16.80425 - 16.80475	960 - 1240	7.25 - 7.75
4.125 - 4.128	25.5 - 25.67	1300 - 1427	8.025 - 8.5
4.17725 - 4.17775	37.5 - 38.25	1435 - 1626.5	9.0 - 9.2
4.20725 - 4.20775	73 - 74.6	1645.5 - 1646.5	9.3 - 9.5
6.215 - 6.218	74.8 - 75.2	1660 - 1710	10.6 - 12.7
6.26775 - 6.26825	108 - 121.94	1718.8 - 1722.2	13.25 - 13.4
6.31175 - 6.31225	123 - 138	2200 - 2300	14.47 - 14.5
8.291 - 8.294	149.9 - 150.05	2310 - 2390	15.35 - 16.2
8.362 - 8.366	156.52475 - 156.52525	2483.5 - 2500	17.7 - 21.4
8.37625 - 8.38675	156.7 - 156.9	2690 - 2900	22.01 - 23.12
8.41425 - 8.41475	162.0125 - 167.17	3260 - 3267	23.6 - 24.0
12.29 - 12.293	167.72 - 173.2	3332 - 3339	31.2 - 31.8
12.51975 - 12.52025	240 - 285	3345.8 - 3358	36.43 - 36.5
12.57675 - 12.57725	322 - 335.4	3600 - 4400	( <sup>2</sup> )

#### 6.3.2 FCC 15.209 Limit

FREQUENCY MHz	DISTANCE Meters	FIELD STRENGTHS LIMIT	
		$\mu\text{V}/\text{m}$	$\text{dB}(\mu\text{V})/\text{m}$
30 ~ 88	3	100	40.0
88 ~ 216	3	150	43.5
216 ~ 960	3	200	46.0
960 ~ 1000	3	500	54.0
Above 1000	3	74.0 $\text{dB}(\mu\text{V})/\text{m}$ (Peak) 54.0 $\text{dB}(\mu\text{V})/\text{m}$ (Average)	

#### 6.3.3 FCC 15.249(a) limit

Fundamental Frequency (MHz)	Field strength of fundamental (millivolts/meter)	Field strength of harmonics (millivolts/meter)
902-928	50	500
2400-2483.5	50	500
5725-5875	50	500
24.0-24.25	250	2500

#### 4.4. Test Procedure

- (1) EUT was placed on a non-metallic table, 80 cm above the ground plane inside a semi-anechoic chamber.
- (2) Setup EUT and assistant system according clause 2.4 and 8.2
- (3) Test antenna was located 3m from the EUT on an adjustable mast. Below pre-scan procedure was first performed in order to find prominent radiated emissions.
  - (a) Change work frequency or channel of device if practicable.
  - (b) Change modulation type of device if practicable.
  - (c) Change power supply range from 85% to 115% of the rated supply voltage
  - (d) Rotated EUT though three orthogonal axes to determine the attitude of EUT arrangement produces highest emissions
- (4) Spectrum frequency from 9MHz to 25GHz (tenth harmonic of fundamental frequency) was investigated, and no any obvious emission were detected from 9KHz to 30MHz and 18GHz to 25GHz, so below final test was performed with frequency range from 30MHz to 18GHz.
- (5) For final emissions measurements at each frequency of interest, the EUT were rotated and the antenna height was varied between 1m and 4m in order to maximize the emission. Measurements in both horizontal and vertical polarities were made and the data was recorded. In order to find the maximum emission, the relative positions of equipments and all of the interface cables were changed according to ANSI C63.10 2013 on Radiated Emission test.
- (6) For emissions from 30MHz to 1GHz, Quasi-Peak values were measured with EMI Receiver and the bandwidth of Receiver is 120 KHz.
- (7) For emissions above 1GHz, both Peak and Average level were measured with Spectrum Analyzer, and the RBW is set at 1MHz, VBW is set at 3MHz for Peak measure, Detector is at PK; RBW is set at 1MHz, VBW is set at 3MHz for Average measure, Detector is at RMS.
- (8) For Field Strength of Fundamental were measured with Spectrum Analyzer, and the RBW is set at above 99% Occupied Bandwidth , VBW is set at equal to RBW for Peak measure, Detector is at PK for PK value ,RMS detector for AV value.

## 4.5. Test result

### Below 30M

<b>EUT:</b>	MARS IR STATION FOR XBOX ONE	<b>Model No.:</b>	048-116
<b>Temperature:</b>	24°C	<b>Relative Humidity:</b>	55%
<b>Distance:</b>	3m	<b>Test Power:</b>	DC 5V
<b>Polarization:</b>	--	<b>Test Result:</b>	Pass
<b>Test Mode:</b>	Keeping TX mode	<b>Test By:</b>	Lake

Freq. (MHz)	Reading (dBuV/m)	Limit (dBuV/m)	Margin (dB)	State P/F
--	--	--	--	P
--	--	--	--	P

**Note:**

The amplitude of spurious emissions which are attenuated by more than 20dB below the permissible value has no need to be reported.

Distance extrapolation factor =  $20 \log(\text{specific distance}/\text{test distance})(\text{dB})$ ;

Limit line = specific limits(dBuv) + distance extrapolation factor

### Between 30M – 1000 MHz

EUT:	MARS IR STATION FOR XBOX ONE	Model No.:	048-116
Temperature:	24°C	Relative Humidity:	55%
Distance:	3m	Test Power:	DC5V
Polarization:	Vertical	Test Result:	Pass
Test Time:	2019-05-03	Test By:	Lake
Standard:	(RE)FCC PART 15		
Test Mode:	TX		
Note:	2402MHz		

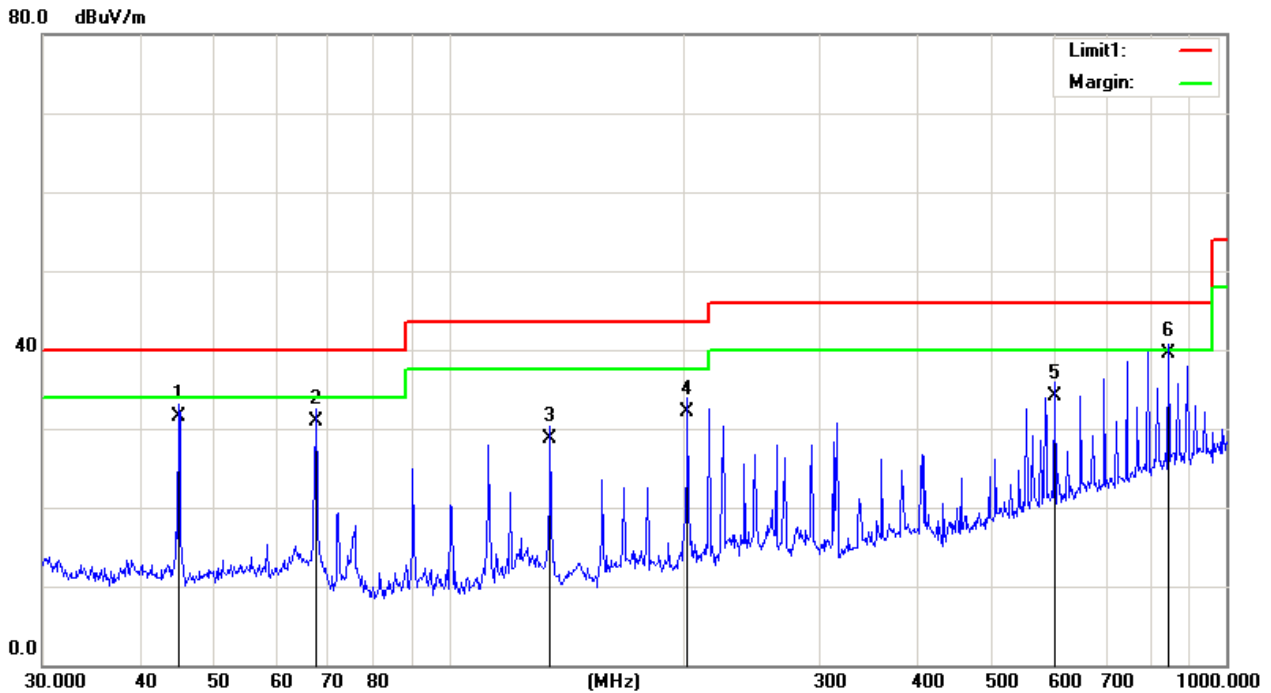

No.	Frequency (MHz)	Reading (dBuV/m)	Correct Factor (dB/m)	Result (dBuV/m)	Limit (dBuV/m)	Margin (dB)	Remark
1	44.9006	45.85	-14.37	31.48	40.00	-8.52	QP
2	67.4382	45.11	-14.15	30.96	40.00	-9.04	QP
3	135.0319	41.40	-12.65	28.75	43.50	-14.75	QP
4	202.8104	43.67	-11.61	32.06	43.50	-11.44	QP
5	601.4265	38.42	-4.25	34.17	46.00	-11.83	QP
6	842.1296	39.64	-0.08	39.56	46.00	-6.44	QP

The test result is calculated as the following:

- (1) Result = Reading + Correct Factor
- (2) Correct Factor = Antenna Factor + Cable Loss – Amplifier Gain + Attenuator
- (3) Margin = Result - Limit



<b>EUT:</b>	<b>MARS IR STATION FOR XBOX ONE</b>	<b>Model No.:</b>	<b>048-116</b>
<b>Temperature:</b>	<b>24°C</b>	<b>Relative Humidity:</b>	<b>55%</b>
<b>Distance:</b>	<b>3m</b>	<b>Test Power:</b>	<b>DC5V</b>
<b>Polarization:</b>	<b>Horizontal</b>	<b>Test Result:</b>	<b>Pass</b>
<b>Test Time:</b>	<b>2019-05-03</b>	<b>Test By:</b>	<b>Lake</b>
<b>Standard:</b>	<b>(RE)FCC PART 15</b>		
<b>Test Mode:</b>	<b>TX</b>		
<b>Note:</b>	<b>2402MHz</b>		

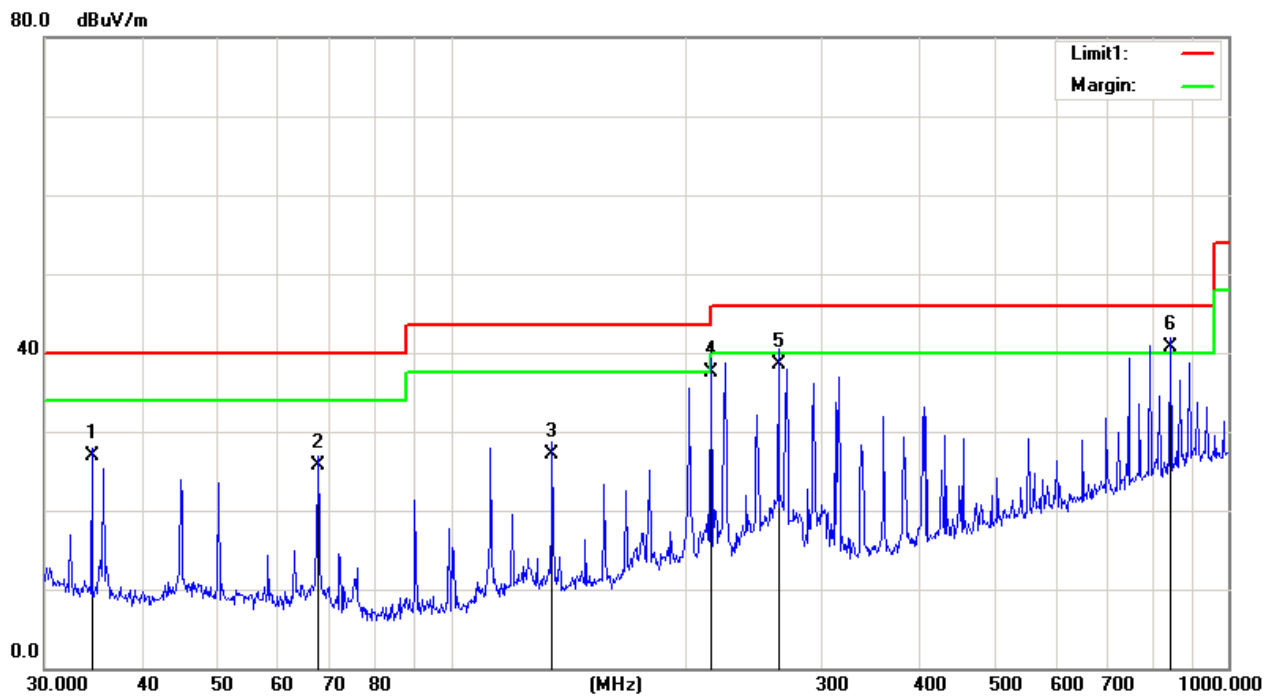

No.	Frequency (MHz)	Reading (dBuV/m)	Correct Factor(dB/m)	Result (dBuV/m)	Limit (dBuV/m)	Margin (dB)	Remark
1	34.5173	41.64	-14.79	26.85	40.00	-13.15	QP
2	67.4382	41.93	-16.17	25.76	40.00	-14.24	QP
3	135.0319	40.78	-13.65	27.13	43.50	-16.37	QP
4	216.0240	47.46	-9.91	37.55	46.00	-8.45	QP
5	263.8190	44.01	-5.42	38.59	46.00	-7.41	QP
6	842.1296	40.15	0.49	40.64	46.00	-5.36	QP

The test result is calculated as the following:

- (1) Result = Reading + Correct Factor
- (2) Correct Factor = Antenna Factor + Cable Loss – Amplifier Gain + Attenuator
- (3) Margin = Result - Limit

### Between 1000M – 25000 MHz

EUT:	MARS IR STATION FOR XBOX ONE	Model No.:	048-116
Temperature:	24°C	Relative Humidity:	55%
Distance:	3m	Test Power:	DC5V
Polarization:	Vertical	Test Result:	Pass
Test Time:	2019-05-03	Test By:	Lake
Standard:	FCC PART 15 C 1-26.5G PEAK		
Test Mode:	TX		
Note:	2402MHz		

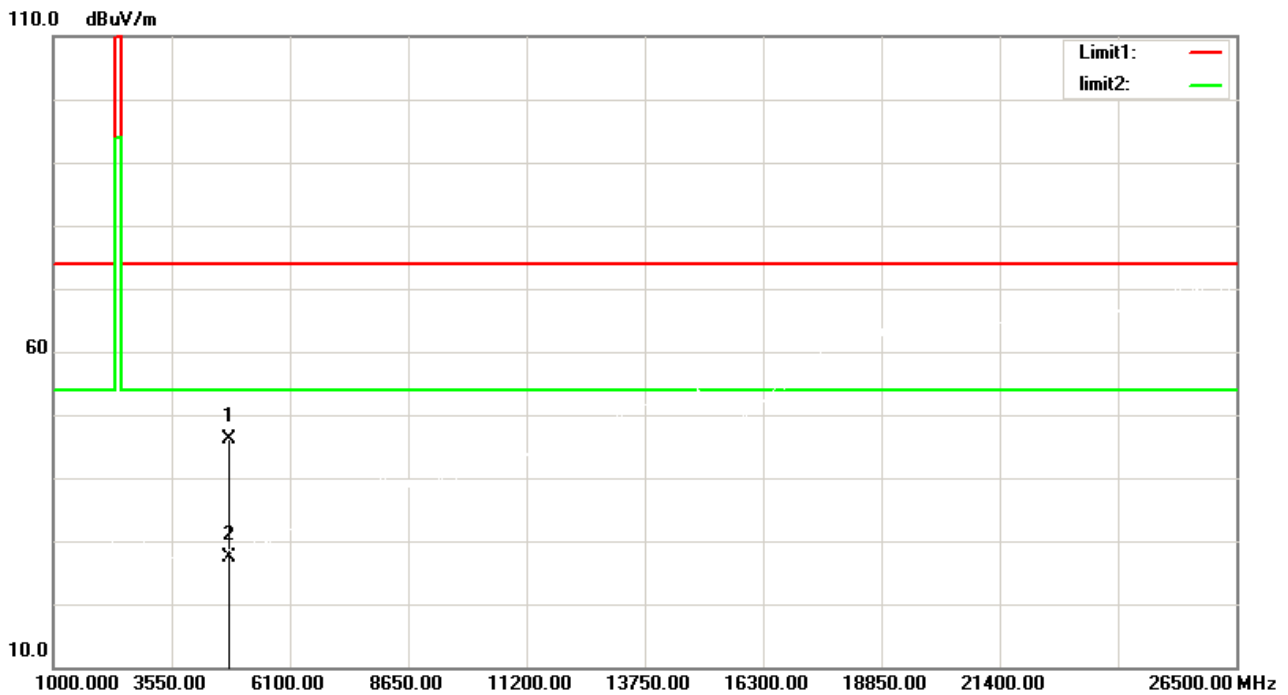

No.	Frequency (MHz)	Reading (dBuV/m)	Correct Factor(dB/m)	Result (dBuV/m)	Limit (dBuV/m)	Margin (dB)	Remark
1	4804.209	56.80	-10.79	46.01	74.00	-27.99	peak
2	4804.209	38.14	-10.79	27.35	54.00	-26.65	AVG

The test result is calculated as the following:

- (1) Result = Reading + Correct Factor
- (2) Correct Factor = Antenna Factor + Cable Loss – Amplifier Gain + Attenuator
- (3) Margin = Result - Limit

<b>EUT:</b>	<b>MARS IR STATION FOR XBOX ONE</b>	<b>Model No.:</b>	<b>048-116</b>
<b>Temperature:</b>	<b>24°C</b>	<b>Relative Humidity:</b>	<b>55%</b>
<b>Distance:</b>	<b>3m</b>	<b>Test Power:</b>	<b>DC5V</b>
<b>Polarization:</b>	<b>Horizontal</b>	<b>Test Result:</b>	<b>Pass</b>
<b>Test Time:</b>	<b>2019-05-03</b>	<b>Test By:</b>	<b>Lake</b>
<b>Standard:</b>	<b>FCC PART 15 C 1-26.5G PEAK</b>		
<b>Test Mode:</b>	<b>TX</b>		
<b>Note:</b>	<b>2402MHz</b>		

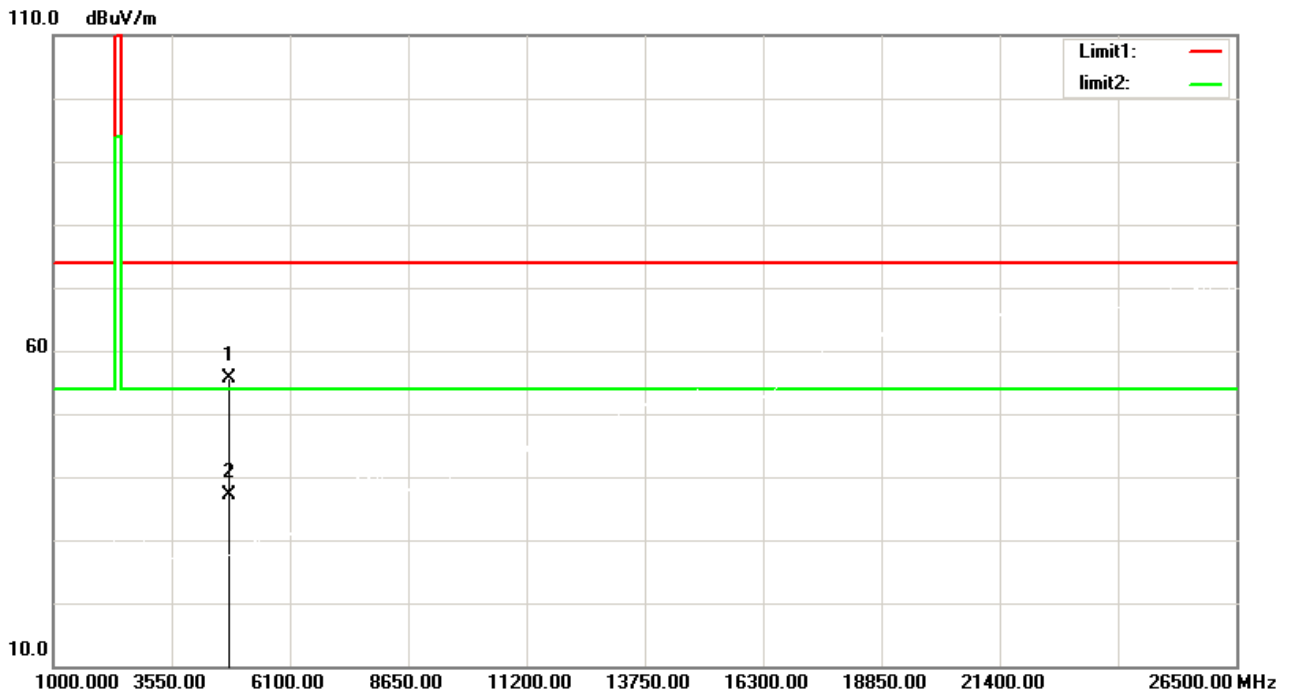

No.	Frequency (MHz)	Reading (dBuV/m)	Correct Factor(dB/m)	Result (dBuV/m)	Limit (dBuV/m)	Margin (dB)	Remark
1	4804.169	66.46	-10.79	55.67	74.00	-18.33	peak
2	4804.169	47.80	-10.79	37.01	54.00	-16.99	AVG

The test result is calculated as the following:

- (1) Result = Reading + Correct Factor
- (2) Correct Factor = Antenna Factor + Cable Loss – Amplifier Gain + Attenuator
- (3) Margin = Result - Limit

<b>EUT:</b>	<b>MARS IR STATION FOR XBOX ONE</b>	<b>Model No.:</b>	<b>048-116</b>
<b>Temperature:</b>	<b>24°C</b>	<b>Relative Humidity:</b>	<b>55%</b>
<b>Distance:</b>	<b>3m</b>	<b>Test Power:</b>	<b>DC5V</b>
<b>Polarization:</b>	<b>Vertical</b>	<b>Test Result:</b>	<b>Pass</b>
<b>Test Time:</b>	<b>2019-05-03</b>	<b>Test By:</b>	<b>Lake</b>
<b>Standard:</b>	<b>FCC PART 15 C 1-26.5G PEAK</b>		
<b>Test Mode:</b>	<b>TX</b>		
<b>Note:</b>	<b>2442MHz</b>		

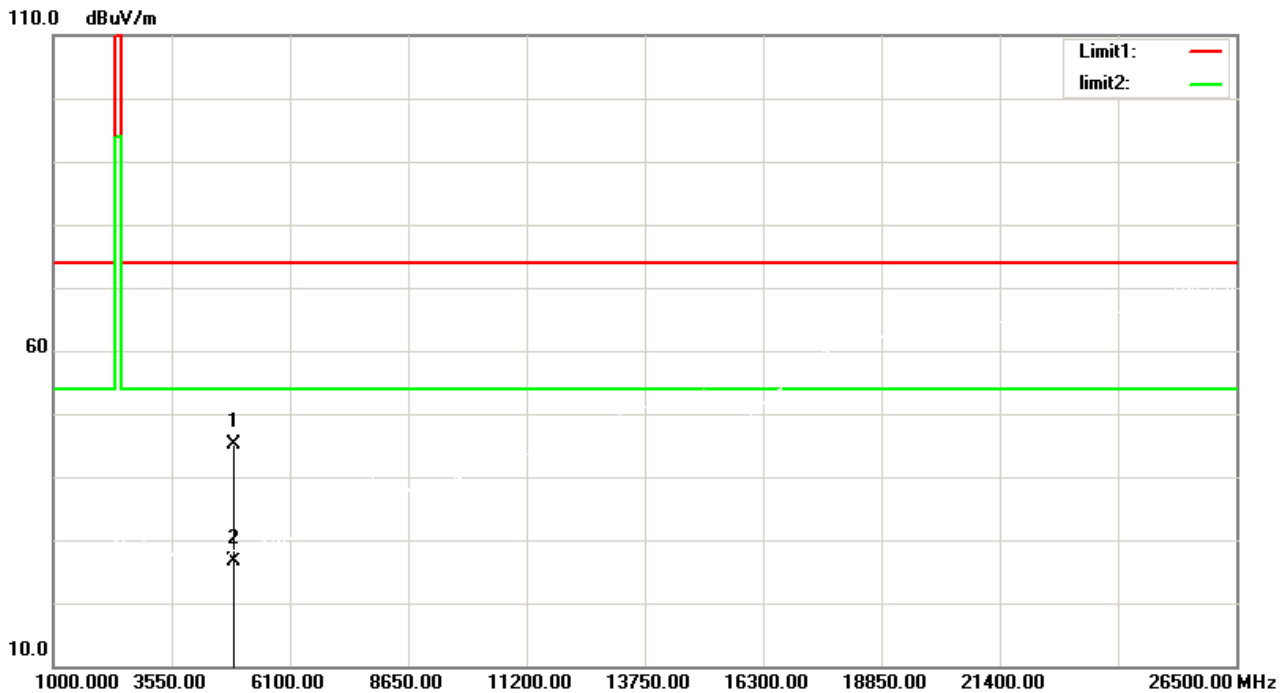

No.	Frequency (MHz)	Reading (dBuV/m)	Correct Factor(dB/m)	Result (dBuV/m)	Limit (dBuV/m)	Margin (dB)	Remark
1	4884.007	55.62	-10.41	45.21	74.00	-28.79	peak
2	4884.007	36.96	-10.41	26.55	54.00	-27.45	AVG

The test result is calculated as the following:

- (1) Result = Reading + Correct Factor
- (2) Correct Factor = Antenna Factor + Cable Loss – Amplifier Gain + Attenuator
- (3) Margin = Result - Limit

<b>EUT:</b>	<b>MARS IR STATION FOR XBOX ONE</b>	<b>Model No.:</b>	<b>048-116</b>
<b>Temperature:</b>	<b>24°C</b>	<b>Relative Humidity:</b>	<b>55%</b>
<b>Distance:</b>	<b>3m</b>	<b>Test Power:</b>	<b>DC5V</b>
<b>Polarization:</b>	<b>Horizontal</b>	<b>Test Result:</b>	<b>Pass</b>
<b>Test Time:</b>	<b>2019-05-03</b>	<b>Test By:</b>	<b>Lake</b>
<b>Standard:</b>	<b>FCC PART 15 C 1-26.5G PEAK</b>		
<b>Test Mode:</b>	<b>TX</b>		
<b>Note:</b>	<b>2442MHz</b>		

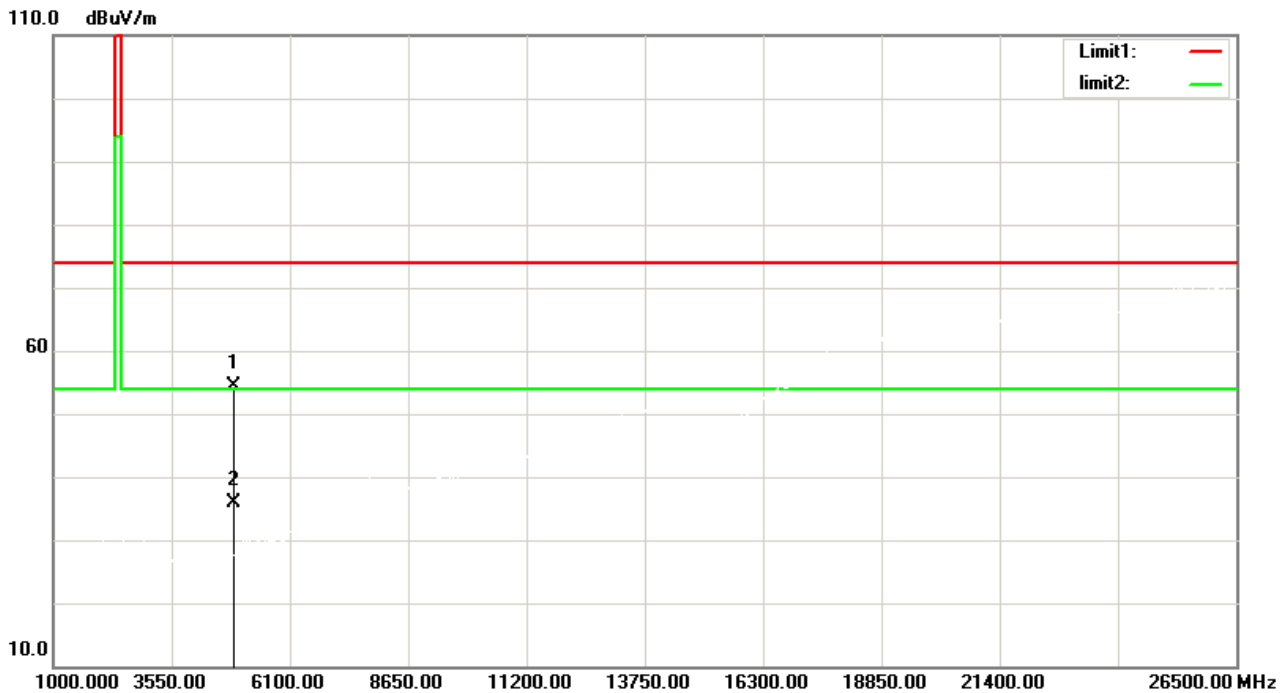

No.	Frequency (MHz)	Reading (dBuV/m)	Correct Factor(dB/m)	Result (dBuV/m)	Limit (dBuV/m)	Margin (dB)	Remark
1	4883.967	64.85	-10.41	54.44	74.00	-19.56	peak
2	4883.967	46.19	-10.41	35.78	54.00	-18.22	AVG

The test result is calculated as the following:

- (1) Result = Reading + Correct Factor
- (2) Correct Factor = Antenna Factor + Cable Loss – Amplifier Gain + Attenuator
- (3) Margin = Result - Limit

<b>EUT:</b>	<b>MARS IR STATION FOR XBOX ONE</b>	<b>Model No.:</b>	<b>048-116</b>
<b>Temperature:</b>	<b>24°C</b>	<b>Relative Humidity:</b>	<b>55%</b>
<b>Distance:</b>	<b>3m</b>	<b>Test Power:</b>	<b>DC5V</b>
<b>Polarization:</b>	<b>Vertical</b>	<b>Test Result:</b>	<b>Pass</b>
<b>Test Time:</b>	<b>2019-05-03</b>	<b>Test By:</b>	<b>Lake</b>
<b>Standard:</b>	<b>FCC PART 15 C 1-26.5G PEAK</b>		
<b>Test Mode:</b>	<b>TX</b>		
<b>Note:</b>	<b>2480MHz</b>		

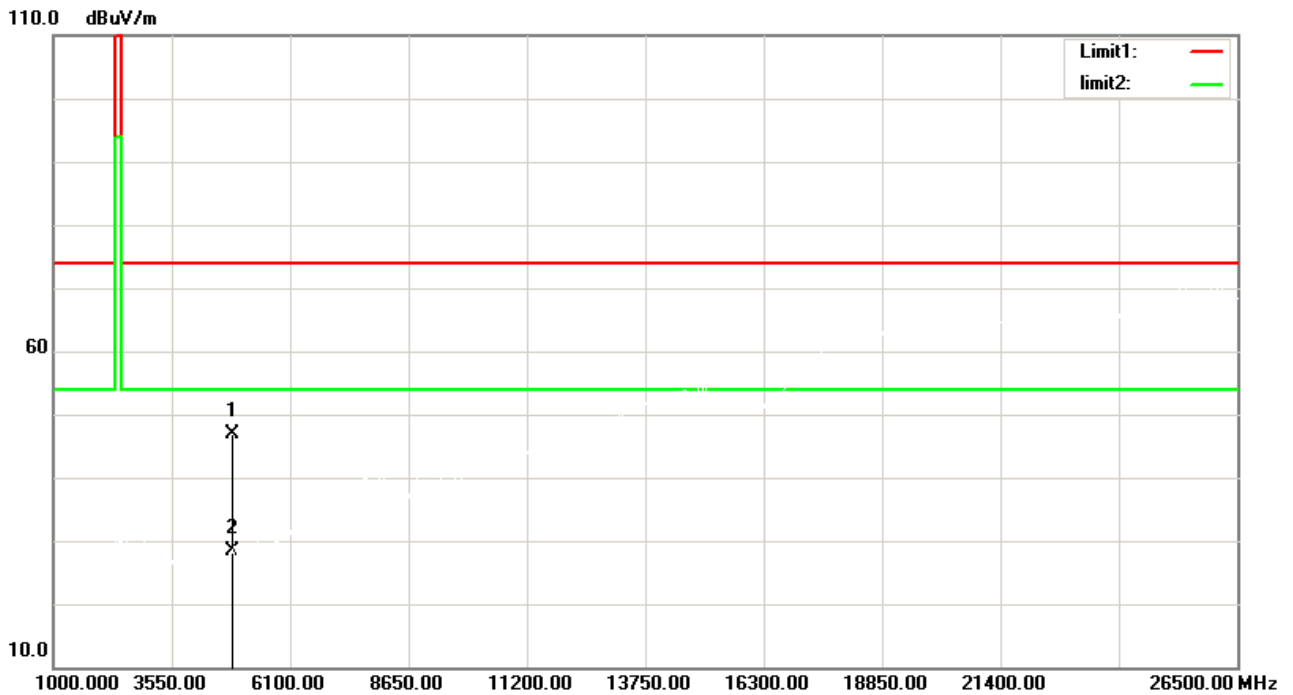

No.	Frequency (MHz)	Reading (dBuV/m)	Correct Factor(dB/m)	Result (dBuV/m)	Limit (dBuV/m)	Margin (dB)	Remark
1	4860.101	57.49	-10.53	46.96	74.00	-27.04	peak
2	4860.101	38.83	-10.53	28.30	54.00	-25.70	AVG

The test result is calculated as the following:

- (1) Result = Reading + Correct Factor
- (2) Correct Factor = Antenna Factor + Cable Loss – Amplifier Gain + Attenuator
- (3) Margin = Result - Limit

<b>EUT:</b>	<b>MARS IR STATION FOR XBOX ONE</b>	<b>Model No.:</b>	<b>048-116</b>
<b>Temperature:</b>	<b>24°C</b>	<b>Relative Humidity:</b>	<b>55%</b>
<b>Distance:</b>	<b>3m</b>	<b>Test Power:</b>	<b>DC5V</b>
<b>Polarization:</b>	<b>Horizontal</b>	<b>Test Result:</b>	<b>Pass</b>
<b>Test Time:</b>	<b>2019-05-03</b>	<b>Test By:</b>	<b>Lake</b>
<b>Standard:</b>	<b>FCC PART 15 C 1-26.5G PEAK</b>		
<b>Test Mode:</b>	<b>TX</b>		
<b>Note:</b>	<b>2480MHz</b>		

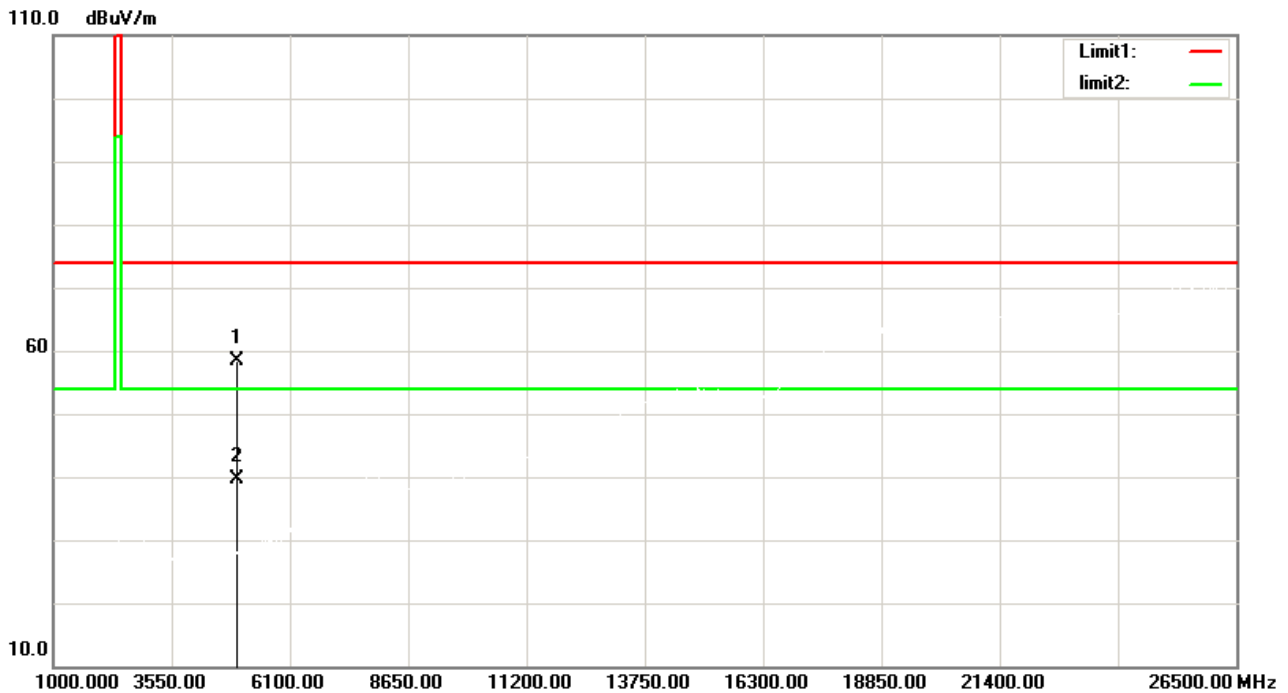

No.	Frequency (MHz)	Reading (dBuV/m)	Correct Factor(dB/m)	Result (dBuV/m)	Limit (dBuV/m)	Margin (dB)	Remark
1	4960.041	68.38	-10.08	58.30	74.00	-15.70	peak
2	4960.041	49.72	-10.08	39.64	54.00	-14.36	AVG

The test result is calculated as the following:

- (1) Result = Reading + Correct Factor
- (2) Correct Factor = Antenna Factor + Cable Loss – Amplifier Gain + Attenuator
- (3) Margin = Result - Limit

### Radiated band edge and Field Strength of Fundamental

EUT:	MARS IR STATION FOR XBOX ONE	Model No.:	048-116
Temperature:	24°C	Relative Humidity:	55%
Distance:	3m	Test Power:	DC5V
Polarization:	Vertical	Test Result:	Pass
Test Time:	2019-05-03	Test By:	Lake
Standard:	FCC PART 15 C 1-26.5G PEAK		
Test Mode:	TX		
Note:	2402MHz		

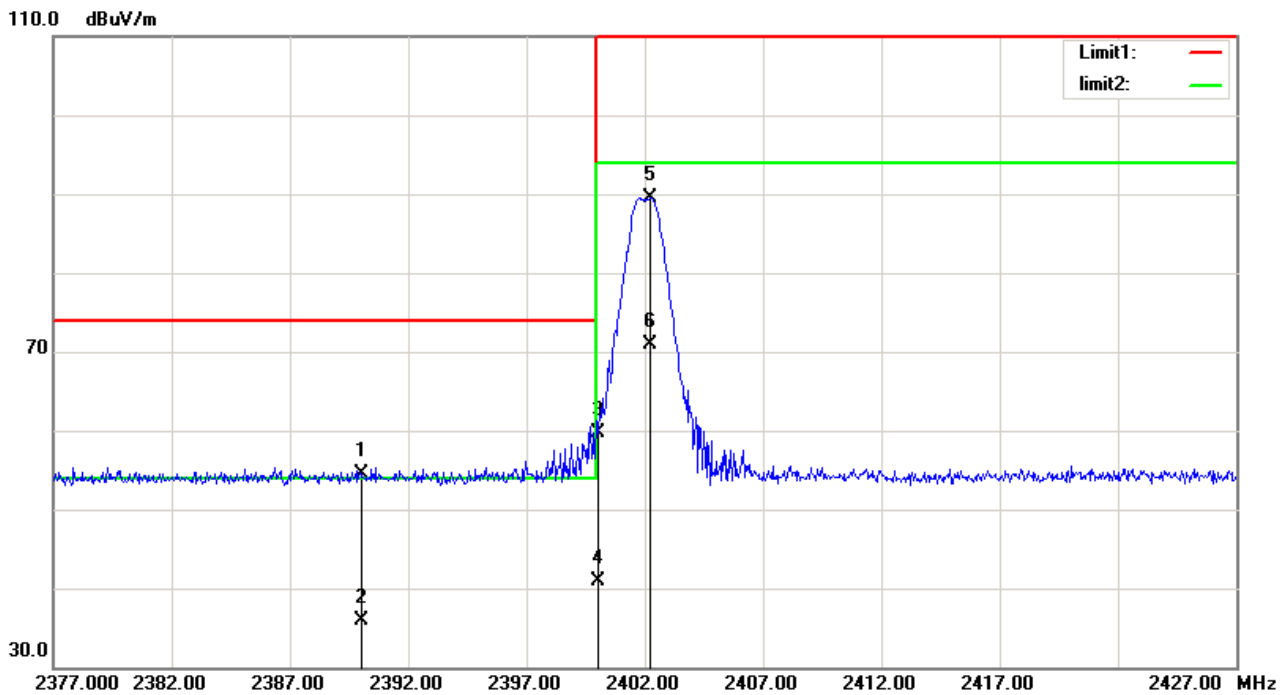

No.	Frequency (MHz)	Reading (dBuV/m)	Correct Factor (dB/m)	Result (dBuV/m)	Limit (dBuV/m)	Margin (dB)	Remark
1	2390.000	23.70	30.85	54.55	74.00	-19.45	peak
2	2390.000	5.04	30.85	35.89	54.00	-18.11	AVG
3	2400.000	28.76	30.87	59.63	74.00	-14.37	peak
4	2400.000	10.10	30.87	40.97	54.00	-13.03	AVG
5	2402.250	58.72	30.87	89.59	114.00	-24.41	peak
6	2402.250	40.06	30.87	70.93	94.00	-23.07	AVG

The test result is calculated as the following:

- (1) Result = Reading + Correct Factor
- (2) Correct Factor = Antenna Factor + Cable Loss – Amplifier Gain + Attenuator
- (3) Margin = Result - Limit



EUT:	MARS IR STATION FOR XBOX ONE	Model No.:	048-116
Temperature:	24°C	Relative Humidity:	55%
Distance:	3m	Test Power:	DC5V
Polarization:	Horizontal	Test Result:	Pass
Test Time:	2019-05-03	Test By:	Lake
Standard:	FCC PART 15 C 1-26.5G PEAK		
Test Mode:	TX		
Note:	2402MHz		

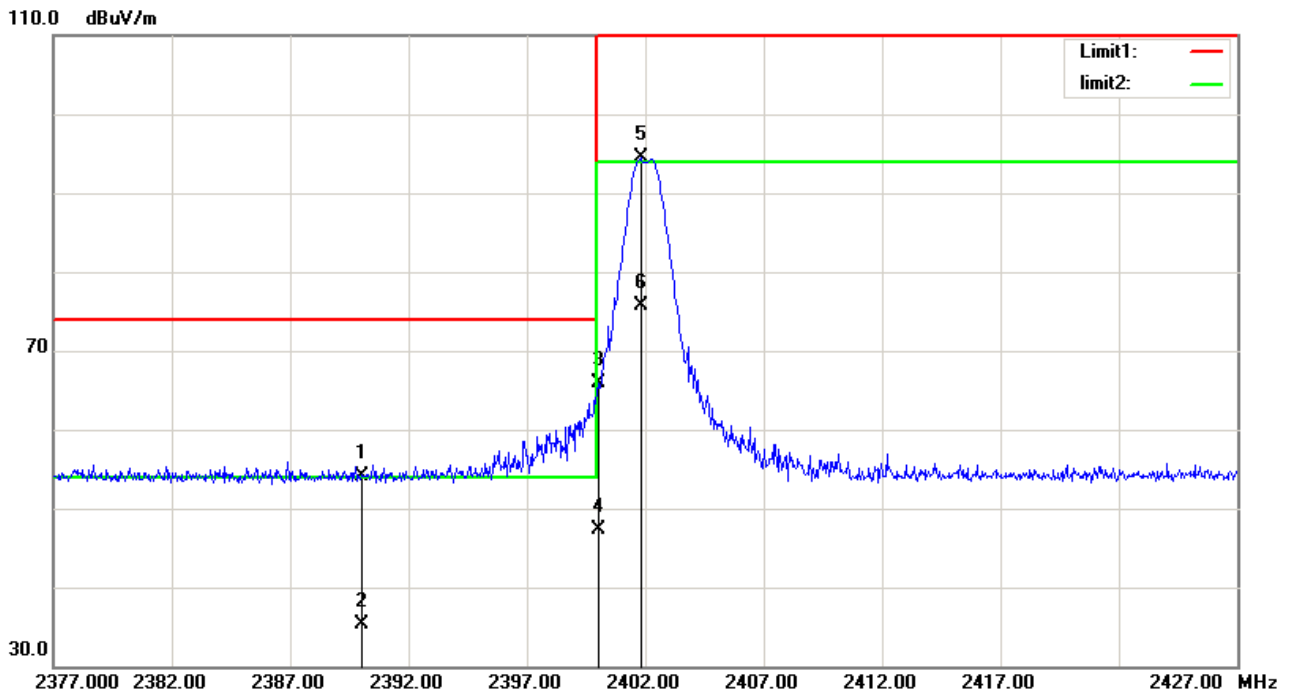

No.	Frequency (MHz)	Reading (dBuV/m)	Correct Factor (dB/m)	Result (dBuV/m)	Limit (dBuV/m)	Margin (dB)	Remark
1	2390.000	23.19	30.85	54.04	74.00	-19.96	peak
2	2390.000	4.53	30.85	35.38	54.00	-18.62	AVG
3	2400.000	35.10	30.87	65.97	74.00	-8.03	peak
4	2400.000	16.44	30.87	47.31	54.00	-6.69	AVG
5	2401.800	63.56	30.87	94.43	114.00	-19.57	peak
6	2401.800	44.90	30.87	75.77	94.00	-18.23	AVG

The test result is calculated as the following:

- (1) Result = Reading + Correct Factor
- (2) Correct Factor = Antenna Factor + Cable Loss – Amplifier Gain + Attenuator
- (3) Margin = Result - Limit

<b>EUT:</b>	<b>MARS IR STATION FOR XBOX ONE</b>	<b>Model No.:</b>	<b>048-116</b>
<b>Temperature:</b>	<b>24°C</b>	<b>Relative Humidity:</b>	<b>55%</b>
<b>Distance:</b>	<b>3m</b>	<b>Test Power:</b>	<b>DC5V</b>
<b>Polarization:</b>	<b>Vertical</b>	<b>Test Result:</b>	<b>Pass</b>
<b>Test Time:</b>	<b>2019-05-03</b>	<b>Test By:</b>	<b>Lake</b>
<b>Standard:</b>	<b>FCC PART 15 C 1-26.5G PEAK</b>		
<b>Test Mode:</b>	<b>TX</b>		
<b>Note:</b>	<b>2442MHz</b>		

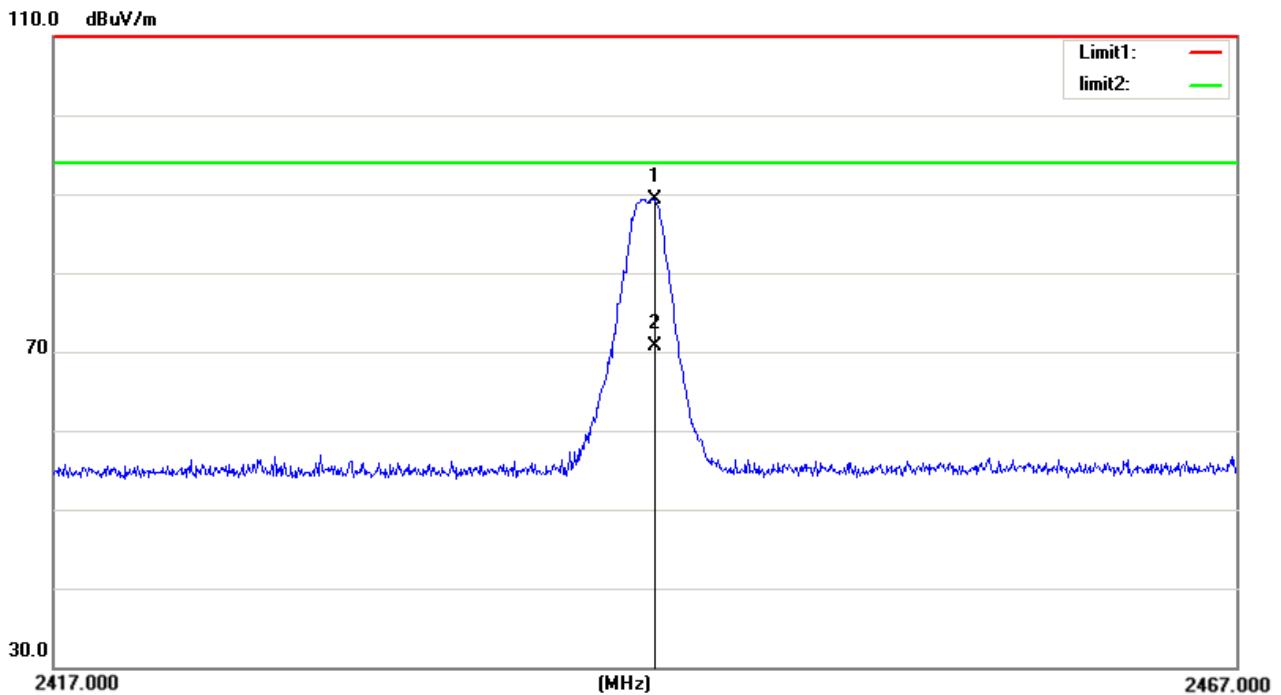

No.	Frequency (MHz)	Reading (dBuV/m)	Correct Factor(dB/m)	Result (dBuV/m)	Limit (dBuV/m)	Margin (dB)	Remark
1	2442.300	58.45	30.89	89.34	114.00	-24.66	peak
2	2442.300	39.79	30.89	70.68	94.00	-23.32	AVG

The test result is calculated as the following:

- (1) Result = Reading + Correct Factor
- (2) Correct Factor = Antenna Factor + Cable Loss – Amplifier Gain + Attenuator
- (3) Margin = Result - Limit

<b>EUT:</b>	<b>MARS IR STATION FOR XBOX ONE</b>	<b>Model No.:</b>	<b>048-116</b>
<b>Temperature:</b>	<b>24°C</b>	<b>Relative Humidity:</b>	<b>55%</b>
<b>Distance:</b>	<b>3m</b>	<b>Test Power:</b>	<b>DC5V</b>
<b>Polarization:</b>	<b>Horizontal</b>	<b>Test Result:</b>	<b>Pass</b>
<b>Test Time:</b>	<b>2019-05-03</b>	<b>Test By:</b>	<b>Lake</b>
<b>Standard:</b>	<b>FCC PART 15 C 1-26.5G PEAK</b>		
<b>Test Mode:</b>	<b>TX</b>		
<b>Note:</b>	<b>2442MHz</b>		

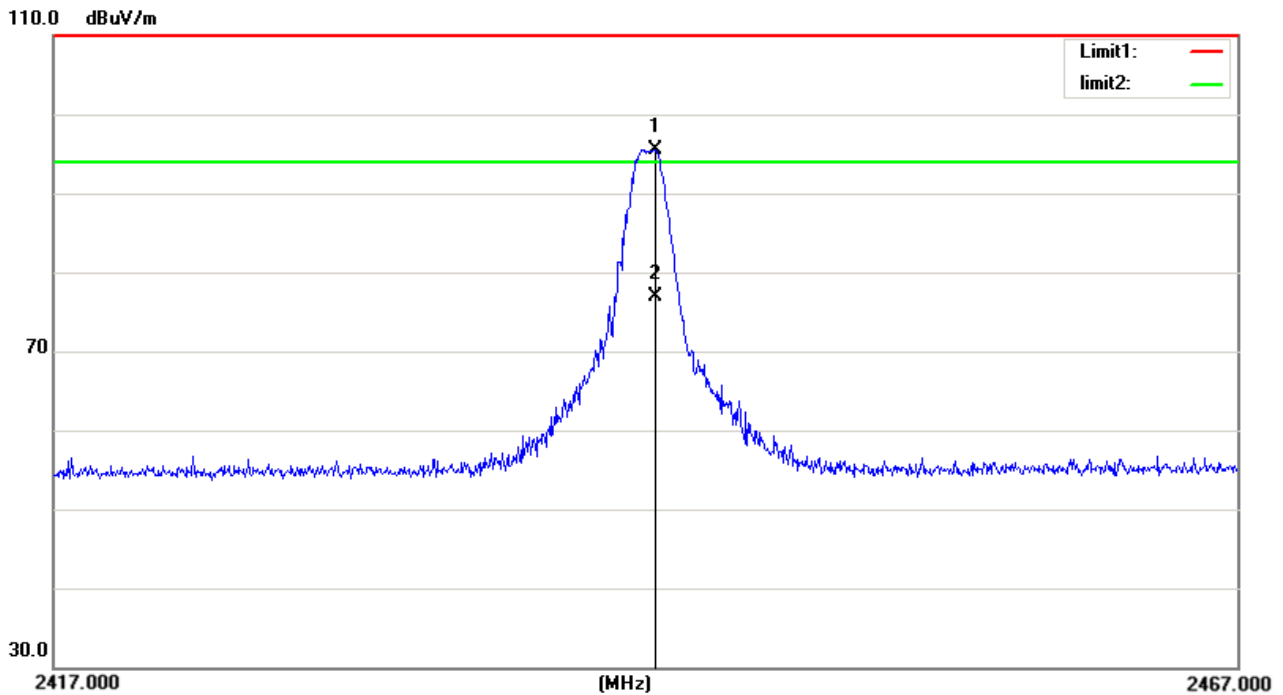

No.	Frequency (MHz)	Reading (dBuV/m)	Correct Factor(dB/m)	Result (dBuV/m)	Limit (dBuV/m)	Margin (dB)	Remark
1	2442.300	64.26	30.89	95.15	114.00	-18.85	peak
2	2442.300	46.01	30.89	76.90	94.00	-17.10	AVG

The test result is calculated as the following:

- (1) Result = Reading + Correct Factor
- (2) Correct Factor = Antenna Factor + Cable Loss – Amplifier Gain + Attenuator
- (3) Margin = Result - Limit

EUT:	MARS IR STATION FOR XBOX ONE	Model No.:	048-116
Temperature:	24°C	Relative Humidity:	55%
Distance:	3m	Test Power:	DC5V
Polarization:	Vertical	Test Result:	Pass
Test Time:	2019-05-03	Test By:	Lake
Standard:	FCC PART 15 C 1-26.5G PEAK		
Test Mode:	TX		
Note:	2480MHz		

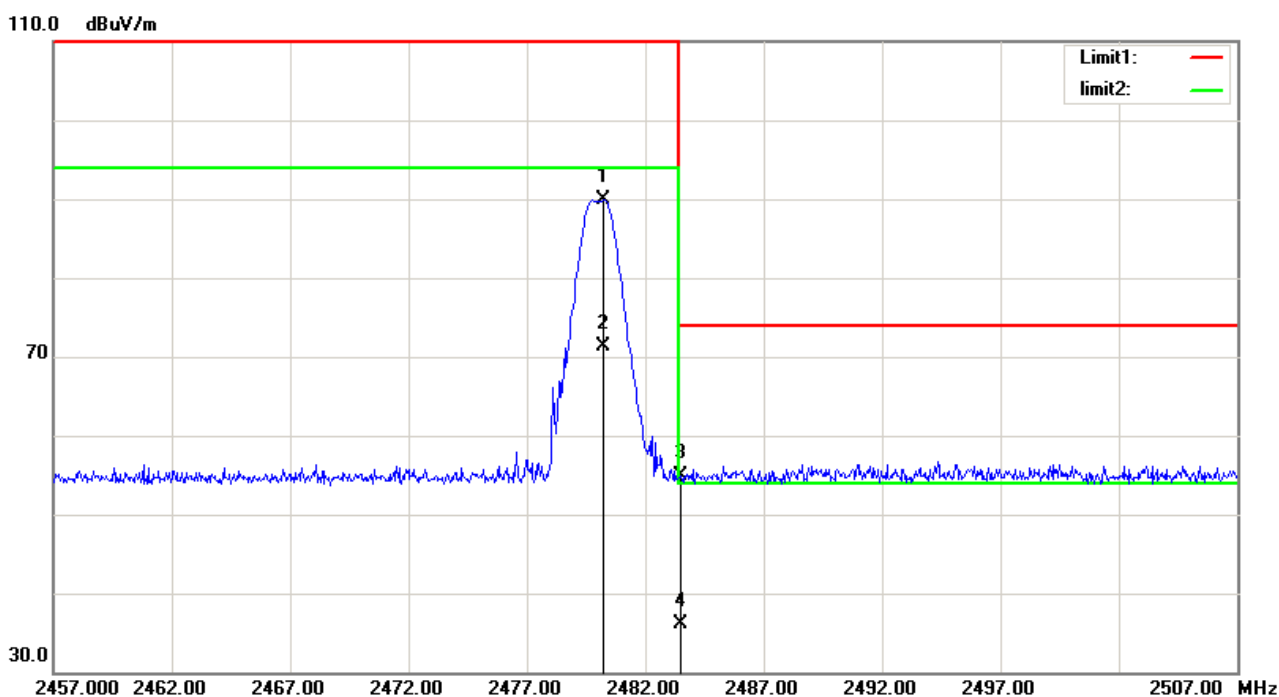

No.	Frequency (MHz)	Reading (dBuV/m)	Correct Factor(dB/m)	Result (dBuV/m)	Limit (dBuV/m)	Margin (dB)	Remark
1	2480.250	58.85	31.06	89.91	114.00	-24.09	peak
2	2480.250	40.19	31.06	71.25	94.00	-22.75	AVG
3	2483.500	23.74	31.07	54.81	74.00	-19.19	peak
4	2483.500	5.08	31.07	36.15	54.00	-17.85	AVG

The test result is calculated as the following:

- (1) Result = Reading + Correct Factor
- (2) Correct Factor = Antenna Factor + Cable Loss – Amplifier Gain + Attenuator
- (3) Margin = Result - Limit

EUT:	MARS IR STATION FOR XBOX ONE	Model No.:	048-116
Temperature:	24°C	Relative Humidity:	55%
Distance:	3m	Test Power:	DC5V
Polarization:	Horizontal	Test Result:	Pass
Test Time:	2019-05-03	Test By:	Lake
Standard:	FCC PART 15 C 1-26.5G PEAK		
Test Mode:	TX		
Note:	2480MHz		

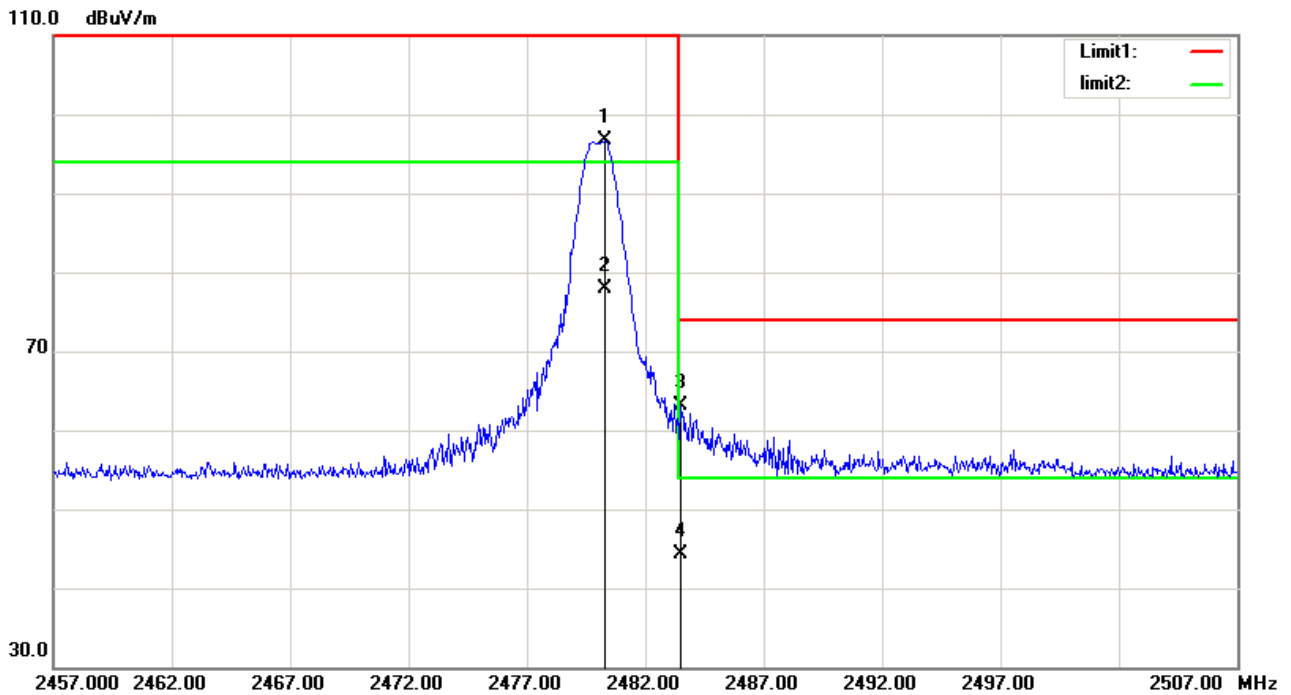

No.	Frequency (MHz)	Reading (dBuV/m)	Correct Factor(dB/m)	Result (dBuV/m)	Limit (dBuV/m)	Margin (dB)	Remark
1	2480.300	65.56	31.06	96.62	114.00	-17.38	peak
2	2480.300	46.90	31.06	77.96	94.00	-16.04	AVG
3	2483.500	31.99	31.07	63.06	74.00	-10.94	peak
4	2483.500	13.33	31.07	44.40	54.00	-9.60	AVG

The test result is calculated as the following:

- (1) Result = Reading + Correct Factor
- (2) Correct Factor = Antenna Factor + Cable Loss – Amplifier Gain + Attenuator
- (3) Margin = Result - Limit

## 5 POWER LINE CONDUCTED EMISSION

### 5.1 Test equipment

Item	Kind of Equipment	Manufacturer	Type No.	Serial No.	Calibrated until
1	Pulse Limiter	MTS-systemtechnik	MTS-IMP-136	261115-010-0024	12/16/2019
2	EMI Test Receiver	R&S	ESCI	101308	12/16/2019
3	LISN	AFJ	LS16	16011103219	06/09/2020
4	LISN	Schwarzbeck	NSLK 8127	8127-432	12/16/2019
5	Measurement Software	Farad	EZ-EMC (Ver.ATT-03A)	N/A	N/A

### 5.2 Block diagram of test setup

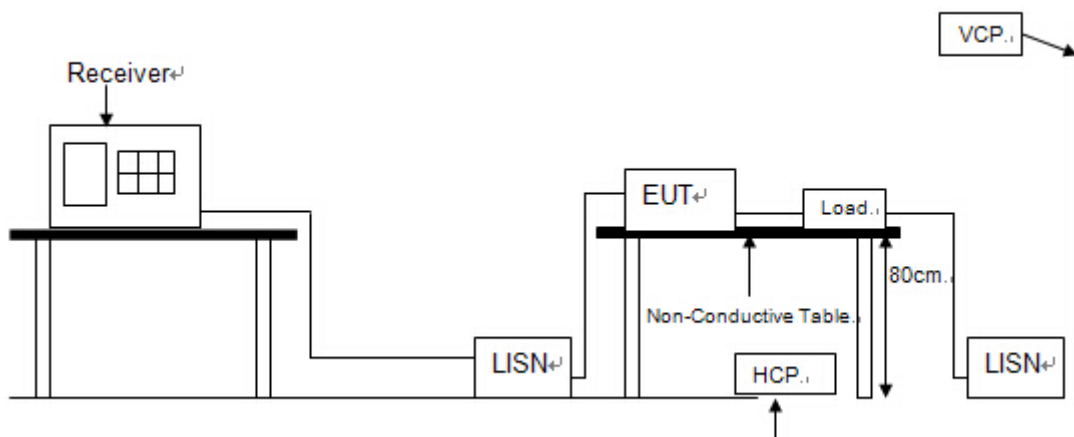

### 5.3 Power Line Conducted Emission Limits(Class B)

Frequency	Quasi-Peak Level dB( $\mu$ V)	Average Level dB( $\mu$ V)
150kHz ~ 500kHz	66 ~ 56*	56 ~ 46*
500kHz ~ 5MHz	56	46
5MHz ~ 30MHz	60	50

Note 1: \* Decreasing linearly with logarithm of frequency.

Note 2: The lower limit shall apply at the transition frequencies.

## 5.4 Test Procedure

The EUT and Support equipment, if needed, were put placed on a non-metallic table, 80cm above the ground plane.

Configuration EUT to simulate typical usage as described in clause 2.4 and test equipment as described in clause 10.2 of this report.

All I/O cables were positioned to simulate typical actual usage as per ANSI C63.4.

All support equipment power received from a second LISN.

Emissions were measured on each current carrying line of the EUT using an EMI Test Receiver connected to the LISN powering the EUT.

The Receiver scanned from 150 kHz to 30MHz for emissions in each of the test modes.

During the above scans, the emissions were maximized by cable manipulation.

The test mode(s) described in clause 2.4 were scanned during the preliminary test.

After the preliminary scan, we found the test mode producing the highest emission level.

The EUT configuration and worse cable configuration of the above highest emission levels were recorded for reference of the final test.

EUT and support equipment were set up on the test bench as per the configuration with highest emission level in the preliminary test.

A scan was taken on both power lines, Neutral and Line, recording at least the six highest emissions.

Emission frequency and amplitude were recorded into a computer in which correction factors were used to calculate the emission level and compare reading to the applicable limit.

The test data of the worst-case condition(s) was recorded.

The bandwidth of test receiver is set at 9 KHz.

## 5.5 Test Result

PASS. (See below detailed test result)

Note1: All emissions not reported below are too low against the prescribed limits.

Note2: “----” means peak detection; “-----” mans average detection

<b>EUT:</b>	<b>MARS IR STATION FOR XBOX ONE</b>	<b>Model No.:</b>	<b>048-116</b>
<b>Temperature:</b>	<b>24°C</b>	<b>Relative Humidity:</b>	<b>55%</b>
<b>Probe:</b>	<b>N</b>	<b>Test Power:</b>	<b>DC5V</b>
<b>Test Time:</b>	<b>2019-04-30</b>	<b>Test Result:</b>	<b>Pass</b>
<b>Standard:</b>	<b>(CE)FCC PART 15 class B_QP</b>	<b>Test By:</b>	<b>Lake</b>
<b>Test Mode:</b>	<b>TX</b>		
<b>Note:</b>	<b>2402MHz</b>		

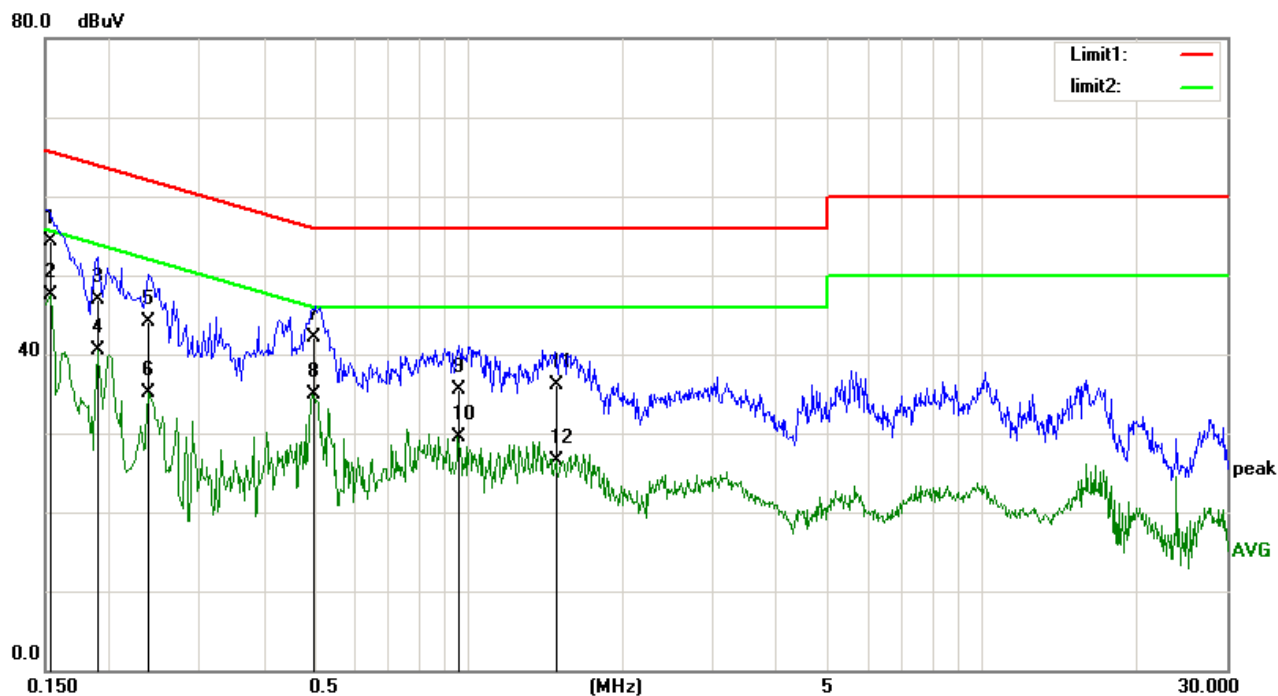

No.	Frequency (MHz)	Reading (dBuV)	Correct Factor(dB)	Result (dBuV)	Limit (dBuV)	Margin (dB)	Remark
1	0.1532	42.79	11.45	54.24	65.82	-11.58	QP
2	0.1532	36.00	11.45	47.45	55.82	-8.37	AVG
3	0.1900	35.74	11.19	46.93	64.03	-17.10	QP
4	0.1900	29.34	11.19	40.53	54.03	-13.50	AVG
5	0.2380	33.21	10.86	44.07	62.16	-18.09	QP
6	0.2380	24.29	10.86	35.15	52.16	-17.01	AVG
7	0.4980	31.87	10.18	42.05	56.03	-13.98	QP
8	0.4980	24.70	10.18	34.88	46.03	-11.15	AVG
9	0.9580	25.37	10.09	35.46	56.00	-20.54	QP
10	0.9580	19.41	10.09	29.50	46.00	-16.50	AVG
11	1.4860	26.08	10.10	36.18	56.00	-19.82	QP
12	1.4860	16.45	10.10	26.55	46.00	-19.45	AVG

The test result is calculated as the following:

- (1) Result = Reading + Correct Factor
- (2) Correct Factor = (LISN, ISN, PLC or Current Probe) Factor + Cable Loss +Attenuator
- (3) Margin = Result - Limit



<b>EUT:</b>	<b>MARS IR STATION FOR XBOX ONE</b>	<b>Model No.:</b>	<b>048-116</b>
<b>Temperature:</b>	<b>24°C</b>	<b>Relative Humidity:</b>	<b>55%</b>
<b>Probe:</b>	<b>L1</b>	<b>Test Power:</b>	<b>DC5V</b>
<b>Test Time:</b>	<b>2019-04-30</b>	<b>Test Result:</b>	<b>Pass</b>
<b>Standard:</b>	<b>(CE)FCC PART 15 class B_QP</b>	<b>Test By:</b>	<b>Lake</b>
<b>Test Mode:</b>	<b>TX</b>		
<b>Note:</b>	<b>2402MHz</b>		

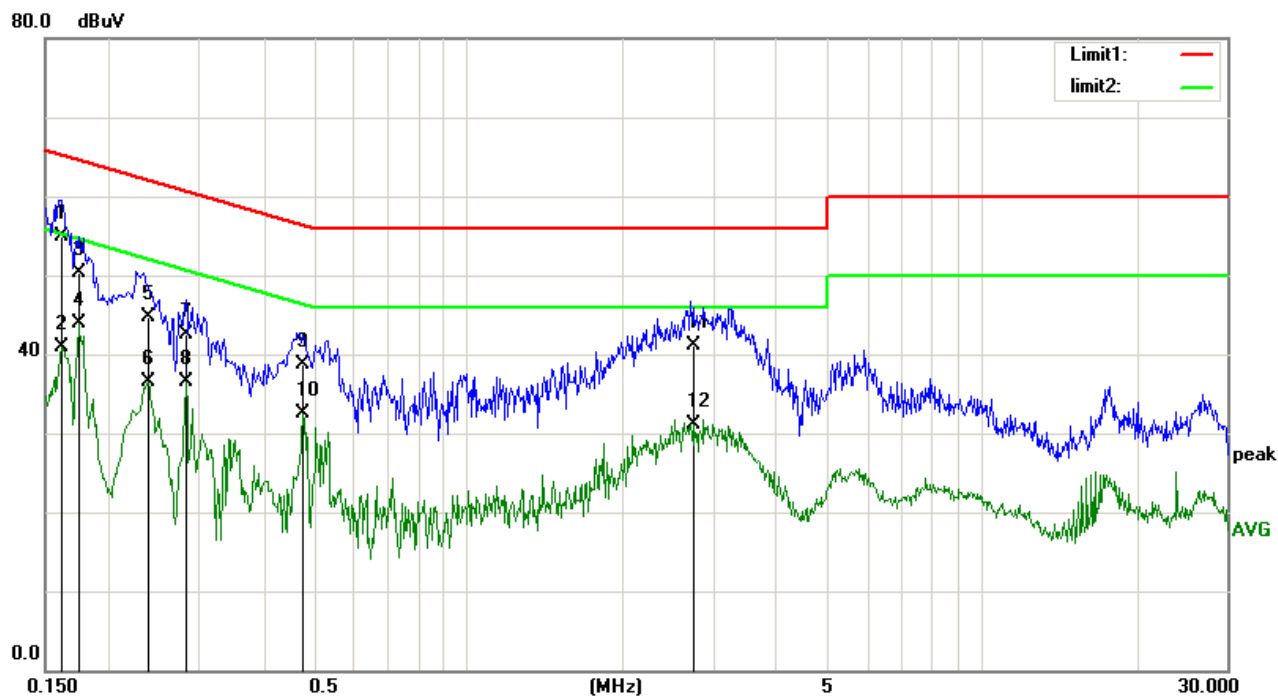

No.	Frequency (MHz)	Reading (dBuV)	Correct Factor(dB)	Result (dBuV)	Limit (dBuV)	Margin (dB)	Remark
1	0.1620	43.59	11.39	54.98	65.36	-10.38	QP
2	0.1620	29.49	11.39	40.88	55.36	-14.48	AVG
3	0.1737	39.00	11.31	50.31	64.78	-14.47	QP
4	0.1737	32.61	11.31	43.92	54.78	-10.86	AVG
5	0.2379	33.85	10.87	44.72	62.17	-17.45	QP
6	0.2379	25.54	10.87	36.41	52.17	-15.76	AVG
7	0.2818	31.97	10.56	42.53	60.76	-18.23	QP
8	0.2818	25.93	10.56	36.49	50.76	-14.27	AVG
9	0.4778	28.48	10.21	38.69	56.38	-17.69	QP
10	0.4778	22.28	10.21	32.49	46.38	-13.89	AVG
11	2.7580	31.01	10.13	41.14	56.00	-14.86	QP
12	2.7580	20.89	10.13	31.02	46.00	-14.98	AVG

The test result is calculated as the following:

- (1) Result = Reading + Correct Factor
- (2) Correct Factor = (LISN, ISN, PLC or Current Probe) Factor + Cable Loss + Attenuator
- (3) Margin = Result - Limit

## 6 Frequency Stability

### 6.1. Test equipment

Item	Equipment	Manufacturer	Model No.	Serial No.	Calibrated until	Calibrated Date
1	Spectrum analyzer	KEYSIGHT	N9010A	MY55150427	05/27/2020	05/28/2019
2	Attenuator	Mini-Circuits	BW-S10W2	101109	12/16/2019	12/17/2018
3	RF Cable	Micable	C10-01-01-1	100309	12/16/2019	12/17/2018
4	Temperature conditioning	Guan Jian.HTH1000	-20-130℃	GJ1000-10D001	12/16/2019	12/17/2018
5	DC Power Supply	G.KE	IPR-10010D	010931954	12/16/2019	12/17/2018

### 6.2. Block diagram of test setup

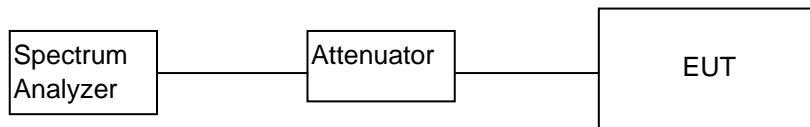

### 6.3 Test Result

GFSK

Temperature vs. Frequency Stability		
Voltage	Temperature	Measurement Frequency (MHz)
5.0V	(°C)	<b>2402</b>
	-20	2401.974
	20	2402.039
	50	2402.041
4.2V	20	2401.980
	Max. Deviation (MHz)	<b>2402.041</b>
	Max. Deviation (ppm)	<b>17.07</b>

Voltage	Temperature	Measurement Frequency (MHz)
5.0V	(°C)	<b>2442</b>
	-20	2441.984
	20	2441.977
	50	2441.989
4.2V	20	2442.035
	Max. Deviation (MHz)	<b>2442.035</b>
	Max. Deviation (ppm)	<b>14.33</b>

Voltage	Temperature	Measurement Frequency (MHz)
5.0V	(°C)	<b>2480</b>
	-20	2479.974
	20	2479.982
	50	2479.976
4.2V	20	2480.033
	Max. Deviation (MHz)	<b>2480.033</b>
	Max. Deviation (ppm)	<b>13.31</b>

Note: 4.2V is the end point voltage, and products below 4.2V will cease working

**END OF REPORT**