

FCC Test Report

Product Name	Afterglow Anka_AG7 wireless Headset for XB1
Model No	048-032R
FCC ID.	X5B-048-032R

Applicant	Performance Designed Products, LLC
Address	14144 Ventura Blvd., Suite 200 Sherman Oaks, CA91423 USA

Date of Receipt	Apr. 17, 2015
Issue Date	June. 01, 2015
Report No.	1540390R-RFUSP25V00
Report Version	V1.0



The test results relate only to the samples tested.
 The test results shown in the test report are traceable to the national/international standard through the calibration report of the equipment and evaluated measurement uncertainty herein.
 This report must not be used to claim product endorsement by TAF or any agency of the government.
 The test report shall not be reproduced without the written approval of Quietek Corporation.

Test Report

Issue Date: June. 01, 2015

Report No.: 1540390R-RFUSP25V00



Product Name	Afterglow Anka_AG7 wireless Headset for XB1
Applicant	Performance Designed Products, LLC
Address	14144 Ventura Blvd., Suite 200 Sherman Oaks, CA91423 USA
Manufacturer	Performance Designed Products, LLC
Model No.	048-032R
EUT Rated Voltage	DC 3.7V (Power by Battery)
EUT Test Voltage	AC 120V/60Hz
Trade Name	pdp, Afterglow
Applicable Standard	FCC CFR Title 47 Part 15 Subpart C: 2014 ANSI C63.4: 2009, ANSI C63.10: 2009 KDB 558074 D01 DTS Meas Guidance v03r02
Test Result	Complied

Documented By : Leven Huang
(Senior Adm. Specialist / Leven Huang)

Tested By : Eason chen
(Engineer /Eason Chen)

Approved By : [Signature]
(Director / Vincent Lin)

TABLE OF CONTENTS

Description	Page
1. GENERAL INFORMATION	5
1.1. EUT Description.....	5
1.2. Operational Description	7
1.3. Tested System Details.....	8
1.4. Configuration of Tested System	8
1.5. EUT Exercise Software	8
1.6. Test Facility	9
2. Conducted Emission.....	10
2.1. Test Equipment.....	10
2.2. Test Setup	10
2.3. Limits	11
2.4. Test Procedure	11
2.5. Uncertainty	11
2.6. Test Result of Conducted Emission.....	12
3. Peak Power Output	14
3.1. Test Equipment.....	14
3.2. Test Setup	14
3.3. Limit	14
3.4. Test Procedure	14
3.5. Uncertainty	14
3.6. Test Result of Peak Power Output.....	15
4. Radiated Emission.....	16
4.1. Test Equipment.....	16
4.2. Test Setup	16
4.3. Limits	17
4.4. Test Procedure	18
4.5. Uncertainty	18
4.6. Test Result of Radiated Emission.....	19
5. RF Antenna Conducted Test.....	23
5.1. Test Equipment.....	23
5.2. Test Setup	23
5.3. Limits	23
5.4. Test Procedure	23
5.5. Uncertainty	23
5.6. Test Result of RF antenna conducted test.....	24
6. Band Edge	27
6.1. Test Equipment.....	27
6.2. Test Setup	28
6.3. Limit	29
6.4. Test Procedure	29
6.5. Uncertainty	29
6.6. Test Result of Band Edge	30

7. Occupied Bandwidth34

7.1. Test Equipment 34

7.2. Test Setup 34

7.3. Limits 34

7.4. Test Procedure 34

7.5. Uncertainty 34

7.6. Test Result of Occupied Bandwidth 35

8. Power Density38

8.1. Test Equipment 38

8.2. Test Setup 38

8.3. Limits 38

8.4. Test Procedure 38

8.5. Uncertainty 38

8.6. Test Result of Power Density 39

9. EMI Reduction Method During Compliance Testing42

Attachment 1: EUT Test Photographs

Attachment 2: EUT Detailed Photographs

1. GENERAL INFORMATION

1.1. EUT Description

Product Name	Afterglow Anka_AG7 wireless Headset for XB1
Trade Name	pdp, Afterglow
Model No.	048-032R
FCC ID.	X5B-048-032R
Frequency Range	2403.35 – 2479.35MHz
Channel Control	Auto
Channel Separation	2MHz
Antenna Gain	Refer to the table “Antenna List”
Channel Number	39
Type of Modulation	Pi/4 DQPSK
Antenna Type	Printed on PCB
Audio Cable	Non-Shielded, 1.2m
Micro USB Cable	Non-Shielded, 1.8m

Antenna List

No.	Manufacturer	Part No.	Peak Gain
1	TATUNG	N/A (TX0) N/A (TX1)	1.09dBi for 2.4 GHz

Note: The antenna of EUT is conform to FCC 15.203

Center Frequency of Each Channel:

Channel	Frequency	Channel	Frequency	Channel	Frequency	Channel	Frequency
Channel 1:	2403.35 MHz	Channel 11:	2423.35 MHz	Channel 21:	2443.35 MHz	Channel 31:	2463.35 MHz
Channel 2:	2405.35 MHz	Channel 12:	2425.35 MHz	Channel 22:	2445.35 MHz	Channel 32:	2465.35 MHz
Channel 3:	2407.35 MHz	Channel 13:	2427.35 MHz	Channel 23:	2447.35 MHz	Channel 33:	2467.35 MHz
Channel 4:	2409.35 MHz	Channel 14:	2429.35 MHz	Channel 24:	2449.35 MHz	Channel 34:	2469.35 MHz
Channel 5:	2411.35 MHz	Channel 15:	2431.35 MHz	Channel 25:	2451.35 MHz	Channel 35:	2471.35 MHz
Channel 6:	2413.35 MHz	Channel 16:	2433.35 MHz	Channel 26:	2453.35 MHz	Channel 36:	2473.35 MHz
Channel 7:	2415.35 MHz	Channel 17:	2435.35 MHz	Channel 27:	2455.35 MHz	Channel 37:	2475.35 MHz
Channel 8:	2417.35 MHz	Channel 18:	2437.35 MHz	Channel 28:	2457.35 MHz	Channel 38:	2477.35 MHz
Channel 9:	2419.35 MHz	Channel 19:	2439.35 MHz	Channel 29:	2459.35 MHz	Channel 39:	2479.35 MHz
Channel 10:	2421.35 MHz	Channel 20:	2441.35 MHz	Channel 30:	2461.35 MHz		

Note:

1. The EUT is an Afterglow Anka_AG7 wireless Headset for XB1 with a built-in 2.4GHz WLAN transceiver.
2. Device contains a diversity function, only worst case is shown in the report.
3. Regarding to the operation frequency, the lowest, middle and highest frequency are selected to perform the test.
4. The radiation measurements are performed in X, Y, Z axis positioning. Only the worst case is shown in the report.
5. The EUT is using two the same SISO antennas(Ant0&Ant1) and only the worst case(Ant0) is shown in the report.
6. These tests are conducted on a sample for the purpose of demonstrating compliance of 2.4GHz transmitter with Part 15 Subpart C Paragraph 15.247 of spread spectrum devices

Test Mode:	Mode 1: Transmit
------------	------------------

1.3. Tested System Details

The types for all equipment, plus descriptions of all cables used in the tested system (including inserted cards) are:

	Product	Manufacturer	Model No.	Serial No.	Power Cord
1	Notebook PC	DELL	PPT	N/A	Non-Shielded, 0.8m

Signal Cable Type	Signal cable Description
A Audio Cable	Non-Shielded, 1.2m
B Micro USB Cable	Non-Shielded, 1.8m

1.4. Configuration of Tested System

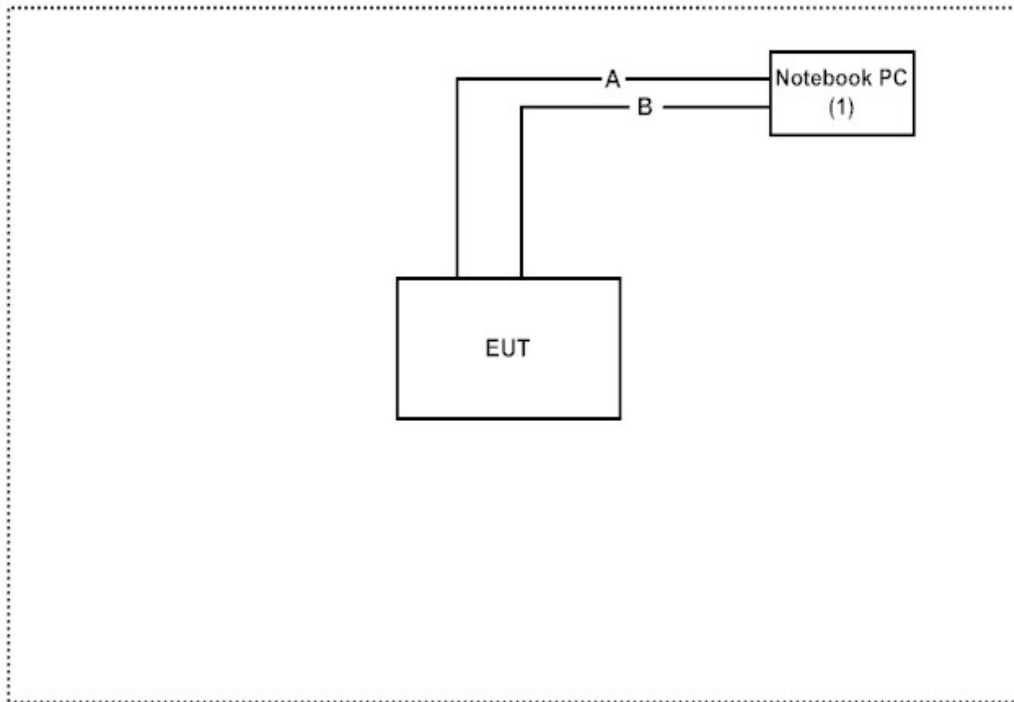

1.5. EUT Exercise Software

- (1) Setup the EUT as shown in Section 1.4.
- (2) Execute “VMI debug.exe (v1.1.6.47)” on the Notebook PC.
- (3) Configure the test mode, the test channel, and the data rate.
- (4) Press “OK” to start the continuous Transmit.
- (5) Verify that the EUT works properly.

1.6. Test Facility

Ambient conditions in the laboratory:

Items	Required (IEC 68-1)	Actual
Temperature (°C)	15-35	20-35
Humidity (%RH)	25-75	50-65
Barometric pressure (mbar)	860-1060	950-1000

The related certificate for our laboratories about the test site and management system can be downloaded from Quietek Corporation's Web Site: <http://www.quietek.com/chinese/about/certificates.aspx?bval=5>
 The address and introduction of Quietek Corporation's laboratories can be founded in our Web site: <http://www.quietek.com/>

Site Description: File on
 Federal Communications Commission
 FCC Engineering Laboratory
 7435 Oakland Mills Road
 Columbia, MD 21046
 Registration Number: 92195

Site Name: Quietek Corporation
 Site Address: No.5-22, Ruishukeng,
 Linkou Dist. New Taipei City 24451,
 Taiwan, R.O.C.
 TEL: 886-2-8601-3788 / FAX : 886-2-8601-3789
 E-Mail : service@quietek.com

FCC Accreditation Number: TW1014

2. Conducted Emission

2.1. Test Equipment

	Equipment	Manufacturer	Model No. / Serial No.	Last Cal.	Remark
X	Test Receiver	R & S	ESCS 30 / 825442/018	Sep., 2014	
X	Artificial Mains Network	R & S	ENV4200 / 848411/10	Feb., 2015	Peripherals
X	LISN	R & S	ESH3-Z5 / 825562/002	Feb., 2015	EUT
	DC LISN	Schwarzbeck	8226 / 176	Mar., 2015	EUT
X	Pulse Limiter	R & S	ESH3-Z2 / 357.8810.52	Feb., 2015	
	No.1 Shielded Room				

Note:

1. All equipments are calibrated every one year.
2. The test instruments marked by “X” are used to measure the final test results.

2.2. Test Setup

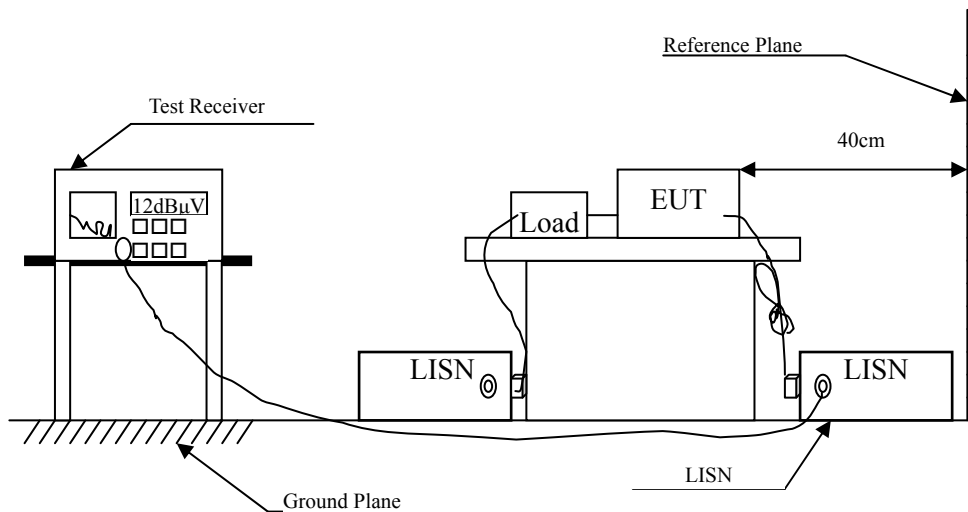

2.3. Limits

FCC Part 15 Subpart C Paragraph 15.207 (dBµV) Limit		
Frequency MHz	Limits	
	QP	AV
0.15 - 0.50	66-56	56-46
0.50-5.0	56	46
5.0 - 30	60	50

Remarks: In the above table, the tighter limit applies at the band edges.

2.4. Test Procedure

The EUT and Peripherals are connected to the main power through a line impedance stabilization network (L.I.S.N.). This provides a 50 ohm /50uH coupling impedance for the measuring equipment. The peripheral devices are also connected to the main power through a LISN that provides a 50ohm /50uH coupling impedance with 50ohm termination. (Please refer to the block diagram of the test setup and photographs.)

Both sides of A.C. line are checked for maximum conducted interference. In order to find the maximum emission, the relative positions of equipment and all the interface cables must be changed according to ANSI C63.4: 2009 on conducted measurement.

Conducted emissions were investigated over the frequency range from 0.15MHz to 30MHz using a receiver bandwidth of 9kHz.

The EUT was setup to ANSI C63.4: 2009; tested to FHSS test procedure of FCC Public Notice DA 00-705 for compliance to FCC 47CFR 15.247 requirements.

2.5. Uncertainty

± 2.26 dB

2.6. Test Result of Conducted Emission

Product : Afterglow Anka_AG7 wireless Headset for XB1
 Test Item : Conducted Emission Test
 Power Line : Line 1
 Test Mode : Mode 1: Transmit (2441.35MHz)

Frequency MHz	Correct Factor dB	Reading Level dBuV	Measurement Level dBuV	Margin dB	Limit dBuV
Line 1					
Quasi-Peak					
0.216	9.651	34.550	44.201	-19.913	64.114
0.287	9.655	28.630	38.285	-23.801	62.086
0.357	9.659	30.320	39.979	-20.107	60.086
0.498	9.667	25.560	35.227	-20.830	56.057
5.556	9.876	24.540	34.416	-25.584	60.000
14.463	10.071	22.570	32.641	-27.359	60.000
Average					
0.216	9.651	32.560	42.211	-11.903	54.114
0.287	9.655	24.640	34.295	-17.791	52.086
0.357	9.659	24.740	34.399	-15.687	50.086
0.498	9.667	23.890	33.557	-12.500	46.057
5.556	9.876	13.200	23.076	-26.924	50.000
14.463	10.071	15.980	26.051	-23.949	50.000

Note:

1. All Reading Levels are Quasi-Peak and average value.
2. "■" means the worst emission level.
3. Measurement Level = Reading Level + Correct Factor

Product : Afterglow Anka_AG7 wireless Headset for XB1
 Test Item : Conducted Emission Test
 Power Line : Line 2
 Test Mode : Mode 1: Transmit (2441.35MHz)

Frequency MHz	Correct Factor dB	Reading Level dBuV	Measurement Level dBuV	Margin dB	Limit dBuV
Line 2					
Quasi-Peak					
0.216	9.661	32.460	42.121	-21.993	64.114
0.283	9.664	25.740	35.404	-26.796	62.200
0.357	9.659	27.620	37.279	-22.807	60.086
0.576	9.671	15.420	25.091	-30.909	56.000
5.201	9.871	18.560	28.431	-31.569	60.000
14.318	10.090	21.740	31.830	-28.170	60.000
Average					
0.216	9.661	26.120	35.781	-18.333	54.114
0.283	9.664	23.140	32.804	-19.396	52.200
0.357	9.659	23.800	33.459	-16.627	50.086
0.576	9.671	9.740	19.411	-26.589	46.000
5.201	9.871	11.290	21.161	-28.839	50.000
14.318	10.090	20.000	30.090	-19.910	50.000

Note:

1. All Reading Levels are Quasi-Peak and average value.
2. "■" means the worst emission level.
3. Measurement Level = Reading Level + Correct Factor

3. Peak Power Output

3.1. Test Equipment

	Equipment	Manufacturer	Model No./Serial No.	Last Cal.
X	Power Meter	Anritsu	ML2495A/6K00003357	May, 2015
X	Power Sensor	Anritsu	MA2411B/0738448	Jun., 2015

Note: 1. All equipments are calibrated every one year.
2. The test instruments marked by “X” are used to measure the final test results.

3.2. Test Setup

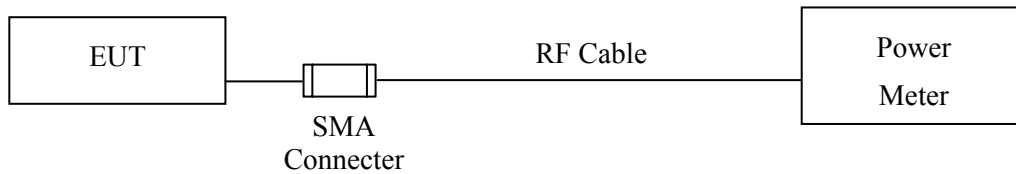

3.3. Limit

The maximum peak power shall be less 1Watt.

3.4. Test Procedure

Tested according to DTS test procedure of KDB 558074 for compliance to FCC 47CFR 15.247 requirements. The maximum peak conducted output power using KDB 558074 section 9.1.2 PKPM1 Peak power meter method.

3.5. Uncertainty

± 1.27 dB

3.6. Test Result of Peak Power Output

Product : Afterglow Anka_AG7 wireless Headset for XB1
 Test Item : Peak Power Output Data
 Test Site : No.3 OATS
 Test Mode : Mode 1: Transmit

Channel No.	Frequency (MHz)	Measurement Level (dBm)	Required Limit (dBm)	Result
01	2403.35	2.10	<30dBm	Pass
20	2441.35	2.09	<30dBm	Pass
39	2479.35	1.24	<30dBm	Pass

4. Radiated Emission

4.1. Test Equipment

The following test equipments are used during the radiated emission test:

Test Site	Equipment	Manufacturer	Model No./Serial No.	Last Cal.
☒ Site # 3	X Loop Antenna	Teseq	HLA6120 / 26739	Jul., 2014
	X Bilog Antenna	Schaffner Chase	CBL6112B/2673	Sep., 2014
	X Horn Antenna	Schwarzbeck	BBHA9120D/D305	Sep., 2014
	X Horn Antenna	Schwarzbeck	BBHA9170/208	Jul., 2014
	X Pre-Amplifier	Agilent	8447D/2944A09549	Sep., 2014
	X Spectrum Analyzer	Agilent	E4407B / US39440758	May, 2015
	X Test Receiver	R & S	ESCS 30/ 825442/018	Sep., 2014
	X Coaxial Cable	QuieTek	QTK-CABLE/ CAB5	Feb., 2015
	X Controller	QuieTek	QTK-CONTROLLER/ CTRL3	N/A
	X Coaxial Switch	Anritsu	MP59B/6200265729	N/A

- Note:
1. All equipments are calibrated every one year.
 2. The test instruments marked by "X" are used to measure the final test results.

4.2. Test Setup

Below 1GHz

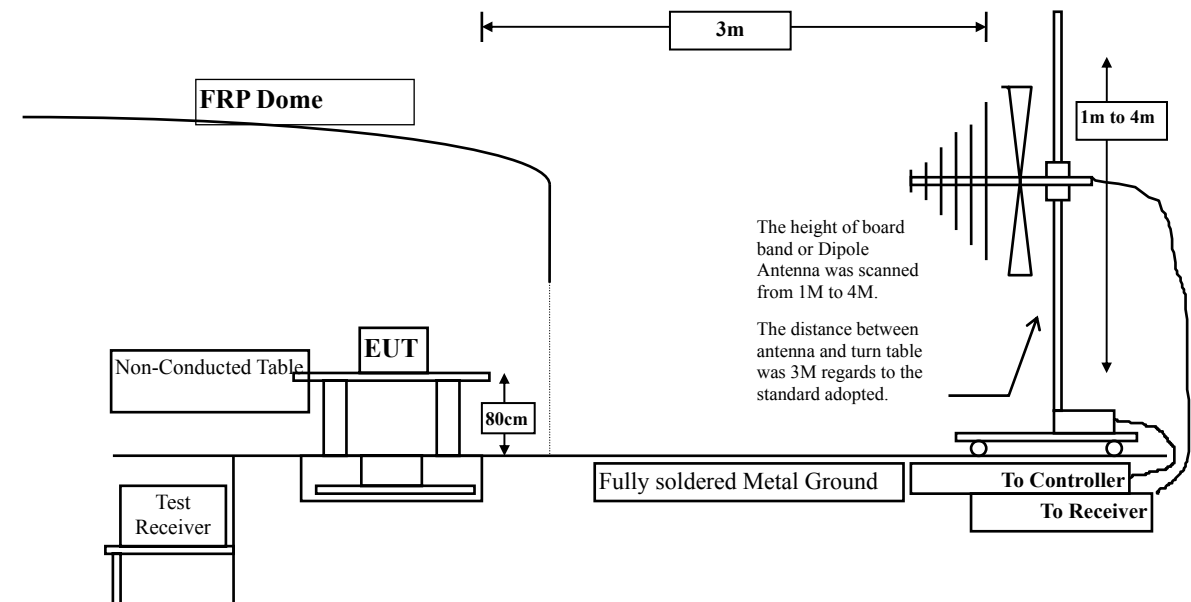

Above 1GHz

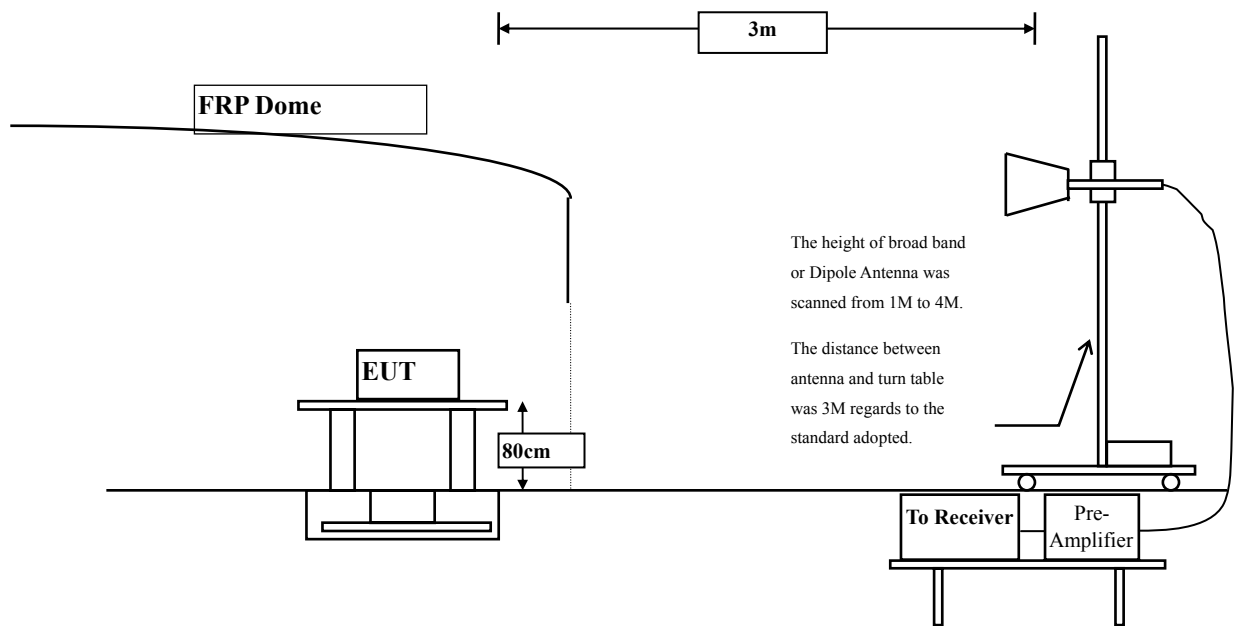

4.3. Limits

➤ General Radiated Emission Limits

Emissions radiated outside of the specified frequency bands, except for harmonics, shall be attenuated by at least 20dB below the level of the fundamental or to the general radiated emission limits in paragraph 15.209, whichever is the lesser attenuation.

FCC Part 15 Subpart C Paragraph 15.209 Limits		
Frequency MHz	Field strength (microvolts/meter)	Measurement distance (meter)
0.009-0.490	2400/F(kHz)	300
0.490-1.705	24000/F(kHz)	30
1.705-30	30	30
30-88	100	3
88-216	150	3
216-960	200	3
Above 960	500	3

- Remarks:
1. RF Voltage (dB μ V) = 20 log RF Voltage (uV)
 2. In the Above Table, the tighter limit applies at the band edges.
 3. Distance refers to the distance in meters between the measuring instrument antenna and the closed point of any part of the device or system.

4.4. Test Procedure

The EUT was setup according to ANSI C63.10: 2009 and tested according to DTS test procedure of KDB558074 for compliance to FCC 47CFR 15.247 requirements.

The EUT is placed on a turn table which is 0.8 meter above ground. The turn table is rotated 360 degrees to determine the position of the maximum emission level. The EUT was positioned such that the distance from antenna to the EUT was 3 meters.

The antenna is scanned between 1 meter and 4 meters to find out the maximum emission level. This is repeated for both horizontal and vertical polarization of the antenna. In order to find the maximum emission, all of the interface cables were manipulated according to ANSI C63.10: 2009 on radiated measurement.

The resolution bandwidth below 30MHz setting on the field strength meter is 9kHz and 30MHz~1GHz is 120kHz and above 1GHz is 1MHz.

Radiated emission measurements below 30MHz are made using Loop Antenna and 30MHz~1GHz are made using broadband Bilog antenna and above 1GHz are made using Horn Antennas.

The measurement is divided into the Preliminary Measurement and the Final Measurement.

The suspected frequencies are searched for in Preliminary Measurement with the measurement antenna kept pointed at the source of the emission both in azimuth and elevation, with the polarization of the antenna oriented for maximum response. The antenna is pointed at an angle towards the source of the emission, and the EUT is rotated in both height and polarization to maximize the measured emission. The emission is kept within the illumination area of the 3 dB bandwidth of the antenna.

The worst radiated emission is measured in the Open Area Test Site on the Final Measurement.

The measurement frequency range from 9kHz - 10th Harmonic of fundamental was investigated.

4.5. Uncertainty

± 3.9 dB above 1GHz

± 3.8 dB below 1GHz

4.6. Test Result of Radiated Emission

Product : Afterglow Anka_AG7 wireless Headset for XB1
 Test Item : Harmonic Radiated Emission Data
 Test Site : No.3 OATS
 Test Mode : Mode 1: Transmit (2403.35MHz)

Frequency MHz	Correct Factor dB	Reading Level dBuV	Measurement Level dBuV/m	Margin dB	Limit dBuV/m
Horizontal					
Peak Detector:					
4806.700	2.534	42.770	45.304	-28.696	74.000
7210.050	9.466	44.320	53.786	-20.214	74.000
9613.400	10.343	39.610	49.954	-24.046	74.000
Vertical					
Peak Detector:					
4806.700	2.934	41.900	44.834	-29.166	74.000
7210.050	9.946	42.030	51.977	-22.023	74.000
9613.400	10.808	39.700	50.508	-23.492	74.000

Note:

1. All Readings below 1GHz are Quasi-Peak, above 1GHz are performed with peak and/or average measurements as necessary.
2. Peak measurements: RBW = 1MHz, VBW = 3 MHz, Sweep: Auto.
3. Average measurements: RBW = 1MHz, VBW = 10 Hz, Sweep: Auto.
4. Measurement Level = Reading Level + Correct Factor.
5. Correct Factor = Antenna factor + Cable loss – Amplifier gain.
6. The average measurement was not performed when the peak measured data under the limit of average detection.
7. The emission levels of other frequencies are very lower than the limit and not show in test report.

Product : Afterglow Anka_AG7 wireless Headset for XB1
 Test Item : Harmonic Radiated Emission Data
 Test Site : No.3 OATS
 Test Mode : Mode 1: Transmit (2441.35MHz)

Frequency MHz	Correct Factor dB	Reading Level dBuV	Measurement Level dBuV/m	Margin dB	Limit dBuV/m
Horizontal					
Peak Detector:					
4882.700	2.021	45.030	47.051	-26.949	74.000
7324.050	9.783	47.870	57.653	-16.347	74.000
9765.400	9.687	38.810	48.497	-25.503	74.000
Average Detector:					
7324.050	9.783	39.510	49.293	-4.707	54.000
Vertical					
Peak Detector:					
4882.700	2.484	42.080	44.564	-29.436	74.000
7324.050	10.399	43.450	53.849	-20.151	74.000
9765.400	10.320	39.040	49.360	-24.640	74.000

Note:

1. All Readings below 1GHz are Quasi-Peak, above 1GHz are performed with peak and/or average measurements as necessary.
2. Peak measurements: RBW = 1MHz, VBW = 3 MHz, Sweep: Auto.
3. Average measurements: RBW = 1MHz, VBW = 10 Hz, Sweep: Auto.
4. Measurement Level = Reading Level + Correct Factor.
5. Correct Factor = Antenna factor + Cable loss – Amplifier gain.
6. The average measurement was not performed when the peak measured data under the limit of average detection.
7. The emission levels of other frequencies are very lower than the limit and not show in test report.

Product : Afterglow Anka_AG7 wireless Headset for XB1
 Test Item : Harmonic Radiated Emission Data
 Test Site : No.3 OATS
 Test Mode : Mode 1: Transmit (2479.35MHz)

Frequency MHz	Correct Factor dB	Reading Level dBuV	Measurement Level dBuV/m	Margin dB	Limit dBuV/m
Horizontal					
Peak Detector:					
4958.700	2.569	47.440	50.009	-23.991	74.000
7438.050	10.548	45.960	56.508	-17.492	74.000
9917.400	10.202	38.450	48.652	-25.348	74.000
Average Detector:					
7438.050	10.548	39.060	49.608	-4.392	54.000
Vertical					
Peak Detector:					
4958.700	3.378	43.190	46.569	-27.431	74.000
7438.050	11.216	42.760	53.976	-20.024	74.000
9917.400	11.244	39.140	50.384	-23.616	74.000

Note:

1. All Readings below 1GHz are Quasi-Peak, above 1GHz are performed with peak and/or average measurements as necessary.
2. Peak measurements: RBW = 1MHz, VBW = 3 MHz, Sweep: Auto.
3. Average measurements: RBW = 1MHz, VBW = 10 Hz, Sweep: Auto.
4. Measurement Level = Reading Level + Correct Factor.
5. Correct Factor = Antenna factor + Cable loss – Amplifier gain.
6. The average measurement was not performed when the peak measured data under the limit of average detection.
7. The emission levels of other frequencies are very lower than the limit and not show in test report.

Product : Afterglow Anka_AG7 wireless Headset for XB1
 Test Item : General Radiated Emission Data
 Test Site : No.3 OATS
 Test Mode : Mode 1: Transmit (2441.35MHz)

Frequency MHz	Correct Factor dB	Reading Level dBuV	Measurement Level dBuV/m	Margin dB	Limit dBuV/m
Horizontal					
193.930	-10.284	45.974	35.690	-7.810	43.500
258.920	-5.440	47.411	41.971	-4.029	46.000
454.860	1.754	36.664	38.417	-7.583	46.000
617.820	2.438	32.172	34.610	-11.390	46.000
746.830	3.911	34.674	38.585	-7.415	46.000
946.650	6.940	24.033	30.973	-15.027	46.000
Vertical					
194.900	-5.673	36.078	30.405	-13.095	43.500
291.900	-5.272	43.031	37.759	-8.241	46.000
380.170	0.962	34.005	34.967	-11.033	46.000
612.970	1.872	31.491	33.363	-12.637	46.000
714.820	-1.629	37.657	36.028	-9.972	46.000
808.910	3.193	30.516	33.709	-12.291	46.000

Note:

1. All Readings below 1GHz are Quasi-Peak, above 1GHz are performed with peak and/or average measurements as necessary.
2. Peak measurements: RBW = 1MHz, VBW = 3 MHz, Sweep: Auto.
3. Average measurements: RBW = 1MHz, VBW = 10 Hz, Sweep: Auto.
4. Measurement Level = Reading Level + Correct Factor.
5. Correct Factor = Antenna factor + Cable loss – Amplifier gain.
6. The average measurement was not performed when the peak measured data under the limit of average detection.
7. The emission levels of other frequencies are very lower than the limit and not show in test report.
8. No emission found between lowest internal used/generated frequency to 30MHz.

5. RF Antenna Conducted Test

5.1. Test Equipment

	Equipment	Manufacturer	Model No./Serial No.	Last Cal.
	Spectrum Analyzer	R&S	FSP40 / 100170	Jun., 2015
	Spectrum Analyzer	Agilent	E4407B / US39440758	Jun., 2015
X	Spectrum Analyzer	Agilent	N9010A / MY48030495	Apr., 2015

Note: 1. All equipments are calibrated every one year.
2. The test instruments Marked “X” are used to measure the final test results.

5.2. Test Setup

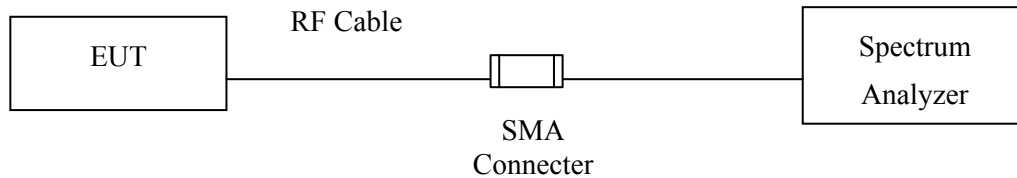

5.3. Limits

According to FCC Section 15.247(d). In any 100 kHz bandwidth outside the frequency band in which the spread spectrum or digitally modulated intentional radiator is operating, the radio frequency power that is produced by the intentional radiator shall be at least 20 dB below that in the 100 kHz bandwidth within the band that contains the highest level of the desired power, based on either an RF conducted or measurement, provided the transmitter demonstrates compliance with the peak conducted power limits. If the transmitter complies with the conducted power limits based on the use of RMS averaging over a time interval, the attenuation required under this paragraph shall be 30 dB instead of 20 dB.

5.4. Test Procedure

The EUT was tested according to DTS test procedure of KDB558074 for compliance to FCC 47CFR 15.247 requirements.

5.5. Uncertainty

± 150Hz

5.6. Test Result of RF antenna conducted test

Product : Afterglow Anka_AG7 wireless Headset for XB1
Test Item : RF antenna conducted test
Test Site : No.3 OATS
Test Mode : Mode 1: Transmit

Channel 01 (2403.35MHz) 30M-25GHz

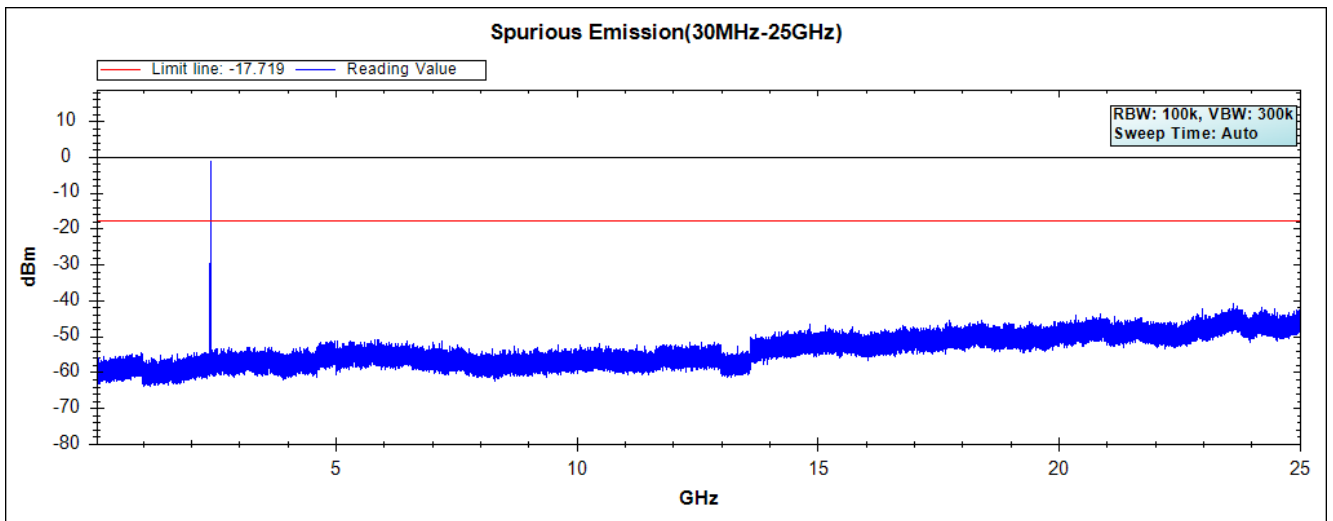

Note: The above test pattern is synthesized by multiple of the frequency range.

Product : Afterglow Anka_AG7 wireless Headset for XB1
Test Item : RF antenna conducted test
Test Site : No.3 OATS
Test Mode : Mode 1: Transmit

Channel 20 (2441.35MHz) 30M-25GHz

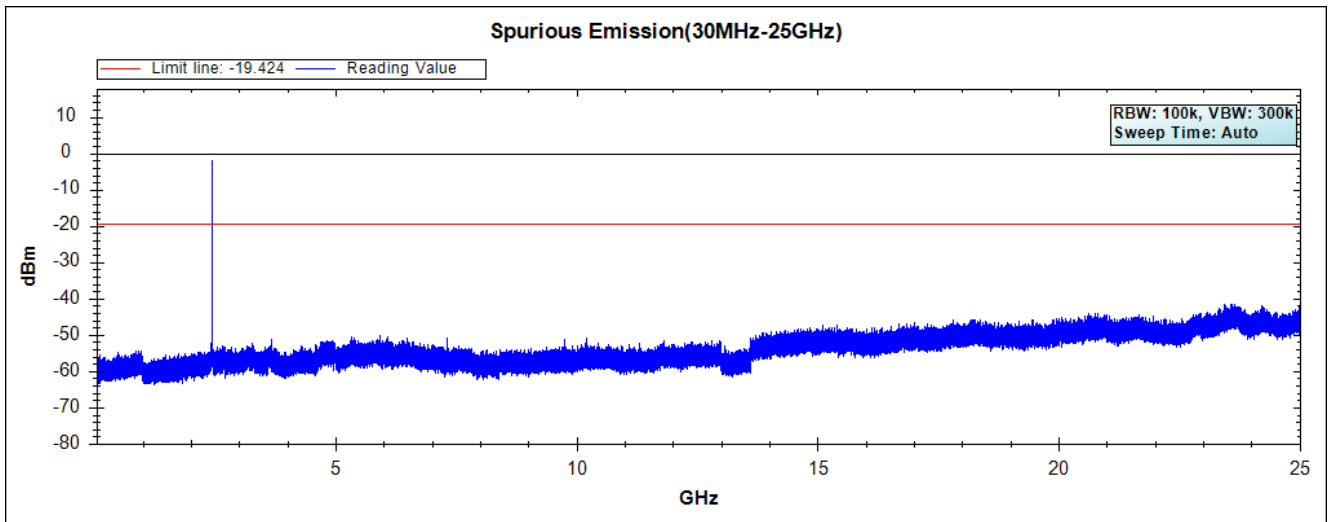

Note: The above test pattern is synthesized by multiple of the frequency range.

Product : Afterglow Anka_AG7 wireless Headset for XB1
Test Item : RF antenna conducted test
Test Site : No.3 OATS
Test Mode : Mode 1: Transmit

Channel 39 (2479.35MHz) 30M-25GHz

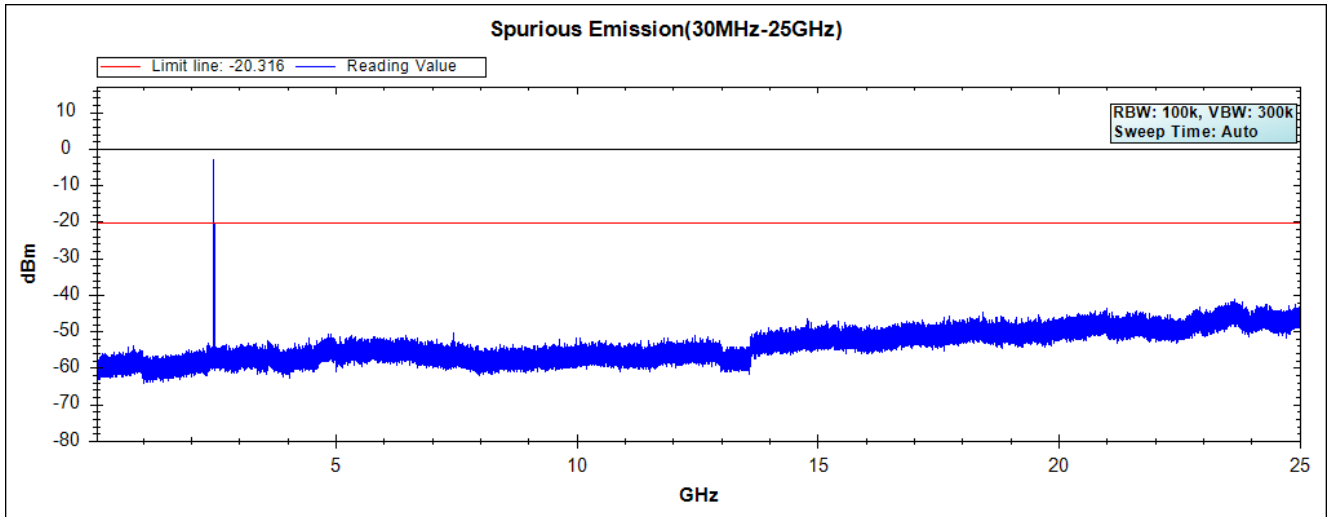

Note: The above test pattern is synthesized by multiple of the frequency range.

6. Band Edge

6.1. Test Equipment

RF Conducted Measurement

The following test equipments are used during the band edge tests:

	Equipment	Manufacturer	Model No./Serial No.	Last Cal.
	Spectrum Analyzer	R&S	FSP40 / 100170	Jun., 2015
	Spectrum Analyzer	Agilent	E4407B / US39440758	Jun., 2015
X	Spectrum Analyzer	Agilent	N9010A / MY48030495	Apr., 2015

RF Radiated Measurement:

The following test equipments are used during the band edge tests:

Test Site		Equipment	Manufacturer	Model No./Serial No.	Last Cal.
☒ Site # 3		Bilog Antenna	Schaffner Chase	CBL6112B/2673	Sep., 2014
	X	Horn Antenna	Schwarzbeck	BBHA9120D/D305	Sep., 2014
		Horn Antenna	Schwarzbeck	BBHA9170/208	Jul., 2014
	X	Pre-Amplifier	Agilent	8447D/2944A09549	Sep., 2014
	X	Spectrum Analyzer	Agilent	E4407B / US39440758	May, 2015
		Test Receiver	R & S	ESCS 30/ 825442/018	Sep., 2014
	X	Coaxial Cable	QuieTek	QTK-CABLE/ CAB5	Feb., 2015
	X	Controller	QuieTek	QTK-CONTROLLER/ CTRL3	N/A
	X	Coaxial Switch	Anritsu	MP59B/6200265729	N/A

- Note:
1. All equipments are calibrated every one year.
 2. The test instruments marked by "X" are used to measure the final test results.

6.2. Test Setup

RF Conducted Measurement

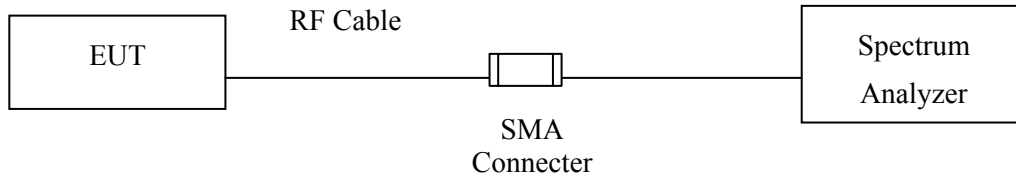

RF Radiated Measurement:

Above 1GHz

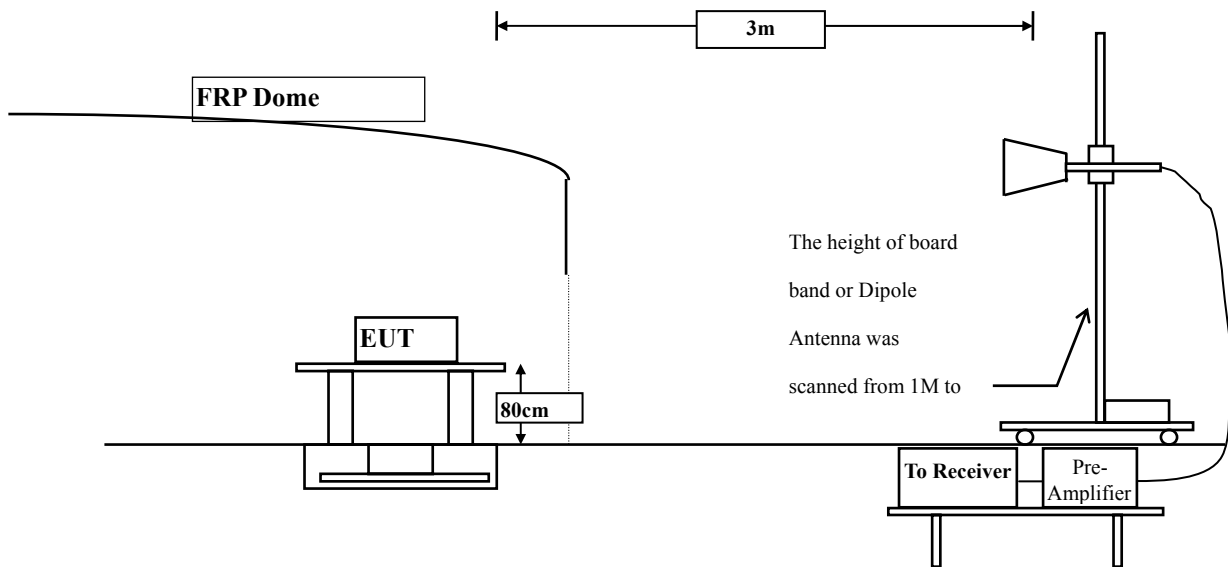

6.3. Limit

In any 100 kHz bandwidth outside the frequency band in which the spread spectrum intentional radiator is operating, the radio frequency power that is produced by the intentional radiator shall be at least 20 dB below that in the 100 kHz bandwidth within the band that contains the highest level of the desired power, based on either an RF conducted or a radiated measurement. Attenuation below the general limits specified in Section 15.209(a) is not required. In addition, radiated emissions which fall in the restricted bands, as defined in Section 15.205(a), must also comply with the radiated emission limits specified in Section 15.209(a) (see Section 15.205(c)).

6.4. Test Procedure

The EUT was setup according to ANSI C63.10, 2009 and tested according to DTS test procedure of KDB558074 for compliance to FCC 47CFR 15.247 requirements.

The EUT is placed on a turn table which is 0.8 meter above ground. The turn table is rotated 360 degrees to determine the position of the maximum emission level. The EUT was positioned such that the distance from antenna to the EUT was 3 meters.

The antenna is scanned from 1 meter to 4 meters to find out the maximum emission level. This is repeated for both horizontal and vertical polarization of the antenna. In order to find the maximum emission, all of the interface cables were manipulated according to ANSI C63.10:2009 on radiated measurement.

6.5. Uncertainty

± 3.9 dB above 1GHz

± 3.8 dB below 1GHz

6.6. Test Result of Band Edge

Product : Afterglow Anka_AG7 wireless Headset for XB1
 Test Item : Band Edge Data
 Test Site : No.3 OATS
 Test Mode : Mode 1: Transmit (2403.35MHz)

RF Radiated Measurement (Horizontal):

Channel No.	Frequency (MHz)	Correct Factor (dB)	Reading Level (dBuV)	Emission Level (dBuV/m)	Peak Limit (dBuV/m)	Average Limit (dBuV/m)	Result
01 (Peak)	2390.000	-2.687	53.093	50.406	74.00	54.00	Pass
01 (Peak)	2398.800	-2.662	77.298	74.636	--	--	--
01 (Peak)	2400.000	-2.660	76.301	73.641	--	--	--
01 (Peak)	2403.600	-2.655	100.947	98.292	--	--	--
01 (Average)	2390.000	-2.687	41.075	38.388	74.00	54.00	Pass
01 (Average)	2398.000	-2.663	69.145	66.482	--	--	--
01 (Average)	2400.000	-2.660	64.489	61.829	--	--	--
01 (Average)	2403.400	-2.655	97.854	95.199	--	--	--

Figure Channel 01: Horizontal (Peak)

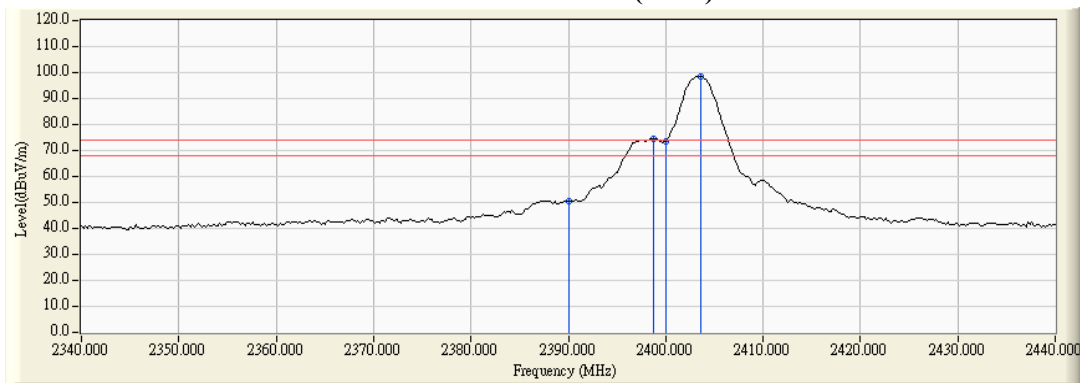
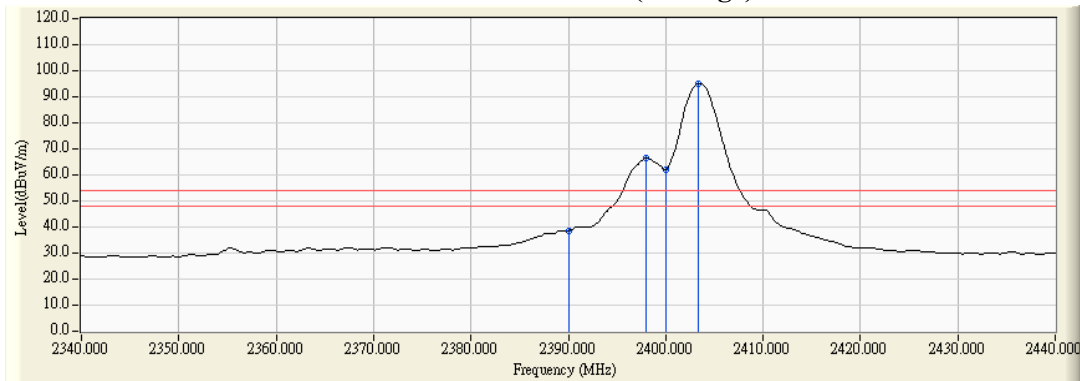

Figure Channel 01: Horizontal (Average)



- Note: 1. All readings above 1GHz are performed with peak and/or average measurements as necessary.
 2. Peak measurements: RBW = 1MHz, VBW = 3 MHz, Sweep: Auto.
 3. Average measurements: RBW = 1MHz, VBW = 10 Hz, Sweep: Auto.
 4. “ * ”, means this data is the worst emission level.
 5. Measurement Level = Reading Level + Correct Factor.
 6. The average measurement was not performed when the peak measured data under the limit of average detection.

Product : Afterglow Anka_AG7 wireless Headset for XB1
 Test Item : Band Edge Data
 Test Site : No.3 OATS
 Test Mode : Mode 1: Transmit (2403.35MHz)

RF Radiated Measurement (Vertical):

Channel No.	Frequency (MHz)	Correct Factor (dB)	Reading Level (dBuV)	Emission Level (dBuV/m)	Peak Limit (dBuV/m)	Average Limit (dBuV/m)	Result
01 (Peak)	2390.000	-4.159	47.583	43.424	74.00	54.00	Pass
01 (Peak)	2399.000	-4.172	71.073	66.902	--	--	--
01 (Peak)	2400.000	-4.171	69.619	65.448	--	--	--
01 (Peak)	2403.600	-4.170	94.378	90.208	--	--	--
01 (Average)	2390.000	-4.159	35.658	31.499	74.00	54.00	Pass
01 (Average)	2398.000	-4.171	62.752	58.581	--	--	--
01 (Average)	2400.000	-4.171	58.060	53.889	--	--	--
01 (Average)	2403.400	-4.170	91.248	87.078	--	--	--

Figure Channel 01: Vertical (Peak)

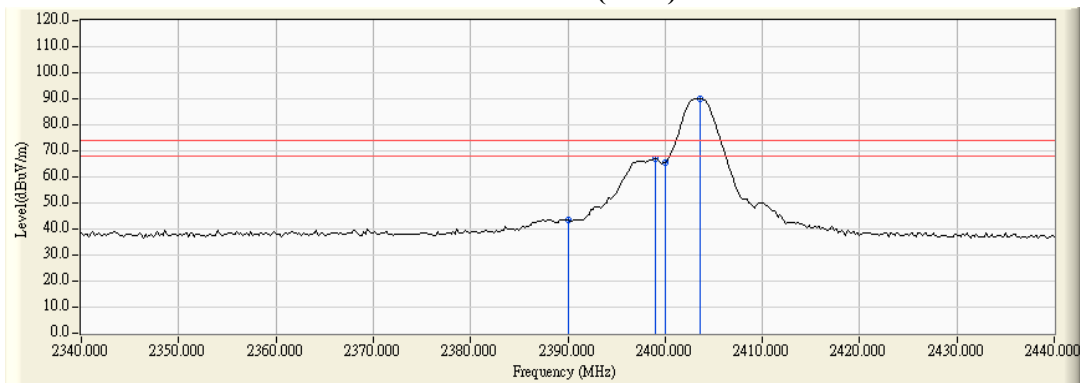
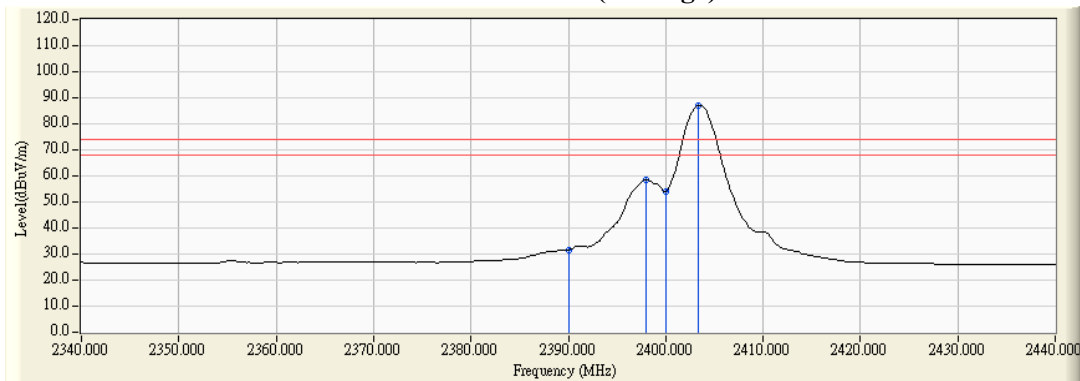

Figure Channel 01: Vertical (Average)



Note:

1. All readings above 1GHz are performed with peak and/or average measurements as necessary.
2. Peak measurements: RBW = 1MHz, VBW = 3 MHz, Sweep: Auto.
3. Average measurements: RBW = 1MHz, VBW = 10 Hz, Sweep: Auto.
4. “ * ”, means this data is the worst emission level.
5. Measurement Level = Reading Level + Correct Factor.
6. The average measurement was not performed when the peak measured data under the limit of average detection.

Product : Afterglow Anka_AG7 wireless Headset for XB1
 Test Item : Band Edge Data
 Test Site : No.3 OATS
 Test Mode : Mode 1: Transmit (2479.35MHz)

RF Radiated Measurement (Horizontal):

Channel No.	Frequency (MHz)	Correct Factor (dB)	Reading Level (dBuV)	Emission Level (dBuV/m)	Peak Limit (dBuV/m)	Average Limit (dBuV/m)	Result
39 (Peak)	2479.100	-2.606	97.766	95.160	--	--	--
39 (Peak)	2483.500	-2.601	65.376	62.774	74.00	54.00	Pass
39 (Average)	2479.500	-2.605	94.798	92.193	--	--	--
39 (Average)	2483.500	-2.601	55.217	52.615	74.00	54.00	Pass

Figure Channel 39: Horizontal (Peak)

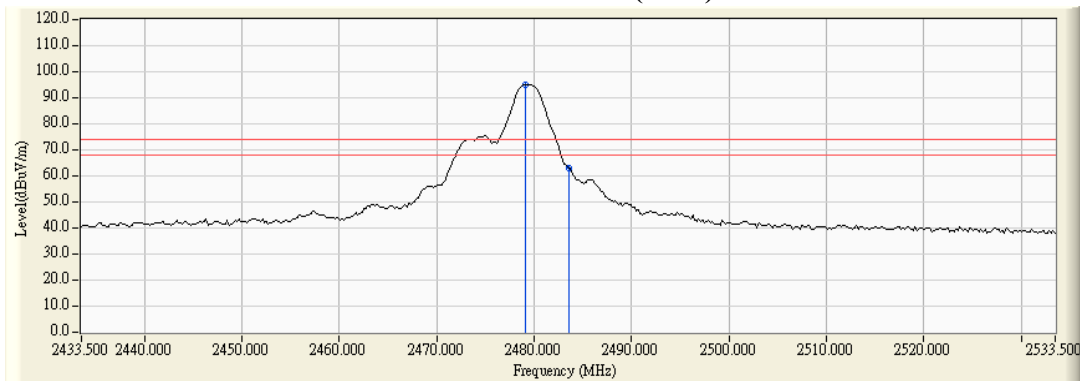
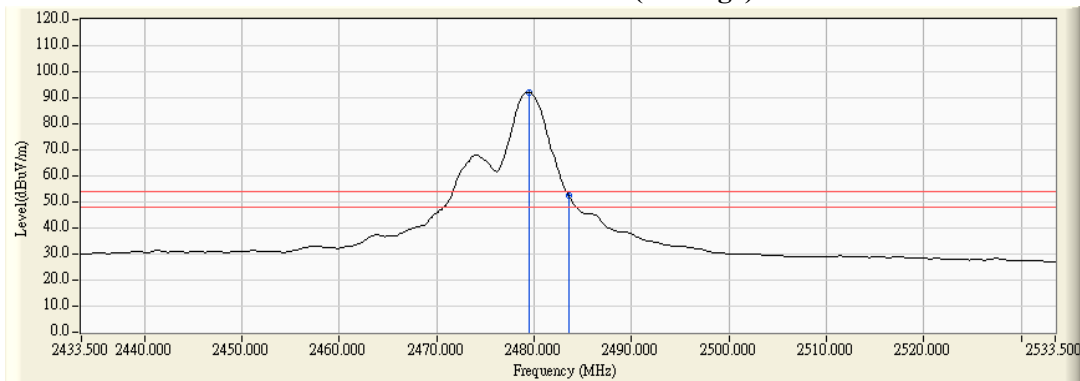

Figure Channel 39: Horizontal (Average)



- Note:1. All readings above 1GHz are performed with peak and/or average measurements as necessary.
 2. Peak measurements: RBW = 1MHz, VBW = 3 MHz, Sweep: Auto.
 3. Average measurements: RBW = 1MHz, VBW = 10 Hz, Sweep: Auto.
 4. “ * ”, means this data is the worst emission level.
 5. Measurement Level = Reading Level + Correct Factor.
 6. The average measurement was not performed when the peak measured data under the limit of average detection.

Product : Afterglow Anka_AG7 wireless Headset for XB1
 Test Item : Band Edge Data
 Test Site : No.3 OATS
 Test Mode : Mode 1: Transmit (2479.35MHz)

RF Radiated Measurement (Vertical):

Channel No.	Frequency (MHz)	Correct Factor (dB)	Reading Level (dBuV)	Emission Level (dBuV/m)	Peak Limit (dBuV/m)	Average Limit (dBuV/m)	Result
39 (Peak)	2479.100	-3.981	92.569	88.588	--	--	--
39 (Peak)	2483.500	-3.966	61.661	57.694	74.00	54.00	Pass
39 (Average)	2479.500	-3.979	89.544	85.565	--	--	--
39 (Average)	2483.500	-3.966	50.037	46.070	74.00	54.00	Pass

Figure Channel 39: Vertical (Peak)

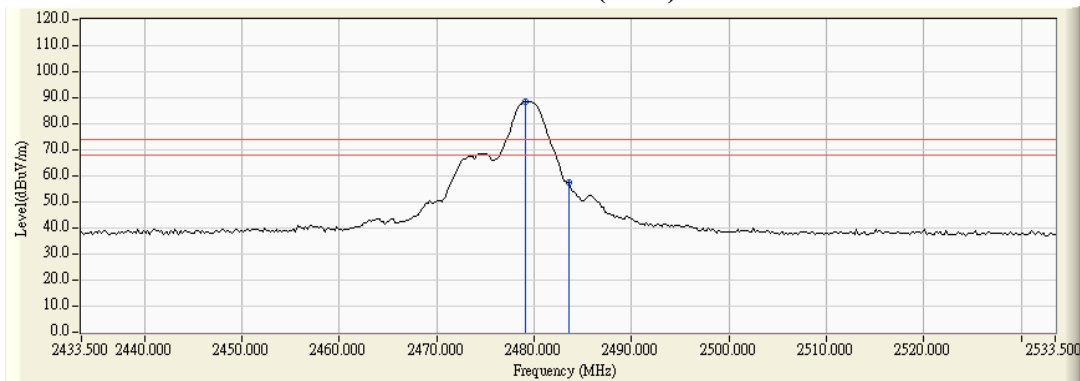
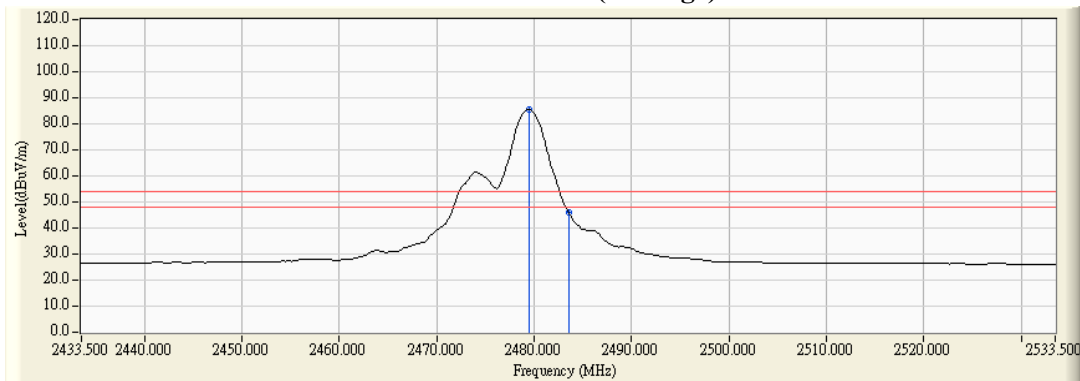

Figure Channel 39: Vertical (Average)



Note:

1. All readings above 1GHz are performed with peak and/or average measurements as necessary.
2. Peak measurements: RBW = 1MHz, VBW = 3 MHz, Sweep: Auto.
3. Average measurements: RBW = 1MHz, VBW = 10 Hz, Sweep: Auto.
4. “ * ”, means this data is the worst emission level.
5. Measurement Level = Reading Level + Correct Factor.
6. The average measurement was not performed when the peak measured data under the limit of average detection.

7. Occupied Bandwidth

7.1. Test Equipment

	Equipment	Manufacturer	Model No./Serial No.	Last Cal.
	Spectrum Analyzer	R&S	FSP40 / 100170	Jun., 2015
	Spectrum Analyzer	Agilent	E4407B / US39440758	Jun., 2015
X	Spectrum Analyzer	Agilent	N9010A / MY48030495	Apr., 2015

Note:

1. All equipments are calibrated with traceable calibrations. Each calibration is traceable to the national or international standards.
2. The test instruments marked with “X” are used to measure the final test results.

7.2. Test Setup

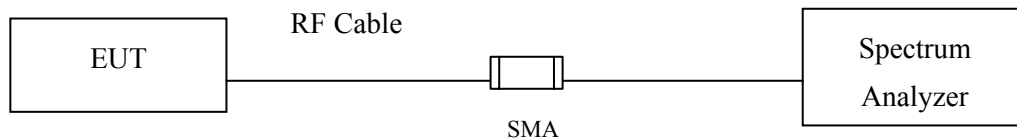

7.3. Limits

The minimum bandwidth shall be at least 500 kHz.

7.4. Test Procedure

The EUT was setup according to ANSI C63.10 2009; tested according to DTS test procedure of KDB558074 for compliance to FCC 47CFR 15.247 requirements.

Set RBW = 100kHz , VBW \geq 3*RBW

7.5. Uncertainty

\pm 150Hz

7.6. Test Result of Occupied Bandwidth

Product : Afterglow Anka_AG7 wireless Headset for XB1
 Test Item : Occupied Bandwidth Data
 Test Site : No.3 OATS
 Test Mode : Mode 1: Transmit (2403.35MHz)

Channel No.	Frequency (MHz)	Measurement Level (kHz)	Required Limit (kHz)	Result
01	2403.35	1620	>500	Pass

Figure Channel 01:

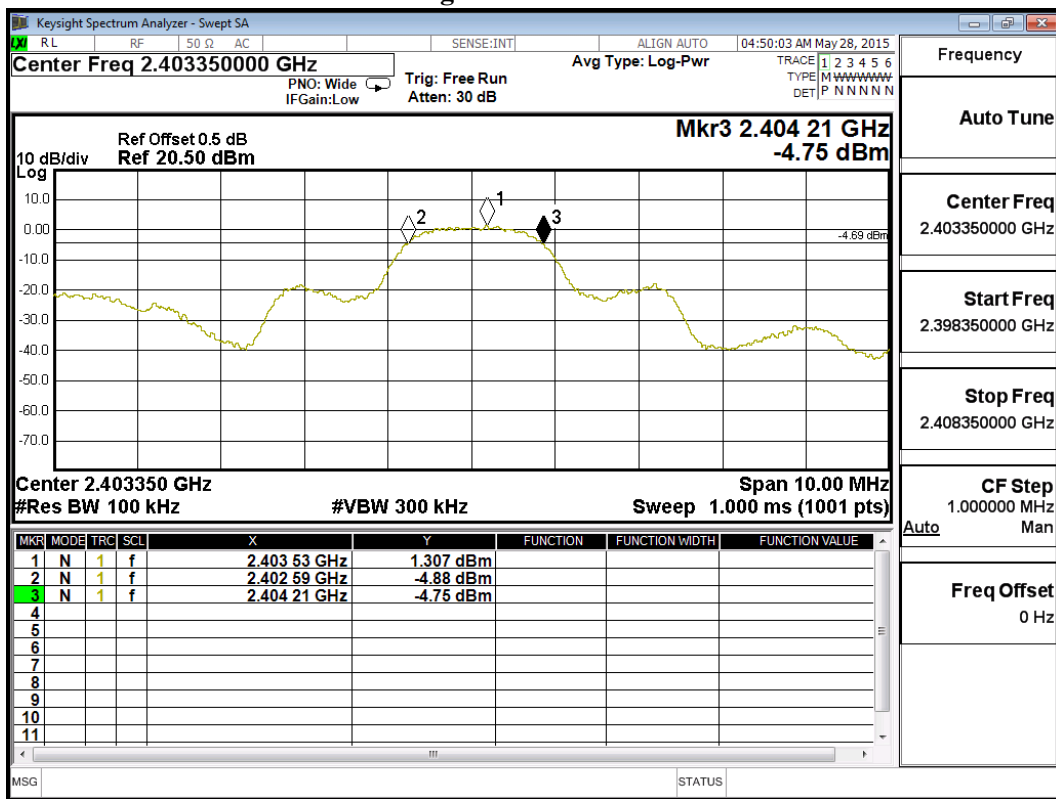

Product : Afterglow Anka_AG7 wireless Headset for XB1
 Test Item : Occupied Bandwidth Data
 Test Site : No.3 OATS
 Test Mode : Mode 1: Transmit (2441.35MHz)

Channel No.	Frequency (MHz)	Measurement Level (kHz)	Required Limit (kHz)	Result
20	2441.35	1600	>500	Pass

Figure Channel 20:

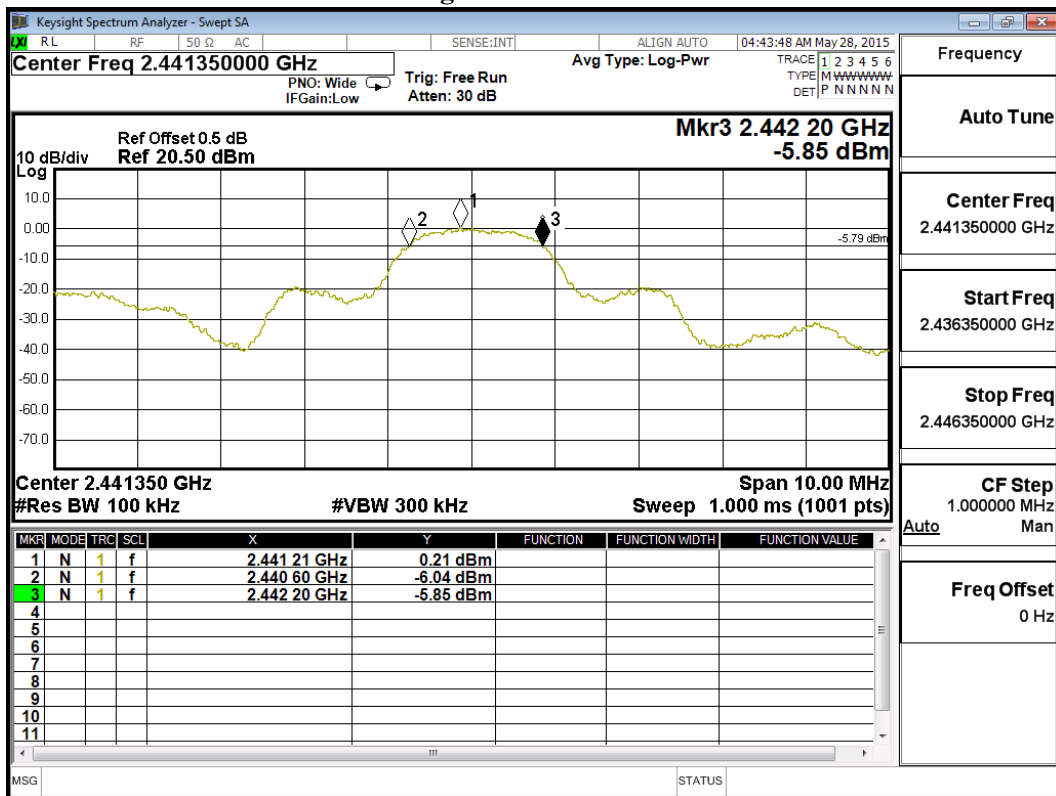

Product : Afterglow Anka_AG7 wireless Headset for XB1
 Test Item : Occupied Bandwidth Data
 Test Site : No.3 OATS
 Test Mode : Mode 1: Transmit (2479.35MHz)

Channel No.	Frequency (MHz)	Measurement Level (kHz)	Required Limit (kHz)	Result
39	2479.35	1640	>500	Pass

Figure Channel 39:

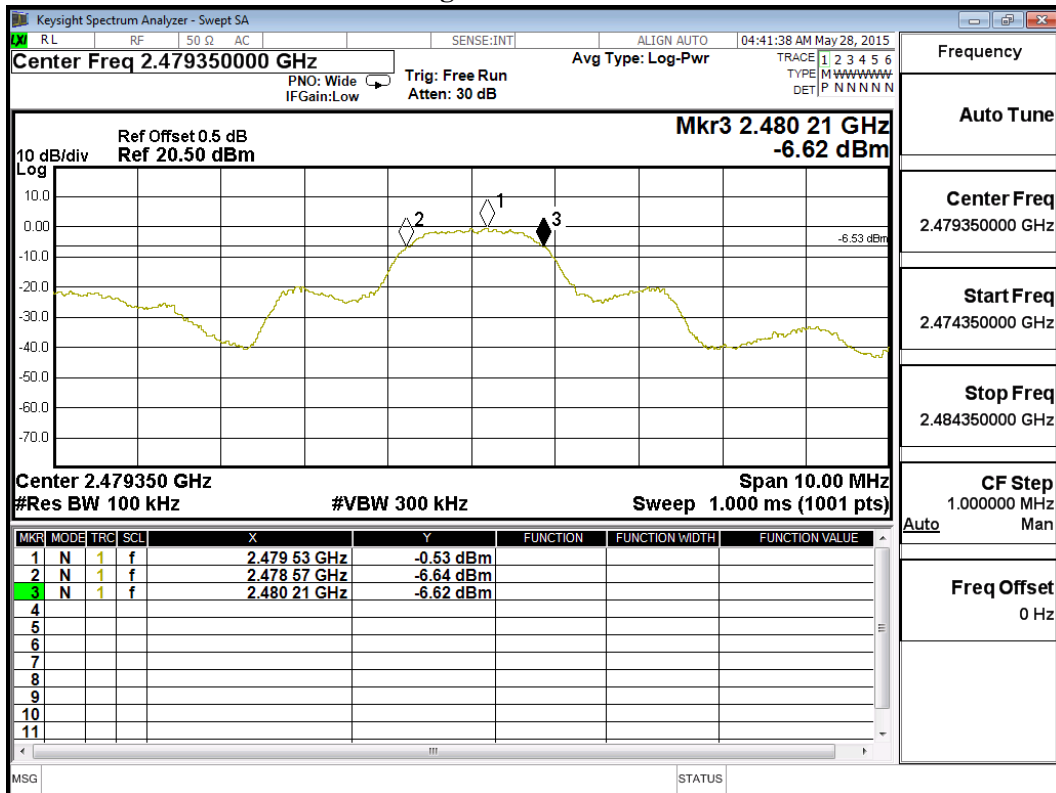

8. Power Density

8.1. Test Equipment

	Equipment	Manufacturer	Model No./Serial No.	Last Cal.
	Spectrum Analyzer	R&S	FSP40 / 100170	Jun., 2015
	Spectrum Analyzer	Agilent	E4407B / US39440758	Jun., 2015
X	Spectrum Analyzer	Agilent	N9010A / MY48030495	Apr., 2015

Note:

1. All equipments are calibrated with traceable calibrations. Each calibration is traceable to the national or international standards.
2. The test instruments marked with “X” are used to measure the final test results.

8.2. Test Setup

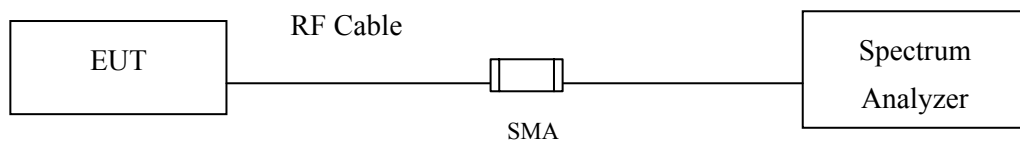

8.3. Limits

The transmitted power density averaged over any 1 second interval shall not be greater +8dBm in any 3kHz bandwidth.

8.4. Test Procedure

The EUT was setup according to ANSI C63.10: 2009, the maximum power spectral density using KDB 558074 section 10.2 PKPSD (peak PSD) method.

8.5. Uncertainty

± 1.27 dB

8.6. Test Result of Power Density

Product : Afterglow Anka_AG7 wireless Headset for XB1
 Test Item : Power Density Data
 Test Site : No.3 OATS
 Test Mode : Mode 1: Transmit(2403.35MHz)

Channel No.	Frequency (MHz)	Measure Level (dBm)	Limit (dBm)	Result
01	2403.35	2.281	< 8dBm	Pass

Figure Channel 01:

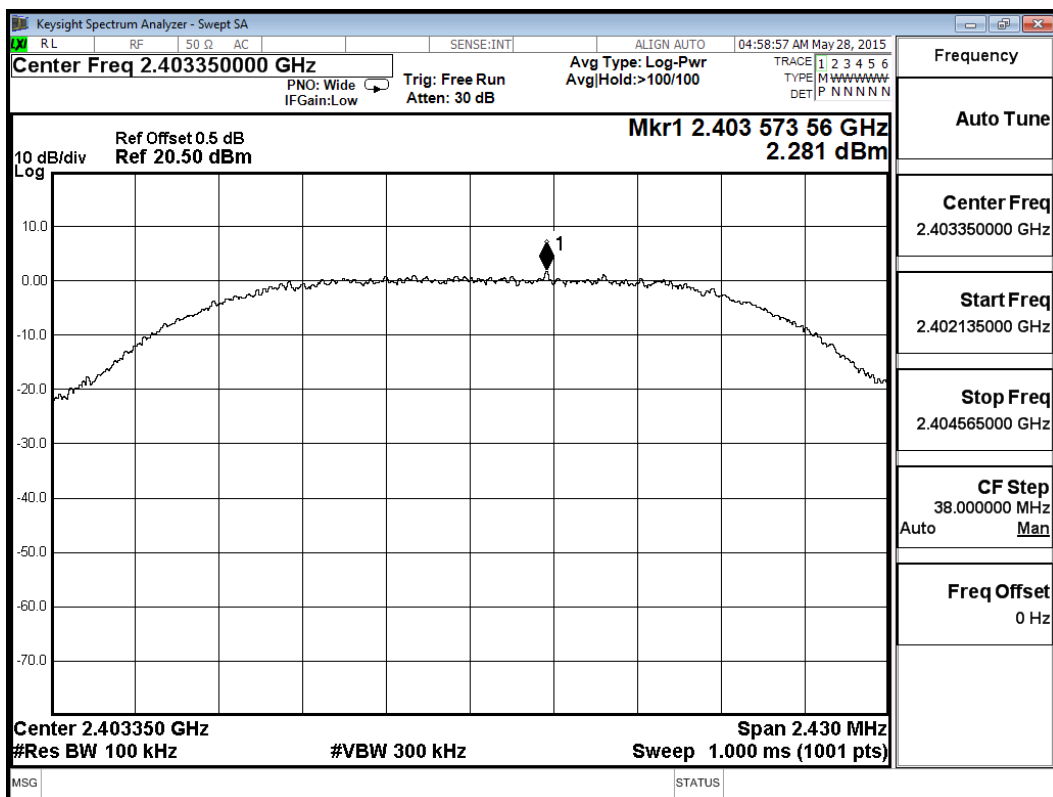

Product : Afterglow Anka_AG7 wireless Headset for XB1
 Test Item : Power Density Data
 Test Site : No.3OATS
 Test Mode : Mode 1: Transmit (2441.35MHz)

Channel No.	Frequency (MHz)	Measurement Level (dBm)	Required Limit (dBm)	Result
20	2441.35	0.576	< 8dBm	Pass

Figure Channel 20:

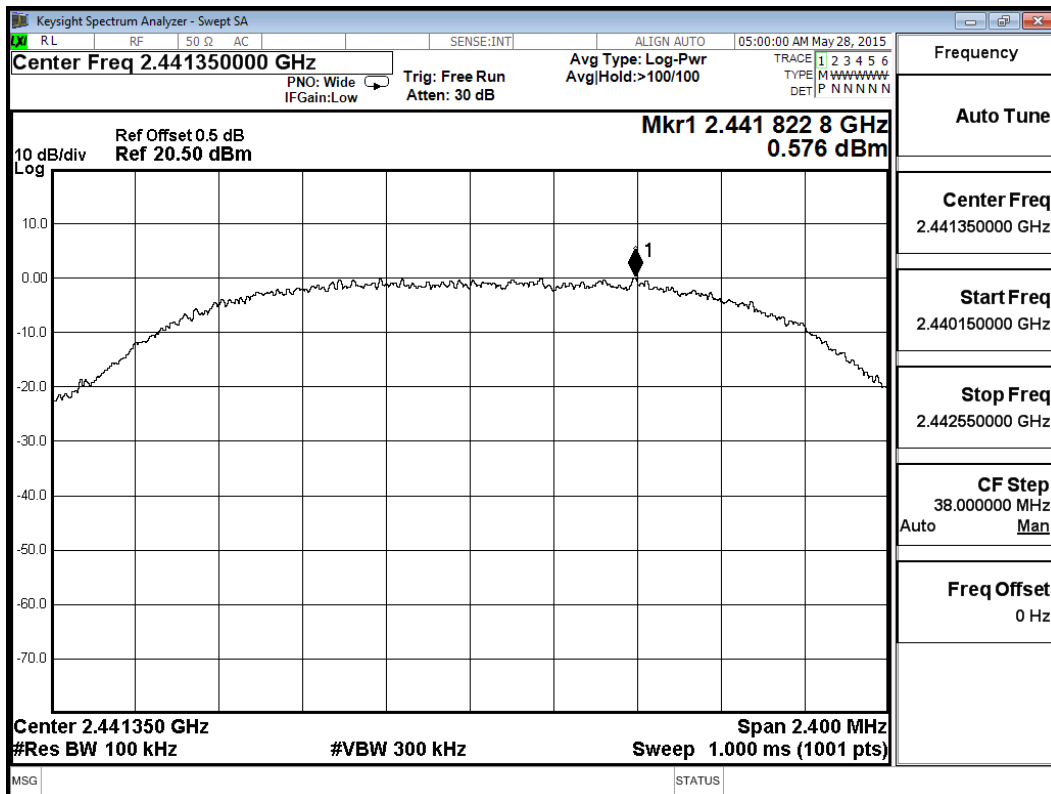

Product : Afterglow Anka_AG7 wireless Headset for XB1
Test Item : Power Density Data
Test Site : No.3 OATS
Test Mode : Mode 1: Transmit (2479.35MHz)

Channel No.	Frequency (MHz)	Measurement Level (dBm)	Required Limit (dBm)	Result
39	2479.35	-0.316	< 8dBm	Pass

Figure Channel 39:

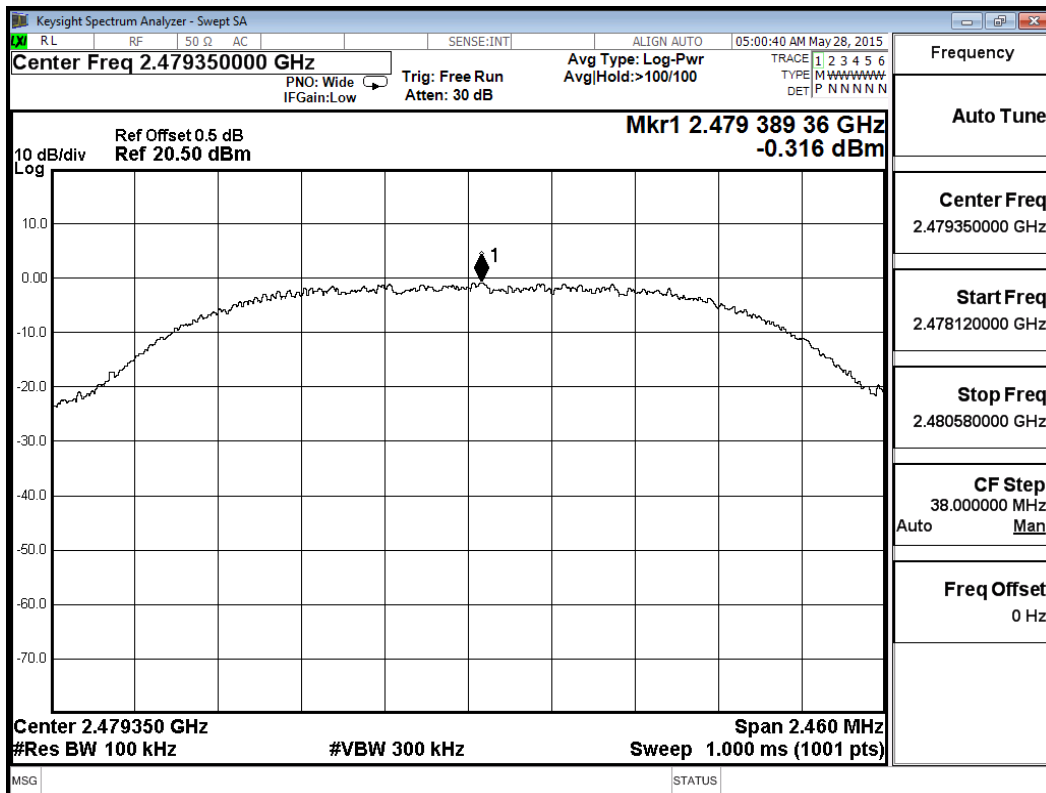

9. EMI Reduction Method During Compliance Testing

No modification was made during testing.