

TEST REPORT

Report No.: BCTC2312923038-2E

Applicant: NEXXT SOLUTIONS

Product Name: Router

Test Model: NCM-X1800

Tested Date: 2023-12-12 to 2023-12-25

Issued Date: 2023-12-25

Shenzhen BCTC Testing Co., Ltd.



FCC ID: X4YHAX1800

Product Name: Router
Trademark: N/A
Model/Type reference: NCM-X1800
Prepared For: NEXXT SOLUTIONS
Address: 3505 N.W 107TH AVE. MIAMI, Florida 33178, United States
Manufacturer: Sungale Electronics (Shenzhen) Limited
Address: No. 1302, DaHong High-Tech Park, No. 6-18, Xinhe Road, Xinqiao, BaoAn, Shenzhen 518125, CHINA
Prepared By: Shenzhen BCTC Testing Co., Ltd.
Address: 1-2/F., Building B, Pengzhou Industrial Park, No.158, Fuyuan 1st Road, Zhancheng, Fuhai Subdistrict, Bao'an District, Shenzhen, Guangdong, China
Sample Received Date: 2023-12-12
Sample tested Date: 2023-12-12 to 2023-12-25
Issue Date: 2023-12-25
Report No.: BCTC2312923038-2E
FCC Part15 15.407
ANSI C63.10-2013
KDB 662911 D01 v02r01
KDB 789033 D02 v02r01
Test Standards:
Test Results: PASS

Tested by:

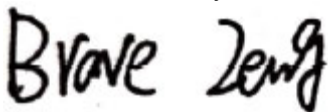

Brave Zeng/ Project Handler

Approved by:



Zero Zhou/Reviewer

The test report is effective only with both signature and specialized stamp. This result(s) shown in this report refer only to the sample(s) tested. Without written approval of Shenzhen BCTC Testing Co., Ltd, this report can't be reproduced except in full. The tested sample(s) and the sample information are provided by the client.

Table Of Content

	Page
Test Report Declaration	
1. Version	5
2. Test Summary	6
3. Measurement Uncertainty	7
4. Product Information And Test Setup	8
4.1 Product Information.....	8
4.2 Test Setup Configuration	9
4.3 Support Equipment	9
4.4 Channel List	9
4.5 Test Mode	10
4.7 Antenna.....	11
5. Test Facility And Test Instrument Used.....	12
5.1 Test Facility.....	12
5.2 Test Instrument Used.....	12
6. Conducted Emissions.....	14
6.1 Block Diagram Of Test Setup.....	14
6.2 Limit	14
6.3 Test Procedure	14
6.4 EUT Operating Conditions	14
6.5 Test Result.....	15
7. Radiated Emissions.....	17
7.1 Block Diagram Of Test Setup.....	17
7.2 Limit	18
7.3 Test Procedure	19
7.4 EUT Operating Conditions	20
7.5 Test Result.....	20
8. Power Spectral Density Test	41
8.1 Block Diagram Of Test Setup.....	41
8.2 Limit	41
8.3 Test Procedure	42
8.4 EUT Operating Conditions	42
8.5 Test Result.....	43
9. 26dB & 6dB & 99% Emission Bandwidth	65
9.1 Block Diagram Of Test Setup.....	65
9.2 Limit	65
9.3 Test Procedure	65
9.4 EUT Operating Conditions	66
9.5 Test Result.....	67
10. Maximum Conducted Output Power.....	111
10.1 Block Diagram Of Test Setup.....	111
10.2 Limit	111
10.3 Test Procedure	111
10.4 EUT Operating Conditions	112
10.5 Test Result.....	113

11. Out Of Band Emissions	115
11.1 Block Diagram Of Test Setup.....	115
11.2 Limit	115
11.3 Test Procedure	115
11.4 EUT Operating Conditions	115
11.5 Test Result.....	115
12. Spurious RF Conducted Emissions.....	134
12.1 Block Diagram Of Test Setup.....	134
12.2 Limit	134
12.3 Test Procedure	134
12.4 Test Result.....	134
13. Frequency Stability Measurement	155
13.1 Block Diagram Of Test Setup.....	155
13.2 Limit	155
13.3 Test Procedure	155
13.4 Test Result.....	156
14. Antenna Requirement	162
14.1 Limit	162
14.2 Test Result.....	162
15. EUT Photographs.....	163
16. EUT Test Setup Photographs.....	164

(Note: N/A Means Not Applicable)

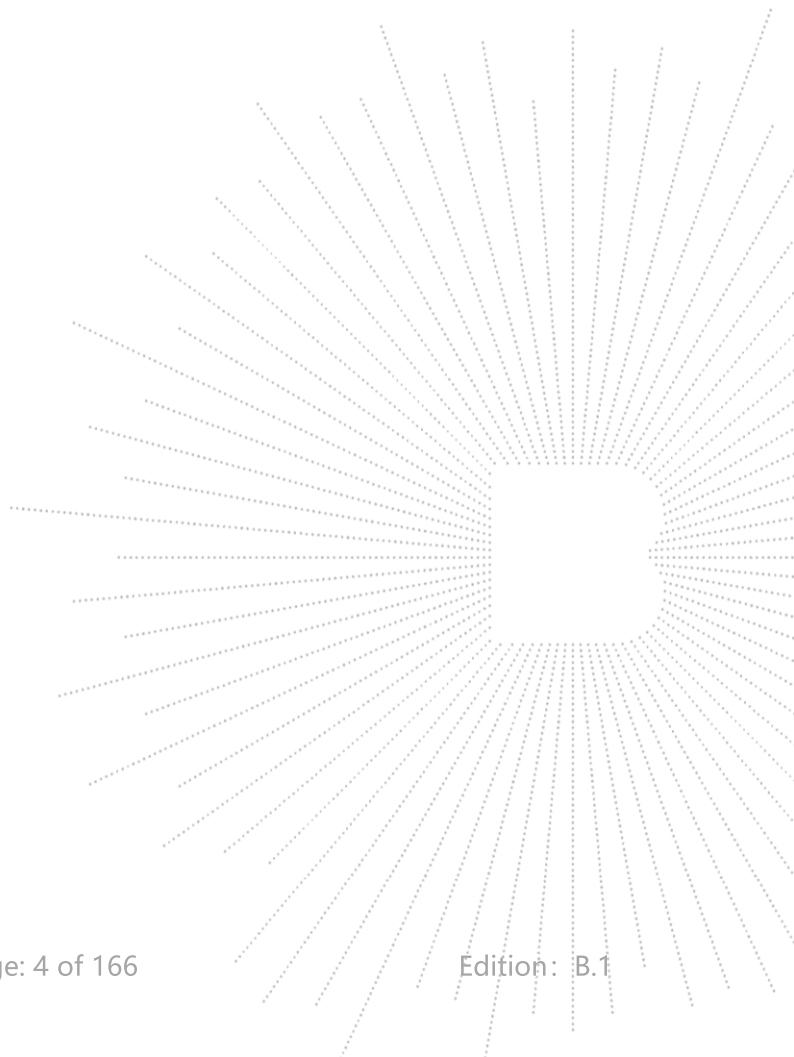

1. Version

Report No.	Issue Date	Description	Approved
BCTC2312923038-2E	2023-12-25	Original	Valid

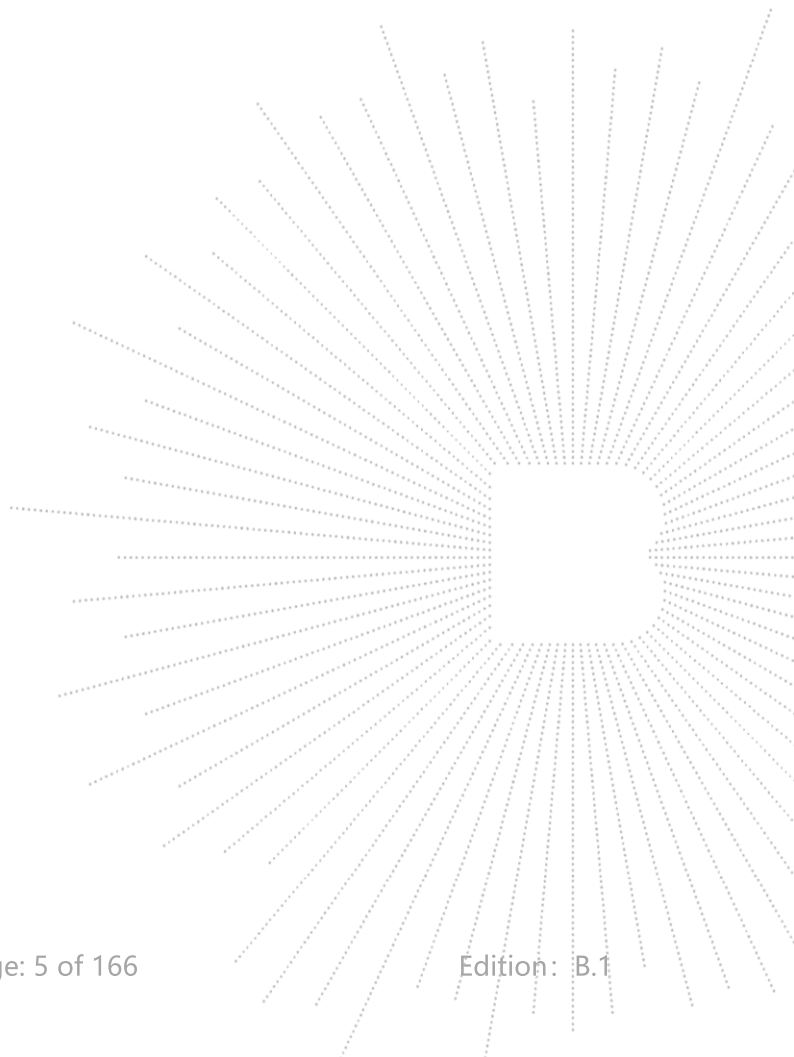

2. Test Summary

The Product has been tested according to the following specifications:

No.	Test Parameter	Clause No	Results
1	Spurious Radiated Emissions	15.209(a), 15.407 (b)(1) 15.407 (b)(4) 15.407 (b)(8)	PASS
2	Conducted Emission	15.207	PASS
3	26 dB and 99% Emission Bandwidth	15.407 (a)(12) 15.1049	PASS
4	Minimum 6 dB bandwidth	15.407(e)	PASS
5	Maximum Conducted Output Power	15.407 (a)(1) 15.407 (a)(3)	PASS
6	Band Edge	2.1051, 15.407(b)(1) 15.407(b)(4)	PASS
7	Power Spectral Density	15.407 (a)(1) 15.407 (a)(3)	PASS
8	Spurious Emissions at Antenna Terminals	2.1051, 15.407(b)	PASS
9	Antenna Requirement	15.203	PASS

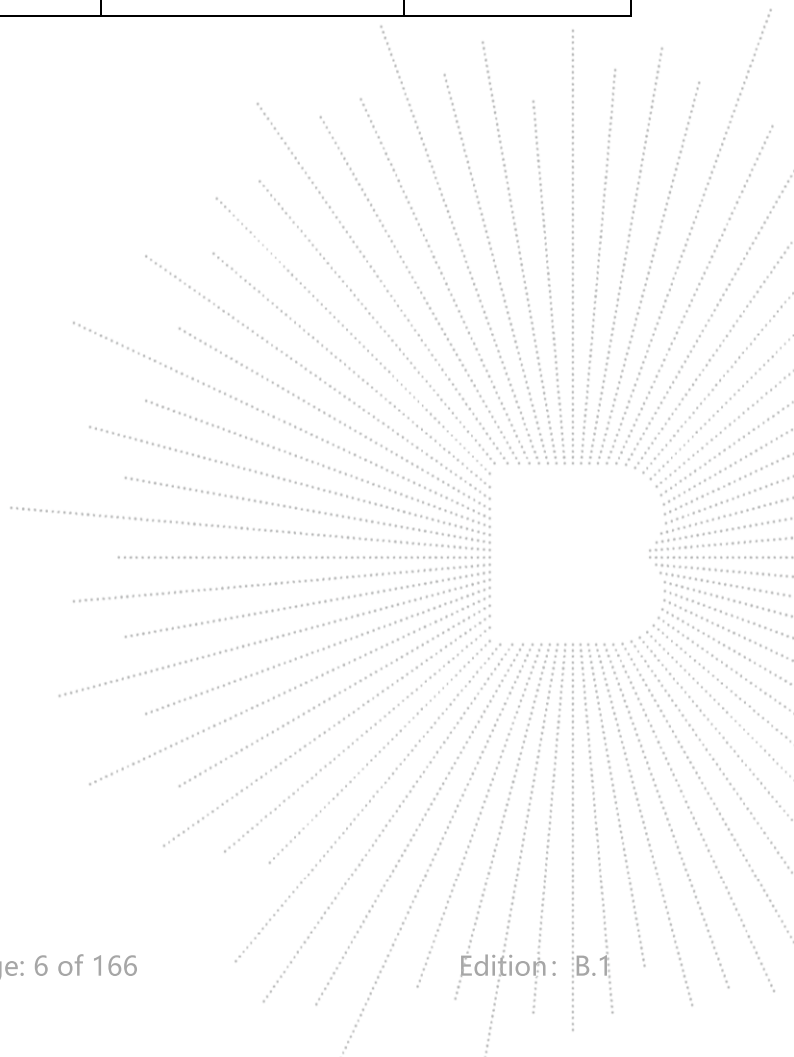

3. Measurement Uncertainty

Where relevant, the following measurement uncertainty levels have been estimated for tests performed on the Product as specified in CISPR 16-4-2. This uncertainty represents an expanded uncertainty expressed at approximately the 95% confidence level using a coverage factor of k=2.

No.	Item	Uncertainty
1	3m chamber Radiated spurious emission(9kHz-30MHz)	U=3.7dB
2	3m chamber Radiated spurious emission(30MHz-1GHz)	U=4.3dB
3	3m chamber Radiated spurious emission(1GHz-18GHz)	U=4.5dB
4	3m chamber Radiated spurious emission(18GHz-40GHz)	U=3.34dB
5	Conducted Emission(150kHz-30MHz)	U=3.20dB
6	Conducted Adjacent channel power	U=1.38dB
7	Conducted output power uncertainty Above 1G	U=1.576dB
8	Conducted output power uncertainty below 1G	U=1.28dB
9	humidity uncertainty	U=5.3%
10	Temperature uncertainty	U=0.59°C

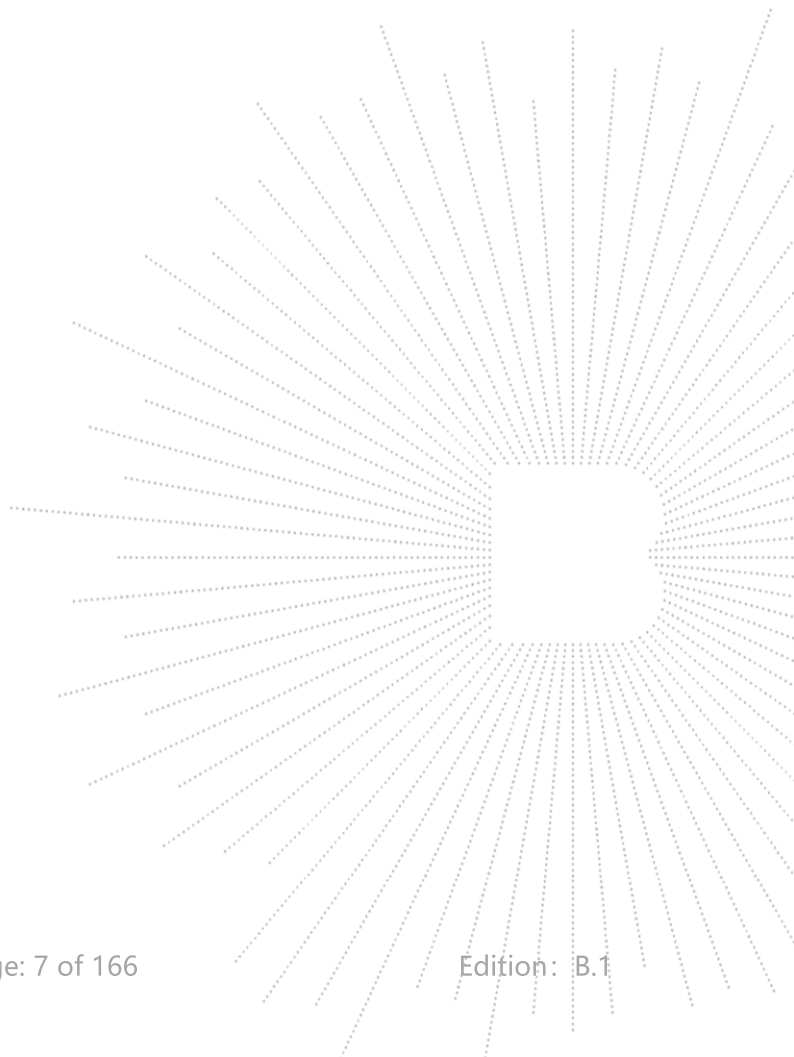

4. Product Information And Test Setup

4.1 Product Information

Model/Type Ref.:	NCM-X1800
Model differences:	N/A
Hardware Version:	N/A
Software Version:	N/A
IEEE 802.11 WLAN Mode Supported	802.11a/n/ac/ax(20MHz channel bandwidth) 802.11n/ac/ax(40MHz channel bandwidth) 802.11ac/ax(80MHz channel bandwidth) 5180-5240MHz for 802.11a/n/ax(HT20); 5190-5230MHz for 802.11n/ax(HT40); 5210MHz for 802.11 ac/ax80;
Operation Frequency:	5745-5825 MHz for 802.11a/n/ax(HT20); 5755-5795 MHz for 802.11n/ax(HT40); 5775MHz for 802.11 ac/ax80;
Data Rate	802.11a: 6,9,12,18,24,36,48,54Mbps; 802.11n(HT20/HT40):MCS0-MCS15; 802.11ac/ax(VHT20): NSS1, MCS0-MCS8 802.11ac/ax(VHT40/VHT80):NSS1, MCS0-MCS
Type of Modulation:	OFDM with BPSK/QPSK/16QAM/64QAM/256QAM/1024QAM for 802.11a/n/ac/ax;
Number Of Channel	4 channels for 802.11a/n20/ax20 in the 5180-5240MHz band ; 2 channels for 802.11 n40/ax40 in the 5190-5230MHz band ; 1 channels for 802.11 ac80/ax80 in the 5210MHz band ; 5 channels for 802.11a/n20/ax20 in the 5745-5825MHz band ; 2 channels for 802.11 n40/ax40 in the 5755-5795MHz band ; 1 channels for 802.11 ac80/ax80 in the 5775MHz band
Antenna installation:	Internal antenna 5.1G&5.8G Antenna A: 5.24 dBi Antenna B: 5.24 dBi
Antenna Gain:	Remark: <input checked="" type="checkbox"/> The antenna gain of the product comes from the antenna report provided by the customer, and the test data is affected by the customer information. <input type="checkbox"/> The antenna gain of the product is provided by the customer, and the test data is affected by the customer information.
Ratings:	DC 12V from adapter
Adapter:	MODEL NO.:MAUS-1201501802 INPUT: AC 100-240V~50/60Hz 0.5A OUTPUT: DC 12V 1.5A

4.2 Test Setup Configuration

See test photographs attached in *EUT TEST SETUP PHOTOGRAPHS* for the actual connections between Product and support equipment.

4.3 Support Equipment

No.	Device Type	Brand	Model	Series No.	Note
E-1	Router	N/A	NCM-X1800	N/A	EUT
E-2	ADAPTER	N/A	MAUS-1201501 802	N/A	Auxiliary

Item	Shielded Type	Ferrite Core	Length	Note
C-1	N/A	N/A	1M	DC cable unshielded

Notes:

- All the equipment/cables were placed in the worst-case configuration to maximize the emission during the test.
- Grounding was established in accordance with the manufacturer's requirements and conditions for the intended use.

4.4 Channel List

5.1G

802.11a/n/ac/ax(20MHz) Carrier Frequency Channel							
Channel	Frequency (MHz)	Channel	Frequency (MHz)	Channel	Frequency (MHz)	Channel	Frequency (MHz)
36	5180	44	5220	-	-	-	-
40	5200	48	5240	-	-	-	-

802.11n /ac/ax(40MHz) Carrier Frequency Channel							
Channel	Frequency (MHz)	Channel	Frequency (MHz)	Channel	Frequency (MHz)	Channel	Frequency (MHz)
38	5190	-	-	-	-	-	-
46	5230	-	-	-	-	-	-

802.11ac/ax (80MHz) Carrier Frequency Channel	
Channel	Frequency (MHz)
42	5210

5.8G

802.11a/n/ac/ax(20 MHz) Carrier Frequency Channel							
Channel	Frequency (MHz)	Channel	Frequency (MHz)	Channel	Frequency (MHz)	Channel	Frequency (MHz)
149	5745	153	5765	157	5785	161	5805
165	5825	-	-	-	-	-	-

802.11n/ac/ax 40MHz Carrier Frequency Channel					
Channel	Frequency (MHz)	Channel	Frequency (MHz)	Channel	Frequency (MHz)
151	5755	159	5795	-	-

802.11 ac/ax 80MHz Carrier Frequency Channel	
Channel	Frequency (MHz)
155	5775

4.5 Test Mode

To investigate the maximum EMI emission characteristics generates from EUT, the test system was pre-scanning tested base on the consideration of following EUT operation mode or test configuration mode which possible have effect on EMI emission level. Each of these EUT operation mode(s) or test configuration mode(s) mentioned above was evaluated respectively.

Pretest Mode	Description
Mode 1	802.11a / n/ ac 20/ ax 20 CH36/ CH40/ CH 48 802.11a /n/ ac 20/ ax 20 CH149/ CH157/ CH 165
Mode 2	802.11n/ ac40/ ax 40 CH38/ CH 46 802.11n/ ac40/ ax 40 CH 151 / CH 159
Mode 3	802.11 ac80/ ax80 CH 42/CH 155
Mode 4	Link mode (Conducted emission & Radiated emission)

Note:

- (1) The measurements are performed at all Bit Rate of Transmitter, the worst data was reported.
- (2) We're testing antenna A data.

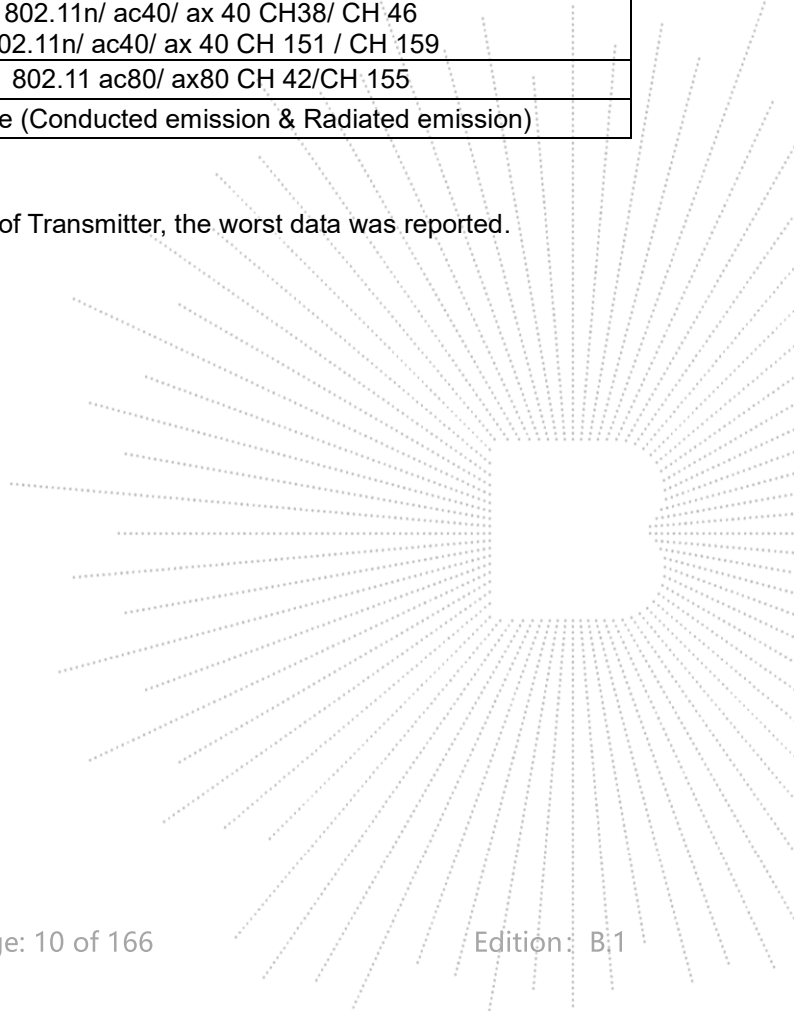

4.6 Table Of Parameters Of Text Software Setting

During testing channel & power controlling software provided by the customer was used to control the operating channel as well as the output power level. The RF output power selection is for the setting of RF output power expected by the customer and is going to be fixed on the firmware of the final end product power parameters

Test software Version	CMD		
Parameters	DEF	DEF	DEF

4.7 Antenna

5.1G & 5.8G

1)For power spectral density(PSD) measurements,
 Array Gain= $10\log(NANT/NSS)$ dB= $10\log(2/1)$ =3.01dB,
 So the directional gain for PSD is 8.25 dBi

2)For power measurements,
 The Array gain=0 dB for $NANT \leq 4$,
 So the directional gain for Power measurements is 5.24 dBi

Antenna	Brand	Model Name	Antenna Type	Gain (dBi)	NOTE
A	N/A	N/A	Internal antenna	5.24	N/A
B	N/A	N/A	Internal antenna	5.24	N/A

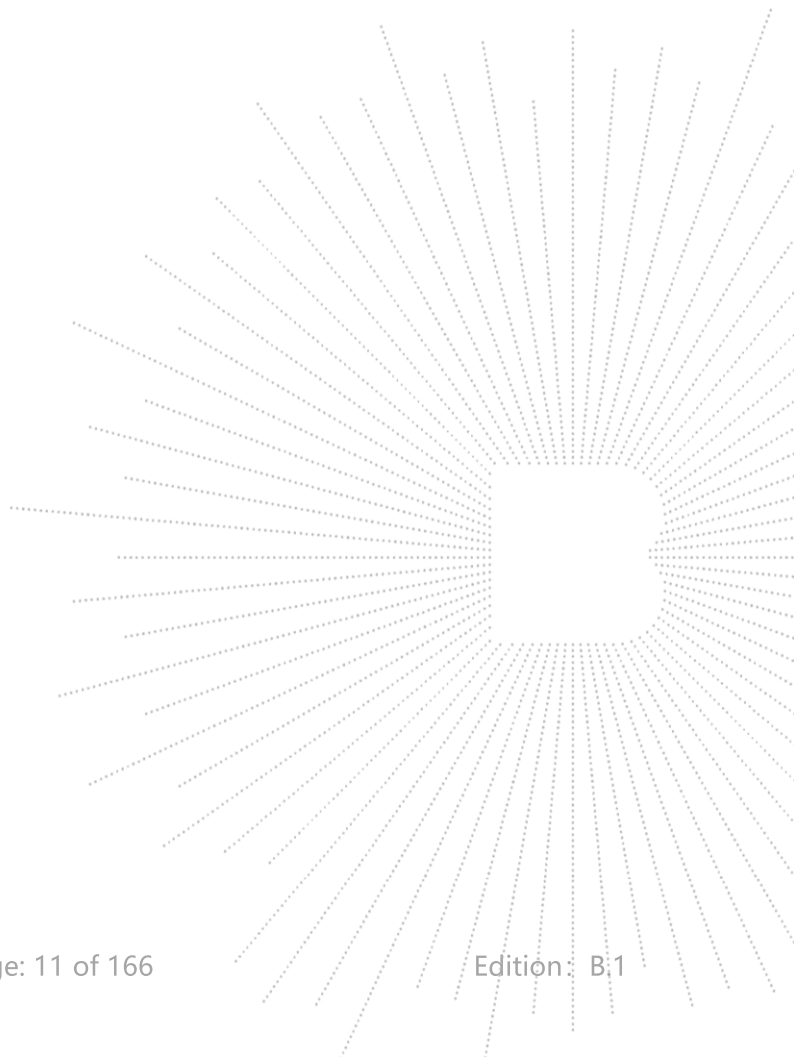

5. Test Facility And Test Instrument Used

5.1 Test Facility

All measurement facilities used to collect the measurement data are located at Shenzhen BCTC Testing Co., Ltd. Address: 1-2/F., Building B, Pengzhou Industrial Park, No.158, Fuyuan 1st Road, Zhancheng, Fuhai Subdistrict, Bao'an District, Shenzhen, Guangdong, China. The site and apparatus are constructed in conformance with the requirements of ANSI C63.4 and CISPR 16-1-1 other equivalent standards.

FCC Test Firm Registration Number: 712850

A2LA certificate registration number is: CN1212

ISED Registered No.: 23583

ISED CAB identifier: CN0017

5.2 Test Instrument Used

Conducted Emissions Test					
Equipment	Manufacturer	Model#	Serial#	Last Cal.	Next Cal.
Receiver	R&S	ESR3	102075	May 15, 2023	May 14, 2024
LISN	R&S	ENV216	101375	May 15, 2023	May 14, 2024
Software	Frad	EZ-EMC	EMC-CON 3A1	\	\
Pulse limiter	Schwarzbeck	VTSD9561-F	01323	Sept. 22, 2023	Sept. 21, 2024

RF Conducted Test					
Equipment	Manufacturer	Model#	Serial#	Last Cal.	Next Cal.
Power meter	Keysight	E4419	\	May 15, 2023	May 14, 2024
Power Sensor (AV)	Keysight	E9300A	\	May 15, 2023	May 14, 2024
Signal Analyzer20kHz-26.5GHz	Keysight	N9020A	MY49100060	May 15, 2023	May 14, 2024
Spectrum Analyzer9kHz-40GHz	R&S	FSP40	100363	May 15, 2023	May 14, 2024
Radio frequency control box	MAIWEI	MW100-RF CB	\	\	\
Software	MAIWEI	MTS 8310	\	\	\

Radiated Emissions Test (966 Chamber01)					
Equipment	Manufacturer	Model#	Serial#	Last Cal.	Next Cal.
966 chamber	ChengYu	966 Room	966	May 15, 2023	May 14, 2026
Receiver	R&S	ESR3	102075	May 15, 2023	May 14, 2024
Receiver	R&S	ESRP	101154	May 15, 2023	May 14, 2024
Amplifier	Schwarzbeck	BBV9744	9744-0037	May 15, 2023	May 14, 2024
TRILOG Broadband Antenna	Schwarzbeck	VULB9163	942	May 29, 2023	May 28, 2024
Loop Antenna(9KHz -30MHz)	Schwarzbeck	FMZB1519B	00014	May 31, 2023	May 30, 2024
Amplifier	SKET	LAPA_01G18 G-45dB	SK2021040901	May 15, 2023	May 14, 2024
Horn Antenna	Schwarzbeck	BBHA9120D	1541	May 31, 2023	May 30, 2024
Amplifier(18G Hz-40GHz)	MITEQ	TTA1840-35-HG	2034381	May 15, 2023	May 14, 2024
Horn Antenna(18G Hz-40GHz)	Schwarzbeck	BBHA9170	00822	May 31, 2023	May 30, 2024
Spectrum Analyzer9kHz-40GHz	R&S	FSP40	100363	May 15, 2023	May 14, 2024
Software	Frad	EZ-EMC	FA-03A2 RE	\	\

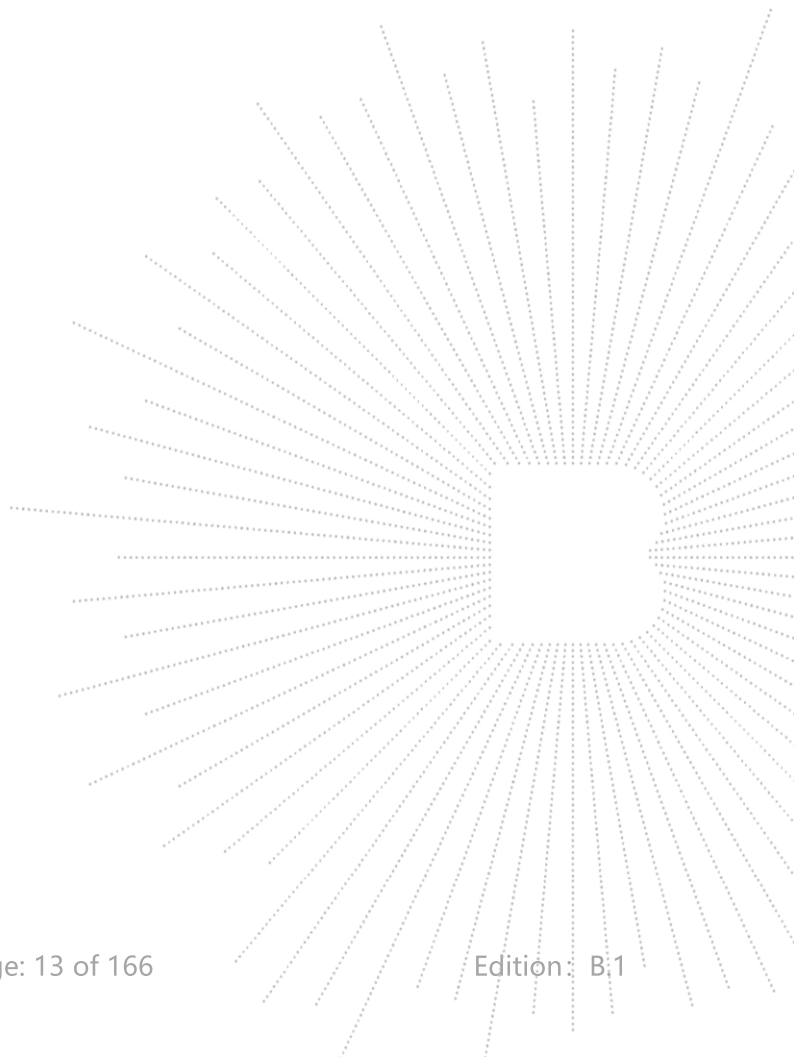

6. Conducted Emissions

6.1 Block Diagram Of Test Setup

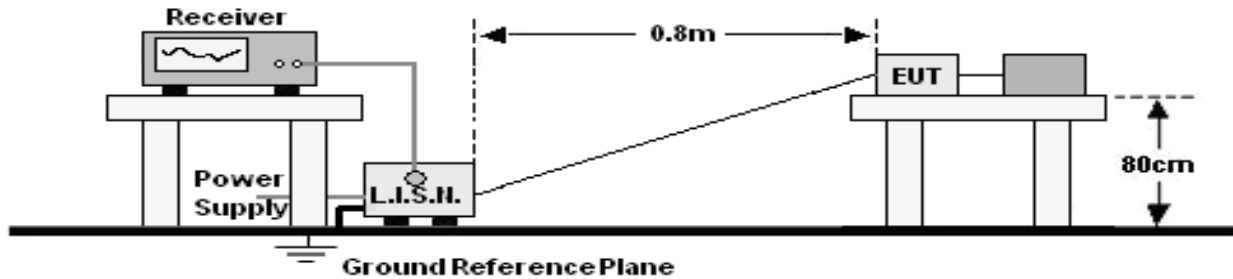

6.2 Limit

Frequency (MHz)	Limit (dBuV)	
	Quas-peak	Average
0.15 -0.5	66 - 56 *	56 - 46 *
0.50 -5.0	56.00	46.00
5.0 -30.0	60.00	50.00

Notes:
 1. *Decreasing linearly with logarithm of frequency.
 2. The lower limit shall apply at the transition frequencies.

6.3 Test Procedure

Receiver Parameters	Setting
Attenuation	10 dB
Start Frequency	0.15 MHz
Stop Frequency	30 MHz
IF Bandwidth	9 kHz

- The Product was placed on a nonconductive table 0.8 m above the horizontal ground reference plane, and 0.4 m from the vertical ground reference plane, and connected to the main through Line Impedance Stability Network (L.I.S.N).
- The RBW of the receiver was set at 9 kHz in 150 kHz ~ 30MHz with Peak and AVG detector in Max Hold mode. Run the receiver's pre-scan to record the maximum disturbance generated from Product in all power lines in the full band.
- For each frequency whose maximum record was higher or close to limit, measure its QP and AVG values and record.

6.4 EUT Operating Conditions

The EUT was configured for testing in a typical fashion (as a customer would normally use it). The EUT has been programmed to continuously transmit during test. This operating condition was tested and used to collect the included data.

6.5 Test Result

Temperature:	26 °C	Relative Humidity:	54%
Pressure:	101KPa	Phase :	L
Test Mode:	Mode 1	Test Voltage :	AC120V/60Hz

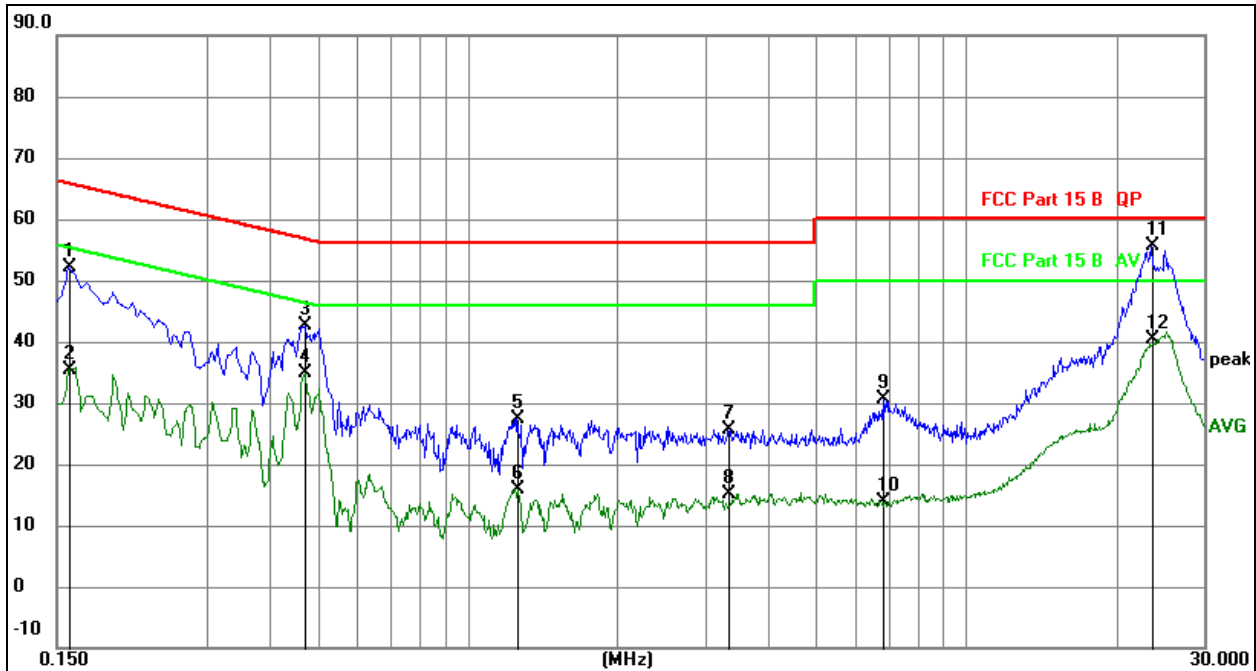

Remark:

1. All readings are Quasi-Peak and Average values.
2. Factor = Insertion Loss + Cable Loss.
3. Measurement=Reading Level+ Correct Factor
4. Over= Measurement-Limit

No.	Mk.	Freq. MHz	Reading Level	Correct Factor dB	Measure- ment dBuV	Limit dBuV	Over dB	Detector
1		0.1582	32.32	19.75	52.07	65.56	-13.49	QP
2		0.1582	15.70	19.75	35.45	55.56	-20.11	AVG
3		0.4736	22.89	19.84	42.73	56.45	-13.72	QP
4		0.4736	15.03	19.84	34.87	46.45	-11.58	AVG
5		1.2555	7.41	19.95	27.36	56.00	-28.64	QP
6		1.2555	-4.05	19.95	15.90	46.00	-30.10	AVG
7		3.3281	5.11	20.42	25.53	56.00	-30.47	QP
8		3.3281	-5.23	20.42	15.19	46.00	-30.81	AVG
9		6.8051	10.73	20.01	30.74	60.00	-29.26	QP
10		6.8051	-6.03	20.01	13.98	50.00	-36.02	AVG
11	*	23.6355	35.61	19.99	55.60	60.00	-4.40	QP
12		23.6355	20.30	19.99	40.29	50.00	-9.71	AVG

Temperature:	26 °C	Relative Humidity:	54%
Pressure:	101KPa	Phase :	N
Test Mode:	Mode 1	Test Voltage :	AC120V/60Hz

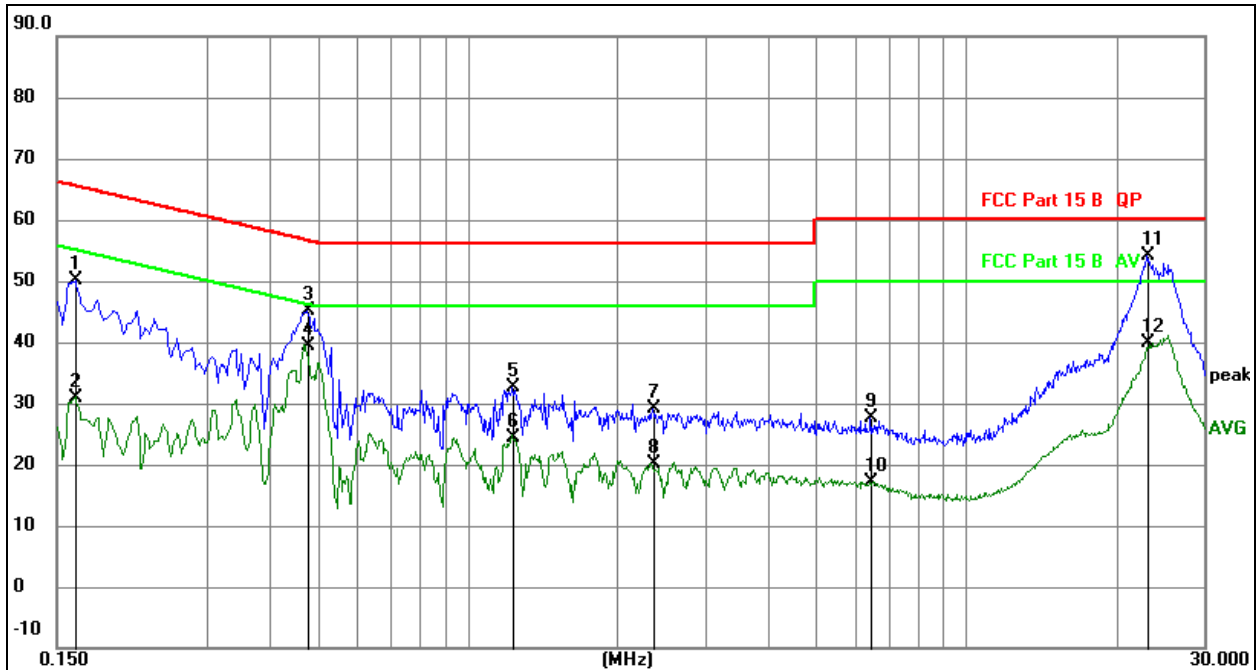
Remark:

1. All readings are Quasi-Peak and Average values.
2. Factor = Insertion Loss + Cable Loss.
3. Measurement=Reading Level+ Correct Factor
4. Over=Measurement-Limit

No.	Mk.	Freq. MHz	Reading Level	Correct Factor dB	Measure- ment dBuV	Limit dBuV	Over dB	Detector
1		0.1635	30.25	19.76	50.01	65.28	-15.27	QP
2		0.1635	11.24	19.76	31.00	55.28	-24.28	AVG
3		0.4785	25.32	19.84	45.16	56.37	-11.21	QP
4		0.4785	19.66	19.84	39.50	46.37	-6.87	AVG
5		1.2300	12.70	19.95	32.65	56.00	-23.35	QP
6		1.2300	4.47	19.95	24.42	46.00	-21.58	AVG
7		2.3460	9.16	20.07	29.23	56.00	-26.77	QP
8		2.3460	0.04	20.07	20.11	46.00	-25.89	AVG
9		6.4455	7.55	20.09	27.64	60.00	-32.36	QP
10		6.4455	-2.98	20.09	17.11	50.00	-32.89	AVG
11	*	23.0910	34.03	19.99	54.02	60.00	-5.98	QP
12		23.0910	20.00	19.99	39.99	50.00	-10.01	AVG

7. Radiated Emissions

7.1 Block Diagram Of Test Setup

(A) Radiated Emission Test-Up Frequency Below 30MHz

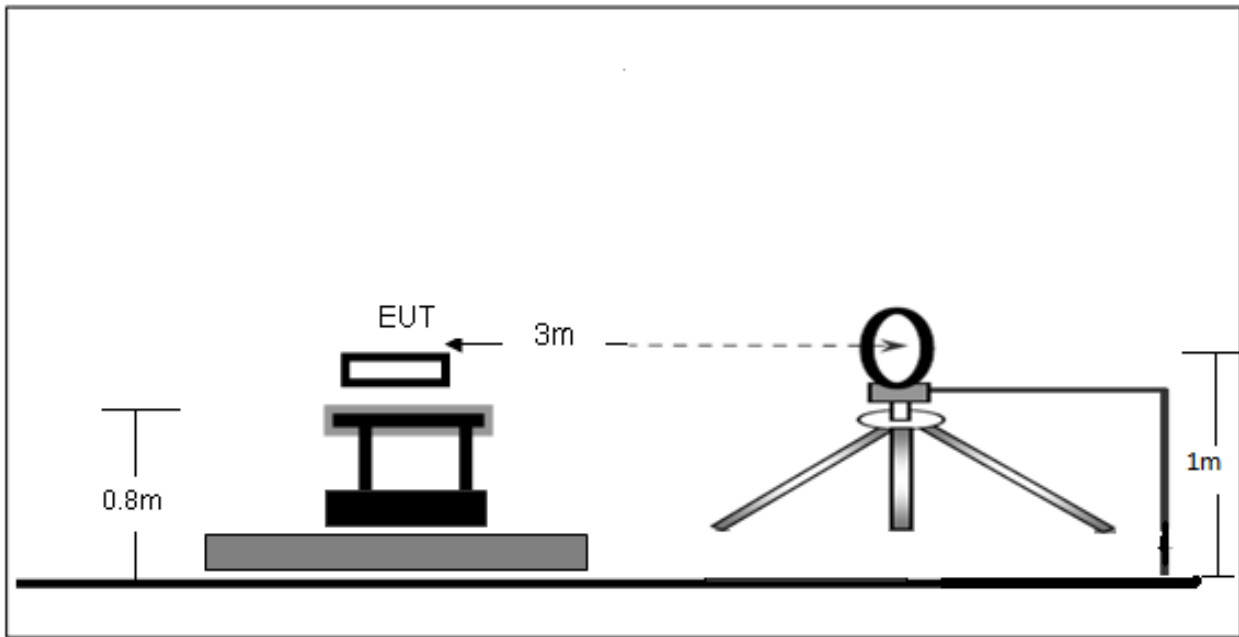

(B) Radiated Emission Test-Up Frequency 30MHz~1GHz

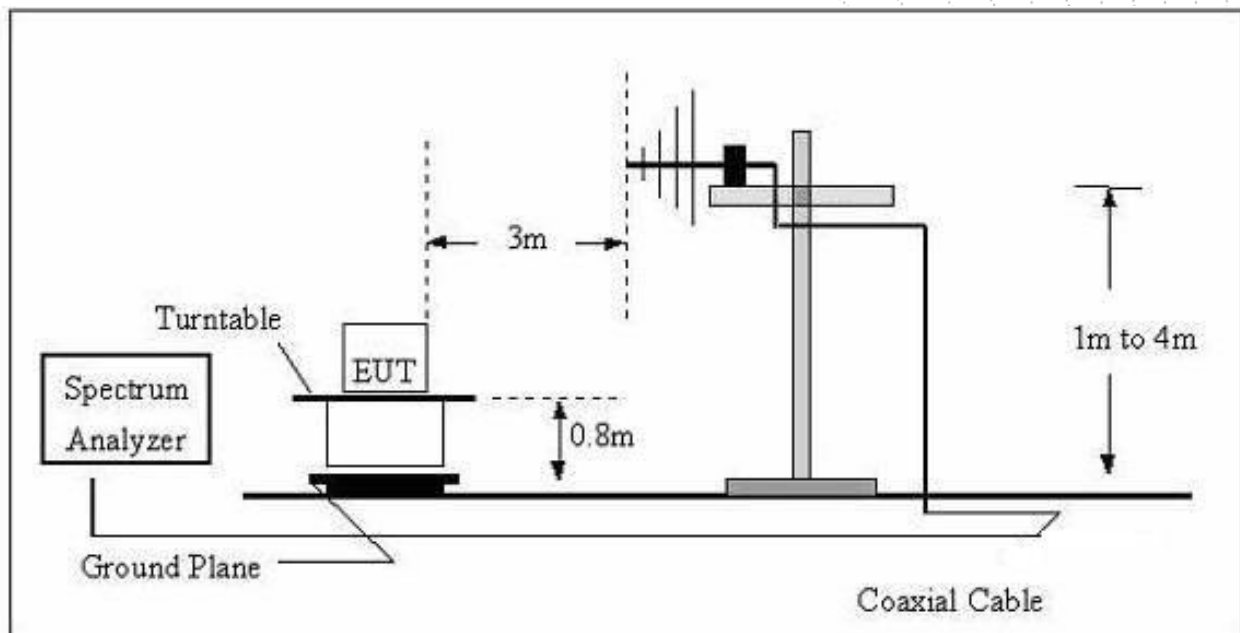

(C) Radiated Emission Test-Up Frequency Above 1GHz

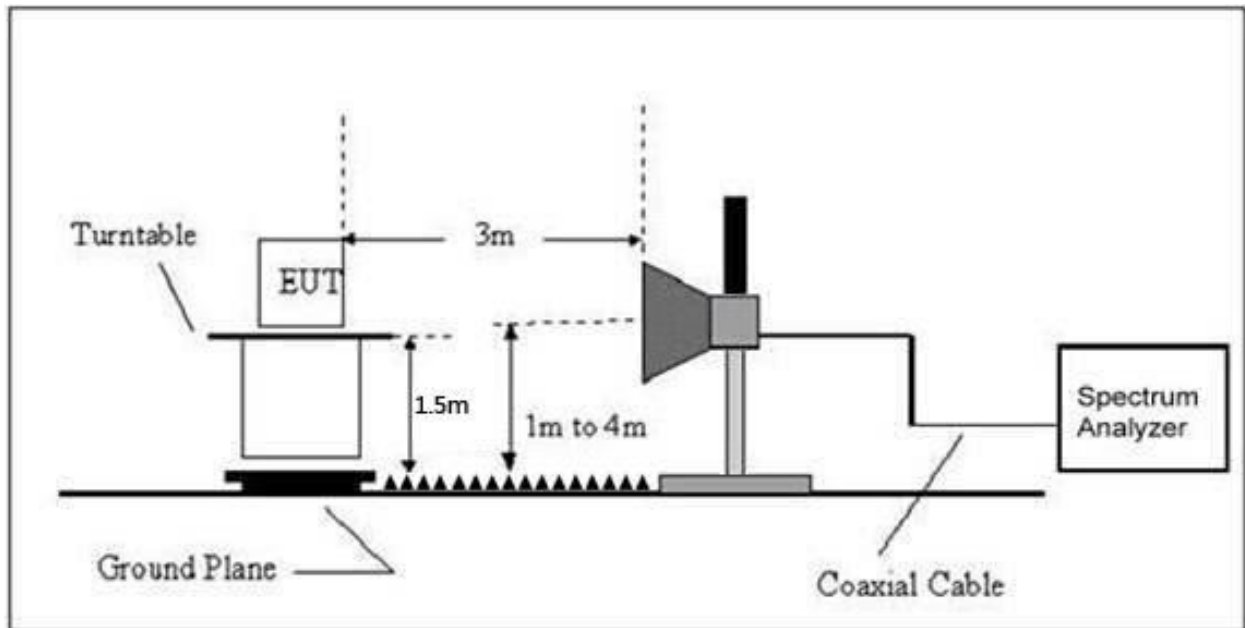

7.2 Limit

20dBc in any 100 kHz bandwidth outside the operating frequency band. In case the emission fall within the restricted band specified on 15.205(a), then the 15.209(a) limit in the table below has to be followed.

Frequency (MHz)	Field Strength uV/m	Distance (m)	Field Strength Limit at 3m Distance	
			uV/m	dBuV/m
0.009 ~ 0.490	2400/F(kHz)	300	10000 * 2400/F(kHz)	$20\log^{(2400/F(kHz))} + 80$
0.490 ~ 1.705	24000/F(kHz)	30	100 * 24000/F(kHz)	$20\log^{(24000/F(kHz))} + 40$
1.705 ~ 30	30	30	100 * 30	$20\log^{(30)} + 40$
30 ~ 88	100	3	100	$20\log^{(100)}$
88 ~ 216	150	3	150	$20\log^{(150)}$
216 ~ 960	200	3	200	$20\log^{(200)}$
Above 960	500	3	500	$20\log^{(500)}$

Limits Of Radiated Emission Measurement (Above 1000MHz)

Frequency (MHz)	Limit (dBuV/m) (at 3M)	
	Peak	Average
Above 1000	74	54

Notes:

- (1)The limit for radiated test was performed according to FCC PART 15C.
- (2)The tighter limit applies at the band edges.
- (3) Emission level (dBuV/m)=20log Emission level (uV/m).

7.3 Test Procedure

The test site semi-anechoic chamber has met the requirement of NSA tolerance 4 dB according to the standards: ANSI C63.10-2013. The test distance is 3m. The setup is according to the requirements in Section 13.1.4.1 of ANSI C63.10-2013 and CAN/CSA-CEI/IEC CISPR 22.

This test is required for any spurious emission that falls in a Restricted Band, as defined in Section 15.205.

It must be performed with the highest gain of each type of antenna proposed for use with the EUT. Use the following spectrum analyzer settings:

Spectrum Parameter	Setting
Attenuation	Auto
Start Frequency	1000 MHz
Stop Frequency	10th carrier harmonic
RB / VB (emission in restricted band)	1 MHz / 1 MHz for Peak, 1 MHz / 10Hz for Average

Receiver Parameter	Setting
Attenuation	Auto
Start ~ Stop Frequency	9kHz~150kHz / RB 200Hz for QP
Start ~ Stop Frequency	150kHz~30MHz / RB 9kHz for QP
Start ~ Stop Frequency	30MHz~1000MHz / RB 120kHz for QP

- The measuring distance of at 3 m shall be used for measurements at frequency up to 1GHz. For frequencies above 1GHz, any suitable measuring distance may be used.
- The EUT was placed on the top of a rotating table 0.8 m for below 1GHz and 1.5m for above 1GHz the ground at a 3 meter. The table was rotated 360 degrees to determine the position of the highest radiation.
- The height of the equipment or of the substitution antenna shall be 0.8 m for below 1GHz and 1.5m for above 1GHz; the height of the test antenna shall vary between 1 m to 4 m. Both horizontal and vertical polarizations of the antenna are set to make the measurement.
- The initial step in collecting conducted emission data is a spectrum analyzer peak detector mode pre-scanning the measurement frequency range. Significant peaks are then marked and then Quasi Peak detector mode re-measured.
- If the Peak Mode measured value compliance with and lower than Quasi Peak Mode Limit, the EUT shall be deemed to meet QP Limits and then no additional QP Mode measurement performed.
- For the actual test configuration, please refer to the related Item –EUT Test Photos.

Note:

Both horizontal and vertical antenna polarities were tested and performed pretest to three orthogonal axis. The worst case emissions were reported

During the radiated emission test, the Spectrum Analyzer was set with the following configurations:

Frequency Band (MHz)	Function	Resolution bandwidth	Video Bandwidth
30 to 1000	QP	120 kHz	300 kHz
Above 1000	Peak	1 MHz	1 MHz
	Average	1 MHz	10 Hz

Note: for the frequency ranges below 30 MHz, a narrower RBW is used for these ranges but the measured value should add a RBW correction factor (RBWCF) where $RBWCF [dB] = 10 \cdot \lg(100 [kHz] / \text{narrower RBW [kHz]})$. , the narrower RBW is 1 kHz and RBWCF is 20 dB for the frequency 9 kHz to 150 kHz, and the narrower RBW is 10 kHz and RBWCF is 10 dB for the frequency 150 kHz to 30 MHz.

7.4 EUT Operating Conditions

The EUT was configured for testing in a typical fashion (as a customer would normally use it). The EUT has been programmed to continuously transmit during test. This operating condition was tested and used to collect the included data.

7.5 Test Result

Below 30MHz

Temperature:	26°C	Relative Humidity:	24%
Pressure:	101 kPa	Test Voltage:	AC120V/60Hz
Test Mode:	Mode 1	Polarization:	--

Freq. (MHz)	Reading (dBuV/m)	Limit (dBuV/m)	Margin (dB)	State P/F
--	--	--	--	PASS
--	--	--	--	PASS

Note:

The amplitude of spurious emissions which are attenuated by more than 20dB below the permissible value has no need to be reported.

Distance extrapolation factor = $40 \log(\text{specific distance/test distance})(\text{dB})$;

Limit line = specific limits(dBuv) + distance extrapolation factor.

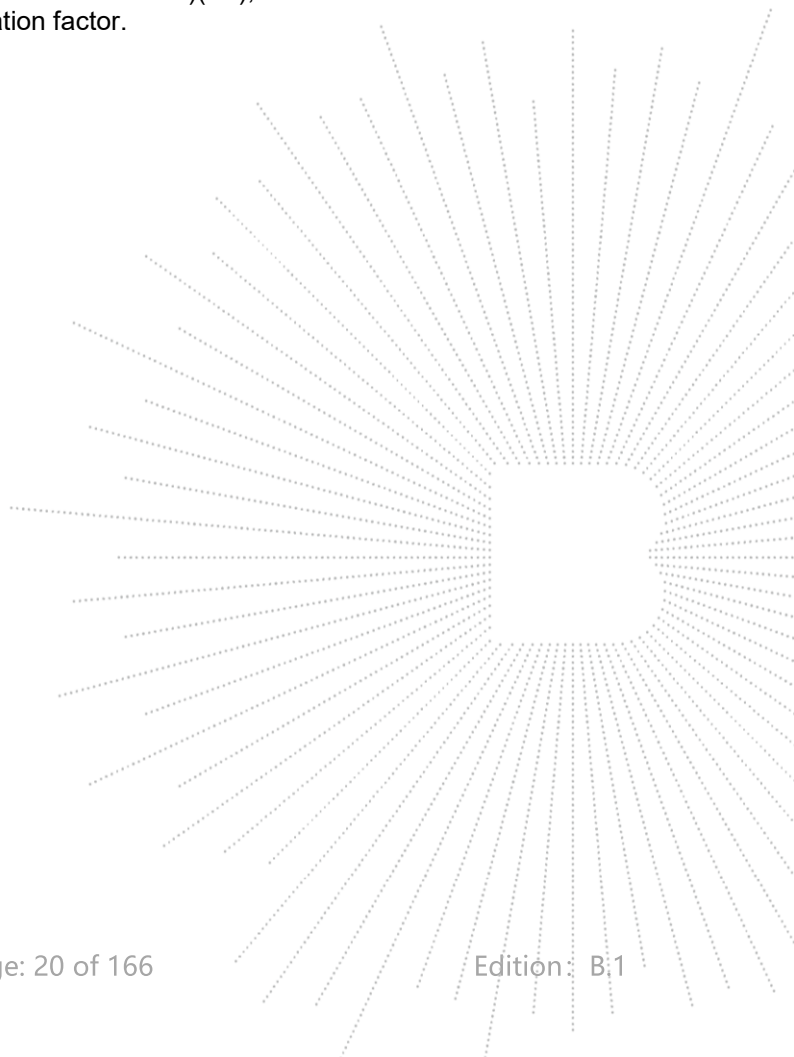

Between 30MHz – 1GHz

Temperature:	26 °C	Relative Humidity:	54%
Pressure:	101KPa	Phase :	Horizontal
Test Mode:	Mode 1	Test Voltage :	AC120V/60Hz

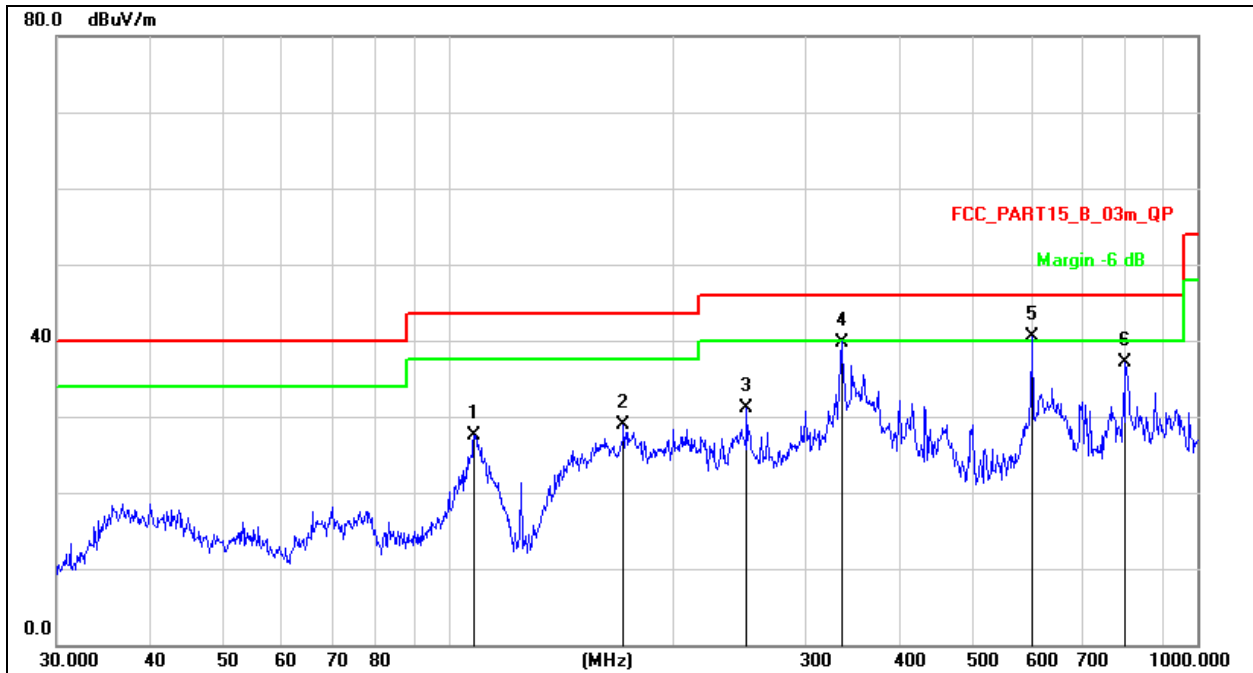

Remark:

1. Factor = Antenna Factor + Cable Loss – Pre-amplifier.
2. Measurement=Reading Level+ Correct Factor
3. Over= Measurement-Limit

No.	Mk.	Freq. MHz	Reading Level dBuV	Correct Factor dB	Measure- ment dBuV/m	Limit dB/m	Over dB	Detector
1		108.2667	44.10	-16.51	27.59	43.50	-15.91	QP
2		171.3926	46.74	-17.84	28.90	43.50	-14.60	QP
3		250.3012	45.31	-14.28	31.03	46.00	-14.97	QP
4		334.8589	51.81	-12.01	39.80	46.00	-6.20	QP
5	*	601.4265	47.51	-7.00	40.51	46.00	-5.49	QP
6		801.7863	41.39	-4.38	37.01	46.00	-8.99	QP

Temperature:	26 °C	Relative Humidity:	54%
Pressure:	101KPa	Phase :	Vertical
Test Mode:	Mode 1	Test Voltage :	AC120V/60Hz

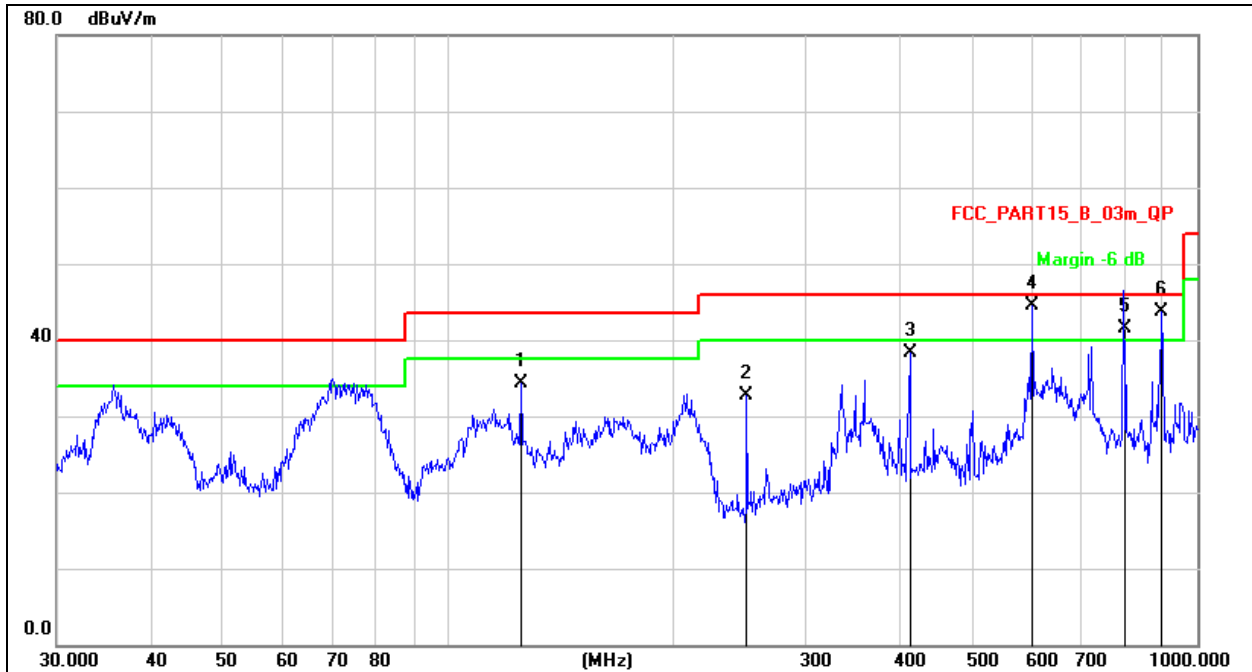

Remark:

1. Factor = Antenna Factor + Cable Loss – Pre-amplifier.
2. Measurement=Reading Level+ Correct Factor
3. Over= Measurement-Limit

No.	Mk.	Freq. MHz	Reading Level dBuV	Correct Factor dB	Measure- ment dBuV/m	Limit dB/m	Over dB	Detector
1		125.0066	52.07	-17.68	34.39	43.50	-9.11	QP
2		250.3011	46.99	-14.28	32.71	46.00	-13.29	QP
3		413.2706	48.82	-10.58	38.24	46.00	-7.76	QP
4	*	601.4265	51.47	-7.00	44.47	46.00	-1.53	QP
5	!	799.9790	45.90	-4.40	41.50	46.00	-4.50	QP
6	!	896.9965	46.81	-3.17	43.64	46.00	-2.36	QP

Between 1GHz – 40GHz

Test Mode:	TX(5.1G) - 802.11a
------------	--------------------

Polar	Frequency	Reading Level	Correct Factor	Measurement	Limits	Over	Detector Type
(H/V)	(MHz)	(dBuV/m)	(dB)	(dBuV/m)	(dBuV/m)	(dB)	
Low Channel (5180 MHz)-Above 1G							
Vertical	4434.10	73.99	-20.73	53.26	68.20	-14.94	PK
Vertical	4434.10	59.67	-20.73	38.94	54.00	-15.06	AV
Vertical	10360.10	62.30	-9.36	52.94	68.20	-15.26	PK
Vertical	10360.10	49.75	-9.36	40.39	54.00	-13.61	AV
Vertical	15540.03	60.64	-7.84	52.80	74.00	-21.20	PK
Vertical	15540.03	49.06	-7.84	41.22	54.00	-12.78	AV
Horizontal	4434.04	71.17	-20.73	50.44	68.20	-17.76	PK
Horizontal	4434.04	59.93	-20.73	39.20	54.00	-14.80	AV
Horizontal	10360.11	63.63	-9.36	54.27	68.20	-13.93	PK
Horizontal	10360.11	49.78	-9.36	40.42	54.00	-13.58	AV
Horizontal	15540.07	60.10	-7.84	52.26	74.00	-21.74	PK
Horizontal	15540.07	50.00	-7.84	42.16	54.00	-11.84	AV
Middle Channel (5200 MHz)-Above 1G							
Vertical	4592.04	72.90	-20.42	52.49	74.00	-21.51	PK
Vertical	4592.04	59.62	-20.42	39.20	54.00	-14.80	AV
Vertical	10400.10	60.32	-9.30	51.02	68.20	-17.18	PK
Vertical	10400.10	49.20	-9.30	39.90	54.00	-14.10	AV
Vertical	15600.18	61.33	-7.82	53.51	74.00	-20.49	PK
Vertical	15600.18	49.98	-7.82	42.16	54.00	-11.84	AV
Horizontal	4592.07	73.52	-20.42	53.10	74.00	-20.90	PK
Horizontal	4592.07	59.17	-20.42	38.76	54.00	-15.24	AV
Horizontal	10400.11	61.05	-9.30	51.75	68.20	-16.45	PK
Horizontal	10400.11	49.42	-9.30	40.12	54.00	-13.88	AV
Horizontal	15600.11	64.71	-7.82	56.89	74.00	-17.11	PK
Horizontal	15600.11	49.73	-7.82	41.91	54.00	-12.09	AV
High Channel (5240 MHz)-Above 1G							
Vertical	4739.15	71.20	-20.12	51.08	74.00	-22.92	PK
Vertical	4739.15	59.27	-20.12	39.15	54.00	-14.85	AV
Vertical	10480.13	62.20	-9.18	53.02	68.20	-15.18	PK
Vertical	10480.13	49.09	-9.18	39.91	54.00	-14.09	AV
Vertical	15720.14	62.17	-7.78	54.39	74.00	-19.61	PK
Vertical	15720.14	49.05	-7.78	41.27	54.00	-12.73	AV
Horizontal	4739.05	72.27	-20.12	52.14	74.00	-21.86	PK
Horizontal	4739.05	59.09	-20.12	38.97	54.00	-15.03	AV
Horizontal	10480.17	61.71	-9.18	52.53	68.20	-15.67	PK
Horizontal	10480.17	49.44	-9.18	40.26	54.00	-13.74	AV
Horizontal	15720.04	60.85	-7.78	53.07	74.00	-20.93	PK
Horizontal	15720.04	49.97	-7.78	42.19	54.00	-11.81	AV

Note: PK value is lower than the Average value limit, So average didn't record.
 The 26.5-40G amplitude of spurious emissions that are attenuated by more than 20dB below the permissible value has no need to be reported.
 Emission level (dBuV/m) = 20 log Emission level (uV/m).
 Corrected Reading: Antenna Factor + Cable Loss + Read Level - Preamp Factor = Level.
 The worst case is Antenna A.

Test Mode:	TX(5.1G) - 802.11n-HT20
------------	-------------------------

Polar	Frequency	Reading Level	Correct Factor	Measurement	Limits	Over	Detector Type
(H/V)	(MHz)	(dBuV/m)	(dB)	(dBuV/m)	(dBuV/m)	(dB)	
Low Channel (5180 MHz)-Above 1G							
Vertical	4434.10	71.55	-20.73	50.82	68.20	-17.38	PK
Vertical	4434.10	59.79	-20.73	39.06	54.00	-14.94	AV
Vertical	10360.02	62.53	-9.36	53.17	68.20	-15.03	PK
Vertical	10360.02	49.61	-9.36	40.25	54.00	-13.75	AV
Vertical	15540.16	62.42	-7.84	54.58	74.00	-19.42	PK
Vertical	15540.16	49.98	-7.84	42.14	54.00	-11.86	AV
Horizontal	4434.05	71.84	-20.73	51.10	68.20	-17.10	PK
Horizontal	4434.05	59.67	-20.73	38.94	54.00	-15.06	AV
Horizontal	10360.17	60.19	-9.36	50.83	68.20	-17.37	PK
Horizontal	10360.17	49.04	-9.36	39.68	54.00	-14.32	AV
Horizontal	15540.15	64.61	-7.84	56.77	74.00	-17.23	PK
Horizontal	15540.15	49.91	-7.84	42.07	54.00	-11.93	AV
Middle Channel (5200 MHz)-Above 1G							
Vertical	4592.14	73.87	-20.42	53.45	74.00	-20.55	PK
Vertical	4592.14	59.86	-20.42	39.44	54.00	-14.56	AV
Vertical	10400.17	63.19	-9.30	53.89	68.20	-14.31	PK
Vertical	10400.17	49.77	-9.30	40.47	54.00	-13.53	AV
Vertical	15600.11	63.67	-7.82	55.85	74.00	-18.15	PK
Vertical	15600.11	49.55	-7.82	41.73	54.00	-12.27	AV
Horizontal	4592.16	74.29	-20.42	53.87	74.00	-20.13	PK
Horizontal	4592.16	59.86	-20.42	39.45	54.00	-14.55	AV
Horizontal	10400.16	62.44	-9.30	53.14	68.20	-15.06	PK
Horizontal	10400.16	49.75	-9.30	40.45	54.00	-13.55	AV
Horizontal	15600.05	61.83	-7.82	54.01	74.00	-19.99	PK
Horizontal	15600.05	49.01	-7.82	41.19	54.00	-12.81	AV
High Channel (5240 MHz)-Above 1G							
Vertical	4739.04	71.21	-20.12	51.09	74.00	-22.91	PK
Vertical	4739.04	59.74	-20.12	39.62	54.00	-14.38	AV
Vertical	10480.07	61.21	-9.18	52.03	68.20	-16.17	PK
Vertical	10480.07	49.19	-9.18	40.01	54.00	-13.99	AV
Vertical	15720.09	64.57	-7.78	56.79	74.00	-17.21	PK
Vertical	15720.09	49.20	-7.78	41.42	54.00	-12.58	AV
Horizontal	4739.15	72.03	-20.12	51.90	74.00	-22.10	PK
Horizontal	4739.15	59.75	-20.12	39.63	54.00	-14.37	AV
Horizontal	10480.01	60.25	-9.18	51.07	68.20	-17.13	PK
Horizontal	10480.01	49.27	-9.18	40.09	54.00	-13.91	AV
Horizontal	15720.11	64.94	-7.78	57.16	74.00	-16.84	PK
Horizontal	15720.11	49.98	-7.78	42.20	54.00	-11.80	AV

Note: PK value is lower than the Average value limit, So average didn't record.
 The 26.5-40G amplitude of spurious emissions that are attenuated by more than 20dB below the permissible value has no need to be reported.
 Emission level (dBuV/m) = 20 log Emission level (uV/m).
 Corrected Reading: Antenna Factor + Cable Loss + Read Level - Preamp Factor = Level.
 Test Mode is MIMO Mode.

Test Mode:	TX(5.1G) - 802.11n-HT40
------------	-------------------------

Polar (H/V)	Frequency (MHz)	Reading Level (dBuV/m)	Correct Factor (dB)	Measurement (dBuV/m)	Limits (dBuV/m)	Over (dB)	Detector Type
Low Channel (5190 MHz)-Above 1G							
Vertical	4434.17	70.90	-20.73	50.17	68.20	-18.03	PK
Vertical	4434.17	59.74	-20.73	39.01	54.00	-14.99	AV
Vertical	10380.18	63.09	-9.33	53.76	68.20	-14.44	PK
Vertical	10380.18	49.28	-9.33	39.95	54.00	-14.05	AV
Vertical	15570.17	60.97	-7.83	53.14	74.00	-20.86	PK
Vertical	15570.17	49.80	-7.83	41.97	54.00	-12.03	AV
Horizontal	4434.11	71.66	-20.73	50.92	74.00	-23.08	PK
Horizontal	4434.11	59.05	-20.73	38.32	54.00	-15.68	AV
Horizontal	10380.07	63.91	-9.33	54.58	68.20	-13.62	PK
Horizontal	10380.07	49.92	-9.33	40.59	54.00	-13.41	AV
Horizontal	15570.12	60.53	-7.83	52.70	74.00	-21.30	PK
Horizontal	15570.12	49.05	-7.83	41.22	54.00	-12.78	AV
Middle Channel (5230 MHz)-Above 1G							
Vertical	4739.08	70.45	-20.12	50.33	68.20	-17.87	PK
Vertical	4739.08	59.92	-20.12	39.80	54.00	-14.20	AV
Vertical	10460.09	64.26	-9.21	55.05	68.20	-13.15	PK
Vertical	10460.09	49.19	-9.21	39.98	54.00	-14.02	AV
Vertical	15690.10	61.40	-7.79	53.61	74.00	-20.39	PK
Vertical	15690.10	49.01	-7.79	41.22	54.00	-12.78	AV
Horizontal	4739.02	74.55	-20.12	54.43	68.20	-13.77	PK
Horizontal	4739.02	59.07	-20.12	38.94	54.00	-15.06	AV
Horizontal	10460.20	61.53	-9.21	52.32	68.20	-15.88	PK
Horizontal	10460.20	49.20	-9.21	39.99	54.00	-14.01	AV
Horizontal	15690.11	64.55	-7.79	56.76	74.00	-17.24	PK
Horizontal	15690.11	49.69	-7.79	41.90	54.00	-12.10	AV

Note: PK value is lower than the Average value limit, So average didn't record.

The 26.5-40G amplitude of spurious emissions that are attenuated by more than 20dB below the permissible value has no need to be reported.

Emission level (dBuV/m) = 20 log Emission level (uV/m).

Corrected Reading: Antenna Factor + Cable Loss + Read Level - Preamp Factor = Level.

Test Mode is MIMO Mode.

Test Mode:	TX(5.1G) - 802.11ac-HT20
------------	--------------------------

Polar (H/V)	Frequency (MHz)	Reading Level (dBuV/m)	Correct Factor (dB)	Measurement (dBuV/m)	Limits (dBuV/m)	Over (dB)	Detector Type
Low Channel (5180 MHz)-Above 1G							
Vertical	4434.15	74.62	-20.73	53.89	68.20	-14.31	PK
Vertical	4434.15	59.94	-20.73	39.21	54.00	-14.79	AV
Vertical	10360.08	62.10	-9.36	52.74	68.20	-15.46	PK
Vertical	10360.08	49.81	-9.36	40.45	54.00	-13.55	AV
Vertical	15540.05	62.65	-7.84	54.81	74.00	-19.19	PK
Vertical	15540.05	49.62	-7.84	41.78	54.00	-12.22	AV
Horizontal	4434.09	74.21	-20.73	53.48	68.20	-14.72	PK
Horizontal	4434.09	59.88	-20.73	39.15	54.00	-14.85	AV
Horizontal	10360.16	62.16	-9.36	52.80	68.20	-15.40	PK
Horizontal	10360.16	49.35	-9.36	39.99	54.00	-14.01	AV
Horizontal	15540.12	61.94	-7.84	54.10	74.00	-19.90	PK
Horizontal	15540.12	49.72	-7.84	41.88	54.00	-12.12	AV
Middle Channel (5200 MHz)-Above 1G							
Vertical	4592.11	74.11	-20.42	53.70	74.00	-20.30	PK
Vertical	4592.11	59.58	-20.42	39.16	54.00	-14.84	AV
Vertical	10400.15	64.30	-9.30	55.00	68.20	-13.20	PK
Vertical	10400.15	49.86	-9.30	40.56	54.00	-13.44	AV
Vertical	15600.15	63.44	-7.82	55.62	74.00	-18.38	PK
Vertical	15600.15	49.46	-7.82	41.64	54.00	-12.36	AV
Horizontal	4592.12	72.72	-20.42	52.31	74.00	-21.69	PK
Horizontal	4592.12	59.20	-20.42	38.79	54.00	-15.21	AV
Horizontal	10400.14	63.31	-9.30	54.01	68.20	-14.19	PK
Horizontal	10400.14	49.34	-9.30	40.04	54.00	-13.96	AV
Horizontal	15600.01	61.41	-7.82	53.59	74.00	-20.41	PK
Horizontal	15600.01	49.69	-7.82	41.87	54.00	-12.13	AV
High Channel (5240 MHz)-Above 1G							
Vertical	4739.19	70.13	-20.12	50.01	74.00	-23.99	PK
Vertical	4739.19	59.67	-20.12	39.54	54.00	-14.46	AV
Vertical	10480.16	62.16	-9.18	52.98	68.20	-15.22	PK
Vertical	10480.16	49.70	-9.18	40.52	54.00	-13.48	AV
Vertical	15720.17	62.19	-7.78	54.41	74.00	-19.59	PK
Vertical	15720.17	49.13	-7.78	41.35	54.00	-12.65	AV
Horizontal	4739.08	71.00	-20.12	50.88	74.00	-23.12	PK
Horizontal	4739.08	59.35	-20.12	39.22	54.00	-14.78	AV
Horizontal	10480.15	64.73	-9.18	55.55	68.20	-12.65	PK
Horizontal	10480.15	49.83	-9.18	40.65	54.00	-13.35	AV
Horizontal	15720.04	64.21	-7.78	56.43	74.00	-17.57	PK
Horizontal	15720.04	49.78	-7.78	42.00	54.00	-12.00	AV

Note: PK value is lower than the Average value limit, So average didn't record.
 The 26.5-40G amplitude of spurious emissions that are attenuated by more than 20dB below the permissible value has no need to be reported.
 Emission level (dBuV/m) = 20 log Emission level (uV/m).
 Corrected Reading: Antenna Factor + Cable Loss + Read Level - Preamp Factor = Level.
 Test Mode is MIMO Mode.

Test Mode:	TX(5.1G) - 802.11ac-HT40
------------	--------------------------

Polar (H/V)	Frequency (MHz)	Reading Level (dBuV/m)	Correct Factor (dB)	Measurement (dBuV/m)	Limits (dBuV/m)	Over (dB)	Detector Type
Low Channel (5190 MHz)-Above 1G							
Vertical	4434.05	71.89	-20.73	51.16	68.20	-17.04	PK
Vertical	4434.05	59.53	-20.73	38.80	54.00	-15.20	AV
Vertical	10380.09	60.38	-9.33	51.05	68.20	-17.15	PK
Vertical	10380.09	49.03	-9.33	39.70	54.00	-14.30	AV
Vertical	15570.15	62.87	-7.83	55.04	74.00	-18.96	PK
Vertical	15570.15	49.05	-7.83	41.22	54.00	-12.78	AV
Horizontal	4434.02	70.16	-20.73	49.43	74.00	-24.57	PK
Horizontal	4434.02	59.14	-20.73	38.41	54.00	-15.59	AV
Horizontal	10380.07	61.73	-9.33	52.40	68.20	-15.80	PK
Horizontal	10380.07	49.92	-9.33	40.59	54.00	-13.41	AV
Horizontal	15570.18	63.08	-7.83	55.25	74.00	-18.75	PK
Horizontal	15570.18	49.37	-7.83	41.54	54.00	-12.46	AV
Middle Channel (5230 MHz)-Above 1G							
Vertical	4739.10	73.23	-20.12	53.11	68.20	-15.09	PK
Vertical	4739.10	59.99	-20.12	39.86	54.00	-14.14	AV
Vertical	10460.04	64.61	-9.21	55.40	68.20	-12.80	PK
Vertical	10460.04	49.38	-9.21	40.17	54.00	-13.83	AV
Vertical	15690.12	61.02	-7.79	53.23	74.00	-20.77	PK
Vertical	15690.12	49.50	-7.79	41.71	54.00	-12.29	AV
Horizontal	4739.03	71.87	-20.12	51.75	68.20	-16.45	PK
Horizontal	4739.03	59.20	-20.12	39.08	54.00	-14.92	AV
Horizontal	10460.13	62.90	-9.21	53.69	68.20	-14.51	PK
Horizontal	10460.13	49.72	-9.21	40.51	54.00	-13.49	AV
Horizontal	15690.15	62.65	-7.79	54.86	74.00	-19.14	PK
Horizontal	15690.15	49.75	-7.79	41.96	54.00	-12.04	AV

Note: PK value is lower than the Average value limit, So average didn't record.

The 26.5-40G amplitude of spurious emissions that are attenuated by more than 20dB below the permissible value has no need to be reported.

Emission level (dBuV/m) = 20 log Emission level (uV/m).

Corrected Reading: Antenna Factor + Cable Loss + Read Level - Preamp Factor = Level.

Test Mode is MIMO Mode.

Test Mode:	TX(5.1G) - 802.11ac 80
------------	------------------------

Polar (H/V)	Frequency (MHz)	Reading Level (dBuV/m)	Correct Factor (dB)	Measurement (dBuV/m)	Limits (dBuV/m)	Over (dB)	Detector Type
Low Channel (5210 MHz)-Above 1G							
Vertical	4434.16	74.28	-20.73	53.55	68.20	-14.65	PK
Vertical	4434.16	59.99	-20.73	39.26	54.00	-14.74	AV
Vertical	10420.09	60.95	-9.27	51.68	68.20	-16.52	PK
Vertical	10420.09	49.48	-9.27	40.21	54.00	-13.79	AV
Vertical	15630.17	61.54	-7.81	53.73	74.00	-20.27	PK
Vertical	15630.17	49.18	-7.81	41.37	54.00	-12.63	AV
Horizontal	4434.02	74.44	-20.73	53.71	68.20	-14.49	PK
Horizontal	4434.02	49.52	-20.73	28.78	54.00	-25.22	AV
Horizontal	10420.03	42.16	9.27	51.43	68.20	-16.77	PK
Horizontal	10420.03	29.38	9.27	38.65	54.00	-15.35	AV
Horizontal	15630.12	61.68	-7.81	53.87	74.00	-20.13	PK
Horizontal	15630.12	49.07	-7.81	41.26	54.00	-12.74	AV

Note: PK value is lower than the Average value limit, So average didn't record.
 The 26.5-40G amplitude of spurious emissions that are attenuated by more than 20dB below the permissible value has no need to be reported.
 $\text{Emission level (dBuV/m)} = 20 \log \text{Emission level (uV/m)}$.
 Corrected Reading: Antenna Factor + Cable Loss + Read Level - Preamp Factor = Level.
 Test Mode is MIMO Mode.

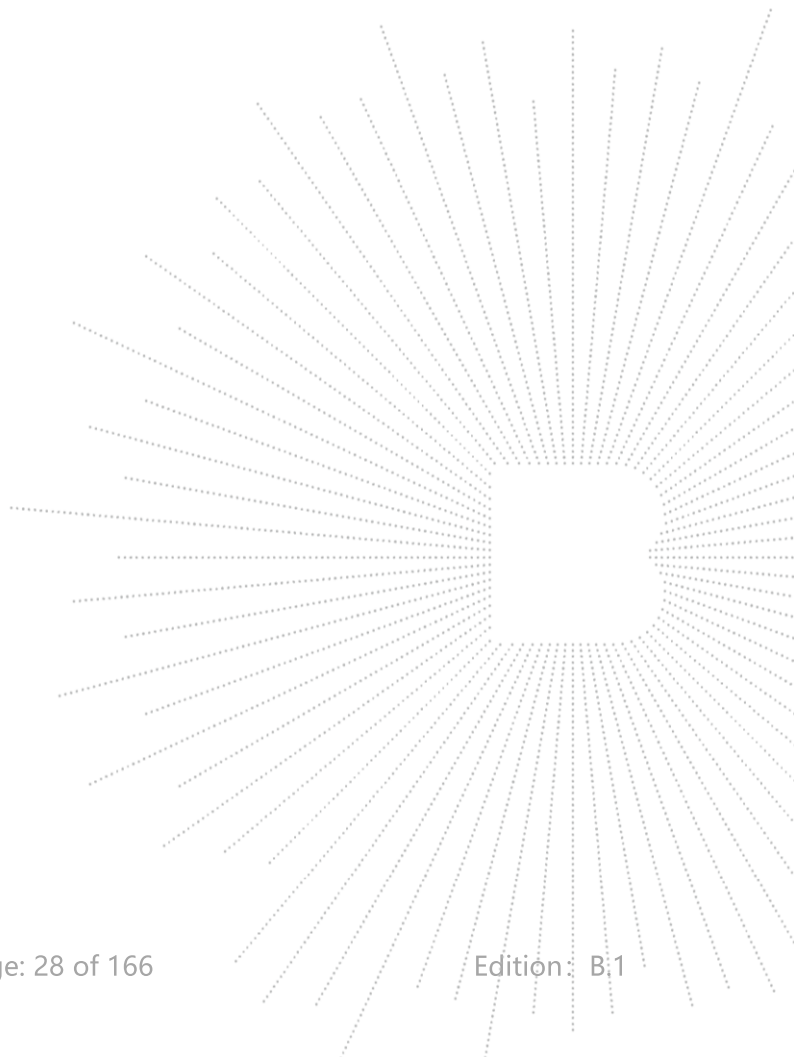

Test Mode:	TX(5.1G) - 802.11ax-HT20
------------	--------------------------

Polar	Frequency	Reading Level	Correct Factor	Measurement	Limits	Over	Detector Type
(H/V)	(MHz)	(dBuV/m)	(dB)	(dBuV/m)	(dBuV/m)	(dB)	
Low Channel (5180 MHz)-Above 1G							
Vertical	4434.06	72.71	-20.73	51.98	68.20	-16.22	PK
Vertical	4434.06	59.97	-20.73	39.24	54.00	-14.76	AV
Vertical	10360.20	62.06	-9.36	52.70	68.20	-15.50	PK
Vertical	10360.20	49.78	-9.36	40.42	54.00	-13.58	AV
Vertical	15540.09	64.28	-7.84	56.44	74.00	-17.56	PK
Vertical	15540.09	49.90	-7.84	42.06	54.00	-11.94	AV
Horizontal	4434.14	72.59	-20.73	51.86	68.20	-16.34	PK
Horizontal	4434.14	59.49	-20.73	38.76	54.00	-15.24	AV
Horizontal	10360.14	63.12	-9.36	53.76	68.20	-14.44	PK
Horizontal	10360.14	49.30	-9.36	39.94	54.00	-14.06	AV
Horizontal	15540.17	61.75	-7.84	53.91	74.00	-20.09	PK
Horizontal	15540.17	49.39	-7.84	41.55	54.00	-12.45	AV
Middle Channel (5200 MHz)-Above 1G							
Vertical	4592.17	73.18	-20.42	52.76	74.00	-21.24	PK
Vertical	4592.17	59.76	-20.42	39.34	54.00	-14.66	AV
Vertical	10400.11	64.30	-9.30	55.00	68.20	-13.20	PK
Vertical	10400.11	49.20	-9.30	39.90	54.00	-14.10	AV
Vertical	15600.03	60.42	-7.82	52.60	74.00	-21.40	PK
Vertical	15600.03	49.17	-7.82	41.35	54.00	-12.65	AV
Horizontal	4592.17	70.02	-20.42	49.61	74.00	-24.39	PK
Horizontal	4592.17	59.35	-20.42	38.93	54.00	-15.07	AV
Horizontal	10400.00	63.72	-9.30	54.42	68.20	-13.78	PK
Horizontal	10400.00	49.49	-9.30	40.19	54.00	-13.81	AV
Horizontal	15600.04	62.02	-7.82	54.20	74.00	-19.80	PK
Horizontal	15600.04	49.26	-7.82	41.44	54.00	-12.56	AV
High Channel (5240 MHz)-Above 1G							
Vertical	4739.18	74.65	-20.12	54.53	74.00	-19.47	PK
Vertical	4739.18	59.04	-20.12	38.92	54.00	-15.08	AV
Vertical	10480.08	62.45	-9.18	53.27	68.20	-14.93	PK
Vertical	10480.08	49.05	-9.18	39.87	54.00	-14.13	AV
Vertical	15720.01	64.91	-7.78	57.13	74.00	-16.87	PK
Vertical	15720.01	49.07	-7.78	41.29	54.00	-12.71	AV
Horizontal	4739.15	74.88	-20.12	54.76	74.00	-19.24	PK
Horizontal	4739.15	59.76	-20.12	39.63	54.00	-14.37	AV
Horizontal	10480.15	61.71	-9.18	52.53	68.20	-15.67	PK
Horizontal	10480.15	49.39	-9.18	40.21	54.00	-13.79	AV
Horizontal	15720.01	64.84	-7.78	57.06	74.00	-16.94	PK
Horizontal	15720.01	49.82	-7.78	42.04	54.00	-11.96	AV

Note: PK value is lower than the Average value limit, So average didn't record.

The 26.5-40G amplitude of spurious emissions that are attenuated by more than 20dB below the permissible value has no need to be reported.

Emission level (dBuV/m) = 20 log Emission level (uV/m).

Corrected Reading: Antenna Factor + Cable Loss + Read Level - Preamp Factor = Level.

Test Mode is MIMO Mode.

Test Mode:	TX(5.1G) - 802.11ax-HT40
------------	--------------------------

Polar (H/V)	Frequency (MHz)	Reading Level (dBuV/m)	Correct Factor (dB)	Measurement (dBuV/m)	Limits (dBuV/m)	Over (dB)	Detector Type
Low Channel (5190 MHz)-Above 1G							
Vertical	4434.18	73.58	-20.73	52.85	68.20	-15.35	PK
Vertical	4434.18	59.07	-20.73	38.34	54.00	-15.66	AV
Vertical	10380.15	64.63	-9.33	55.30	68.20	-12.90	PK
Vertical	10380.15	49.37	-9.33	40.04	54.00	-13.96	AV
Vertical	15570.06	61.37	-7.83	53.54	74.00	-20.46	PK
Vertical	15570.06	49.88	-7.83	42.05	54.00	-11.95	AV
Horizontal	4434.13	74.83	-20.73	54.10	74.00	-19.90	PK
Horizontal	4434.13	59.81	-20.73	39.08	54.00	-14.92	AV
Horizontal	10380.03	64.95	-9.33	55.62	68.20	-12.58	PK
Horizontal	10380.03	49.41	-9.33	40.08	54.00	-13.92	AV
Horizontal	15570.07	61.88	-7.83	54.05	74.00	-19.95	PK
Horizontal	15570.07	49.71	-7.83	41.88	54.00	-12.12	AV
Middle Channel (5230 MHz)-Above 1G							
Vertical	4739.19	74.23	-20.12	54.11	68.20	-14.09	PK
Vertical	4739.19	59.71	-20.12	39.58	54.00	-14.42	AV
Vertical	10460.07	62.29	-9.21	53.08	68.20	-15.12	PK
Vertical	10460.07	49.47	-9.21	40.26	54.00	-13.74	AV
Vertical	15690.01	64.92	-7.79	57.13	74.00	-16.87	PK
Vertical	15690.01	49.65	-7.79	41.86	54.00	-12.14	AV
Horizontal	4739.13	73.08	-20.12	52.95	68.20	-15.25	PK
Horizontal	4739.13	59.28	-20.12	39.15	54.00	-14.85	AV
Horizontal	10460.01	62.79	-9.21	53.58	68.20	-14.62	PK
Horizontal	10460.01	49.43	-9.21	40.22	54.00	-13.78	AV
Horizontal	15690.10	61.82	-7.79	54.03	74.00	-19.97	PK
Horizontal	15690.10	49.61	-7.79	41.82	54.00	-12.18	AV

Note: PK value is lower than the Average value limit, So average didn't record.

The 26.5-40G amplitude of spurious emissions that are attenuated by more than 20dB below the permissible value has no need to be reported.

Emission level (dBuV/m) = 20 log Emission level (uV/m).

Corrected Reading: Antenna Factor + Cable Loss + Read Level - Preamp Factor = Level.

Test Mode is MIMO Mode.

Test Mode:	TX(5.1G) - 802.11ax 80
------------	------------------------

Polar (H/V)	Frequency (MHz)	Reading Level (dBuV/m)	Correct Factor (dB)	Measurement (dBuV/m)	Limits (dBuV/m)	Over (dB)	Detector Type
Low Channel (5210 MHz)-Above 1G							
Vertical	4434.10	74.47	-20.73	53.74	68.20	-14.46	PK
Vertical	4434.10	59.53	-20.73	38.79	54.00	-15.21	AV
Vertical	10420.09	64.69	-9.27	55.42	68.20	-12.78	PK
Vertical	10420.09	49.34	-9.27	40.07	54.00	-13.93	AV
Vertical	15630.01	61.75	-7.81	53.94	74.00	-20.06	PK
Vertical	15630.01	49.73	-7.81	41.92	54.00	-12.08	AV
Horizontal	4434.13	73.64	-20.73	52.90	68.20	-15.30	PK
Horizontal	4434.13	49.66	-20.73	28.93	54.00	-25.07	AV
Horizontal	10420.11	43.96	9.27	53.23	68.20	-14.97	PK
Horizontal	10420.11	29.84	9.27	39.11	54.00	-14.89	AV
Horizontal	15630.10	61.17	-7.81	53.36	74.00	-20.64	PK
Horizontal	15630.10	49.29	-7.81	41.48	54.00	-12.52	AV

Note: PK value is lower than the Average value limit, So average didn't record.
 The 26.5-40G amplitude of spurious emissions that are attenuated by more than 20dB below the permissible value has no need to be reported.
 $\text{Emission level (dBuV/m)} = 20 \log \text{Emission level (uV/m)}$.
 Corrected Reading: Antenna Factor + Cable Loss + Read Level - Preamp Factor = Level.
 Test Mode is MIMO Mode.

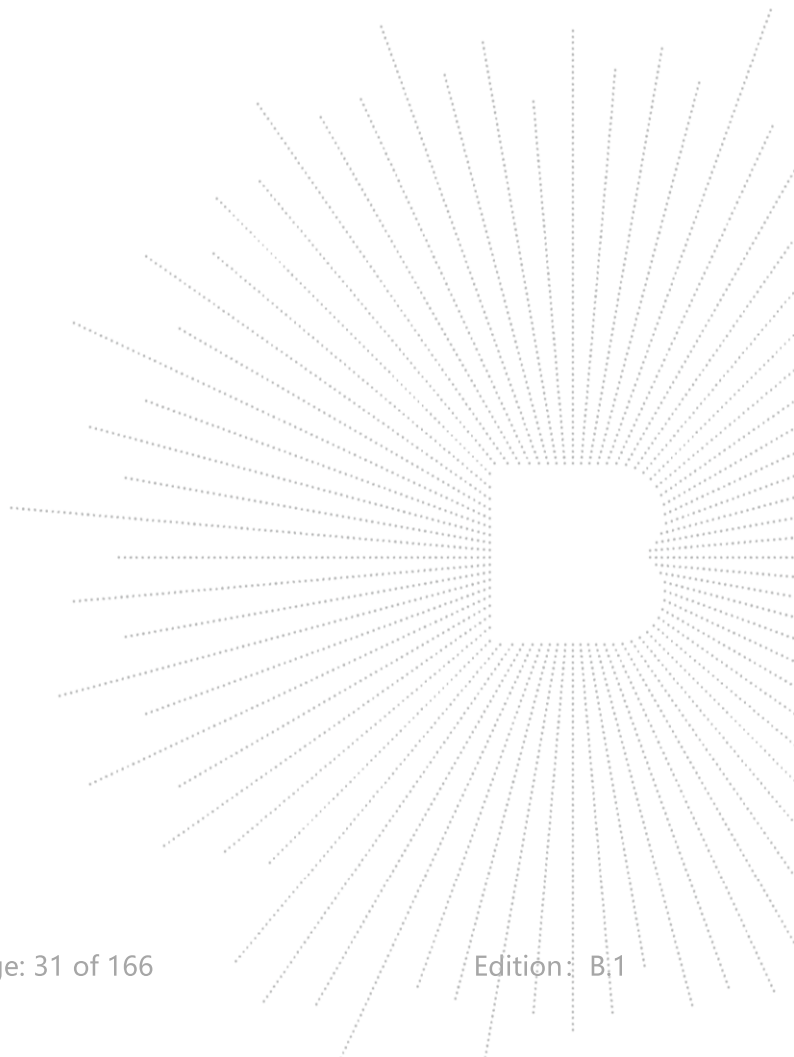

Test Mode:	TX (5.8G) -- 802.11a
------------	----------------------

Polar	Frequency	Reading Level	Correct Factor	Measurement	Limits	Over	Detector Type
(H/V)	(MHz)	(dBuV/m)	(dB)	(dBuV/m)	(dBuV/m)	(dB)	
Low Channel (5745 MHz)-Above 1G							
Vertical	4679.11	72.77	-20.24	52.53	74.00	-21.47	PK
Vertical	4679.11	59.92	-20.24	39.68	54.00	-14.32	AV
Vertical	11490.15	62.65	-8.79	53.86	68.20	-14.34	PK
Vertical	11490.15	49.24	-8.79	40.45	54.00	-13.55	AV
Vertical	17235.05	55.06	-3.18	51.88	68.20	-16.32	PK
Vertical	17235.05	44.76	-3.18	41.58	54.00	-12.42	AV
Horizontal	4679.06	73.88	-20.73	53.15	74.00	-20.85	PK
Horizontal	4679.06	59.96	-20.73	39.23	54.00	-14.77	AV
Horizontal	11490.06	60.66	-8.79	51.87	68.20	-16.33	PK
Horizontal	11490.06	49.30	-8.79	40.51	54.00	-13.49	AV
Horizontal	17235.13	57.57	-3.18	54.39	68.20	-13.81	PK
Horizontal	17235.13	44.12	-3.18	40.94	54.00	-13.06	AV
Middle Channel (5785 MHz)-Above 1G							
Vertical	4592.04	73.55	-20.42	53.13	74.00	-20.87	PK
Vertical	4592.04	59.89	-20.42	39.47	54.00	-14.53	AV
Vertical	11570.12	62.81	-8.86	53.95	68.20	-14.25	PK
Vertical	11570.12	49.53	-8.86	40.67	54.00	-13.33	AV
Vertical	17355.02	55.01	-2.52	52.49	68.20	-15.71	PK
Vertical	17355.02	44.90	-2.52	42.38	54.00	-11.62	AV
Horizontal	4592.16	70.86	-20.42	50.44	74.00	-23.56	PK
Horizontal	4592.16	59.61	-20.42	39.20	54.00	-14.80	AV
Horizontal	11570.17	61.77	-8.86	52.91	68.20	-15.29	PK
Horizontal	11570.17	49.81	-8.86	40.95	54.00	-13.05	AV
Horizontal	17355.20	55.01	-2.52	52.49	68.20	-15.71	PK
Horizontal	17355.20	44.37	-2.52	41.85	54.00	-12.15	AV
High Channel (5825 MHz)-Above 1G							
Vertical	6039.12	74.05	-18.93	55.12	68.20	-13.08	PK
Vertical	6039.12	59.15	-18.93	40.21	54.00	-13.79	AV
Vertical	11650.04	64.44	-8.92	55.52	74.00	-18.48	PK
Vertical	11650.04	49.91	-8.92	40.99	54.00	-13.01	AV
Vertical	17475.02	58.45	-1.86	56.59	68.20	-11.61	PK
Vertical	17475.02	44.36	-1.86	42.50	54.00	-11.50	AV
Horizontal	6039.19	72.13	-18.93	53.19	68.20	-15.01	PK
Horizontal	6039.19	59.82	-18.93	40.88	54.00	-13.12	AV
Horizontal	11650.11	61.79	-8.92	52.87	74.00	-21.13	PK
Horizontal	11650.11	49.22	-8.92	40.30	54.00	-13.70	AV
Horizontal	17475.12	57.13	-1.86	55.27	68.20	-12.93	PK
Horizontal	17475.12	44.19	-1.86	42.33	54.00	-11.67	AV

Note: PK value is lower than the Average value limit, So average didn't record.
 The 26.5-40G amplitude of spurious emissions that are attenuated by more than 20dB below the permissible value has no need to be reported.
 Emission level (dBuV/m) = 20 log Emission level (uV/m).
 Corrected Reading: Antenna Factor + Cable Loss + Read Level - Preamp Factor = Level.
 The Worst mode is Antenna A.

Test Mode:	TX (5.8G) --802.11n-HT20
------------	--------------------------

Polar	Frequency	Reading Level	Correct Factor	Measurement	Limits	Over	Detector Type
(H/V)	(MHz)	(dBuV/m)	(dB)	(dBuV/m)	(dBuV/m)	(dB)	
Low Channel (5745 MHz)-Above 1G							
Vertical	4679.01	73.94	-20.24	53.70	74.00	-20.30	PK
Vertical	4679.01	59.18	-20.24	38.94	54.00	-15.06	AV
Vertical	11490.02	61.50	-8.79	52.71	68.20	-15.49	PK
Vertical	11490.02	49.11	-8.79	40.32	54.00	-13.68	AV
Vertical	17235.06	56.60	-3.18	53.42	68.20	-14.78	PK
Vertical	17235.06	44.07	-3.18	40.89	54.00	-13.11	AV
Horizontal	4679.08	73.67	-20.24	53.43	74.00	-20.57	PK
Horizontal	4679.08	59.78	-20.24	39.53	54.00	-14.47	AV
Horizontal	11490.17	61.11	-8.79	52.32	68.20	-15.88	PK
Horizontal	11490.17	49.30	-8.79	40.51	54.00	-13.49	AV
Horizontal	17235.16	57.22	-3.18	54.04	68.20	-14.16	PK
Horizontal	17235.16	44.12	-3.18	40.94	54.00	-13.06	AV
Middle Channel (5785 MHz)-Above 1G							
Vertical	4592.13	73.19	-20.42	52.78	74.00	-21.22	PK
Vertical	4592.13	59.61	-20.42	39.19	54.00	-14.81	AV
Vertical	11570.06	61.67	-8.86	52.81	68.20	-15.39	PK
Vertical	11570.06	49.10	-8.86	40.24	54.00	-13.76	AV
Vertical	17355.06	59.08	-2.52	56.56	68.20	-11.64	PK
Vertical	17355.06	44.36	-2.52	41.84	54.00	-12.16	AV
Horizontal	4592.07	74.26	-20.42	53.84	74.00	-20.16	PK
Horizontal	4592.07	59.38	-20.42	38.96	54.00	-15.04	AV
Horizontal	11570.04	63.06	-8.86	54.20	68.20	-14.00	PK
Horizontal	11570.04	49.50	-8.86	40.64	54.00	-13.36	AV
Horizontal	17355.02	57.60	-2.52	55.08	68.20	-13.12	PK
Horizontal	17355.02	44.94	-2.52	42.42	54.00	-11.58	AV
High Channel (5825 MHz)-Above 1G							
Vertical	6039.17	74.81	-18.93	55.88	68.20	-12.32	PK
Vertical	6039.17	59.45	-18.93	40.52	54.00	-13.48	AV
Vertical	11650.19	63.35	-8.92	54.43	74.00	-19.57	PK
Vertical	11650.19	49.50	-8.92	40.58	54.00	-13.42	AV
Vertical	17475.02	57.16	-1.86	55.30	68.20	-12.90	PK
Vertical	17475.02	44.44	-1.86	42.58	54.00	-11.42	AV
Horizontal	6039.05	72.00	-18.93	53.07	68.20	-15.13	PK
Horizontal	6039.05	59.84	-18.93	40.91	54.00	-13.09	AV
Horizontal	11650.00	62.98	-8.92	54.06	74.00	-19.94	PK
Horizontal	11650.00	49.80	-8.92	40.88	54.00	-13.12	AV
Horizontal	17475.10	57.82	-1.86	55.96	68.20	-12.24	PK
Horizontal	17475.10	44.83	-1.86	42.97	54.00	-11.03	AV

Note: PK value is lower than the Average value limit, So average didn't record.
 The 26.5-40G amplitude of spurious emissions that are attenuated by more than 20dB below the permissible value has no need to be reported.
 Emission level (dBuV/m) = 20 log Emission level (uV/m).
 Corrected Reading: Antenna Factor + Cable Loss + Read Level - Preamp Factor = Level.
 Test Mode is MIMO Mode.

Test Mode:	TX (5.8G) -- 802.11n-HT40
------------	---------------------------

Polar (H/V)	Frequency (MHz)	Reading Level (dBuV/m)	Correct Factor (dB)	Measurement (dBuV/m)	Limits (dBuV/m)	Over (dB)	Detector Type
Low Channel (5755 MHz)-Above 1G							
Vertical	4679.10	71.52	-20.24	51.28	74.00	-22.72	PK
Vertical	4679.10	59.39	-20.24	39.15	54.00	-14.85	AV
Vertical	11510.04	61.17	-8.81	52.36	74.00	-21.64	PK
Vertical	11510.04	49.90	-8.81	41.09	54.00	-12.91	AV
Vertical	17265.15	56.92	-3.01	53.91	68.20	-14.29	PK
Vertical	17265.15	44.06	-3.01	41.05	54.00	-12.95	AV
Horizontal	4679.04	74.86	-20.24	54.62	74.00	-19.38	PK
Horizontal	4679.04	59.41	-20.24	39.17	54.00	-14.83	AV
Horizontal	11510.19	64.22	-8.81	55.41	74.00	-18.59	PK
Horizontal	11510.19	49.46	-8.81	40.65	54.00	-13.35	AV
Horizontal	17265.14	57.35	-3.01	54.34	68.20	-13.86	PK
Horizontal	17265.14	44.28	-3.01	41.27	54.00	-12.73	AV
Middle Channel (5795 MHz)-Above 1G							
Vertical	6039.14	74.81	-18.93	55.87	68.20	-12.33	PK
Vertical	6039.14	59.05	-18.93	40.12	54.00	-13.88	AV
Vertical	11590.17	64.54	-8.87	55.67	74.00	-18.33	PK
Vertical	11590.17	49.47	-8.87	40.60	54.00	-13.40	AV
Vertical	17385.19	59.77	-2.35	57.42	68.20	-10.78	PK
Vertical	17385.19	44.19	-2.35	41.84	54.00	-12.16	AV
Horizontal	6039.12	70.03	-18.93	51.10	68.20	-17.10	PK
Horizontal	6039.12	59.24	-18.93	40.31	54.00	-13.69	AV
Horizontal	11590.15	61.82	-8.87	52.95	74.00	-21.05	PK
Horizontal	11590.15	49.88	-8.87	41.01	54.00	-12.99	AV
Horizontal	17385.10	59.80	-2.35	57.45	68.20	-10.75	PK
Horizontal	17385.10	44.85	-2.35	42.50	54.00	-11.50	AV

Note: PK value is lower than the Average value limit, So average didn't record.

The 26.5-40G amplitude of spurious emissions that are attenuated by more than 20dB below the permissible value has no need to be reported.

Emission level (dBuV/m) = 20 log Emission level (uV/m).

Corrected Reading: Antenna Factor + Cable Loss + Read Level - Preamp Factor = Level.

Test Mode is MIMO Mode.

Test Mode:	TX (5.8G) --802.11ac-HT20
------------	---------------------------

Polar	Frequency	Reading Level	Correct Factor	Measurement	Limits	Over	Detector Type
(H/V)	(MHz)	(dBuV/m)	(dB)	(dBuV/m)	(dBuV/m)	(dB)	
Low Channel (5745 MHz)-Above 1G							
Vertical	4679.11	72.45	-20.24	52.21	74.00	-21.79	PK
Vertical	4679.11	59.13	-20.24	38.89	54.00	-15.11	AV
Vertical	11490.16	61.22	-8.79	52.43	68.20	-15.77	PK
Vertical	11490.16	49.69	-8.79	40.90	54.00	-13.10	AV
Vertical	17235.17	58.60	-3.18	55.42	68.20	-12.78	PK
Vertical	17235.17	44.53	-3.18	41.35	54.00	-12.65	AV
Horizontal	4679.06	72.92	-20.24	52.68	74.00	-21.32	PK
Horizontal	4679.06	59.20	-20.24	38.96	54.00	-15.04	AV
Horizontal	11490.18	63.26	-8.79	54.47	68.20	-13.73	PK
Horizontal	11490.18	49.49	-8.79	40.70	54.00	-13.30	AV
Horizontal	17235.10	59.45	-3.18	56.27	68.20	-11.93	PK
Horizontal	17235.10	44.25	-3.18	41.07	54.00	-12.93	AV
Middle Channel (5785 MHz)-Above 1G							
Vertical	4592.19	72.98	-20.42	52.56	74.00	-21.44	PK
Vertical	4592.19	59.05	-20.42	38.63	54.00	-15.37	AV
Vertical	11570.16	64.90	-8.86	56.04	68.20	-12.16	PK
Vertical	11570.16	49.78	-8.86	40.92	54.00	-13.08	AV
Vertical	17355.17	55.00	-2.52	52.48	68.20	-15.72	PK
Vertical	17355.17	44.37	-2.52	41.85	54.00	-12.15	AV
Horizontal	4592.12	74.54	-20.42	54.13	74.00	-19.87	PK
Horizontal	4592.12	59.80	-20.42	39.38	54.00	-14.62	AV
Horizontal	11570.02	63.52	-8.86	54.66	68.20	-13.54	PK
Horizontal	11570.02	49.13	-8.86	40.27	54.00	-13.73	AV
Horizontal	17355.12	57.97	-2.52	55.45	68.20	-12.75	PK
Horizontal	17355.12	44.89	-2.52	42.37	54.00	-11.63	AV
High Channel (5825 MHz)-Above 1G							
Vertical	6039.10	73.68	-18.93	54.75	68.20	-13.45	PK
Vertical	6039.10	59.31	-18.93	40.38	54.00	-13.62	AV
Vertical	11650.02	60.79	-8.92	51.87	74.00	-22.13	PK
Vertical	11650.02	49.43	-8.92	40.51	54.00	-13.49	AV
Vertical	17475.17	59.44	-1.86	57.58	68.20	-10.62	PK
Vertical	17475.17	44.49	-1.86	42.63	54.00	-11.37	AV
Horizontal	6039.08	71.92	-18.93	52.99	68.20	-15.21	PK
Horizontal	6039.08	59.84	-18.93	40.91	54.00	-13.09	AV
Horizontal	11650.01	60.80	-8.92	51.88	74.00	-22.12	PK
Horizontal	11650.01	49.08	-8.92	40.16	54.00	-13.84	AV
Horizontal	17475.08	57.28	-1.86	55.42	68.20	-12.78	PK
Horizontal	17475.08	44.75	-1.86	42.89	54.00	-11.11	AV

Note: PK value is lower than the Average value limit, So average didn't record.
 The 26.5-40G amplitude of spurious emissions that are attenuated by more than 20dB below the permissible value has no need to be reported.
 Emission level (dBuV/m) = 20 log Emission level (uV/m).
 Corrected Reading: Antenna Factor + Cable Loss + Read Level - Preamp Factor = Level.
 Test Mode is MIMO Mode.

Test Mode :	TX (5.8G) -- 802.11ac-HT40
-------------	----------------------------

Polar (H/V)	Frequency (MHz)	Reading Level (dBuV/m)	Correct Factor (dB)	Measurement (dBuV/m)	Limits (dBuV/m)	Over (dB)	Detector Type
Low Channel (5755 MHz)-Above 1G							
Vertical	4679.00	72.62	-20.24	52.38	74.00	-21.62	PK
Vertical	4679.00	59.61	-20.24	39.36	54.00	-14.64	AV
Vertical	11510.13	62.88	-8.81	54.07	74.00	-19.93	PK
Vertical	11510.13	49.06	-8.81	40.25	54.00	-13.75	AV
Vertical	17265.12	58.66	-3.01	55.65	68.20	-12.55	PK
Vertical	17265.12	44.39	-3.01	41.38	54.00	-12.62	AV
Horizontal	4679.06	71.29	-20.24	51.05	74.00	-22.95	PK
Horizontal	4679.06	59.42	-20.24	39.18	54.00	-14.82	AV
Horizontal	11510.01	62.61	-8.81	53.80	74.00	-20.20	PK
Horizontal	11510.01	49.29	-8.81	40.48	54.00	-13.52	AV
Horizontal	17265.08	55.69	-3.01	52.68	68.20	-15.52	PK
Horizontal	17265.08	44.13	-3.01	41.12	54.00	-12.88	AV
Middle Channel (5795 MHz)-Above 1G							
Vertical	6039.09	73.69	-18.93	54.76	68.20	-13.44	PK
Vertical	6039.09	59.63	-18.93	40.69	54.00	-13.31	AV
Vertical	11590.16	60.09	-8.87	51.22	74.00	-22.78	PK
Vertical	11590.16	49.79	-8.87	40.92	54.00	-13.08	AV
Vertical	17385.12	57.89	-2.35	55.54	68.20	-12.66	PK
Vertical	17385.12	44.47	-2.35	42.12	54.00	-11.88	AV
Horizontal	6039.15	71.39	-18.93	52.45	68.20	-15.75	PK
Horizontal	6039.15	59.97	-18.93	41.04	54.00	-12.96	AV
Horizontal	11590.17	63.91	-8.87	55.04	74.00	-18.96	PK
Horizontal	11590.17	49.99	-8.87	41.12	54.00	-12.88	AV
Horizontal	17385.04	55.50	-2.35	53.15	68.20	-15.05	PK
Horizontal	17385.04	44.95	-2.35	42.60	54.00	-11.40	AV

Note: PK value is lower than the Average value limit, So average didn't record.

The 26.5-40G amplitude of spurious emissions that are attenuated by more than 20dB below the permissible value has no need to be reported.

Emission level (dBuV/m) = 20 log Emission level (uV/m).

Corrected Reading: Antenna Factor + Cable Loss + Read Level - Preamp Factor = Level.

Test Mode is MIMO Mode.

Test Mode :	TX (5.8G) -- 802.11ac 80
-------------	--------------------------

Polar (H/V)	Frequency (MHz)	Reading Level (dBuV/m)	Correct Factor (dB)	Measurement (dBuV/m)	Limits (dBuV/m)	Over (dB)	Detector Type
Low Channel (5775 MHz)-Above 1G							
Vertical	4679.06	72.61	-20.24	52.37	74.00	-21.63	PK
Vertical	4679.06	59.98	-20.24	39.74	54.00	-14.26	AV
Vertical	11550.15	63.17	-8.84	54.33	74.00	-19.67	PK
Vertical	11550.15	49.71	-8.84	40.87	54.00	-13.13	AV
Vertical	17325.12	58.81	-2.68	56.13	68.20	-12.07	PK
Vertical	17325.12	44.78	-2.68	42.10	54.00	-11.90	AV
Horizontal	4679.13	71.35	-20.24	51.11	74.00	-22.89	PK
Horizontal	4679.13	59.17	-20.24	38.93	54.00	-15.07	AV
Horizontal	11550.19	62.43	-8.84	53.59	74.00	-20.41	PK
Horizontal	11550.19	49.64	-8.84	40.80	54.00	-13.20	AV
Horizontal	17325.19	57.10	-2.68	54.42	68.20	-13.78	PK
Horizontal	17325.19	44.16	-2.68	41.48	54.00	-12.52	AV

Note: PK value is lower than the Average value limit, So average didn't record.

The 26.5-40G amplitude of spurious emissions that are attenuated by more than 20dB below the permissible value has no need to be reported.

Emission level (dBuV/m) = 20 log Emission level (uV/m).

Corrected Reading: Antenna Factor + Cable Loss + Read Level - Preamp Factor = Level.

Test Mode is MIMO Mode.

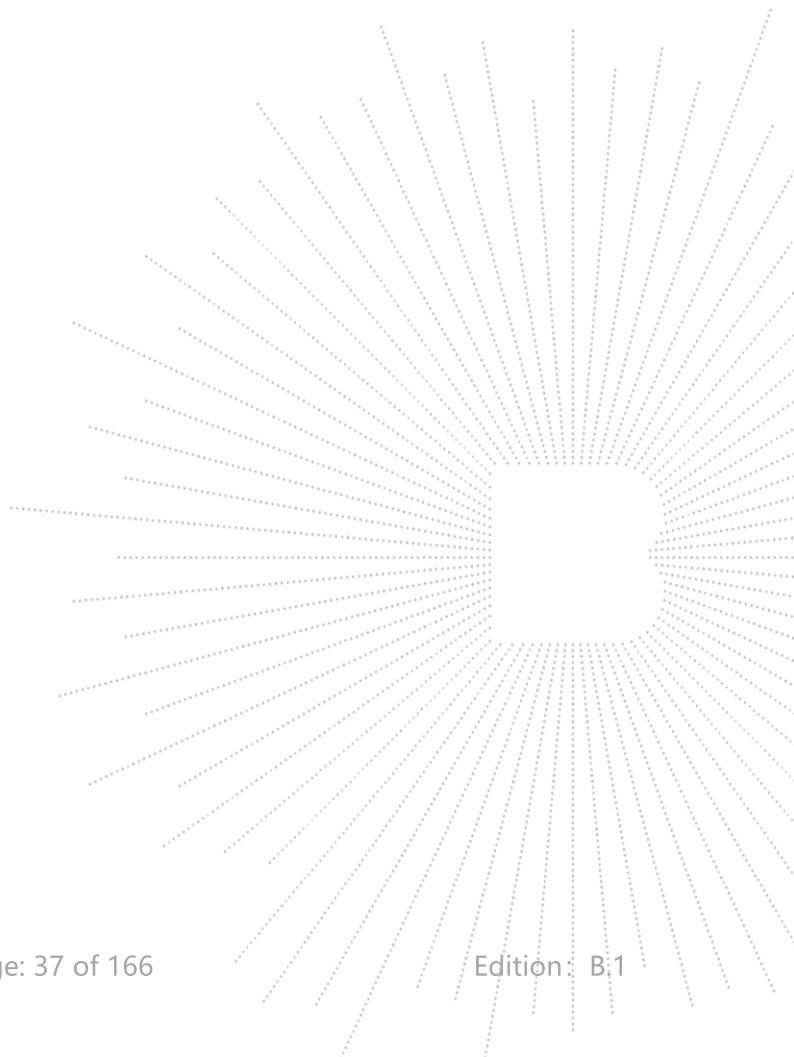

Test Mode:	TX (5.8G) --802.11ax-HT20
------------	---------------------------

Polar	Frequency	Reading Level	Correct Factor	Measurement	Limits	Over	Detector Type
(H/V)	(MHz)	(dBuV/m)	(dB)	(dBuV/m)	(dBuV/m)	(dB)	
Low Channel (5745 MHz)-Above 1G							
Vertical	4679.07	73.00	-20.24	52.76	74.00	-21.24	PK
Vertical	4679.07	59.40	-20.24	39.16	54.00	-14.84	AV
Vertical	11490.09	64.65	-8.79	55.86	68.20	-12.34	PK
Vertical	11490.09	49.42	-8.79	40.63	54.00	-13.37	AV
Vertical	17235.05	55.58	-3.18	52.40	68.20	-15.80	PK
Vertical	17235.05	44.62	-3.18	41.44	54.00	-12.56	AV
Horizontal	4679.06	74.21	-20.24	53.97	74.00	-20.03	PK
Horizontal	4679.06	60.00	-20.24	39.75	54.00	-14.25	AV
Horizontal	11490.19	64.91	-8.79	56.12	68.20	-12.08	PK
Horizontal	11490.19	49.99	-8.79	41.20	54.00	-12.80	AV
Horizontal	17235.05	59.70	-3.18	56.52	68.20	-11.68	PK
Horizontal	17235.05	44.31	-3.18	41.13	54.00	-12.87	AV
Middle Channel (5785 MHz)-Above 1G							
Vertical	4592.00	74.65	-20.42	54.23	74.00	-19.77	PK
Vertical	4592.00	59.42	-20.42	39.01	54.00	-14.99	AV
Vertical	11570.13	61.79	-8.86	52.93	68.20	-15.27	PK
Vertical	11570.13	49.47	-8.86	40.61	54.00	-13.39	AV
Vertical	17355.13	56.35	-2.52	53.83	68.20	-14.37	PK
Vertical	17355.13	44.22	-2.52	41.70	54.00	-12.30	AV
Horizontal	4592.16	73.50	-20.42	53.08	74.00	-20.92	PK
Horizontal	4592.16	59.08	-20.42	38.66	54.00	-15.34	AV
Horizontal	11570.06	60.94	-8.86	52.08	68.20	-16.12	PK
Horizontal	11570.06	49.63	-8.86	40.77	54.00	-13.23	AV
Horizontal	17355.13	56.40	-2.52	53.88	68.20	-14.32	PK
Horizontal	17355.13	44.06	-2.52	41.54	54.00	-12.46	AV
High Channel (5825 MHz)-Above 1G							
Vertical	6039.12	73.10	-18.93	54.17	68.20	-14.03	PK
Vertical	6039.12	59.42	-18.93	40.49	54.00	-13.51	AV
Vertical	11650.16	63.49	-8.92	54.57	74.00	-19.43	PK
Vertical	11650.16	49.68	-8.92	40.76	54.00	-13.24	AV
Vertical	17475.09	56.84	-1.86	54.98	68.20	-13.22	PK
Vertical	17475.09	44.69	-1.86	42.83	54.00	-11.17	AV
Horizontal	6039.10	71.46	-18.93	52.53	68.20	-15.67	PK
Horizontal	6039.10	59.40	-18.93	40.46	54.00	-13.54	AV
Horizontal	11650.10	62.48	-8.92	53.56	74.00	-20.44	PK
Horizontal	11650.10	49.47	-8.92	40.55	54.00	-13.45	AV
Horizontal	17475.09	58.05	-1.86	56.19	68.20	-12.01	PK
Horizontal	17475.09	44.39	-1.86	42.53	54.00	-11.47	AV

Note: PK value is lower than the Average value limit, So average didn't record.
 The 26.5-40G amplitude of spurious emissions that are attenuated by more than 20dB below the permissible value has no need to be reported.
 Emission level (dBuV/m) = 20 log Emission level (uV/m).
 Corrected Reading: Antenna Factor + Cable Loss + Read Level - Preamp Factor = Level.
 Test Mode is MIMO Mode.

Test Mode :	TX (5.8G) -- 802.11ax-HT40
-------------	----------------------------

Polar (H/V)	Frequency (MHz)	Reading Level (dBuV/m)	Correct Factor (dB)	Measure- ment (dBuV/m)	Limits (dBuV/m)	Over (dB)	Detector Type
Low Channel (5755 MHz)-Above 1G							
Vertical	4679.03	70.81	-20.24	50.57	74.00	-23.43	PK
Vertical	4679.03	59.70	-20.24	39.46	54.00	-14.54	AV
Vertical	11510.09	64.10	-8.81	55.29	74.00	-18.71	PK
Vertical	11510.09	49.26	-8.81	40.45	54.00	-13.55	AV
Vertical	17265.11	55.65	-3.01	52.64	68.20	-15.56	PK
Vertical	17265.11	44.29	-3.01	41.28	54.00	-12.72	AV
Horizontal	4679.07	72.29	-20.24	52.05	74.00	-21.95	PK
Horizontal	4679.07	59.21	-20.24	38.97	54.00	-15.03	AV
Horizontal	11510.14	63.31	-8.81	54.50	74.00	-19.50	PK
Horizontal	11510.14	49.31	-8.81	40.50	54.00	-13.50	AV
Horizontal	17265.06	59.14	-3.01	56.13	68.20	-12.07	PK
Horizontal	17265.06	44.91	-3.01	41.90	54.00	-12.10	AV
Middle Channel (5795 MHz)-Above 1G							
Vertical	6039.06	73.72	-18.93	54.79	68.20	-13.41	PK
Vertical	6039.06	59.54	-18.93	40.61	54.00	-13.39	AV
Vertical	11590.02	63.50	-8.87	54.63	74.00	-19.37	PK
Vertical	11590.02	49.13	-8.87	40.26	54.00	-13.74	AV
Vertical	17385.16	56.66	-2.35	54.31	68.20	-13.89	PK
Vertical	17385.16	44.79	-2.35	42.44	54.00	-11.56	AV
Horizontal	6039.14	72.94	-18.93	54.01	68.20	-14.19	PK
Horizontal	6039.14	59.06	-18.93	40.13	54.00	-13.87	AV
Horizontal	11590.09	63.01	-8.87	54.14	74.00	-19.86	PK
Horizontal	11590.09	49.39	-8.87	40.52	54.00	-13.48	AV
Horizontal	17385.06	56.29	-2.35	53.94	68.20	-14.26	PK
Horizontal	17385.06	44.53	-2.35	42.18	54.00	-11.82	AV

Note: PK value is lower than the Average value limit, So average didn't record.

The 26.5-40G amplitude of spurious emissions that are attenuated by more than 20dB below the permissible value has no need to be reported.

Emission level (dBuV/m) = 20 log Emission level (uV/m).

Corrected Reading: Antenna Factor + Cable Loss + Read Level - Preamp Factor = Level.

Test Mode is MIMO Mode.

Test Mode :	TX (5.8G) -- 802.11ax 80
-------------	--------------------------

Polar (H/V)	Frequency (MHz)	Reading Level (dBuV/m)	Correct Factor (dB)	Measurement (dBuV/m)	Limits (dBuV/m)	Over (dB)	Detector Type
Low Channel (5775 MHz)-Above 1G							
Vertical	4679.15	74.21	-20.24	53.97	74.00	-20.03	PK
Vertical	4679.15	59.73	-20.24	39.48	54.00	-14.52	AV
Vertical	11550.20	63.81	-8.84	54.97	74.00	-19.03	PK
Vertical	11550.20	49.99	-8.84	41.15	54.00	-12.85	AV
Vertical	17325.13	55.46	-2.68	52.78	68.20	-15.42	PK
Vertical	17325.13	44.59	-2.68	41.91	54.00	-12.09	AV
Horizontal	4679.18	72.08	-20.24	51.83	74.00	-22.17	PK
Horizontal	4679.18	59.28	-20.24	39.04	54.00	-14.96	AV
Horizontal	11550.06	62.92	-8.84	54.08	74.00	-19.92	PK
Horizontal	11550.06	49.59	-8.84	40.75	54.00	-13.25	AV
Horizontal	17325.02	58.34	-2.68	55.66	68.20	-12.54	PK
Horizontal	17325.02	44.73	-2.68	42.05	54.00	-11.95	AV

Note: PK value is lower than the Average value limit, So average didn't record.
 The 26.5-40G amplitude of spurious emissions that are attenuated by more than 20dB below the permissible value has no need to be reported.
 Emission level (dBuV/m) = 20 log Emission level (uV/m).
 Corrected Reading: Antenna Factor + Cable Loss + Read Level - Preamp Factor = Level.
 Test Mode is MIMO Mode.

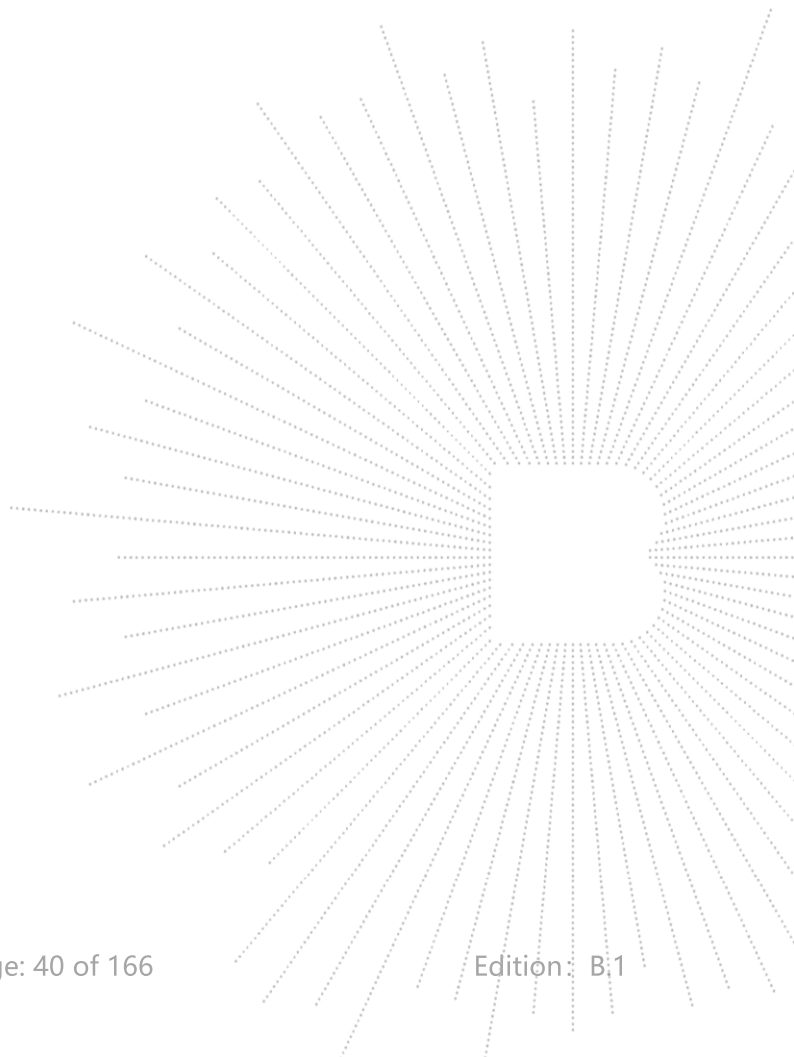

8. Power Spectral Density Test

8.1 Block Diagram Of Test Setup

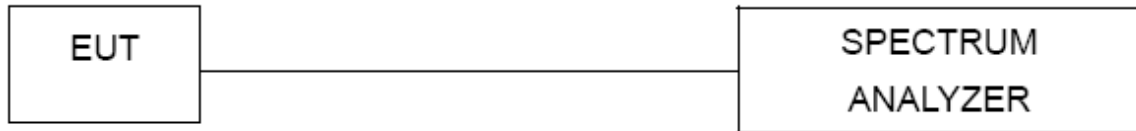

8.2 Limit

For the band 5.15-5.25 GHz,

(i) For an outdoor access point operating in the band 5.15-5.25 GHz, the maximum power spectral density shall not exceed 17 dBm in any 1 megahertz band. If transmitting antennas of directional gain greater than 6 dBi are used, both the maximum conducted output power and the maximum power spectral density shall be reduced by the amount in dB that the directional gain of the antenna exceeds 6 dBi. The maximum e.i.r.p. at any elevation angle above 30 degrees as measured from the horizon must not exceed 125 mW (21 dBm).

(ii) For an indoor access point operating in the band 5.15-5.25 GHz, the maximum power spectral density shall not exceed 17 dBm in any 1 megahertz band. If transmitting antennas of directional gain greater than 6 dBi are used, both the maximum conducted output power and the maximum power spectral density shall be reduced by the amount in dB that the directional gain of the antenna exceeds 6 dBi.

(iii) For fixed point-to-point access points operating in the band 5.15-5.25 GHz, the maximum power spectral density shall not exceed 17 dBm in any 1 megahertz band. Fixed point-to-point U-NII devices may employ antennas with directional gain up to 23 dBi without any corresponding reduction in the maximum conducted output power or maximum power spectral density. For fixed point-to-point transmitters that employ a directional antenna gain greater than 23 dBi, a 1 dB reduction in maximum conducted output power and maximum power spectral density is required for each 1 dB of antenna gain in excess of 23 dBi. Fixed, point-to-point operations exclude the use of point-to-multipoint systems, omnidirectional applications, and multiple collocated transmitters transmitting the same information. The operator of the U-NII device, or if the equipment is professionally installed, the installer, is responsible for ensuring that systems employing high gain directional antennas are used exclusively for fixed, point-to-point operations.

(iv) For client devices in the 5.15-5.25 GHz band, the maximum power spectral density shall not exceed 11 dBm in any 1 megahertz band. If transmitting antennas of directional gain greater than 6 dBi are used, both the maximum conducted output power and the maximum power spectral density shall be reduced by the amount in dB that the directional gain of the antenna exceeds 6 dBi.

For the band 5.725-5.85 GHz

(3) For the band 5.725-5.85 GHz, the maximum power spectral density shall not exceed 30 dBm in any 500-kHz band. If transmitting antennas of directional gain greater than 6 dBi are used, both the maximum conducted output power and the maximum power spectral density shall be reduced by the amount in dB that the directional gain of the antenna exceeds 6 dBi.

8.3 Test Procedure

For devices operating in the bands 5.15-5.25 GHz, 5.25-5.35 GHz, and 5.47-5.725 GHz, the above procedures make use of 1 MHz RBW to satisfy directly the 1 MHz reference bandwidth specified in § 15.407(a)(5). For devices operating in the band 5.725-5.85 GHz, the rules specify a measurement bandwidth of 500 kHz. Many spectrum analyzers do not have 500 kHz RBW, thus a narrower RBW may need to be used. The rules permit the use of a RBWs less than 1 MHz, or 500 kHz, “provided that the measured power is integrated over the full reference bandwidth” to show the total power over the specified measurement bandwidth (i.e., 1 MHz, or 500 kHz). If measurements are performed using a reduced resolution bandwidth (< 1 MHz, or < 500 kHz) and integrated over 1 MHz, or 500 KHz bandwidth, the following adjustments to the procedures apply:

- a) Set $RBW \geq 1/T$, where T is defined in section II.B.I.a).
- b) Set $VBW \geq 3 RBW$.
- c) If measurement bandwidth of Maximum PSD is specified in 500 kHz, add $10\log(500\text{kHz}/RBW)$ to the measured result, whereas RBW (< 500 KHz) is the reduced resolution bandwidth of the spectrum analyzer set during measurement.
- d) If measurement bandwidth of Maximum PSD is specified in 1 MHz, add $10\log(1\text{MHz}/RBW)$ to the measured result, whereas RBW (< 1 MHz) is the reduced resolution bandwidth of spectrum analyzer set during measurement.
- e) Care must be taken to ensure that the measurements are performed during a period of continuous transmission or are corrected upward for duty cycle.

Note: As a practical matter, it is recommended to use reduced RBW of 100 kHz for the sections 5.c) and 5.d) above, since RBW=100 KHZ is available on nearly all spectrum analyzers.

8.4 EUT Operating Conditions

The EUT was configured for testing in a typical fashion (as a customer would normally use it). The EUT has been programmed to continuously transmit during test. This operating condition was tested and used to collect the included data.

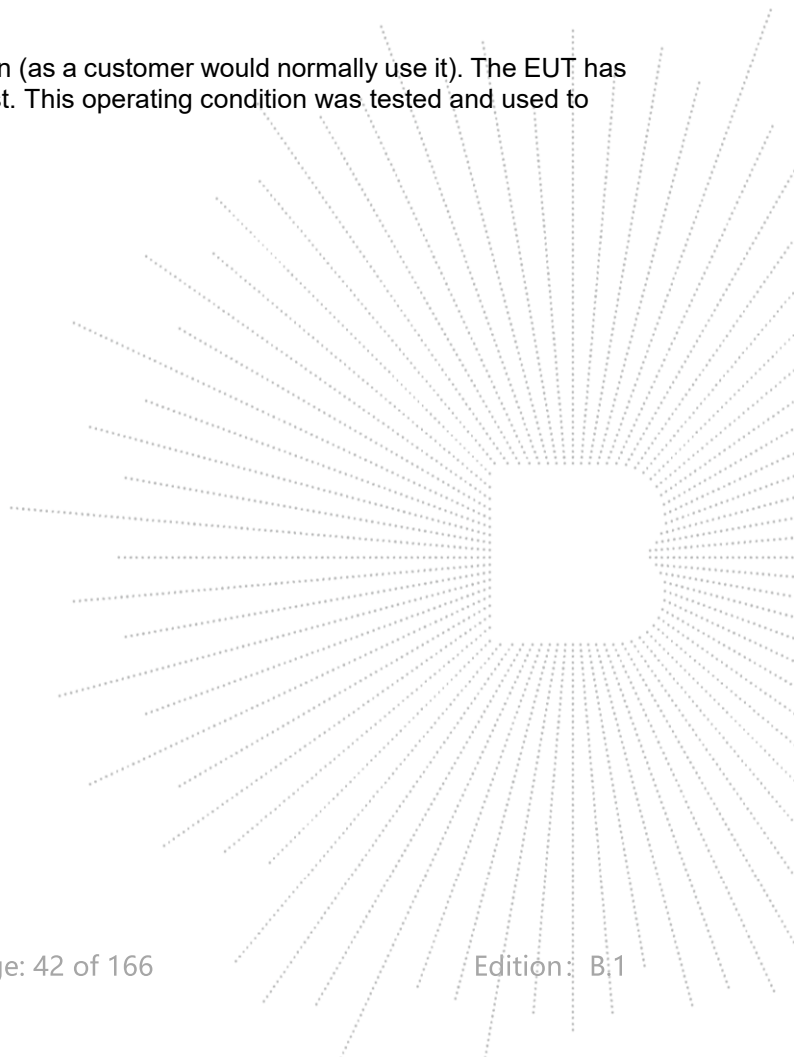

8.5 Test Result

Temperature:	26 °C	Relative Humidity:	54%
Pressure:	101kPa	Test Voltage:	DC 12V
Test Mode:	TX Frequency U-NII-1 (5180-5240MHz)		

Mode	Frequency (MHz)	Measured Power Density (dBm/MHz)			Limit (dBm/MHz)	Result
		ANT A	ANT B	Total		
a	5180	0.54	0.62	/	11	PASS
a	5200	0	-0.11	/	11	PASS
a	5240	-0.97	-2	/	11	PASS
n20	5180	-1.23	-0.22	2.31	8.75	PASS
n20	5200	-1.85	-0.31	2.00	8.75	PASS
n20	5240	-3.86	-2.09	0.12	8.75	PASS
n40	5190	-3.72	-2.5	-0.06	8.75	PASS
n40	5230	-5.2	-4.42	-1.78	8.75	PASS
ac20	5180	-1.1	-0.22	2.37	8.75	PASS
ac20	5200	-1.2	-1.47	1.68	8.75	PASS
ac20	5240	-2.56	6.81	7.29	8.75	PASS
ac40	5190	-3.23	-2.03	0.42	8.75	PASS
ac40	5230	-5.31	-4.92	-2.10	8.75	PASS
ac80	5210	-8.9	-8.02	-5.43	8.75	PASS
ax20	5180	-1.41	-0.34	2.17	8.75	PASS
ax20	5200	-1.57	-0.56	1.97	8.75	PASS
ax20	5240	-3.31	-2.78	-0.03	8.75	PASS
ax40	5190	-3.57	-2.8	-0.16	8.75	PASS
ax40	5230	-5.5	-5.06	-2.26	8.75	PASS
ax80	5210	-7.38	-6.35	-3.82	8.75	PASS

For MIMO mode:

Antenna A gain:5.24dBi, Antenna B gain: 5.24dBi, Directional gain=[GainANT + 10 log(NANT/NSS) dBi]
=8.25dbi>6dbi

Limit=11-(8.25-6)=8.75 dbi

Note: A(B) Represent the value of antenna A and B, The worst data is Antenna B, only shown Antenna B Plot.

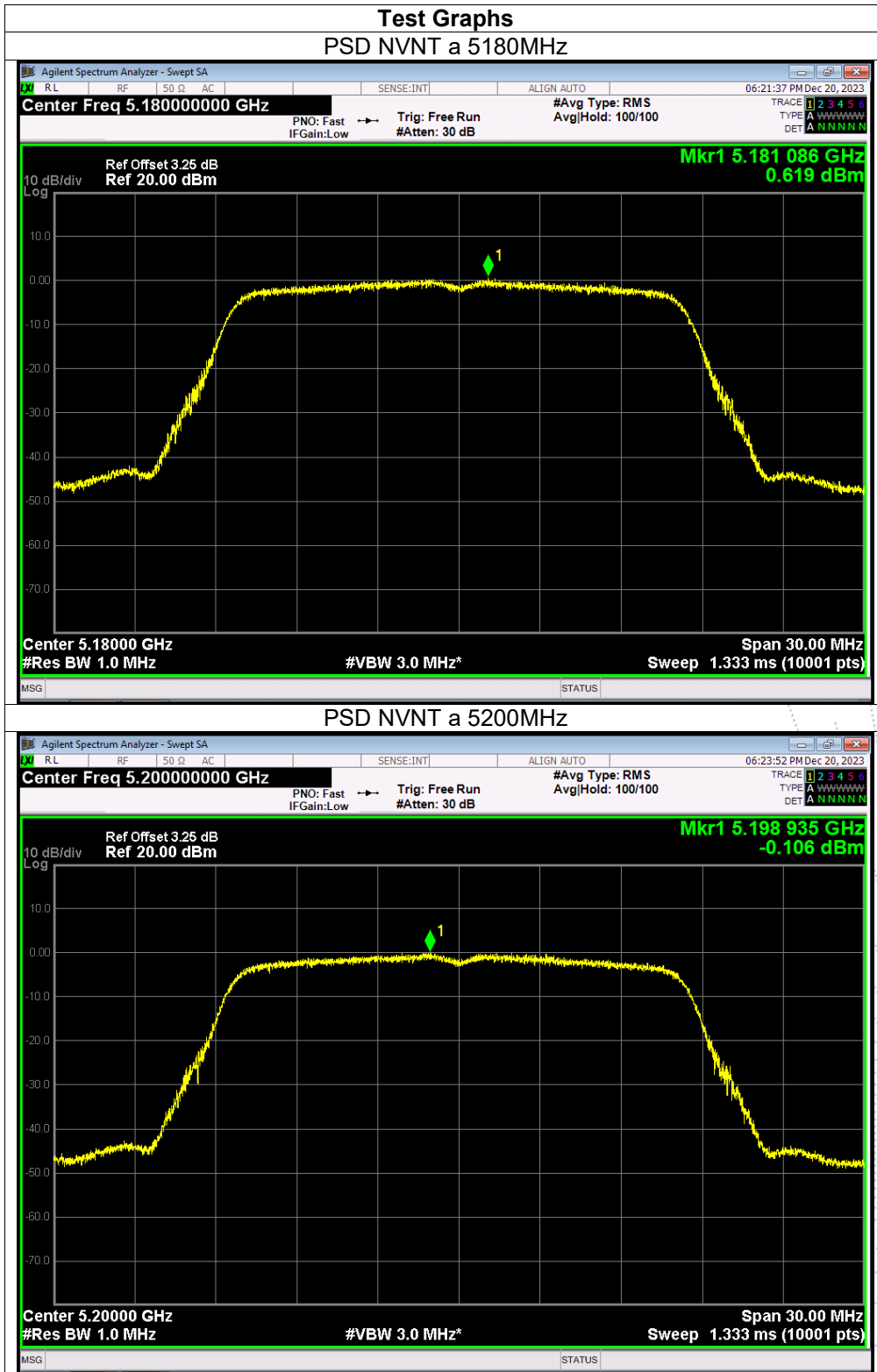

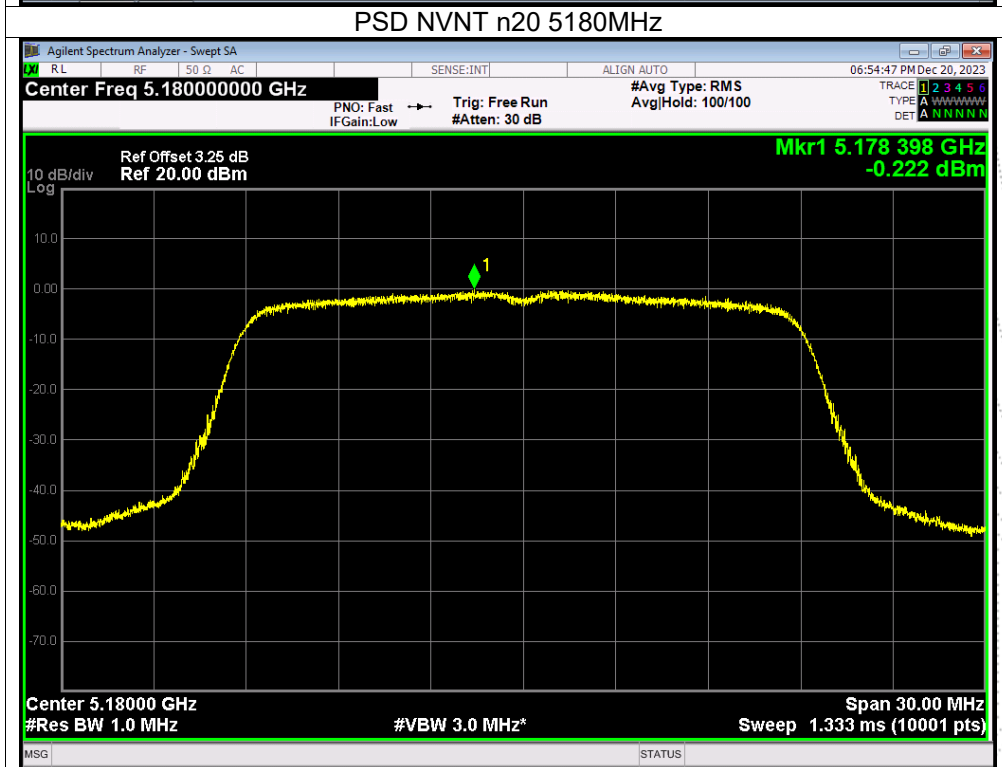
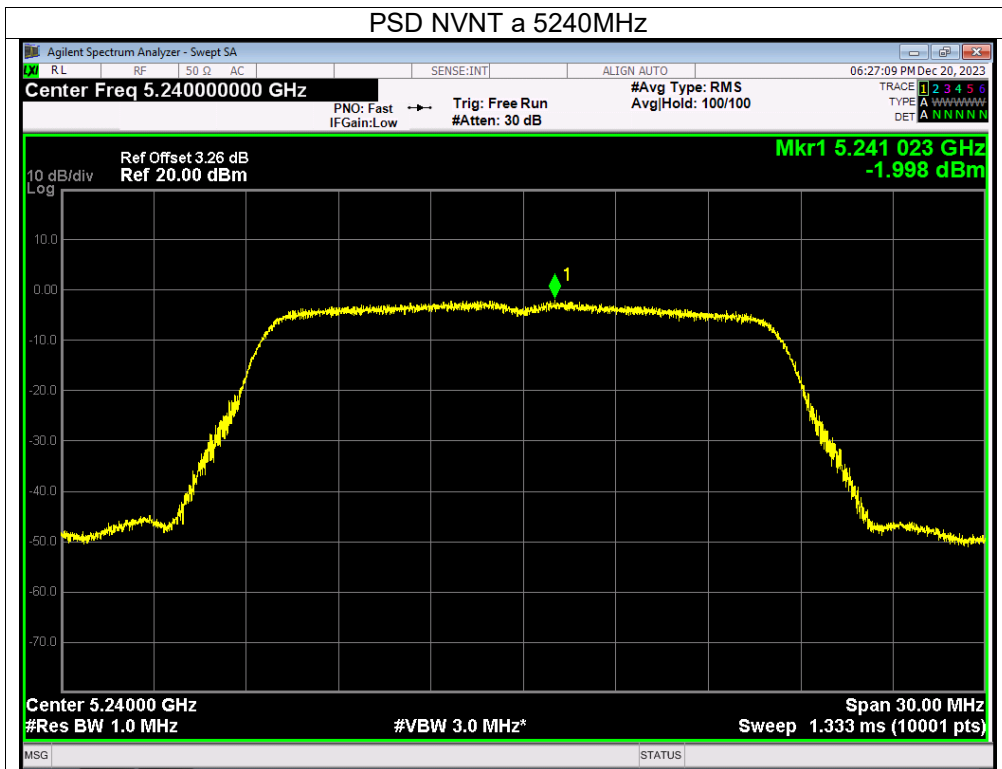

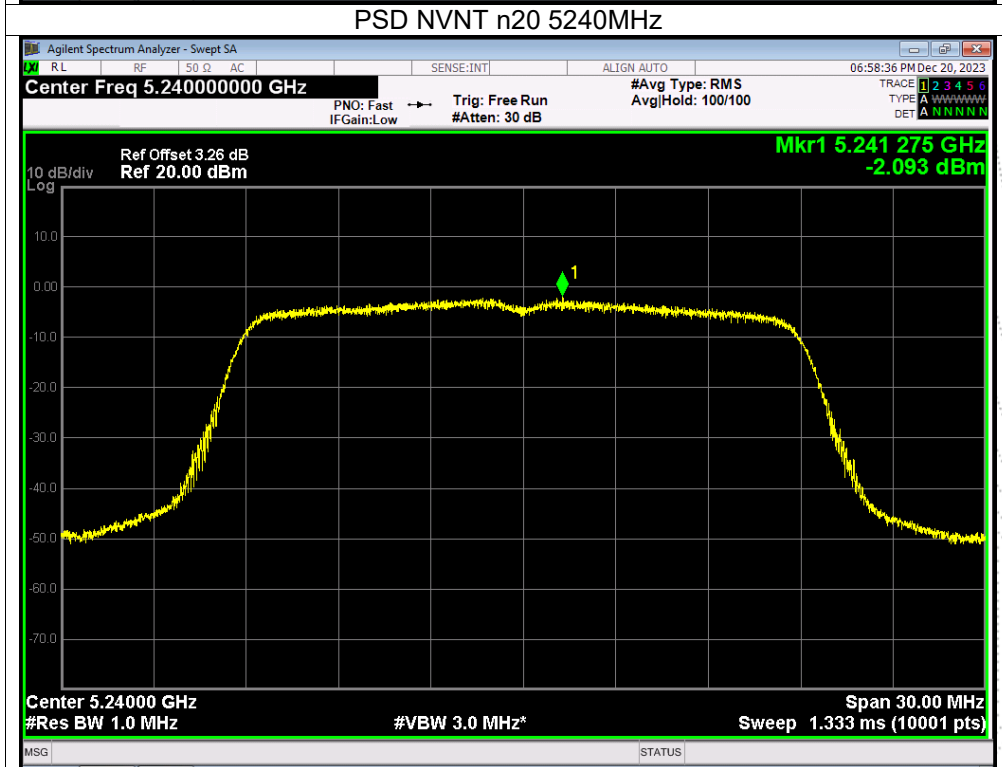
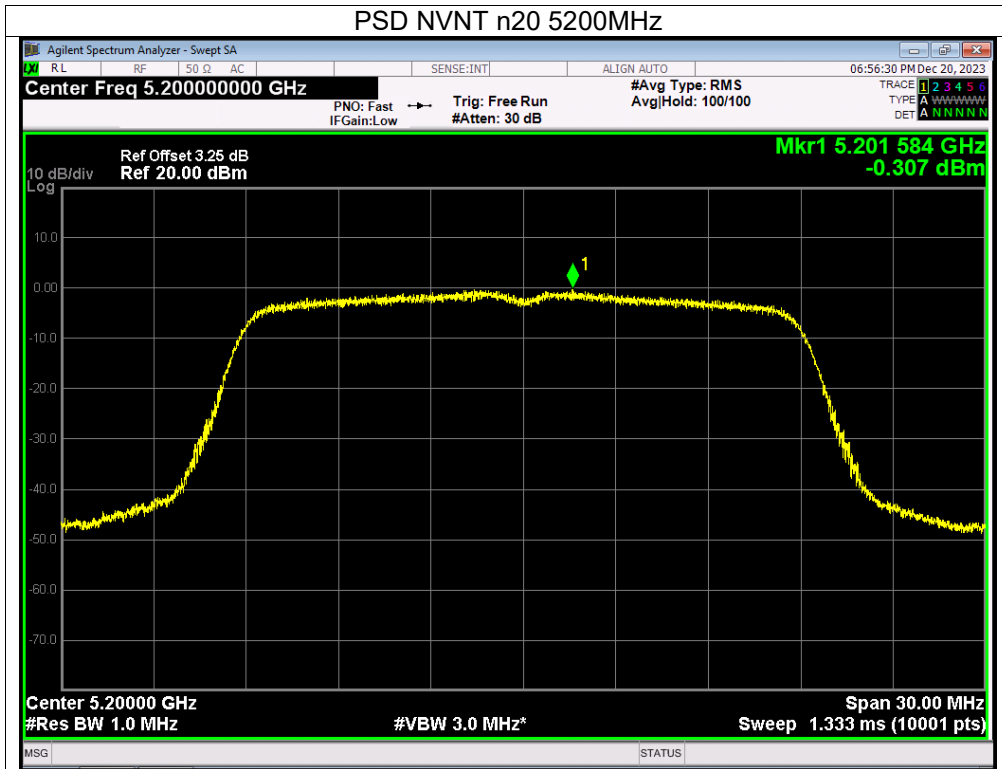

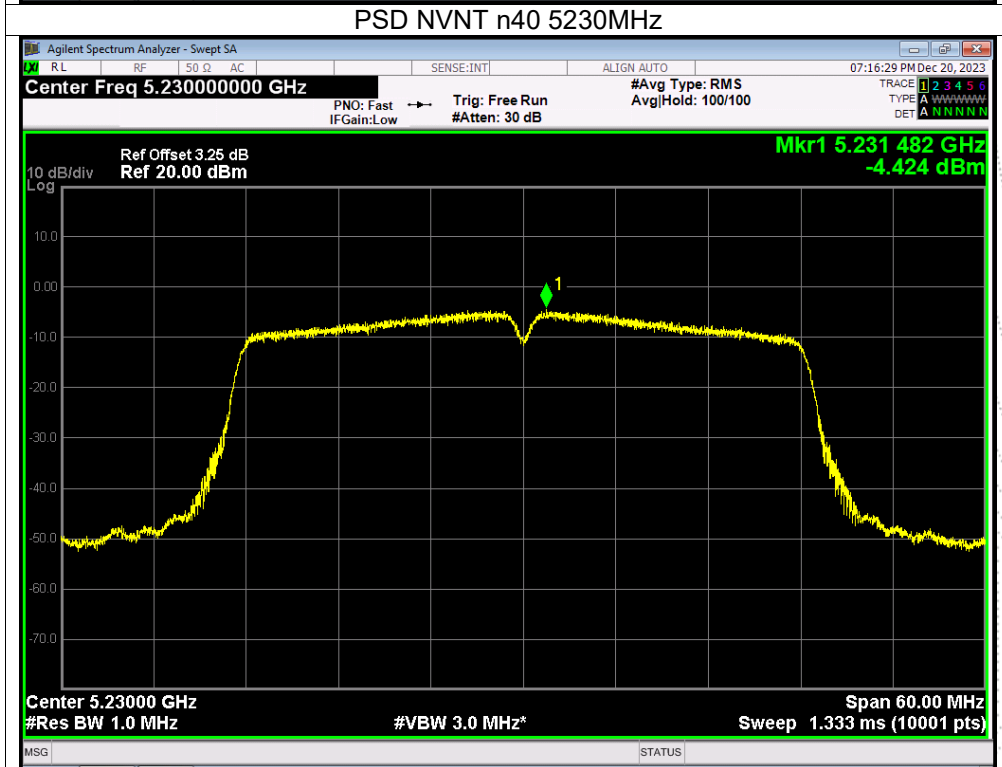
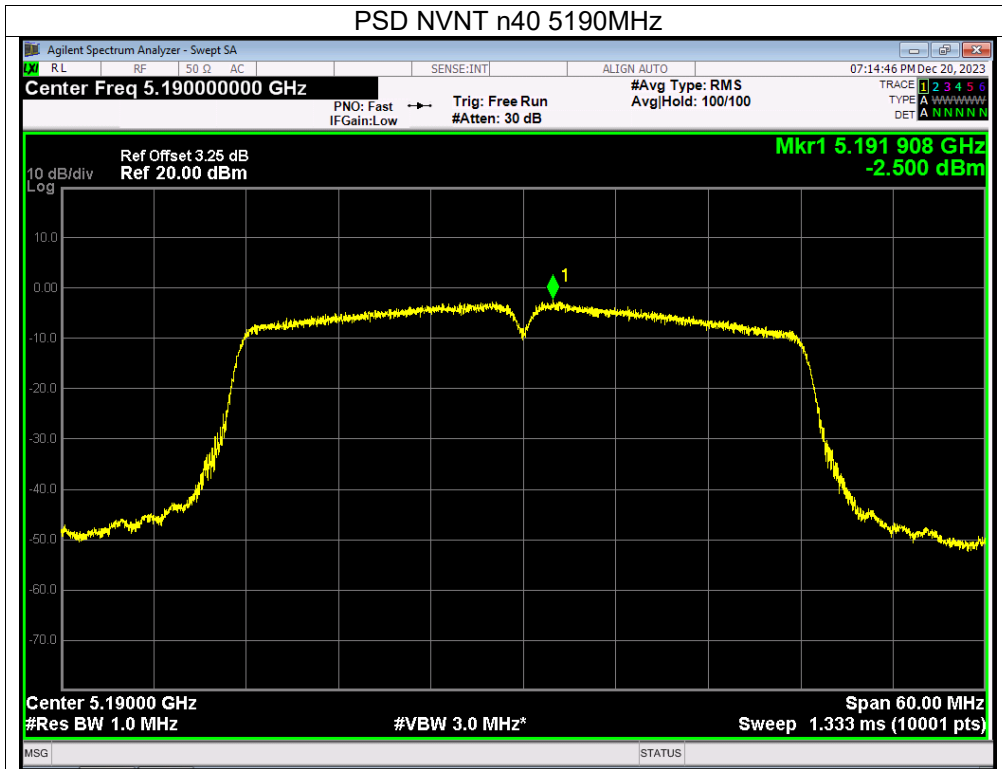

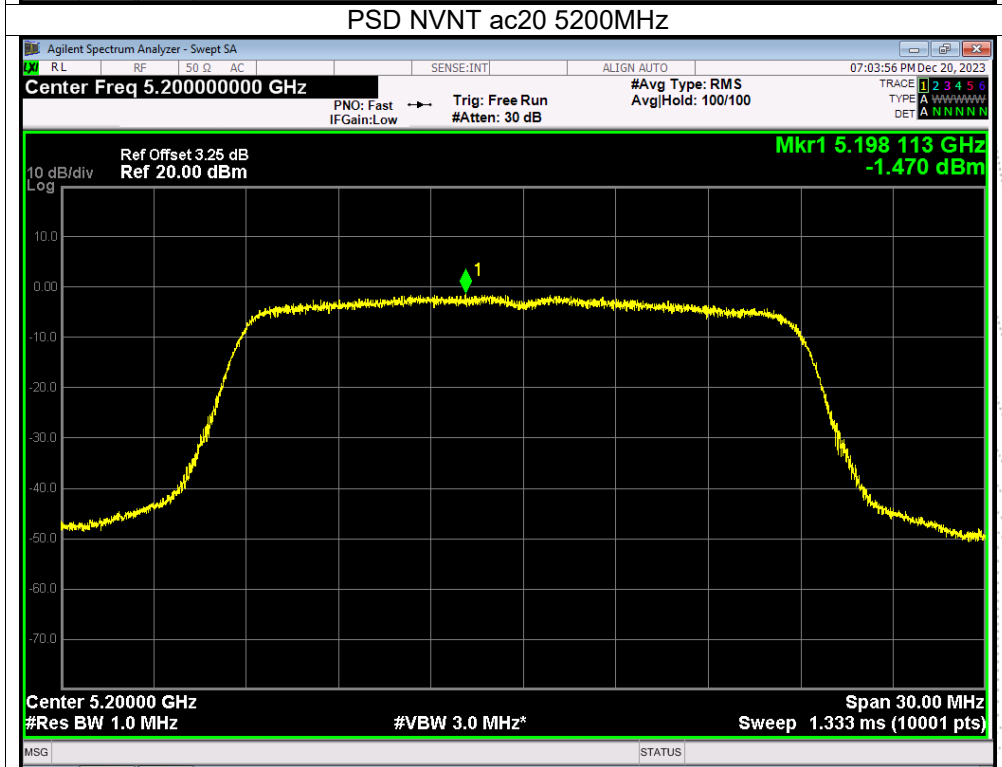
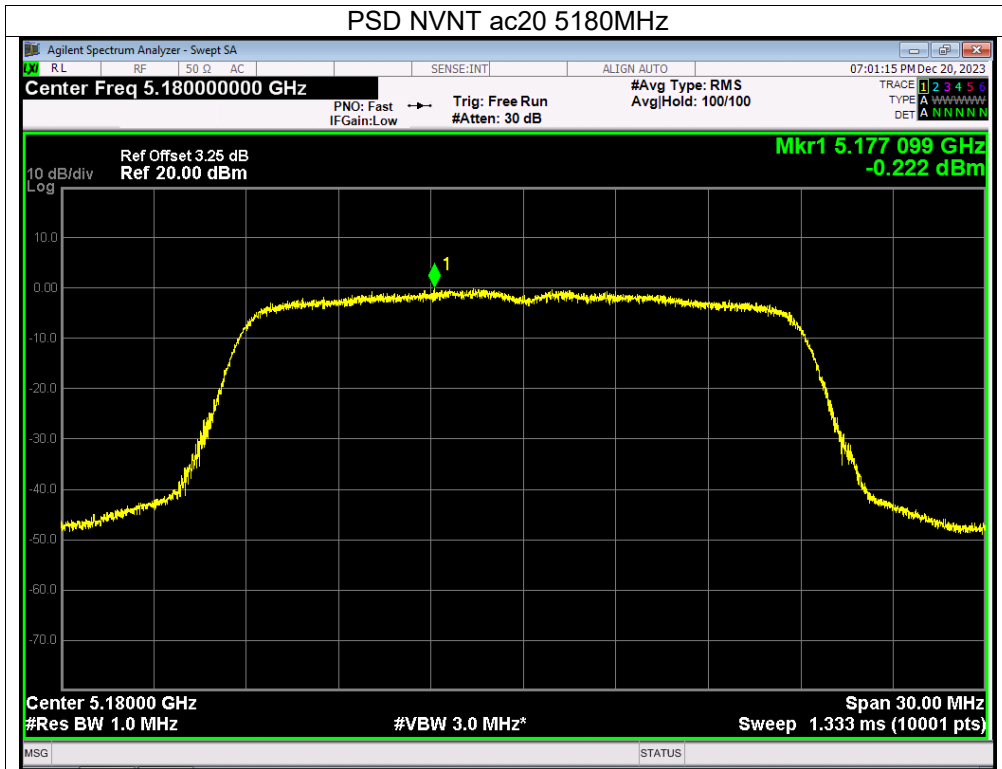

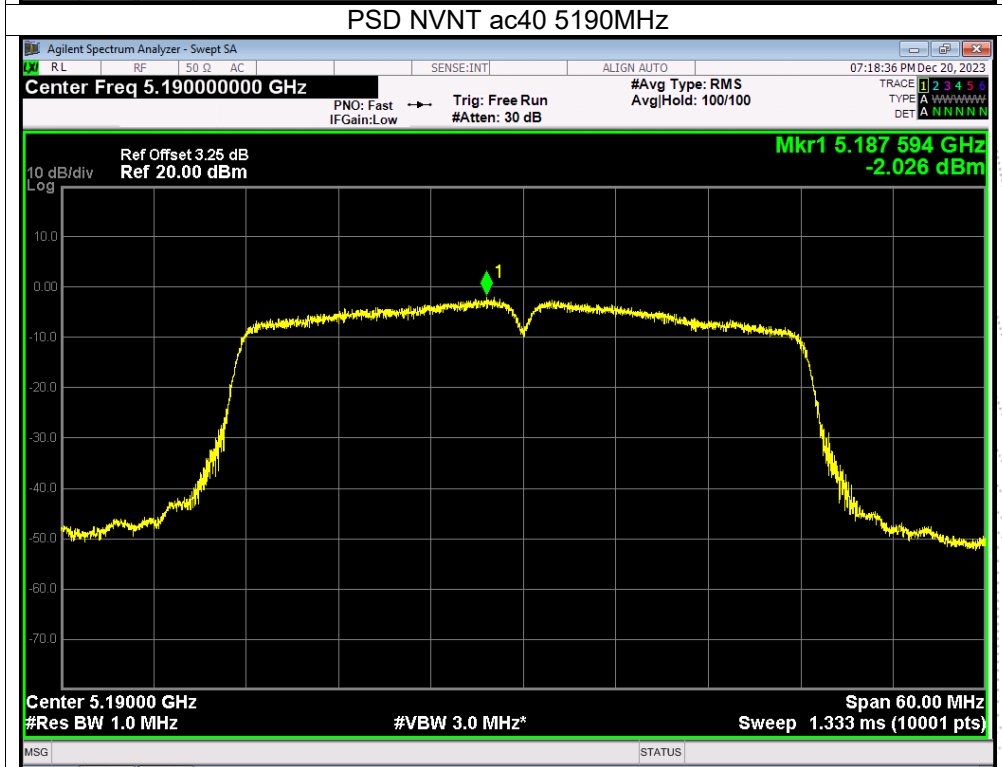
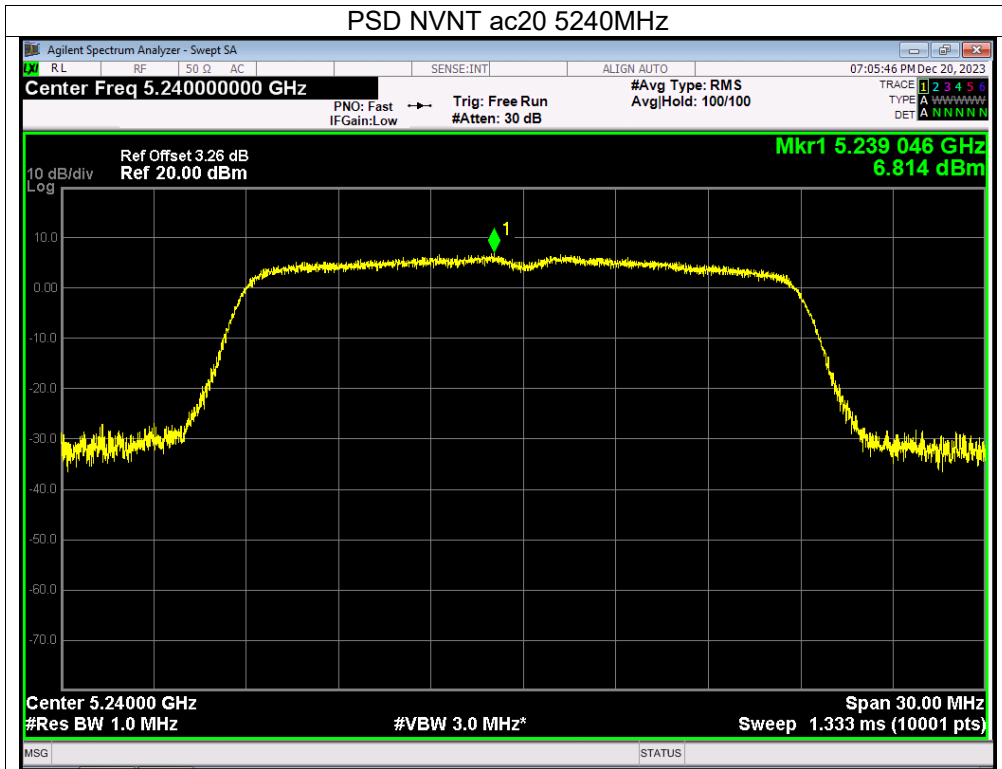

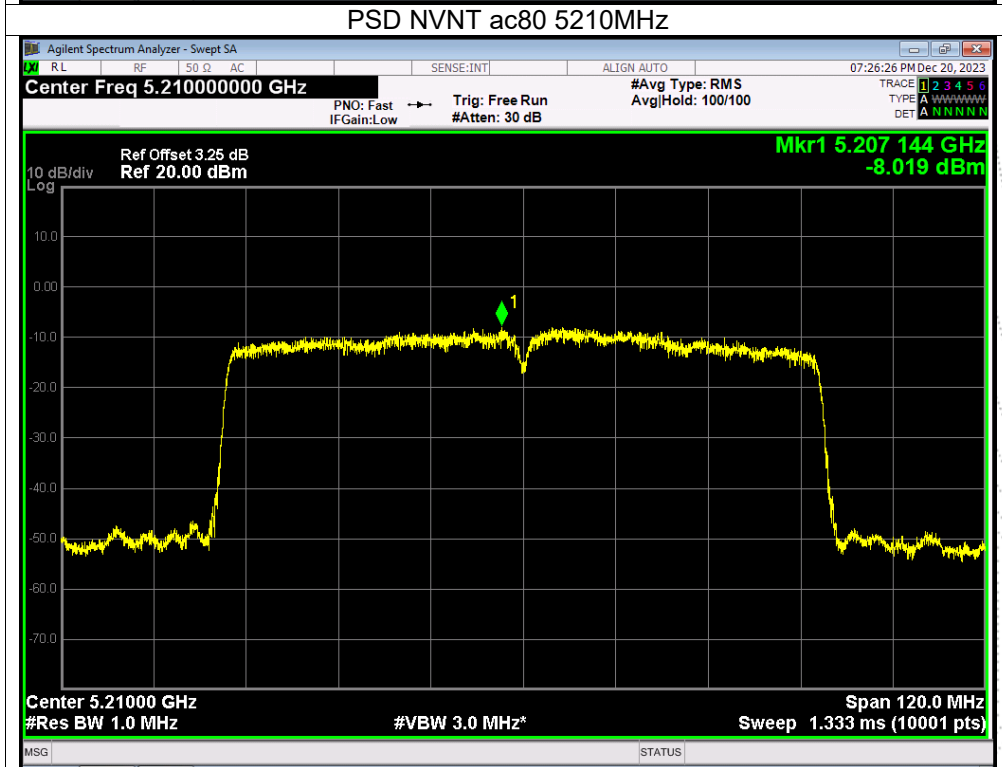
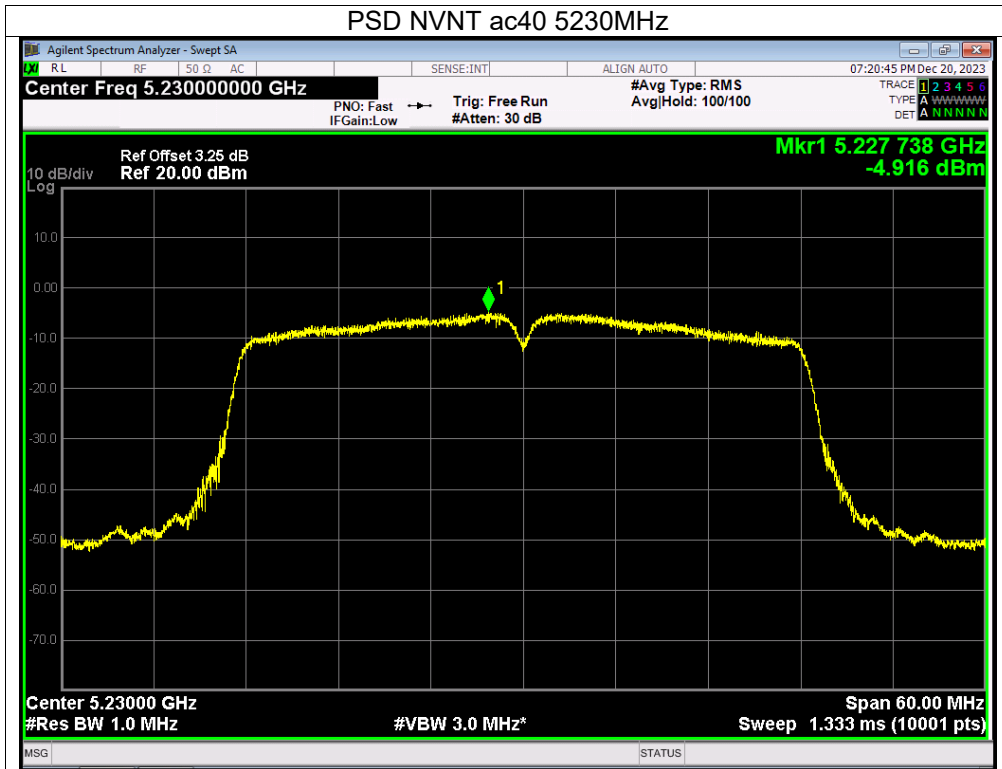

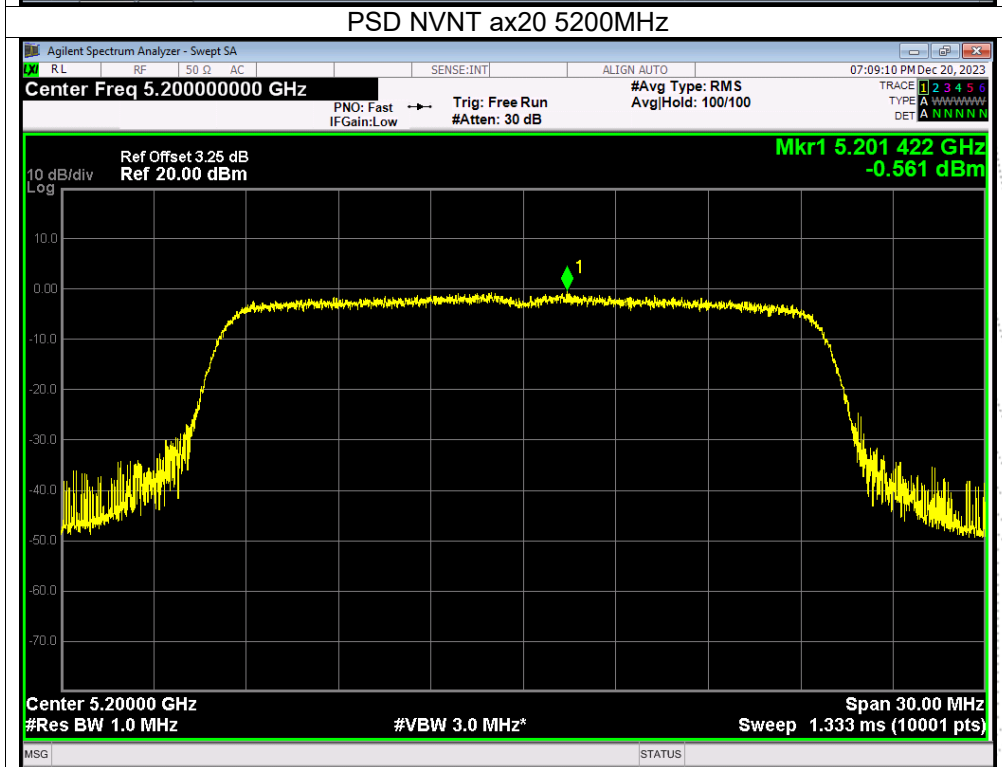
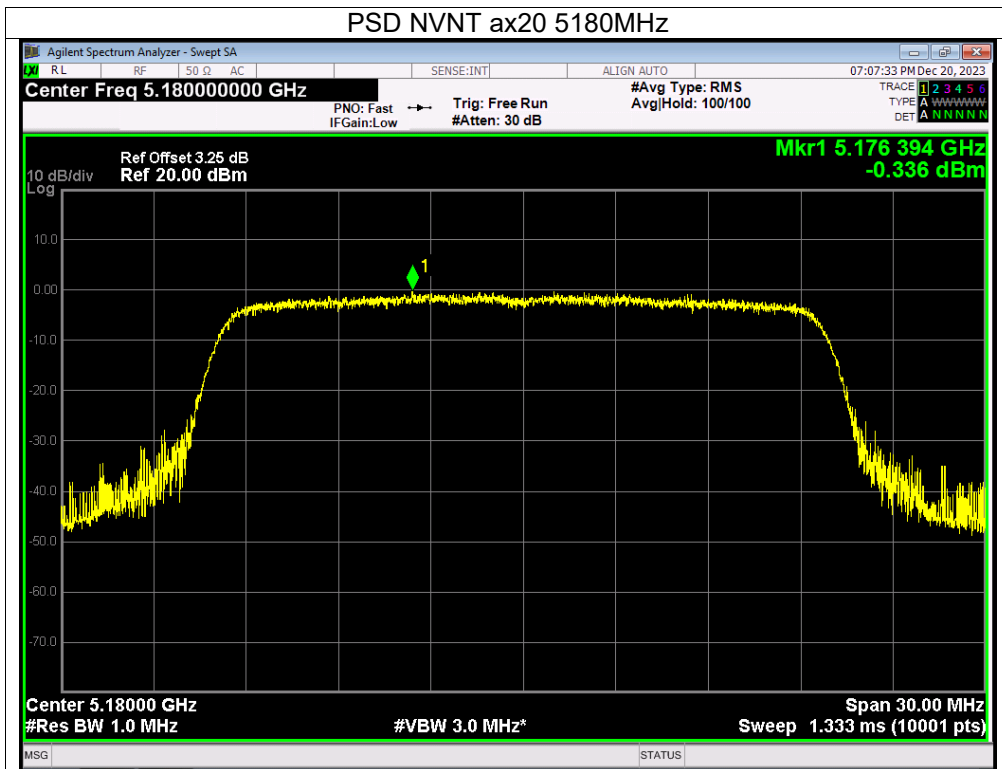

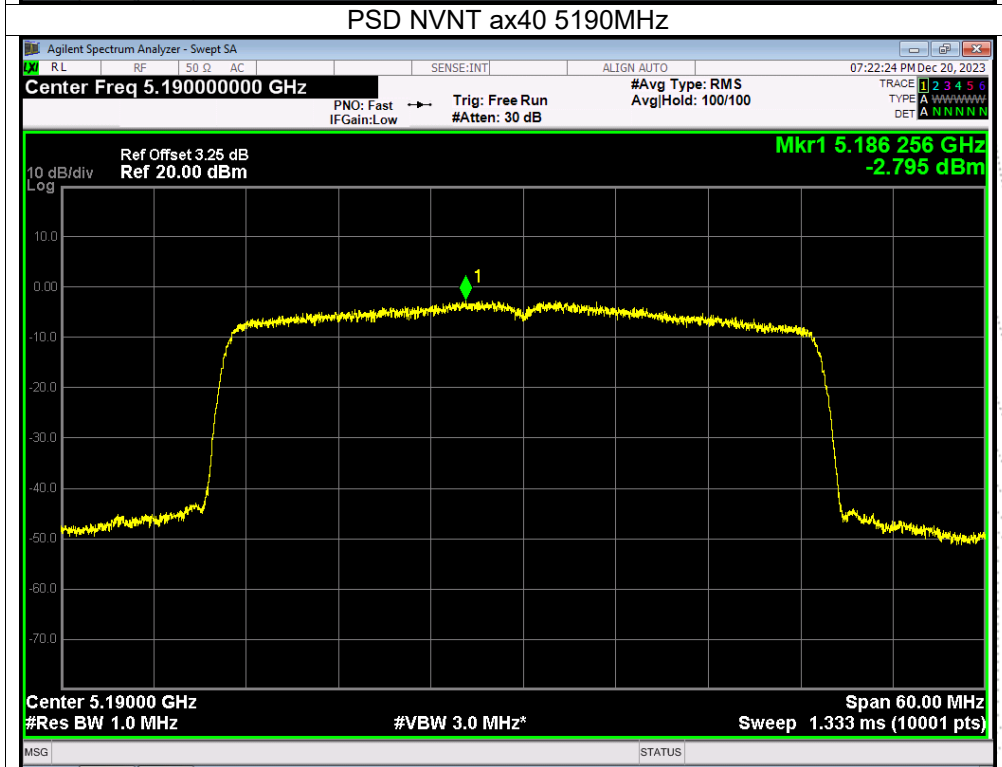
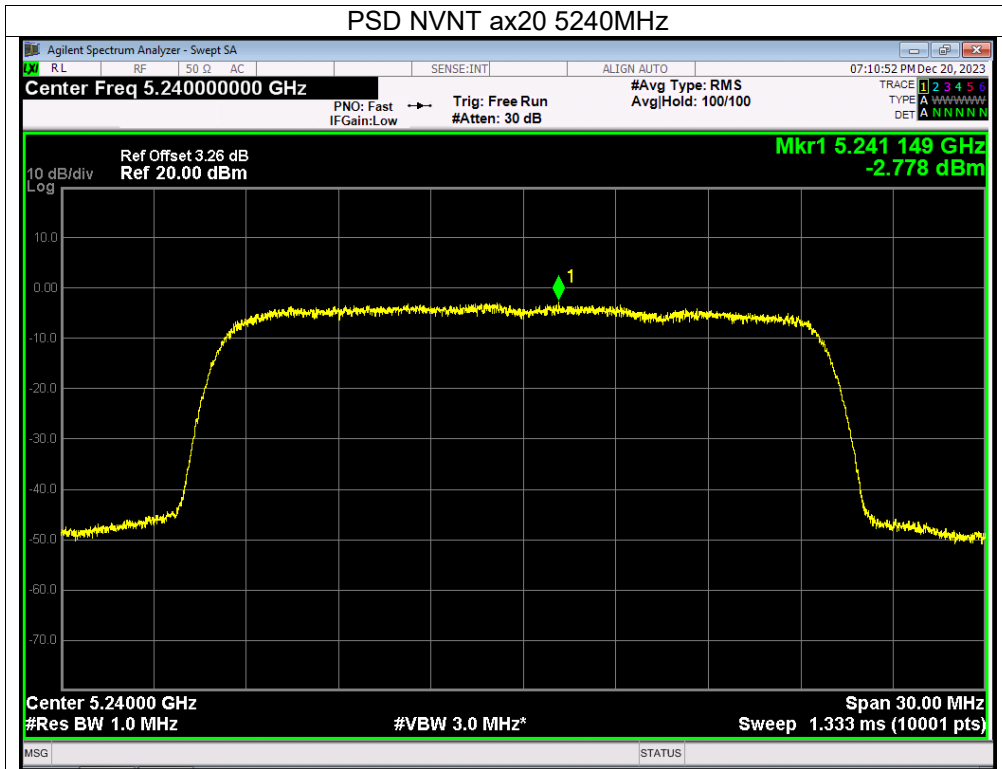

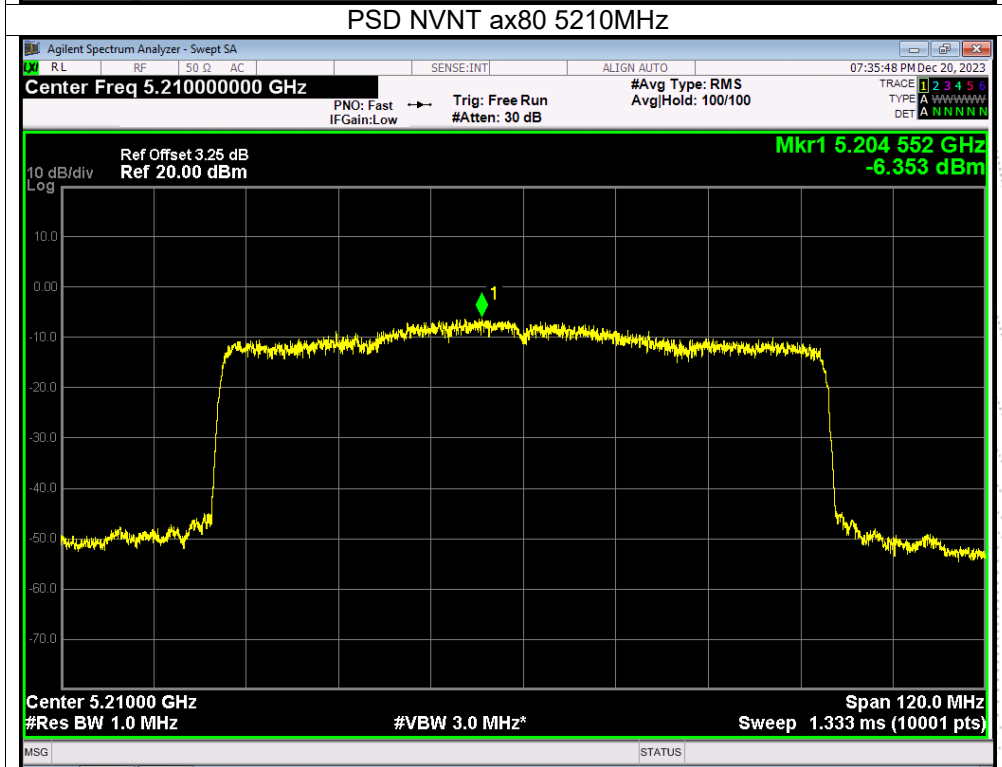
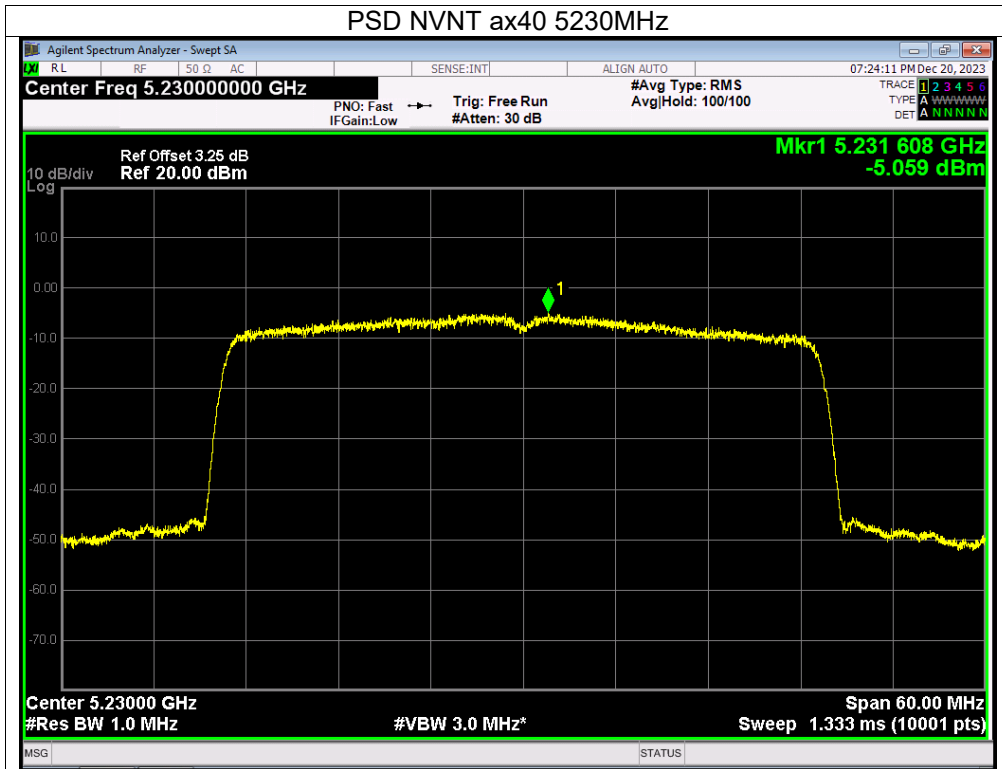

Temperature:	26 °C	Relative Humidity:	54%
Pressure:	101kPa	Test Voltage:	DC 12V
Test Mode:	TX Frequency U-NII-3 (5745-5825MHz)		

Mode	Fre- quency (MHz)	Measured Power Density (dBm/510KHz)		Measured Power Density (dBm/500KHz)			Limit (dBm/ 500kHz)	Result
		ANT A	ANT B	ANT A	ANT B	Total		
a	5745	-2.46	4.06	-2.546	3.974	/	30	PASS
a	5785	-2.88	3.67	-2.966	3.584	/	30	PASS
a	5825	-3.91	3.45	-3.996	3.364	/	30	PASS
n20	5745	-3.86	2.22	-3.946	2.134	3.09	27.75	PASS
n20	5785	-4.57	2.75	-4.656	2.664	3.40	27.75	PASS
n20	5825	-5.37	1.15	-5.456	1.064	1.94	27.75	PASS
n40	5755	-6.53	-1.29	-6.616	-1.376	-0.24	27.75	PASS
n40	5795	-6.86	-1.56	-6.946	-1.646	-0.52	27.75	PASS
ac20	5745	3.25	3.37	3.164	3.284	6.23	27.75	PASS
ac20	5785	2.54	4.43	2.454	4.344	6.51	27.75	PASS
ac20	5825	2.39	2.86	2.304	2.774	5.56	27.75	PASS
ac40	5755	0.19	0.88	0.104	0.794	3.47	27.75	PASS
ac40	5795	0.25	0.63	0.164	0.544	3.37	27.75	PASS
ac80	5775	-1.67	0.02	-1.756	-0.066	2.18	27.75	PASS
ax20	5745	-4.16	-4.82	-4.246	-4.906	-1.55	27.75	PASS
ax20	5785	-4.27	-4.73	-4.356	-4.816	-1.57	27.75	PASS
ax20	5825	-5.53	-5.37	-5.616	-5.456	-2.52	27.75	PASS
ax40	5755	-6.93	-8.27	-7.016	-8.356	-4.62	27.75	PASS
ax40	5795	-6.57	-8.67	-6.656	-8.756	-4.57	27.75	PASS
ax80	5775	-11.19	-10.97	-11.276	-11.056	-8.15	27.75	PASS

Note: Correct Factor=10log(500kHz/RBW in measurement)=-0.086

For MIMO mode:

Antenna A gain:5.24dBi, Antenna B gain: 5.24dBi, Directional gain=[GainANT + 10 log(NANT/NSS) dBi]
=8.25dbi>6dbi

Limit=30-(8.25-6)=27.75 dbi

Note: A(B) Represent the value of antenna A and B, The worst data is Antenna B, only shown Antenna B Plot.



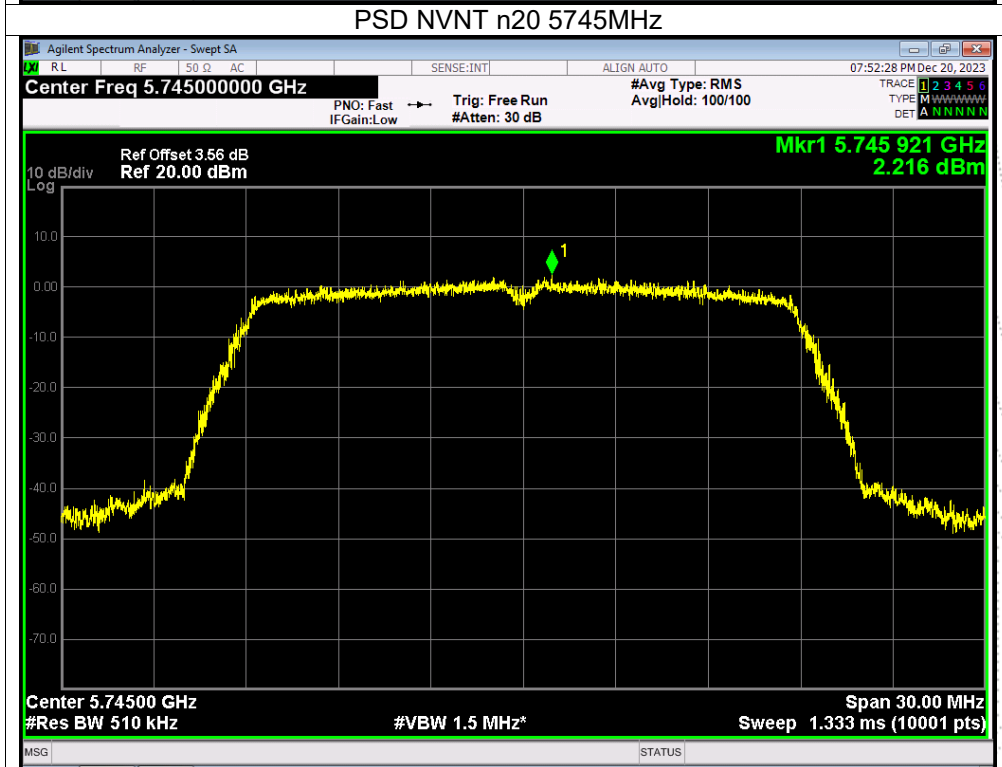
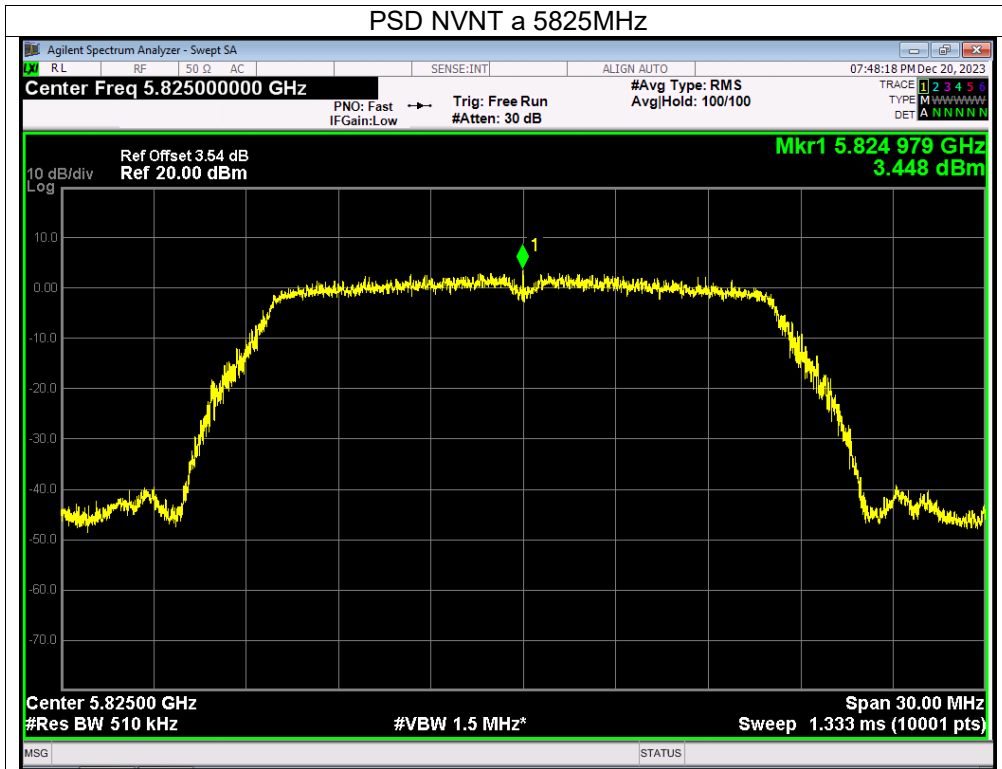

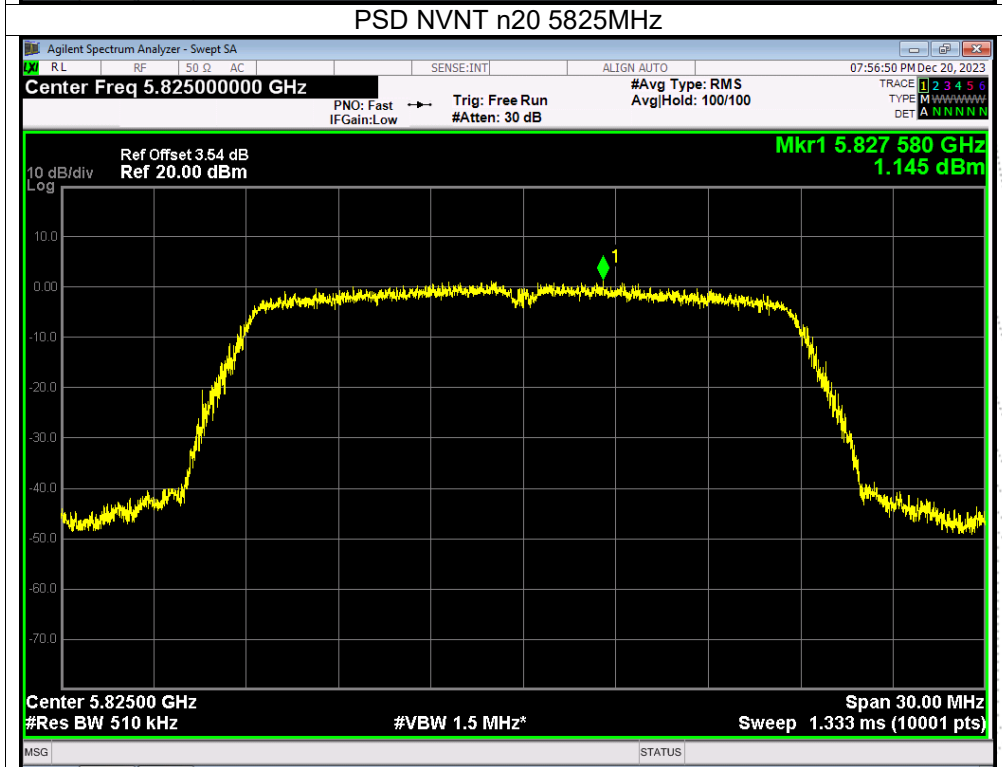
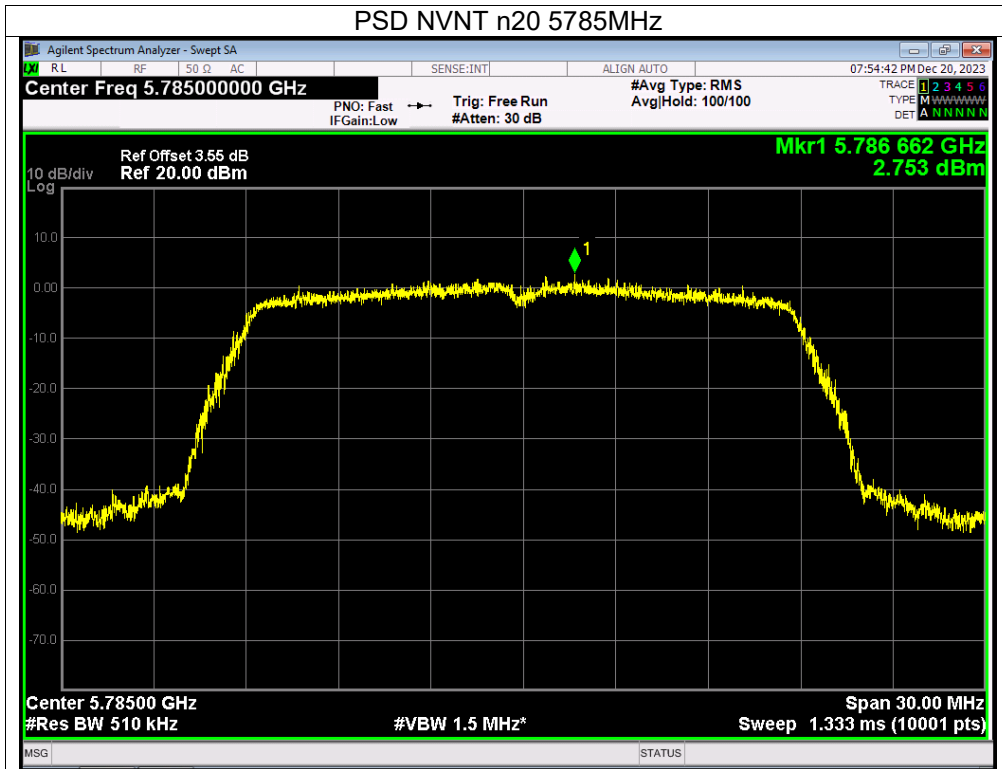

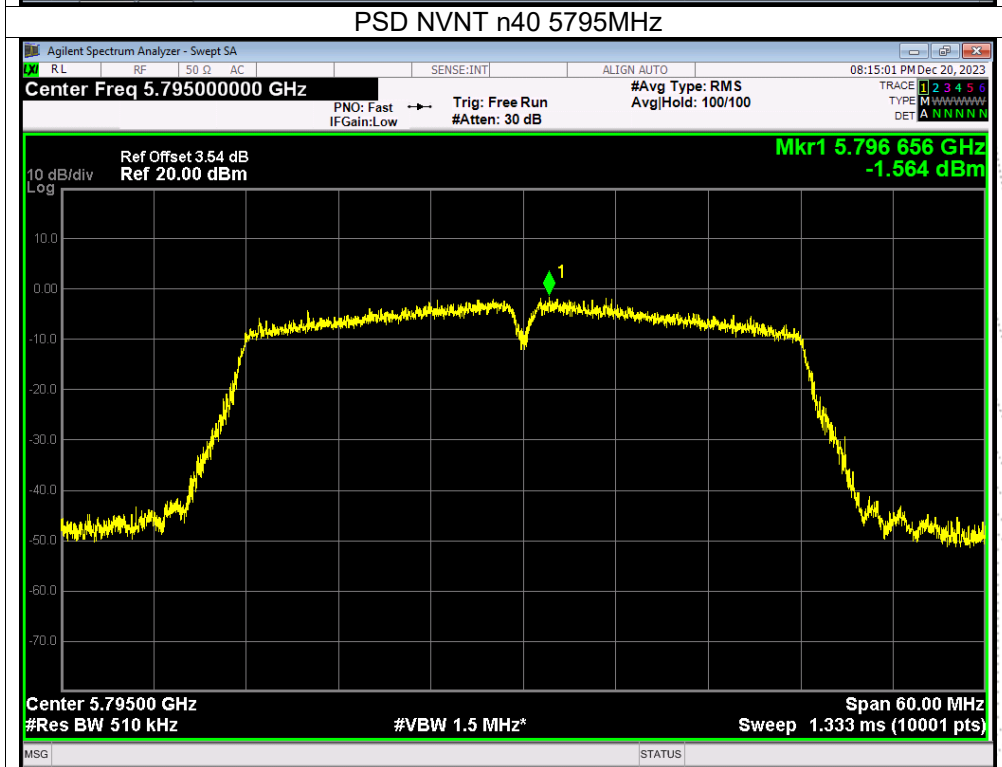
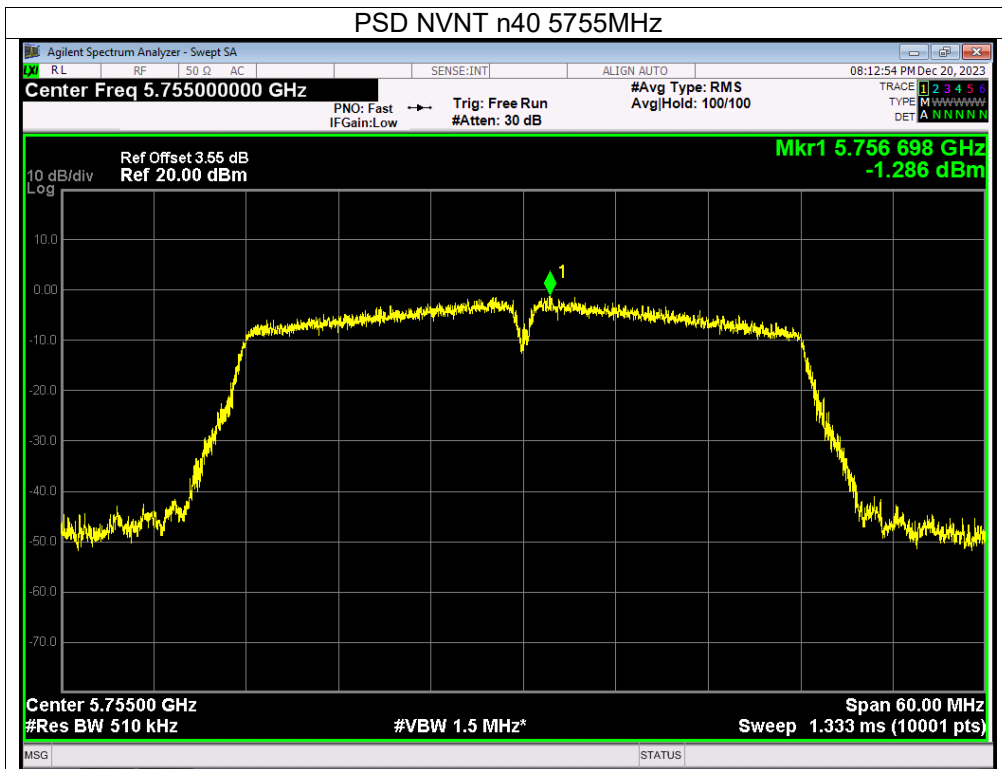

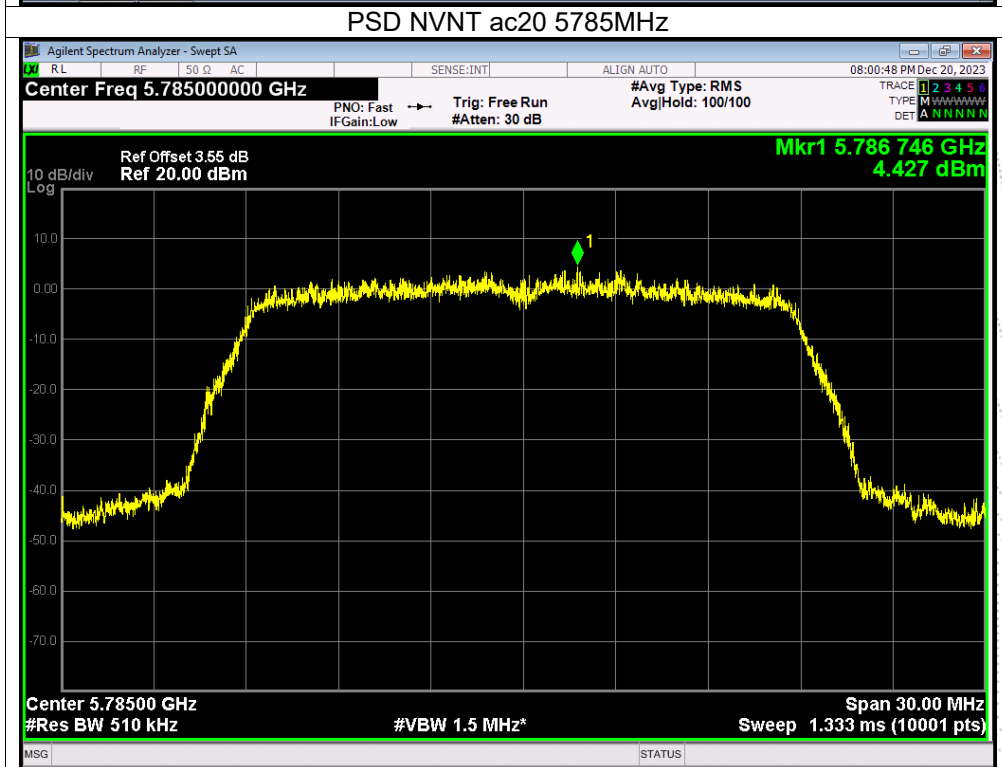
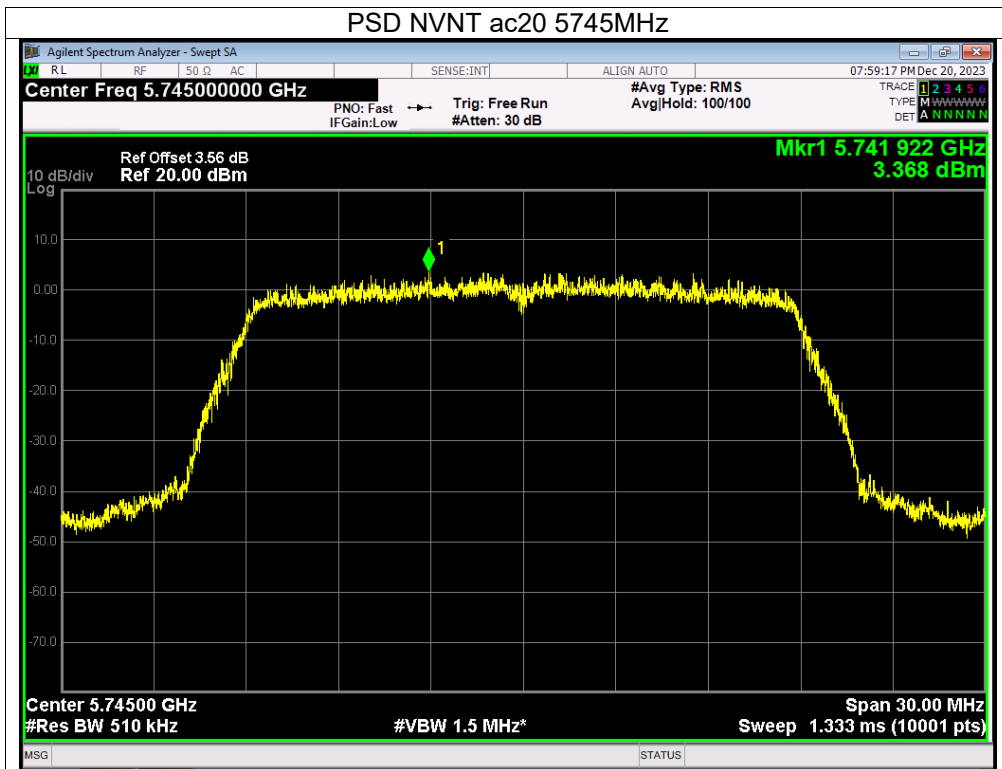

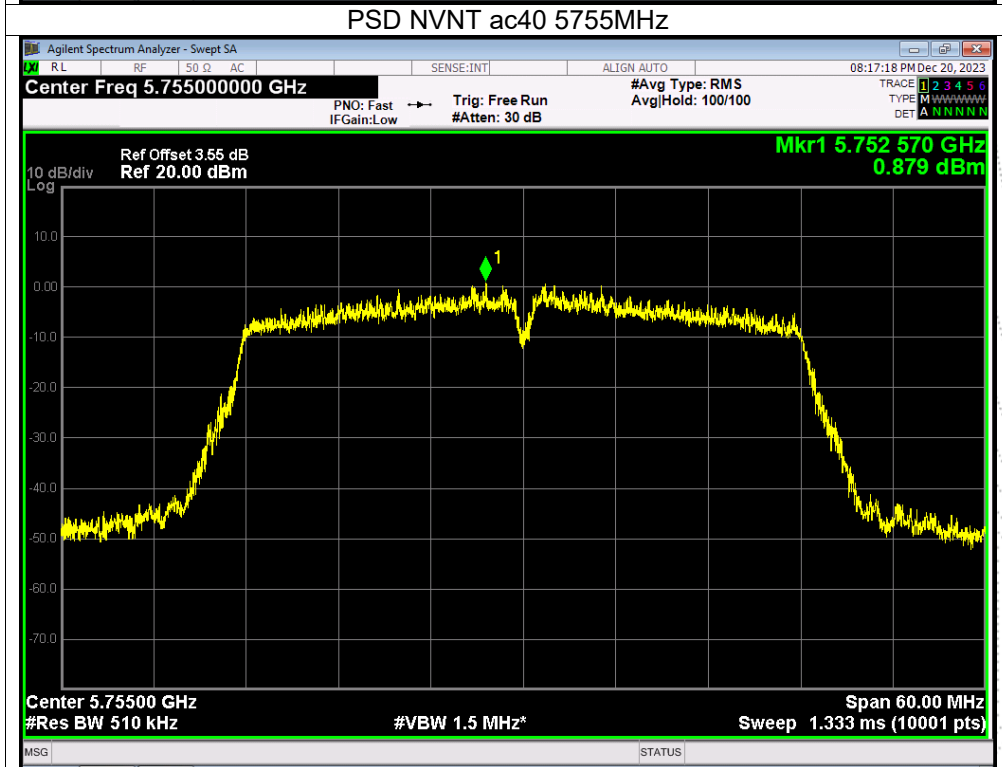
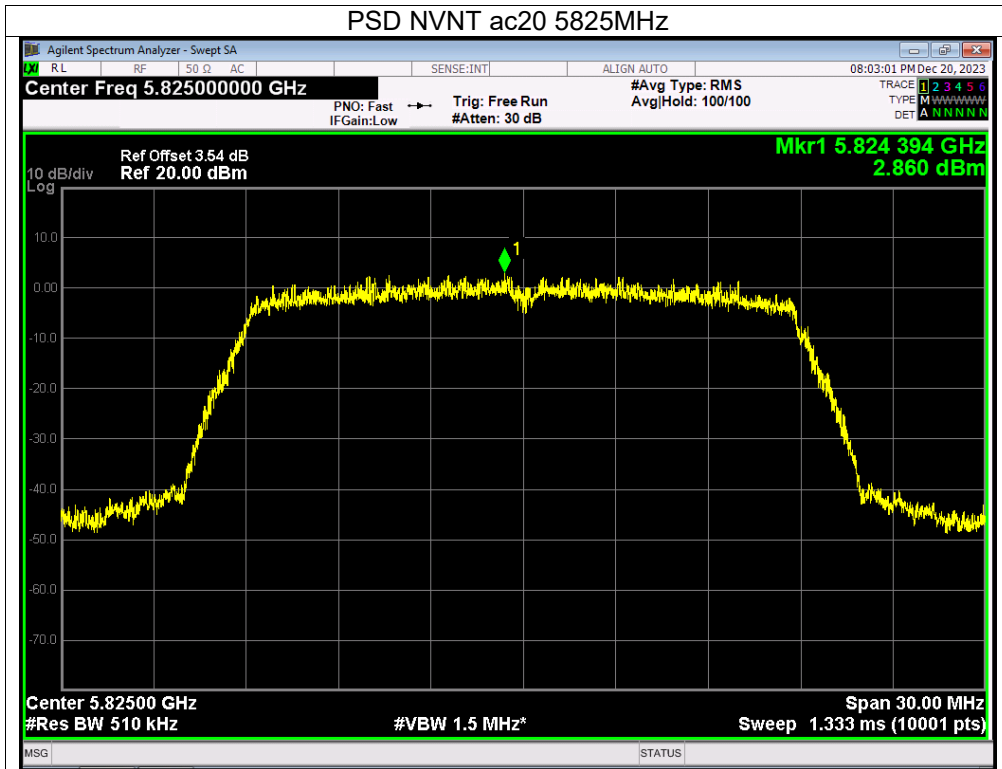

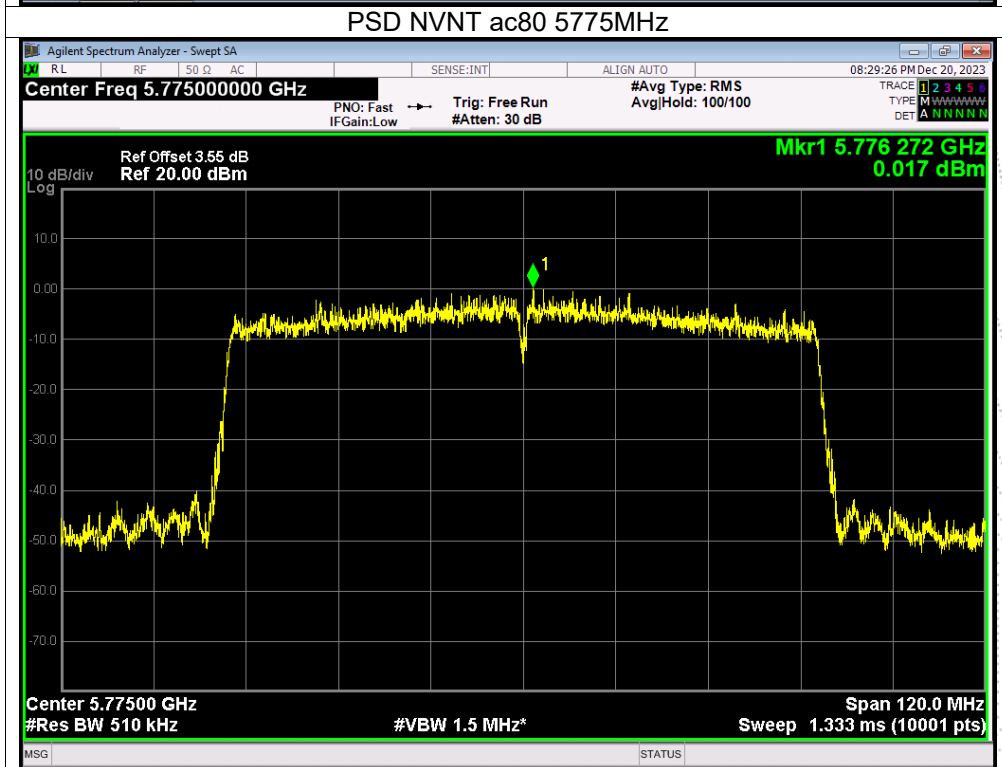
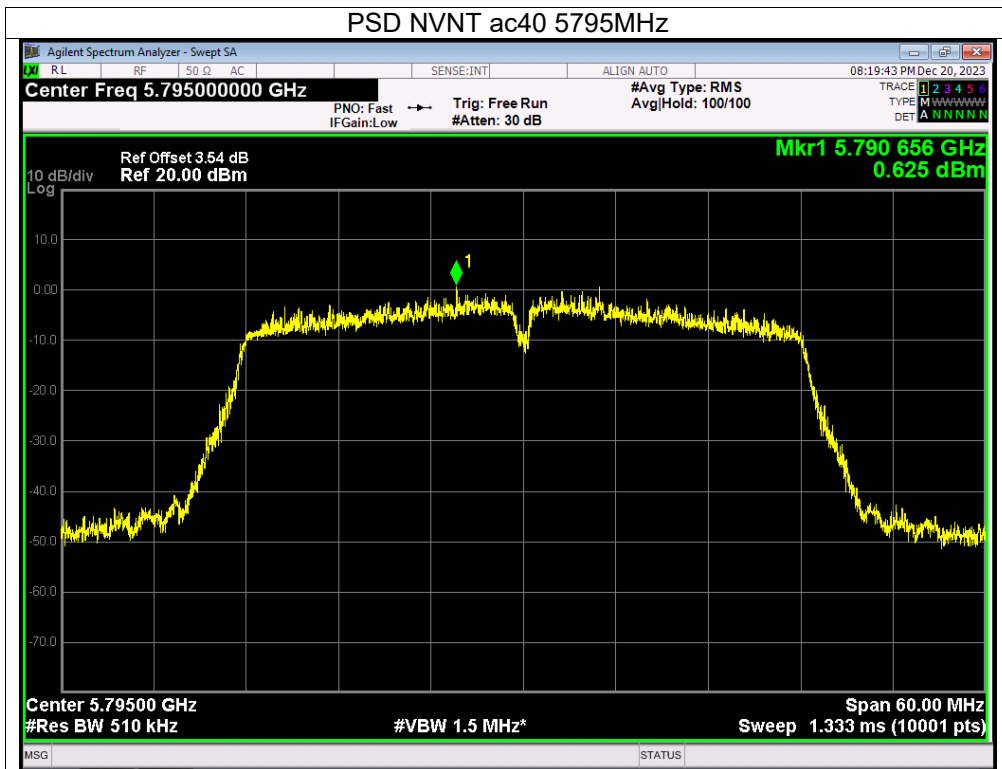

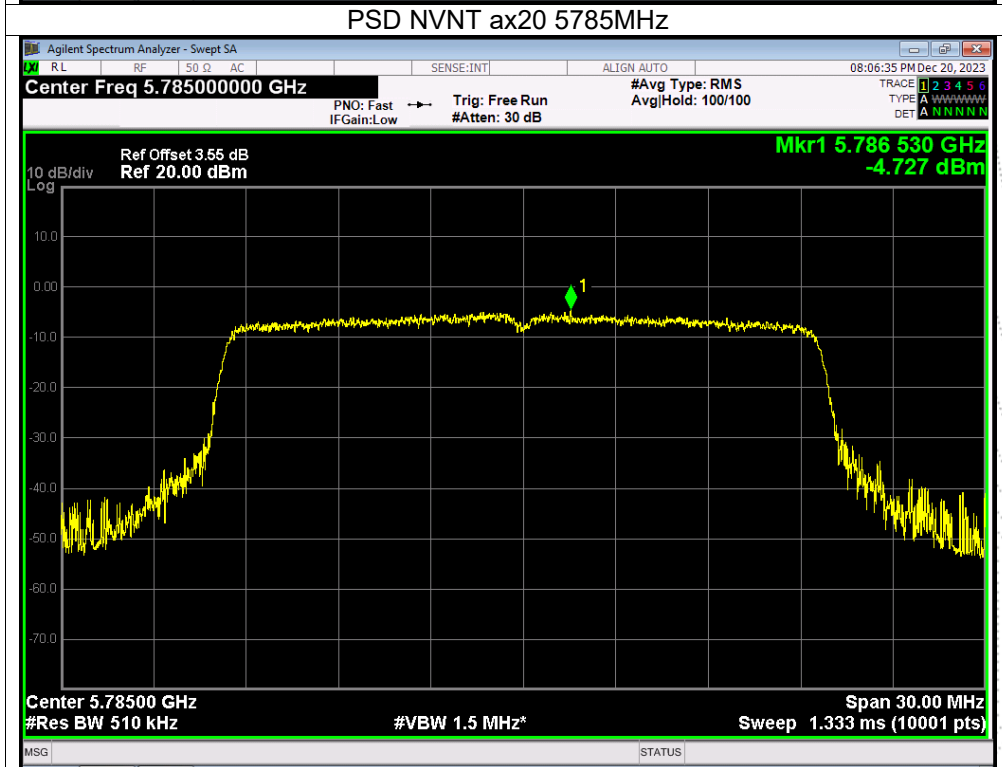
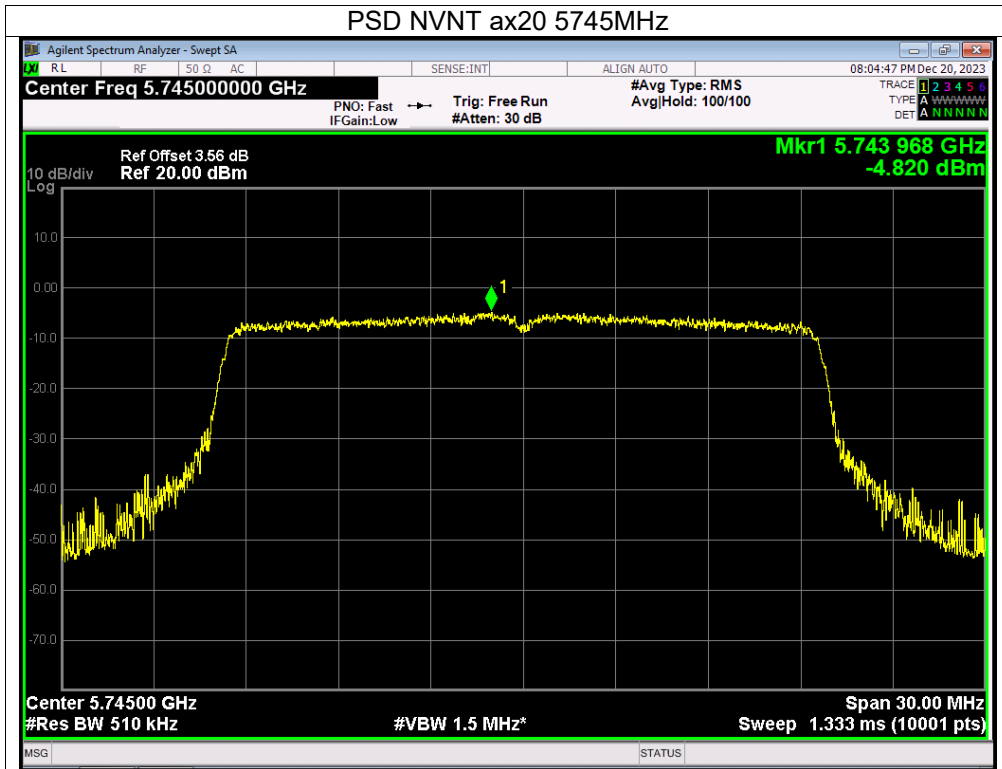

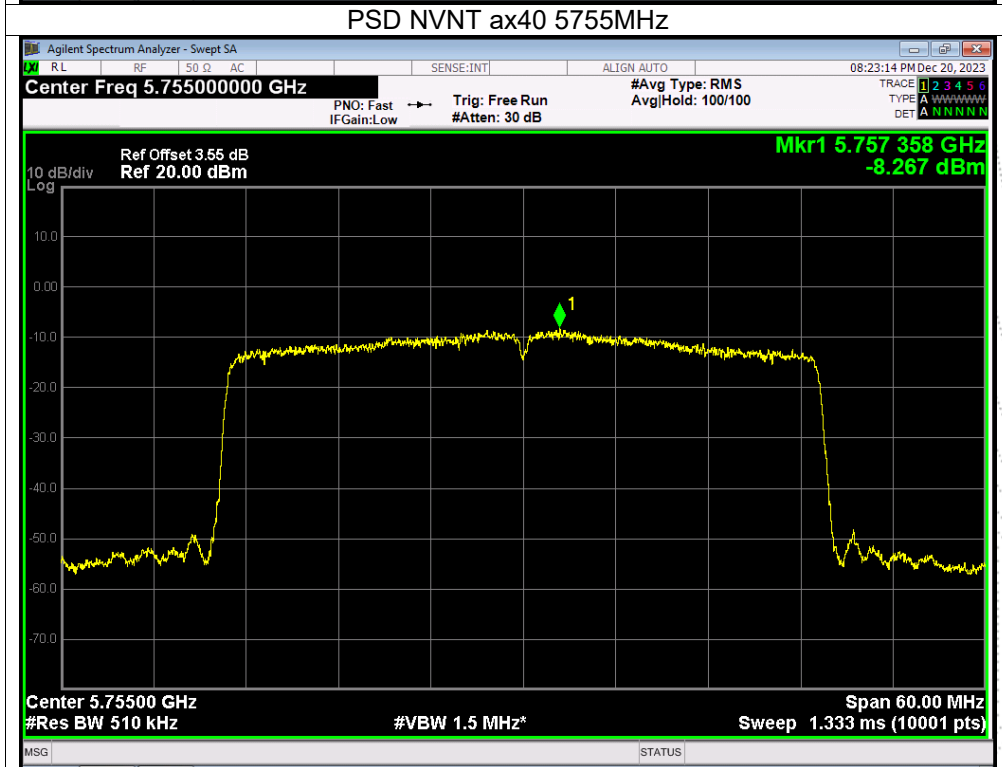
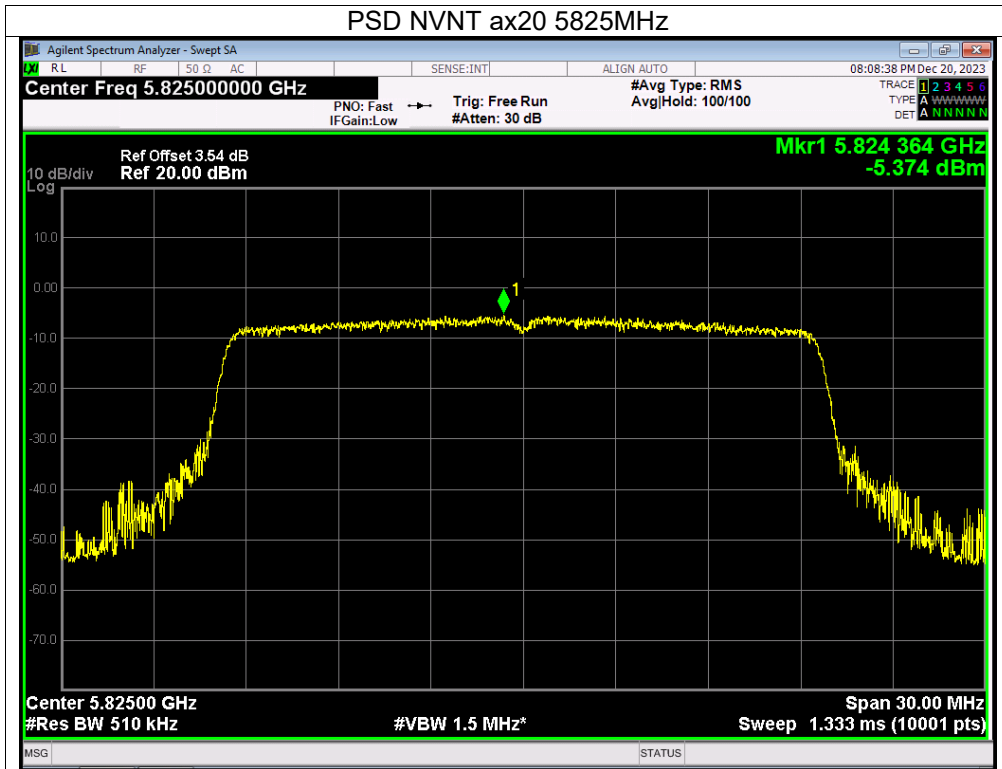

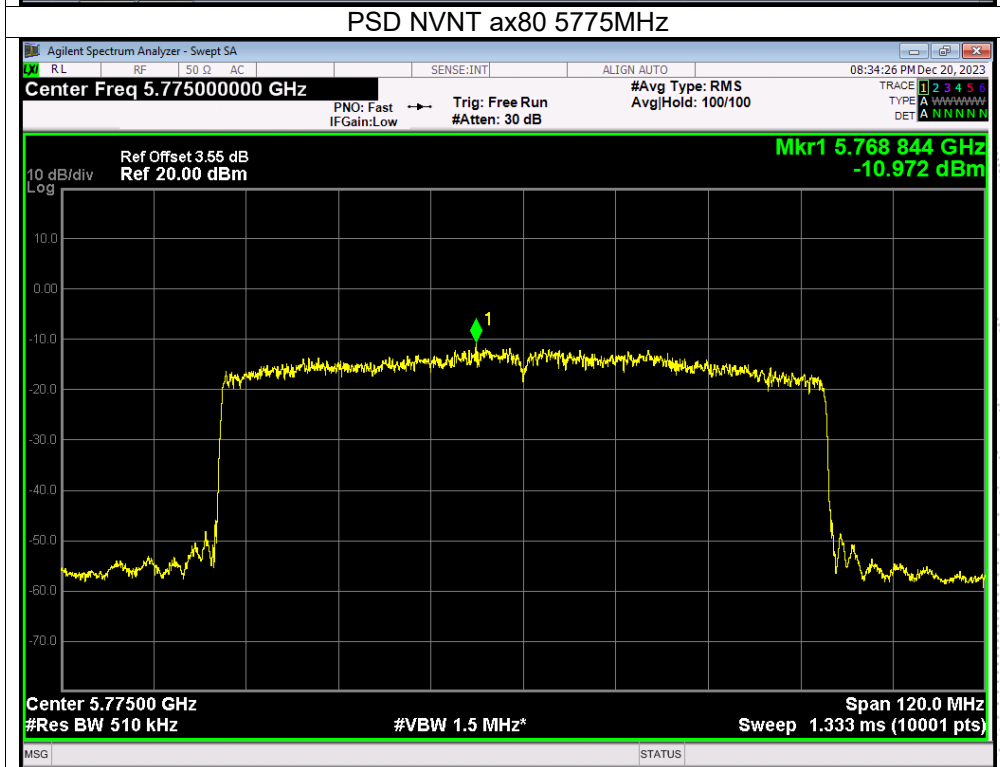
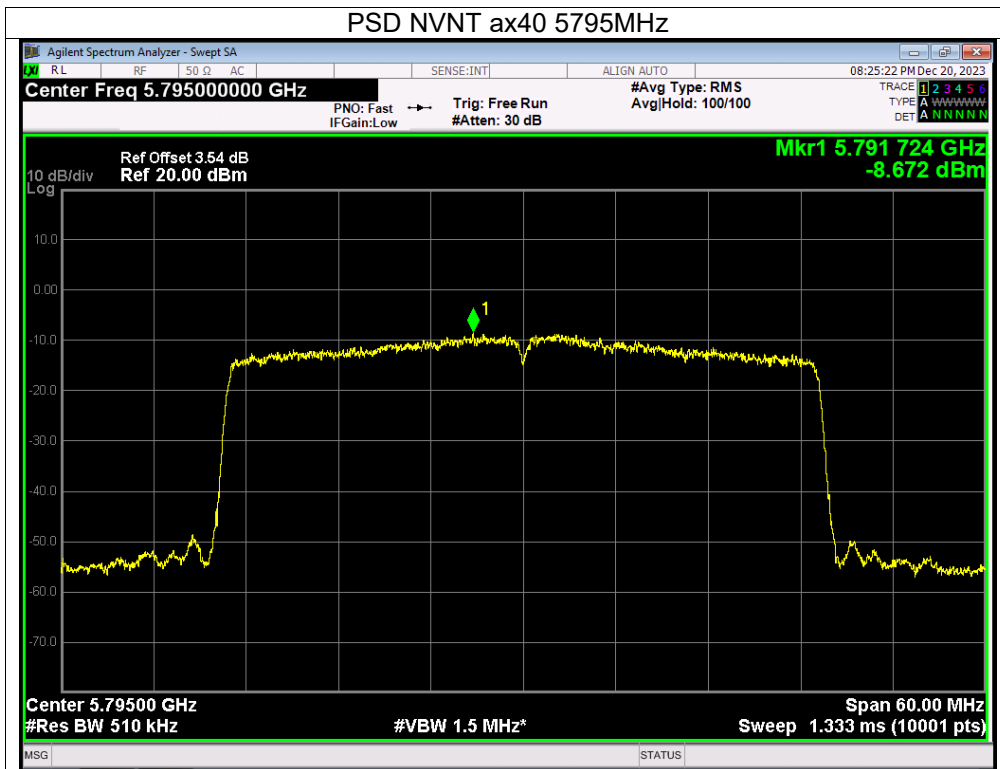

9. 26dB & 6dB & 99% Emission Bandwidth

9.1 Block Diagram Of Test Setup

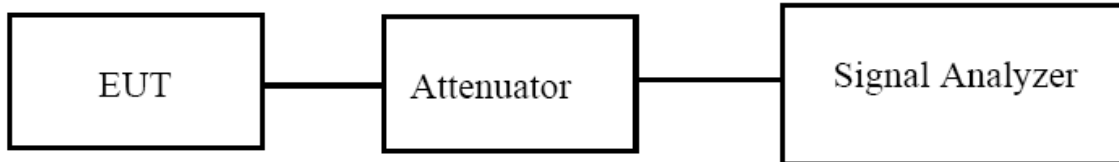

9.2 Limit

The maximum power spectral density is measured as a conducted emission by direct connection of a calibrated test instrument to the equipment under test. If the device cannot be connected directly, alternative techniques acceptable to the Commission may be used. Measurements in the 5.725-5.85 GHz band are made over a reference bandwidth of 500 kHz or the 26 dB emission bandwidth of the device, whichever is less. Measurements in the 5.15-5.25 GHz, 5.25-5.35 GHz, and the 5.47-5.725 GHz bands are made over a bandwidth of 1 MHz or the 26 dB emission bandwidth of the device, whichever is less. A narrower resolution bandwidth can be used, provided that the measured power is integrated over the full reference bandwidth.
(6dB bandwidth)>500kHz

9.3 Test Procedure

- a) Set RBW = approximately 1% of the emission bandwidth.
- b) Set the VBW > RBW.
- c) Detector = Peak.
- d) Trace mode = max hold.
- e) Measure the maximum width of the emission that is 26 dB down from the maximum of the emission. Compare this with the RBW setting of the analyzer. Readjust RBW and repeat measurement as needed until the RBW/EBW ratio is approximately 1%.

The following procedure shall be used for measuring (99 %) power bandwidth:

1. Set center frequency to the nominal EUT channel center frequency.
2. Set span = 1.5 times to 5.0 times the OBW.
3. Set RBW = 1 % to 5 % of the OBW
4. Set VBW $\geq 3 \cdot$ RBW
5. Video averaging is not permitted. Where practical, a sample detection and single sweep mode shall be used. Otherwise, peak detection and max hold mode (until the trace stabilizes) shall be used.
6. Use the 99 % power bandwidth function of the instrument (if available).
7. If the instrument does not have a 99 % power bandwidth function, the trace data points are recovered and directly summed in power units. The recovered amplitude data points, beginning at the lowest frequency, are placed in a running sum until 0.5 % of the total is reached; that frequency is recorded as the lower frequency. The process is repeated until 99.5 % of the total is reached; that frequency is recorded as the upper frequency. The 99% occupied bandwidth is the difference between these two frequencies.

6dB

1. Set RBW = 100 kHz.
2. Set the video bandwidth (VBW) $\geq 3 \times$ RBW.
3. Detector = Peak.
4. Trace mode = max hold.
5. Sweep = auto couple.

6. Allow the trace to stabilize.

7. Measure the maximum width of the emission that is constrained by the frequencies associated with the two outermost amplitude points (upper and lower frequencies) that are attenuated by 6 dB relative to the maximum level measured in the fundamental emission.

9.4 EUT Operating Conditions

The EUT was configured for testing in a typical fashion (as a customer would normally use it). The EUT has been programmed to continuously transmit during test. This operating condition was tested and used to collect the included data.

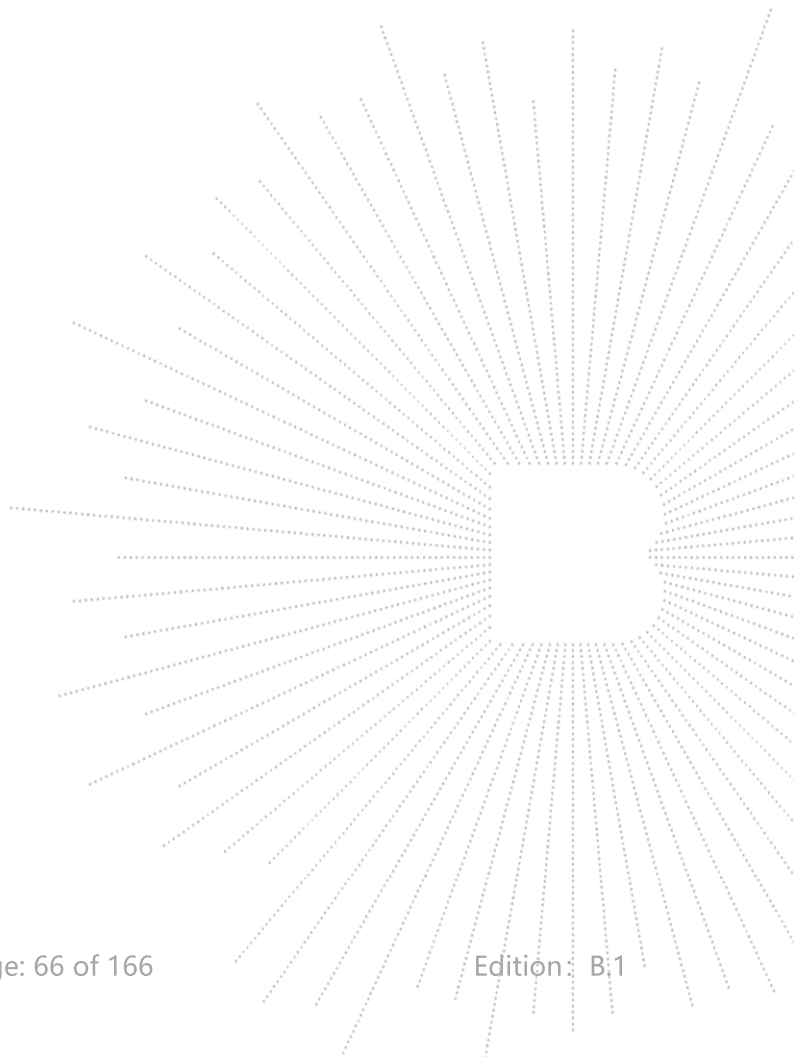

9.5 Test Result

Temperature:	26 °C	Relative Humidity:	54%
Pressure:	101kPa	Test Voltage:	DC 12V
Test Mode:	TX Frequency U-NII-1 (5180-5240MHz)		

Condition	Mode	Frequency (MHz)	26dB bandwidth (MHz)		Result
			ANT A	ANT B	
NVNT	a	5180	20.343	20.024	Pass
NVNT	a	5200	20.162	19.884	Pass
NVNT	a	5240	19.976	19.954	Pass
NVNT	n20	5180	20.459	20.355	Pass
NVNT	n20	5200	20.371	20.434	Pass
NVNT	n20	5240	20.54	20.356	Pass
NVNT	n40	5190	41.013	40.765	Pass
NVNT	n40	5230	40.342	41.539	Pass
NVNT	ac20	5180	20.372	20.259	Pass
NVNT	ac20	5200	20.527	20.041	Pass
NVNT	ac20	5240	20.528	21.087	Pass
NVNT	ac40	5190	40.592	40.428	Pass
NVNT	ac40	5230	41.113	40.818	Pass
NVNT	ac80	5210	79.523	79.344	Pass
NVNT	ax20	5180	23.169	24.391	Pass
NVNT	ax20	5200	21.935	24.196	Pass
NVNT	ax20	5240	19.855	19.904	Pass
NVNT	ax40	5190	39.085	39.214	Pass
NVNT	ax40	5230	39.063	39.202	Pass
NVNT	ax80	5210	79.16	79.072	Pass

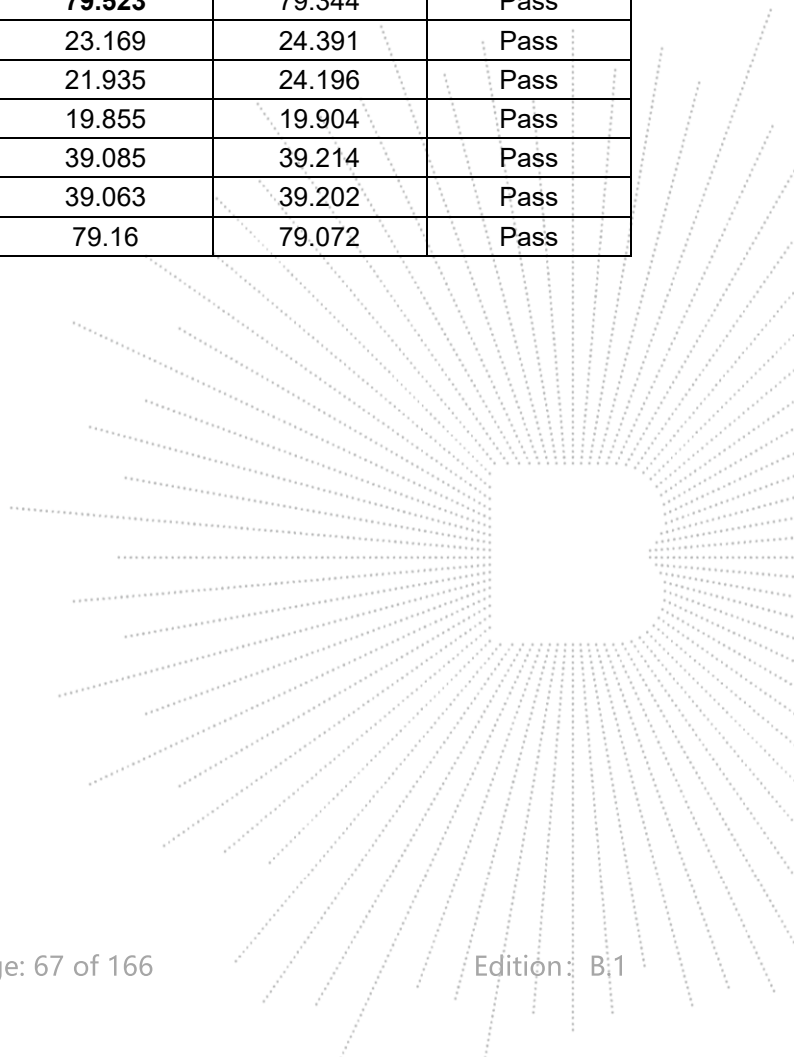

Condition	Mode	Frequency (MHz)	99% bandwidth (MHz)		Result
			ANT A	ANT B	
NVNT	a	5180	16.486	16.493	Pass
NVNT	a	5200	16.456	16.435	Pass
NVNT	a	5240	16.481	16.493	Pass
NVNT	n20	5180	17.598	17.631	Pass
NVNT	n20	5200	17.62	17.606	Pass
NVNT	n20	5240	17.598	17.587	Pass
NVNT	n40	5190	35.8	35.73	Pass
NVNT	n40	5230	35.813	35.861	Pass
NVNT	ac20	5180	17.597	17.607	Pass
NVNT	ac20	5200	17.587	17.581	Pass
NVNT	ac20	5240	17.571	17.619	Pass
NVNT	ac40	5190	35.806	35.81	Pass
NVNT	ac40	5230	35.909	35.868	Pass
NVNT	ac80	5210	75.216	74.964	Pass
NVNT	ax20	5180	18.981	18.987	Pass
NVNT	ax20	5200	18.955	18.918	Pass
NVNT	ax20	5240	18.865	18.864	Pass
NVNT	ax40	5190	37.542	37.545	Pass
NVNT	ax40	5230	37.496	37.516	Pass
NVNT	ax80	5210	76.505	76.474	Pass

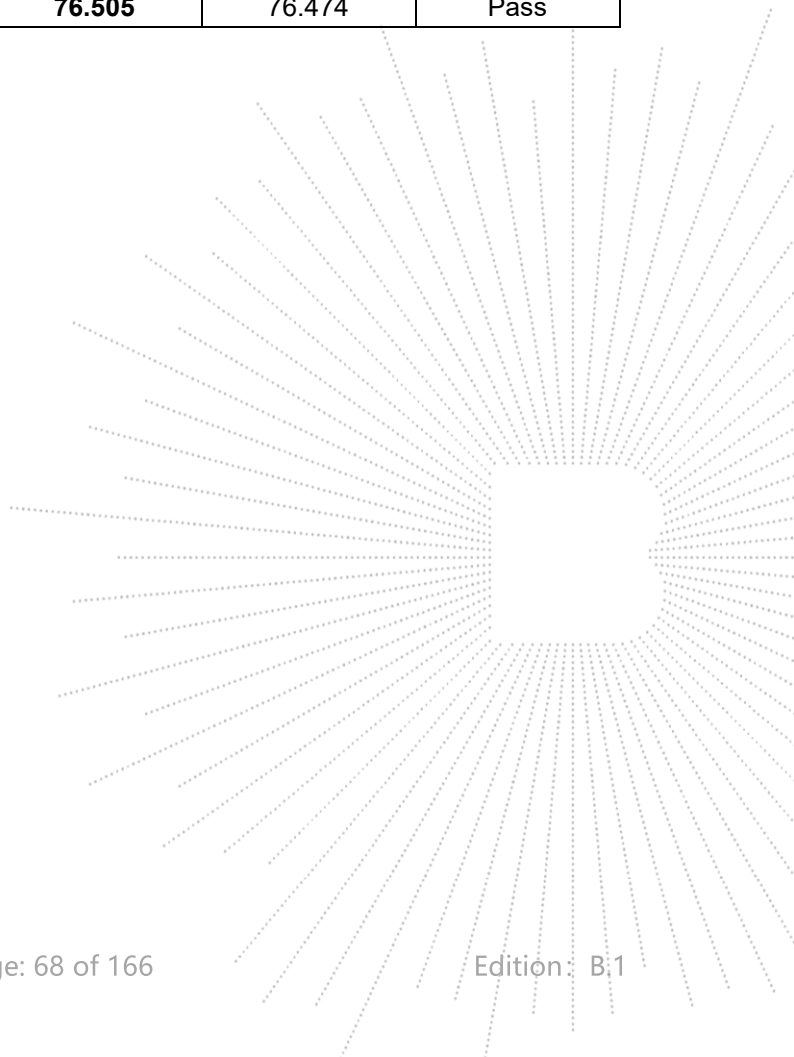

Note: A(B) Represent the value of antenna A and B. The worst data is Antenna A, only shown Antenna A Plot.

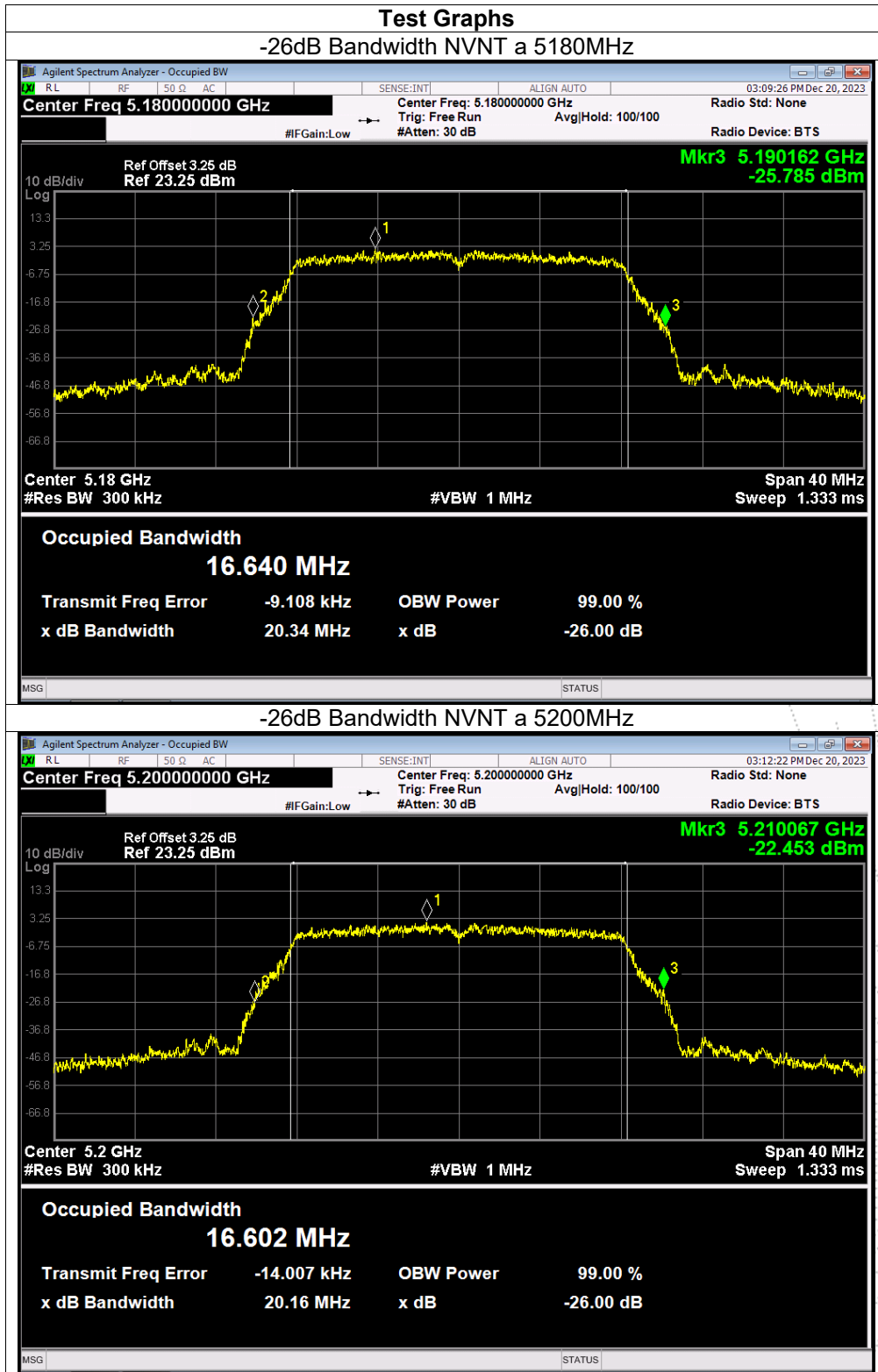

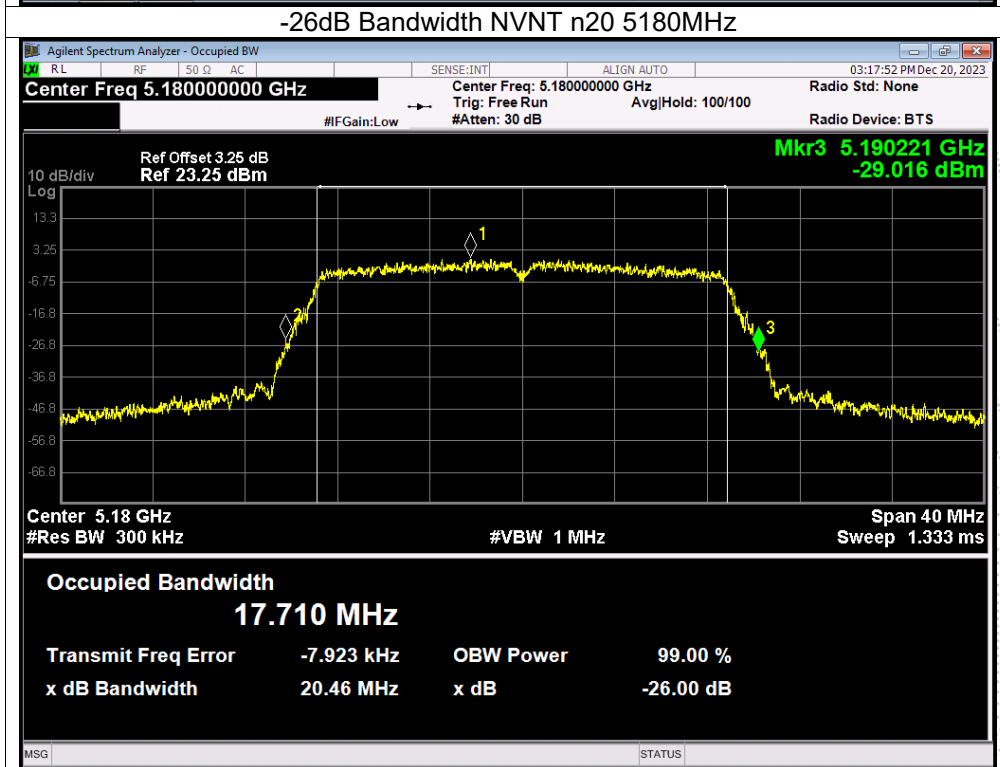
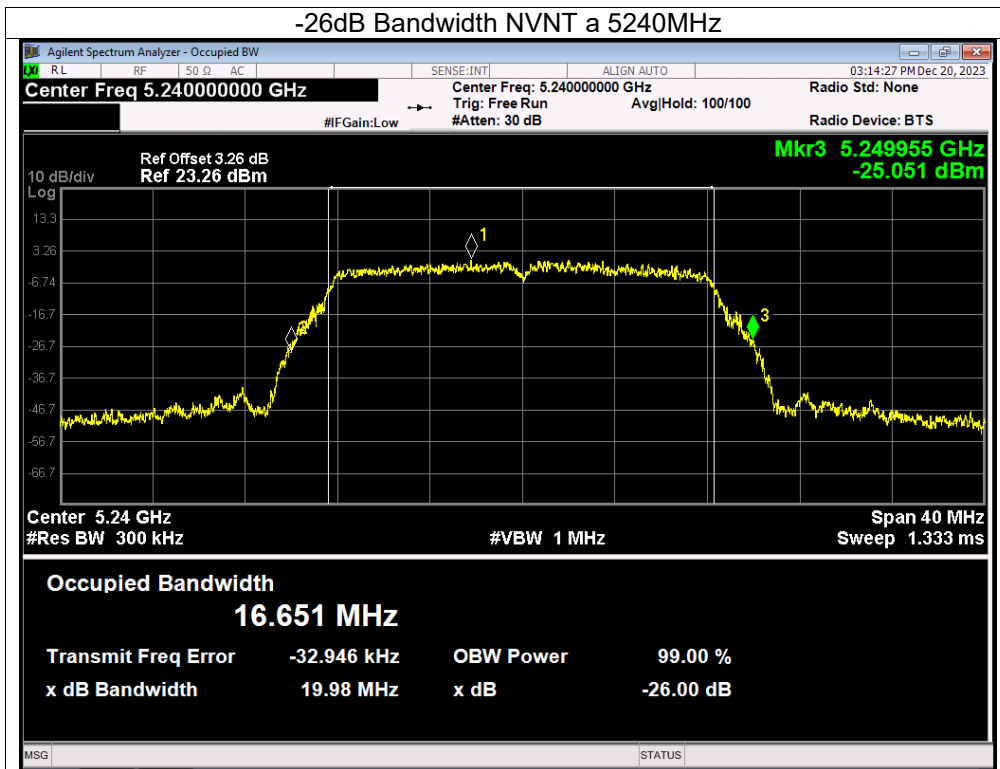

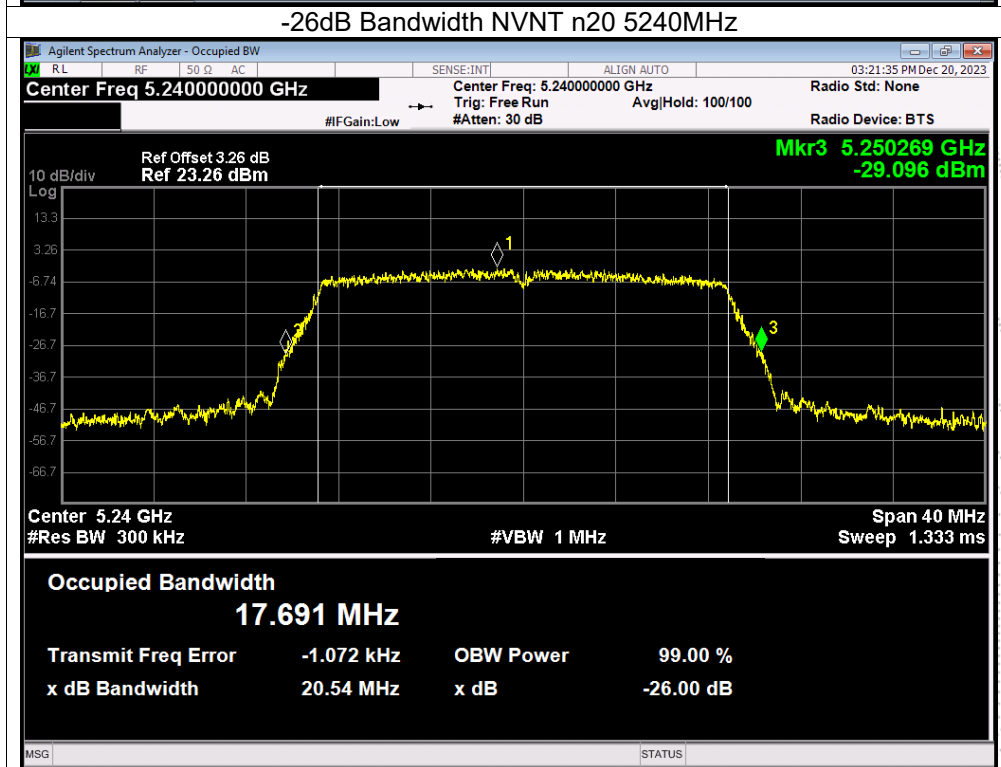
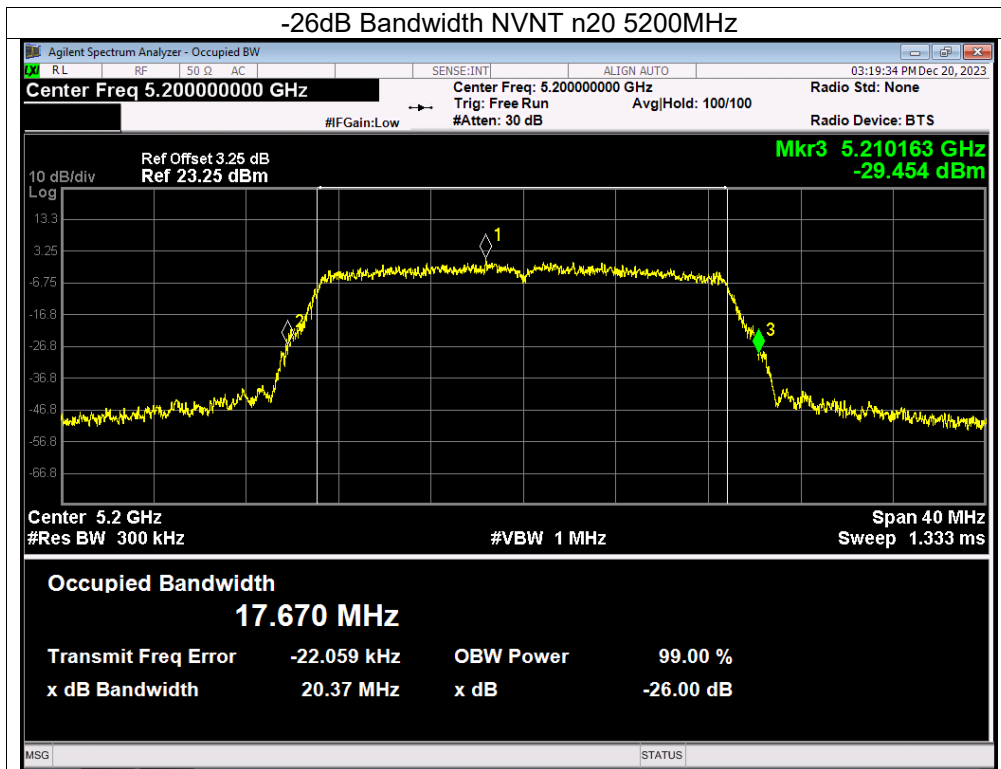

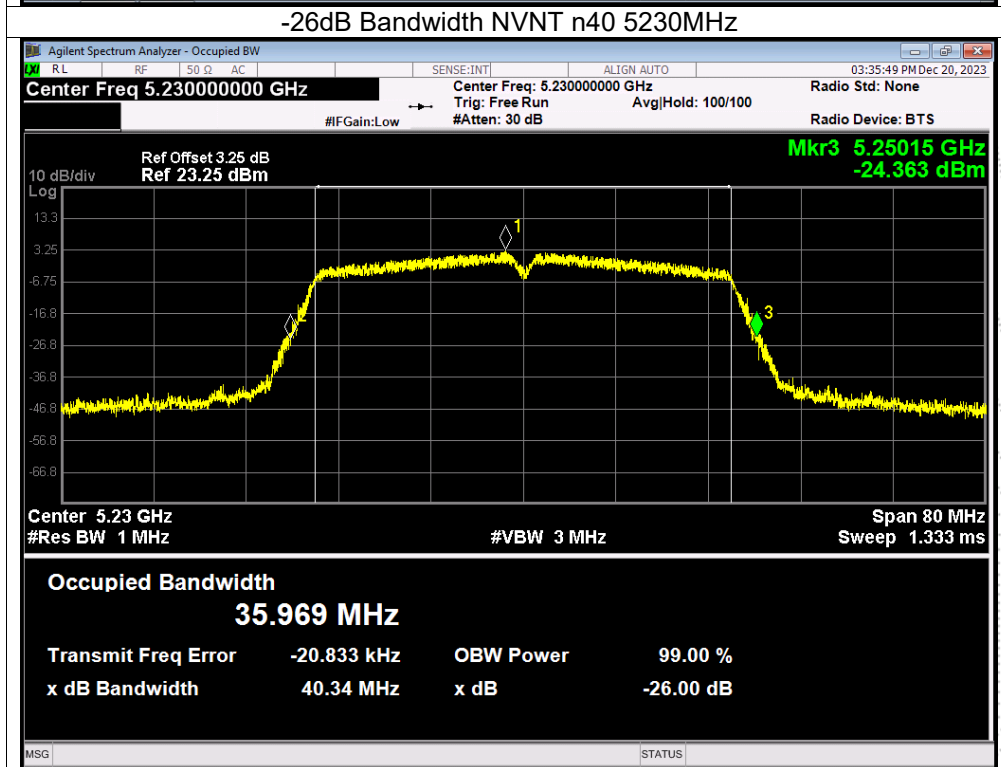
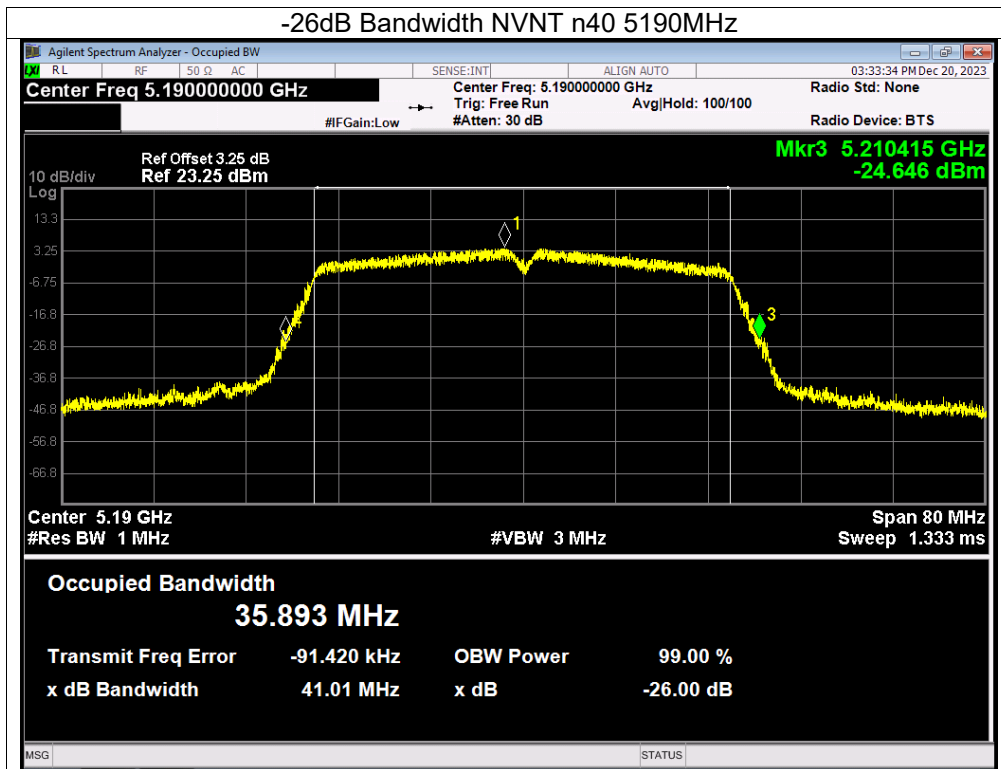

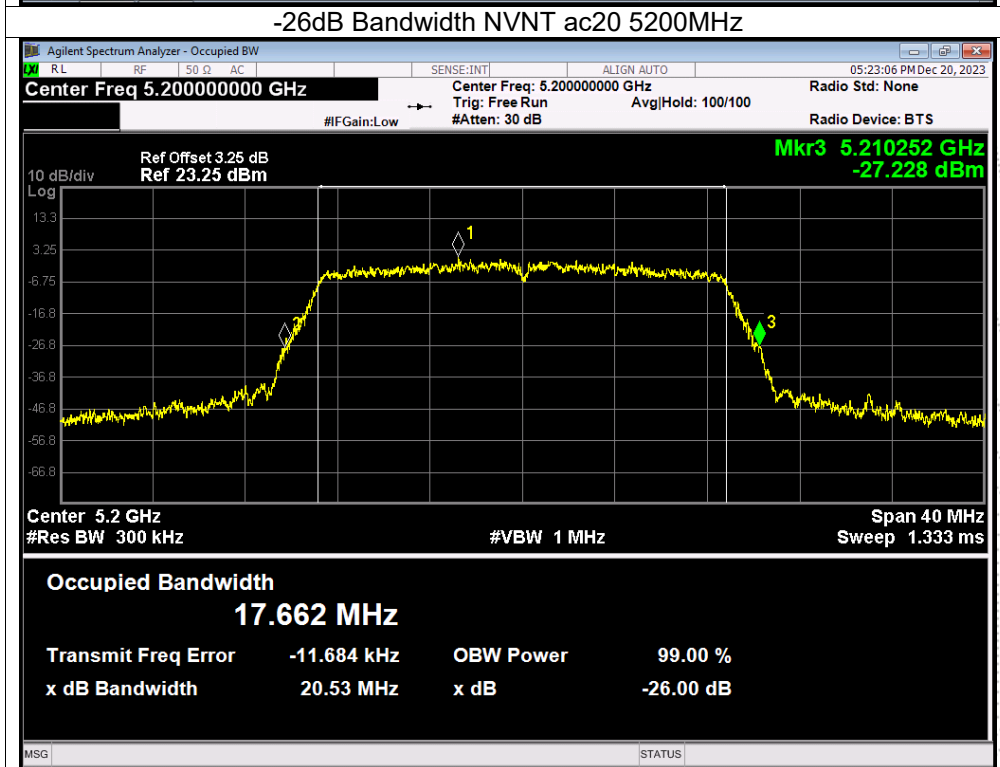
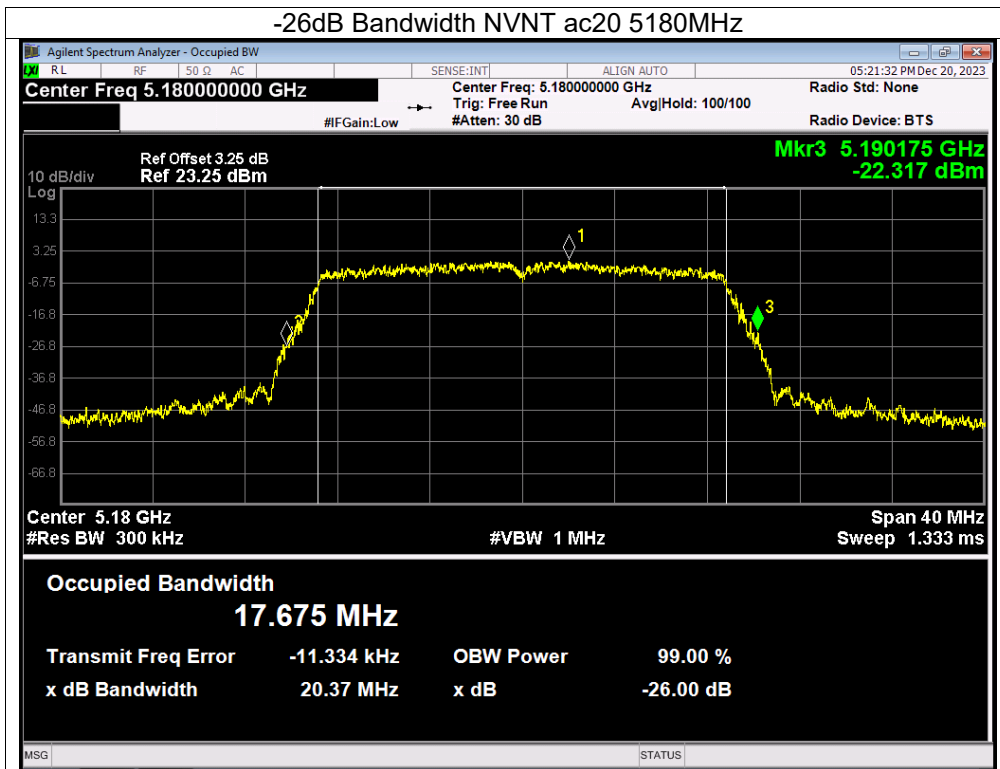

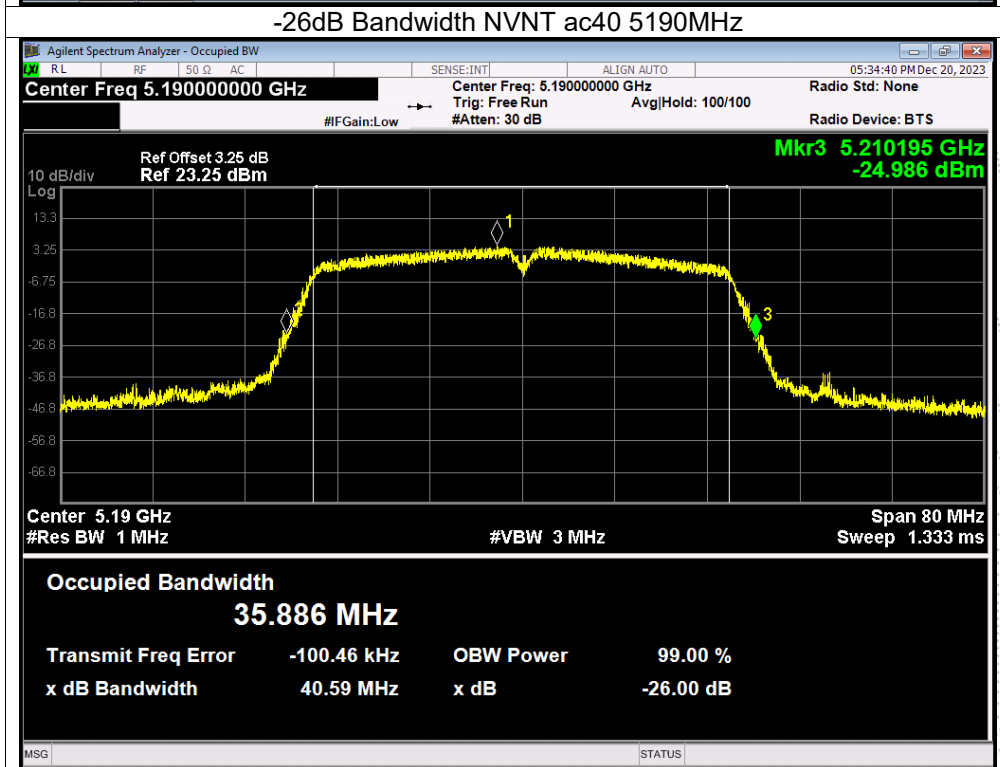
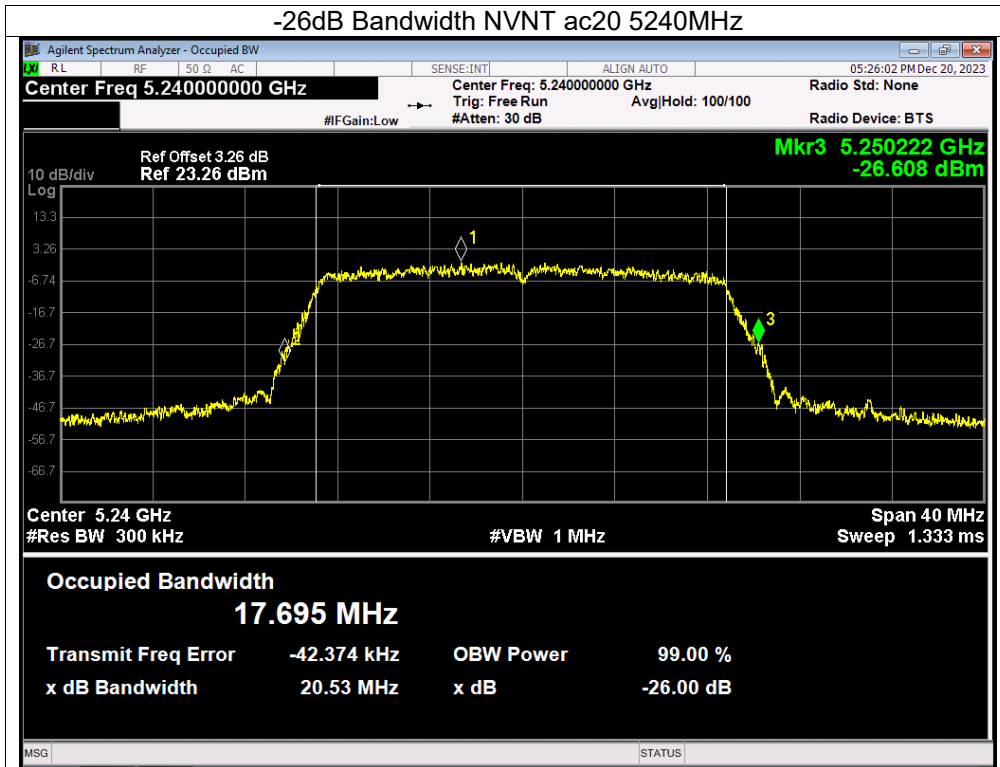

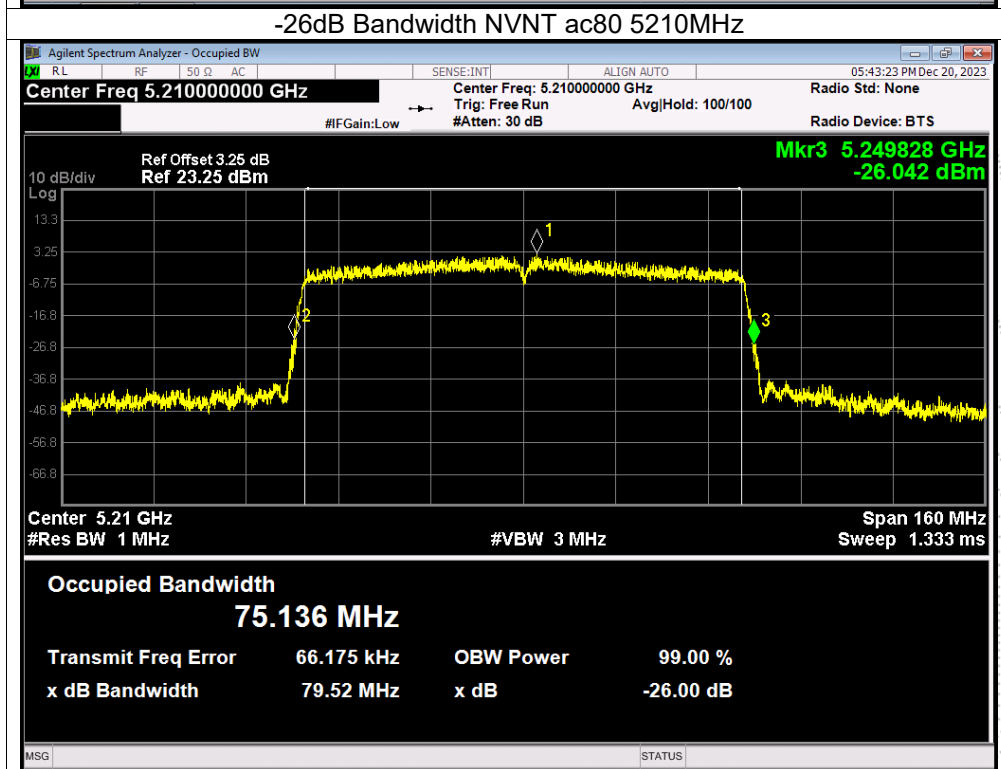
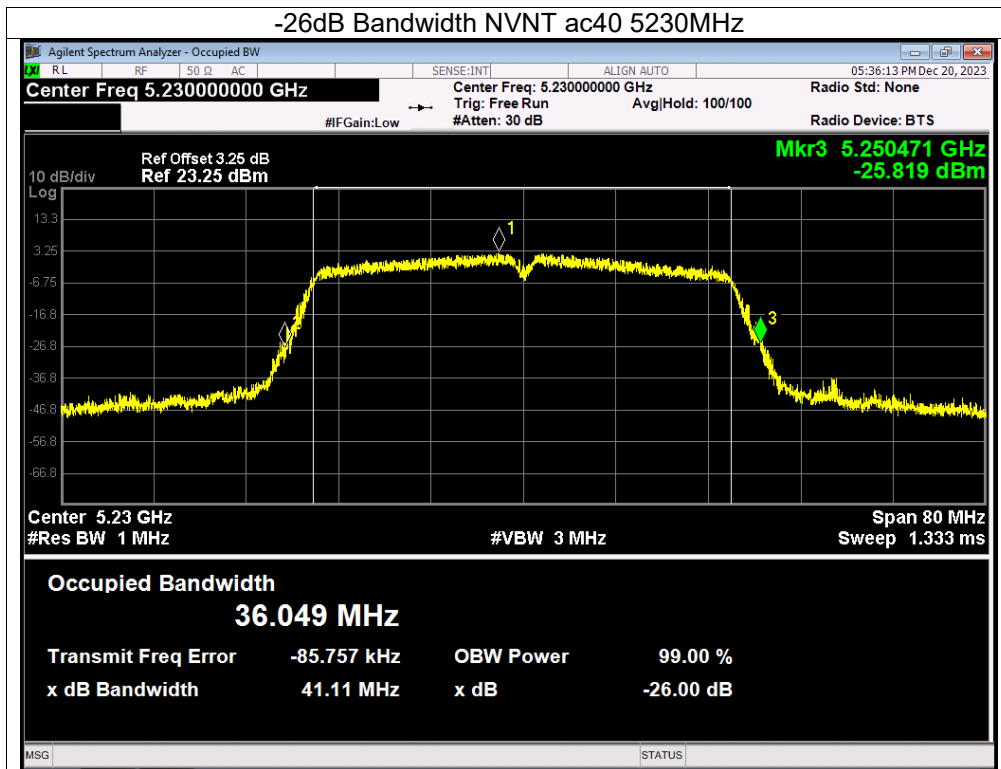

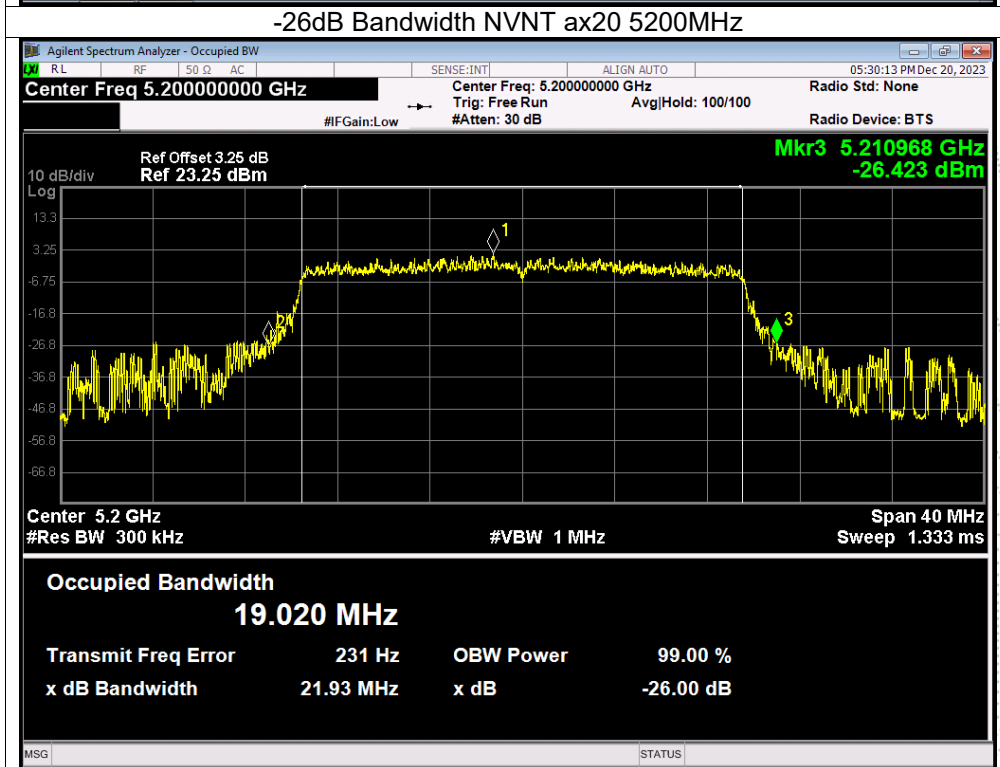
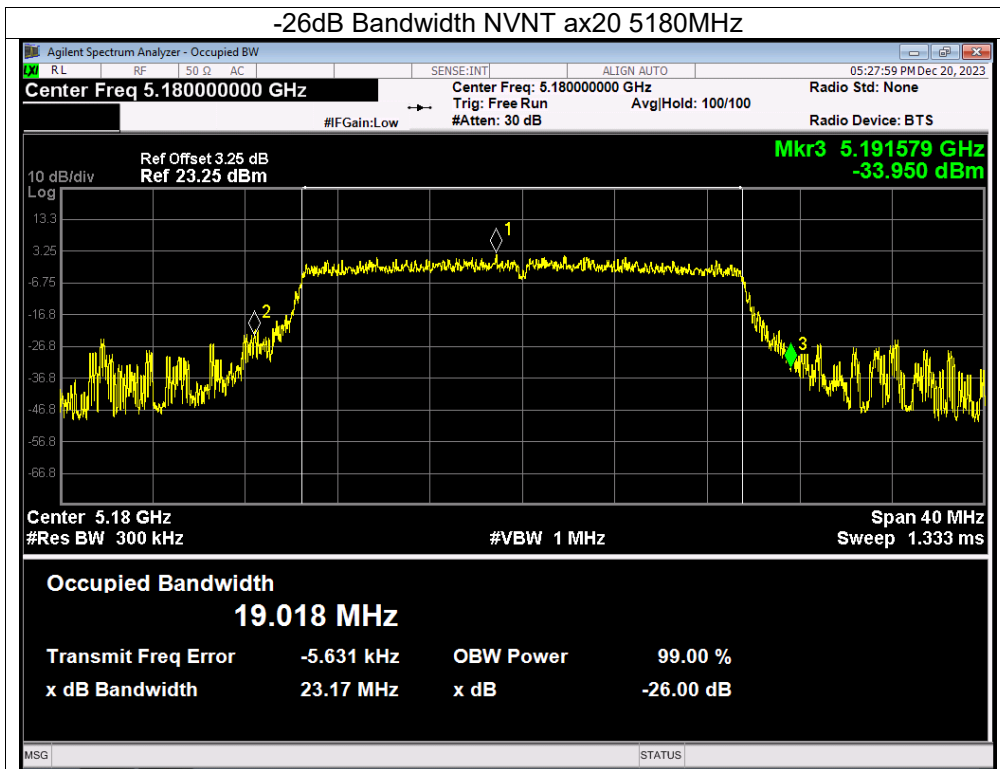

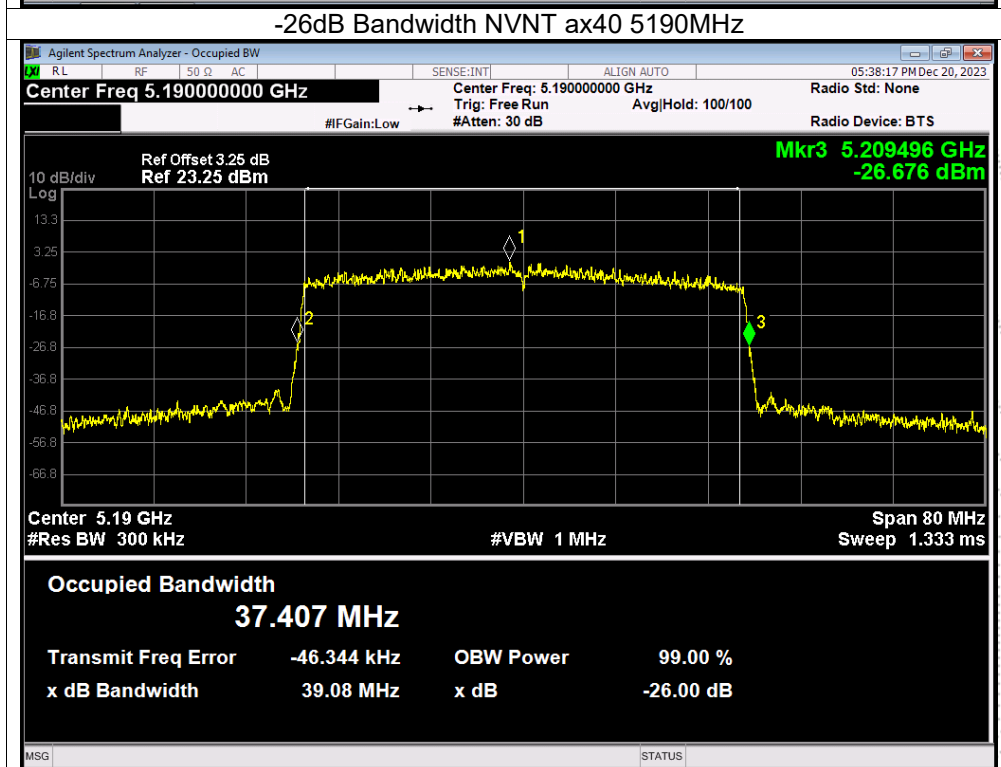
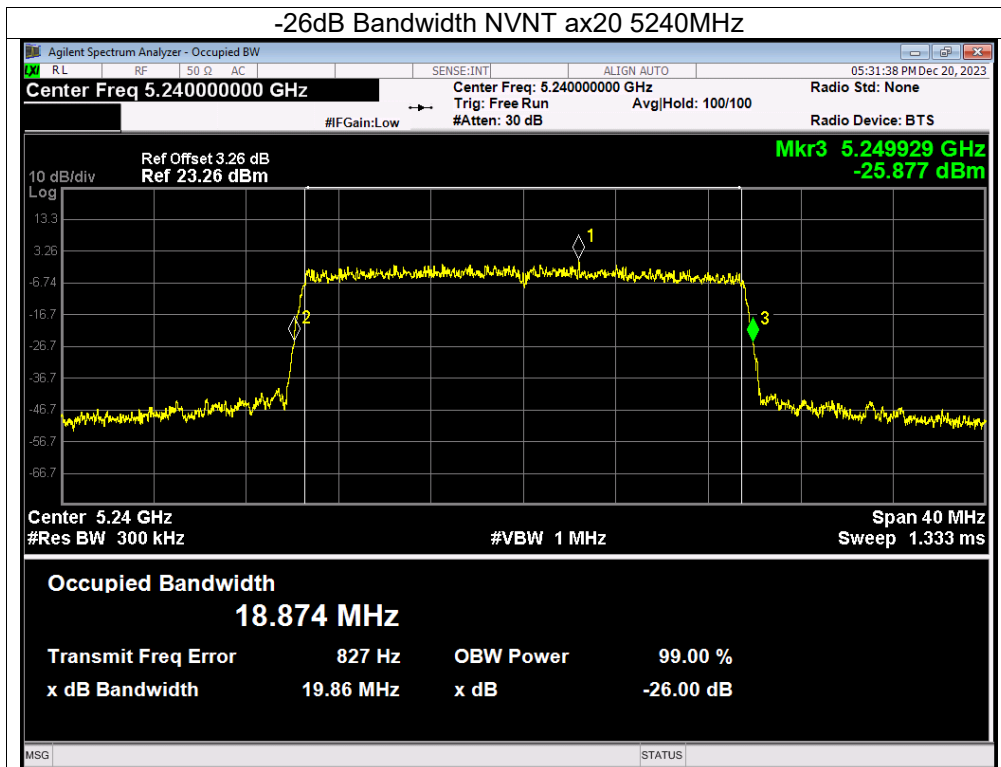

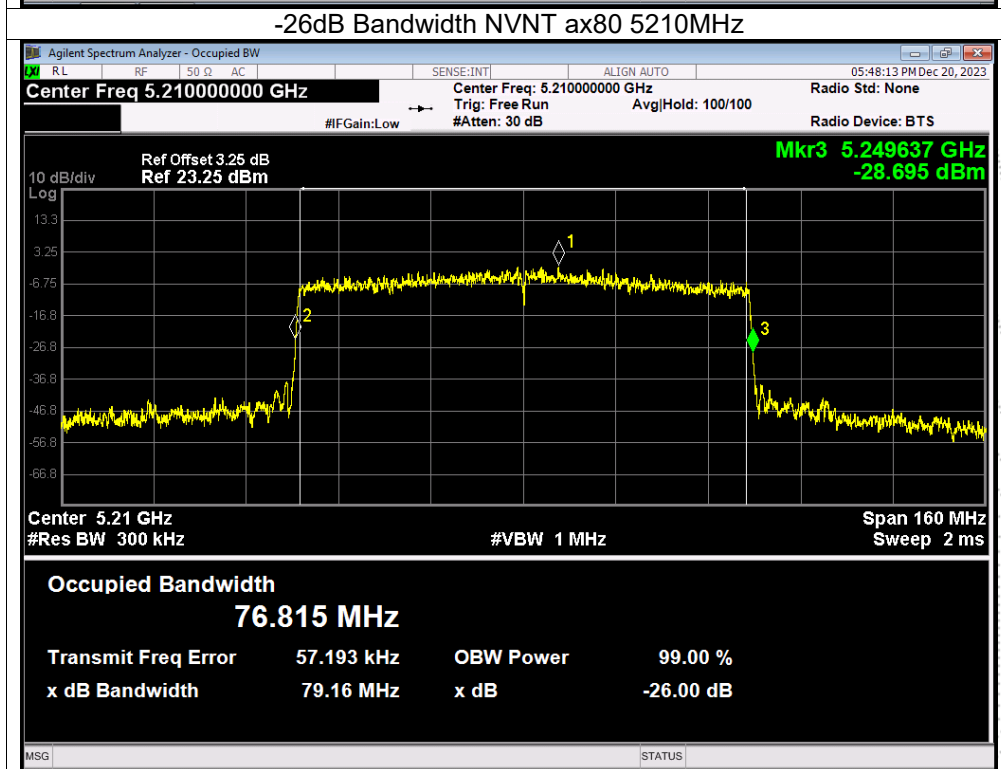
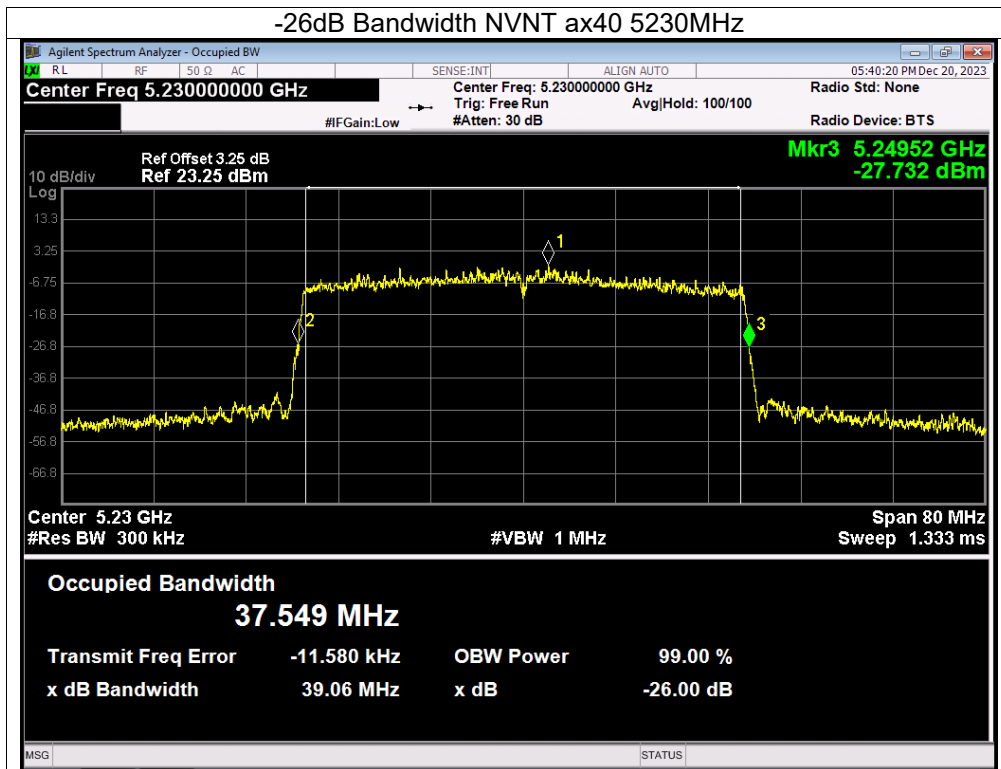

Note: A(B) Represent the value of antenna A and B. The worst data is Antenna A, only shown Antenna A Plot.

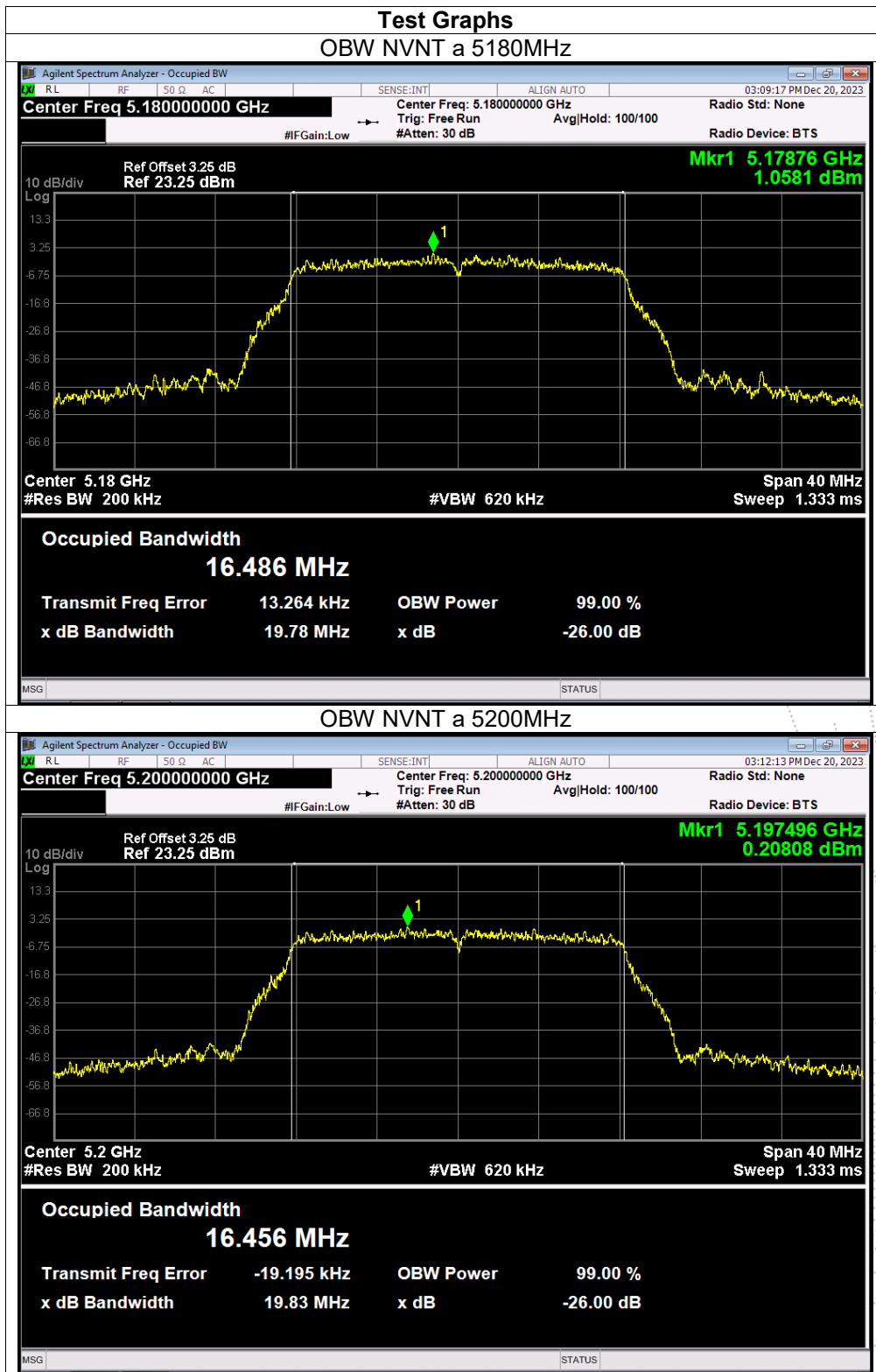

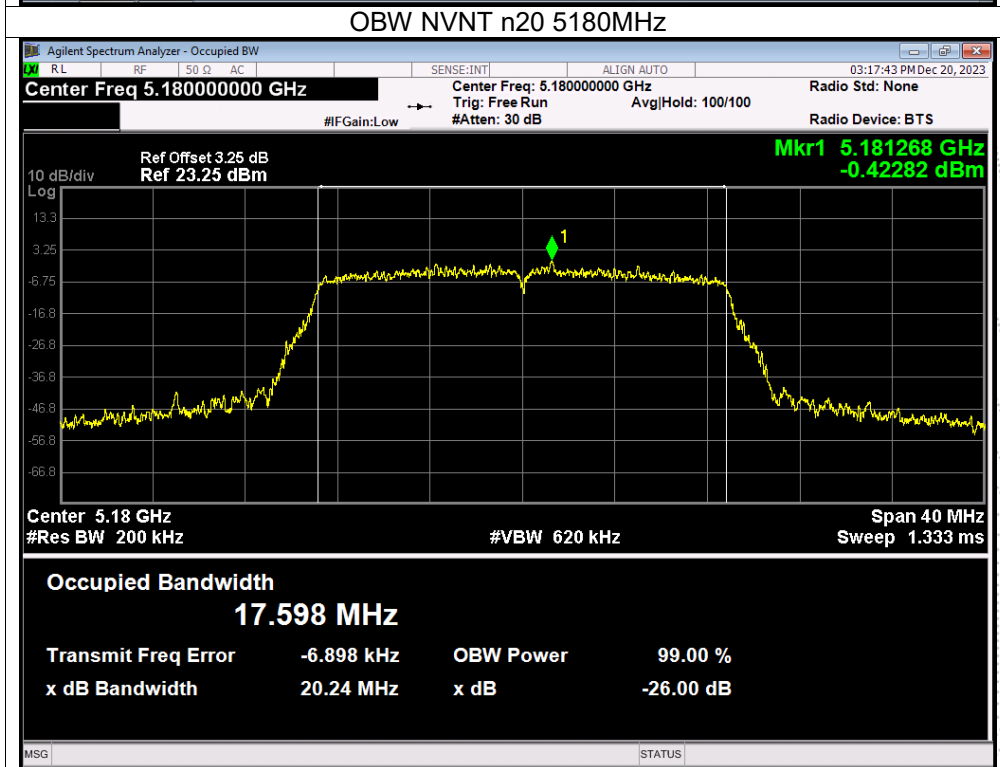
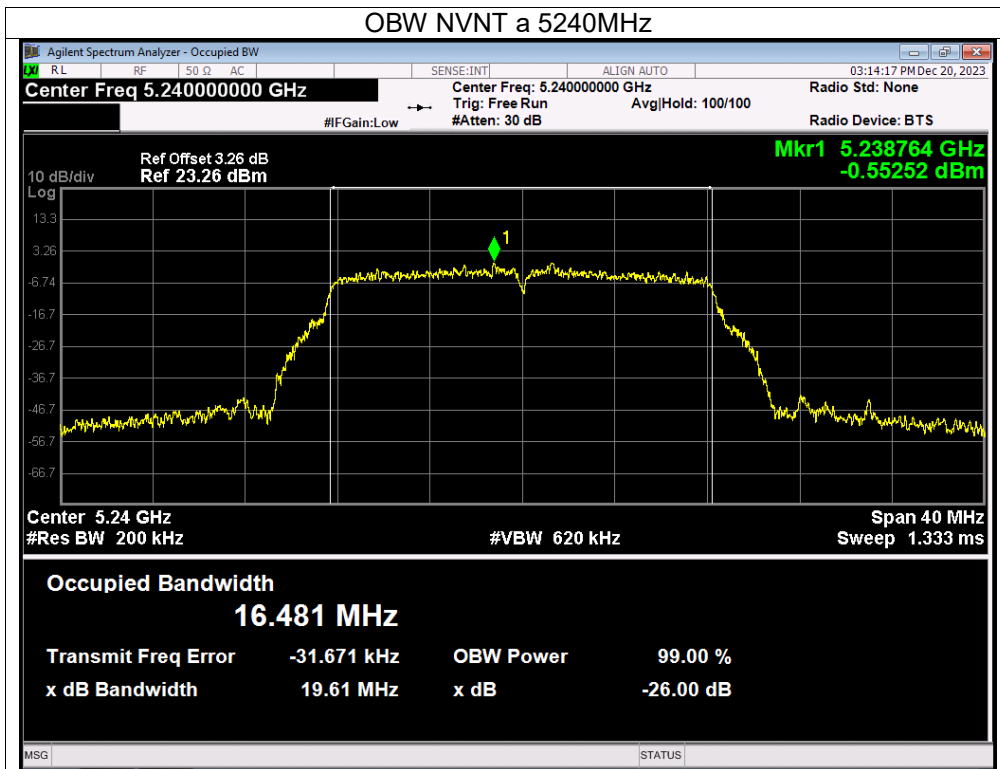

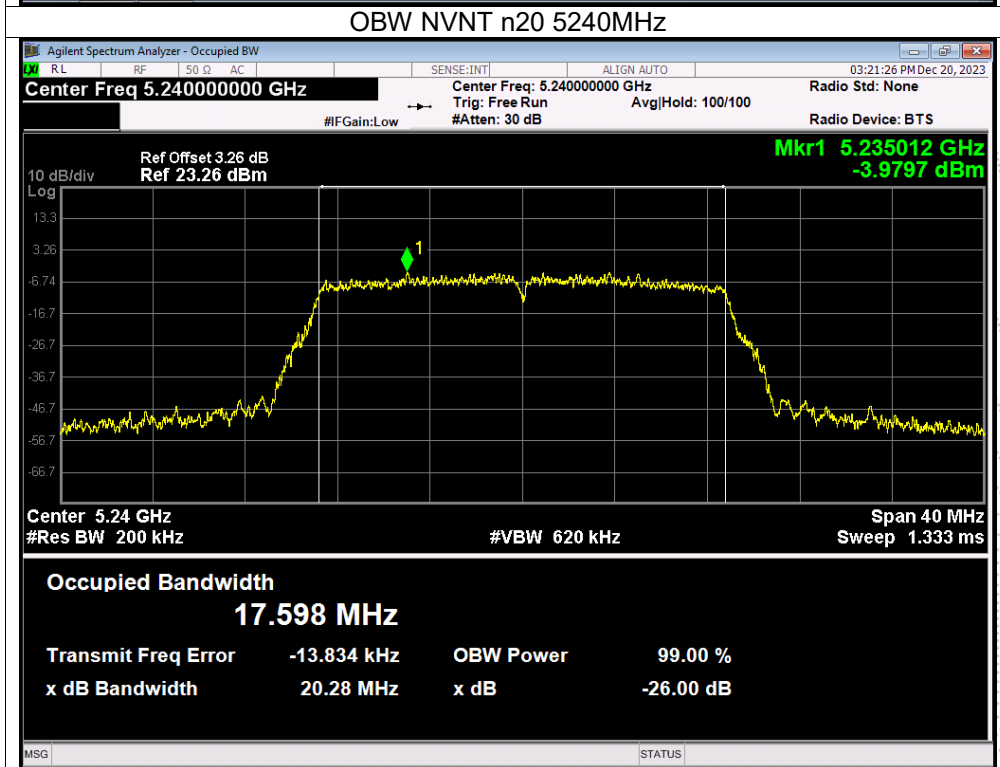
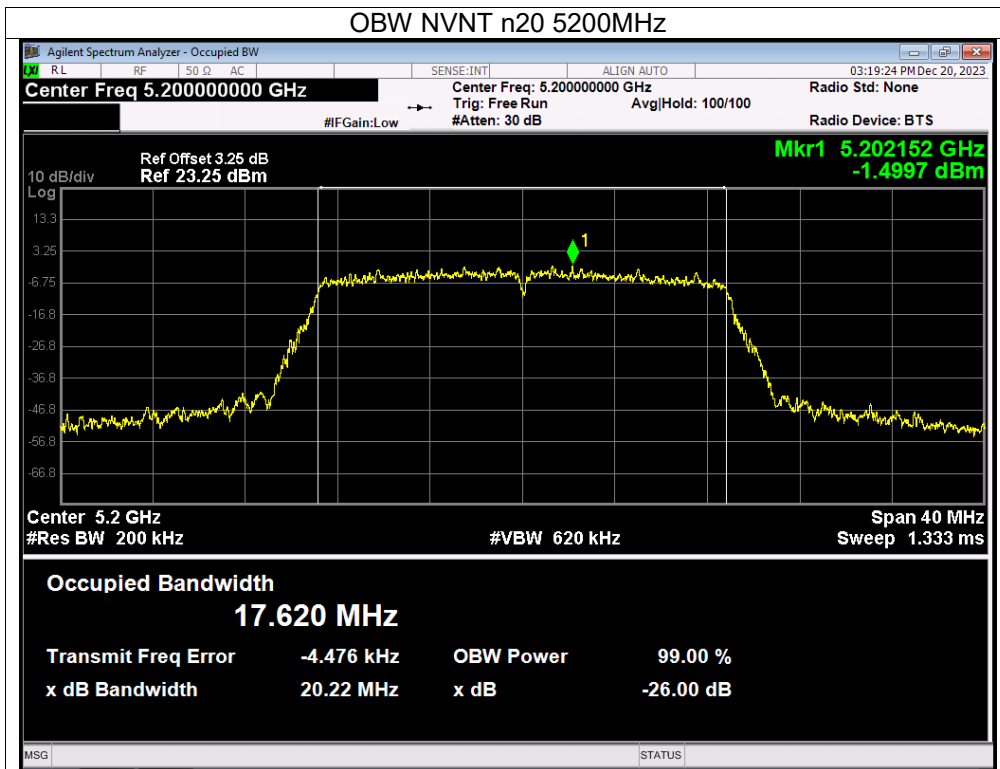

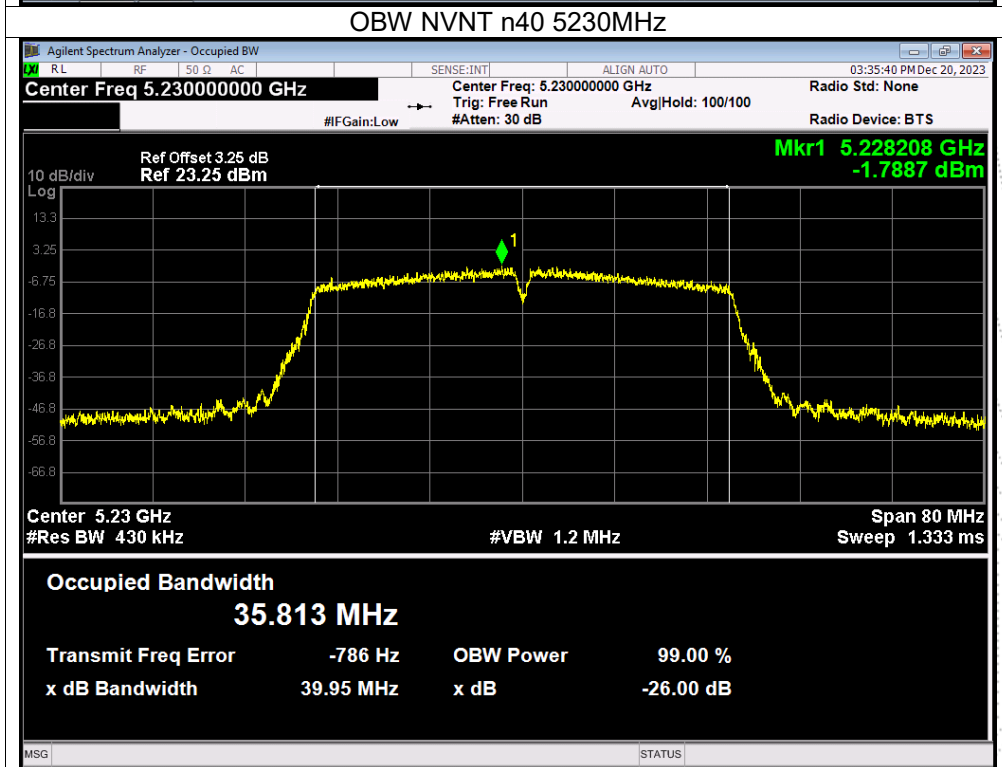
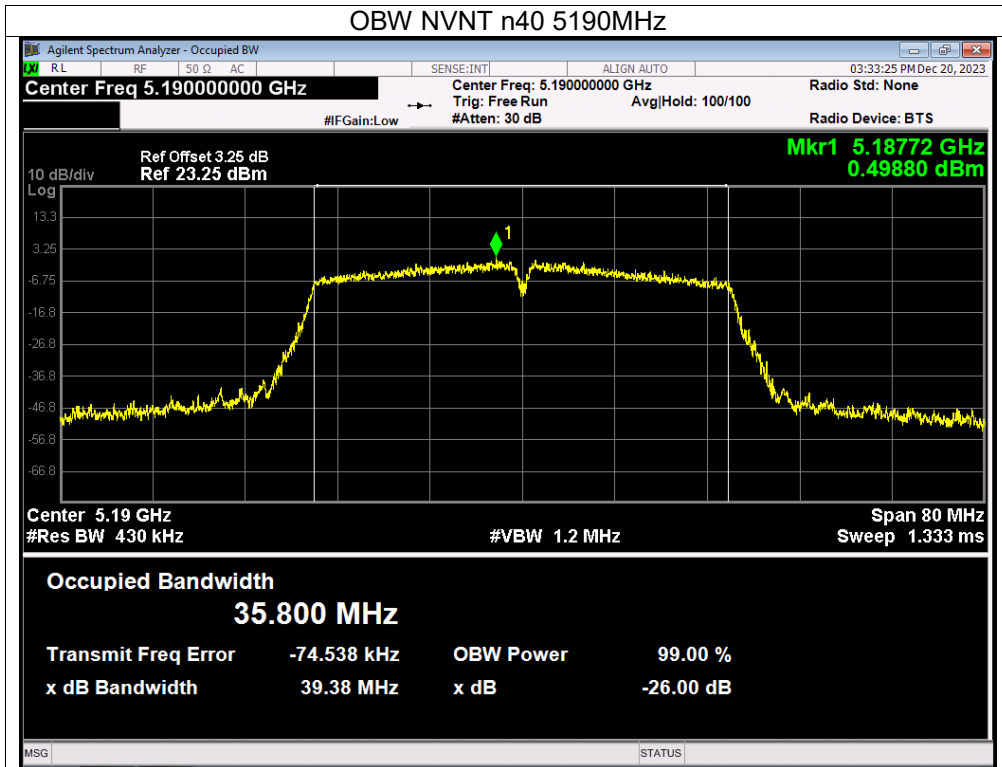

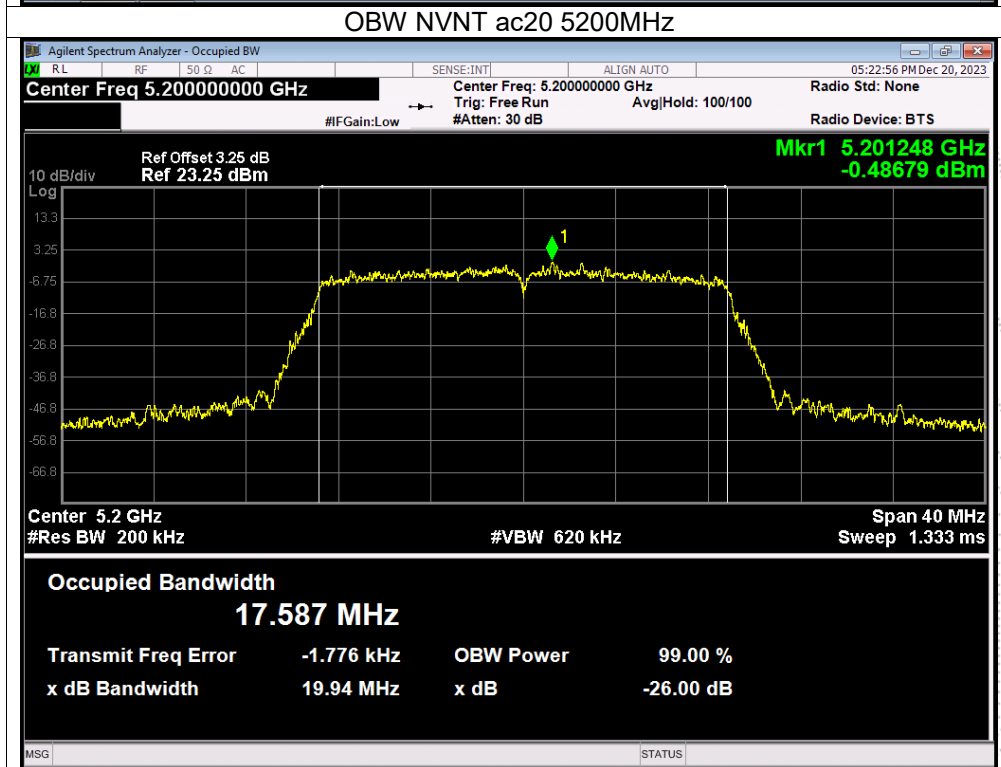
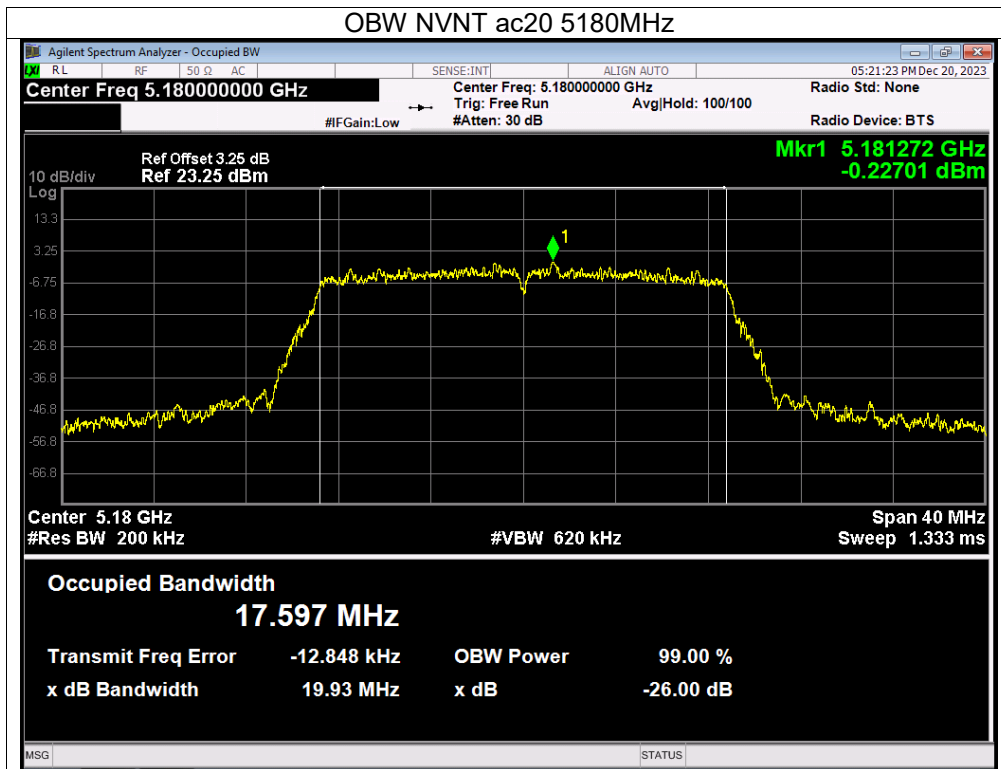

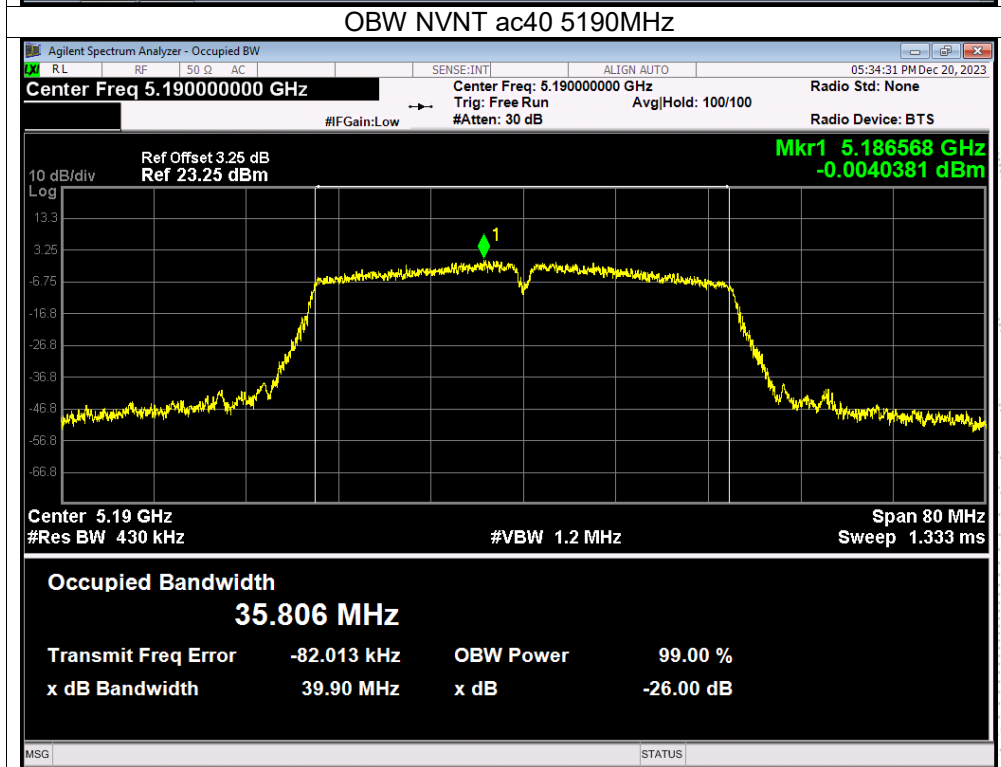
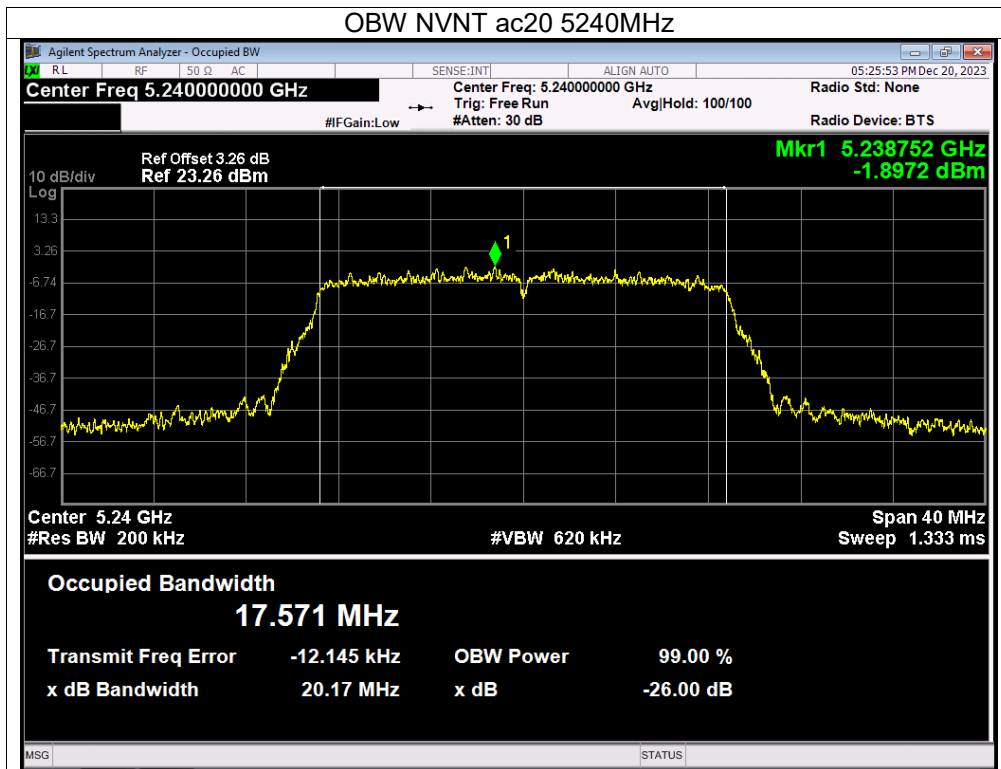

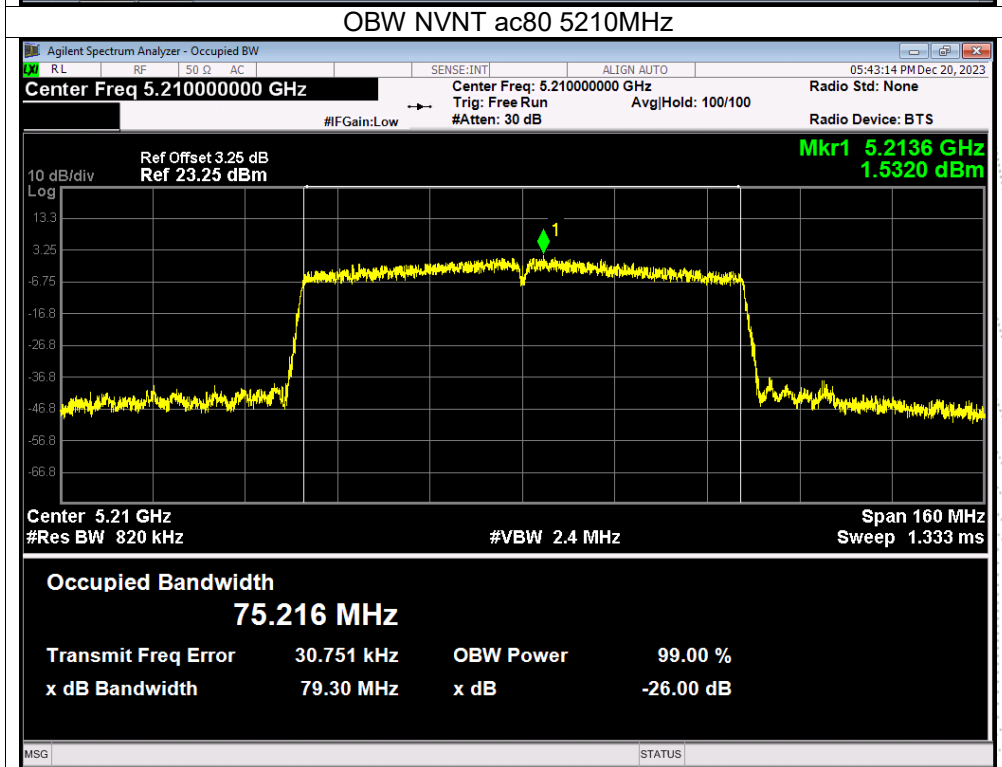
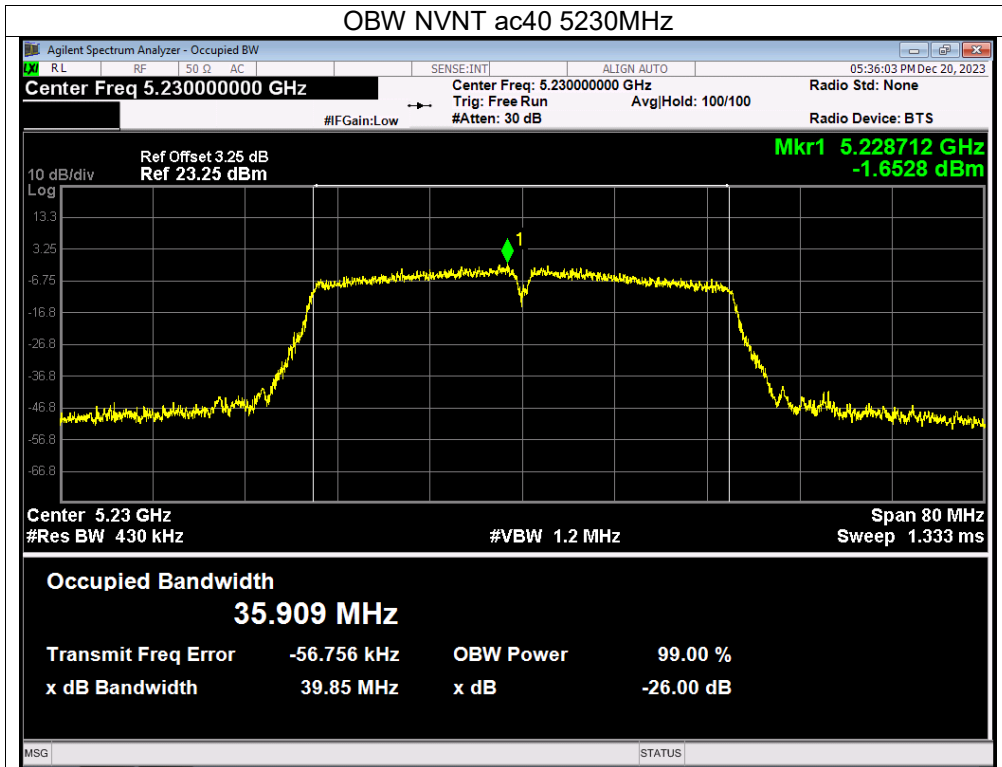

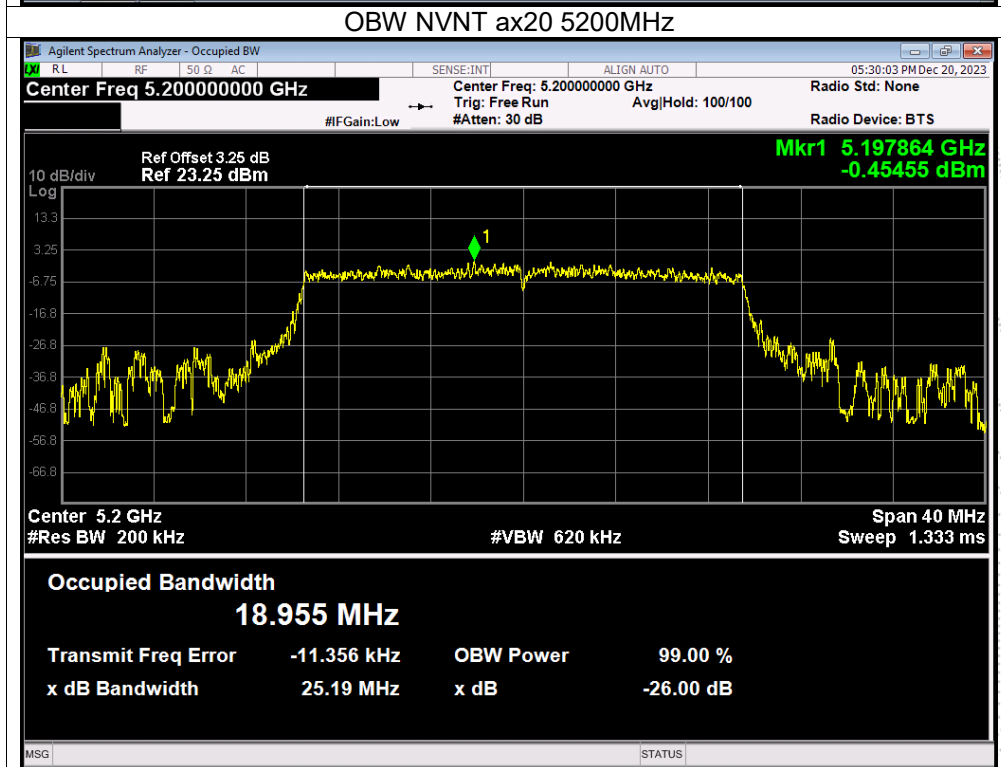
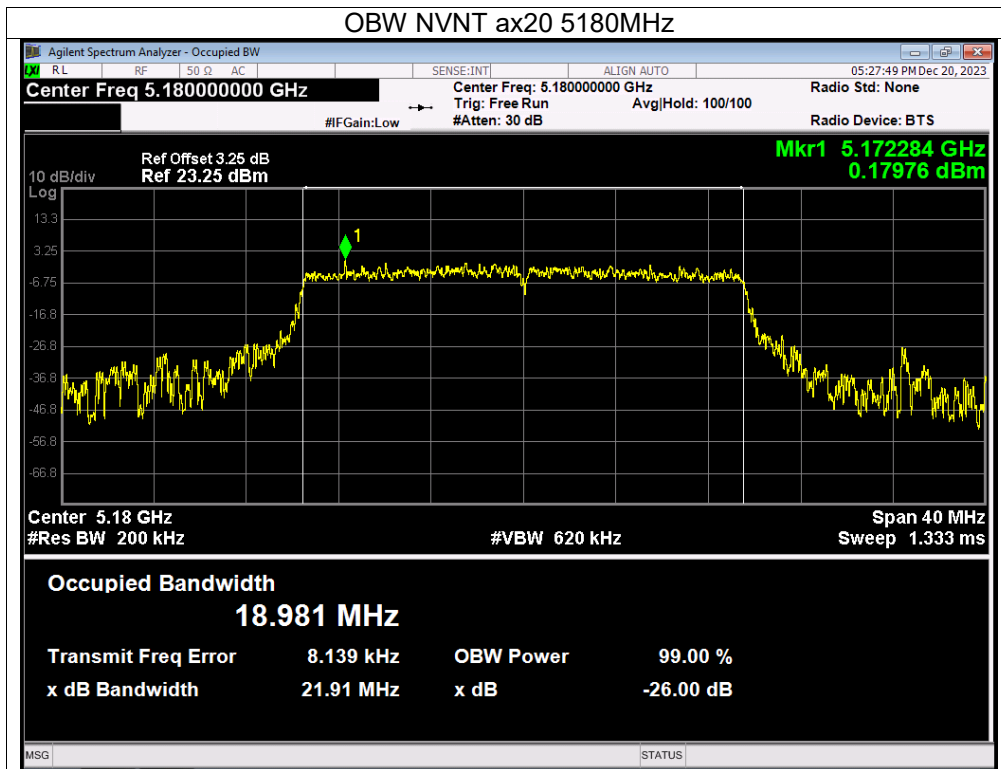

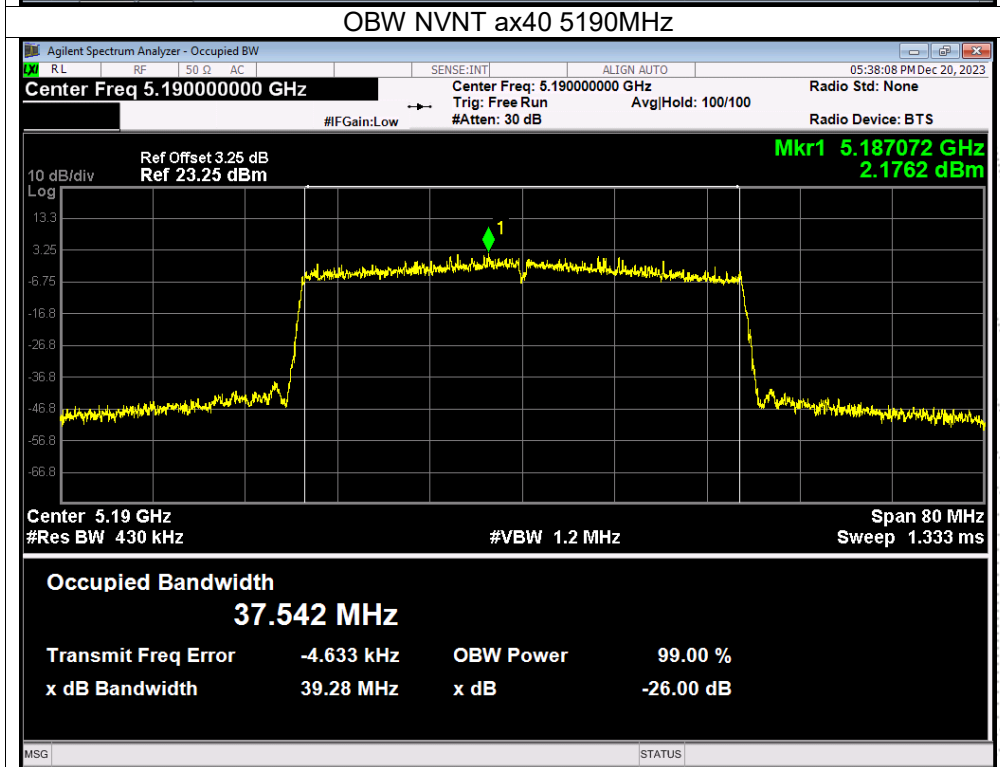
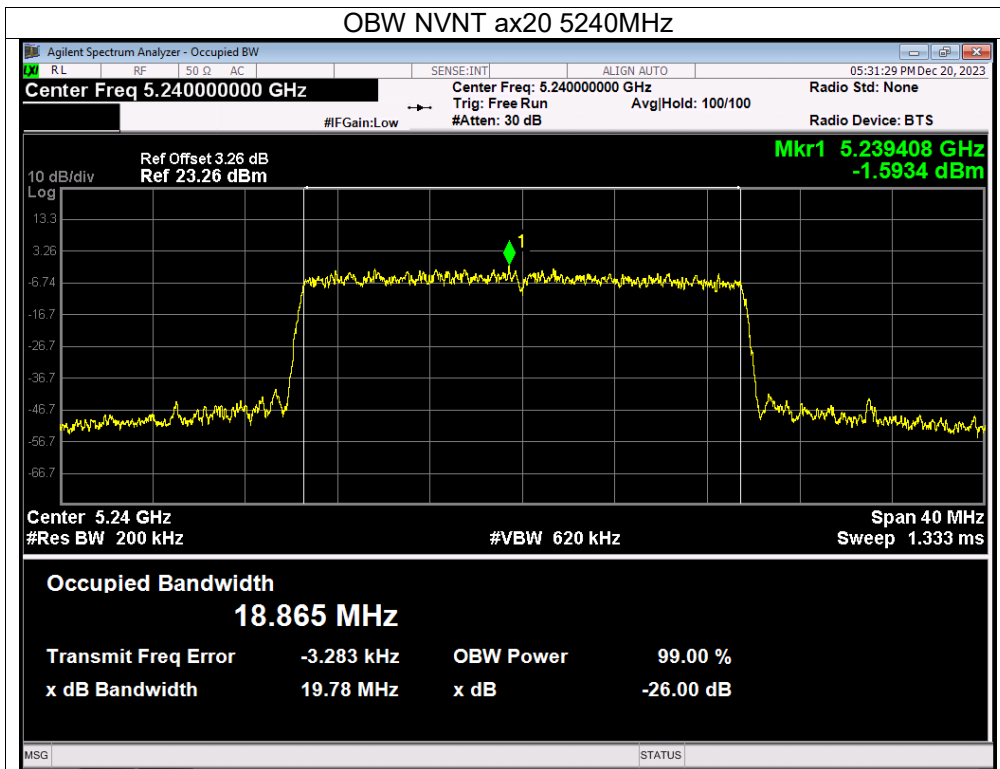

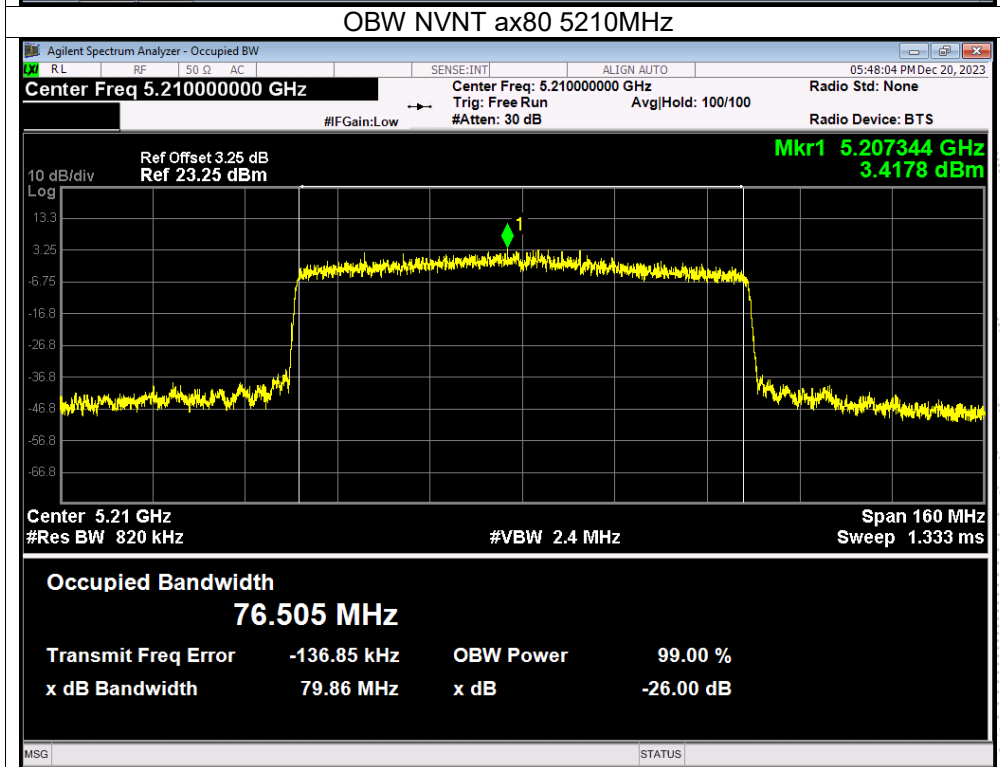
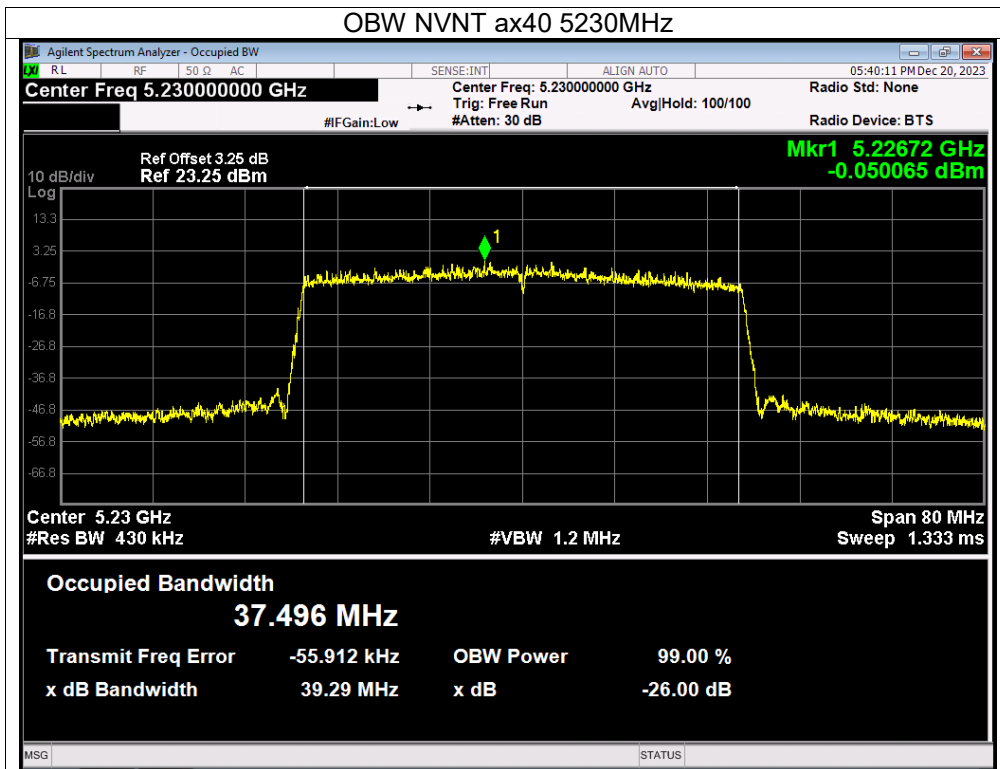

Temperature:	26 °C	Relative Humidity:	54%
Pressure:	101kPa	Test Voltage:	DC 12V
Test Mode:	TX Frequency U-NII-3(5745-5825MHz)		

Condition	Mode	Frequency (MHz)	-6dB bandwidth (MHz)		Limit -6dB bandwidth MHz	Result
			ANT A	ANT B		
NVNT	a	5745	15.019	15.026	≥500	Pass
NVNT	a	5785	15.513	16.031	≥500	Pass
NVNT	a	5825	15.644	15.439	≥500	Pass
NVNT	n20	5745	15.011	15.057	≥500	Pass
NVNT	n20	5785	16.025	16.867	≥500	Pass
NVNT	n20	5825	15.444	15.098	≥500	Pass
NVNT	n40	5755	28.85	33.799	≥500	Pass
NVNT	n40	5795	32.563	32.564	≥500	Pass
NVNT	ac20	5745	15.891	16.69	≥500	Pass
NVNT	ac20	5785	15.036	15.266	≥500	Pass
NVNT	ac20	5825	17.01	16.911	≥500	Pass
NVNT	ac40	5755	32.547	35.004	≥500	Pass
NVNT	ac40	5795	33.751	35.059	≥500	Pass
NVNT	ac80	5775	73.843	75.064	≥500	Pass
NVNT	ax20	5745	18.543	18.928	≥500	Pass
NVNT	ax20	5785	18.495	18.263	≥500	Pass
NVNT	ax20	5825	18.759	18.781	≥500	Pass
NVNT	ax40	5755	35.11	35.07	≥500	Pass
NVNT	ax40	5795	35.096	35.06	≥500	Pass
NVNT	ax80	5775	75.11	75.002	≥500	Pass

Condition	Mode	Frequency (MHz)	99% bandwidth (MHz)		Result
			ANT A	ANT B	
NVNT	a	5745	16.464	16.481	Pass
NVNT	a	5785	16.454	16.511	Pass
NVNT	a	5825	16.485	16.453	Pass
NVNT	n20	5745	17.597	17.617	Pass
NVNT	n20	5785	17.589	17.592	Pass
NVNT	n20	5825	17.604	17.598	Pass
NVNT	n40	5755	35.756	35.821	Pass
NVNT	n40	5795	35.802	35.811	Pass
NVNT	ac20	5745	17.599	17.602	Pass
NVNT	ac20	5785	17.562	17.595	Pass
NVNT	ac20	5825	17.584	17.591	Pass
NVNT	ac40	5755	35.785	35.818	Pass
NVNT	ac40	5795	35.838	35.755	Pass
NVNT	ac80	5775	75.061	74.991	Pass
NVNT	ax20	5745	18.998	19.034	Pass
NVNT	ax20	5785	18.953	18.971	Pass
NVNT	ax20	5825	18.959	18.947	Pass
NVNT	ax40	5755	37.435	37.424	Pass
NVNT	ax40	5795	37.417	37.422	Pass
NVNT	ax80	5775	76.561	76.681	Pass

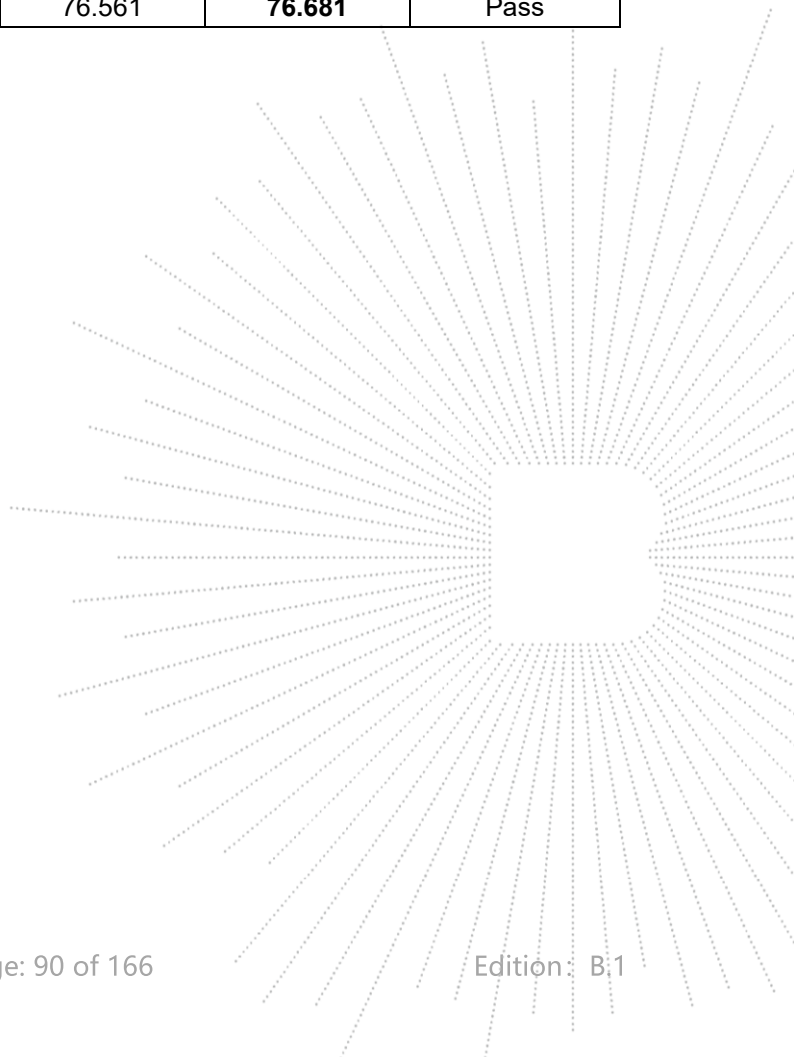

Note: A(B) Represent the value of antenna A and B, The worst data is Antenna A, only shown Antenna A Plot.

