

802.11ax_40MHz_Chain0_5710MHz_UNII 3

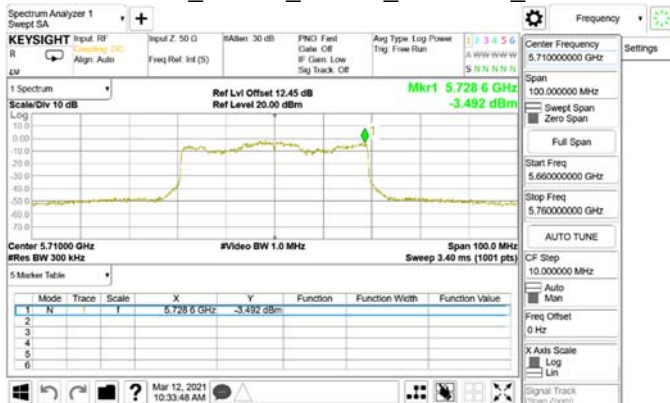

802.11ax_40MHz_Chain0_5795MHz



802.11ax_40MHz_Chain0_5755MHz

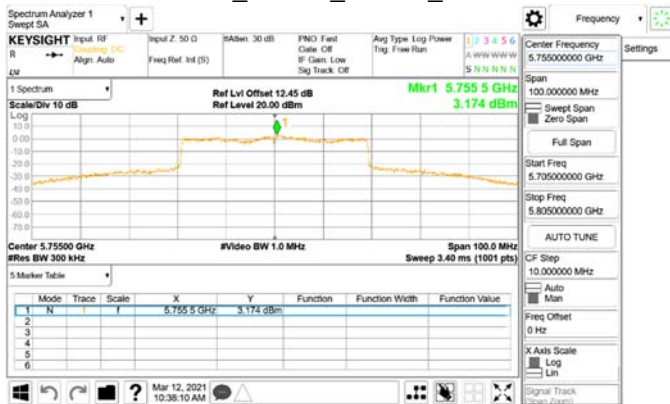

802.11ax_40MHz_Chain0_5795MHz_RU242_62

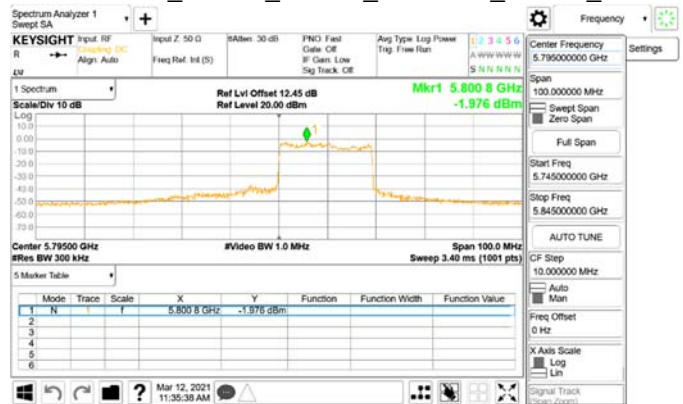

802.11ax_40MHz_Chain0_5755MHz_RU242_61



802.11ax_40MHz_Chain1_5190MHz

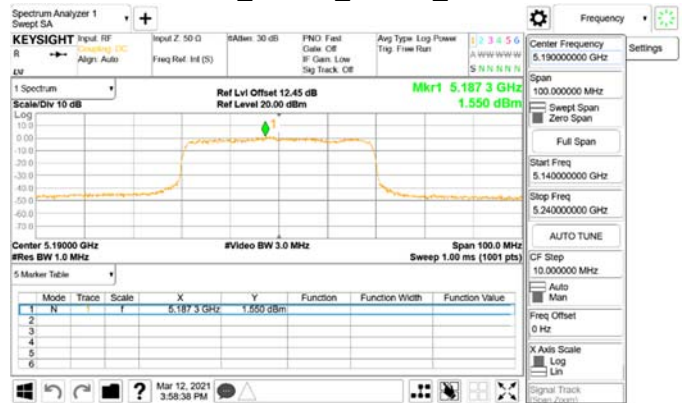

Unless otherwise stated the results shown in this test report refer only to the sample(s) tested and such sample(s) are retained for 90 days only.

除非另有說明，此報告結果僅對測試之樣品負責，同時此樣品僅保留90天。本報告未經本公司書面許可，不可部份複製。

This document is issued by the Company subject to its General Conditions of Service printed overleaf, available on request or accessible at <http://www.sgs.com.tw/Terms-and-Conditions> and for electronic format documents, subject to Terms and Conditions for Electronic Documents at <http://www.sgs.com.tw/Terms-and-Conditions>. Attention is drawn to the limitation of liability, indemnification and jurisdiction issues defined therein. Any holder of this document is advised that information contained hereon reflects the Company's findings at the time of its intervention only and within the limits of Client's instructions, if any. The Company's sole responsibility is to its Client and this document does not exonerate parties to a transaction from exercising all their rights and obligations under the transaction documents. This document cannot be reproduced except in full, without prior written approval of the Company. Any unauthorized alteration, forgery or falsification of the content or appearance of this document is unlawful and offenders may be prosecuted to the fullest extent of the law.

802.11ax_40MHz_Chain1_5190MHz_RU242_61

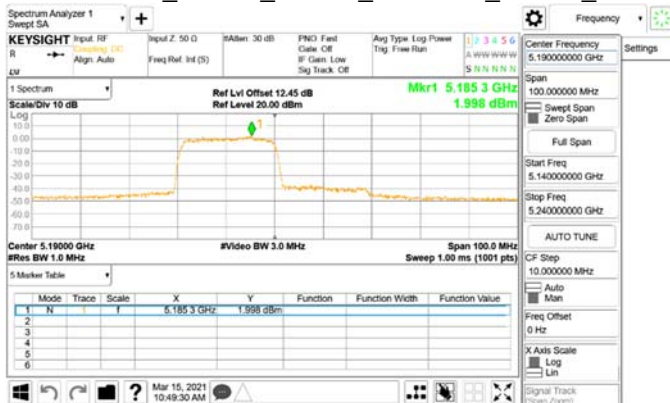

802.11ax_40MHz_Chain1_5310MHz



802.11ax_40MHz_Chain1_5230MHz

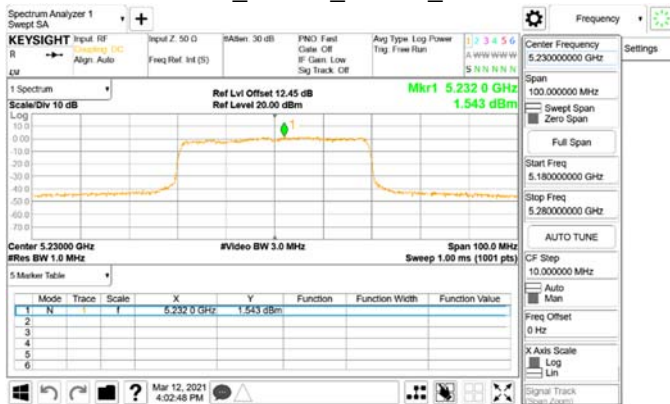

802.11ax_40MHz_Chain1_5310MHz_RU242_62

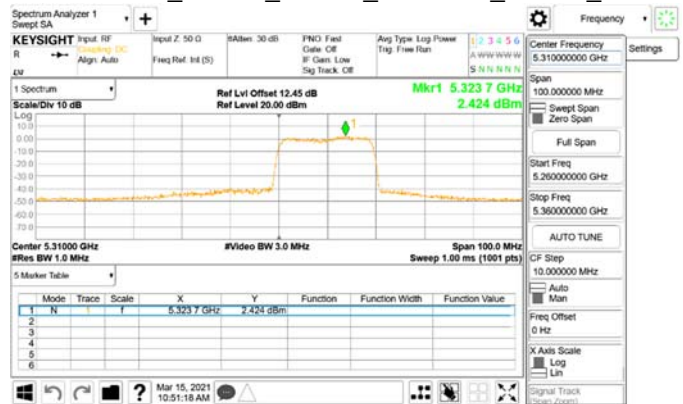

802.11ax_40MHz_Chain1_5270MHz



802.11ax_40MHz_Chain1_5510MHz



Unless otherwise stated the results shown in this test report refer only to the sample(s) tested and such sample(s) are retained for 90 days only.

除非另有說明，此報告結果僅對測試之樣品負責，同時此樣品僅保留90天。本報告未經本公司書面許可，不可部份複製。

This document is issued by the Company subject to its General Conditions of Service printed overleaf, available on request or accessible at <http://www.sgs.com.tw/Terms-and-Conditions> and for electronic format documents, subject to Terms and Conditions for Electronic Documents at <http://www.sgs.com.tw/Terms-and-Conditions>. Attention is drawn to the limitation of liability, indemnification and jurisdiction issues defined therein. Any holder of this document is advised that information contained hereon reflects the Company's findings at the time of its intervention only and within the limits of Client's instructions, if any. The Company's sole responsibility is to its Client and this document does not exonerate parties to a transaction from exercising all their rights and obligations under the transaction documents. This document cannot be reproduced except in full, without prior written approval of the Company. Any unauthorized alteration, forgery or falsification of the content or appearance of this document is unlawful and offenders may be prosecuted to the fullest extent of the law.

802.11ax_40MHz_Chain1_5510MHz_RU242_61

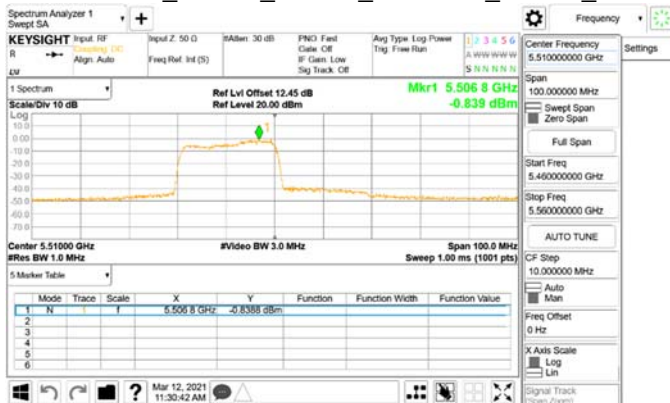

802.11ax_40MHz_Chain1_5670MHz_RU242_62



802.11ax_40MHz_Chain1_5550MHz

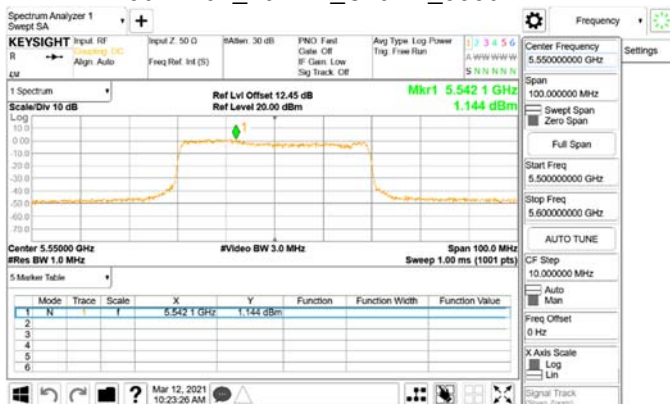

802.11ax_40MHz_Chain1_5710MHz_UNII 2C

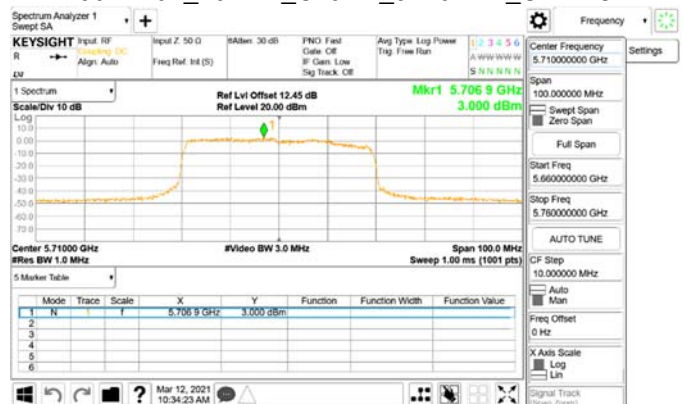

802.11ax_40MHz_Chain1_5670MHz

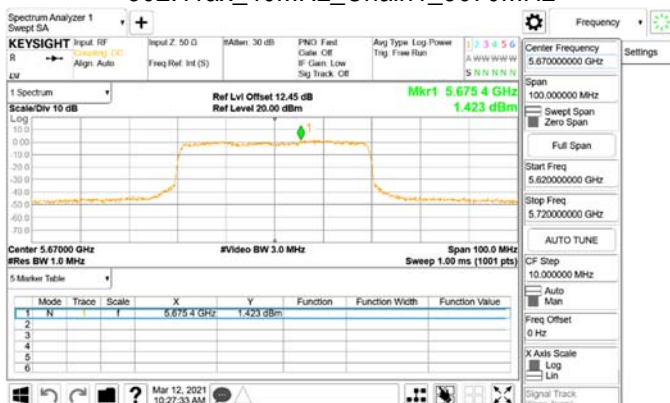

802.11ax_40MHz_Chain1_5710MHz_UNII 3

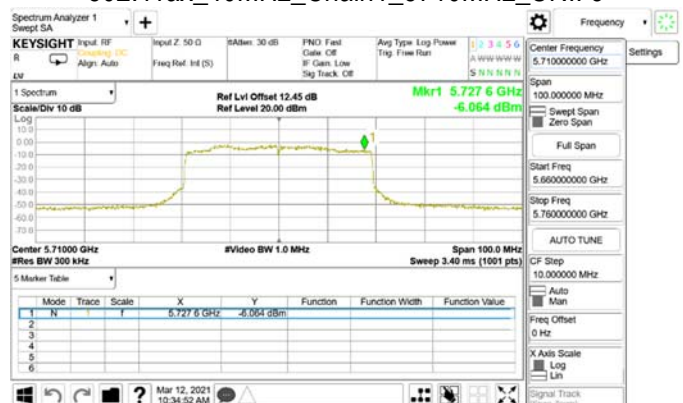

Unless otherwise stated the results shown in this test report refer only to the sample(s) tested and such sample(s) are retained for 90 days only.

除非另有說明，此報告結果僅對測試之樣品負責，同時此樣品僅保留90天。本報告未經本公司書面許可，不可部份複製。

This document is issued by the Company subject to its General Conditions of Service printed overleaf, available on request or accessible at <http://www.sgs.com.tw/Terms-and-Conditions> and for electronic format documents, subject to Terms and Conditions for Electronic Documents at <http://www.sgs.com.tw/Terms-and-Conditions>. Attention is drawn to the limitation of liability, indemnification and jurisdiction issues defined therein. Any holder of this document is advised that information contained hereon reflects the Company's findings at the time of its intervention only and within the limits of Client's instructions, if any. The Company's sole responsibility is to its Client and this document does not exonerate parties to a transaction from exercising all their rights and obligations under the transaction documents. This document cannot be reproduced except in full, without prior written approval of the Company. Any unauthorized alteration, forgery or falsification of the content or appearance of this document is unlawful and offenders may be prosecuted to the fullest extent of the law.

802.11ax_40MHz_Chain1_5755MHz

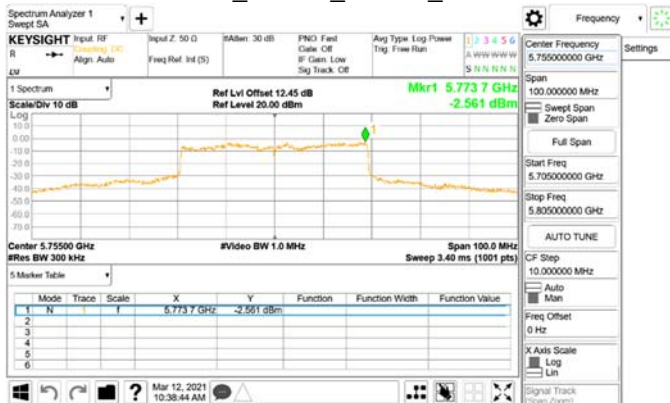

802.11ax_40MHz_Chain1_5795MHz_RU242_62



802.11ax_40MHz_Chain1_5755MHz_RU242_61

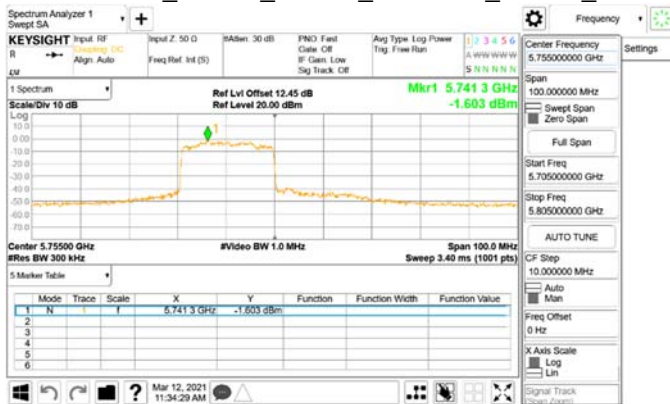

802.11ax_80MHz_Chain0_5210MHz



802.11ax_40MHz_Chain1_5795MHz

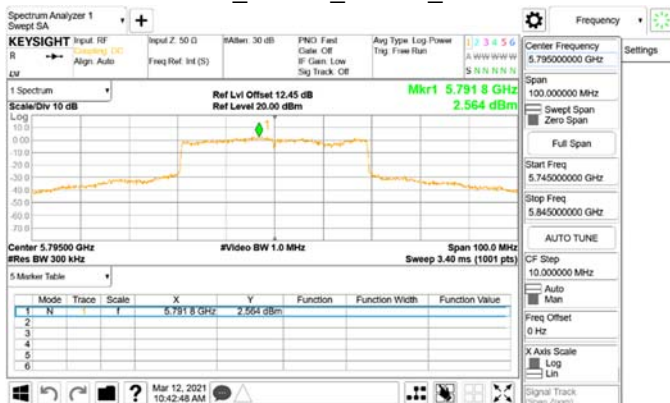

802.11ax_80MHz_Chain0_5210MHz_RU484_65



Unless otherwise stated the results shown in this test report refer only to the sample(s) tested and such sample(s) are retained for 90 days only.
 除非另有說明，此報告結果僅對測試之樣品負責，同時此樣品僅保留90天。本報告未經本公司書面許可，不可部份複製。
 This document is issued by the Company subject to its General Conditions of Service printed overleaf, available on request or accessible at <http://www.sgs.com.tw/Terms-and-Conditions> and for electronic format documents, subject to Terms and Conditions for Electronic Documents at <http://www.sgs.com.tw/Terms-and-Conditions>. Attention is drawn to the limitation of liability, indemnification and jurisdiction issues defined therein. Any holder of this document is advised that information contained hereon reflects the Company's findings at the time of its intervention only and within the limits of Client's instructions, if any. The Company's sole responsibility is to its Client and this document does not exonerate parties to a transaction from exercising all their rights and obligations under the transaction documents. This document cannot be reproduced except in full, without prior written approval of the Company. Any unauthorized alteration, forgery or falsification of the content or appearance of this document is unlawful and offenders may be prosecuted to the fullest extent of the law.

802.11ax_80MHz_Chain0_5290MHz



802.11ax_80MHz_Chain0_5530MHz_RU484_65



802.11ax_80MHz_Chain0_5290MHz_RU484_66

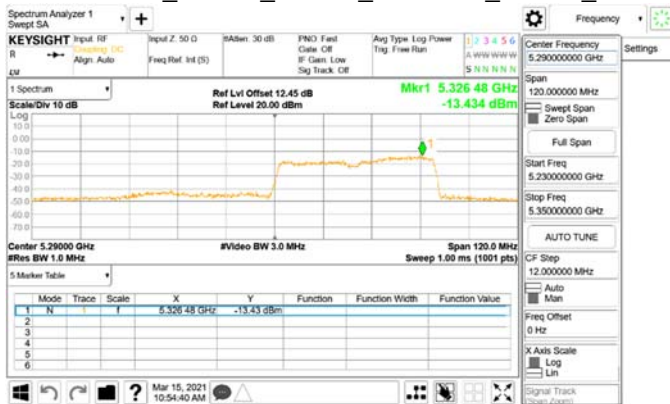

802.11ax_80MHz_Chain0_5610MHz

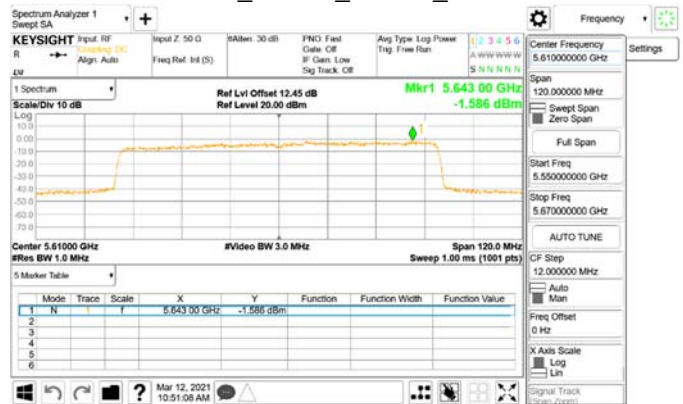

802.11ax_80MHz_Chain0_5530MHz



802.11ax_80MHz_Chain0_5610MHz_RU484_66



Unless otherwise stated the results shown in this test report refer only to the sample(s) tested and such sample(s) are retained for 90 days only.

除非另有說明，此報告結果僅對測試之樣品負責，同時此樣品僅保留90天。本報告未經本公司書面許可，不可部份複製。

This document is issued by the Company subject to its General Conditions of Service printed overleaf, available on request or accessible at <http://www.sgs.com.tw/Terms-and-Conditions> and for electronic format documents, subject to Terms and Conditions for Electronic Documents at <http://www.sgs.com.tw/Terms-and-Conditions>. Attention is drawn to the limitation of liability, indemnification and jurisdiction issues defined therein. Any holder of this document is advised that information contained hereon reflects the Company's findings at the time of its intervention only and within the limits of Client's instructions, if any. The Company's sole responsibility is to its Client and this document does not exonerate parties to a transaction from exercising all their rights and obligations under the transaction documents. This document cannot be reproduced except in full, without prior written approval of the Company. Any unauthorized alteration, forgery or falsification of the content or appearance of this document is unlawful and offenders may be prosecuted to the fullest extent of the law.

802.11ax_80MHz_Chain0_5690MHz_UNII 2C



802.11ax_80MHz_Chain0_5775MHz_RU484_65



802.11ax_80MHz_Chain0_5690MHz_UNII 3

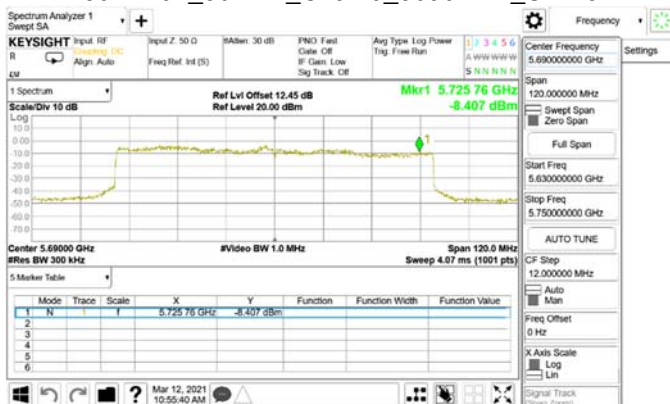

802.11ax_80MHz_Chain0_5775MHz_RU484_66



802.11ax_80MHz_Chain0_5775MHz



802.11ax_80MHz_Chain1_5210MHz



Unless otherwise stated the results shown in this test report refer only to the sample(s) tested and such sample(s) are retained for 90 days only.

除非另有說明，此報告結果僅對測試之樣品負責，同時此樣品僅保留90天。本報告未經本公司書面許可，不可部份複製。

This document is issued by the Company subject to its General Conditions of Service printed overleaf, available on request or accessible at <http://www.sgs.com.tw/Terms-and-Conditions> and for electronic format documents, subject to Terms and Conditions for Electronic Documents at <http://www.sgs.com.tw/Terms-and-Conditions>. Attention is drawn to the limitation of liability, indemnification and jurisdiction issues defined therein. Any holder of this document is advised that information contained hereon reflects the Company's findings at the time of its intervention only and within the limits of Client's instructions, if any. The Company's sole responsibility is to its Client and this document does not exonerate parties to a transaction from exercising all their rights and obligations under the transaction documents. This document cannot be reproduced except in full, without prior written approval of the Company. Any unauthorized alteration, forgery or falsification of the content or appearance of this document is unlawful and offenders may be prosecuted to the fullest extent of the law.

802.11ax_80MHz_Chain1_5210MHz_RU484_65

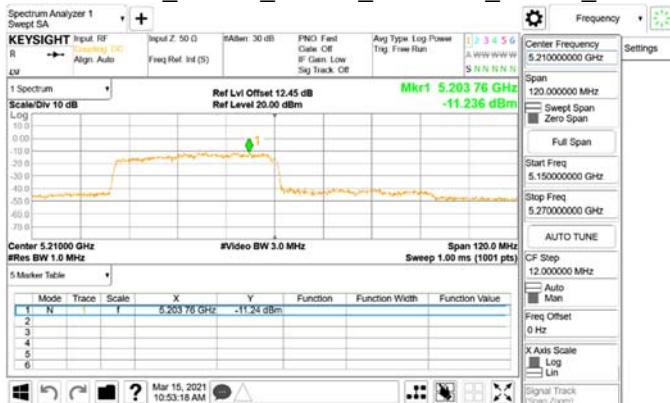

802.11ax_80MHz_Chain1_5530MHz



802.11ax_80MHz_Chain1_5290MHz



802.11ax_80MHz_Chain1_5530MHz_RU484_65

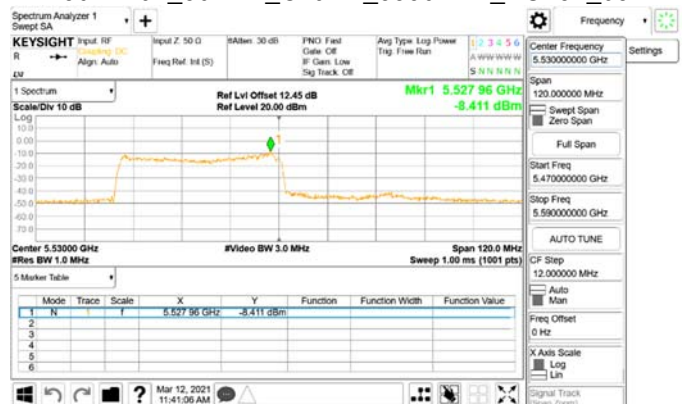

802.11ax_80MHz_Chain1_5290MHz_RU484_66

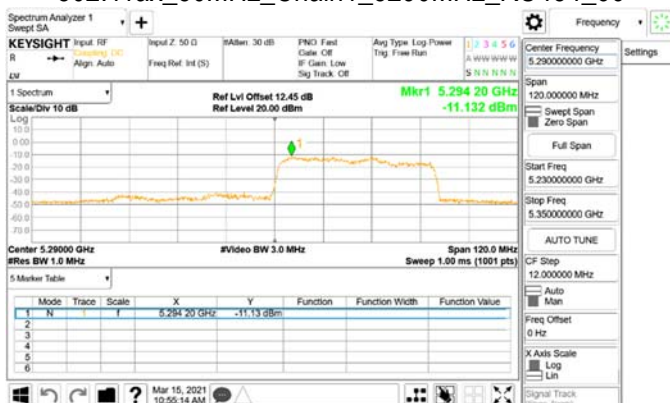

802.11ax_80MHz_Chain1_5610MHz



Unless otherwise stated the results shown in this test report refer only to the sample(s) tested and such sample(s) are retained for 90 days only.

除非另有說明，此報告結果僅對測試之樣品負責，同時此樣品僅保留90天。本報告未經本公司書面許可，不可部份複製。

This document is issued by the Company subject to its General Conditions of Service printed overleaf, available on request or accessible at <http://www.sgs.com.tw/Terms-and-Conditions> and for electronic format documents, subject to Terms and Conditions for Electronic Documents at <http://www.sgs.com.tw/Terms-and-Conditions>. Attention is drawn to the limitation of liability, indemnification and jurisdiction issues defined therein. Any holder of this document is advised that information contained hereon reflects the Company's findings at the time of its intervention only and within the limits of Client's instructions, if any. The Company's sole responsibility is to its Client and this document does not exonerate parties to a transaction from exercising all their rights and obligations under the transaction documents. This document cannot be reproduced except in full, without prior written approval of the Company. Any unauthorized alteration, forgery or falsification of the content or appearance of this document is unlawful and offenders may be prosecuted to the fullest extent of the law.

802.11ax_80MHz_Chain1_5610MHz_RU484_66



802.11ax_80MHz_Chain1_5775MHz

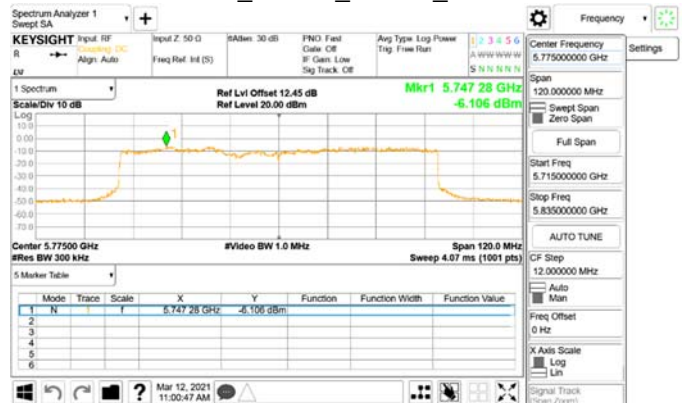

802.11ax_80MHz_Chain1_5690MHz_UNII 2C

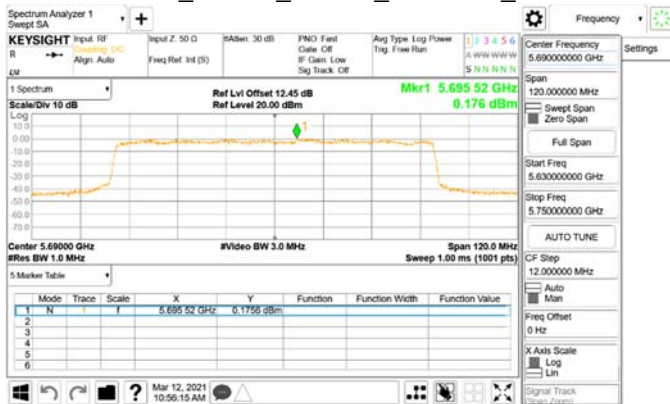

802.11ax_80MHz_Chain1_5775MHz_RU484_65

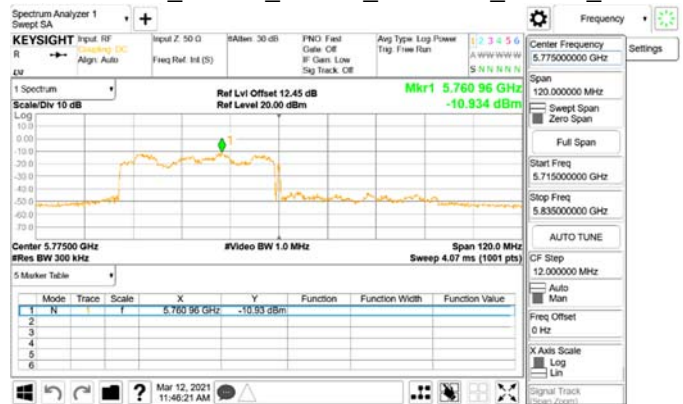

802.11ax_80MHz_Chain1_5690MHz_UNII 3

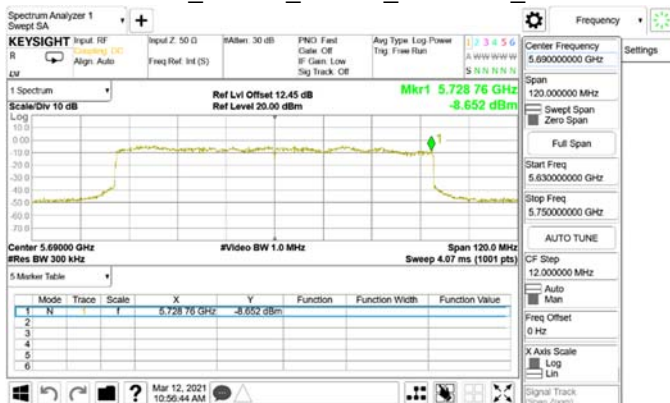

802.11ax_80MHz_Chain1_5775MHz_RU484_66



Unless otherwise stated the results shown in this test report refer only to the sample(s) tested and such sample(s) are retained for 90 days only.

除非另有說明，此報告結果僅對測試之樣品負責，同時此樣品僅保留90天。本報告未經本公司書面許可，不可部份複製。

This document is issued by the Company subject to its General Conditions of Service printed overleaf, available on request or accessible at <http://www.sgs.com.tw/Terms-and-Conditions> and for electronic format documents, subject to Terms and Conditions for Electronic Documents at <http://www.sgs.com.tw/Terms-and-Conditions>. Attention is drawn to the limitation of liability, indemnification and jurisdiction issues defined therein. Any holder of this document is advised that information contained hereon reflects the Company's findings at the time of its intervention only and within the limits of Client's instructions, if any. The Company's sole responsibility is to its Client and this document does not exonerate parties to a transaction from exercising all their rights and obligations under the transaction documents. This document cannot be reproduced except in full, without prior written approval of the Company. Any unauthorized alteration, forgery or falsification of the content or appearance of this document is unlawful and offenders may be prosecuted to the fullest extent of the law.

11 UNDESIRABLE RADIATED EMISSION MEASUREMENT

11.1 Standard Applicable

11.1.1 Band Edge

The maximum emissions outside of the frequency bands of operation shall be attenuated in accordance with the following limits:

1. For transmitters operating in the 5.15-5.25 GHz band: All emissions outside of the 5.15-5.35 GHz band shall not exceed an e.i.r.p. of -27 dBm/MHz.
2. For transmitters operating in the 5.725-5.85 GHz band: All emissions shall be limited to a level of -27 dBm/MHz at 75 MHz or more above or below the band edge increasing linearly to 10 dBm/MHz at 25 MHz above or below the band edge, and from 25 MHz above or below the band edge increasing linearly to a level of 15.6 dBm/MHz at 5 MHz above or below the band edge, and from 5 MHz above or below the band edge increasing linearly to a level of 27 dBm/MHz at the band edge.

| APPLICABLE TO | EIRP LIMIT | FIELD STRENGTH AT 3m |
|---|---|---|
| 15.407(b)(1) | PK: -27 (dBm/MHz) | PK: 68.3 (dBμV/m) |
| 15.407(b)(2) | | |
| 15.407(b)(3) | | |
| 15.407(b)(4)(i) | PK:-27 (dBm/MHz) *1 PK:10 (dBm/MHz) *2 PK:15.6 (dBm/MHz) *3 PK:27 (dBm/MHz) *4 | PK: 68.2(dBμV/m) *1 PK:105.2 (dBμV/m) *2 PK: 110.8(dBμV/m) *3 PK:122.2 (dBμV/m) *4 |
| <p>*1 beyond 75 MHz or more above of the bandedge. *2 below the band edge increasing linearly to 10 dBm/MHz at 25 MHz above. *3 below the band edge increasing linearly to a level of 15.6 dBm/MHz at 5 MHz above. *4 from 5 MHz above or below the band edge increasing linearly to a level of 27 dBm/MHz at the band edge.</p> | | |

$EIRP = (E \cdot d)^2 / 30$, where E is the field in V/m, d is the measurement distance (3m), $EIRP$ is the equivalent isotropically radiated power in Watts.

Unless otherwise stated the results shown in this test report refer only to the sample(s) tested and such sample(s) are retained for 90 days only.

除非另有說明，此報告結果僅對測試之樣品負責，同時此樣品僅保留90天。本報告未經本公司書面許可，不可部份複製。

This document is issued by the Company subject to its General Conditions of Service printed overleaf, available on request or accessible at <http://www.sgs.com.tw/Terms-and-Conditions> and for electronic format documents, subject to Terms and Conditions for Electronic Documents at <http://www.sgs.com.tw/Terms-and-Conditions>. Attention is drawn to the limitation of liability, indemnification and jurisdiction issues defined therein. Any holder of this document is advised that information contained hereon reflects the Company's findings at the time of its intervention only and within the limits of Client's instructions, if any. The Company's sole responsibility is to its Client and this document does not exonerate parties to a transaction from exercising all their rights and obligations under the transaction documents. This document cannot be reproduced except in full, without prior written approval of the Company. Any unauthorized alteration, forgery or falsification of the content or appearance of this document is unlawful and offenders may be prosecuted to the fullest extent of the law.

11.1.2 Spurious Emission

Unwanted spurious emissions which fall in the restricted bands must comply with the radiated emission limits specified as below table:

| Frequency (MHz) | Field strength (microvolts/meter) | Distance (meters) |
|-----------------|-----------------------------------|-------------------|
| 0.009-0.490 | 2400/F(KHz) | 300 |
| 0.490-1.705 | 24000/F(KHz) | 30 |
| 1.705-30 | 30 | 30 |
| 30-88 | 100 | 3 |
| 88-216 | 150 | 3 |
| 216-960 | 200 | 3 |
| Above 960 | 500 | 3 |

Note:

1. The lower limit shall apply at the transition frequencies.
2. Emission level (dBµV/m) = 20 log Emission level (µV/m)

Unless otherwise stated the results shown in this test report refer only to the sample(s) tested and such sample(s) are retained for 90 days only.

除非另有說明，此報告結果僅對測試之樣品負責，同時此樣品僅保留90天。本報告未經本公司書面許可，不可部份複製。

This document is issued by the Company subject to its General Conditions of Service printed overleaf, available on request or accessible at <http://www.sgs.com.tw/Terms-and-Conditions> and for electronic format documents, subject to Terms and Conditions for Electronic Documents at <http://www.sgs.com.tw/Terms-and-Conditions>. Attention is drawn to the limitation of liability, indemnification and jurisdiction issues defined therein. Any holder of this document is advised that information contained hereon reflects the Company's findings at the time of its intervention only and within the limits of Client's instructions, if any. The Company's sole responsibility is to its Client and this document does not exonerate parties to a transaction from exercising all their rights and obligations under the transaction documents. This document cannot be reproduced except in full, without prior written approval of the Company. Any unauthorized alteration, forgery or falsification of the content or appearance of this document is unlawful and offenders may be prosecuted to the fullest extent of the law.

11.2 Measurement Equipment Used

| Radiated Emission Test Site: SAC 3 | | | | | |
|------------------------------------|-----------------|-----------------|--------------------|------------|------------|
| EQUIPMENT TYPE | MFR | MODEL NUMBER | SERIAL NUMBER | LAST CAL. | CAL DUE. |
| Horn Antenna | Schwarzbeck | BBHA9170 | 184 | 12/11/2020 | 12/10/2021 |
| Horn Antenna | Schwarzbeck | BBHA9120D | 1441 | 10/16/2020 | 10/15/2021 |
| Bi-log Antenna | SCHWAZBECK | VULB9168 | 378 | 08/06/2020 | 08/05/2021 |
| Loop Antenna | ETS.LINDGREN | 6502 | 148045 | 10/19/2020 | 10/18/2021 |
| PXA Spectrum Analyzer | Agilent | N9030A | MY53120760 | 04/21/2020 | 04/20/2021 |
| EMI Test Receiver | R&S | ESCI 7 | 100759 | 07/13/2020 | 07/12/2021 |
| Pre-Amplifier | HP | 8449B | 3008A00578 | 12/16/2020 | 12/15/2021 |
| Pre-Amplifier | EMC Instruments | EMC184045B | 980135 | 10/27/2020 | 10/26/2021 |
| Pre-Amplifier | HP | 8447D | 2944A07676 | 12/16/2020 | 12/15/2021 |
| Attenuator | Mini-Circuit | BW-S10W2+ | 4 | 12/16/2020 | 12/15/2021 |
| Filter 5150-5350 MHz | Micro-Tronics | BRM50703 | 1 | 12/16/2020 | 12/15/2021 |
| Filter 5470-5725 MHz | Micro-Tronics | BRM50704 | 1 | 12/16/2020 | 12/15/2021 |
| Filter 5725-5875 MHz | Micro-Tronics | BRM50705 | 1 | 12/16/2020 | 12/15/2021 |
| High Pass Filter | WI | WHKX7.0/18G-8SS | 45 | 12/16/2020 | 12/15/2021 |
| Coaxial Cable | Huber Suhner | SUCOFLEX 102 | MY2636/2 | 12/16/2020 | 12/15/2021 |
| Coaxial Cable | Huber Suhner | SUCOFLEX 104 | 340057/4 | 12/16/2020 | 12/15/2021 |
| Coaxial Cable | Huber Suhner | SUCOFLEX 104PEA | 800052/2 | 12/16/2020 | 12/15/2021 |
| Coaxial Cable | Huber Suhner | SUCOFLEX 102 | MY2621/2 | 12/16/2020 | 12/15/2021 |
| Coaxial Cable | Huber Suhner | SUCOFLEX 102 | MY2617/2 | 12/16/2020 | 12/15/2021 |
| Coaxial Cable | Huber Suhner | SUCOFLEX 102 | MY2630/2 | 12/16/2020 | 12/15/2021 |
| Coaxial Cable | Huber Suhner | SUCOFLEX 102 | MY22962/2 | 12/16/2020 | 12/15/2021 |
| Site Cal | SGS | SAC III chamber | N/A | 01/01/2021 | 12/31/2021 |
| Test Software | audix | e3 | Ver. 6.11-20180413 | N.C.R | N.C.R |

Unless otherwise stated the results shown in this test report refer only to the sample(s) tested and such sample(s) are retained for 90 days only.

除非另有說明，此報告結果僅對測試之樣品負責，同時此樣品僅保留90天。本報告未經本公司書面許可，不可部份複製。

This document is issued by the Company subject to its General Conditions of Service printed overleaf, available on request or accessible at <http://www.sgs.com.tw/Terms-and-Conditions> and for electronic format documents, subject to Terms and Conditions for Electronic Documents at <http://www.sgs.com.tw/Terms-and-Conditions>. Attention is drawn to the limitation of liability, indemnification and jurisdiction issues defined therein. Any holder of this document is advised that information contained hereon reflects the Company's findings at the time of its intervention only and within the limits of Client's instructions, if any. The Company's sole responsibility is to its Client and this document does not exonerate parties to a transaction from exercising all their rights and obligations under the transaction documents. This document cannot be reproduced except in full, without prior written approval of the Company. Any unauthorized alteration, forgery or falsification of the content or appearance of this document is unlawful and offenders may be prosecuted to the fullest extent of the law.

11.3 Test SET-UP

(A) Radiated Emission Test Set-UP Frequency Below 30MHz.

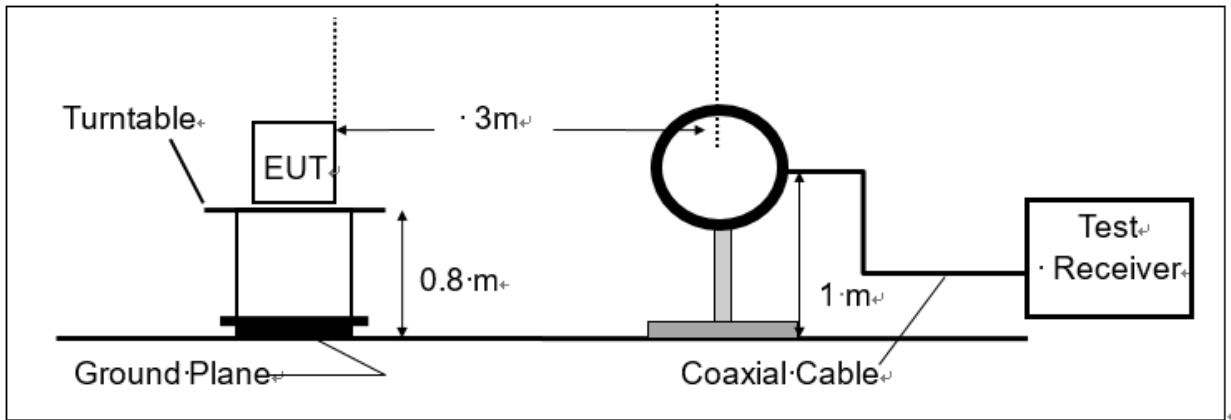

(B) Radiated Emission Test Set-UP, Frequency form 30MHz to 1000MHz

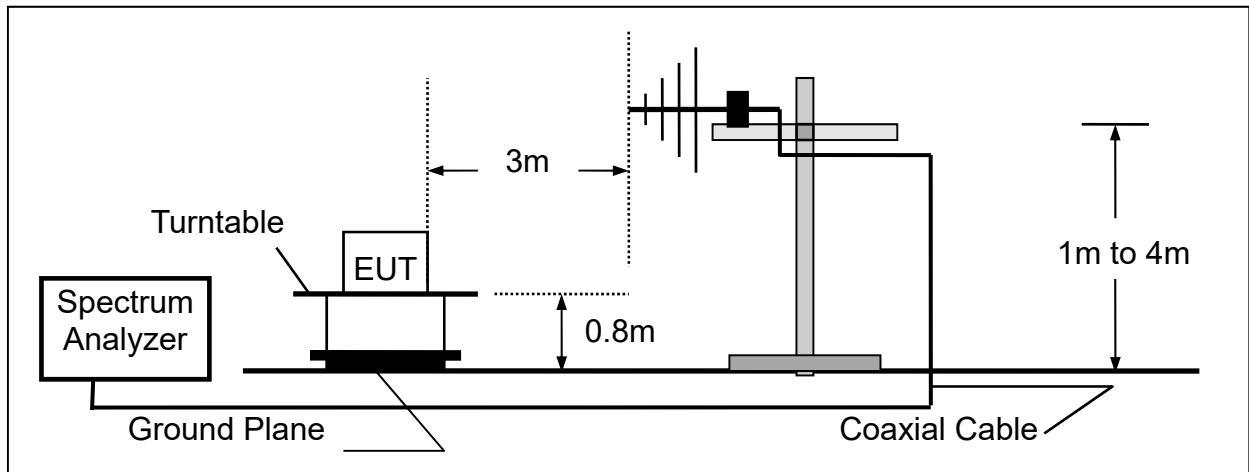

(C) Radiated Emission Test Set-UP Frequency Over 1 GHz

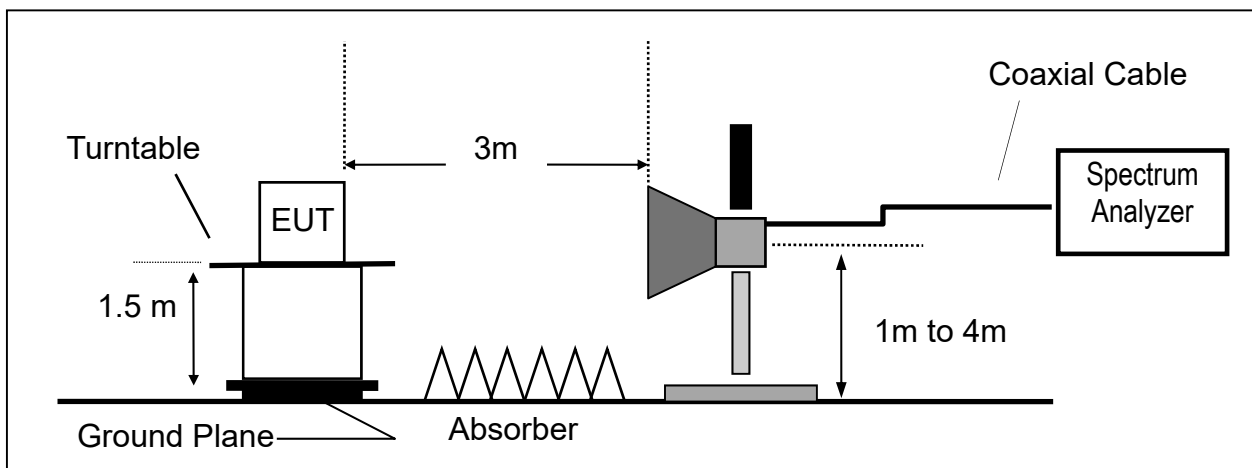

Unless otherwise stated the results shown in this test report refer only to the sample(s) tested and such sample(s) are retained for 90 days only.

除非另有說明，此報告結果僅對測試之樣品負責，同時此樣品僅保留90天。本報告未經本公司書面許可，不可部份複製。

This document is issued by the Company subject to its General Conditions of Service printed overleaf, available on request or accessible at <http://www.sgs.com.tw/Terms-and-Conditions> and for electronic format documents, subject to Terms and Conditions for Electronic Documents at <http://www.sgs.com.tw/Terms-and-Conditions>. Attention is drawn to the limitation of liability, indemnification and jurisdiction issues defined therein. Any holder of this document is advised that information contained hereon reflects the Company's findings at the time of its intervention only and within the limits of Client's instructions, if any. The Company's sole responsibility is to its Client and this document does not exonerate parties to a transaction from exercising all their rights and obligations under the transaction documents. This document cannot be reproduced except in full, without prior written approval of the Company. Any unauthorized alteration, forgery or falsification of the content or appearance of this document is unlawful and offenders may be prosecuted to the fullest extent of the law.

11.4 Measurement Procedure

1. The EUT was placed on a turn table which is 0.8m above ground plane.
2. The testing follows FCC KDB 789033 D02 General UNII Test Procedures New Rules .
3. The EUT was placed on a turn table with 0.8m for frequency < 1GHz and 1.5m for frequency > 1GHz above ground plane.
4. The turn table shall rotate 360 degrees to determine the position of maximum emission level.
5. EUT is set 3m away from the receiving antenna which varied from 1m to 4m to find out the highest emissions.
6. Set the spectrum analyzer as RBW=120 kHz and VBW=300 kHz for Peak Detector (PK) and Quasi-peak (QP) at frequency below 1 GHz.
7. At frequency above 1 GHz, Set the spectrum analyzer:
 - A. RBW=1 MHz, VBW=3 MHz for **Peak** Detector.
 - B. Set the spectrum analyzer as RBW=1 MHz, VBW=10 Hz (Duty cycle > 98%) or VBW $\geq 1/T$ (Duty cycle < 98%) for **Average** Detector.
8. Maximum procedure was performed on the six highest emissions to ensure EUT compliance.
9. And also, each emission was to be maximized by changing the polarization of receiving antenna both horizontal and vertical.
10. Repeat above procedures until all frequency measured were complete.

Unless otherwise stated the results shown in this test report refer only to the sample(s) tested and such sample(s) are retained for 90 days only.

除非另有說明，此報告結果僅對測試之樣品負責，同時此樣品僅保留90天。本報告未經本公司書面許可，不可部份複製。

This document is issued by the Company subject to its General Conditions of Service printed overleaf, available on request or accessible at <http://www.sgs.com.tw/Terms-and-Conditions> and for electronic format documents, subject to Terms and Conditions for Electronic Documents at <http://www.sgs.com.tw/Terms-and-Conditions>. Attention is drawn to the limitation of liability, indemnification and jurisdiction issues defined therein. Any holder of this document is advised that information contained hereon reflects the Company's findings at the time of its intervention only and within the limits of Client's instructions, if any. The Company's sole responsibility is to its Client and this document does not exonerate parties to a transaction from exercising all their rights and obligations under the transaction documents. This document cannot be reproduced except in full, without prior written approval of the Company. Any unauthorized alteration, forgery or falsification of the content or appearance of this document is unlawful and offenders may be prosecuted to the fullest extent of the law.

11.5 Field Strength Calculation

The field strength is calculated by adding the Antenna Factor and Cable Factor and subtracting the Amplifier Gain and Duty Cycle Correction Factor (if any) from the measured reading. The basic equation with a sample calculation is as follows:

$$FS = RA + AF + CL - AG$$

Where *FS* = Field Strength

CL = Cable Attenuation Factor (Cable Loss)

RA = Reading Amplitude

AG = Amplifier Gain

AF = Antenna Factor

The limit of the emission level is expressed in dBuV/m, which converts $20 \cdot \log(uV/m)$

Actual FS(dBuV/m) = SPA. Reading level(dBuV) + Factor(dB)

Factor(dB) = Antenna Factor(dBuV/m) + Cable Loss(dB) – Pre_Amplifier Gain(dB)

11.6 Test Results of Radiated Spurious Emissions form 9 KHz to 30 MHz

The low frequency, which started from 9 kHz to 30MHz, was pre-scanned and the result which was 20dB lower than the limit per 15.31(o) was not reported.

Pre-scanned was done at frequency 5.47 GHz and 5.85 GHz for bandedge measurement of straddle channels 138, 142 and 144 which was 20dB lower than the limit per 15.31(o) & RSS-GEN §6.13.2 was not reported.

Unless otherwise stated the results shown in this test report refer only to the sample(s) tested and such sample(s) are retained for 90 days only.

除非另有說明，此報告結果僅對測試之樣品負責，同時此樣品僅保留90天。本報告未經本公司書面許可，不可部份複製。

This document is issued by the Company subject to its General Conditions of Service printed overleaf, available on request or accessible at <http://www.sgs.com.tw/Terms-and-Conditions> and for electronic format documents, subject to Terms and Conditions for Electronic Documents at <http://www.sgs.com.tw/Terms-and-Conditions>. Attention is drawn to the limitation of liability, indemnification and jurisdiction issues defined therein. Any holder of this document is advised that information contained hereon reflects the Company's findings at the time of its intervention only and within the limits of Client's instructions, if any. The Company's sole responsibility is to its Client and this document does not exonerate parties to a transaction from exercising all their rights and obligations under the transaction documents. This document cannot be reproduced except in full, without prior written approval of the Company. Any unauthorized alteration, forgery or falsification of the content or appearance of this document is unlawful and offenders may be prosecuted to the fullest extent of the law.

11.7 Beamforming Mode Radiated Spurious Emission Measurement Result

11.7.1 Below 1GHz Worst-Case Data:

| | | | |
|----------------|----------------|--------------|------------------|
| Report Number | :ER-2021-20085 | Test Site | :SAC III Chamber |
| Operation Mode | :802.11n20 | Test Date | :2021-03-17 |
| Test Frequency | :5220 MHz | Temp./Humi. | :22.8/65 |
| Test Mode | :Tx CH Mid | Antenna Pol. | :VERTICAL |
| EUT Pol | :H Plane | Engineer | :Ricky |

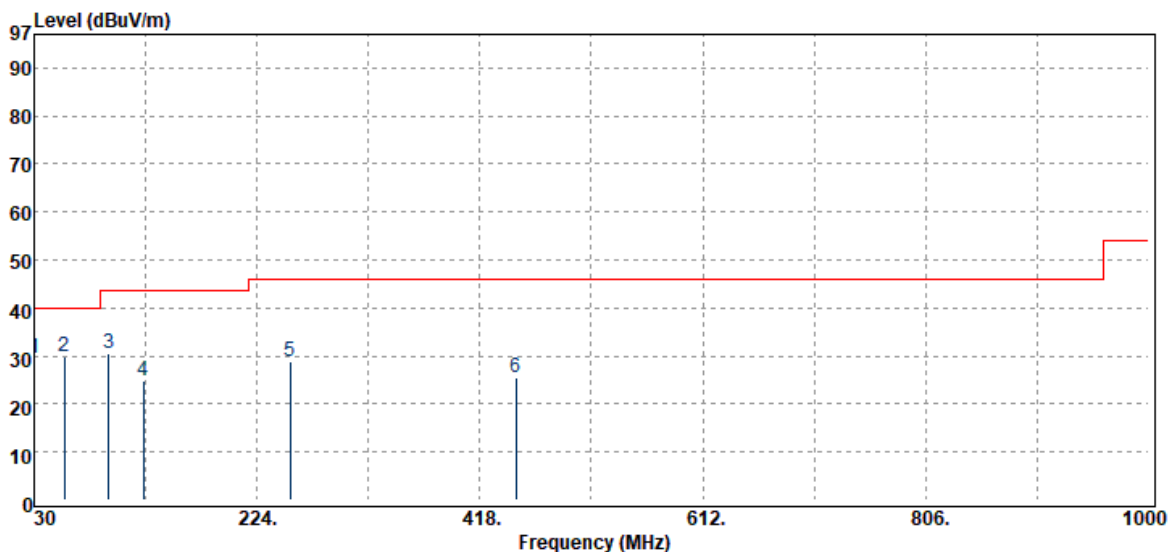

| Freq. MHz | Detector Mode PK/QP/AV | Spectrum Reading Level d μ V | Factor dB | Actual FS dBUV/m | Limit @3m dBUV/m | Margin dB |
|--------------|------------------------------|--|--------------|------------------------|------------------------|--------------|
| 30.00 | Peak | 39.13 | -9.68 | 29.45 | 40.00 | -10.55 |
| 56.19 | Peak | 38.78 | -9.01 | 29.77 | 40.00 | -10.23 |
| 94.99 | Peak | 44.52 | -14.00 | 30.52 | 43.50 | -12.98 |
| 125.06 | Peak | 34.37 | -9.47 | 24.90 | 43.50 | -18.60 |
| 253.10 | Peak | 37.36 | -8.59 | 28.77 | 46.00 | -17.23 |
| 449.04 | Peak | 28.97 | -3.30 | 25.67 | 46.00 | -20.33 |

Unless otherwise stated the results shown in this test report refer only to the sample(s) tested and such sample(s) are retained for 90 days only.

除非另有說明，此報告結果僅對測試之樣品負責，同時此樣品僅保留90天。本報告未經本公司書面許可，不可部份複製。

This document is issued by the Company subject to its General Conditions of Service printed overleaf, available on request or accessible at <http://www.sgs.com.tw/Terms-and-Conditions> and for electronic format documents, subject to Terms and Conditions for Electronic Documents at <http://www.sgs.com.tw/Terms-and-Conditions>. Attention is drawn to the limitation of liability, indemnification and jurisdiction issues defined therein. Any holder of this document is advised that information contained hereon reflects the Company's findings at the time of its intervention only and within the limits of Client's instructions, if any. The Company's sole responsibility is to its Client and this document does not exonerate parties to a transaction from exercising all their rights and obligations under the transaction documents. This document cannot be reproduced except in full, without prior written approval of the Company. Any unauthorized alteration, forgery or falsification of the content or appearance of this document is unlawful and offenders may be prosecuted to the fullest extent of the law.

Report Number :ER-2021-20085
 Operation Mode :802.11n20
 Test Frequency :5220 MHz
 Test Mode :Tx CH Mid
 EUT Pol :H Plane

Test Site :SAC III Chamber
 Test Date :2021-03-17
 Temp./Humi. :22.8/65
 Antenna Pol. :HORIZONTAL
 Engineer :Ricky

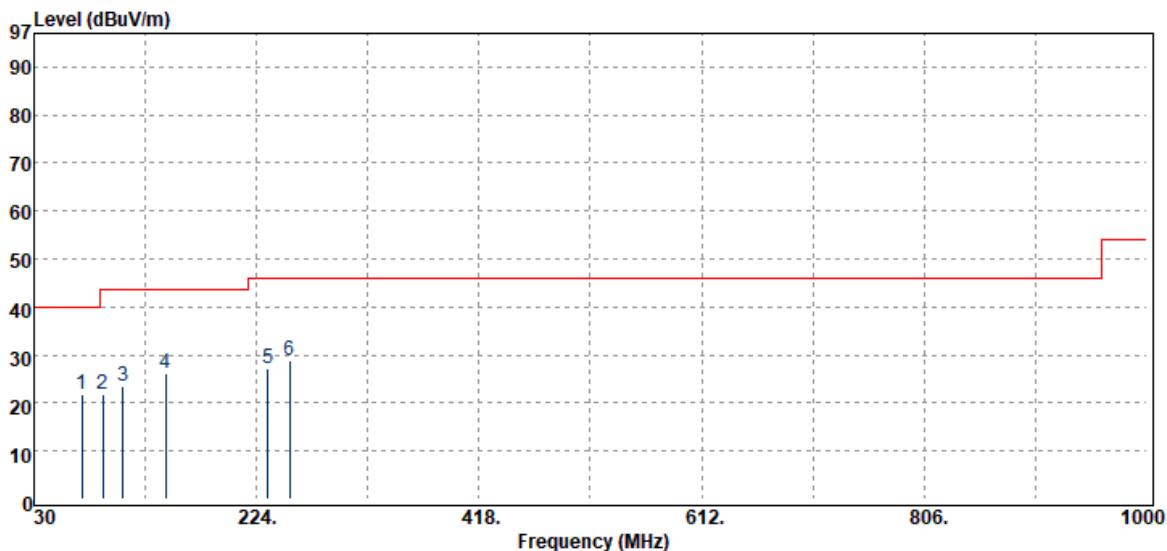

| Freq. MHz | Detector Mode PK/QP/AV | Spectrum Reading Level dB μ V | Factor dB | Actual FS dB μ V/m | Limit @3m dB μ V/m | Margin dB |
|--------------|------------------------------|---|--------------|------------------------------|------------------------------|--------------|
| 71.71 | Peak | 32.23 | -10.50 | 21.73 | 40.00 | -18.27 |
| 90.14 | Peak | 36.00 | -14.26 | 21.74 | 43.50 | -21.76 |
| 107.60 | Peak | 35.19 | -11.84 | 23.35 | 43.50 | -20.15 |
| 144.46 | Peak | 34.38 | -8.09 | 26.29 | 43.50 | -17.21 |
| 233.70 | Peak | 36.68 | -9.42 | 27.26 | 46.00 | -18.74 |
| 253.10 | Peak | 37.52 | -8.59 | 28.93 | 46.00 | -17.07 |

Unless otherwise stated the results shown in this test report refer only to the sample(s) tested and such sample(s) are retained for 90 days only.

除非另有說明，此報告結果僅對測試之樣品負責，同時此樣品僅保留90天。本報告未經本公司書面許可，不可部份複製。

This document is issued by the Company subject to its General Conditions of Service printed overleaf, available on request or accessible at <http://www.sgs.com.tw/Terms-and-Conditions> and for electronic format documents, subject to Terms and Conditions for Electronic Documents at <http://www.sgs.com.tw/Terms-and-Conditions>. Attention is drawn to the limitation of liability, indemnification and jurisdiction issues defined therein. Any holder of this document is advised that information contained hereon reflects the Company's findings at the time of its intervention only and within the limits of Client's instructions, if any. The Company's sole responsibility is to its Client and this document does not exonerate parties to a transaction from exercising all their rights and obligations under the transaction documents. This document cannot be reproduced except in full, without prior written approval of the Company. Any unauthorized alteration, forgery or falsification of the content or appearance of this document is unlawful and offenders may be prosecuted to the fullest extent of the law.

Report Number :ER-2021-20085
 Operation Mode :802.11n20
 Test Frequency :5300 MHz
 Test Mode :Tx CH Mid
 EUT Pol :H Plane

Test Site :SAC III Chamber
 Test Date :2021-03-17
 Temp./Humi. :22.8/65
 Antenna Pol. :VERTICAL
 Engineer :Ricky

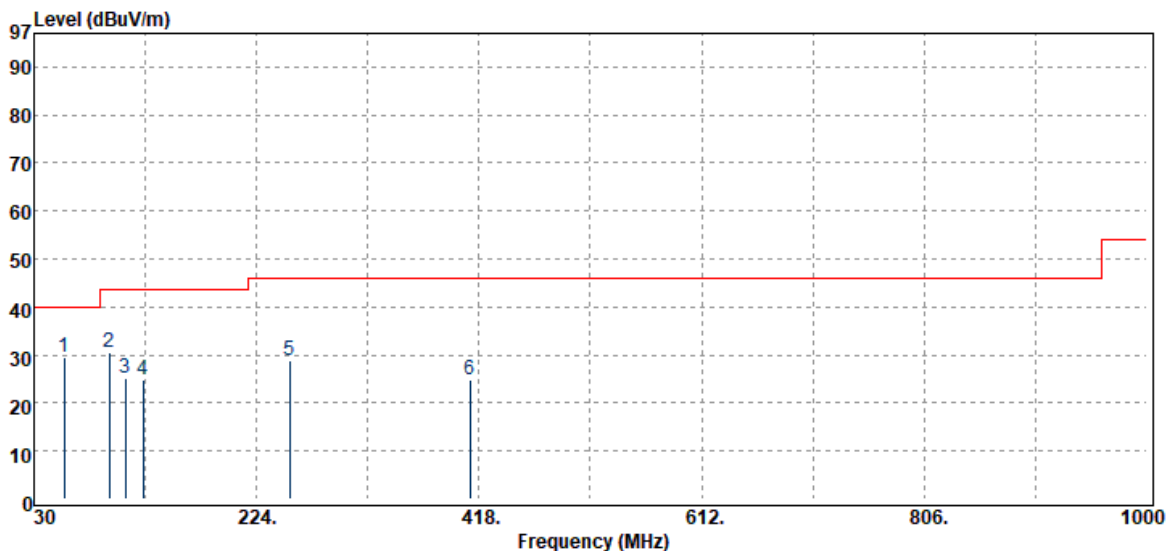

| Freq. MHz | Detector Mode PK/QP/AV | Spectrum Reading Level dBμV | Factor dB | Actual FS dBμV/m | Limit @3m dBμV/m | Margin dB |
|--------------|------------------------------|-----------------------------------|--------------|------------------------|------------------------|--------------|
| 56.19 | Peak | 38.60 | -9.01 | 29.59 | 40.00 | -10.41 |
| 95.96 | Peak | 44.43 | -13.99 | 30.44 | 43.50 | -13.06 |
| 109.54 | Peak | 36.62 | -11.41 | 25.21 | 43.50 | -18.29 |
| 125.06 | Peak | 34.36 | -9.47 | 24.89 | 43.50 | -18.61 |
| 253.10 | Peak | 37.33 | -8.59 | 28.74 | 46.00 | -17.26 |
| 410.24 | Peak | 29.60 | -4.80 | 24.80 | 46.00 | -21.20 |

Unless otherwise stated the results shown in this test report refer only to the sample(s) tested and such sample(s) are retained for 90 days only.

除非另有說明，此報告結果僅對測試之樣品負責，同時此樣品僅保留90天。本報告未經本公司書面許可，不可部份複製。

This document is issued by the Company subject to its General Conditions of Service printed overleaf, available on request or accessible at <http://www.sgs.com.tw/Terms-and-Conditions> and for electronic format documents, subject to Terms and Conditions for Electronic Documents at <http://www.sgs.com.tw/Terms-and-Conditions>. Attention is drawn to the limitation of liability, indemnification and jurisdiction issues defined therein. Any holder of this document is advised that information contained hereon reflects the Company's findings at the time of its intervention only and within the limits of Client's instructions, if any. The Company's sole responsibility is to its Client and this document does not exonerate parties to a transaction from exercising all their rights and obligations under the transaction documents. This document cannot be reproduced except in full, without prior written approval of the Company. Any unauthorized alteration, forgery or falsification of the content or appearance of this document is unlawful and offenders may be prosecuted to the fullest extent of the law.

Report Number :ER-2021-20085
 Operation Mode :802.11n20
 Test Frequency :5300 MHz
 Test Mode :Tx CH Mid
 EUT Pol :H Plane

Test Site :SAC III Chamber
 Test Date :2021-03-17
 Temp./Humi. :22.8/65
 Antenna Pol. :HORIZONTAL
 Engineer :Ricky

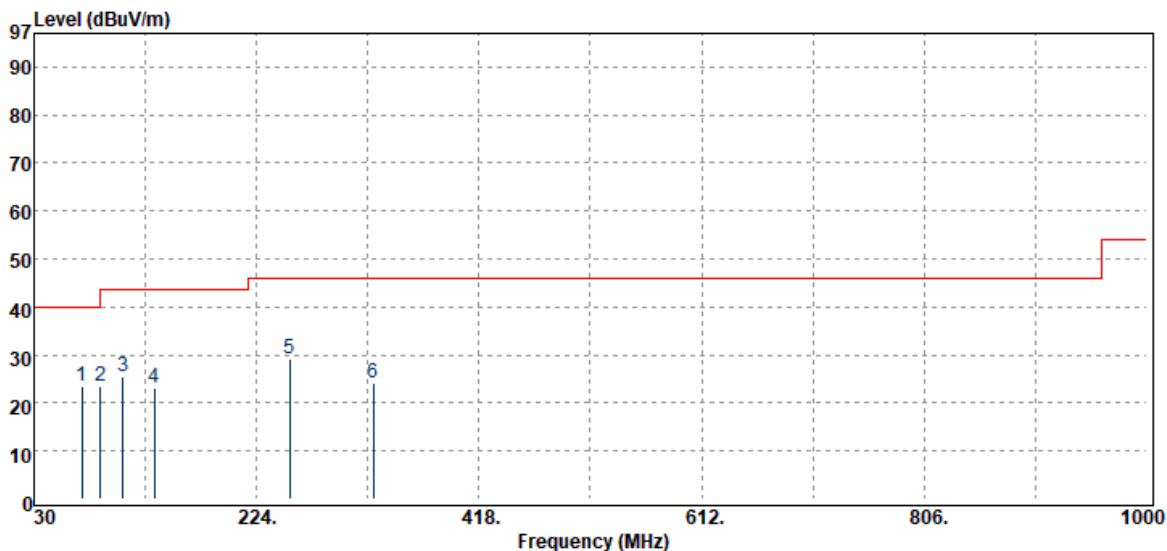

| Freq. MHz | Detector Mode PK/QP/AV | Spectrum Reading Level dB μ V | Factor dB | Actual FS dB μ V/m | Limit @3m dB μ V/m | Margin dB |
|--------------|------------------------------|---|--------------|------------------------------|------------------------------|--------------|
| 71.71 | Peak | 34.01 | -10.50 | 23.51 | 40.00 | -16.49 |
| 88.20 | Peak | 37.68 | -14.25 | 23.43 | 43.50 | -20.07 |
| 107.60 | Peak | 37.22 | -11.84 | 25.38 | 43.50 | -18.12 |
| 134.76 | Peak | 31.85 | -8.62 | 23.23 | 43.50 | -20.27 |
| 253.10 | Peak | 37.82 | -8.59 | 29.23 | 46.00 | -16.77 |
| 325.85 | Peak | 29.89 | -5.87 | 24.02 | 46.00 | -21.98 |

Unless otherwise stated the results shown in this test report refer only to the sample(s) tested and such sample(s) are retained for 90 days only.

除非另有說明，此報告結果僅對測試之樣品負責，同時此樣品僅保留90天。本報告未經本公司書面許可，不可部份複製。

This document is issued by the Company subject to its General Conditions of Service printed overleaf, available on request or accessible at <http://www.sgs.com.tw/Terms-and-Conditions> and for electronic format documents, subject to Terms and Conditions for Electronic Documents at <http://www.sgs.com.tw/Terms-and-Conditions>. Attention is drawn to the limitation of liability, indemnification and jurisdiction issues defined therein. Any holder of this document is advised that information contained hereon reflects the Company's findings at the time of its intervention only and within the limits of Client's instructions, if any. The Company's sole responsibility is to its Client and this document does not exonerate parties to a transaction from exercising all their rights and obligations under the transaction documents. This document cannot be reproduced except in full, without prior written approval of the Company. Any unauthorized alteration, forgery or falsification of the content or appearance of this document is unlawful and offenders may be prosecuted to the fullest extent of the law.

Report Number :ER-2021-20085
 Operation Mode :802.11n20
 Test Frequency :5580 MHz
 Test Mode :Tx CH Mid
 EUT Pol :H Plane

Test Site :SAC III Chamber
 Test Date :2021-03-17
 Temp./Humi. :22.8/65
 Antenna Pol. :VERTICAL
 Engineer :Ricky

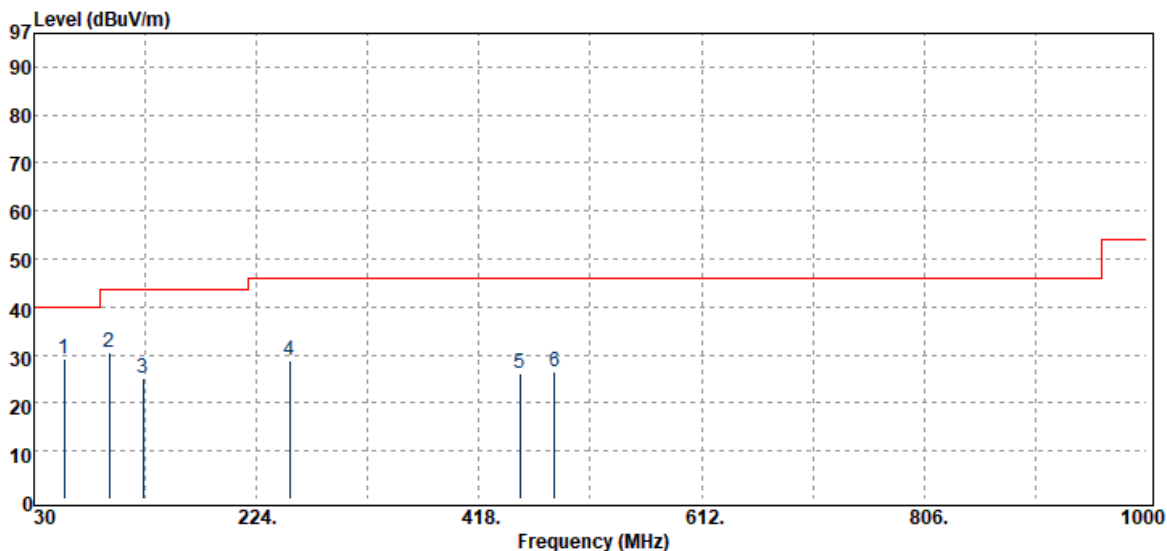

| Freq. MHz | Detector Mode PK/QP/AV | Spectrum Reading Level dB μ V | Factor dB | Actual FS dB μ V/m | Limit @3m dB μ V/m | Margin dB |
|--------------|------------------------------|---|--------------|------------------------------|------------------------------|--------------|
| 56.19 | Peak | 38.36 | -9.01 | 29.35 | 40.00 | -10.65 |
| 95.96 | Peak | 44.60 | -13.99 | 30.61 | 43.50 | -12.89 |
| 125.06 | Peak | 34.51 | -9.47 | 25.04 | 43.50 | -18.46 |
| 253.10 | Peak | 37.35 | -8.59 | 28.76 | 46.00 | -17.24 |
| 453.89 | Peak | 29.36 | -3.17 | 26.19 | 46.00 | -19.81 |
| 483.96 | Peak | 29.66 | -3.20 | 26.46 | 46.00 | -19.54 |

Unless otherwise stated the results shown in this test report refer only to the sample(s) tested and such sample(s) are retained for 90 days only.

除非另有說明，此報告結果僅對測試之樣品負責，同時此樣品僅保留90天。本報告未經本公司書面許可，不可部份複製。

This document is issued by the Company subject to its General Conditions of Service printed overleaf, available on request or accessible at <http://www.sgs.com.tw/Terms-and-Conditions> and for electronic format documents, subject to Terms and Conditions for Electronic Documents at <http://www.sgs.com.tw/Terms-and-Conditions>. Attention is drawn to the limitation of liability, indemnification and jurisdiction issues defined therein. Any holder of this document is advised that information contained hereon reflects the Company's findings at the time of its intervention only and within the limits of Client's instructions, if any. The Company's sole responsibility is to its Client and this document does not exonerate parties to a transaction from exercising all their rights and obligations under the transaction documents. This document cannot be reproduced except in full, without prior written approval of the Company. Any unauthorized alteration, forgery or falsification of the content or appearance of this document is unlawful and offenders may be prosecuted to the fullest extent of the law.

Report Number :ER-2021-20085
 Operation Mode :802.11n20
 Test Frequency :5580 MHz
 Test Mode :Tx CH Mid
 EUT Pol :H Plane

Test Site :SAC III Chamber
 Test Date :2021-03-17
 Temp./Humi. :22.8/65
 Antenna Pol. :HORIZONTAL
 Engineer :Ricky

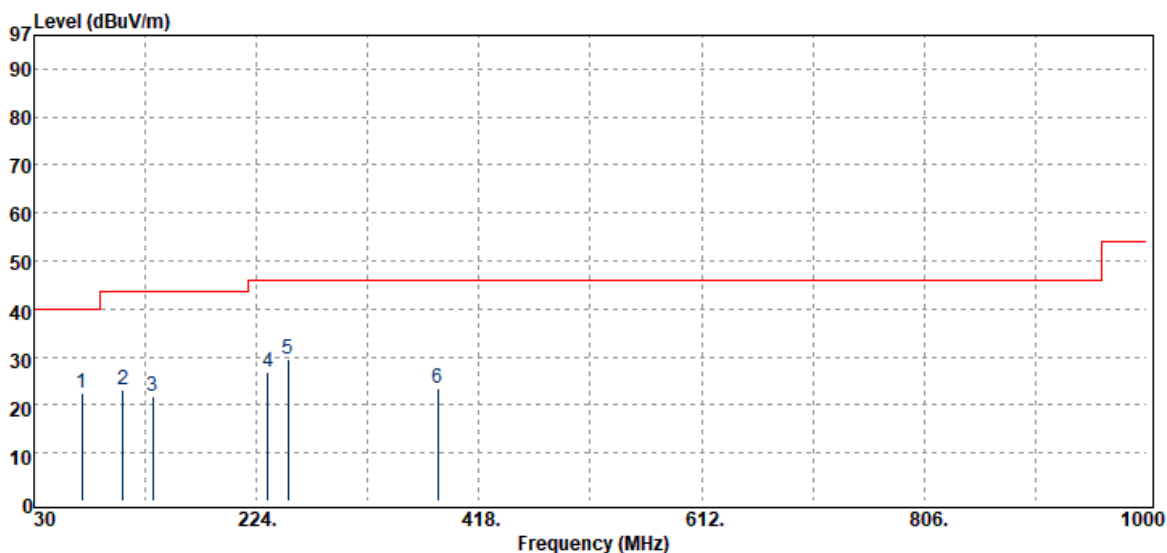

| Freq. MHz | Detector Mode PK/QP/AV | Spectrum Reading Level dB μ V | Factor dB | Actual FS dB μ V/m | Limit @3m dB μ V/m | Margin dB |
|--------------|------------------------------|---|--------------|------------------------------|------------------------------|--------------|
| 71.71 | Peak | 33.04 | -10.50 | 22.54 | 40.00 | -17.46 |
| 107.60 | Peak | 34.89 | -11.84 | 23.05 | 43.50 | -20.45 |
| 133.79 | Peak | 30.55 | -8.80 | 21.75 | 43.50 | -21.75 |
| 233.70 | Peak | 36.30 | -9.42 | 26.88 | 46.00 | -19.12 |
| 251.16 | Peak | 38.40 | -8.72 | 29.68 | 46.00 | -16.32 |
| 382.11 | Peak | 28.61 | -5.20 | 23.41 | 46.00 | -22.59 |

Unless otherwise stated the results shown in this test report refer only to the sample(s) tested and such sample(s) are retained for 90 days only.

除非另有說明，此報告結果僅對測試之樣品負責，同時此樣品僅保留90天。本報告未經本公司書面許可，不可部份複製。

This document is issued by the Company subject to its General Conditions of Service printed overleaf, available on request or accessible at <http://www.sgs.com.tw/Terms-and-Conditions> and for electronic format documents, subject to Terms and Conditions for Electronic Documents at <http://www.sgs.com.tw/Terms-and-Conditions>. Attention is drawn to the limitation of liability, indemnification and jurisdiction issues defined therein. Any holder of this document is advised that information contained hereon reflects the Company's findings at the time of its intervention only and within the limits of Client's instructions, if any. The Company's sole responsibility is to its Client and this document does not exonerate parties to a transaction from exercising all their rights and obligations under the transaction documents. This document cannot be reproduced except in full, without prior written approval of the Company. Any unauthorized alteration, forgery or falsification of the content or appearance of this document is unlawful and offenders may be prosecuted to the fullest extent of the law.

Report Number :ER-2021-20085
 Operation Mode :802.11n20
 Test Frequency :5785 MHz
 Test Mode :Tx CH Mid
 EUT Pol :H Plane

Test Site :SAC III Chamber
 Test Date :2021-03-17
 Temp./Humi. :22.8/65
 Antenna Pol. :VERTICAL
 Engineer :Ricky

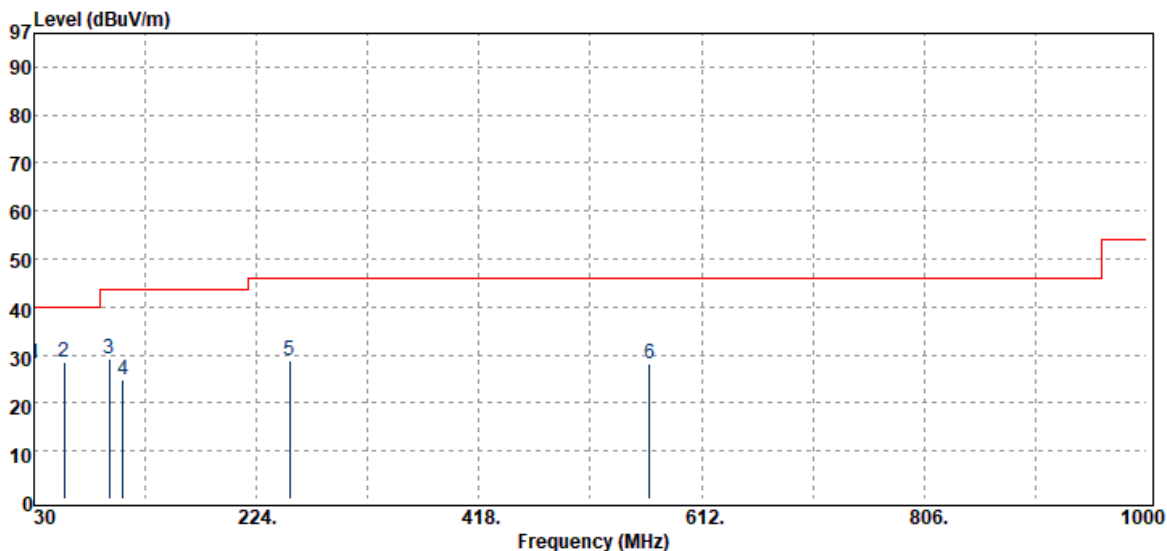

| Freq. MHz | Detector Mode PK/QP/AV | Spectrum Reading Level dBμV | Factor dB | Actual FS dBμV/m | Limit @3m dBμV/m | Margin dB |
|--------------|------------------------------|-----------------------------------|--------------|------------------------|------------------------|--------------|
| 30.00 | Peak | 37.72 | -9.68 | 28.04 | 40.00 | -11.96 |
| 56.19 | Peak | 37.51 | -9.01 | 28.50 | 40.00 | -11.50 |
| 95.96 | Peak | 43.06 | -13.99 | 29.07 | 43.50 | -14.43 |
| 107.60 | Peak | 36.52 | -11.84 | 24.68 | 43.50 | -18.82 |
| 253.10 | Peak | 37.50 | -8.59 | 28.91 | 46.00 | -17.09 |
| 566.41 | Peak | 29.79 | -1.54 | 28.25 | 46.00 | -17.75 |

Unless otherwise stated the results shown in this test report refer only to the sample(s) tested and such sample(s) are retained for 90 days only.

除非另有說明，此報告結果僅對測試之樣品負責，同時此樣品僅保留90天。本報告未經本公司書面許可，不可部份複製。

This document is issued by the Company subject to its General Conditions of Service printed overleaf, available on request or accessible at <http://www.sgs.com.tw/Terms-and-Conditions> and for electronic format documents, subject to Terms and Conditions for Electronic Documents at <http://www.sgs.com.tw/Terms-and-Conditions>. Attention is drawn to the limitation of liability, indemnification and jurisdiction issues defined therein. Any holder of this document is advised that information contained hereon reflects the Company's findings at the time of its intervention only and within the limits of Client's instructions, if any. The Company's sole responsibility is to its Client and this document does not exonerate parties to a transaction from exercising all their rights and obligations under the transaction documents. This document cannot be reproduced except in full, without prior written approval of the Company. Any unauthorized alteration, forgery or falsification of the content or appearance of this document is unlawful and offenders may be prosecuted to the fullest extent of the law.

Report Number :ER-2021-20085
 Operation Mode :802.11n20
 Test Frequency :5785 MHz
 Test Mode :Tx CH Mid
 EUT Pol :H Plane

Test Site :SAC III Chamber
 Test Date :2021-03-17
 Temp./Humi. :22.8/65
 Antenna Pol. :HORIZONTAL
 Engineer :Ricky

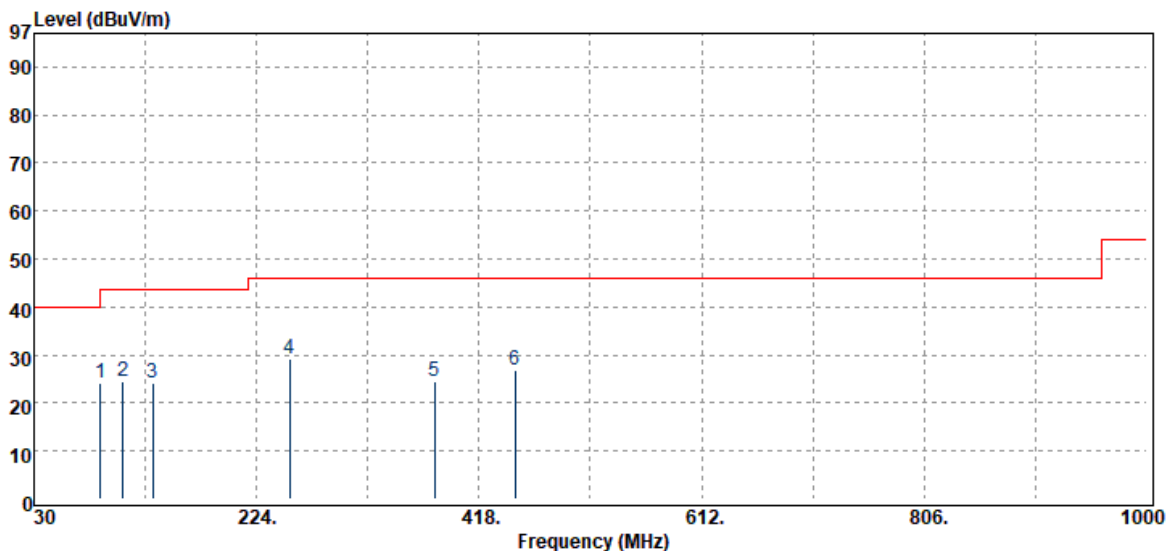

| Freq. MHz | Detector Mode PK/QP/AV | Spectrum Reading Level dB μ V | Factor dB | Actual FS dB μ V/m | Limit @3m dB μ V/m | Margin dB |
|--------------|------------------------------|---|--------------|------------------------------|------------------------------|--------------|
| 88.20 | Peak | 38.46 | -14.25 | 24.21 | 43.50 | -19.29 |
| 107.60 | Peak | 36.24 | -11.84 | 24.40 | 43.50 | -19.10 |
| 133.79 | Peak | 32.85 | -8.80 | 24.05 | 43.50 | -19.45 |
| 253.10 | Peak | 37.93 | -8.59 | 29.34 | 46.00 | -16.66 |
| 379.20 | Peak | 29.87 | -5.24 | 24.63 | 46.00 | -21.37 |
| 449.04 | Peak | 30.04 | -3.30 | 26.74 | 46.00 | -19.26 |

Unless otherwise stated the results shown in this test report refer only to the sample(s) tested and such sample(s) are retained for 90 days only.

除非另有說明，此報告結果僅對測試之樣品負責，同時此樣品僅保留90天。本報告未經本公司書面許可，不可部份複製。

This document is issued by the Company subject to its General Conditions of Service printed overleaf, available on request or accessible at <http://www.sgs.com.tw/Terms-and-Conditions> and for electronic format documents, subject to Terms and Conditions for Electronic Documents at <http://www.sgs.com.tw/Terms-and-Conditions>. Attention is drawn to the limitation of liability, indemnification and jurisdiction issues defined therein. Any holder of this document is advised that information contained hereon reflects the Company's findings at the time of its intervention only and within the limits of Client's instructions, if any. The Company's sole responsibility is to its Client and this document does not exonerate parties to a transaction from exercising all their rights and obligations under the transaction documents. This document cannot be reproduced except in full, without prior written approval of the Company. Any unauthorized alteration, forgery or falsification of the content or appearance of this document is unlawful and offenders may be prosecuted to the fullest extent of the law.

Report Number :ER-2021-20085
 Operation Mode :802.11ax80
 Test Frequency :5210 MHz
 Test Mode :Tx CH Low
 EUT Pol :H Plane

Test Site :SAC III Chamber
 Test Date :2021-03-17
 Temp./Humi. :22.8/65
 Antenna Pol. :VERTICAL
 Engineer :Ricky

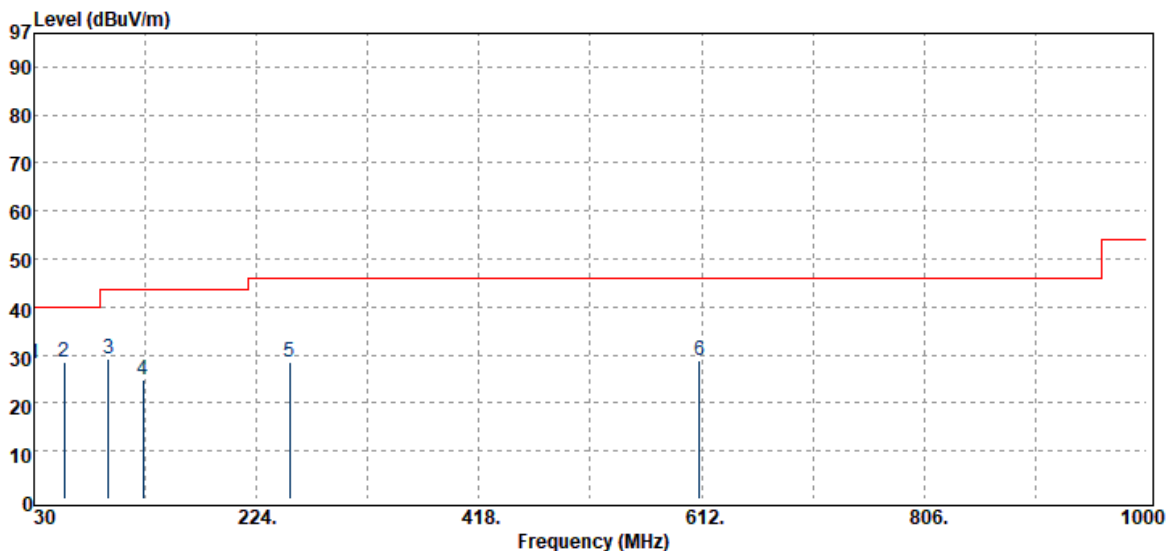

| Freq. MHz | Detector Mode PK/QP/AV | Spectrum Reading Level dB μ V | Factor dB | Actual FS dB μ V/m | Limit @3m dB μ V/m | Margin dB |
|--------------|------------------------------|---|--------------|------------------------------|------------------------------|--------------|
| 30.00 | Peak | 37.71 | -9.68 | 28.03 | 40.00 | -11.97 |
| 56.19 | Peak | 37.50 | -9.01 | 28.49 | 40.00 | -11.51 |
| 94.99 | Peak | 43.26 | -14.00 | 29.26 | 43.50 | -14.24 |
| 125.06 | Peak | 34.30 | -9.47 | 24.83 | 43.50 | -18.67 |
| 253.10 | Peak | 37.07 | -8.59 | 28.48 | 46.00 | -17.52 |
| 610.06 | Peak | 28.82 | 0.07 | 28.89 | 46.00 | -17.11 |

Unless otherwise stated the results shown in this test report refer only to the sample(s) tested and such sample(s) are retained for 90 days only.

除非另有說明，此報告結果僅對測試之樣品負責，同時此樣品僅保留90天。本報告未經本公司書面許可，不可部份複製。

This document is issued by the Company subject to its General Conditions of Service printed overleaf, available on request or accessible at <http://www.sgs.com.tw/Terms-and-Conditions> and for electronic format documents, subject to Terms and Conditions for Electronic Documents at <http://www.sgs.com.tw/Terms-and-Conditions>. Attention is drawn to the limitation of liability, indemnification and jurisdiction issues defined therein. Any holder of this document is advised that information contained hereon reflects the Company's findings at the time of its intervention only and within the limits of Client's instructions, if any. The Company's sole responsibility is to its Client and this document does not exonerate parties to a transaction from exercising all their rights and obligations under the transaction documents. This document cannot be reproduced except in full, without prior written approval of the Company. Any unauthorized alteration, forgery or falsification of the content or appearance of this document is unlawful and offenders may be prosecuted to the fullest extent of the law.

Report Number :ER-2021-20085
 Operation Mode :802.11ax80
 Test Frequency :5210 MHz
 Test Mode :Tx CH Low
 EUT Pol :H Plane

Test Site :SAC III Chamber
 Test Date :2021-03-17
 Temp./Humi. :22.8/65
 Antenna Pol. :HORIZONTAL
 Engineer :Ricky

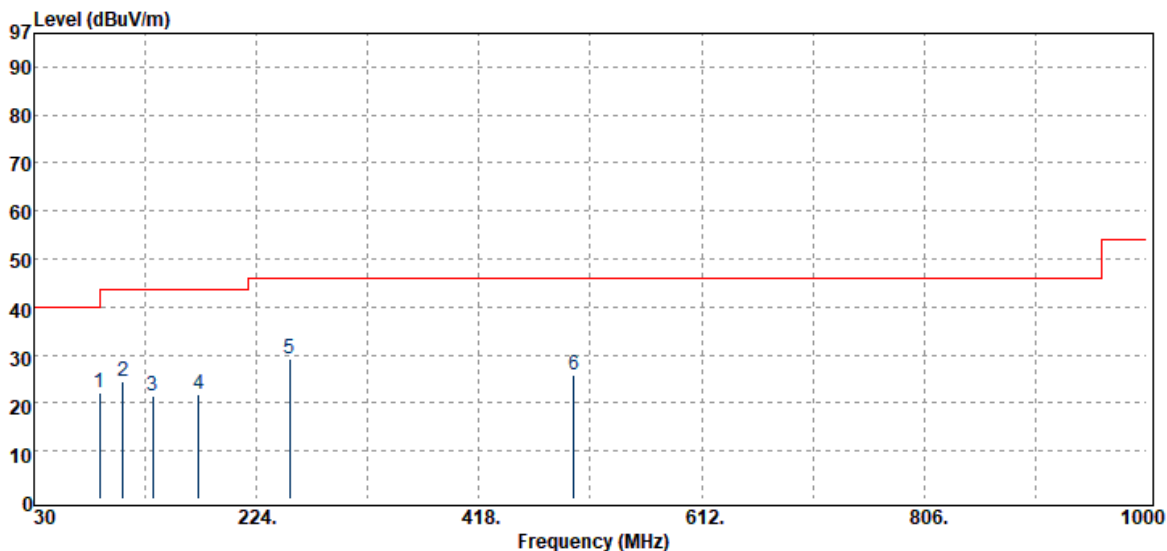

| Freq. MHz | Detector Mode PK/QP/AV | Spectrum Reading Level dB μ V | Factor dB | Actual FS dB μ V/m | Limit @3m dB μ V/m | Margin dB |
|--------------|------------------------------|---|--------------|------------------------------|------------------------------|--------------|
| 87.23 | Peak | 36.26 | -14.12 | 22.14 | 40.00 | -17.86 |
| 107.60 | Peak | 36.22 | -11.84 | 24.38 | 43.50 | -19.12 |
| 133.79 | Peak | 30.40 | -8.80 | 21.60 | 43.50 | -21.90 |
| 173.56 | Peak | 30.44 | -8.61 | 21.83 | 43.50 | -21.67 |
| 253.10 | Peak | 37.83 | -8.59 | 29.24 | 46.00 | -16.76 |
| 500.45 | Peak | 29.26 | -3.42 | 25.84 | 46.00 | -20.16 |

Unless otherwise stated the results shown in this test report refer only to the sample(s) tested and such sample(s) are retained for 90 days only.

除非另有說明，此報告結果僅對測試之樣品負責，同時此樣品僅保留90天。本報告未經本公司書面許可，不可部份複製。

This document is issued by the Company subject to its General Conditions of Service printed overleaf, available on request or accessible at <http://www.sgs.com.tw/Terms-and-Conditions> and for electronic format documents, subject to Terms and Conditions for Electronic Documents at <http://www.sgs.com.tw/Terms-and-Conditions>. Attention is drawn to the limitation of liability, indemnification and jurisdiction issues defined therein. Any holder of this document is advised that information contained hereon reflects the Company's findings at the time of its intervention only and within the limits of Client's instructions, if any. The Company's sole responsibility is to its Client and this document does not exonerate parties to a transaction from exercising all their rights and obligations under the transaction documents. This document cannot be reproduced except in full, without prior written approval of the Company. Any unauthorized alteration, forgery or falsification of the content or appearance of this document is unlawful and offenders may be prosecuted to the fullest extent of the law.

Report Number :ER-2021-20085
 Operation Mode :802.11ax80
 Test Frequency :5290 MHz
 Test Mode :Tx CH Low
 EUT Pol :H Plane

Test Site :SAC III Chamber
 Test Date :2021-03-17
 Temp./Humi. :22.8/65
 Antenna Pol. :VERTICAL
 Engineer :Ricky

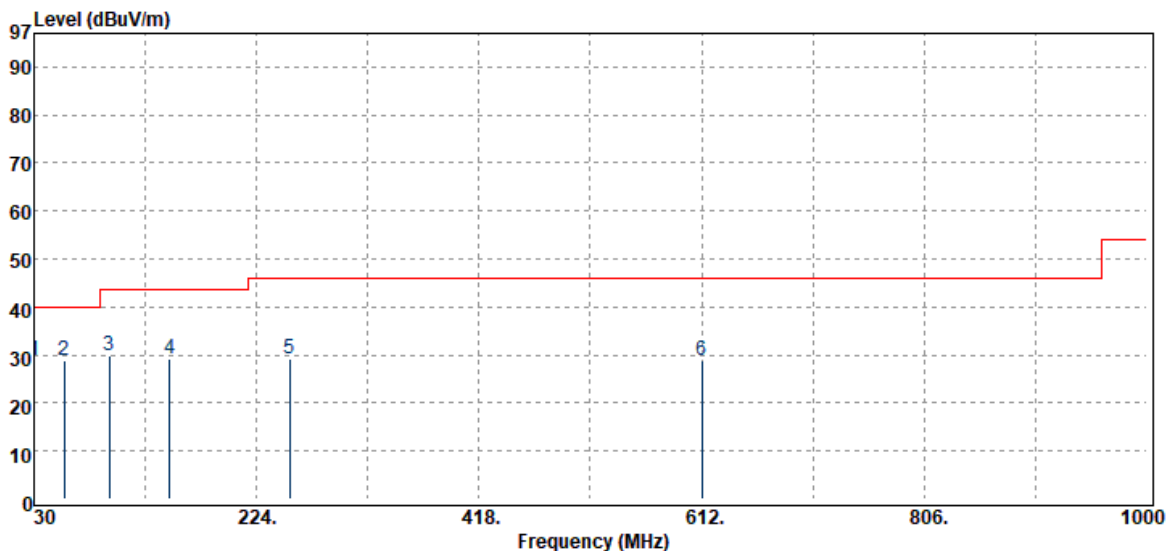

| Freq. MHz | Detector Mode PK/QP/AV | Spectrum Reading Level dB μ V | Factor dB | Actual FS dB μ V/m | Limit @3m dB μ V/m | Margin dB |
|--------------|------------------------------|---|--------------|------------------------------|------------------------------|--------------|
| 30.00 | Peak | 38.53 | -9.68 | 28.85 | 40.00 | -11.15 |
| 56.19 | Peak | 37.94 | -9.01 | 28.93 | 40.00 | -11.07 |
| 95.96 | Peak | 44.00 | -13.99 | 30.01 | 43.50 | -13.49 |
| 148.34 | Peak | 37.34 | -8.03 | 29.31 | 43.50 | -14.19 |
| 253.10 | Peak | 37.80 | -8.59 | 29.21 | 46.00 | -16.79 |
| 612.00 | Peak | 28.74 | 0.02 | 28.76 | 46.00 | -17.24 |

Unless otherwise stated the results shown in this test report refer only to the sample(s) tested and such sample(s) are retained for 90 days only.

除非另有說明，此報告結果僅對測試之樣品負責，同時此樣品僅保留90天。本報告未經本公司書面許可，不可部份複製。

This document is issued by the Company subject to its General Conditions of Service printed overleaf, available on request or accessible at <http://www.sgs.com.tw/Terms-and-Conditions> and for electronic format documents, subject to Terms and Conditions for Electronic Documents at <http://www.sgs.com.tw/Terms-and-Conditions>. Attention is drawn to the limitation of liability, indemnification and jurisdiction issues defined therein. Any holder of this document is advised that information contained hereon reflects the Company's findings at the time of its intervention only and within the limits of Client's instructions, if any. The Company's sole responsibility is to its Client and this document does not exonerate parties to a transaction from exercising all their rights and obligations under the transaction documents. This document cannot be reproduced except in full, without prior written approval of the Company. Any unauthorized alteration, forgery or falsification of the content or appearance of this document is unlawful and offenders may be prosecuted to the fullest extent of the law.

Report Number :ER-2021-20085
 Operation Mode :802.11ax80
 Test Frequency :5290 MHz
 Test Mode :Tx CH Low
 EUT Pol :H Plane

Test Site :SAC III Chamber
 Test Date :2021-03-17
 Temp./Humi. :22.8/65
 Antenna Pol. :HORIZONTAL
 Engineer :Ricky

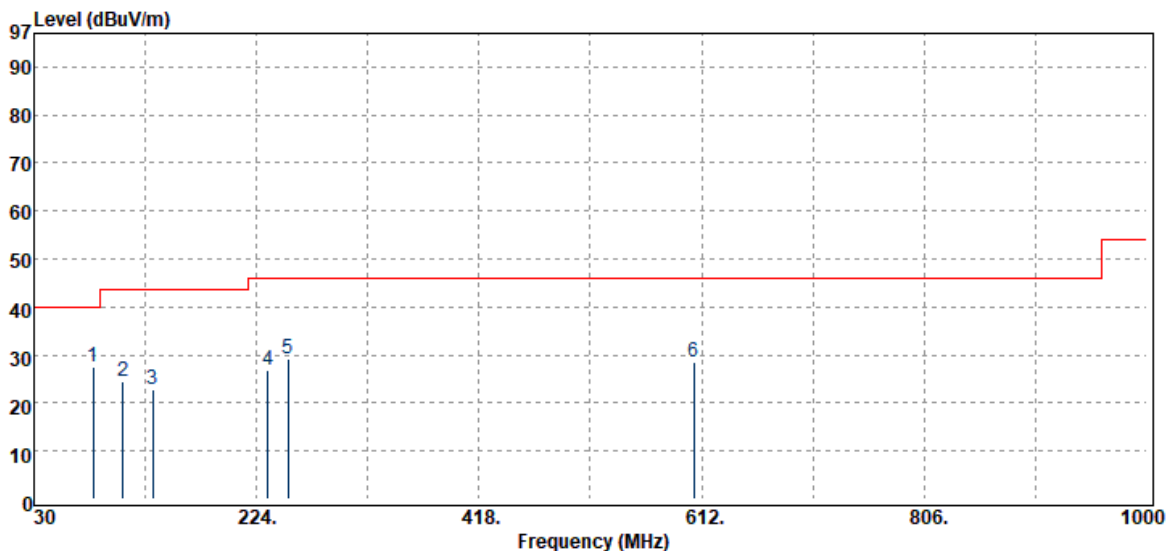

| Freq. MHz | Detector Mode PK/QP/AV | Spectrum Reading Level dB μ V | Factor dB | Actual FS dB μ V/m | Limit @3m dB μ V/m | Margin dB |
|--------------|------------------------------|---|--------------|------------------------------|------------------------------|--------------|
| 81.41 | Peak | 40.45 | -13.07 | 27.38 | 40.00 | -12.62 |
| 107.60 | Peak | 36.35 | -11.84 | 24.51 | 43.50 | -18.99 |
| 133.79 | Peak | 31.66 | -8.80 | 22.86 | 43.50 | -20.64 |
| 233.70 | Peak | 36.39 | -9.42 | 26.97 | 46.00 | -19.03 |
| 251.16 | Peak | 37.86 | -8.72 | 29.14 | 46.00 | -16.86 |
| 605.21 | Peak | 28.83 | -0.16 | 28.67 | 46.00 | -17.33 |

Unless otherwise stated the results shown in this test report refer only to the sample(s) tested and such sample(s) are retained for 90 days only.

除非另有說明，此報告結果僅對測試之樣品負責，同時此樣品僅保留90天。本報告未經本公司書面許可，不可部份複製。

This document is issued by the Company subject to its General Conditions of Service printed overleaf, available on request or accessible at <http://www.sgs.com.tw/Terms-and-Conditions> and for electronic format documents, subject to Terms and Conditions for Electronic Documents at <http://www.sgs.com.tw/Terms-and-Conditions>. Attention is drawn to the limitation of liability, indemnification and jurisdiction issues defined therein. Any holder of this document is advised that information contained hereon reflects the Company's findings at the time of its intervention only and within the limits of Client's instructions, if any. The Company's sole responsibility is to its Client and this document does not exonerate parties to a transaction from exercising all their rights and obligations under the transaction documents. This document cannot be reproduced except in full, without prior written approval of the Company. Any unauthorized alteration, forgery or falsification of the content or appearance of this document is unlawful and offenders may be prosecuted to the fullest extent of the law.

Report Number :ER-2021-20085
 Operation Mode :802.11ax80
 Test Frequency :5610 MHz
 Test Mode :Tx CH Mid
 EUT Pol :H Plane

Test Site :SAC III Chamber
 Test Date :2021-03-17
 Temp./Humi. :22.8/65
 Antenna Pol. :VERTICAL
 Engineer :Ricky

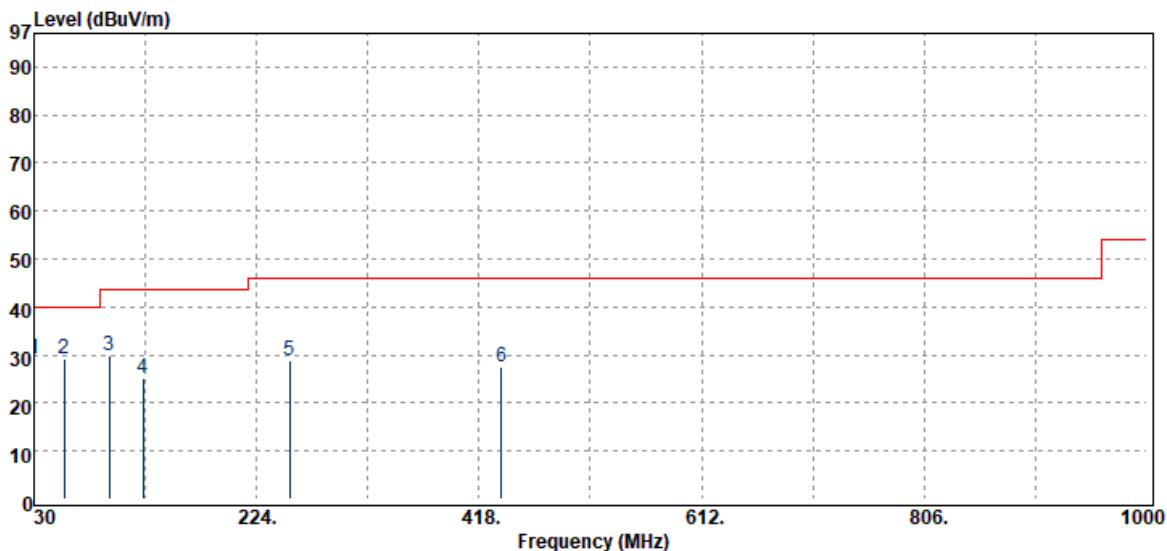

| Freq. MHz | Detector Mode PK/QP/AV | Spectrum Reading Level dB μ V | Factor dB | Actual FS dB μ V/m | Limit @3m dB μ V/m | Margin dB |
|--------------|------------------------------|---|--------------|------------------------------|------------------------------|--------------|
| 30.00 | Peak | 38.77 | -9.68 | 29.09 | 40.00 | -10.91 |
| 56.19 | Peak | 38.09 | -9.01 | 29.08 | 40.00 | -10.92 |
| 95.96 | Peak | 43.79 | -13.99 | 29.80 | 43.50 | -13.70 |
| 125.06 | Peak | 34.51 | -9.47 | 25.04 | 43.50 | -18.46 |
| 253.10 | Peak | 37.44 | -8.59 | 28.85 | 46.00 | -17.15 |
| 437.40 | Peak | 31.16 | -3.56 | 27.60 | 46.00 | -18.40 |

Unless otherwise stated the results shown in this test report refer only to the sample(s) tested and such sample(s) are retained for 90 days only.

除非另有說明，此報告結果僅對測試之樣品負責，同時此樣品僅保留90天。本報告未經本公司書面許可，不可部份複製。

This document is issued by the Company subject to its General Conditions of Service printed overleaf, available on request or accessible at <http://www.sgs.com.tw/Terms-and-Conditions> and for electronic format documents, subject to Terms and Conditions for Electronic Documents at <http://www.sgs.com.tw/Terms-and-Conditions>. Attention is drawn to the limitation of liability, indemnification and jurisdiction issues defined therein. Any holder of this document is advised that information contained hereon reflects the Company's findings at the time of its intervention only and within the limits of Client's instructions, if any. The Company's sole responsibility is to its Client and this document does not exonerate parties to a transaction from exercising all their rights and obligations under the transaction documents. This document cannot be reproduced except in full, without prior written approval of the Company. Any unauthorized alteration, forgery or falsification of the content or appearance of this document is unlawful and offenders may be prosecuted to the fullest extent of the law.

Report Number :ER-2021-20085
 Operation Mode :802.11ax80
 Test Frequency :5610 MHz
 Test Mode :Tx CH Mid
 EUT Pol :H Plane

Test Site :SAC III Chamber
 Test Date :2021-03-17
 Temp./Humi. :22.8/65
 Antenna Pol. :HORIZONTAL
 Engineer :Ricky

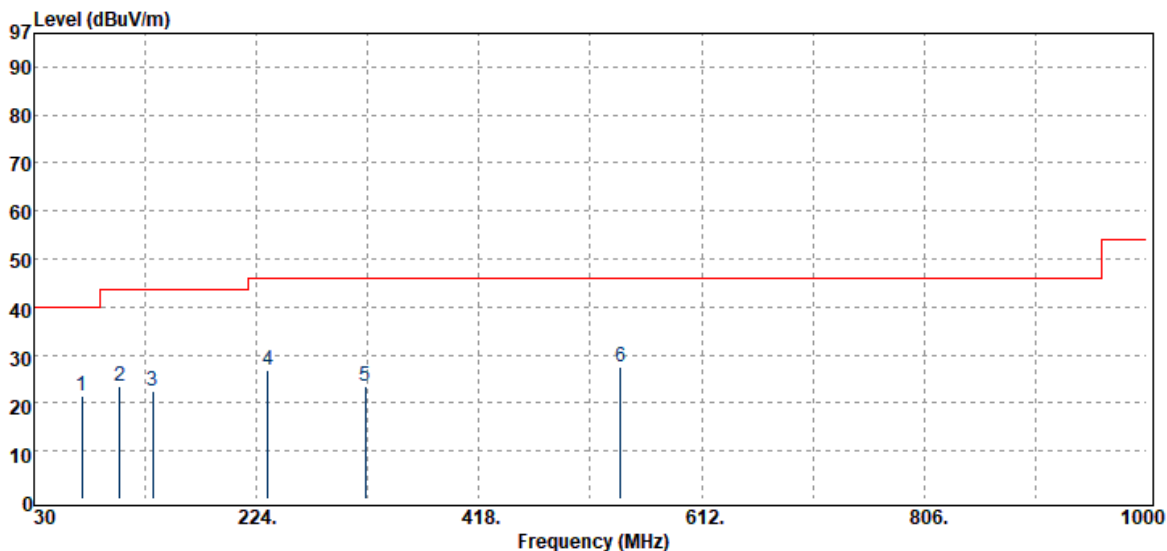

| Freq. MHz | Detector Mode PK/QP/AV | Spectrum Reading Level dBμV | Factor dB | Actual FS dBμV/m | Limit @3m dBμV/m | Margin dB |
|--------------|------------------------------|-----------------------------------|--------------|------------------------|------------------------|--------------|
| 71.71 | Peak | 32.04 | -10.50 | 21.54 | 40.00 | -18.46 |
| 104.69 | Peak | 35.66 | -12.24 | 23.42 | 43.50 | -20.08 |
| 133.79 | Peak | 31.37 | -8.80 | 22.57 | 43.50 | -20.93 |
| 233.70 | Peak | 36.22 | -9.42 | 26.80 | 46.00 | -19.20 |
| 319.06 | Peak | 29.52 | -6.10 | 23.42 | 46.00 | -22.58 |
| 541.19 | Peak | 29.49 | -2.07 | 27.42 | 46.00 | -18.58 |

Unless otherwise stated the results shown in this test report refer only to the sample(s) tested and such sample(s) are retained for 90 days only.

除非另有說明，此報告結果僅對測試之樣品負責，同時此樣品僅保留90天。本報告未經本公司書面許可，不可部份複製。

This document is issued by the Company subject to its General Conditions of Service printed overleaf, available on request or accessible at <http://www.sgs.com.tw/Terms-and-Conditions> and for electronic format documents, subject to Terms and Conditions for Electronic Documents at <http://www.sgs.com.tw/Terms-and-Conditions>. Attention is drawn to the limitation of liability, indemnification and jurisdiction issues defined therein. Any holder of this document is advised that information contained hereon reflects the Company's findings at the time of its intervention only and within the limits of Client's instructions, if any. The Company's sole responsibility is to its Client and this document does not exonerate parties to a transaction from exercising all their rights and obligations under the transaction documents. This document cannot be reproduced except in full, without prior written approval of the Company. Any unauthorized alteration, forgery or falsification of the content or appearance of this document is unlawful and offenders may be prosecuted to the fullest extent of the law.

Report Number :ER-2021-20085
 Operation Mode :802.11ax80
 Test Frequency :5775 MHz
 Test Mode :Tx CH Low
 EUT Pol :H Plane

Test Site :SAC III Chamber
 Test Date :2021-03-17
 Temp./Humi. :22.8/65
 Antenna Pol. :VERTICAL
 Engineer :Ricky

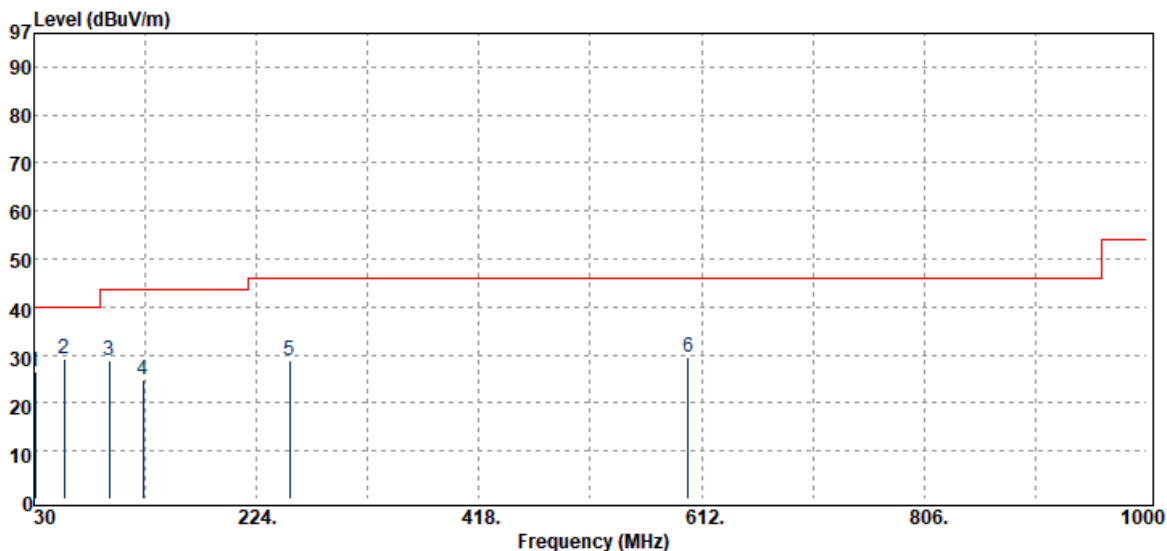

| Freq. MHz | Detector Mode PK/QP/AV | Spectrum Reading Level dB μ V | Factor dB | Actual FS dB μ V/m | Limit @3m dB μ V/m | Margin dB |
|--------------|------------------------------|---|--------------|------------------------------|------------------------------|--------------|
| 30.97 | Peak | 36.53 | -9.86 | 26.67 | 40.00 | -13.33 |
| 56.19 | Peak | 38.24 | -9.01 | 29.23 | 40.00 | -10.77 |
| 95.96 | Peak | 42.80 | -13.99 | 28.81 | 43.50 | -14.69 |
| 125.06 | Peak | 34.46 | -9.47 | 24.99 | 43.50 | -18.51 |
| 253.10 | Peak | 37.42 | -8.59 | 28.83 | 46.00 | -17.17 |
| 600.36 | Peak | 29.83 | -0.38 | 29.45 | 46.00 | -16.55 |

Unless otherwise stated the results shown in this test report refer only to the sample(s) tested and such sample(s) are retained for 90 days only.

除非另有說明，此報告結果僅對測試之樣品負責，同時此樣品僅保留90天。本報告未經本公司書面許可，不可部份複製。

This document is issued by the Company subject to its General Conditions of Service printed overleaf, available on request or accessible at <http://www.sgs.com.tw/Terms-and-Conditions> and for electronic format documents, subject to Terms and Conditions for Electronic Documents at <http://www.sgs.com.tw/Terms-and-Conditions>. Attention is drawn to the limitation of liability, indemnification and jurisdiction issues defined therein. Any holder of this document is advised that information contained hereon reflects the Company's findings at the time of its intervention only and within the limits of Client's instructions, if any. The Company's sole responsibility is to its Client and this document does not exonerate parties to a transaction from exercising all their rights and obligations under the transaction documents. This document cannot be reproduced except in full, without prior written approval of the Company. Any unauthorized alteration, forgery or falsification of the content or appearance of this document is unlawful and offenders may be prosecuted to the fullest extent of the law.

Report Number :ER-2021-20085
 Operation Mode :802.11ax80
 Test Frequency :5775 MHz
 Test Mode :Tx CH Low
 EUT Pol :H Plane

Test Site :SAC III Chamber
 Test Date :2021-03-17
 Temp./Humi. :22.8/65
 Antenna Pol. :HORIZONTAL
 Engineer :Ricky

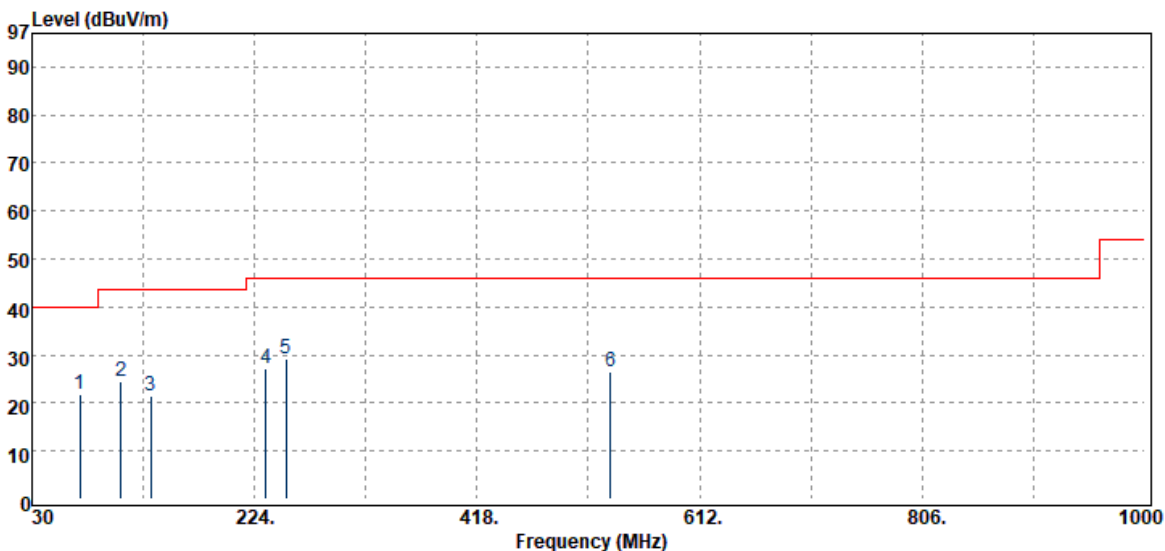

| Freq. MHz | Detector Mode PK/QP/AV | Spectrum Reading Level dB μ V | Factor dB | Actual FS dB μ V/m | Limit @3m dB μ V/m | Margin dB |
|--------------|------------------------------|---|--------------|------------------------------|------------------------------|--------------|
| 71.71 | Peak | 32.22 | -10.50 | 21.72 | 40.00 | -18.28 |
| 107.60 | Peak | 36.22 | -11.84 | 24.38 | 43.50 | -19.12 |
| 133.79 | Peak | 30.34 | -8.80 | 21.54 | 43.50 | -21.96 |
| 233.70 | Peak | 36.70 | -9.42 | 27.28 | 46.00 | -18.72 |
| 251.16 | Peak | 37.94 | -8.72 | 29.22 | 46.00 | -16.78 |
| 534.40 | Peak | 28.94 | -2.35 | 26.59 | 46.00 | -19.41 |

Unless otherwise stated the results shown in this test report refer only to the sample(s) tested and such sample(s) are retained for 90 days only.

除非另有說明，此報告結果僅對測試之樣品負責，同時此樣品僅保留90天。本報告未經本公司書面許可，不可部份複製。

This document is issued by the Company subject to its General Conditions of Service printed overleaf, available on request or accessible at <http://www.sgs.com.tw/Terms-and-Conditions> and for electronic format documents, subject to Terms and Conditions for Electronic Documents at <http://www.sgs.com.tw/Terms-and-Conditions>. Attention is drawn to the limitation of liability, indemnification and jurisdiction issues defined therein. Any holder of this document is advised that information contained hereon reflects the Company's findings at the time of its intervention only and within the limits of Client's instructions, if any. The Company's sole responsibility is to its Client and this document does not exonerate parties to a transaction from exercising all their rights and obligations under the transaction documents. This document cannot be reproduced except in full, without prior written approval of the Company. Any unauthorized alteration, forgery or falsification of the content or appearance of this document is unlawful and offenders may be prosecuted to the fullest extent of the law.

11.7.2 Above 1GHz Worst-Case Data:

| | | | |
|----------------|----------------|--------------|------------------|
| Report Number | :ER-2021-20085 | Test Site | :SAC III Chamber |
| Operation Mode | :802.11n20 | Test Date | :2021-03-16 |
| Test Frequency | :5180 MHz | Temp./Humi. | :22.7/63 |
| Test Mode | :Tx CH Low | Antenna Pol. | :VERTICAL |
| EUT Pol | :H Plane | Engineer | :Ricky |

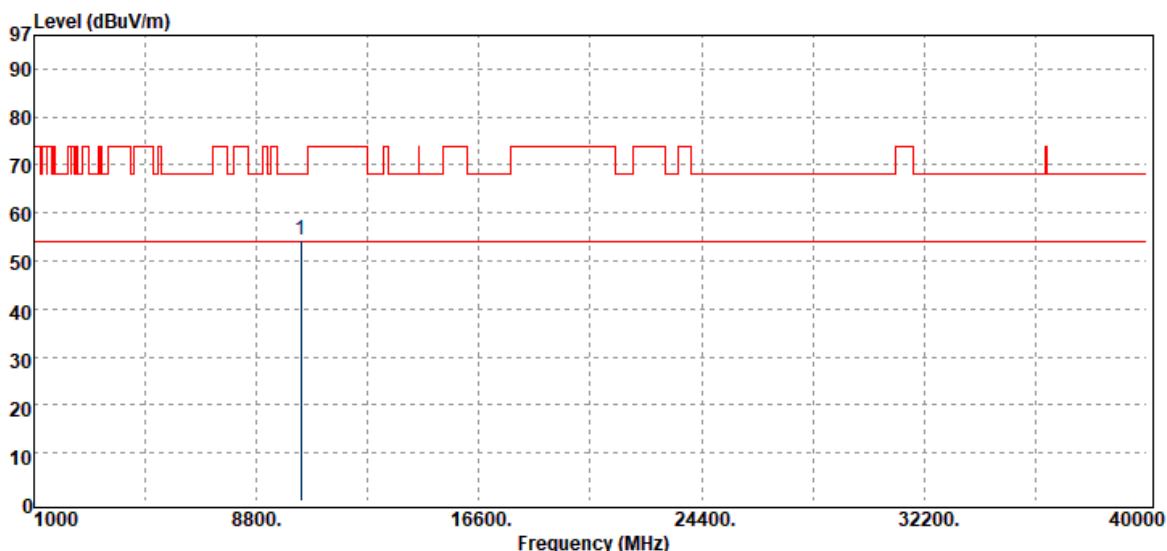

| Freq. MHz | Detector Mode PK/QP/AV | Spectrum Reading Level dB μ V | Factor dB | Actual FS dB μ V/m | Limit @3m dB μ V/m | Margin dB |
|--------------|------------------------------|---|--------------|------------------------------|------------------------------|--------------|
| 10360.00 | Peak | 34.67 | 19.87 | 54.54 | 68.20 | -13.66 |

Unless otherwise stated the results shown in this test report refer only to the sample(s) tested and such sample(s) are retained for 90 days only.

除非另有說明，此報告結果僅對測試之樣品負責，同時此樣品僅保留90天。本報告未經本公司書面許可，不可部份複製。

This document is issued by the Company subject to its General Conditions of Service printed overleaf, available on request or accessible at <http://www.sgs.com.tw/Terms-and-Conditions> and for electronic format documents, subject to Terms and Conditions for Electronic Documents at <http://www.sgs.com.tw/Terms-and-Conditions>. Attention is drawn to the limitation of liability, indemnification and jurisdiction issues defined therein. Any holder of this document is advised that information contained hereon reflects the Company's findings at the time of its intervention only and within the limits of Client's instructions, if any. The Company's sole responsibility is to its Client and this document does not exonerate parties to a transaction from exercising all their rights and obligations under the transaction documents. This document cannot be reproduced except in full, without prior written approval of the Company. Any unauthorized alteration, forgery or falsification of the content or appearance of this document is unlawful and offenders may be prosecuted to the fullest extent of the law.

Report Number :ER-2021-20085
 Operation Mode :802.11n20
 Test Frequency :5180 MHz
 Test Mode :Tx CH Low
 EUT Pol :H Plane

Test Site :SAC III Chamber
 Test Date :2021-03-16
 Temp./Humi. :22.7/63
 Antenna Pol. :HORIZONTAL
 Engineer :Ricky

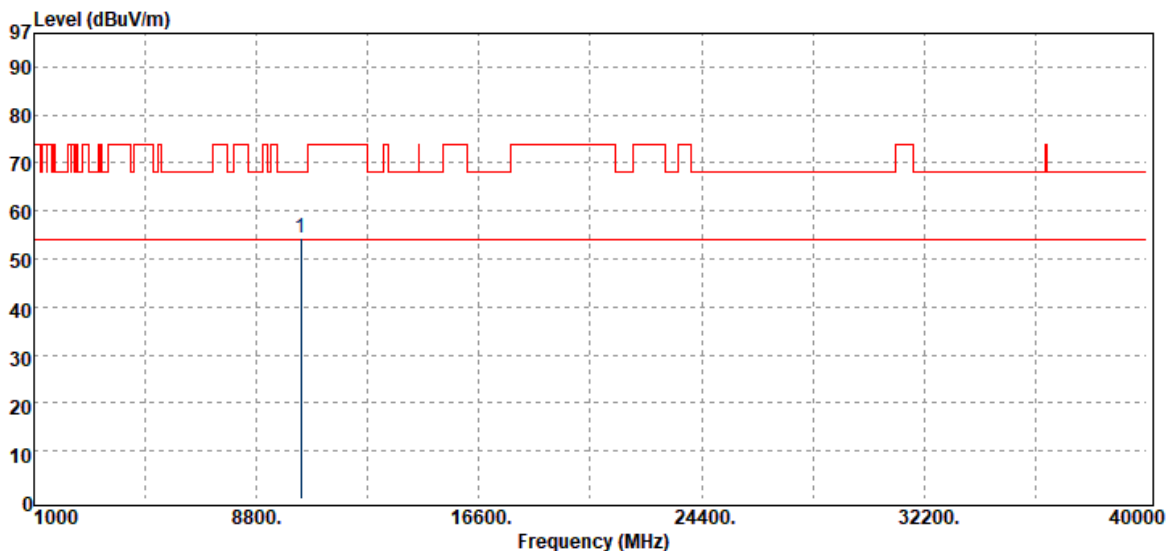

| Freq. MHz | Detector Mode PK/QP/AV | Spectrum Reading Level dB μ V | Factor dB | Actual FS dB μ V/m | Limit @3m dB μ V/m | Margin dB |
|--------------|------------------------------|---|--------------|------------------------------|------------------------------|--------------|
| 10360.00 | Peak | 34.46 | 19.87 | 54.33 | 68.20 | -13.87 |

Unless otherwise stated the results shown in this test report refer only to the sample(s) tested and such sample(s) are retained for 90 days only.

除非另有說明，此報告結果僅對測試之樣品負責，同時此樣品僅保留90天。本報告未經本公司書面許可，不可部份複製。

This document is issued by the Company subject to its General Conditions of Service printed overleaf, available on request or accessible at <http://www.sgs.com.tw/Terms-and-Conditions> and for electronic format documents, subject to Terms and Conditions for Electronic Documents at <http://www.sgs.com.tw/Terms-and-Conditions>. Attention is drawn to the limitation of liability, indemnification and jurisdiction issues defined therein. Any holder of this document is advised that information contained hereon reflects the Company's findings at the time of its intervention only and within the limits of Client's instructions, if any. The Company's sole responsibility is to its Client and this document does not exonerate parties to a transaction from exercising all their rights and obligations under the transaction documents. This document cannot be reproduced except in full, without prior written approval of the Company. Any unauthorized alteration, forgery or falsification of the content or appearance of this document is unlawful and offenders may be prosecuted to the fullest extent of the law.

Report Number :ER-2021-20085
 Operation Mode :802.11n20
 Test Frequency :5220 MHz
 Test Mode :Tx CH Mid
 EUT Pol :H Plane

Test Site :SAC III Chamber
 Test Date :2021-03-16
 Temp./Humi. :22.7/63
 Antenna Pol. :VERTICAL
 Engineer :Ricky

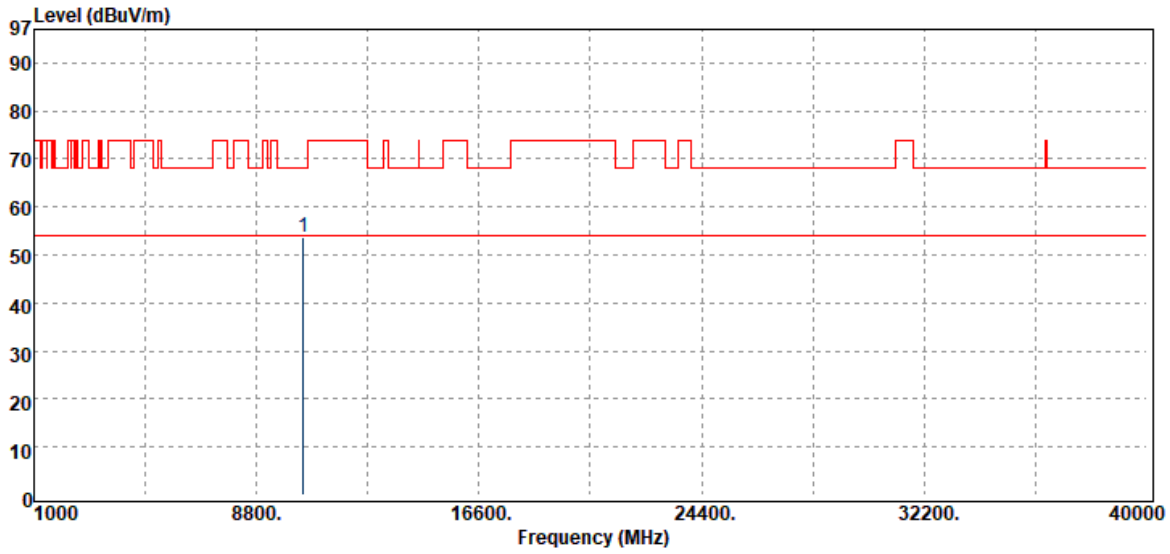

| Freq. MHz | Detector Mode PK/QP/AV | Spectrum Reading Level dB μ V | Factor dB | Actual FS dB μ V/m | Limit @3m dB μ V/m | Margin dB |
|--------------|------------------------------|---|--------------|------------------------------|------------------------------|--------------|
| 10440.00 | Peak | 34.61 | 19.15 | 53.76 | 68.20 | -14.44 |

Unless otherwise stated the results shown in this test report refer only to the sample(s) tested and such sample(s) are retained for 90 days only.

除非另有說明，此報告結果僅對測試之樣品負責，同時此樣品僅保留90天。本報告未經本公司書面許可，不可部份複製。

This document is issued by the Company subject to its General Conditions of Service printed overleaf, available on request or accessible at <http://www.sgs.com.tw/Terms-and-Conditions> and for electronic format documents, subject to Terms and Conditions for Electronic Documents at <http://www.sgs.com.tw/Terms-and-Conditions>. Attention is drawn to the limitation of liability, indemnification and jurisdiction issues defined therein. Any holder of this document is advised that information contained hereon reflects the Company's findings at the time of its intervention only and within the limits of Client's instructions, if any. The Company's sole responsibility is to its Client and this document does not exonerate parties to a transaction from exercising all their rights and obligations under the transaction documents. This document cannot be reproduced except in full, without prior written approval of the Company. Any unauthorized alteration, forgery or falsification of the content or appearance of this document is unlawful and offenders may be prosecuted to the fullest extent of the law.

Report Number :ER-2021-20085
 Operation Mode :802.11n20
 Test Frequency :5220 MHz
 Test Mode :Tx CH Mid
 EUT Pol :H Plane

Test Site :SAC III Chamber
 Test Date :2021-03-16
 Temp./Humi. :22.7/63
 Antenna Pol. :HORIZONTAL
 Engineer :Ricky



| Freq. MHz | Detector Mode PK/QP/AV | Spectrum Reading Level dB μ V | Factor dB | Actual FS dB μ V/m | Limit @3m dB μ V/m | Margin dB |
|--------------|------------------------------|---|--------------|------------------------------|------------------------------|--------------|
| 10440.00 | Peak | 34.07 | 19.15 | 53.22 | 68.20 | -14.98 |

Unless otherwise stated the results shown in this test report refer only to the sample(s) tested and such sample(s) are retained for 90 days only.

除非另有說明，此報告結果僅對測試之樣品負責，同時此樣品僅保留90天。本報告未經本公司書面許可，不可部份複製。

This document is issued by the Company subject to its General Conditions of Service printed overleaf, available on request or accessible at <http://www.sgs.com.tw/Terms-and-Conditions> and for electronic format documents, subject to Terms and Conditions for Electronic Documents at <http://www.sgs.com.tw/Terms-and-Conditions>. Attention is drawn to the limitation of liability, indemnification and jurisdiction issues defined therein. Any holder of this document is advised that information contained hereon reflects the Company's findings at the time of its intervention only and within the limits of Client's instructions, if any. The Company's sole responsibility is to its Client and this document does not exonerate parties to a transaction from exercising all their rights and obligations under the transaction documents. This document cannot be reproduced except in full, without prior written approval of the Company. Any unauthorized alteration, forgery or falsification of the content or appearance of this document is unlawful and offenders may be prosecuted to the fullest extent of the law.

Report Number :ER-2021-20085
 Operation Mode :802.11n20
 Test Frequency :5240 MHz
 Test Mode :Tx CH High
 EUT Pol :H Plane

Test Site :SAC III Chamber
 Test Date :2021-03-16
 Temp./Humi. :22.7/63
 Antenna Pol. :VERTICAL
 Engineer :Ricky

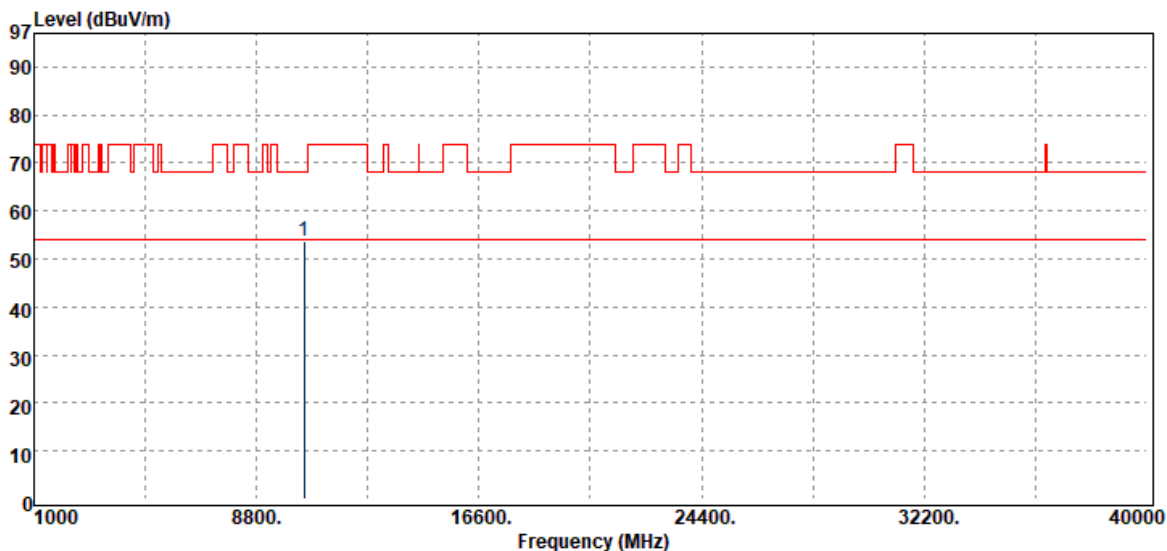

| Freq. MHz | Detector Mode PK/QP/AV | Spectrum Reading Level dB μ V | Factor dB | Actual FS dB μ V/m | Limit @3m dB μ V/m | Margin dB |
|--------------|------------------------------|---|--------------|------------------------------|------------------------------|--------------|
| 10480.00 | Peak | 34.25 | 19.56 | 53.81 | 68.20 | -14.39 |

Unless otherwise stated the results shown in this test report refer only to the sample(s) tested and such sample(s) are retained for 90 days only.

除非另有說明，此報告結果僅對測試之樣品負責，同時此樣品僅保留90天。本報告未經本公司書面許可，不可部份複製。

This document is issued by the Company subject to its General Conditions of Service printed overleaf, available on request or accessible at <http://www.sgs.com.tw/Terms-and-Conditions> and for electronic format documents, subject to Terms and Conditions for Electronic Documents at <http://www.sgs.com.tw/Terms-and-Conditions>. Attention is drawn to the limitation of liability, indemnification and jurisdiction issues defined therein. Any holder of this document is advised that information contained hereon reflects the Company's findings at the time of its intervention only and within the limits of Client's instructions, if any. The Company's sole responsibility is to its Client and this document does not exonerate parties to a transaction from exercising all their rights and obligations under the transaction documents. This document cannot be reproduced except in full, without prior written approval of the Company. Any unauthorized alteration, forgery or falsification of the content or appearance of this document is unlawful and offenders may be prosecuted to the fullest extent of the law.

Report Number :ER-2021-20085
 Operation Mode :802.11n20
 Test Frequency :5240 MHz
 Test Mode :Tx CH High
 EUT Pol :H Plane

Test Site :SAC III Chamber
 Test Date :2021-03-16
 Temp./Humi. :22.7/63
 Antenna Pol. :HORIZONTAL
 Engineer :Ricky

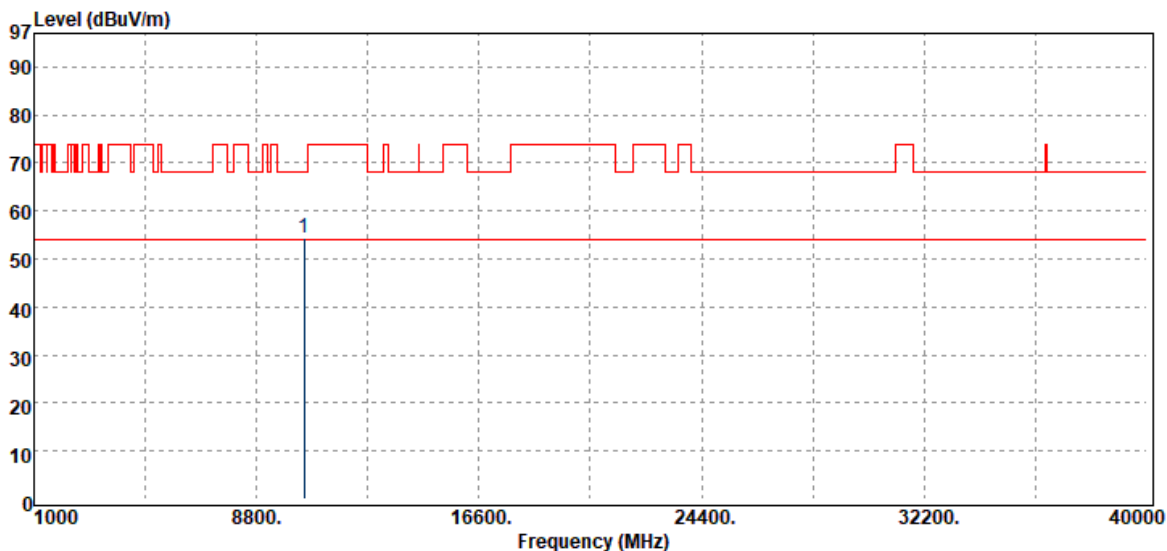

| Freq. MHz | Detector Mode PK/QP/AV | Spectrum Reading Level dB μ V | Factor dB | Actual FS dB μ V/m | Limit @3m dB μ V/m | Margin dB |
|--------------|------------------------------|---|--------------|------------------------------|------------------------------|--------------|
| 10480.00 | Peak | 34.86 | 19.56 | 54.42 | 68.20 | -13.78 |

Unless otherwise stated the results shown in this test report refer only to the sample(s) tested and such sample(s) are retained for 90 days only.

除非另有說明，此報告結果僅對測試之樣品負責，同時此樣品僅保留90天。本報告未經本公司書面許可，不可部份複製。

This document is issued by the Company subject to its General Conditions of Service printed overleaf, available on request or accessible at <http://www.sgs.com.tw/Terms-and-Conditions> and for electronic format documents, subject to Terms and Conditions for Electronic Documents at <http://www.sgs.com.tw/Terms-and-Conditions>. Attention is drawn to the limitation of liability, indemnification and jurisdiction issues defined therein. Any holder of this document is advised that information contained hereon reflects the Company's findings at the time of its intervention only and within the limits of Client's instructions, if any. The Company's sole responsibility is to its Client and this document does not exonerate parties to a transaction from exercising all their rights and obligations under the transaction documents. This document cannot be reproduced except in full, without prior written approval of the Company. Any unauthorized alteration, forgery or falsification of the content or appearance of this document is unlawful and offenders may be prosecuted to the fullest extent of the law.

Report Number :ER-2021-20085
 Operation Mode :802.11n20
 Test Frequency :5260 MHz
 Test Mode :Tx CH Low
 EUT Pol :H Plane

Test Site :SAC III Chamber
 Test Date :2021-03-16
 Temp./Humi. :22.7/63
 Antenna Pol. :VERTICAL
 Engineer :Ricky

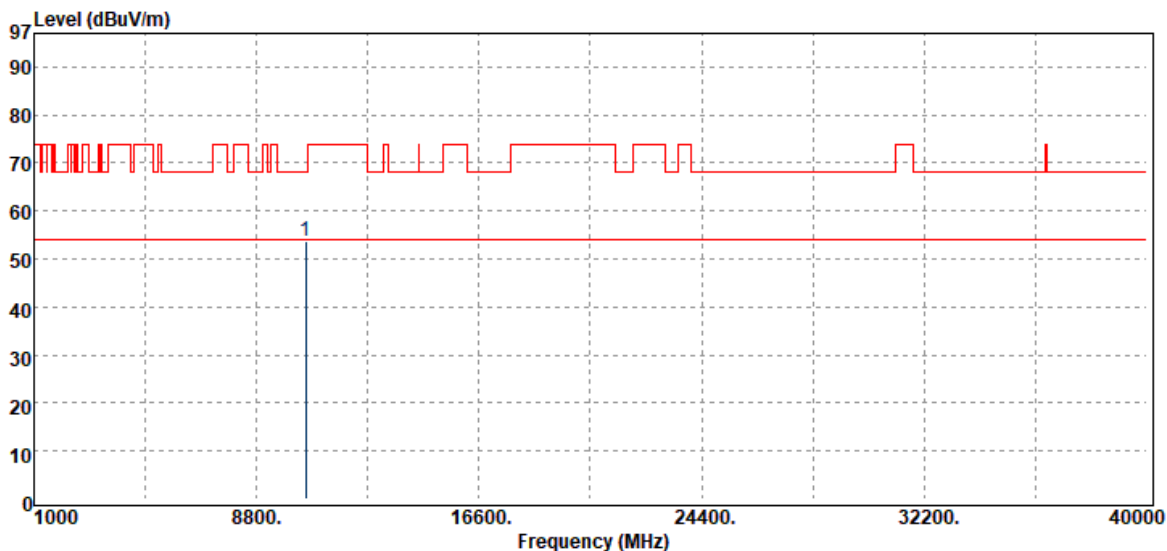

| Freq. MHz | Detector Mode PK/QP/AV | Spectrum Reading Level dB μ V | Factor dB | Actual FS dB μ V/m | Limit @3m dB μ V/m | Margin dB |
|--------------|------------------------------|---|--------------|------------------------------|------------------------------|--------------|
| 10520.00 | Peak | 33.98 | 19.84 | 53.82 | 68.20 | -14.38 |

Unless otherwise stated the results shown in this test report refer only to the sample(s) tested and such sample(s) are retained for 90 days only.

除非另有說明，此報告結果僅對測試之樣品負責，同時此樣品僅保留90天。本報告未經本公司書面許可，不可部份複製。

This document is issued by the Company subject to its General Conditions of Service printed overleaf, available on request or accessible at <http://www.sgs.com.tw/Terms-and-Conditions> and for electronic format documents, subject to Terms and Conditions for Electronic Documents at <http://www.sgs.com.tw/Terms-and-Conditions>. Attention is drawn to the limitation of liability, indemnification and jurisdiction issues defined therein. Any holder of this document is advised that information contained hereon reflects the Company's findings at the time of its intervention only and within the limits of Client's instructions, if any. The Company's sole responsibility is to its Client and this document does not exonerate parties to a transaction from exercising all their rights and obligations under the transaction documents. This document cannot be reproduced except in full, without prior written approval of the Company. Any unauthorized alteration, forgery or falsification of the content or appearance of this document is unlawful and offenders may be prosecuted to the fullest extent of the law.

Report Number :ER-2021-20085
 Operation Mode :802.11n20
 Test Frequency :5260 MHz
 Test Mode :Tx CH Low
 EUT Pol :H Plane

Test Site :SAC III Chamber
 Test Date :2021-03-16
 Temp./Humi. :22.7/63
 Antenna Pol. :HORIZONTAL
 Engineer :Ricky

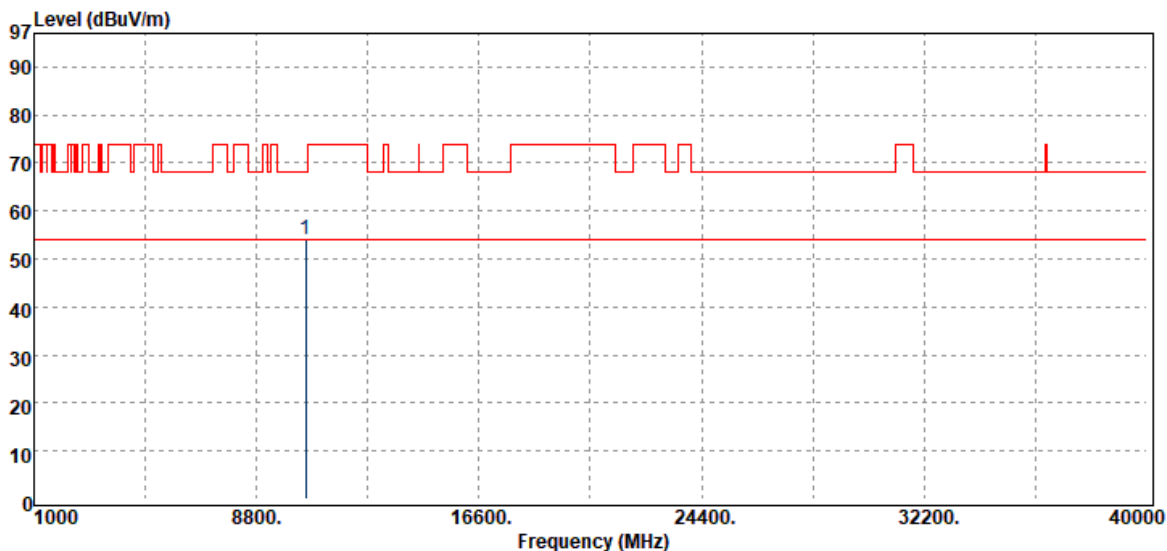

| Freq. MHz | Detector Mode PK/QP/AV | Spectrum Reading Level dB μ V | Factor dB | Actual FS dB μ V/m | Limit @3m dB μ V/m | Margin dB |
|--------------|------------------------------|---|--------------|------------------------------|------------------------------|--------------|
| 10520.00 | Peak | 34.22 | 19.84 | 54.06 | 68.20 | -14.14 |

Unless otherwise stated the results shown in this test report refer only to the sample(s) tested and such sample(s) are retained for 90 days only.

除非另有說明，此報告結果僅對測試之樣品負責，同時此樣品僅保留90天。本報告未經本公司書面許可，不可部份複製。

This document is issued by the Company subject to its General Conditions of Service printed overleaf, available on request or accessible at <http://www.sgs.com.tw/Terms-and-Conditions> and for electronic format documents, subject to Terms and Conditions for Electronic Documents at <http://www.sgs.com.tw/Terms-and-Conditions>. Attention is drawn to the limitation of liability, indemnification and jurisdiction issues defined therein. Any holder of this document is advised that information contained hereon reflects the Company's findings at the time of its intervention only and within the limits of Client's instructions, if any. The Company's sole responsibility is to its Client and this document does not exonerate parties to a transaction from exercising all their rights and obligations under the transaction documents. This document cannot be reproduced except in full, without prior written approval of the Company. Any unauthorized alteration, forgery or falsification of the content or appearance of this document is unlawful and offenders may be prosecuted to the fullest extent of the law.

Report Number :ER-2021-20085
 Operation Mode :802.11n20
 Test Frequency :5300 MHz
 Test Mode :Tx CH Mid
 EUT Pol :H Plane

Test Site :SAC III Chamber
 Test Date :2021-03-16
 Temp./Humi. :22.7/63
 Antenna Pol. :VERTICAL
 Engineer :Ricky

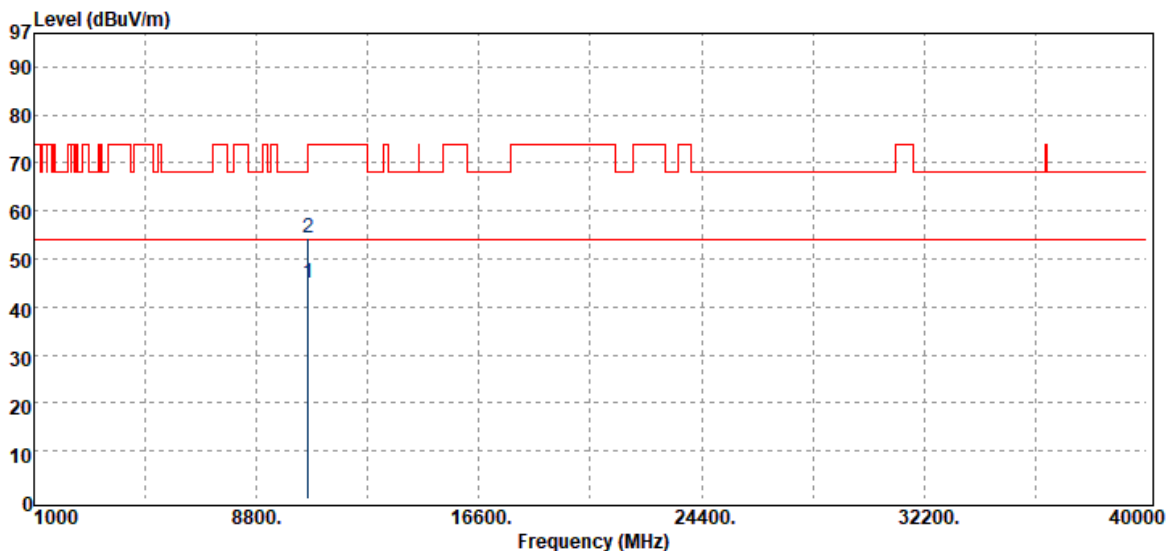

| Freq. MHz | Detector Mode PK/QP/AV | Spectrum Reading Level dB μ V | Factor dB | Actual FS dB μ V/m | Limit @3m dB μ V/m | Margin dB |
|--------------|------------------------------|---|--------------|------------------------------|------------------------------|--------------|
| 10600.00 | Average | 25.11 | 19.86 | 44.97 | 54.00 | -9.03 |
| 10600.00 | Peak | 34.46 | 19.86 | 54.32 | 74.00 | -19.68 |

Unless otherwise stated the results shown in this test report refer only to the sample(s) tested and such sample(s) are retained for 90 days only.

除非另有說明，此報告結果僅對測試之樣品負責，同時此樣品僅保留90天。本報告未經本公司書面許可，不可部份複製。

This document is issued by the Company subject to its General Conditions of Service printed overleaf, available on request or accessible at <http://www.sgs.com.tw/Terms-and-Conditions> and for electronic format documents, subject to Terms and Conditions for Electronic Documents at <http://www.sgs.com.tw/Terms-and-Conditions>. Attention is drawn to the limitation of liability, indemnification and jurisdiction issues defined therein. Any holder of this document is advised that information contained hereon reflects the Company's findings at the time of its intervention only and within the limits of Client's instructions, if any. The Company's sole responsibility is to its Client and this document does not exonerate parties to a transaction from exercising all their rights and obligations under the transaction documents. This document cannot be reproduced except in full, without prior written approval of the Company. Any unauthorized alteration, forgery or falsification of the content or appearance of this document is unlawful and offenders may be prosecuted to the fullest extent of the law.

Report Number :ER-2021-20085
 Operation Mode :802.11n20
 Test Frequency :5300 MHz
 Test Mode :Tx CH Mid
 EUT Pol :H Plane

Test Site :SAC III Chamber
 Test Date :2021-03-16
 Temp./Humi. :22.7/63
 Antenna Pol. :HORIZONTAL
 Engineer :Ricky

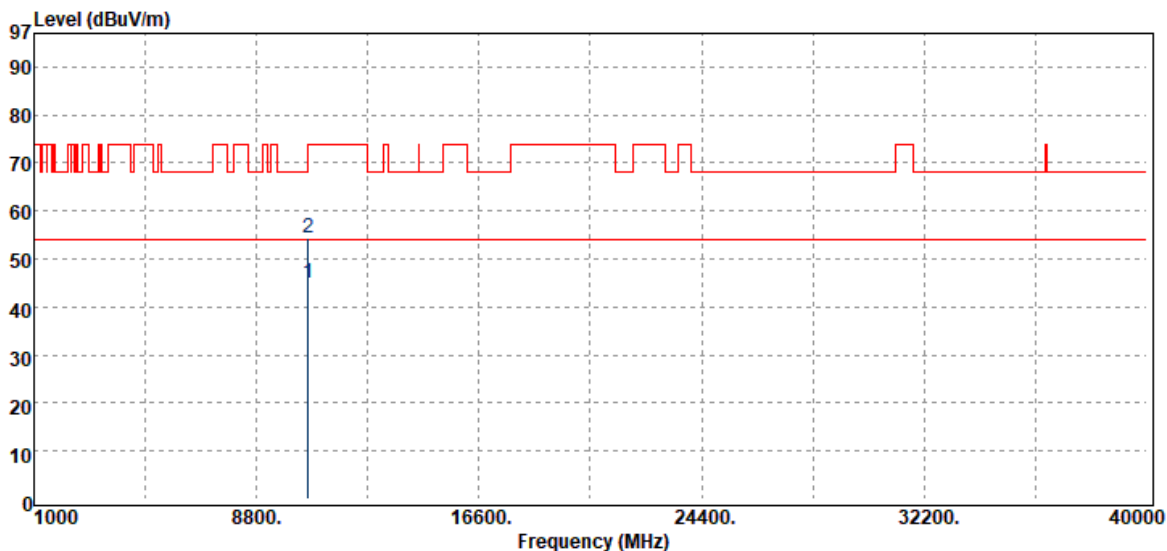

| Freq. MHz | Detector Mode PK/QP/AV | Spectrum Reading Level dB μ V | Factor dB | Actual FS dB μ V/m | Limit @3m dB μ V/m | Margin dB |
|--------------|------------------------------|---|--------------|------------------------------|------------------------------|--------------|
| 10600.00 | Average | 25.16 | 19.86 | 45.02 | 54.00 | -8.98 |
| 10600.00 | Peak | 34.58 | 19.86 | 54.44 | 74.00 | -19.56 |

Unless otherwise stated the results shown in this test report refer only to the sample(s) tested and such sample(s) are retained for 90 days only.

除非另有說明，此報告結果僅對測試之樣品負責，同時此樣品僅保留90天。本報告未經本公司書面許可，不可部份複製。

This document is issued by the Company subject to its General Conditions of Service printed overleaf, available on request or accessible at <http://www.sgs.com.tw/Terms-and-Conditions> and for electronic format documents, subject to Terms and Conditions for Electronic Documents at <http://www.sgs.com.tw/Terms-and-Conditions>. Attention is drawn to the limitation of liability, indemnification and jurisdiction issues defined therein. Any holder of this document is advised that information contained hereon reflects the Company's findings at the time of its intervention only and within the limits of Client's instructions, if any. The Company's sole responsibility is to its Client and this document does not exonerate parties to a transaction from exercising all their rights and obligations under the transaction documents. This document cannot be reproduced except in full, without prior written approval of the Company. Any unauthorized alteration, forgery or falsification of the content or appearance of this document is unlawful and offenders may be prosecuted to the fullest extent of the law.

Report Number :ER-2021-20085
 Operation Mode :802.11n20
 Test Frequency :5320 MHz
 Test Mode :Tx CH High
 EUT Pol :H Plane

Test Site :SAC III Chamber
 Test Date :2021-03-16
 Temp./Humi. :22.7/63
 Antenna Pol. :VERTICAL
 Engineer :Ricky

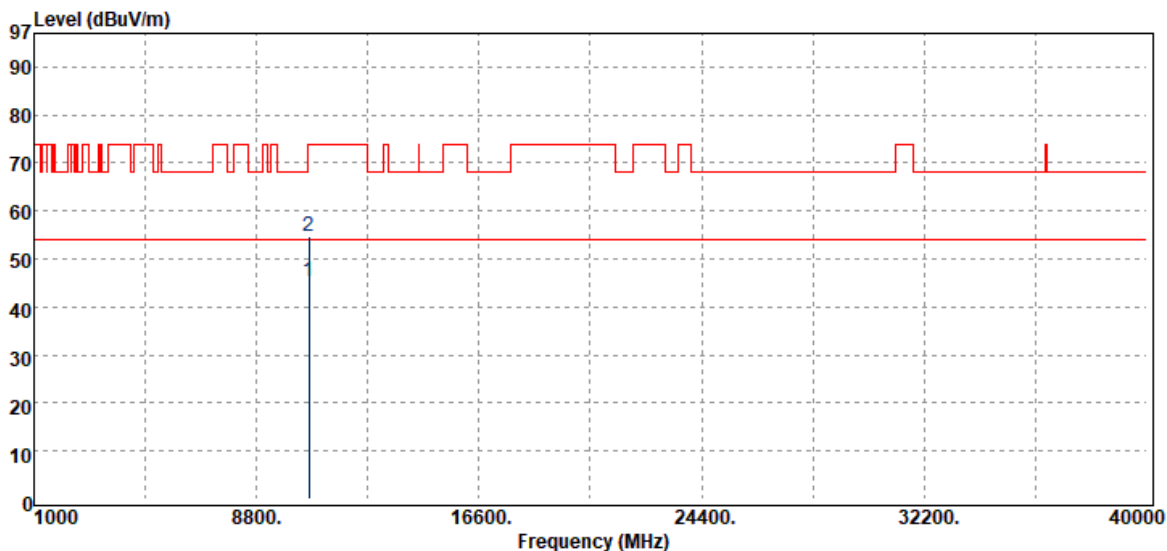

| Freq. MHz | Detector Mode PK/QP/AV | Spectrum Reading Level dBμV | Factor dB | Actual FS dBμV/m | Limit @3m dBμV/m | Margin dB |
|--------------|------------------------------|-----------------------------------|--------------|------------------------|------------------------|--------------|
| 10640.00 | Average | 25.09 | 20.37 | 45.46 | 54.00 | -8.54 |
| 10640.00 | Peak | 34.21 | 20.37 | 54.58 | 74.00 | -19.42 |

Unless otherwise stated the results shown in this test report refer only to the sample(s) tested and such sample(s) are retained for 90 days only.

除非另有說明，此報告結果僅對測試之樣品負責，同時此樣品僅保留90天。本報告未經本公司書面許可，不可部份複製。

This document is issued by the Company subject to its General Conditions of Service printed overleaf, available on request or accessible at <http://www.sgs.com.tw/Terms-and-Conditions> and for electronic format documents, subject to Terms and Conditions for Electronic Documents at <http://www.sgs.com.tw/Terms-and-Conditions>. Attention is drawn to the limitation of liability, indemnification and jurisdiction issues defined therein. Any holder of this document is advised that information contained hereon reflects the Company's findings at the time of its intervention only and within the limits of Client's instructions, if any. The Company's sole responsibility is to its Client and this document does not exonerate parties to a transaction from exercising all their rights and obligations under the transaction documents. This document cannot be reproduced except in full, without prior written approval of the Company. Any unauthorized alteration, forgery or falsification of the content or appearance of this document is unlawful and offenders may be prosecuted to the fullest extent of the law.

Report Number :ER-2021-20085
 Operation Mode :802.11n20
 Test Frequency :5320 MHz
 Test Mode :Tx CH High
 EUT Pol :H Plane

Test Site :SAC III Chamber
 Test Date :2021-03-16
 Temp./Humi. :22.7/63
 Antenna Pol. :HORIZONTAL
 Engineer :Ricky

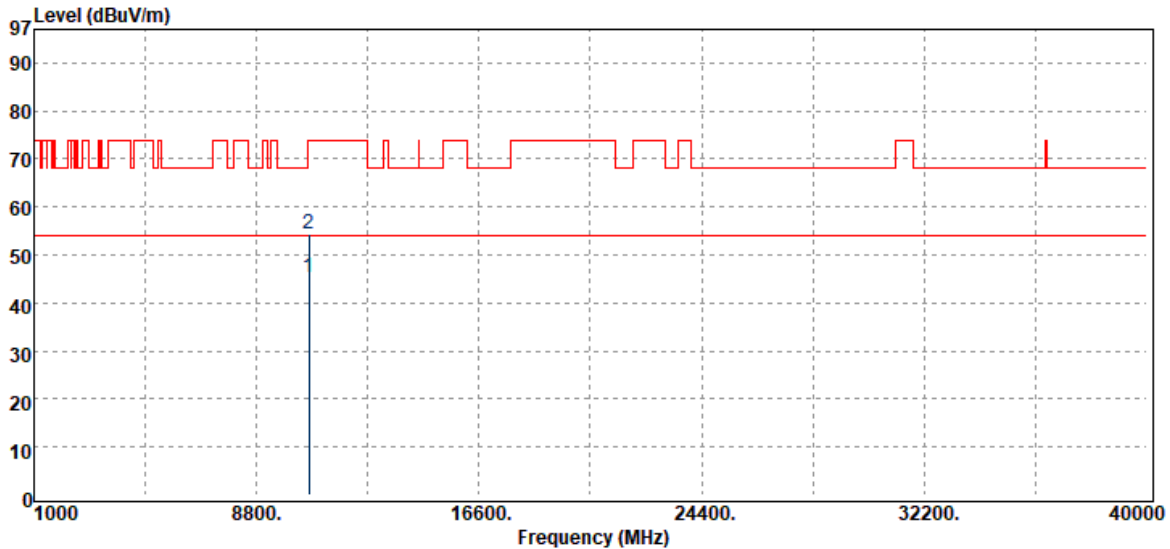

| Freq. MHz | Detector Mode PK/QP/AV | Spectrum Reading Level dB μ V | Factor dB | Actual FS dB μ V/m | Limit @3m dB μ V/m | Margin dB |
|--------------|------------------------------|---|--------------|------------------------------|------------------------------|--------------|
| 10640.00 | Average | 25.08 | 20.37 | 45.45 | 54.00 | -8.55 |
| 10640.00 | Peak | 34.13 | 20.37 | 54.50 | 74.00 | -19.50 |

Unless otherwise stated the results shown in this test report refer only to the sample(s) tested and such sample(s) are retained for 90 days only.

除非另有說明，此報告結果僅對測試之樣品負責，同時此樣品僅保留90天。本報告未經本公司書面許可，不可部份複製。

This document is issued by the Company subject to its General Conditions of Service printed overleaf, available on request or accessible at <http://www.sgs.com.tw/Terms-and-Conditions> and for electronic format documents, subject to Terms and Conditions for Electronic Documents at <http://www.sgs.com.tw/Terms-and-Conditions>. Attention is drawn to the limitation of liability, indemnification and jurisdiction issues defined therein. Any holder of this document is advised that information contained hereon reflects the Company's findings at the time of its intervention only and within the limits of Client's instructions, if any. The Company's sole responsibility is to its Client and this document does not exonerate parties to a transaction from exercising all their rights and obligations under the transaction documents. This document cannot be reproduced except in full, without prior written approval of the Company. Any unauthorized alteration, forgery or falsification of the content or appearance of this document is unlawful and offenders may be prosecuted to the fullest extent of the law.

Report Number :ER-2021-20085
 Operation Mode :802.11n20
 Test Frequency :5500 MHz
 Test Mode :Tx CH Low
 EUT Pol :H Plane

Test Site :SAC III Chamber
 Test Date :2021-03-16
 Temp./Humi. :22.7/63
 Antenna Pol. :VERTICAL
 Engineer :Ricky

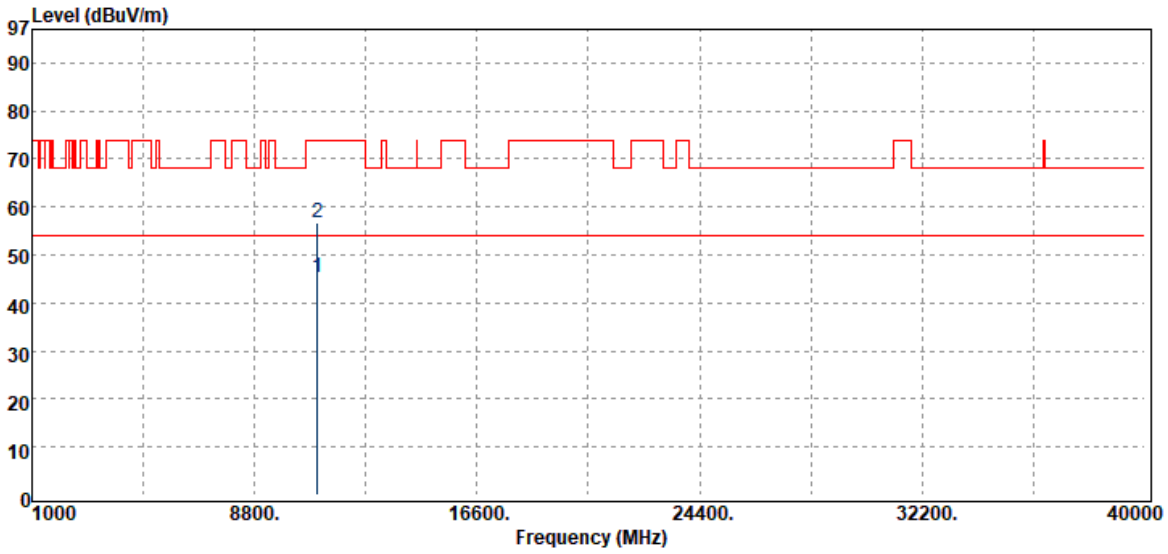

| Freq. MHz | Detector Mode PK/QP/AV | Spectrum Reading Level dB μ V | Factor dB | Actual FS dB μ V/m | Limit @3m dB μ V/m | Margin dB |
|--------------|------------------------------|---|--------------|------------------------------|------------------------------|--------------|
| 11000.00 | Average | 24.55 | 20.90 | 45.45 | 54.00 | -8.55 |
| 11000.00 | Peak | 35.75 | 20.90 | 56.65 | 74.00 | -17.35 |

Unless otherwise stated the results shown in this test report refer only to the sample(s) tested and such sample(s) are retained for 90 days only.

除非另有說明，此報告結果僅對測試之樣品負責，同時此樣品僅保留90天。本報告未經本公司書面許可，不可部份複製。

This document is issued by the Company subject to its General Conditions of Service printed overleaf, available on request or accessible at <http://www.sgs.com.tw/Terms-and-Conditions> and for electronic format documents, subject to Terms and Conditions for Electronic Documents at <http://www.sgs.com.tw/Terms-and-Conditions>. Attention is drawn to the limitation of liability, indemnification and jurisdiction issues defined therein. Any holder of this document is advised that information contained hereon reflects the Company's findings at the time of its intervention only and within the limits of Client's instructions, if any. The Company's sole responsibility is to its Client and this document does not exonerate parties to a transaction from exercising all their rights and obligations under the transaction documents. This document cannot be reproduced except in full, without prior written approval of the Company. Any unauthorized alteration, forgery or falsification of the content or appearance of this document is unlawful and offenders may be prosecuted to the fullest extent of the law.

Report Number :ER-2021-20085
 Operation Mode :802.11n20
 Test Frequency :5500 MHz
 Test Mode :Tx CH Low
 EUT Pol :H Plane

Test Site :SAC III Chamber
 Test Date :2021-03-16
 Temp./Humi. :22.7/63
 Antenna Pol. :HORIZONTAL
 Engineer :Ricky

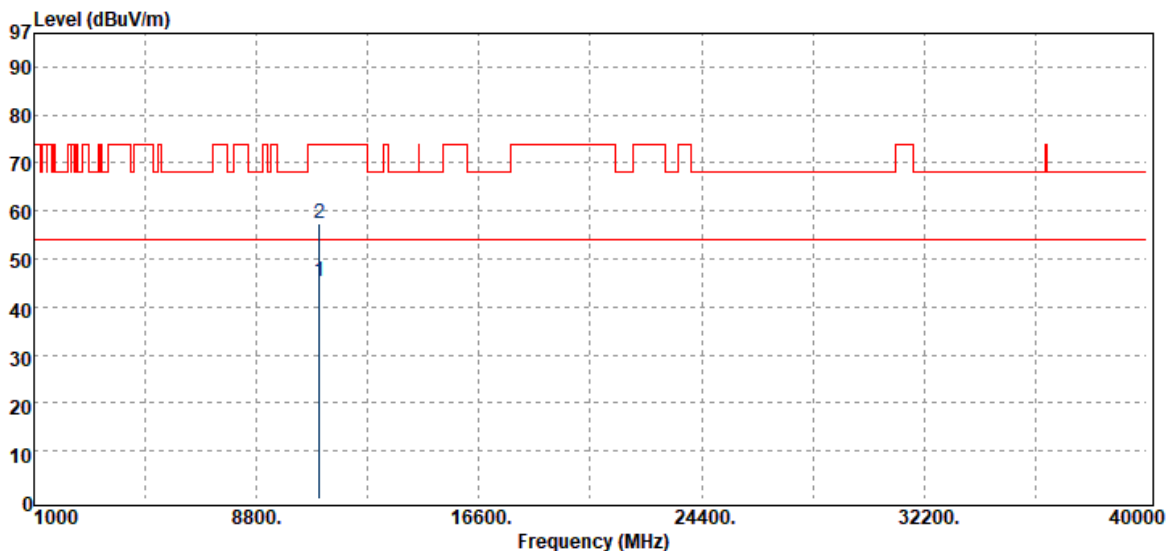

| Freq. MHz | Detector Mode PK/QP/AV | Spectrum Reading Level dB μ V | Factor dB | Actual FS dB μ V/m | Limit @3m dB μ V/m | Margin dB |
|--------------|------------------------------|---|--------------|------------------------------|------------------------------|--------------|
| 11000.00 | Average | 24.52 | 20.90 | 45.42 | 54.00 | -8.58 |
| 11000.00 | Peak | 36.35 | 20.90 | 57.25 | 74.00 | -16.75 |

Unless otherwise stated the results shown in this test report refer only to the sample(s) tested and such sample(s) are retained for 90 days only.

除非另有說明，此報告結果僅對測試之樣品負責，同時此樣品僅保留90天。本報告未經本公司書面許可，不可部份複製。

This document is issued by the Company subject to its General Conditions of Service printed overleaf, available on request or accessible at <http://www.sgs.com.tw/Terms-and-Conditions> and for electronic format documents, subject to Terms and Conditions for Electronic Documents at <http://www.sgs.com.tw/Terms-and-Conditions>. Attention is drawn to the limitation of liability, indemnification and jurisdiction issues defined therein. Any holder of this document is advised that information contained hereon reflects the Company's findings at the time of its intervention only and within the limits of Client's instructions, if any. The Company's sole responsibility is to its Client and this document does not exonerate parties to a transaction from exercising all their rights and obligations under the transaction documents. This document cannot be reproduced except in full, without prior written approval of the Company. Any unauthorized alteration, forgery or falsification of the content or appearance of this document is unlawful and offenders may be prosecuted to the fullest extent of the law.

Report Number :ER-2021-20085
 Operation Mode :802.11n20
 Test Frequency :5580 MHz
 Test Mode :Tx CH Mid
 EUT Pol :H Plane

Test Site :SAC III Chamber
 Test Date :2021-03-16
 Temp./Humi. :22.7/63
 Antenna Pol. :VERTICAL
 Engineer :Ricky

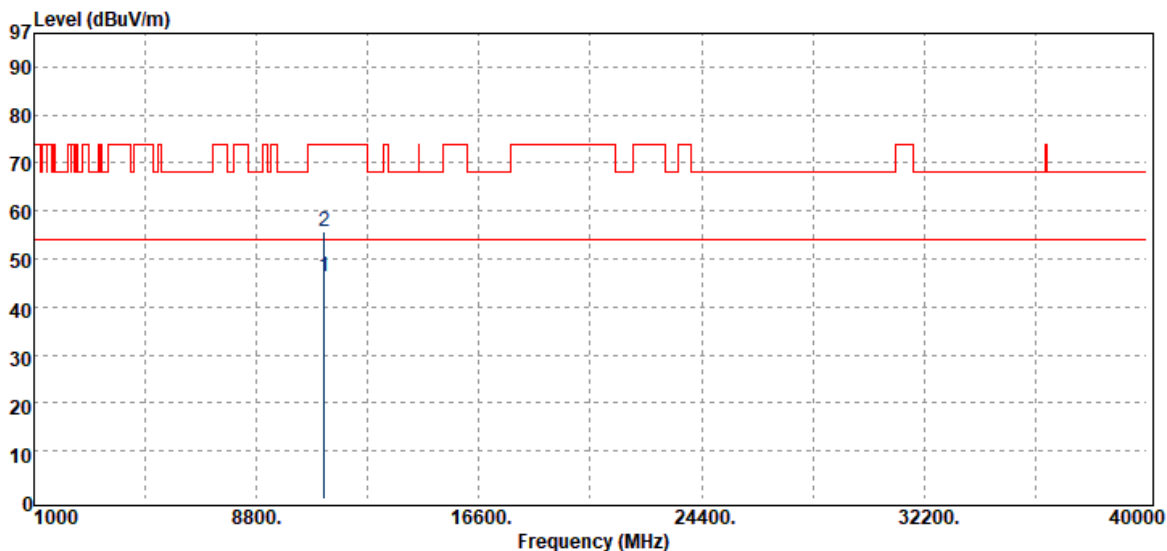

| Freq. MHz | Detector Mode PK/QP/AV | Spectrum Reading Level dB μ V | Factor dB | Actual FS dB μ V/m | Limit @3m dB μ V/m | Margin dB |
|--------------|------------------------------|---|--------------|------------------------------|------------------------------|--------------|
| 11160.00 | Average | 24.76 | 21.60 | 46.36 | 54.00 | -7.64 |
| 11160.00 | Peak | 34.11 | 21.60 | 55.71 | 74.00 | -18.29 |

Unless otherwise stated the results shown in this test report refer only to the sample(s) tested and such sample(s) are retained for 90 days only.

除非另有說明，此報告結果僅對測試之樣品負責，同時此樣品僅保留90天。本報告未經本公司書面許可，不可部份複製。

This document is issued by the Company subject to its General Conditions of Service printed overleaf, available on request or accessible at <http://www.sgs.com.tw/Terms-and-Conditions> and for electronic format documents, subject to Terms and Conditions for Electronic Documents at <http://www.sgs.com.tw/Terms-and-Conditions>. Attention is drawn to the limitation of liability, indemnification and jurisdiction issues defined therein. Any holder of this document is advised that information contained hereon reflects the Company's findings at the time of its intervention only and within the limits of Client's instructions, if any. The Company's sole responsibility is to its Client and this document does not exonerate parties to a transaction from exercising all their rights and obligations under the transaction documents. This document cannot be reproduced except in full, without prior written approval of the Company. Any unauthorized alteration, forgery or falsification of the content or appearance of this document is unlawful and offenders may be prosecuted to the fullest extent of the law.

Report Number :ER-2021-20085
 Operation Mode :802.11n20
 Test Frequency :5580 MHz
 Test Mode :Tx CH Mid
 EUT Pol :H Plane

Test Site :SAC III Chamber
 Test Date :2021-03-16
 Temp./Humi. :22.7/63
 Antenna Pol. :HORIZONTAL
 Engineer :Ricky

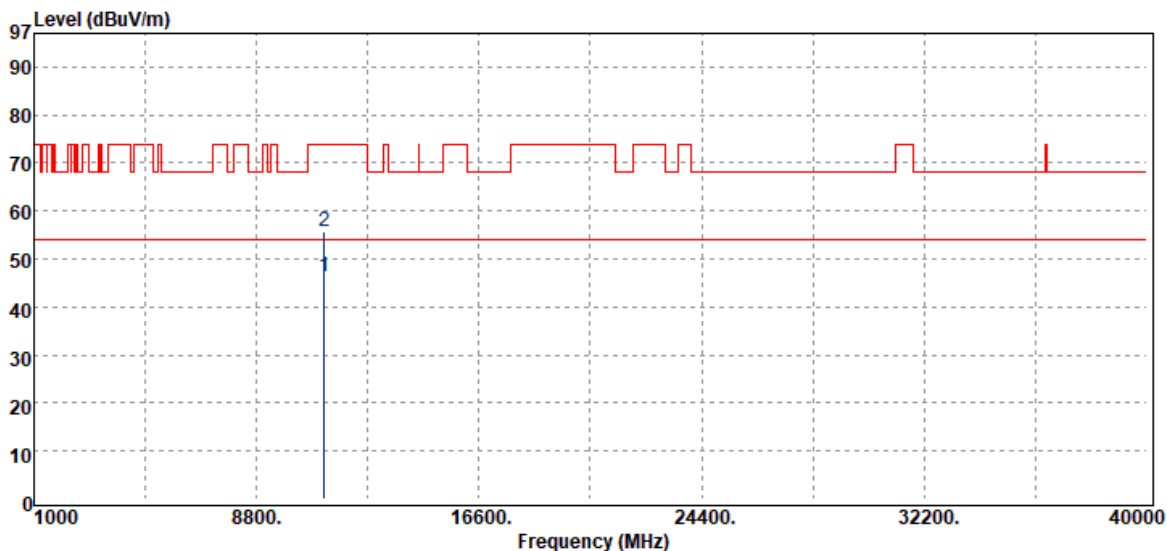

| Freq. MHz | Detector Mode PK/QP/AV | Spectrum Reading Level dB μ V | Factor dB | Actual FS dB μ V/m | Limit @3m dB μ V/m | Margin dB |
|--------------|------------------------------|---|--------------|------------------------------|------------------------------|--------------|
| 11160.00 | Average | 24.81 | 21.60 | 46.41 | 54.00 | -7.59 |
| 11160.00 | Peak | 34.10 | 21.60 | 55.70 | 74.00 | -18.30 |

Unless otherwise stated the results shown in this test report refer only to the sample(s) tested and such sample(s) are retained for 90 days only.

除非另有說明，此報告結果僅對測試之樣品負責，同時此樣品僅保留90天。本報告未經本公司書面許可，不可部份複製。

This document is issued by the Company subject to its General Conditions of Service printed overleaf, available on request or accessible at <http://www.sgs.com.tw/Terms-and-Conditions> and for electronic format documents, subject to Terms and Conditions for Electronic Documents at <http://www.sgs.com.tw/Terms-and-Conditions>. Attention is drawn to the limitation of liability, indemnification and jurisdiction issues defined therein. Any holder of this document is advised that information contained hereon reflects the Company's findings at the time of its intervention only and within the limits of Client's instructions, if any. The Company's sole responsibility is to its Client and this document does not exonerate parties to a transaction from exercising all their rights and obligations under the transaction documents. This document cannot be reproduced except in full, without prior written approval of the Company. Any unauthorized alteration, forgery or falsification of the content or appearance of this document is unlawful and offenders may be prosecuted to the fullest extent of the law.

Report Number :ER-2021-20085
 Operation Mode :802.11n20
 Test Frequency :5700 MHz
 Test Mode :Tx CH High
 EUT Pol :H Plane

Test Site :SAC III Chamber
 Test Date :2021-03-16
 Temp./Humi. :22.7/63
 Antenna Pol. :VERTICAL
 Engineer :Ricky

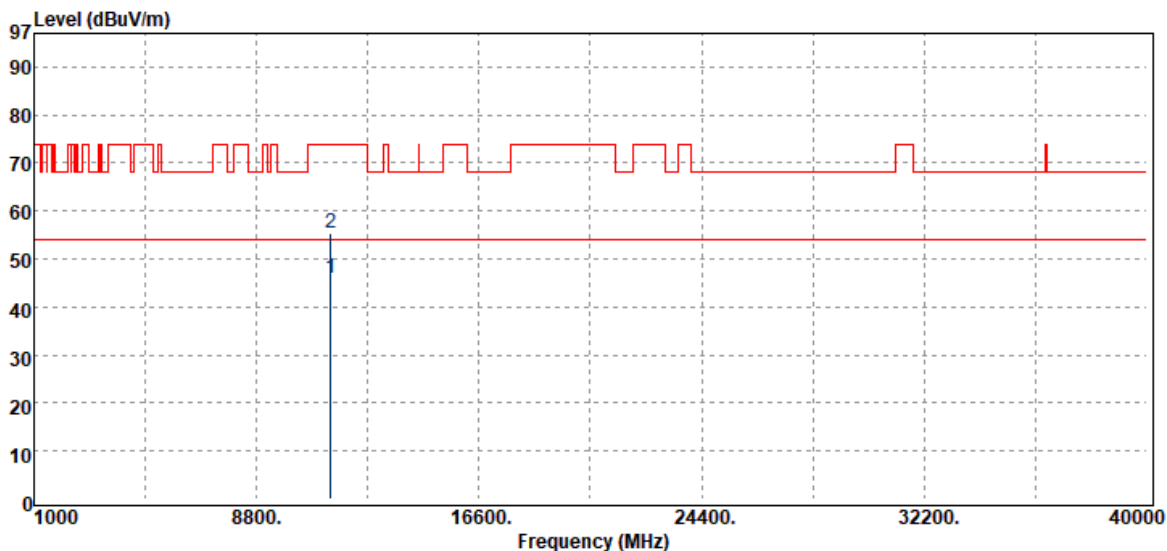

| Freq. MHz | Detector Mode PK/QP/AV | Spectrum Reading Level dB μ V | Factor dB | Actual FS dB μ V/m | Limit @3m dB μ V/m | Margin dB |
|--------------|------------------------------|---|--------------|------------------------------|------------------------------|--------------|
| 11400.00 | Average | 24.56 | 21.51 | 46.07 | 54.00 | -7.93 |
| 11400.00 | Peak | 33.93 | 21.51 | 55.44 | 74.00 | -18.56 |

Unless otherwise stated the results shown in this test report refer only to the sample(s) tested and such sample(s) are retained for 90 days only.

除非另有說明，此報告結果僅對測試之樣品負責，同時此樣品僅保留90天。本報告未經本公司書面許可，不可部份複製。

This document is issued by the Company subject to its General Conditions of Service printed overleaf, available on request or accessible at <http://www.sgs.com.tw/Terms-and-Conditions> and for electronic format documents, subject to Terms and Conditions for Electronic Documents at <http://www.sgs.com.tw/Terms-and-Conditions>. Attention is drawn to the limitation of liability, indemnification and jurisdiction issues defined therein. Any holder of this document is advised that information contained hereon reflects the Company's findings at the time of its intervention only and within the limits of Client's instructions, if any. The Company's sole responsibility is to its Client and this document does not exonerate parties to a transaction from exercising all their rights and obligations under the transaction documents. This document cannot be reproduced except in full, without prior written approval of the Company. Any unauthorized alteration, forgery or falsification of the content or appearance of this document is unlawful and offenders may be prosecuted to the fullest extent of the law.

Report Number :ER-2021-20085
 Operation Mode :802.11n20
 Test Frequency :5700 MHz
 Test Mode :Tx CH High
 EUT Pol :H Plane

Test Site :SAC III Chamber
 Test Date :2021-03-16
 Temp./Humi. :22.7/63
 Antenna Pol. :HORIZONTAL
 Engineer :Ricky

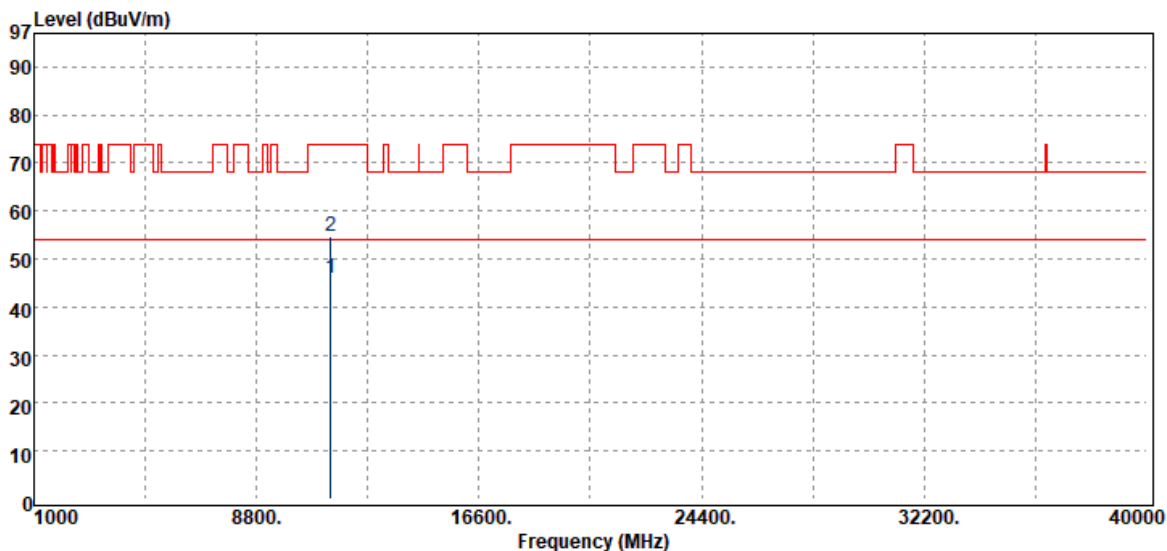

| Freq. MHz | Detector Mode PK/QP/AV | Spectrum Reading Level dB μ V | Factor dB | Actual FS dB μ V/m | Limit @3m dB μ V/m | Margin dB |
|--------------|------------------------------|---|--------------|------------------------------|------------------------------|--------------|
| 11400.00 | Average | 24.52 | 21.51 | 46.03 | 54.00 | -7.97 |
| 11400.00 | Peak | 33.25 | 21.51 | 54.76 | 74.00 | -19.24 |

Unless otherwise stated the results shown in this test report refer only to the sample(s) tested and such sample(s) are retained for 90 days only.

除非另有說明，此報告結果僅對測試之樣品負責，同時此樣品僅保留90天。本報告未經本公司書面許可，不可部份複製。

This document is issued by the Company subject to its General Conditions of Service printed overleaf, available on request or accessible at <http://www.sgs.com.tw/Terms-and-Conditions> and for electronic format documents, subject to Terms and Conditions for Electronic Documents at <http://www.sgs.com.tw/Terms-and-Conditions>. Attention is drawn to the limitation of liability, indemnification and jurisdiction issues defined therein. Any holder of this document is advised that information contained hereon reflects the Company's findings at the time of its intervention only and within the limits of Client's instructions, if any. The Company's sole responsibility is to its Client and this document does not exonerate parties to a transaction from exercising all their rights and obligations under the transaction documents. This document cannot be reproduced except in full, without prior written approval of the Company. Any unauthorized alteration, forgery or falsification of the content or appearance of this document is unlawful and offenders may be prosecuted to the fullest extent of the law.

Report Number :ER-2021-20085
 Operation Mode :802.11n20
 Test Frequency :5720 MHz
 Test Mode :Tx CH High
 EUT Pol :H Plane

Test Site :SAC III Chamber
 Test Date :2021-03-16
 Temp./Humi. :22.7/63
 Antenna Pol. :VERTICAL
 Engineer :Ricky

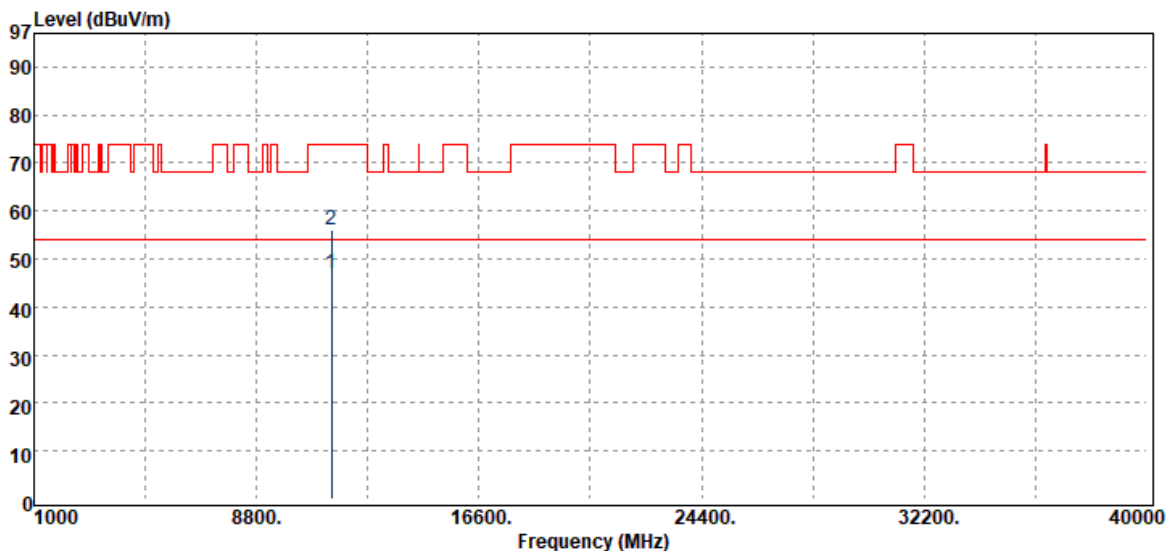

| Freq. MHz | Detector Mode PK/QP/AV | Spectrum Reading Level dB μ V | Factor dB | Actual FS dB μ V/m | Limit @3m dB μ V/m | Margin dB |
|--------------|------------------------------|---|--------------|------------------------------|------------------------------|--------------|
| 11440.00 | Average | 24.16 | 22.75 | 46.91 | 54.00 | -7.09 |
| 11440.00 | Peak | 33.25 | 22.75 | 56.00 | 74.00 | -18.00 |

Unless otherwise stated the results shown in this test report refer only to the sample(s) tested and such sample(s) are retained for 90 days only.

除非另有說明，此報告結果僅對測試之樣品負責，同時此樣品僅保留90天。本報告未經本公司書面許可，不可部份複製。

This document is issued by the Company subject to its General Conditions of Service printed overleaf, available on request or accessible at <http://www.sgs.com.tw/Terms-and-Conditions> and for electronic format documents, subject to Terms and Conditions for Electronic Documents at <http://www.sgs.com.tw/Terms-and-Conditions>. Attention is drawn to the limitation of liability, indemnification and jurisdiction issues defined therein. Any holder of this document is advised that information contained hereon reflects the Company's findings at the time of its intervention only and within the limits of Client's instructions, if any. The Company's sole responsibility is to its Client and this document does not exonerate parties to a transaction from exercising all their rights and obligations under the transaction documents. This document cannot be reproduced except in full, without prior written approval of the Company. Any unauthorized alteration, forgery or falsification of the content or appearance of this document is unlawful and offenders may be prosecuted to the fullest extent of the law.

Report Number :ER-2021-20085
 Operation Mode :802.11n20
 Test Frequency :5720 MHz
 Test Mode :Tx CH High
 EUT Pol :H Plane

Test Site :SAC III Chamber
 Test Date :2021-03-16
 Temp./Humi. :22.7/63
 Antenna Pol. :HORIZONTAL
 Engineer :Ricky

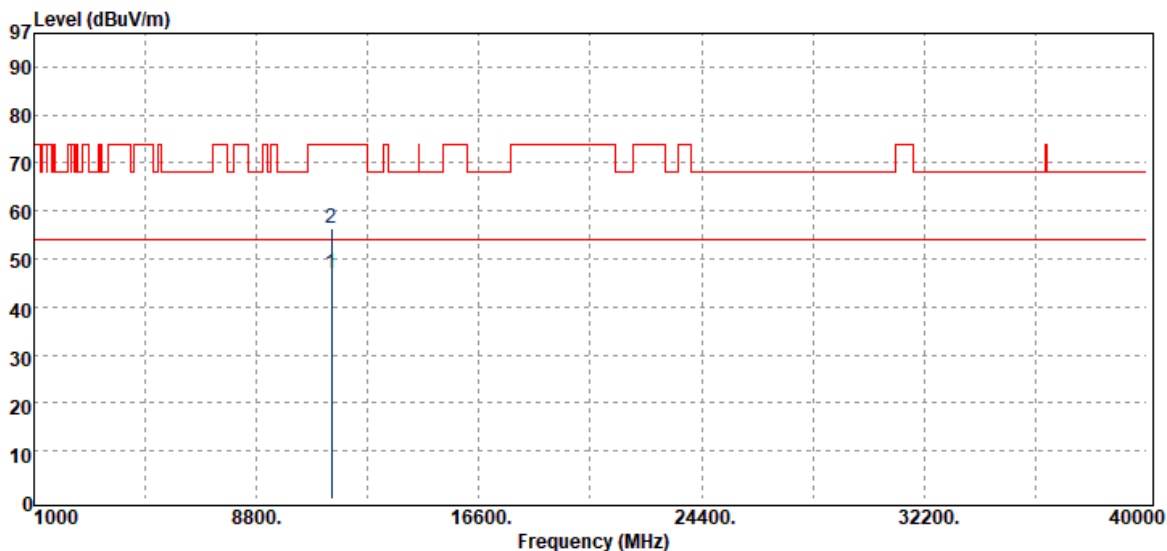

| Freq. MHz | Detector Mode PK/QP/AV | Spectrum Reading Level dB μ V | Factor dB | Actual FS dB μ V/m | Limit @3m dB μ V/m | Margin dB |
|--------------|------------------------------|---|--------------|------------------------------|------------------------------|--------------|
| 11440.00 | Average | 24.12 | 22.75 | 46.87 | 54.00 | -7.13 |
| 11440.00 | Peak | 33.68 | 22.75 | 56.43 | 74.00 | -17.57 |

Unless otherwise stated the results shown in this test report refer only to the sample(s) tested and such sample(s) are retained for 90 days only.

除非另有說明，此報告結果僅對測試之樣品負責，同時此樣品僅保留90天。本報告未經本公司書面許可，不可部份複製。

This document is issued by the Company subject to its General Conditions of Service printed overleaf, available on request or accessible at <http://www.sgs.com.tw/Terms-and-Conditions> and for electronic format documents, subject to Terms and Conditions for Electronic Documents at <http://www.sgs.com.tw/Terms-and-Conditions>. Attention is drawn to the limitation of liability, indemnification and jurisdiction issues defined therein. Any holder of this document is advised that information contained hereon reflects the Company's findings at the time of its intervention only and within the limits of Client's instructions, if any. The Company's sole responsibility is to its Client and this document does not exonerate parties to a transaction from exercising all their rights and obligations under the transaction documents. This document cannot be reproduced except in full, without prior written approval of the Company. Any unauthorized alteration, forgery or falsification of the content or appearance of this document is unlawful and offenders may be prosecuted to the fullest extent of the law.

Report Number :ER-2021-20085
 Operation Mode :802.11n20
 Test Frequency :5745 MHz
 Test Mode :Tx CH Low
 EUT Pol :H Plane

Test Site :SAC III Chamber
 Test Date :2021-03-16
 Temp./Humi. :22.7/63
 Antenna Pol. :VERTICAL
 Engineer :Ricky

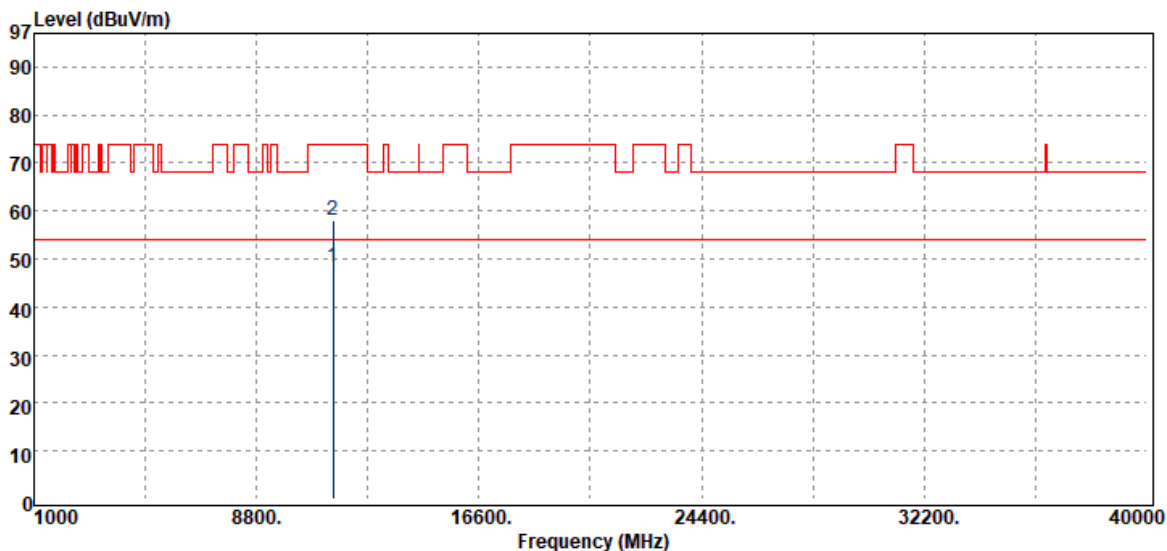

| Freq. MHz | Detector Mode PK/QP/AV | Spectrum Reading Level dB μ V | Factor dB | Actual FS dB μ V/m | Limit @3m dB μ V/m | Margin dB |
|--------------|------------------------------|---|--------------|------------------------------|------------------------------|--------------|
| 11490.00 | Average | 24.08 | 24.41 | 48.49 | 54.00 | -5.51 |
| 11490.00 | Peak | 33.66 | 24.41 | 58.07 | 74.00 | -15.93 |

Unless otherwise stated the results shown in this test report refer only to the sample(s) tested and such sample(s) are retained for 90 days only.

除非另有說明，此報告結果僅對測試之樣品負責，同時此樣品僅保留90天。本報告未經本公司書面許可，不可部份複製。

This document is issued by the Company subject to its General Conditions of Service printed overleaf, available on request or accessible at <http://www.sgs.com.tw/Terms-and-Conditions> and for electronic format documents, subject to Terms and Conditions for Electronic Documents at <http://www.sgs.com.tw/Terms-and-Conditions>. Attention is drawn to the limitation of liability, indemnification and jurisdiction issues defined therein. Any holder of this document is advised that information contained hereon reflects the Company's findings at the time of its intervention only and within the limits of Client's instructions, if any. The Company's sole responsibility is to its Client and this document does not exonerate parties to a transaction from exercising all their rights and obligations under the transaction documents. This document cannot be reproduced except in full, without prior written approval of the Company. Any unauthorized alteration, forgery or falsification of the content or appearance of this document is unlawful and offenders may be prosecuted to the fullest extent of the law.

Report Number :ER-2021-20085
 Operation Mode :802.11n20
 Test Frequency :5745 MHz
 Test Mode :Tx CH Low
 EUT Pol :H Plane

Test Site :SAC III Chamber
 Test Date :2021-03-16
 Temp./Humi. :22.7/63
 Antenna Pol. :HORIZONTAL
 Engineer :Ricky

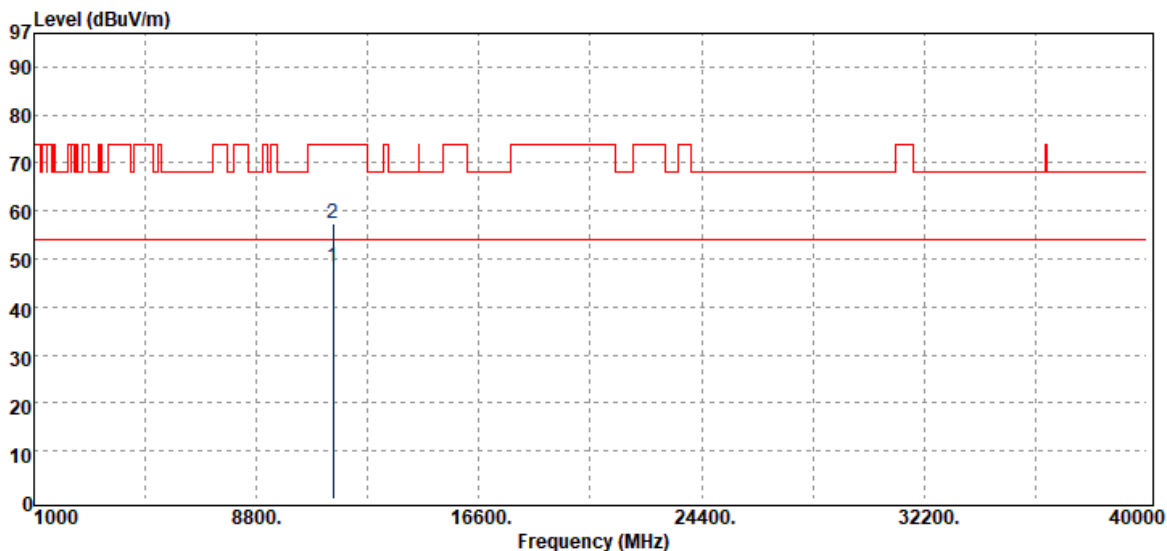

| Freq. MHz | Detector Mode PK/QP/AV | Spectrum Reading Level dB μ V | Factor dB | Actual FS dB μ V/m | Limit @3m dB μ V/m | Margin dB |
|--------------|------------------------------|---|--------------|------------------------------|------------------------------|--------------|
| 11490.00 | Average | 24.07 | 24.41 | 48.48 | 54.00 | -5.52 |
| 11490.00 | Peak | 32.87 | 24.41 | 57.28 | 74.00 | -16.72 |

Unless otherwise stated the results shown in this test report refer only to the sample(s) tested and such sample(s) are retained for 90 days only.

除非另有說明，此報告結果僅對測試之樣品負責，同時此樣品僅保留90天。本報告未經本公司書面許可，不可部份複製。

This document is issued by the Company subject to its General Conditions of Service printed overleaf, available on request or accessible at <http://www.sgs.com.tw/Terms-and-Conditions> and for electronic format documents, subject to Terms and Conditions for Electronic Documents at <http://www.sgs.com.tw/Terms-and-Conditions>. Attention is drawn to the limitation of liability, indemnification and jurisdiction issues defined therein. Any holder of this document is advised that information contained hereon reflects the Company's findings at the time of its intervention only and within the limits of Client's instructions, if any. The Company's sole responsibility is to its Client and this document does not exonerate parties to a transaction from exercising all their rights and obligations under the transaction documents. This document cannot be reproduced except in full, without prior written approval of the Company. Any unauthorized alteration, forgery or falsification of the content or appearance of this document is unlawful and offenders may be prosecuted to the fullest extent of the law.

Report Number :ER-2021-20085
 Operation Mode :802.11n20
 Test Frequency :5785 MHz
 Test Mode :Tx CH Mid
 EUT Pol :H Plane

Test Site :SAC III Chamber
 Test Date :2021-03-16
 Temp./Humi. :22.7/63
 Antenna Pol. :VERTICAL
 Engineer :Ricky

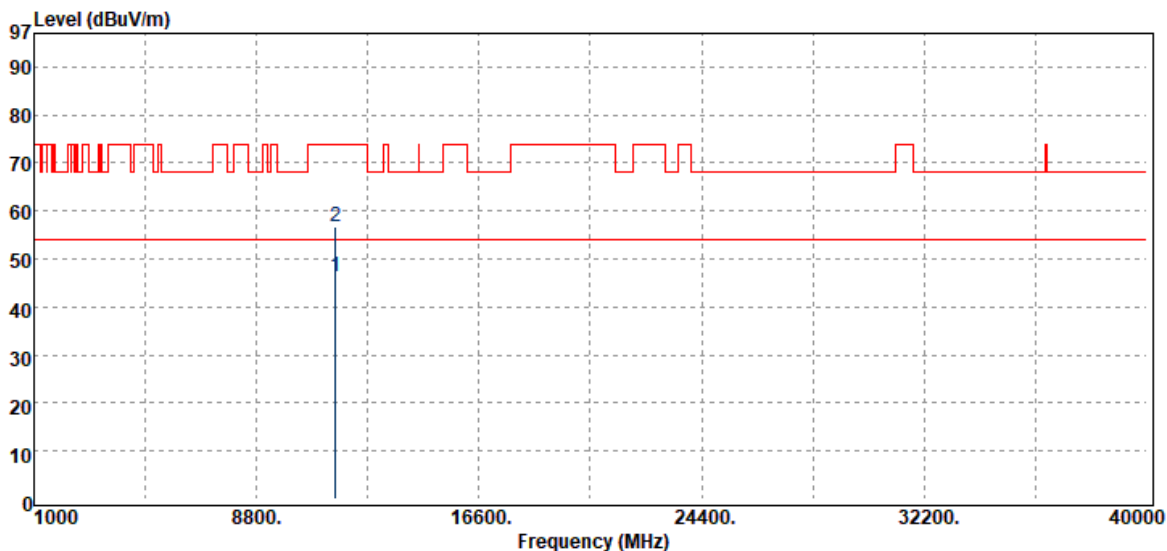

| Freq. MHz | Detector Mode PK/QP/AV | Spectrum Reading Level dB μ V | Factor dB | Actual FS dB μ V/m | Limit @3m dB μ V/m | Margin dB |
|--------------|------------------------------|---|--------------|------------------------------|------------------------------|--------------|
| 11570.00 | Average | 24.60 | 21.84 | 46.44 | 54.00 | -7.56 |
| 11570.00 | Peak | 34.90 | 21.84 | 56.74 | 74.00 | -17.26 |

Unless otherwise stated the results shown in this test report refer only to the sample(s) tested and such sample(s) are retained for 90 days only.

除非另有說明，此報告結果僅對測試之樣品負責，同時此樣品僅保留90天。本報告未經本公司書面許可，不可部份複製。

This document is issued by the Company subject to its General Conditions of Service printed overleaf, available on request or accessible at <http://www.sgs.com.tw/Terms-and-Conditions> and for electronic format documents, subject to Terms and Conditions for Electronic Documents at <http://www.sgs.com.tw/Terms-and-Conditions>. Attention is drawn to the limitation of liability, indemnification and jurisdiction issues defined therein. Any holder of this document is advised that information contained hereon reflects the Company's findings at the time of its intervention only and within the limits of Client's instructions, if any. The Company's sole responsibility is to its Client and this document does not exonerate parties to a transaction from exercising all their rights and obligations under the transaction documents. This document cannot be reproduced except in full, without prior written approval of the Company. Any unauthorized alteration, forgery or falsification of the content or appearance of this document is unlawful and offenders may be prosecuted to the fullest extent of the law.

Report Number :ER-2021-20085
 Operation Mode :802.11n20
 Test Frequency :5785 MHz
 Test Mode :Tx CH Mid
 EUT Pol :H Plane

Test Site :SAC III Chamber
 Test Date :2021-03-16
 Temp./Humi. :22.7/63
 Antenna Pol. :HORIZONTAL
 Engineer :Ricky

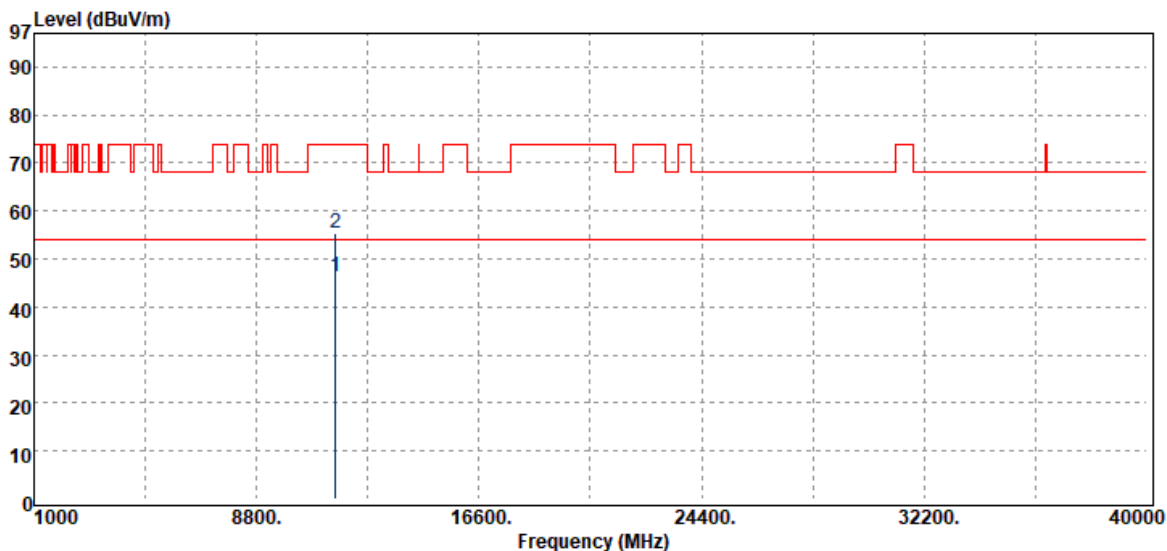

| Freq. MHz | Detector Mode PK/QP/AV | Spectrum Reading Level dB μ V | Factor dB | Actual FS dB μ V/m | Limit @3m dB μ V/m | Margin dB |
|--------------|------------------------------|---|--------------|------------------------------|------------------------------|--------------|
| 11570.00 | Average | 24.53 | 21.84 | 46.37 | 54.00 | -7.63 |
| 11570.00 | Peak | 33.61 | 21.84 | 55.45 | 74.00 | -18.55 |

Unless otherwise stated the results shown in this test report refer only to the sample(s) tested and such sample(s) are retained for 90 days only.

除非另有說明，此報告結果僅對測試之樣品負責，同時此樣品僅保留90天。本報告未經本公司書面許可，不可部份複製。

This document is issued by the Company subject to its General Conditions of Service printed overleaf, available on request or accessible at <http://www.sgs.com.tw/Terms-and-Conditions> and for electronic format documents, subject to Terms and Conditions for Electronic Documents at <http://www.sgs.com.tw/Terms-and-Conditions>. Attention is drawn to the limitation of liability, indemnification and jurisdiction issues defined therein. Any holder of this document is advised that information contained hereon reflects the Company's findings at the time of its intervention only and within the limits of Client's instructions, if any. The Company's sole responsibility is to its Client and this document does not exonerate parties to a transaction from exercising all their rights and obligations under the transaction documents. This document cannot be reproduced except in full, without prior written approval of the Company. Any unauthorized alteration, forgery or falsification of the content or appearance of this document is unlawful and offenders may be prosecuted to the fullest extent of the law.

Report Number :ER-2021-20085
 Operation Mode :802.11n20
 Test Frequency :5825 MHz
 Test Mode :Tx CH High
 EUT Pol :H Plane

Test Site :SAC III Chamber
 Test Date :2021-03-16
 Temp./Humi. :22.7/63
 Antenna Pol. :VERTICAL
 Engineer :Ricky

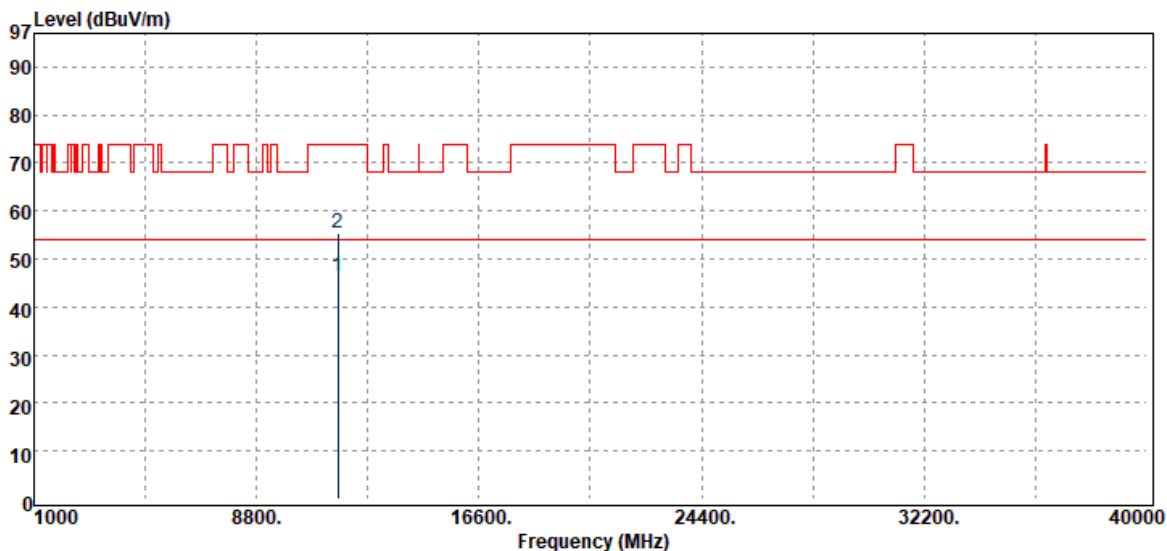

| Freq. MHz | Detector Mode PK/QP/AV | Spectrum Reading Level dB μ V | Factor dB | Actual FS dB μ V/m | Limit @3m dB μ V/m | Margin dB |
|--------------|------------------------------|---|--------------|------------------------------|------------------------------|--------------|
| 11650.00 | Average | 24.15 | 22.13 | 46.28 | 54.00 | -7.72 |
| 11650.00 | Peak | 33.10 | 22.13 | 55.23 | 74.00 | -18.77 |

Unless otherwise stated the results shown in this test report refer only to the sample(s) tested and such sample(s) are retained for 90 days only.

除非另有說明，此報告結果僅對測試之樣品負責，同時此樣品僅保留90天。本報告未經本公司書面許可，不可部份複製。

This document is issued by the Company subject to its General Conditions of Service printed overleaf, available on request or accessible at <http://www.sgs.com.tw/Terms-and-Conditions> and for electronic format documents, subject to Terms and Conditions for Electronic Documents at <http://www.sgs.com.tw/Terms-and-Conditions>. Attention is drawn to the limitation of liability, indemnification and jurisdiction issues defined therein. Any holder of this document is advised that information contained hereon reflects the Company's findings at the time of its intervention only and within the limits of Client's instructions, if any. The Company's sole responsibility is to its Client and this document does not exonerate parties to a transaction from exercising all their rights and obligations under the transaction documents. This document cannot be reproduced except in full, without prior written approval of the Company. Any unauthorized alteration, forgery or falsification of the content or appearance of this document is unlawful and offenders may be prosecuted to the fullest extent of the law.

Report Number :ER-2021-20085
 Operation Mode :802.11n20
 Test Frequency :5825 MHz
 Test Mode :Tx CH High
 EUT Pol :H Plane

Test Site :SAC III Chamber
 Test Date :2021-03-16
 Temp./Humi. :22.7/63
 Antenna Pol. :HORIZONTAL
 Engineer :Ricky

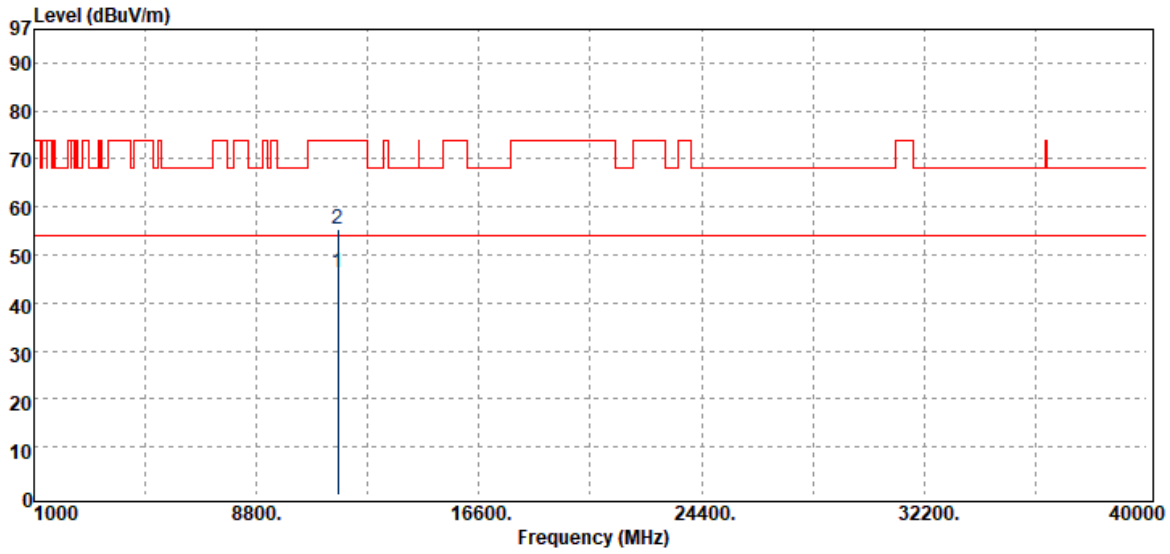

| Freq. MHz | Detector Mode PK/QP/AV | Spectrum Reading Level dB μ V | Factor dB | Actual FS dB μ V/m | Limit @3m dB μ V/m | Margin dB |
|--------------|------------------------------|---|--------------|------------------------------|------------------------------|--------------|
| 11650.00 | Average | 24.15 | 22.13 | 46.28 | 54.00 | -7.72 |
| 11650.00 | Peak | 33.22 | 22.13 | 55.35 | 74.00 | -18.65 |

Unless otherwise stated the results shown in this test report refer only to the sample(s) tested and such sample(s) are retained for 90 days only.

除非另有說明，此報告結果僅對測試之樣品負責，同時此樣品僅保留90天。本報告未經本公司書面許可，不可部份複製。

This document is issued by the Company subject to its General Conditions of Service printed overleaf, available on request or accessible at <http://www.sgs.com.tw/Terms-and-Conditions> and for electronic format documents, subject to Terms and Conditions for Electronic Documents at <http://www.sgs.com.tw/Terms-and-Conditions>. Attention is drawn to the limitation of liability, indemnification and jurisdiction issues defined therein. Any holder of this document is advised that information contained hereon reflects the Company's findings at the time of its intervention only and within the limits of Client's instructions, if any. The Company's sole responsibility is to its Client and this document does not exonerate parties to a transaction from exercising all their rights and obligations under the transaction documents. This document cannot be reproduced except in full, without prior written approval of the Company. Any unauthorized alteration, forgery or falsification of the content or appearance of this document is unlawful and offenders may be prosecuted to the fullest extent of the law.

Report Number :ER-2021-20085
 Operation Mode :802.11n40
 Test Frequency :5190 MHz
 Test Mode :Tx CH Low
 EUT Pol :H Plane

Test Site :SAC III Chamber
 Test Date :2021-03-16
 Temp./Humi. :22.7/63
 Antenna Pol. :VERTICAL
 Engineer :Ricky

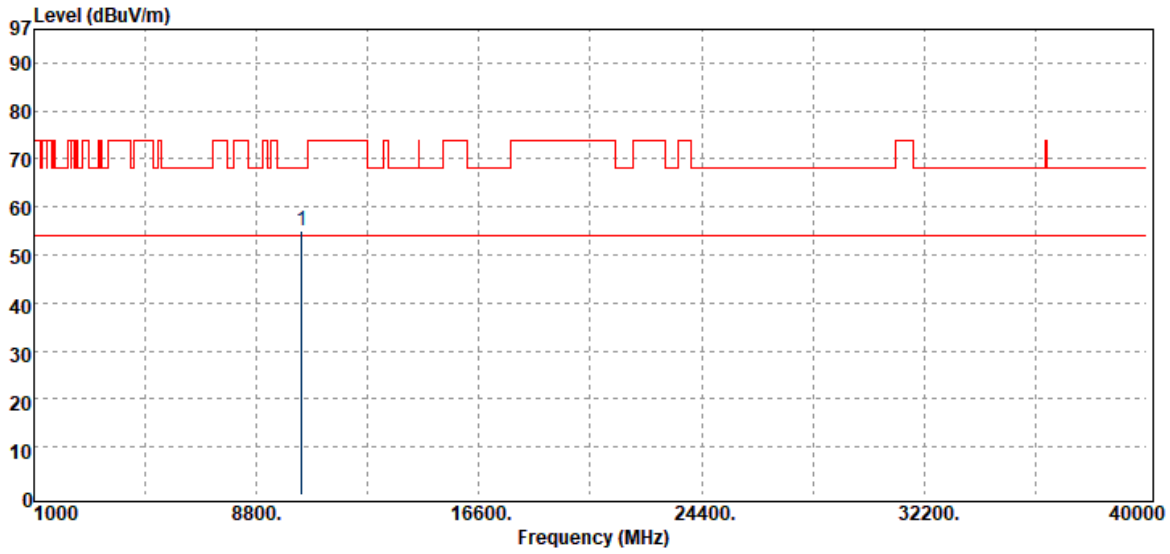

| Freq. MHz | Detector Mode PK/QP/AV | Spectrum Reading Level dB μ V | Factor dB | Actual FS dB μ V/m | Limit @3m dB μ V/m | Margin dB |
|--------------|------------------------------|---|--------------|------------------------------|------------------------------|--------------|
| 10380.00 | Peak | 35.51 | 19.70 | 55.21 | 68.20 | -12.99 |

Unless otherwise stated the results shown in this test report refer only to the sample(s) tested and such sample(s) are retained for 90 days only.

除非另有說明，此報告結果僅對測試之樣品負責，同時此樣品僅保留90天。本報告未經本公司書面許可，不可部份複製。

This document is issued by the Company subject to its General Conditions of Service printed overleaf, available on request or accessible at <http://www.sgs.com.tw/Terms-and-Conditions> and for electronic format documents, subject to Terms and Conditions for Electronic Documents at <http://www.sgs.com.tw/Terms-and-Conditions>. Attention is drawn to the limitation of liability, indemnification and jurisdiction issues defined therein. Any holder of this document is advised that information contained hereon reflects the Company's findings at the time of its intervention only and within the limits of Client's instructions, if any. The Company's sole responsibility is to its Client and this document does not exonerate parties to a transaction from exercising all their rights and obligations under the transaction documents. This document cannot be reproduced except in full, without prior written approval of the Company. Any unauthorized alteration, forgery or falsification of the content or appearance of this document is unlawful and offenders may be prosecuted to the fullest extent of the law.

Report Number :ER-2021-20085
 Operation Mode :802.11n40
 Test Frequency :5190 MHz
 Test Mode :Tx CH Low
 EUT Pol :H Plane

Test Site :SAC III Chamber
 Test Date :2021-03-16
 Temp./Humi. :22.7/63
 Antenna Pol. :HORIZONTAL
 Engineer :Ricky

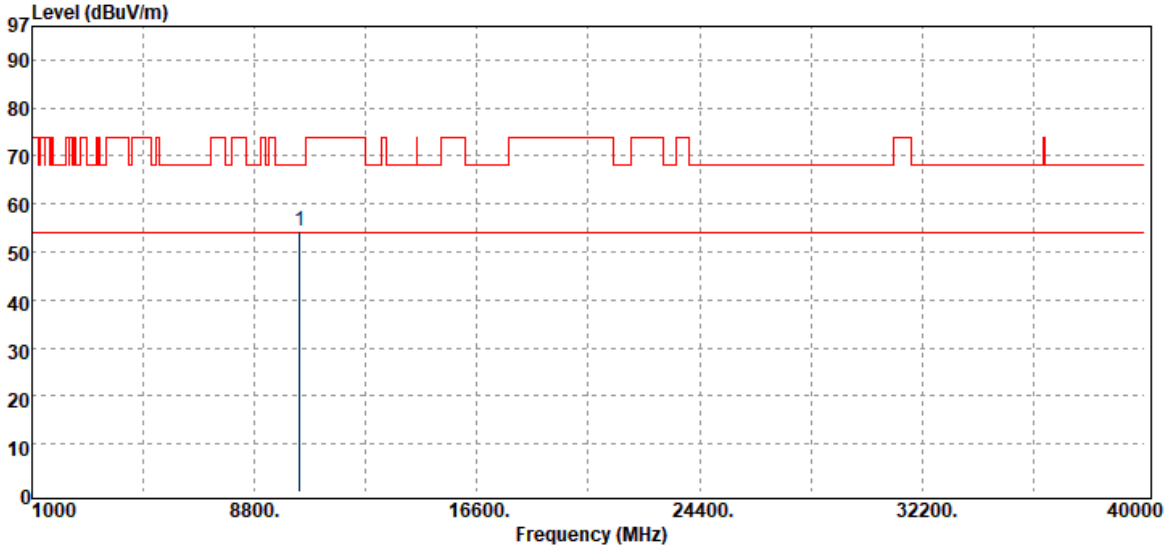

| Freq. MHz | Detector Mode PK/QP/AV | Spectrum Reading Level dB μ V | Factor dB | Actual FS dB μ V/m | Limit @3m dB μ V/m | Margin dB |
|--------------|------------------------------|---|--------------|------------------------------|------------------------------|--------------|
| 10380.00 | Peak | 34.79 | 19.70 | 54.49 | 68.20 | -13.71 |

Unless otherwise stated the results shown in this test report refer only to the sample(s) tested and such sample(s) are retained for 90 days only.

除非另有說明，此報告結果僅對測試之樣品負責，同時此樣品僅保留90天。本報告未經本公司書面許可，不可部份複製。

This document is issued by the Company subject to its General Conditions of Service printed overleaf, available on request or accessible at <http://www.sgs.com.tw/Terms-and-Conditions> and for electronic format documents, subject to Terms and Conditions for Electronic Documents at <http://www.sgs.com.tw/Terms-and-Conditions>. Attention is drawn to the limitation of liability, indemnification and jurisdiction issues defined therein. Any holder of this document is advised that information contained hereon reflects the Company's findings at the time of its intervention only and within the limits of Client's instructions, if any. The Company's sole responsibility is to its Client and this document does not exonerate parties to a transaction from exercising all their rights and obligations under the transaction documents. This document cannot be reproduced except in full, without prior written approval of the Company. Any unauthorized alteration, forgery or falsification of the content or appearance of this document is unlawful and offenders may be prosecuted to the fullest extent of the law.

Report Number :ER-2021-20085
 Operation Mode :802.11n40
 Test Frequency :5230 MHz
 Test Mode :Tx CH High
 EUT Pol :H Plane

Test Site :SAC III Chamber
 Test Date :2021-03-16
 Temp./Humi. :22.7/63
 Antenna Pol. :VERTICAL
 Engineer :Ricky

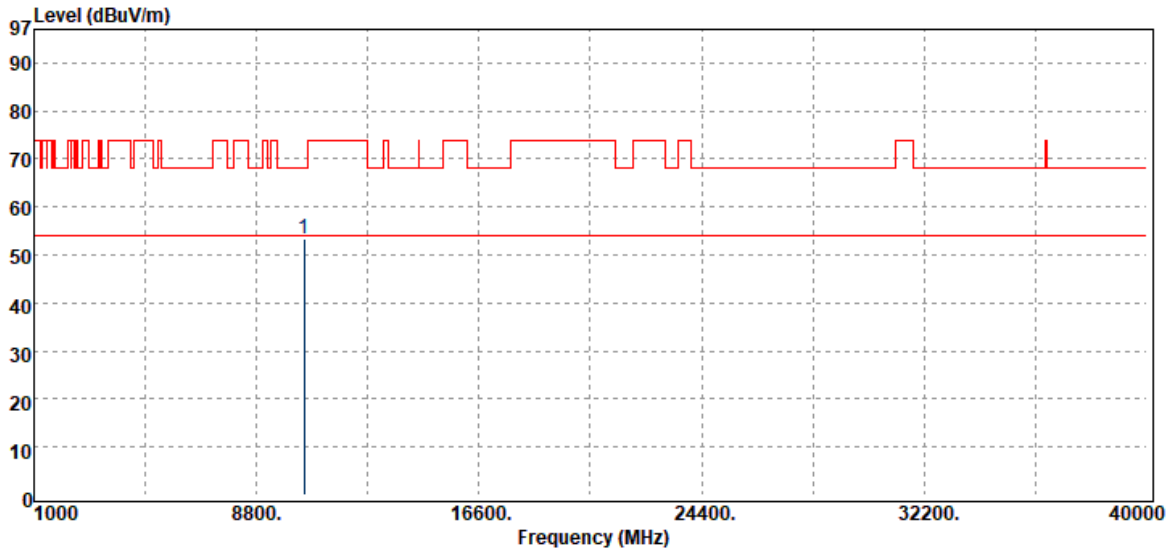

| Freq. MHz | Detector Mode PK/QP/AV | Spectrum Reading Level dB μ V | Factor dB | Actual FS dB μ V/m | Limit @3m dB μ V/m | Margin dB |
|--------------|------------------------------|---|--------------|------------------------------|------------------------------|--------------|
| 10460.00 | Peak | 34.29 | 19.22 | 53.51 | 68.20 | -14.69 |

Unless otherwise stated the results shown in this test report refer only to the sample(s) tested and such sample(s) are retained for 90 days only.

除非另有說明，此報告結果僅對測試之樣品負責，同時此樣品僅保留90天。本報告未經本公司書面許可，不可部份複製。

This document is issued by the Company subject to its General Conditions of Service printed overleaf, available on request or accessible at <http://www.sgs.com.tw/Terms-and-Conditions> and for electronic format documents, subject to Terms and Conditions for Electronic Documents at <http://www.sgs.com.tw/Terms-and-Conditions>. Attention is drawn to the limitation of liability, indemnification and jurisdiction issues defined therein. Any holder of this document is advised that information contained hereon reflects the Company's findings at the time of its intervention only and within the limits of Client's instructions, if any. The Company's sole responsibility is to its Client and this document does not exonerate parties to a transaction from exercising all their rights and obligations under the transaction documents. This document cannot be reproduced except in full, without prior written approval of the Company. Any unauthorized alteration, forgery or falsification of the content or appearance of this document is unlawful and offenders may be prosecuted to the fullest extent of the law.

Report Number :ER-2021-20085
 Operation Mode :802.11n40
 Test Frequency :5230 MHz
 Test Mode :Tx CH High
 EUT Pol :H Plane

Test Site :SAC III Chamber
 Test Date :2021-03-16
 Temp./Humi. :22.7/63
 Antenna Pol. :HORIZONTAL
 Engineer :Ricky

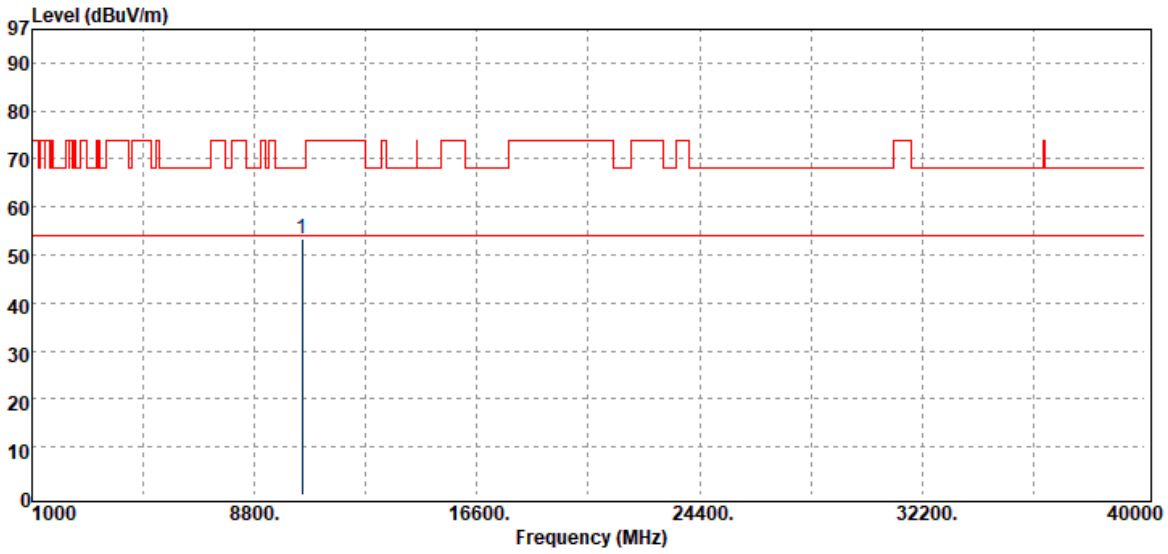

| Freq. MHz | Detector Mode PK/QP/AV | Spectrum Reading Level dB μ V | Factor dB | Actual FS dB μ V/m | Limit @3m dB μ V/m | Margin dB |
|--------------|------------------------------|---|--------------|------------------------------|------------------------------|--------------|
| 10460.00 | Peak | 34.24 | 19.22 | 53.46 | 68.20 | -14.74 |

Unless otherwise stated the results shown in this test report refer only to the sample(s) tested and such sample(s) are retained for 90 days only.

除非另有說明，此報告結果僅對測試之樣品負責，同時此樣品僅保留90天。本報告未經本公司書面許可，不可部份複製。

This document is issued by the Company subject to its General Conditions of Service printed overleaf, available on request or accessible at <http://www.sgs.com.tw/Terms-and-Conditions> and for electronic format documents, subject to Terms and Conditions for Electronic Documents at <http://www.sgs.com.tw/Terms-and-Conditions>. Attention is drawn to the limitation of liability, indemnification and jurisdiction issues defined therein. Any holder of this document is advised that information contained hereon reflects the Company's findings at the time of its intervention only and within the limits of Client's instructions, if any. The Company's sole responsibility is to its Client and this document does not exonerate parties to a transaction from exercising all their rights and obligations under the transaction documents. This document cannot be reproduced except in full, without prior written approval of the Company. Any unauthorized alteration, forgery or falsification of the content or appearance of this document is unlawful and offenders may be prosecuted to the fullest extent of the law.

Report Number :ER-2021-20085
 Operation Mode :802.11n40
 Test Frequency :5270 MHz
 Test Mode :Tx CH Low
 EUT Pol :H Plane

Test Site :SAC III Chamber
 Test Date :2021-03-16
 Temp./Humi. :22.7/63
 Antenna Pol. :VERTICAL
 Engineer :Ricky

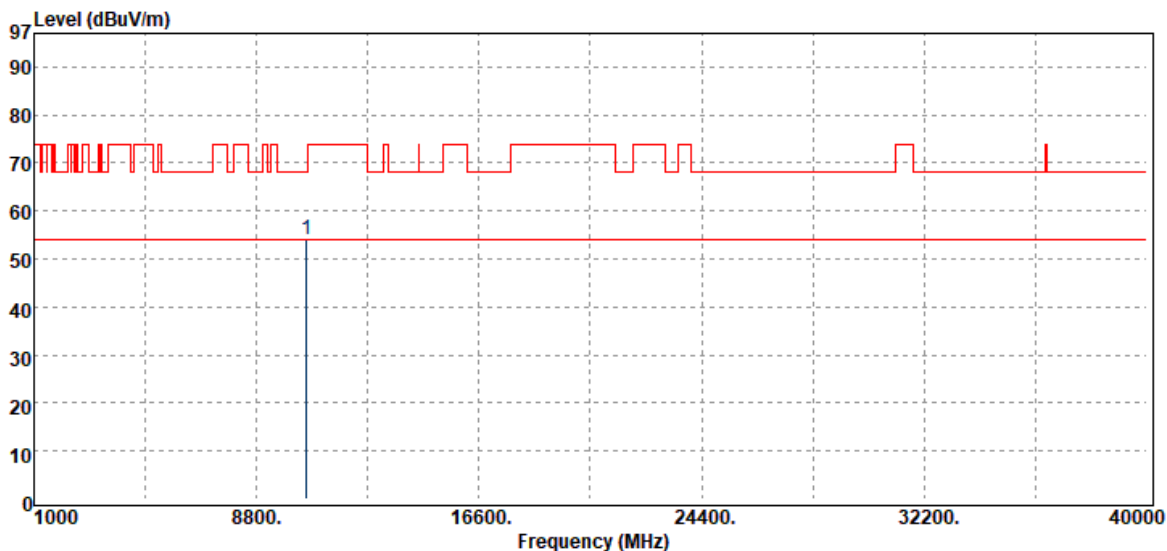

| Freq. MHz | Detector Mode PK/QP/AV | Spectrum Reading Level dB μ V | Factor dB | Actual FS dB μ V/m | Limit @3m dB μ V/m | Margin dB |
|--------------|------------------------------|---|--------------|------------------------------|------------------------------|--------------|
| 10540.00 | Peak | 34.37 | 19.78 | 54.15 | 68.20 | -14.05 |

Unless otherwise stated the results shown in this test report refer only to the sample(s) tested and such sample(s) are retained for 90 days only.

除非另有說明，此報告結果僅對測試之樣品負責，同時此樣品僅保留90天。本報告未經本公司書面許可，不可部份複製。

This document is issued by the Company subject to its General Conditions of Service printed overleaf, available on request or accessible at <http://www.sgs.com.tw/Terms-and-Conditions> and for electronic format documents, subject to Terms and Conditions for Electronic Documents at <http://www.sgs.com.tw/Terms-and-Conditions>. Attention is drawn to the limitation of liability, indemnification and jurisdiction issues defined therein. Any holder of this document is advised that information contained hereon reflects the Company's findings at the time of its intervention only and within the limits of Client's instructions, if any. The Company's sole responsibility is to its Client and this document does not exonerate parties to a transaction from exercising all their rights and obligations under the transaction documents. This document cannot be reproduced except in full, without prior written approval of the Company. Any unauthorized alteration, forgery or falsification of the content or appearance of this document is unlawful and offenders may be prosecuted to the fullest extent of the law.

Report Number :ER-2021-20085
 Operation Mode :802.11n40
 Test Frequency :5270 MHz
 Test Mode :Tx CH Low
 EUT Pol :H Plane

Test Site :SAC III Chamber
 Test Date :2021-03-16
 Temp./Humi. :22.7/63
 Antenna Pol. :HORIZONTAL
 Engineer :Ricky

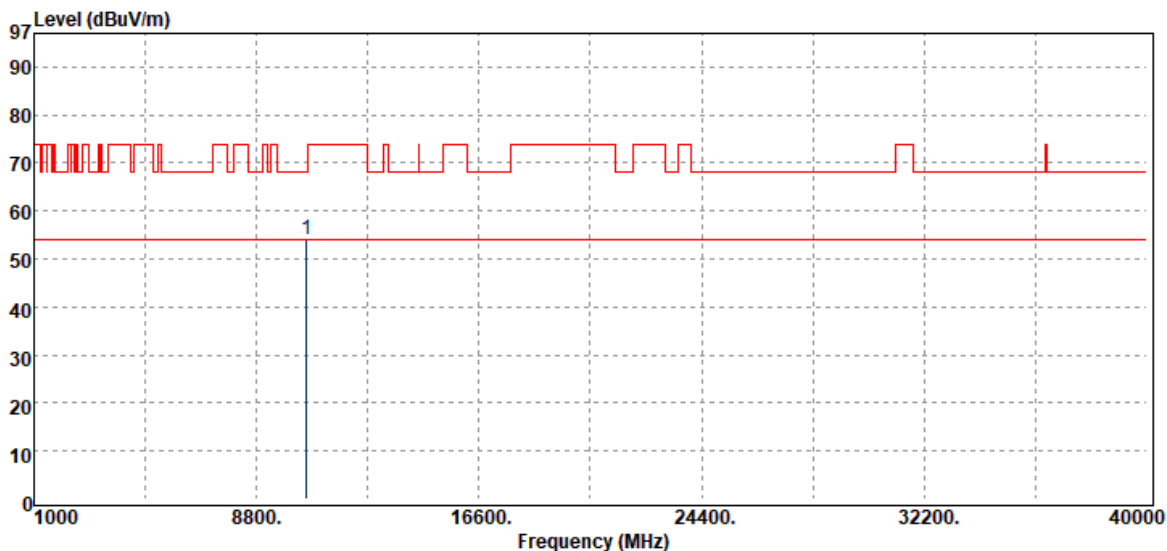

| Freq. MHz | Detector Mode PK/QP/AV | Spectrum Reading Level dB μ V | Factor dB | Actual FS dB μ V/m | Limit @3m dB μ V/m | Margin dB |
|--------------|------------------------------|---|--------------|------------------------------|------------------------------|--------------|
| 10540.00 | Peak | 34.26 | 19.78 | 54.04 | 68.20 | -14.16 |

Unless otherwise stated the results shown in this test report refer only to the sample(s) tested and such sample(s) are retained for 90 days only.

除非另有說明，此報告結果僅對測試之樣品負責，同時此樣品僅保留90天。本報告未經本公司書面許可，不可部份複製。

This document is issued by the Company subject to its General Conditions of Service printed overleaf, available on request or accessible at <http://www.sgs.com.tw/Terms-and-Conditions> and for electronic format documents, subject to Terms and Conditions for Electronic Documents at <http://www.sgs.com.tw/Terms-and-Conditions>. Attention is drawn to the limitation of liability, indemnification and jurisdiction issues defined therein. Any holder of this document is advised that information contained hereon reflects the Company's findings at the time of its intervention only and within the limits of Client's instructions, if any. The Company's sole responsibility is to its Client and this document does not exonerate parties to a transaction from exercising all their rights and obligations under the transaction documents. This document cannot be reproduced except in full, without prior written approval of the Company. Any unauthorized alteration, forgery or falsification of the content or appearance of this document is unlawful and offenders may be prosecuted to the fullest extent of the law.

Report Number :ER-2021-20085
 Operation Mode :802.11n40
 Test Frequency :5310 MHz
 Test Mode :Tx CH High
 EUT Pol :H Plane

Test Site :SAC III Chamber
 Test Date :2021-03-16
 Temp./Humi. :22.7/63
 Antenna Pol. :VERTICAL
 Engineer :Ricky

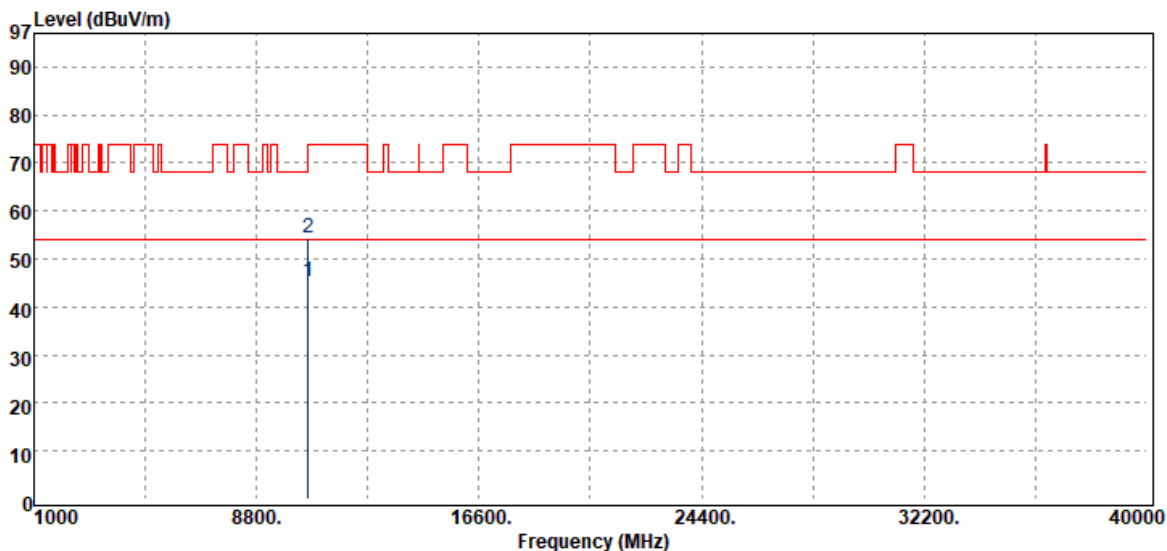

| Freq. MHz | Detector Mode PK/QP/AV | Spectrum Reading Level dB μ V | Factor dB | Actual FS dB μ V/m | Limit @3m dB μ V/m | Margin dB |
|--------------|------------------------------|---|--------------|------------------------------|------------------------------|--------------|
| 10620.00 | Average | 25.12 | 20.12 | 45.24 | 54.00 | -8.76 |
| 10620.00 | Peak | 34.26 | 20.12 | 54.38 | 74.00 | -19.62 |

Unless otherwise stated the results shown in this test report refer only to the sample(s) tested and such sample(s) are retained for 90 days only.

除非另有說明，此報告結果僅對測試之樣品負責，同時此樣品僅保留90天。本報告未經本公司書面許可，不可部份複製。

This document is issued by the Company subject to its General Conditions of Service printed overleaf, available on request or accessible at <http://www.sgs.com.tw/Terms-and-Conditions> and for electronic format documents, subject to Terms and Conditions for Electronic Documents at <http://www.sgs.com.tw/Terms-and-Conditions>. Attention is drawn to the limitation of liability, indemnification and jurisdiction issues defined therein. Any holder of this document is advised that information contained hereon reflects the Company's findings at the time of its intervention only and within the limits of Client's instructions, if any. The Company's sole responsibility is to its Client and this document does not exonerate parties to a transaction from exercising all their rights and obligations under the transaction documents. This document cannot be reproduced except in full, without prior written approval of the Company. Any unauthorized alteration, forgery or falsification of the content or appearance of this document is unlawful and offenders may be prosecuted to the fullest extent of the law.

Report Number :ER-2021-20085
 Operation Mode :802.11n40
 Test Frequency :5310 MHz
 Test Mode :Tx CH High
 EUT Pol :H Plane

Test Site :SAC III Chamber
 Test Date :2021-03-16
 Temp./Humi. :22.7/63
 Antenna Pol. :HORIZONTAL
 Engineer :Ricky

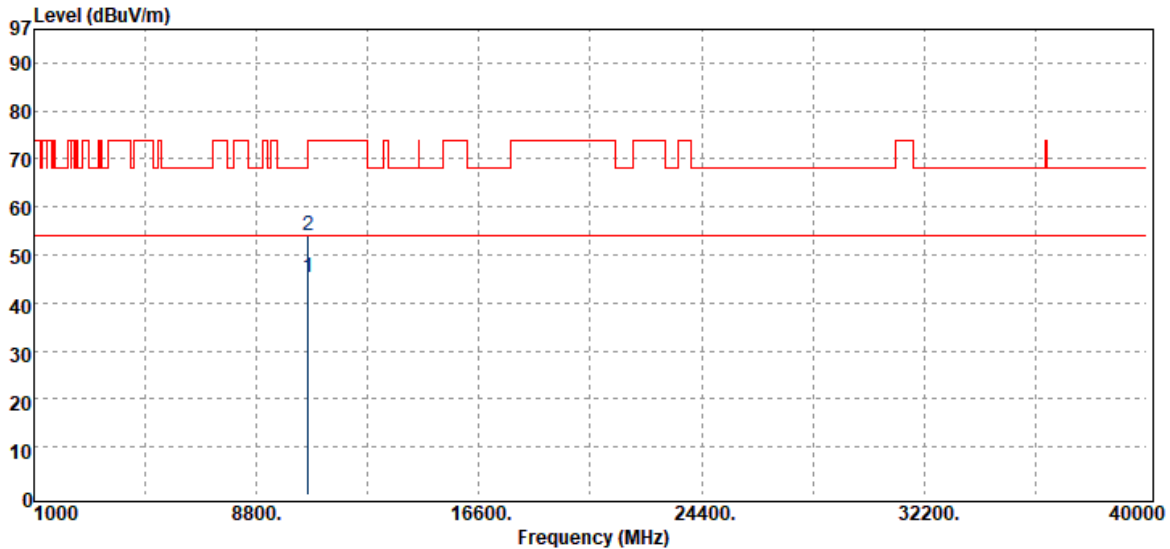

| Freq. MHz | Detector Mode PK/QP/AV | Spectrum Reading Level dB μ V | Factor dB | Actual FS dB μ V/m | Limit @3m dB μ V/m | Margin dB |
|--------------|------------------------------|---|--------------|------------------------------|------------------------------|--------------|
| 10620.00 | Average | 25.12 | 20.12 | 45.24 | 54.00 | -8.76 |
| 10620.00 | Peak | 34.04 | 20.12 | 54.16 | 74.00 | -19.84 |

Unless otherwise stated the results shown in this test report refer only to the sample(s) tested and such sample(s) are retained for 90 days only.

除非另有說明，此報告結果僅對測試之樣品負責，同時此樣品僅保留90天。本報告未經本公司書面許可，不可部份複製。

This document is issued by the Company subject to its General Conditions of Service printed overleaf, available on request or accessible at <http://www.sgs.com.tw/Terms-and-Conditions> and for electronic format documents, subject to Terms and Conditions for Electronic Documents at <http://www.sgs.com.tw/Terms-and-Conditions>. Attention is drawn to the limitation of liability, indemnification and jurisdiction issues defined therein. Any holder of this document is advised that information contained hereon reflects the Company's findings at the time of its intervention only and within the limits of Client's instructions, if any. The Company's sole responsibility is to its Client and this document does not exonerate parties to a transaction from exercising all their rights and obligations under the transaction documents. This document cannot be reproduced except in full, without prior written approval of the Company. Any unauthorized alteration, forgery or falsification of the content or appearance of this document is unlawful and offenders may be prosecuted to the fullest extent of the law.

Report Number :ER-2021-20085
 Operation Mode :802.11n40
 Test Frequency :5510 MHz
 Test Mode :Tx CH Low
 EUT Pol :H Plane

Test Site :SAC III Chamber
 Test Date :2021-03-16
 Temp./Humi. :22.7/63
 Antenna Pol. :VERTICAL
 Engineer :Ricky

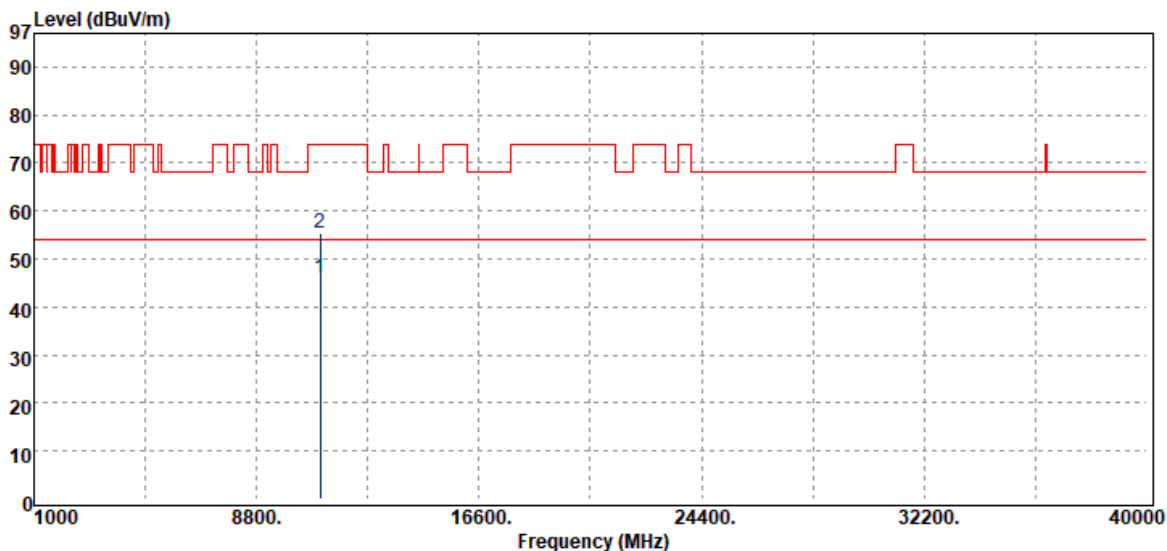

| Freq. MHz | Detector Mode PK/QP/AV | Spectrum Reading Level dB μ V | Factor dB | Actual FS dB μ V/m | Limit @3m dB μ V/m | Margin dB |
|--------------|------------------------------|---|--------------|------------------------------|------------------------------|--------------|
| 11020.00 | Average | 24.49 | 21.61 | 46.10 | 54.00 | -7.90 |
| 11020.00 | Peak | 33.71 | 21.61 | 55.32 | 74.00 | -18.68 |

Unless otherwise stated the results shown in this test report refer only to the sample(s) tested and such sample(s) are retained for 90 days only.

除非另有說明，此報告結果僅對測試之樣品負責，同時此樣品僅保留90天。本報告未經本公司書面許可，不可部份複製。

This document is issued by the Company subject to its General Conditions of Service printed overleaf, available on request or accessible at <http://www.sgs.com.tw/Terms-and-Conditions> and for electronic format documents, subject to Terms and Conditions for Electronic Documents at <http://www.sgs.com.tw/Terms-and-Conditions>. Attention is drawn to the limitation of liability, indemnification and jurisdiction issues defined therein. Any holder of this document is advised that information contained hereon reflects the Company's findings at the time of its intervention only and within the limits of Client's instructions, if any. The Company's sole responsibility is to its Client and this document does not exonerate parties to a transaction from exercising all their rights and obligations under the transaction documents. This document cannot be reproduced except in full, without prior written approval of the Company. Any unauthorized alteration, forgery or falsification of the content or appearance of this document is unlawful and offenders may be prosecuted to the fullest extent of the law.

Report Number :ER-2021-20085
 Operation Mode :802.11n40
 Test Frequency :5510 MHz
 Test Mode :Tx CH Low
 EUT Pol :H Plane

Test Site :SAC III Chamber
 Test Date :2021-03-16
 Temp./Humi. :22.7/63
 Antenna Pol. :HORIZONTAL
 Engineer :Ricky

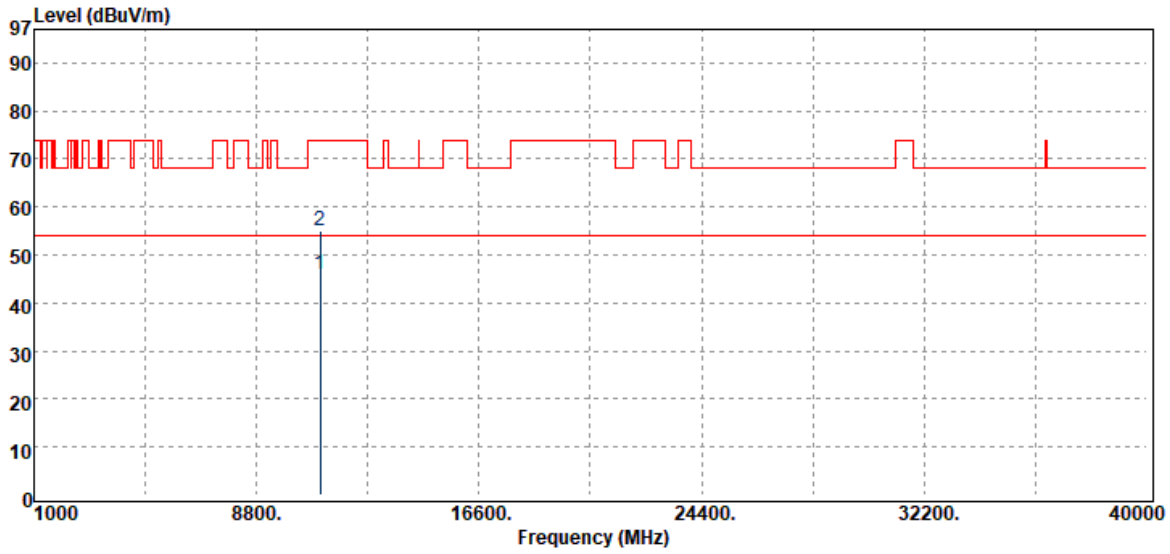

| Freq. MHz | Detector Mode PK/QP/AV | Spectrum Reading Level dB μ V | Factor dB | Actual FS dB μ V/m | Limit @3m dB μ V/m | Margin dB |
|--------------|------------------------------|---|--------------|------------------------------|------------------------------|--------------|
| 11020.00 | Average | 24.46 | 21.61 | 46.07 | 54.00 | -7.93 |
| 11020.00 | Peak | 33.33 | 21.61 | 54.94 | 74.00 | -19.06 |

Unless otherwise stated the results shown in this test report refer only to the sample(s) tested and such sample(s) are retained for 90 days only.

除非另有說明，此報告結果僅對測試之樣品負責，同時此樣品僅保留90天。本報告未經本公司書面許可，不可部份複製。

This document is issued by the Company subject to its General Conditions of Service printed overleaf, available on request or accessible at <http://www.sgs.com.tw/Terms-and-Conditions> and for electronic format documents, subject to Terms and Conditions for Electronic Documents at <http://www.sgs.com.tw/Terms-and-Conditions>. Attention is drawn to the limitation of liability, indemnification and jurisdiction issues defined therein. Any holder of this document is advised that information contained hereon reflects the Company's findings at the time of its intervention only and within the limits of Client's instructions, if any. The Company's sole responsibility is to its Client and this document does not exonerate parties to a transaction from exercising all their rights and obligations under the transaction documents. This document cannot be reproduced except in full, without prior written approval of the Company. Any unauthorized alteration, forgery or falsification of the content or appearance of this document is unlawful and offenders may be prosecuted to the fullest extent of the law.

Report Number :ER-2021-20085
 Operation Mode :802.11n40
 Test Frequency :5550 MHz
 Test Mode :Tx CH Mid
 EUT Pol :H Plane

Test Site :SAC III Chamber
 Test Date :2021-03-16
 Temp./Humi. :22.7/63
 Antenna Pol. :VERTICAL
 Engineer :Ricky

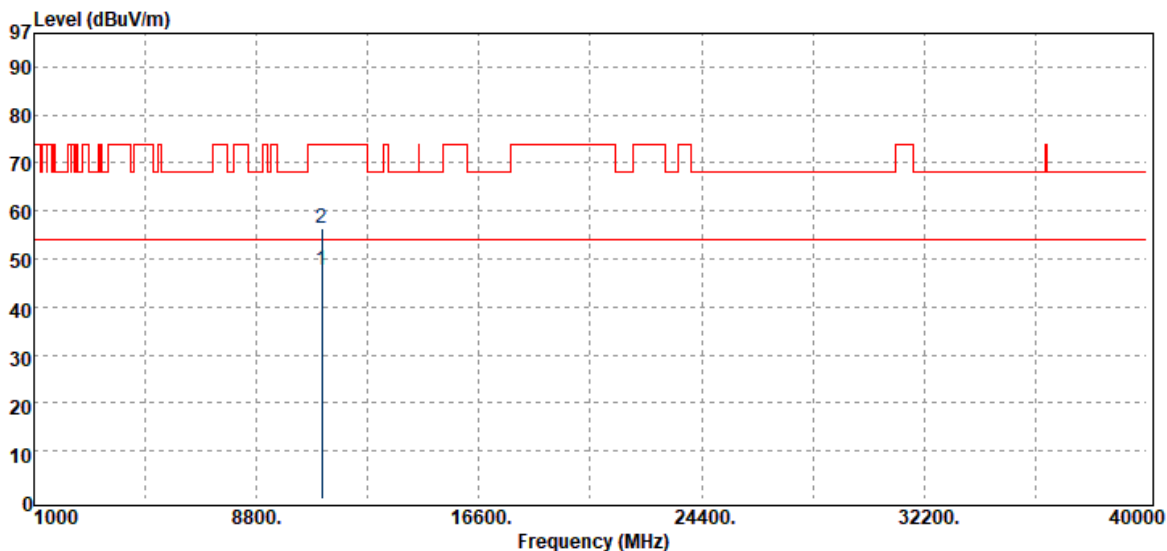

| Freq. MHz | Detector Mode PK/QP/AV | Spectrum Reading Level dB μ V | Factor dB | Actual FS dB μ V/m | Limit @3m dB μ V/m | Margin dB |
|--------------|------------------------------|---|--------------|------------------------------|------------------------------|--------------|
| 11100.00 | Average | 24.74 | 22.83 | 47.57 | 54.00 | -6.43 |
| 11100.00 | Peak | 33.59 | 22.83 | 56.42 | 74.00 | -17.58 |

Unless otherwise stated the results shown in this test report refer only to the sample(s) tested and such sample(s) are retained for 90 days only.

除非另有說明，此報告結果僅對測試之樣品負責，同時此樣品僅保留90天。本報告未經本公司書面許可，不可部份複製。

This document is issued by the Company subject to its General Conditions of Service printed overleaf, available on request or accessible at <http://www.sgs.com.tw/Terms-and-Conditions> and for electronic format documents, subject to Terms and Conditions for Electronic Documents at <http://www.sgs.com.tw/Terms-and-Conditions>. Attention is drawn to the limitation of liability, indemnification and jurisdiction issues defined therein. Any holder of this document is advised that information contained hereon reflects the Company's findings at the time of its intervention only and within the limits of Client's instructions, if any. The Company's sole responsibility is to its Client and this document does not exonerate parties to a transaction from exercising all their rights and obligations under the transaction documents. This document cannot be reproduced except in full, without prior written approval of the Company. Any unauthorized alteration, forgery or falsification of the content or appearance of this document is unlawful and offenders may be prosecuted to the fullest extent of the law.

Report Number :ER-2021-20085
 Operation Mode :802.11n40
 Test Frequency :5550 MHz
 Test Mode :Tx CH Mid
 EUT Pol :H Plane

Test Site :SAC III Chamber
 Test Date :2021-03-16
 Temp./Humi. :22.7/63
 Antenna Pol. :HORIZONTAL
 Engineer :Ricky

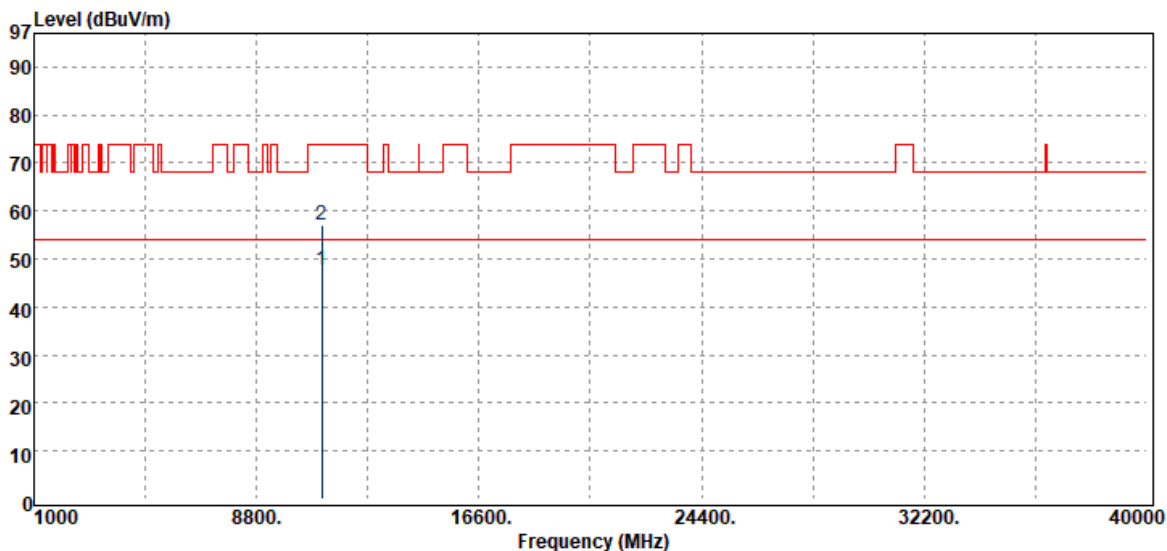

| Freq. MHz | Detector Mode PK/QP/AV | Spectrum Reading Level dB μ V | Factor dB | Actual FS dB μ V/m | Limit @3m dB μ V/m | Margin dB |
|--------------|------------------------------|---|--------------|------------------------------|------------------------------|--------------|
| 11100.00 | Average | 24.71 | 22.83 | 47.54 | 54.00 | -6.46 |
| 11100.00 | Peak | 34.16 | 22.83 | 56.99 | 74.00 | -17.01 |

Unless otherwise stated the results shown in this test report refer only to the sample(s) tested and such sample(s) are retained for 90 days only.

除非另有說明，此報告結果僅對測試之樣品負責，同時此樣品僅保留90天。本報告未經本公司書面許可，不可部份複製。

This document is issued by the Company subject to its General Conditions of Service printed overleaf, available on request or accessible at <http://www.sgs.com.tw/Terms-and-Conditions> and for electronic format documents, subject to Terms and Conditions for Electronic Documents at <http://www.sgs.com.tw/Terms-and-Conditions>. Attention is drawn to the limitation of liability, indemnification and jurisdiction issues defined therein. Any holder of this document is advised that information contained hereon reflects the Company's findings at the time of its intervention only and within the limits of Client's instructions, if any. The Company's sole responsibility is to its Client and this document does not exonerate parties to a transaction from exercising all their rights and obligations under the transaction documents. This document cannot be reproduced except in full, without prior written approval of the Company. Any unauthorized alteration, forgery or falsification of the content or appearance of this document is unlawful and offenders may be prosecuted to the fullest extent of the law.

Report Number :ER-2021-20085
 Operation Mode :802.11n40
 Test Frequency :5670 MHz
 Test Mode :Tx CH High
 EUT Pol :H Plane

Test Site :SAC III Chamber
 Test Date :2021-03-16
 Temp./Humi. :22.7/63
 Antenna Pol. :VERTICAL
 Engineer :Ricky

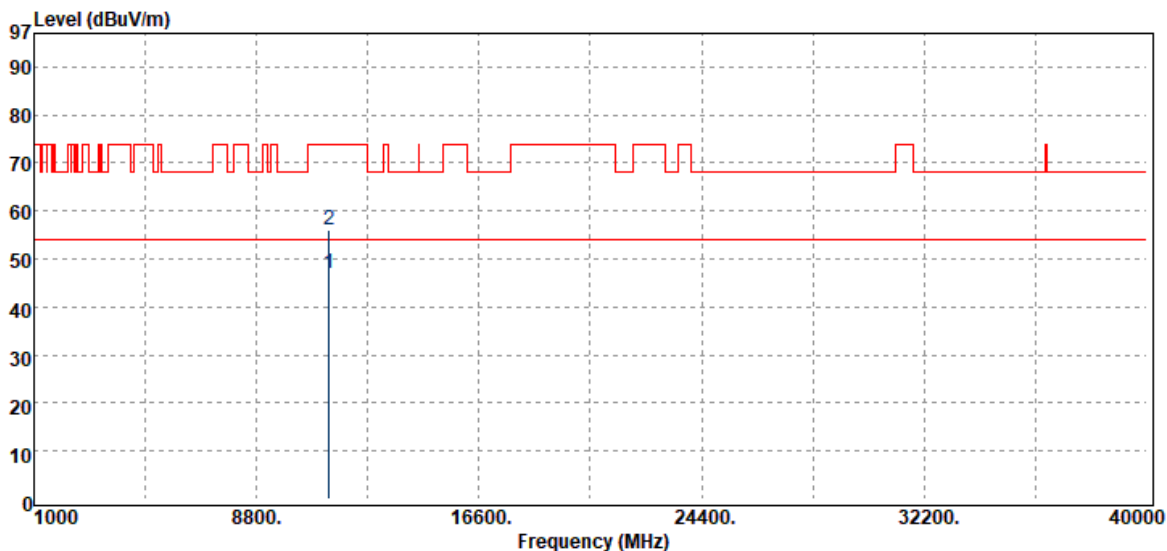

| Freq. MHz | Detector Mode PK/QP/AV | Spectrum Reading Level dB μ V | Factor dB | Actual FS dB μ V/m | Limit @3m dB μ V/m | Margin dB |
|--------------|------------------------------|---|--------------|------------------------------|------------------------------|--------------|
| 11340.00 | Average | 24.90 | 22.19 | 47.09 | 54.00 | -6.91 |
| 11340.00 | Peak | 33.98 | 22.19 | 56.17 | 74.00 | -17.83 |

Unless otherwise stated the results shown in this test report refer only to the sample(s) tested and such sample(s) are retained for 90 days only.

除非另有說明，此報告結果僅對測試之樣品負責，同時此樣品僅保留90天。本報告未經本公司書面許可，不可部份複製。

This document is issued by the Company subject to its General Conditions of Service printed overleaf, available on request or accessible at <http://www.sgs.com.tw/Terms-and-Conditions> and for electronic format documents, subject to Terms and Conditions for Electronic Documents at <http://www.sgs.com.tw/Terms-and-Conditions>. Attention is drawn to the limitation of liability, indemnification and jurisdiction issues defined therein. Any holder of this document is advised that information contained hereon reflects the Company's findings at the time of its intervention only and within the limits of Client's instructions, if any. The Company's sole responsibility is to its Client and this document does not exonerate parties to a transaction from exercising all their rights and obligations under the transaction documents. This document cannot be reproduced except in full, without prior written approval of the Company. Any unauthorized alteration, forgery or falsification of the content or appearance of this document is unlawful and offenders may be prosecuted to the fullest extent of the law.

Report Number :ER-2021-20085
 Operation Mode :802.11n40
 Test Frequency :5670 MHz
 Test Mode :Tx CH High
 EUT Pol :H Plane

Test Site :SAC III Chamber
 Test Date :2021-03-16
 Temp./Humi. :22.7/63
 Antenna Pol. :HORIZONTAL
 Engineer :Ricky

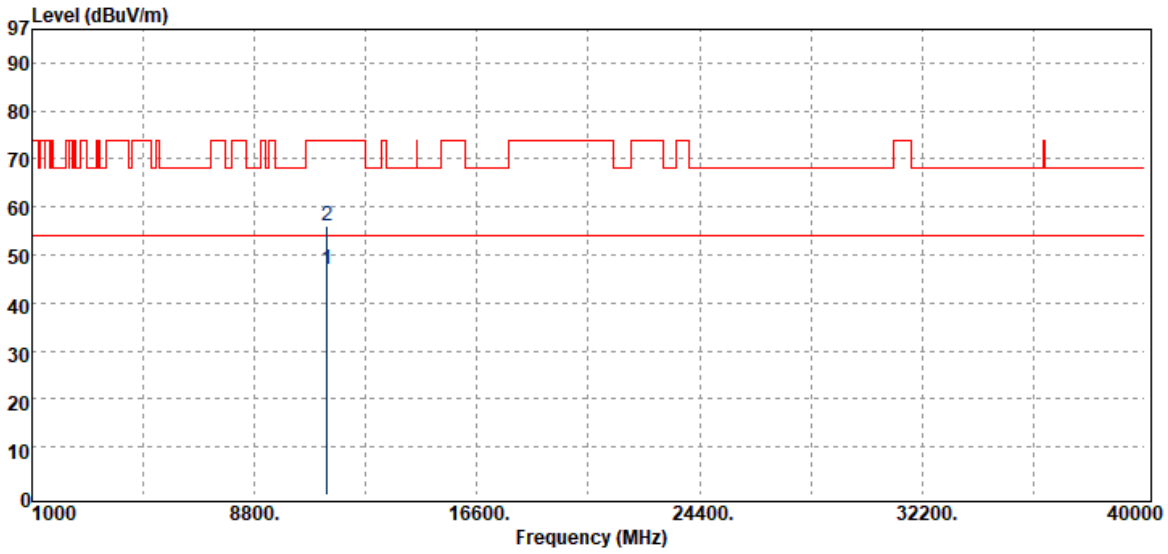

| Freq. MHz | Detector Mode PK/QP/AV | Spectrum Reading Level dB μ V | Factor dB | Actual FS dB μ V/m | Limit @3m dB μ V/m | Margin dB |
|--------------|------------------------------|---|--------------|------------------------------|------------------------------|--------------|
| 11340.00 | Average | 24.70 | 22.19 | 46.89 | 54.00 | -7.11 |
| 11340.00 | Peak | 33.95 | 22.19 | 56.14 | 74.00 | -17.86 |

Unless otherwise stated the results shown in this test report refer only to the sample(s) tested and such sample(s) are retained for 90 days only.

除非另有說明，此報告結果僅對測試之樣品負責，同時此樣品僅保留90天。本報告未經本公司書面許可，不可部份複製。

This document is issued by the Company subject to its General Conditions of Service printed overleaf, available on request or accessible at <http://www.sgs.com.tw/Terms-and-Conditions> and for electronic format documents, subject to Terms and Conditions for Electronic Documents at <http://www.sgs.com.tw/Terms-and-Conditions>. Attention is drawn to the limitation of liability, indemnification and jurisdiction issues defined therein. Any holder of this document is advised that information contained hereon reflects the Company's findings at the time of its intervention only and within the limits of Client's instructions, if any. The Company's sole responsibility is to its Client and this document does not exonerate parties to a transaction from exercising all their rights and obligations under the transaction documents. This document cannot be reproduced except in full, without prior written approval of the Company. Any unauthorized alteration, forgery or falsification of the content or appearance of this document is unlawful and offenders may be prosecuted to the fullest extent of the law.

Report Number :ER-2021-20085
 Operation Mode :802.11n40
 Test Frequency :5710 MHz
 Test Mode :Tx CH High
 EUT Pol :H Plane

Test Site :SAC III Chamber
 Test Date :2021-03-16
 Temp./Humi. :22.7/63
 Antenna Pol. :VERTICAL
 Engineer :Ricky

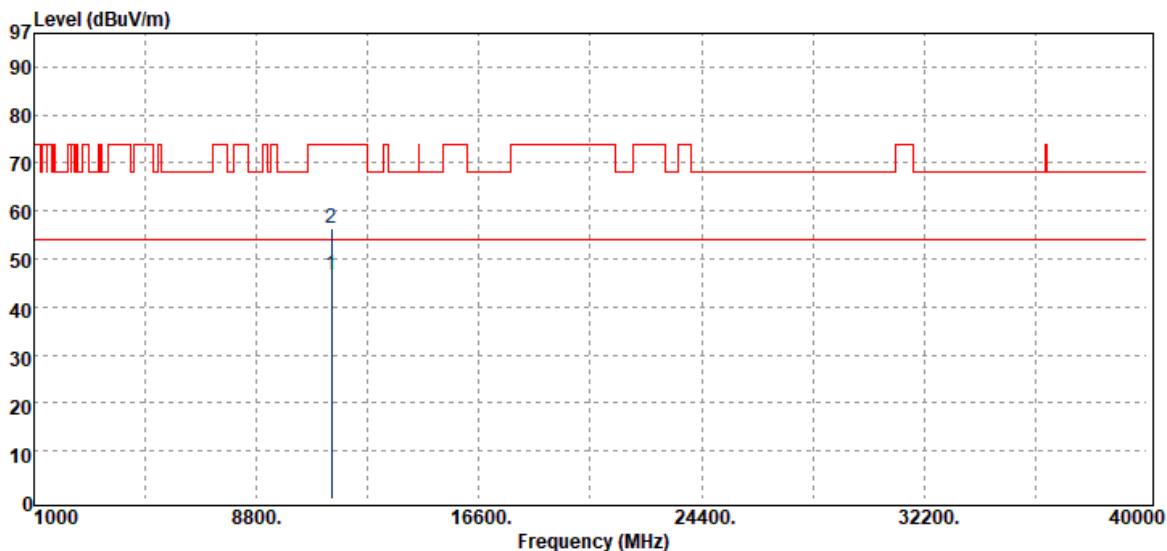

| Freq. MHz | Detector Mode PK/QP/AV | Spectrum Reading Level dB μ V | Factor dB | Actual FS dB μ V/m | Limit @3m dB μ V/m | Margin dB |
|--------------|------------------------------|---|--------------|------------------------------|------------------------------|--------------|
| 11420.00 | Average | 24.36 | 22.13 | 46.49 | 54.00 | -7.51 |
| 11420.00 | Peak | 34.19 | 22.13 | 56.32 | 74.00 | -17.68 |

Unless otherwise stated the results shown in this test report refer only to the sample(s) tested and such sample(s) are retained for 90 days only.

除非另有說明，此報告結果僅對測試之樣品負責，同時此樣品僅保留90天。本報告未經本公司書面許可，不可部份複製。

This document is issued by the Company subject to its General Conditions of Service printed overleaf, available on request or accessible at <http://www.sgs.com.tw/Terms-and-Conditions> and for electronic format documents, subject to Terms and Conditions for Electronic Documents at <http://www.sgs.com.tw/Terms-and-Conditions>. Attention is drawn to the limitation of liability, indemnification and jurisdiction issues defined therein. Any holder of this document is advised that information contained hereon reflects the Company's findings at the time of its intervention only and within the limits of Client's instructions, if any. The Company's sole responsibility is to its Client and this document does not exonerate parties to a transaction from exercising all their rights and obligations under the transaction documents. This document cannot be reproduced except in full, without prior written approval of the Company. Any unauthorized alteration, forgery or falsification of the content or appearance of this document is unlawful and offenders may be prosecuted to the fullest extent of the law.

Report Number :ER-2021-20085
 Operation Mode :802.11n40
 Test Frequency :5710 MHz
 Test Mode :Tx CH High
 EUT Pol :H Plane

Test Site :SAC III Chamber
 Test Date :2021-03-16
 Temp./Humi. :22.7/63
 Antenna Pol. :HORIZONTAL
 Engineer :Ricky

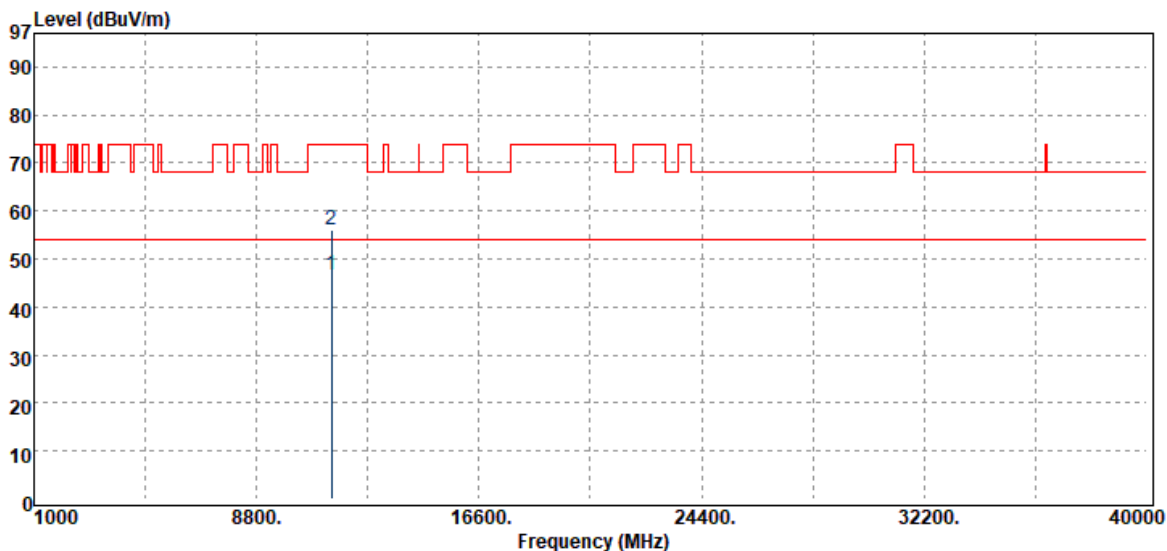

| Freq. MHz | Detector Mode PK/QP/AV | Spectrum Reading Level dB μ V | Factor dB | Actual FS dB μ V/m | Limit @3m dB μ V/m | Margin dB |
|--------------|------------------------------|---|--------------|------------------------------|------------------------------|--------------|
| 11420.00 | Average | 24.45 | 22.13 | 46.58 | 54.00 | -7.42 |
| 11420.00 | Peak | 33.78 | 22.13 | 55.91 | 74.00 | -18.09 |

Unless otherwise stated the results shown in this test report refer only to the sample(s) tested and such sample(s) are retained for 90 days only.

除非另有說明，此報告結果僅對測試之樣品負責，同時此樣品僅保留90天。本報告未經本公司書面許可，不可部份複製。

This document is issued by the Company subject to its General Conditions of Service printed overleaf, available on request or accessible at <http://www.sgs.com.tw/Terms-and-Conditions> and for electronic format documents, subject to Terms and Conditions for Electronic Documents at <http://www.sgs.com.tw/Terms-and-Conditions>. Attention is drawn to the limitation of liability, indemnification and jurisdiction issues defined therein. Any holder of this document is advised that information contained hereon reflects the Company's findings at the time of its intervention only and within the limits of Client's instructions, if any. The Company's sole responsibility is to its Client and this document does not exonerate parties to a transaction from exercising all their rights and obligations under the transaction documents. This document cannot be reproduced except in full, without prior written approval of the Company. Any unauthorized alteration, forgery or falsification of the content or appearance of this document is unlawful and offenders may be prosecuted to the fullest extent of the law.

Report Number :ER-2021-20085
 Operation Mode :802.11n40
 Test Frequency :5755 MHz
 Test Mode :Tx CH Low
 EUT Pol :H Plane

Test Site :SAC III Chamber
 Test Date :2021-03-16
 Temp./Humi. :22.7/63
 Antenna Pol. :VERTICAL
 Engineer :Ricky

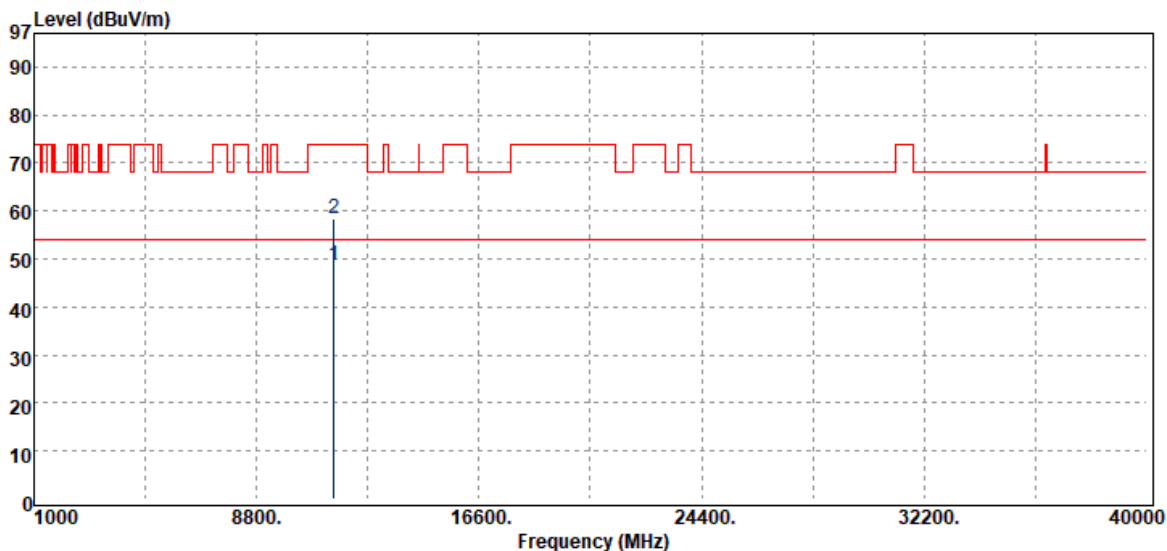

| Freq. MHz | Detector Mode PK/QP/AV | Spectrum Reading Level dB μ V | Factor dB | Actual FS dB μ V/m | Limit @3m dB μ V/m | Margin dB |
|--------------|------------------------------|---|--------------|------------------------------|------------------------------|--------------|
| 11510.00 | Average | 24.25 | 24.31 | 48.56 | 54.00 | -5.44 |
| 11510.00 | Peak | 34.02 | 24.31 | 58.33 | 74.00 | -15.67 |

Unless otherwise stated the results shown in this test report refer only to the sample(s) tested and such sample(s) are retained for 90 days only.

除非另有說明，此報告結果僅對測試之樣品負責，同時此樣品僅保留90天。本報告未經本公司書面許可，不可部份複製。

This document is issued by the Company subject to its General Conditions of Service printed overleaf, available on request or accessible at <http://www.sgs.com.tw/Terms-and-Conditions> and for electronic format documents, subject to Terms and Conditions for Electronic Documents at <http://www.sgs.com.tw/Terms-and-Conditions>. Attention is drawn to the limitation of liability, indemnification and jurisdiction issues defined therein. Any holder of this document is advised that information contained hereon reflects the Company's findings at the time of its intervention only and within the limits of Client's instructions, if any. The Company's sole responsibility is to its Client and this document does not exonerate parties to a transaction from exercising all their rights and obligations under the transaction documents. This document cannot be reproduced except in full, without prior written approval of the Company. Any unauthorized alteration, forgery or falsification of the content or appearance of this document is unlawful and offenders may be prosecuted to the fullest extent of the law.

Report Number :ER-2021-20085
 Operation Mode :802.11n40
 Test Frequency :5755 MHz
 Test Mode :Tx CH Low
 EUT Pol :H Plane

Test Site :SAC III Chamber
 Test Date :2021-03-16
 Temp./Humi. :22.7/63
 Antenna Pol. :HORIZONTAL
 Engineer :Ricky

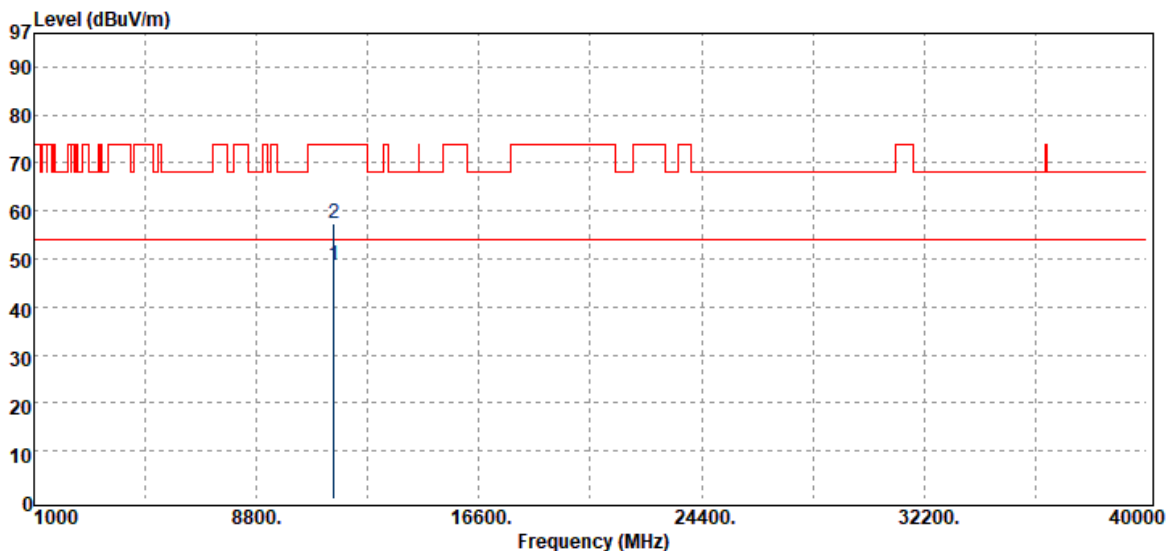

| Freq. MHz | Detector Mode PK/QP/AV | Spectrum Reading Level dB μ V | Factor dB | Actual FS dB μ V/m | Limit @3m dB μ V/m | Margin dB |
|--------------|------------------------------|---|--------------|------------------------------|------------------------------|--------------|
| 11510.00 | Average | 24.19 | 24.31 | 48.50 | 54.00 | -5.50 |
| 11510.00 | Peak | 32.95 | 24.31 | 57.26 | 74.00 | -16.74 |

Unless otherwise stated the results shown in this test report refer only to the sample(s) tested and such sample(s) are retained for 90 days only.

除非另有說明，此報告結果僅對測試之樣品負責，同時此樣品僅保留90天。本報告未經本公司書面許可，不可部份複製。

This document is issued by the Company subject to its General Conditions of Service printed overleaf, available on request or accessible at <http://www.sgs.com.tw/Terms-and-Conditions> and for electronic format documents, subject to Terms and Conditions for Electronic Documents at <http://www.sgs.com.tw/Terms-and-Conditions>. Attention is drawn to the limitation of liability, indemnification and jurisdiction issues defined therein. Any holder of this document is advised that information contained hereon reflects the Company's findings at the time of its intervention only and within the limits of Client's instructions, if any. The Company's sole responsibility is to its Client and this document does not exonerate parties to a transaction from exercising all their rights and obligations under the transaction documents. This document cannot be reproduced except in full, without prior written approval of the Company. Any unauthorized alteration, forgery or falsification of the content or appearance of this document is unlawful and offenders may be prosecuted to the fullest extent of the law.

Report Number :ER-2021-20085
 Operation Mode :802.11n40
 Test Frequency :5795 MHz
 Test Mode :Tx CH High
 EUT Pol :H Plane

Test Site :SAC III Chamber
 Test Date :2021-03-16
 Temp./Humi. :22.7/63
 Antenna Pol. :VERTICAL
 Engineer :Ricky

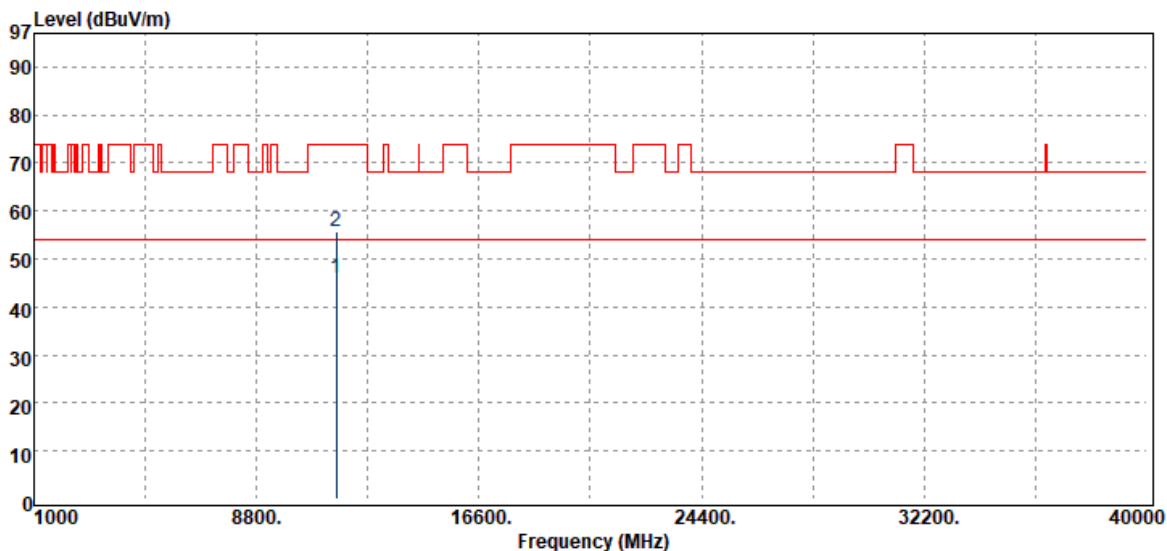

| Freq. MHz | Detector Mode PK/QP/AV | Spectrum Reading Level dB μ V | Factor dB | Actual FS dB μ V/m | Limit @3m dB μ V/m | Margin dB |
|--------------|------------------------------|---|--------------|------------------------------|------------------------------|--------------|
| 11590.00 | Average | 24.90 | 21.17 | 46.07 | 54.00 | -7.93 |
| 11590.00 | Peak | 34.64 | 21.17 | 55.81 | 74.00 | -18.19 |

Unless otherwise stated the results shown in this test report refer only to the sample(s) tested and such sample(s) are retained for 90 days only.

除非另有說明，此報告結果僅對測試之樣品負責，同時此樣品僅保留90天。本報告未經本公司書面許可，不可部份複製。

This document is issued by the Company subject to its General Conditions of Service printed overleaf, available on request or accessible at <http://www.sgs.com.tw/Terms-and-Conditions> and for electronic format documents, subject to Terms and Conditions for Electronic Documents at <http://www.sgs.com.tw/Terms-and-Conditions>. Attention is drawn to the limitation of liability, indemnification and jurisdiction issues defined therein. Any holder of this document is advised that information contained hereon reflects the Company's findings at the time of its intervention only and within the limits of Client's instructions, if any. The Company's sole responsibility is to its Client and this document does not exonerate parties to a transaction from exercising all their rights and obligations under the transaction documents. This document cannot be reproduced except in full, without prior written approval of the Company. Any unauthorized alteration, forgery or falsification of the content or appearance of this document is unlawful and offenders may be prosecuted to the fullest extent of the law.

Report Number :ER-2021-20085
 Operation Mode :802.11n40
 Test Frequency :5795 MHz
 Test Mode :Tx CH High
 EUT Pol :H Plane

Test Site :SAC III Chamber
 Test Date :2021-03-16
 Temp./Humi. :22.7/63
 Antenna Pol. :HORIZONTAL
 Engineer :Ricky

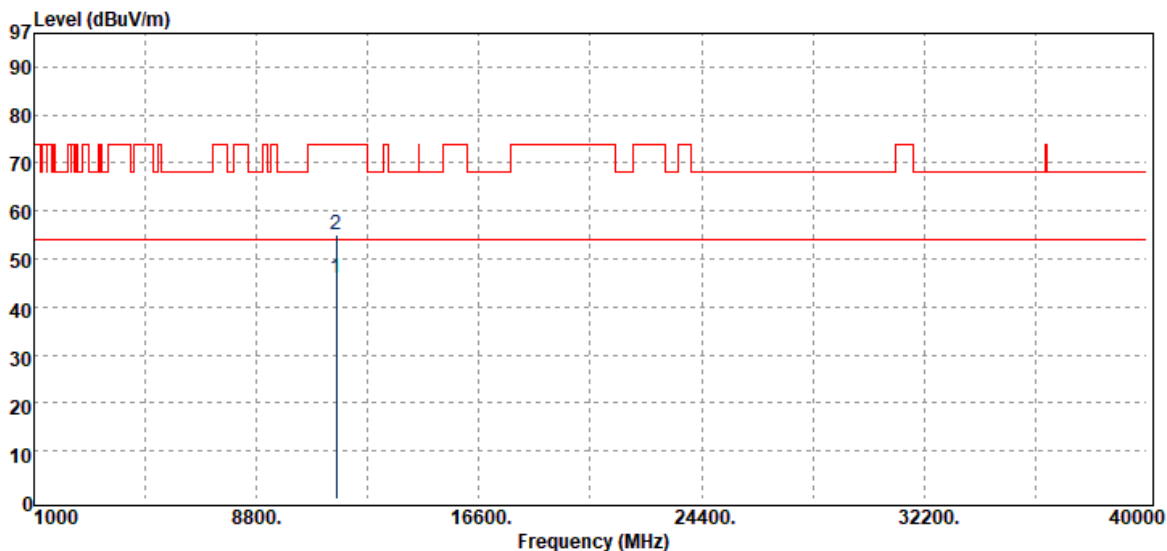

| Freq. MHz | Detector Mode PK/QP/AV | Spectrum Reading Level dB μ V | Factor dB | Actual FS dB μ V/m | Limit @3m dB μ V/m | Margin dB |
|--------------|------------------------------|---|--------------|------------------------------|------------------------------|--------------|
| 11590.00 | Average | 24.93 | 21.17 | 46.10 | 54.00 | -7.90 |
| 11590.00 | Peak | 33.93 | 21.17 | 55.10 | 74.00 | -18.90 |

Unless otherwise stated the results shown in this test report refer only to the sample(s) tested and such sample(s) are retained for 90 days only.

除非另有說明，此報告結果僅對測試之樣品負責，同時此樣品僅保留90天。本報告未經本公司書面許可，不可部份複製。

This document is issued by the Company subject to its General Conditions of Service printed overleaf, available on request or accessible at <http://www.sgs.com.tw/Terms-and-Conditions> and for electronic format documents, subject to Terms and Conditions for Electronic Documents at <http://www.sgs.com.tw/Terms-and-Conditions>. Attention is drawn to the limitation of liability, indemnification and jurisdiction issues defined therein. Any holder of this document is advised that information contained hereon reflects the Company's findings at the time of its intervention only and within the limits of Client's instructions, if any. The Company's sole responsibility is to its Client and this document does not exonerate parties to a transaction from exercising all their rights and obligations under the transaction documents. This document cannot be reproduced except in full, without prior written approval of the Company. Any unauthorized alteration, forgery or falsification of the content or appearance of this document is unlawful and offenders may be prosecuted to the fullest extent of the law.

Report Number :ER-2021-20085
 Operation Mode :802.11ac80
 Test Frequency :5210 MHz
 Test Mode :Tx CH Low
 EUT Pol :H Plane

Test Site :SAC III Chamber
 Test Date :2021-03-17
 Temp./Humi. :22.8/65
 Antenna Pol. :VERTICAL
 Engineer :Ricky

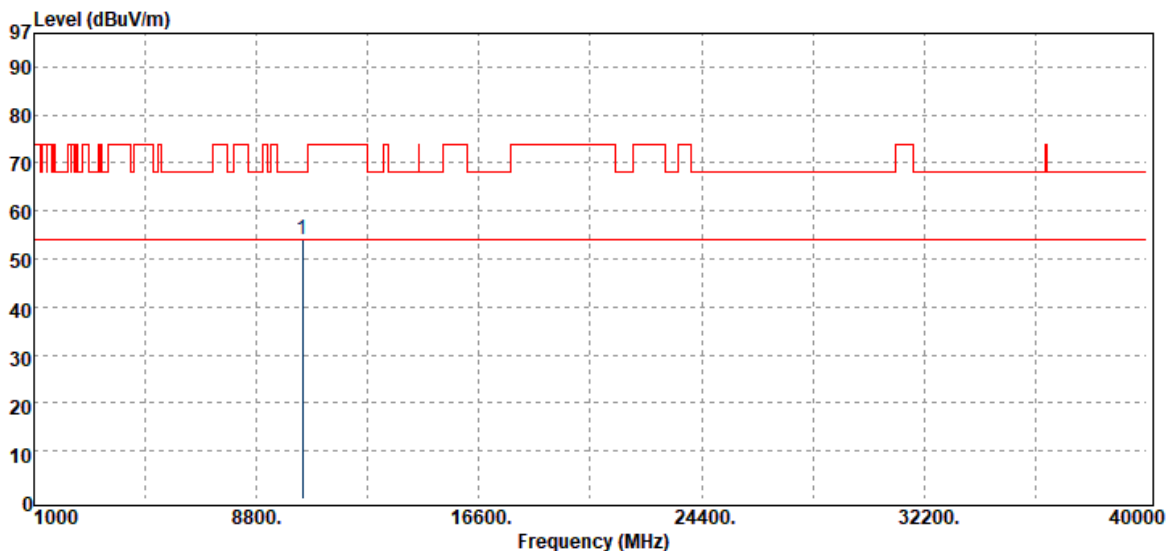

| Freq. MHz | Detector Mode PK/QP/AV | Spectrum Reading Level dB μ V | Factor dB | Actual FS dB μ V/m | Limit @3m dB μ V/m | Margin dB |
|--------------|------------------------------|---|--------------|------------------------------|------------------------------|--------------|
| 10420.00 | Peak | 34.85 | 19.35 | 54.20 | 68.20 | -14.00 |

Unless otherwise stated the results shown in this test report refer only to the sample(s) tested and such sample(s) are retained for 90 days only.

除非另有說明，此報告結果僅對測試之樣品負責，同時此樣品僅保留90天。本報告未經本公司書面許可，不可部份複製。

This document is issued by the Company subject to its General Conditions of Service printed overleaf, available on request or accessible at <http://www.sgs.com.tw/Terms-and-Conditions> and for electronic format documents, subject to Terms and Conditions for Electronic Documents at <http://www.sgs.com.tw/Terms-and-Conditions>. Attention is drawn to the limitation of liability, indemnification and jurisdiction issues defined therein. Any holder of this document is advised that information contained hereon reflects the Company's findings at the time of its intervention only and within the limits of Client's instructions, if any. The Company's sole responsibility is to its Client and this document does not exonerate parties to a transaction from exercising all their rights and obligations under the transaction documents. This document cannot be reproduced except in full, without prior written approval of the Company. Any unauthorized alteration, forgery or falsification of the content or appearance of this document is unlawful and offenders may be prosecuted to the fullest extent of the law.

Report Number :ER-2021-20085
 Operation Mode :802.11ac80
 Test Frequency :5210 MHz
 Test Mode :Tx CH Low
 EUT Pol :H Plane

Test Site :SAC III Chamber
 Test Date :2021-03-17
 Temp./Humi. :22.8/65
 Antenna Pol. :HORIZONTAL
 Engineer :Ricky

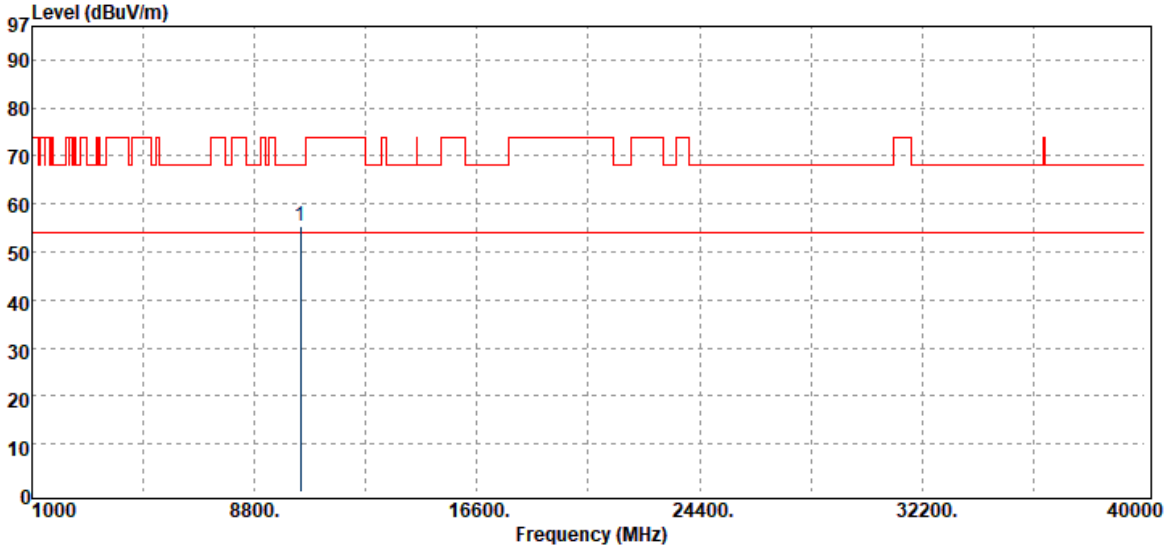

| Freq. MHz | Detector Mode PK/QP/AV | Spectrum Reading Level dB μ V | Factor dB | Actual FS dB μ V/m | Limit @3m dB μ V/m | Margin dB |
|--------------|------------------------------|---|--------------|------------------------------|------------------------------|--------------|
| 10420.00 | Peak | 35.89 | 19.35 | 55.24 | 68.20 | -12.96 |

Unless otherwise stated the results shown in this test report refer only to the sample(s) tested and such sample(s) are retained for 90 days only.

除非另有說明，此報告結果僅對測試之樣品負責，同時此樣品僅保留90天。本報告未經本公司書面許可，不可部份複製。

This document is issued by the Company subject to its General Conditions of Service printed overleaf, available on request or accessible at <http://www.sgs.com.tw/Terms-and-Conditions> and for electronic format documents, subject to Terms and Conditions for Electronic Documents at <http://www.sgs.com.tw/Terms-and-Conditions>. Attention is drawn to the limitation of liability, indemnification and jurisdiction issues defined therein. Any holder of this document is advised that information contained hereon reflects the Company's findings at the time of its intervention only and within the limits of Client's instructions, if any. The Company's sole responsibility is to its Client and this document does not exonerate parties to a transaction from exercising all their rights and obligations under the transaction documents. This document cannot be reproduced except in full, without prior written approval of the Company. Any unauthorized alteration, forgery or falsification of the content or appearance of this document is unlawful and offenders may be prosecuted to the fullest extent of the law.

Report Number :ER-2021-20085
 Operation Mode :802.11ac80
 Test Frequency :5290 MHz
 Test Mode :Tx CH Low
 EUT Pol :H Plane

Test Site :SAC III Chamber
 Test Date :2021-03-17
 Temp./Humi. :22.8/65
 Antenna Pol. :VERTICAL
 Engineer :Ricky

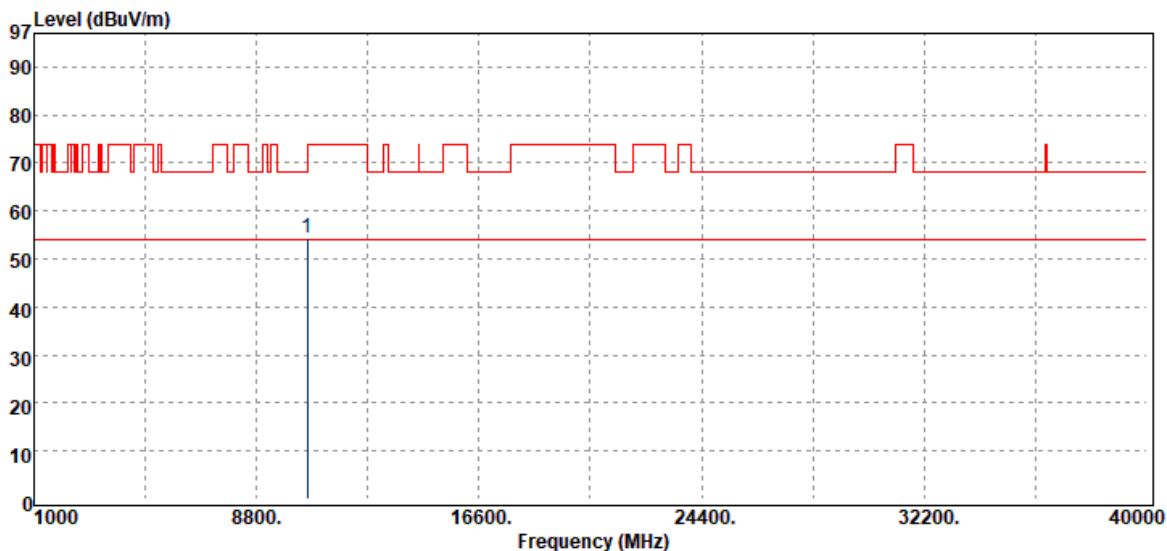

| Freq. MHz | Detector Mode PK/QP/AV | Spectrum Reading Level dB μ V | Factor dB | Actual FS dB μ V/m | Limit @3m dB μ V/m | Margin dB |
|--------------|------------------------------|---|--------------|------------------------------|------------------------------|--------------|
| 10580.00 | Peak | 34.53 | 19.82 | 54.35 | 68.20 | -13.85 |

Unless otherwise stated the results shown in this test report refer only to the sample(s) tested and such sample(s) are retained for 90 days only.

除非另有說明，此報告結果僅對測試之樣品負責，同時此樣品僅保留90天。本報告未經本公司書面許可，不可部份複製。

This document is issued by the Company subject to its General Conditions of Service printed overleaf, available on request or accessible at <http://www.sgs.com.tw/Terms-and-Conditions> and for electronic format documents, subject to Terms and Conditions for Electronic Documents at <http://www.sgs.com.tw/Terms-and-Conditions>. Attention is drawn to the limitation of liability, indemnification and jurisdiction issues defined therein. Any holder of this document is advised that information contained hereon reflects the Company's findings at the time of its intervention only and within the limits of Client's instructions, if any. The Company's sole responsibility is to its Client and this document does not exonerate parties to a transaction from exercising all their rights and obligations under the transaction documents. This document cannot be reproduced except in full, without prior written approval of the Company. Any unauthorized alteration, forgery or falsification of the content or appearance of this document is unlawful and offenders may be prosecuted to the fullest extent of the law.

Report Number :ER-2021-20085
 Operation Mode :802.11ac80
 Test Frequency :5290 MHz
 Test Mode :Tx CH Low
 EUT Pol :H Plane

Test Site :SAC III Chamber
 Test Date :2021-03-17
 Temp./Humi. :22.8/65
 Antenna Pol. :HORIZONTAL
 Engineer :Ricky

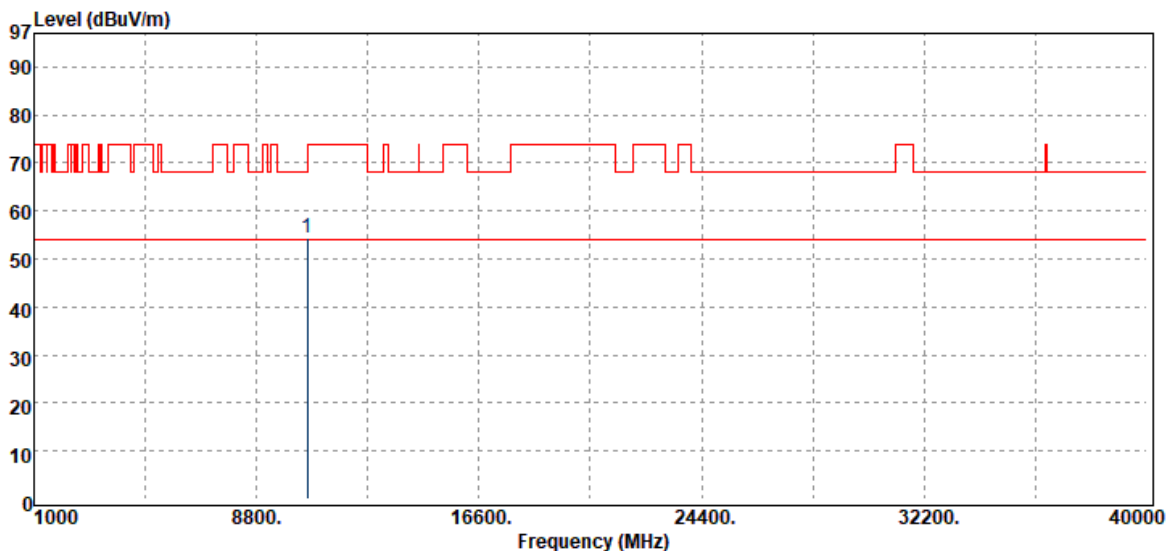

| Freq. MHz | Detector Mode PK/QP/AV | Spectrum Reading Level dB μ V | Factor dB | Actual FS dB μ V/m | Limit @3m dB μ V/m | Margin dB |
|--------------|------------------------------|---|--------------|------------------------------|------------------------------|--------------|
| 10580.00 | Peak | 34.52 | 19.82 | 54.34 | 68.20 | -13.86 |

Unless otherwise stated the results shown in this test report refer only to the sample(s) tested and such sample(s) are retained for 90 days only.

除非另有說明，此報告結果僅對測試之樣品負責，同時此樣品僅保留90天。本報告未經本公司書面許可，不可部份複製。

This document is issued by the Company subject to its General Conditions of Service printed overleaf, available on request or accessible at <http://www.sgs.com.tw/Terms-and-Conditions> and for electronic format documents, subject to Terms and Conditions for Electronic Documents at <http://www.sgs.com.tw/Terms-and-Conditions>. Attention is drawn to the limitation of liability, indemnification and jurisdiction issues defined therein. Any holder of this document is advised that information contained hereon reflects the Company's findings at the time of its intervention only and within the limits of Client's instructions, if any. The Company's sole responsibility is to its Client and this document does not exonerate parties to a transaction from exercising all their rights and obligations under the transaction documents. This document cannot be reproduced except in full, without prior written approval of the Company. Any unauthorized alteration, forgery or falsification of the content or appearance of this document is unlawful and offenders may be prosecuted to the fullest extent of the law.

Report Number :ER-2021-20085
 Operation Mode :802.11ac80
 Test Frequency :5530 MHz
 Test Mode :Tx CH Low
 EUT Pol :H Plane

Test Site :SAC III Chamber
 Test Date :2021-03-17
 Temp./Humi. :22.8/65
 Antenna Pol. :VERTICAL
 Engineer :Ricky

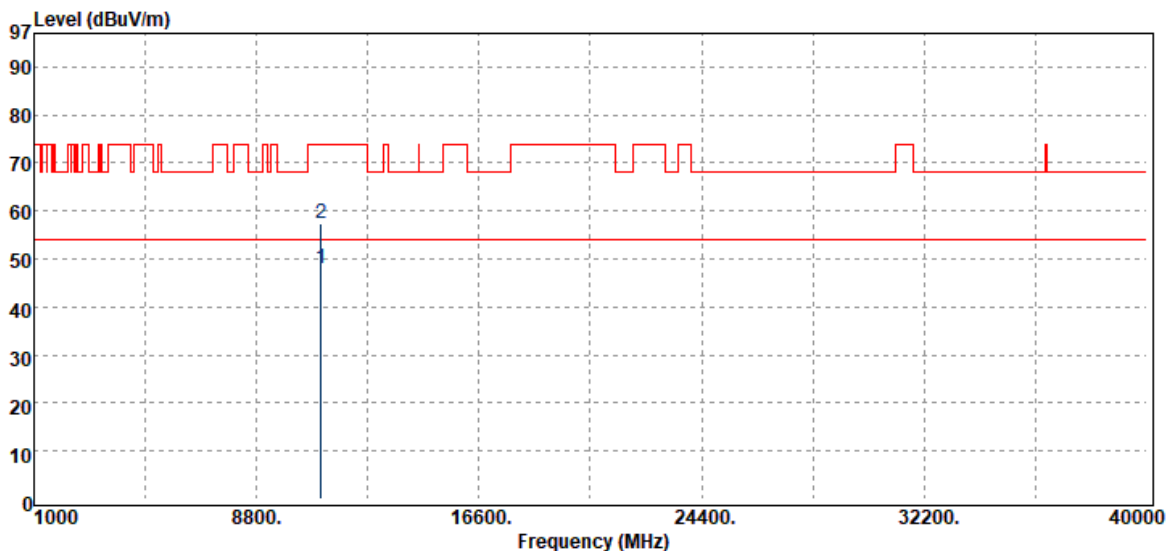

| Freq. MHz | Detector Mode PK/QP/AV | Spectrum Reading Level dB μ V | Factor dB | Actual FS dB μ V/m | Limit @3m dB μ V/m | Margin dB |
|--------------|------------------------------|---|--------------|------------------------------|------------------------------|--------------|
| 11060.00 | Average | 25.37 | 22.71 | 48.08 | 54.00 | -5.92 |
| 11060.00 | Peak | 34.73 | 22.71 | 57.44 | 74.00 | -16.56 |

Unless otherwise stated the results shown in this test report refer only to the sample(s) tested and such sample(s) are retained for 90 days only.

除非另有說明，此報告結果僅對測試之樣品負責，同時此樣品僅保留90天。本報告未經本公司書面許可，不可部份複製。

This document is issued by the Company subject to its General Conditions of Service printed overleaf, available on request or accessible at <http://www.sgs.com.tw/Terms-and-Conditions> and for electronic format documents, subject to Terms and Conditions for Electronic Documents at <http://www.sgs.com.tw/Terms-and-Conditions>. Attention is drawn to the limitation of liability, indemnification and jurisdiction issues defined therein. Any holder of this document is advised that information contained hereon reflects the Company's findings at the time of its intervention only and within the limits of Client's instructions, if any. The Company's sole responsibility is to its Client and this document does not exonerate parties to a transaction from exercising all their rights and obligations under the transaction documents. This document cannot be reproduced except in full, without prior written approval of the Company. Any unauthorized alteration, forgery or falsification of the content or appearance of this document is unlawful and offenders may be prosecuted to the fullest extent of the law.

Report Number :ER-2021-20085
 Operation Mode :802.11ac80
 Test Frequency :5530 MHz
 Test Mode :Tx CH Low
 EUT Pol :H Plane

Test Site :SAC III Chamber
 Test Date :2021-03-17
 Temp./Humi. :22.8/65
 Antenna Pol. :HORIZONTAL
 Engineer :Ricky

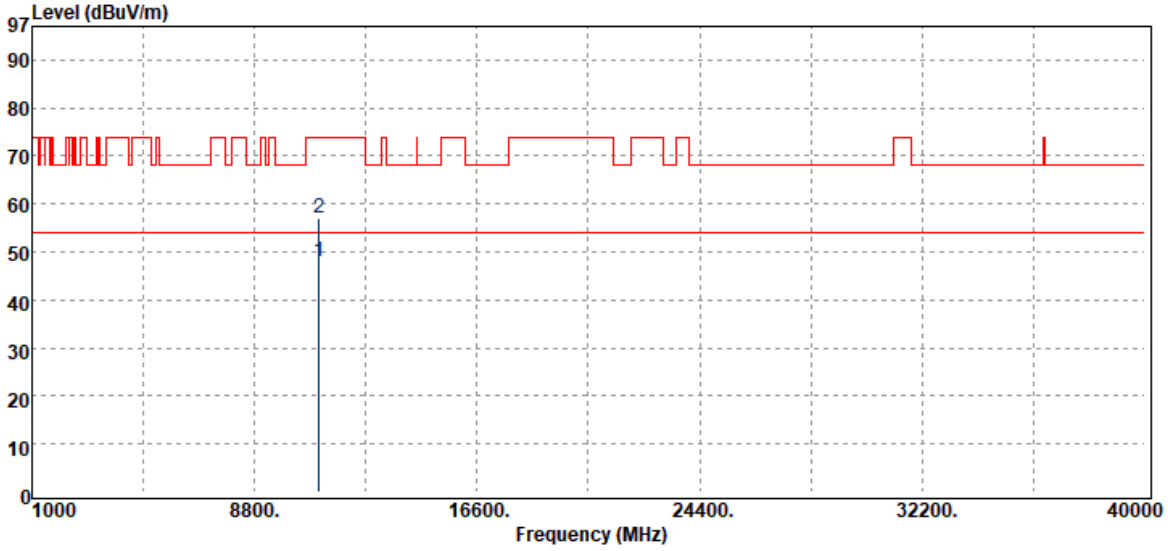

| Freq. MHz | Detector Mode PK/QP/AV | Spectrum Reading Level dB μ V | Factor dB | Actual FS dB μ V/m | Limit @3m dB μ V/m | Margin dB |
|--------------|------------------------------|---|--------------|------------------------------|------------------------------|--------------|
| 11060.00 | Average | 25.21 | 22.71 | 47.92 | 54.00 | -6.08 |
| 11060.00 | Peak | 34.29 | 22.71 | 57.00 | 74.00 | -17.00 |

Unless otherwise stated the results shown in this test report refer only to the sample(s) tested and such sample(s) are retained for 90 days only.

除非另有說明，此報告結果僅對測試之樣品負責，同時此樣品僅保留90天。本報告未經本公司書面許可，不可部份複製。

This document is issued by the Company subject to its General Conditions of Service printed overleaf, available on request or accessible at <http://www.sgs.com.tw/Terms-and-Conditions> and for electronic format documents, subject to Terms and Conditions for Electronic Documents at <http://www.sgs.com.tw/Terms-and-Conditions>. Attention is drawn to the limitation of liability, indemnification and jurisdiction issues defined therein. Any holder of this document is advised that information contained hereon reflects the Company's findings at the time of its intervention only and within the limits of Client's instructions, if any. The Company's sole responsibility is to its Client and this document does not exonerate parties to a transaction from exercising all their rights and obligations under the transaction documents. This document cannot be reproduced except in full, without prior written approval of the Company. Any unauthorized alteration, forgery or falsification of the content or appearance of this document is unlawful and offenders may be prosecuted to the fullest extent of the law.

Report Number :ER-2021-20085
 Operation Mode :802.11ac80
 Test Frequency :5610 MHz
 Test Mode :Tx CH Mid
 EUT Pol :H Plane

Test Site :SAC III Chamber
 Test Date :2021-03-17
 Temp./Humi. :22.8/65
 Antenna Pol. :VERTICAL
 Engineer :Ricky

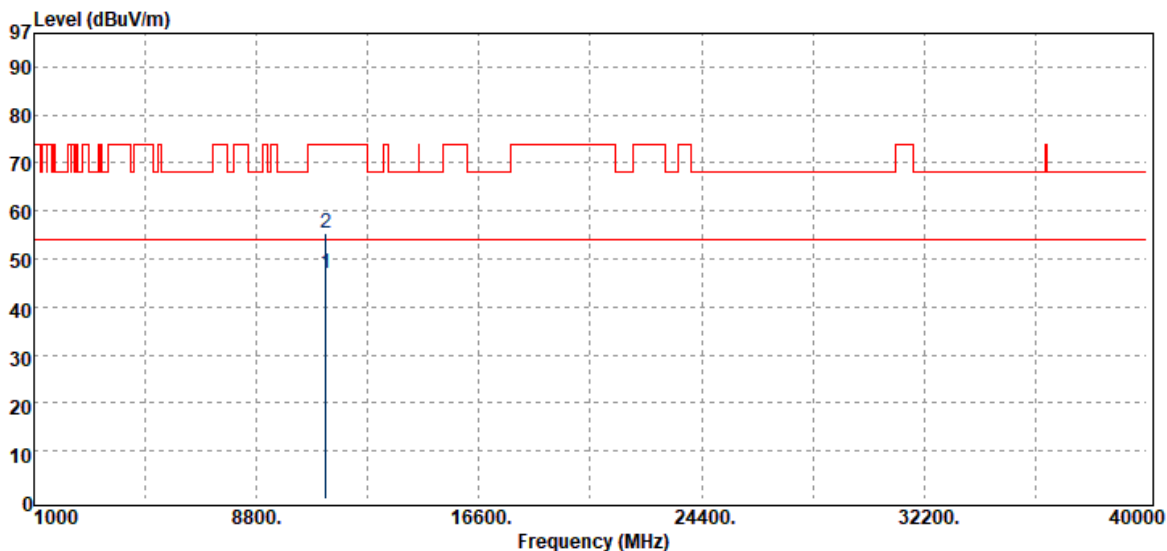

| Freq. MHz | Detector Mode PK/QP/AV | Spectrum Reading Level dB μ V | Factor dB | Actual FS dB μ V/m | Limit @3m dB μ V/m | Margin dB |
|--------------|------------------------------|---|--------------|------------------------------|------------------------------|--------------|
| 11220.00 | Average | 25.50 | 21.37 | 46.87 | 54.00 | -7.13 |
| 11220.00 | Peak | 34.04 | 21.37 | 55.41 | 74.00 | -18.59 |

Unless otherwise stated the results shown in this test report refer only to the sample(s) tested and such sample(s) are retained for 90 days only.

除非另有說明，此報告結果僅對測試之樣品負責，同時此樣品僅保留90天。本報告未經本公司書面許可，不可部份複製。

This document is issued by the Company subject to its General Conditions of Service printed overleaf, available on request or accessible at <http://www.sgs.com.tw/Terms-and-Conditions> and for electronic format documents, subject to Terms and Conditions for Electronic Documents at <http://www.sgs.com.tw/Terms-and-Conditions>. Attention is drawn to the limitation of liability, indemnification and jurisdiction issues defined therein. Any holder of this document is advised that information contained hereon reflects the Company's findings at the time of its intervention only and within the limits of Client's instructions, if any. The Company's sole responsibility is to its Client and this document does not exonerate parties to a transaction from exercising all their rights and obligations under the transaction documents. This document cannot be reproduced except in full, without prior written approval of the Company. Any unauthorized alteration, forgery or falsification of the content or appearance of this document is unlawful and offenders may be prosecuted to the fullest extent of the law.

Report Number :ER-2021-20085
 Operation Mode :802.11ac80
 Test Frequency :5610 MHz
 Test Mode :Tx CH Mid
 EUT Pol :H Plane

Test Site :SAC III Chamber
 Test Date :2021-03-17
 Temp./Humi. :22.8/65
 Antenna Pol. :HORIZONTAL
 Engineer :Ricky

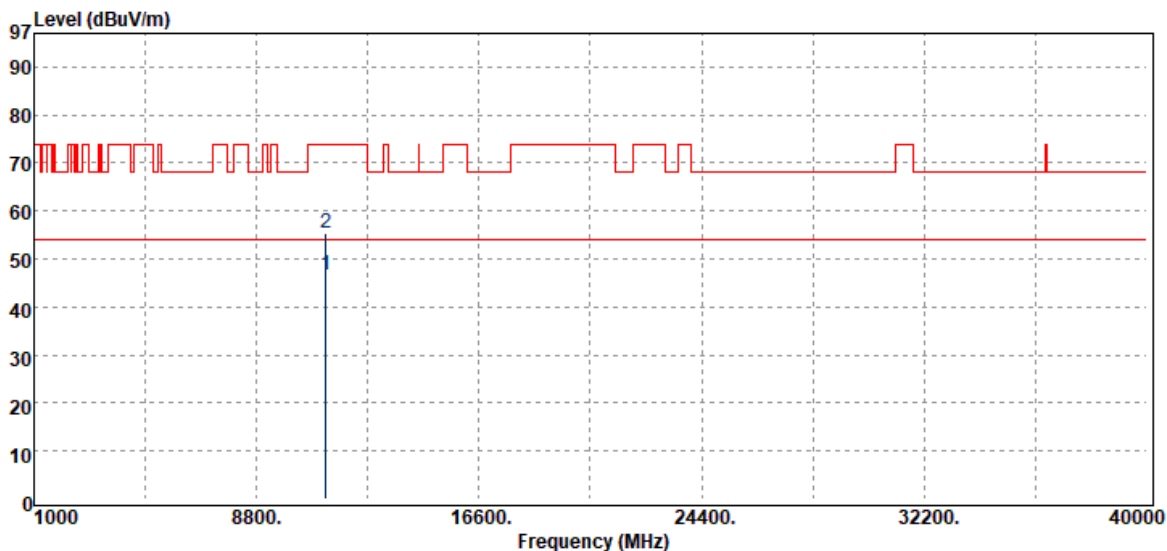

| Freq. MHz | Detector Mode PK/QP/AV | Spectrum Reading Level dB μ V | Factor dB | Actual FS dB μ V/m | Limit @3m dB μ V/m | Margin dB |
|--------------|------------------------------|---|--------------|------------------------------|------------------------------|--------------|
| 11220.00 | Average | 25.32 | 21.37 | 46.69 | 54.00 | -7.31 |
| 11220.00 | Peak | 33.87 | 21.37 | 55.24 | 74.00 | -18.76 |

Unless otherwise stated the results shown in this test report refer only to the sample(s) tested and such sample(s) are retained for 90 days only.

除非另有說明，此報告結果僅對測試之樣品負責，同時此樣品僅保留90天。本報告未經本公司書面許可，不可部份複製。

This document is issued by the Company subject to its General Conditions of Service printed overleaf, available on request or accessible at <http://www.sgs.com.tw/Terms-and-Conditions> and for electronic format documents, subject to Terms and Conditions for Electronic Documents at <http://www.sgs.com.tw/Terms-and-Conditions>. Attention is drawn to the limitation of liability, indemnification and jurisdiction issues defined therein. Any holder of this document is advised that information contained hereon reflects the Company's findings at the time of its intervention only and within the limits of Client's instructions, if any. The Company's sole responsibility is to its Client and this document does not exonerate parties to a transaction from exercising all their rights and obligations under the transaction documents. This document cannot be reproduced except in full, without prior written approval of the Company. Any unauthorized alteration, forgery or falsification of the content or appearance of this document is unlawful and offenders may be prosecuted to the fullest extent of the law.

Report Number :ER-2021-20085
 Operation Mode :802.11ac80
 Test Frequency :5690 MHz
 Test Mode :Tx CH High
 EUT Pol :H Plane

Test Site :SAC III Chamber
 Test Date :2021-03-17
 Temp./Humi. :22.8/65
 Antenna Pol. :VERTICAL
 Engineer :Ricky

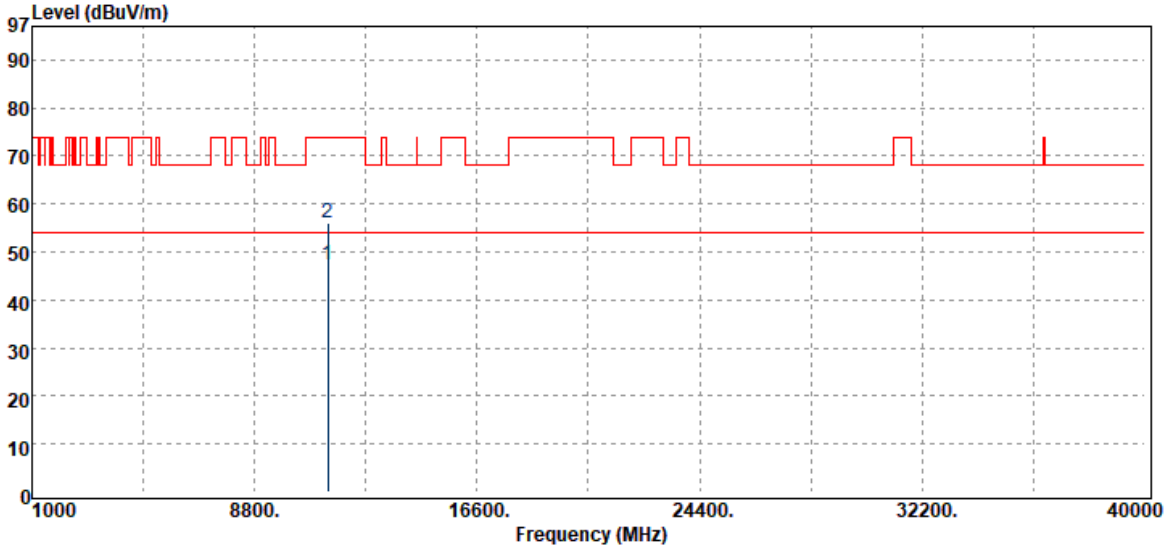

| Freq. MHz | Detector Mode PK/QP/AV | Spectrum Reading Level dB μ V | Factor dB | Actual FS dB μ V/m | Limit @3m dB μ V/m | Margin dB |
|--------------|------------------------------|---|--------------|------------------------------|------------------------------|--------------|
| 11380.00 | Average | 25.39 | 21.81 | 47.20 | 54.00 | -6.80 |
| 11380.00 | Peak | 34.20 | 21.81 | 56.01 | 74.00 | -17.99 |

Unless otherwise stated the results shown in this test report refer only to the sample(s) tested and such sample(s) are retained for 90 days only.

除非另有說明，此報告結果僅對測試之樣品負責，同時此樣品僅保留90天。本報告未經本公司書面許可，不可部份複製。

This document is issued by the Company subject to its General Conditions of Service printed overleaf, available on request or accessible at <http://www.sgs.com.tw/Terms-and-Conditions> and for electronic format documents, subject to Terms and Conditions for Electronic Documents at <http://www.sgs.com.tw/Terms-and-Conditions>. Attention is drawn to the limitation of liability, indemnification and jurisdiction issues defined therein. Any holder of this document is advised that information contained hereon reflects the Company's findings at the time of its intervention only and within the limits of Client's instructions, if any. The Company's sole responsibility is to its Client and this document does not exonerate parties to a transaction from exercising all their rights and obligations under the transaction documents. This document cannot be reproduced except in full, without prior written approval of the Company. Any unauthorized alteration, forgery or falsification of the content or appearance of this document is unlawful and offenders may be prosecuted to the fullest extent of the law.

Report Number :ER-2021-20085
 Operation Mode :802.11ac80
 Test Frequency :5690 MHz
 Test Mode :Tx CH High
 EUT Pol :H Plane

Test Site :SAC III Chamber
 Test Date :2021-03-17
 Temp./Humi. :22.8/65
 Antenna Pol. :HORIZONTAL
 Engineer :Ricky

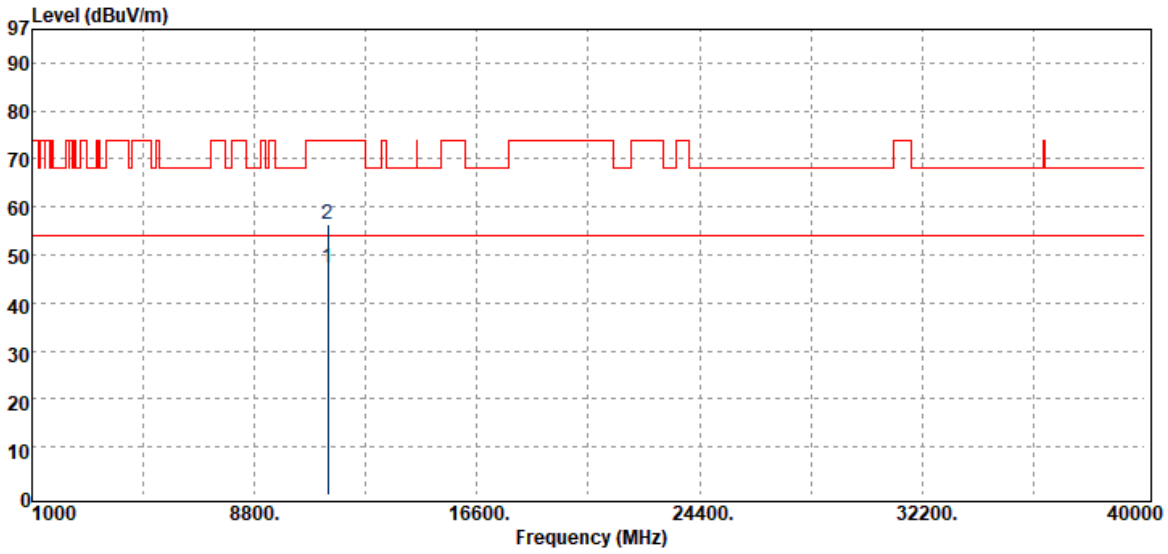

| Freq. MHz | Detector Mode PK/QP/AV | Spectrum Reading Level dB μ V | Factor dB | Actual FS dB μ V/m | Limit @3m dB μ V/m | Margin dB |
|--------------|------------------------------|---|--------------|------------------------------|------------------------------|--------------|
| 11380.00 | Average | 25.37 | 21.81 | 47.18 | 54.00 | -6.82 |
| 11380.00 | Peak | 34.42 | 21.81 | 56.23 | 74.00 | -17.77 |

Unless otherwise stated the results shown in this test report refer only to the sample(s) tested and such sample(s) are retained for 90 days only.

除非另有說明，此報告結果僅對測試之樣品負責，同時此樣品僅保留90天。本報告未經本公司書面許可，不可部份複製。

This document is issued by the Company subject to its General Conditions of Service printed overleaf, available on request or accessible at <http://www.sgs.com.tw/Terms-and-Conditions> and for electronic format documents, subject to Terms and Conditions for Electronic Documents at <http://www.sgs.com.tw/Terms-and-Conditions>. Attention is drawn to the limitation of liability, indemnification and jurisdiction issues defined therein. Any holder of this document is advised that information contained hereon reflects the Company's findings at the time of its intervention only and within the limits of Client's instructions, if any. The Company's sole responsibility is to its Client and this document does not exonerate parties to a transaction from exercising all their rights and obligations under the transaction documents. This document cannot be reproduced except in full, without prior written approval of the Company. Any unauthorized alteration, forgery or falsification of the content or appearance of this document is unlawful and offenders may be prosecuted to the fullest extent of the law.

Report Number :ER-2021-20085
 Operation Mode :802.11ac80
 Test Frequency :5775 MHz
 Test Mode :Tx CH Low
 EUT Pol :H Plane

Test Site :SAC III Chamber
 Test Date :2021-03-17
 Temp./Humi. :22.8/65
 Antenna Pol. :VERTICAL
 Engineer :Ricky

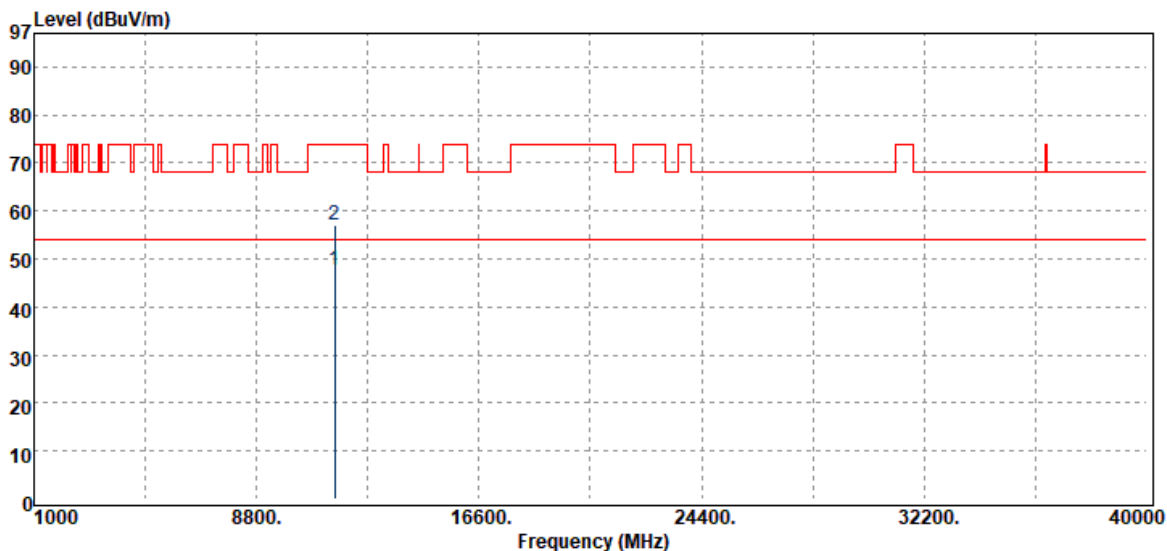

| Freq. MHz | Detector Mode PK/QP/AV | Spectrum Reading Level dBμV | Factor dB | Actual FS dBμV/m | Limit @3m dBμV/m | Margin dB |
|--------------|------------------------------|-----------------------------------|--------------|------------------------|------------------------|--------------|
| 11550.00 | Average | 25.29 | 22.52 | 47.81 | 54.00 | -6.19 |
| 11550.00 | Peak | 34.39 | 22.52 | 56.91 | 74.00 | -17.09 |

Unless otherwise stated the results shown in this test report refer only to the sample(s) tested and such sample(s) are retained for 90 days only.

除非另有說明，此報告結果僅對測試之樣品負責，同時此樣品僅保留90天。本報告未經本公司書面許可，不可部份複製。

This document is issued by the Company subject to its General Conditions of Service printed overleaf, available on request or accessible at <http://www.sgs.com.tw/Terms-and-Conditions> and for electronic format documents, subject to Terms and Conditions for Electronic Documents at <http://www.sgs.com.tw/Terms-and-Conditions>. Attention is drawn to the limitation of liability, indemnification and jurisdiction issues defined therein. Any holder of this document is advised that information contained hereon reflects the Company's findings at the time of its intervention only and within the limits of Client's instructions, if any. The Company's sole responsibility is to its Client and this document does not exonerate parties to a transaction from exercising all their rights and obligations under the transaction documents. This document cannot be reproduced except in full, without prior written approval of the Company. Any unauthorized alteration, forgery or falsification of the content or appearance of this document is unlawful and offenders may be prosecuted to the fullest extent of the law.

Report Number :ER-2021-20085
 Operation Mode :802.11ac80
 Test Frequency :5775 MHz
 Test Mode :Tx CH Low
 EUT Pol :H Plane

Test Site :SAC III Chamber
 Test Date :2021-03-17
 Temp./Humi. :22.8/65
 Antenna Pol. :HORIZONTAL
 Engineer :Ricky

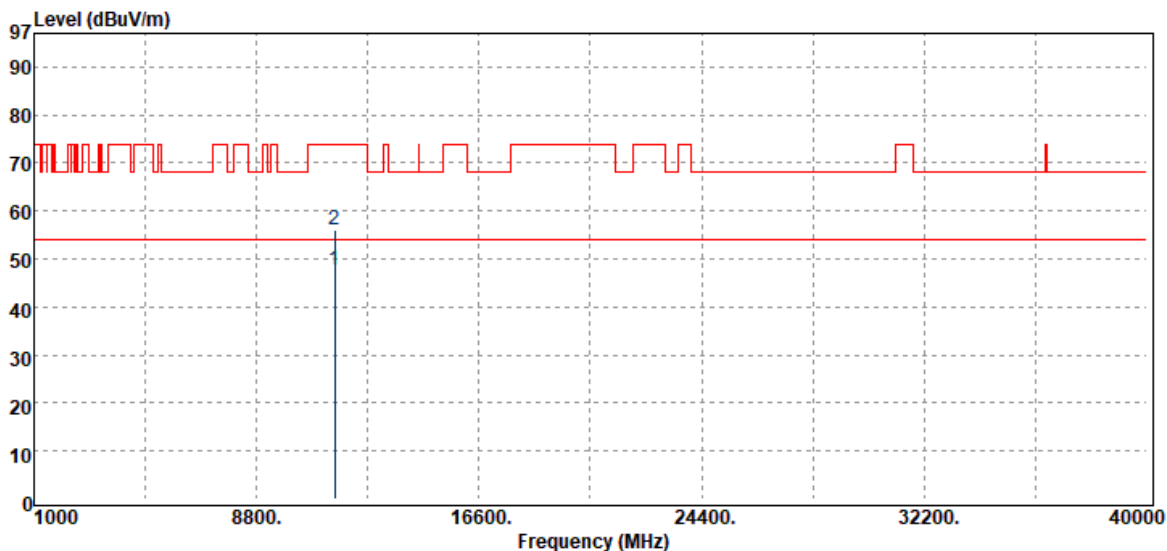

| Freq. MHz | Detector Mode PK/QP/AV | Spectrum Reading Level dB μ V | Factor dB | Actual FS dB μ V/m | Limit @3m dB μ V/m | Margin dB |
|--------------|------------------------------|---|--------------|------------------------------|------------------------------|--------------|
| 11550.00 | Average | 25.24 | 22.52 | 47.76 | 54.00 | -6.24 |
| 11550.00 | Peak | 33.66 | 22.52 | 56.18 | 74.00 | -17.82 |

Unless otherwise stated the results shown in this test report refer only to the sample(s) tested and such sample(s) are retained for 90 days only.

除非另有說明，此報告結果僅對測試之樣品負責，同時此樣品僅保留90天。本報告未經本公司書面許可，不可部份複製。

This document is issued by the Company subject to its General Conditions of Service printed overleaf, available on request or accessible at <http://www.sgs.com.tw/Terms-and-Conditions> and for electronic format documents, subject to Terms and Conditions for Electronic Documents at <http://www.sgs.com.tw/Terms-and-Conditions>. Attention is drawn to the limitation of liability, indemnification and jurisdiction issues defined therein. Any holder of this document is advised that information contained hereon reflects the Company's findings at the time of its intervention only and within the limits of Client's instructions, if any. The Company's sole responsibility is to its Client and this document does not exonerate parties to a transaction from exercising all their rights and obligations under the transaction documents. This document cannot be reproduced except in full, without prior written approval of the Company. Any unauthorized alteration, forgery or falsification of the content or appearance of this document is unlawful and offenders may be prosecuted to the fullest extent of the law.

Report Number :ER-2021-20085
 Operation Mode :802.11ax20
 Test Frequency :5180 MHz
 Test Mode :Tx CH Low
 EUT Pol :H Plane

Test Site :SAC III Chamber
 Test Date :2021-03-17
 Temp./Humi. :22.8/65
 Antenna Pol. :VERTICAL
 Engineer :Ricky

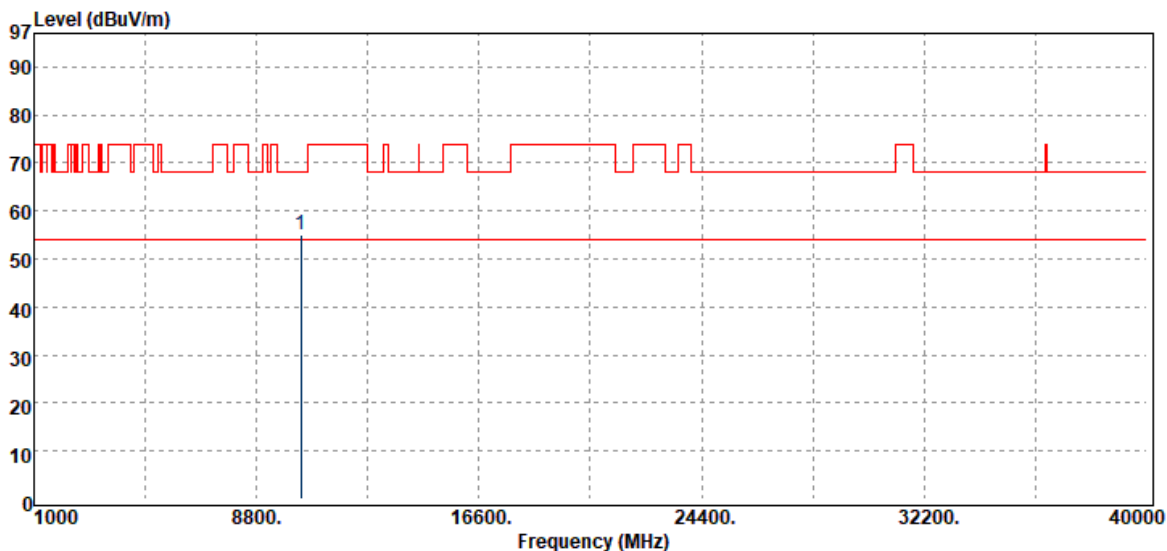

| Freq. MHz | Detector Mode PK/QP/AV | Spectrum Reading Level dB μ V | Factor dB | Actual FS dB μ V/m | Limit @3m dB μ V/m | Margin dB |
|--------------|------------------------------|---|--------------|------------------------------|------------------------------|--------------|
| 10360.00 | Peak | 35.01 | 19.87 | 54.88 | 68.20 | -13.32 |

Unless otherwise stated the results shown in this test report refer only to the sample(s) tested and such sample(s) are retained for 90 days only.

除非另有說明，此報告結果僅對測試之樣品負責，同時此樣品僅保留90天。本報告未經本公司書面許可，不可部份複製。

This document is issued by the Company subject to its General Conditions of Service printed overleaf, available on request or accessible at <http://www.sgs.com.tw/Terms-and-Conditions> and for electronic format documents, subject to Terms and Conditions for Electronic Documents at <http://www.sgs.com.tw/Terms-and-Conditions>. Attention is drawn to the limitation of liability, indemnification and jurisdiction issues defined therein. Any holder of this document is advised that information contained hereon reflects the Company's findings at the time of its intervention only and within the limits of Client's instructions, if any. The Company's sole responsibility is to its Client and this document does not exonerate parties to a transaction from exercising all their rights and obligations under the transaction documents. This document cannot be reproduced except in full, without prior written approval of the Company. Any unauthorized alteration, forgery or falsification of the content or appearance of this document is unlawful and offenders may be prosecuted to the fullest extent of the law.

Report Number :ER-2021-20085
 Operation Mode :802.11ax20
 Test Frequency :5180 MHz
 Test Mode :Tx CH Low
 EUT Pol :H Plane

Test Site :SAC III Chamber
 Test Date :2021-03-17
 Temp./Humi. :22.8/65
 Antenna Pol. :HORIZONTAL
 Engineer :Ricky

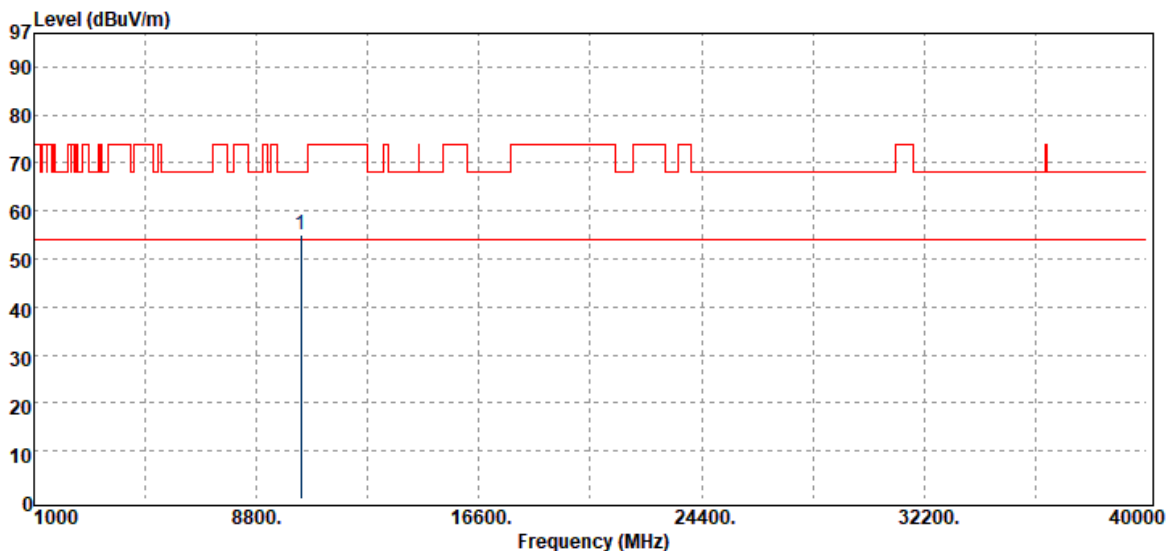

| Freq. MHz | Detector Mode PK/QP/AV | Spectrum Reading Level dB μ V | Factor dB | Actual FS dB μ V/m | Limit @3m dB μ V/m | Margin dB |
|--------------|------------------------------|---|--------------|------------------------------|------------------------------|--------------|
| 10360.00 | Peak | 35.06 | 19.87 | 54.93 | 68.20 | -13.27 |

Unless otherwise stated the results shown in this test report refer only to the sample(s) tested and such sample(s) are retained for 90 days only.

除非另有說明，此報告結果僅對測試之樣品負責，同時此樣品僅保留90天。本報告未經本公司書面許可，不可部份複製。

This document is issued by the Company subject to its General Conditions of Service printed overleaf, available on request or accessible at <http://www.sgs.com.tw/Terms-and-Conditions> and for electronic format documents, subject to Terms and Conditions for Electronic Documents at <http://www.sgs.com.tw/Terms-and-Conditions>. Attention is drawn to the limitation of liability, indemnification and jurisdiction issues defined therein. Any holder of this document is advised that information contained hereon reflects the Company's findings at the time of its intervention only and within the limits of Client's instructions, if any. The Company's sole responsibility is to its Client and this document does not exonerate parties to a transaction from exercising all their rights and obligations under the transaction documents. This document cannot be reproduced except in full, without prior written approval of the Company. Any unauthorized alteration, forgery or falsification of the content or appearance of this document is unlawful and offenders may be prosecuted to the fullest extent of the law.

Report Number :ER-2021-20085
 Operation Mode :802.11ax20
 Test Frequency :5220 MHz
 Test Mode :Tx CH Mid
 EUT Pol :H Plane

Test Site :SAC III Chamber
 Test Date :2021-03-17
 Temp./Humi. :22.8/65
 Antenna Pol. :VERTICAL
 Engineer :Ricky

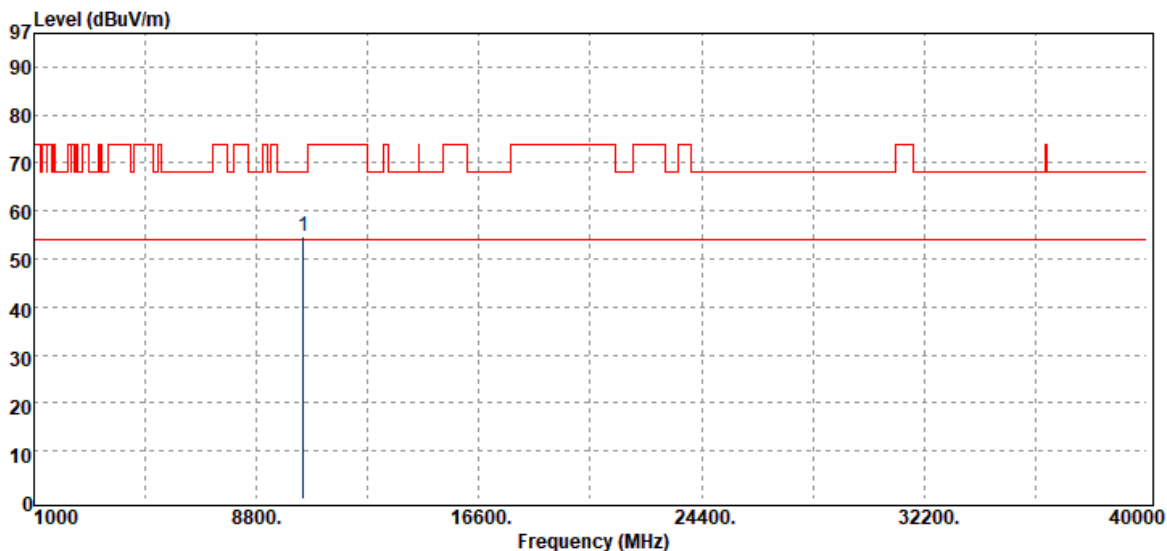

| Freq. MHz | Detector Mode PK/QP/AV | Spectrum Reading Level dB μ V | Factor dB | Actual FS dB μ V/m | Limit @3m dB μ V/m | Margin dB |
|--------------|------------------------------|---|--------------|------------------------------|------------------------------|--------------|
| 10440.00 | Peak | 35.49 | 19.15 | 54.64 | 68.20 | -13.56 |

Unless otherwise stated the results shown in this test report refer only to the sample(s) tested and such sample(s) are retained for 90 days only.

除非另有說明，此報告結果僅對測試之樣品負責，同時此樣品僅保留90天。本報告未經本公司書面許可，不可部份複製。

This document is issued by the Company subject to its General Conditions of Service printed overleaf, available on request or accessible at <http://www.sgs.com.tw/Terms-and-Conditions> and for electronic format documents, subject to Terms and Conditions for Electronic Documents at <http://www.sgs.com.tw/Terms-and-Conditions>. Attention is drawn to the limitation of liability, indemnification and jurisdiction issues defined therein. Any holder of this document is advised that information contained hereon reflects the Company's findings at the time of its intervention only and within the limits of Client's instructions, if any. The Company's sole responsibility is to its Client and this document does not exonerate parties to a transaction from exercising all their rights and obligations under the transaction documents. This document cannot be reproduced except in full, without prior written approval of the Company. Any unauthorized alteration, forgery or falsification of the content or appearance of this document is unlawful and offenders may be prosecuted to the fullest extent of the law.

Report Number :ER-2021-20085
 Operation Mode :802.11ax20
 Test Frequency :5220 MHz
 Test Mode :Tx CH Mid
 EUT Pol :H Plane

Test Site :SAC III Chamber
 Test Date :2021-03-17
 Temp./Humi. :22.8/65
 Antenna Pol. :HORIZONTAL
 Engineer :Ricky

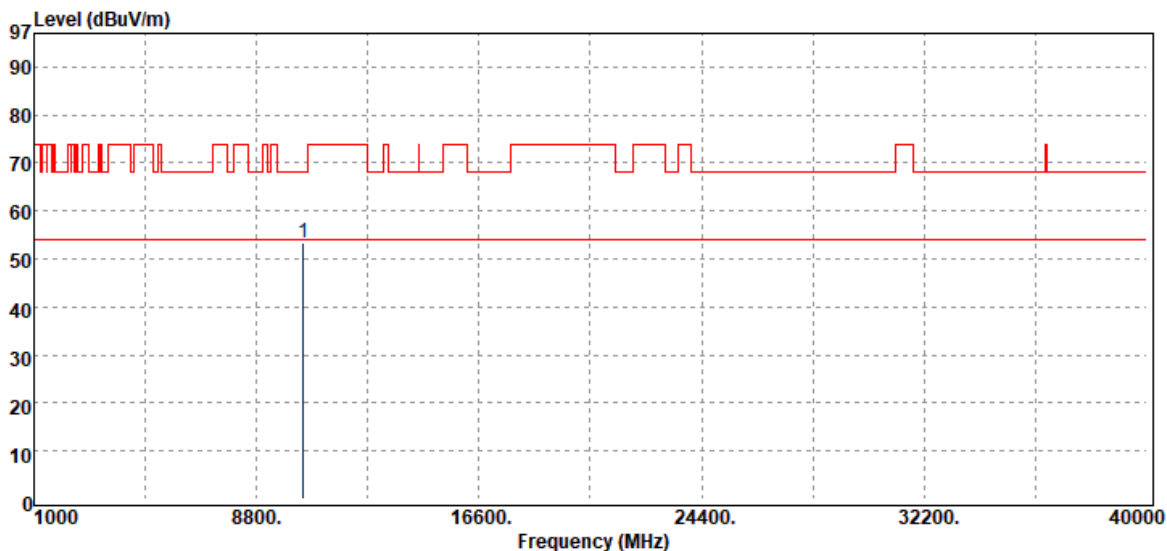

| Freq. MHz | Detector Mode PK/QP/AV | Spectrum Reading Level dB μ V | Factor dB | Actual FS dB μ V/m | Limit @3m dB μ V/m | Margin dB |
|--------------|------------------------------|---|--------------|------------------------------|------------------------------|--------------|
| 10440.00 | Peak | 34.15 | 19.15 | 53.30 | 68.20 | -14.90 |

Unless otherwise stated the results shown in this test report refer only to the sample(s) tested and such sample(s) are retained for 90 days only.

除非另有說明，此報告結果僅對測試之樣品負責，同時此樣品僅保留90天。本報告未經本公司書面許可，不可部份複製。

This document is issued by the Company subject to its General Conditions of Service printed overleaf, available on request or accessible at <http://www.sgs.com.tw/Terms-and-Conditions> and for electronic format documents, subject to Terms and Conditions for Electronic Documents at <http://www.sgs.com.tw/Terms-and-Conditions>. Attention is drawn to the limitation of liability, indemnification and jurisdiction issues defined therein. Any holder of this document is advised that information contained hereon reflects the Company's findings at the time of its intervention only and within the limits of Client's instructions, if any. The Company's sole responsibility is to its Client and this document does not exonerate parties to a transaction from exercising all their rights and obligations under the transaction documents. This document cannot be reproduced except in full, without prior written approval of the Company. Any unauthorized alteration, forgery or falsification of the content or appearance of this document is unlawful and offenders may be prosecuted to the fullest extent of the law.

Report Number :ER-2021-20085
 Operation Mode :802.11ax20
 Test Frequency :5240 MHz
 Test Mode :Tx CH High
 EUT Pol :H Plane

Test Site :SAC III Chamber
 Test Date :2021-03-17
 Temp./Humi. :22.8/65
 Antenna Pol. :VERTICAL
 Engineer :Ricky

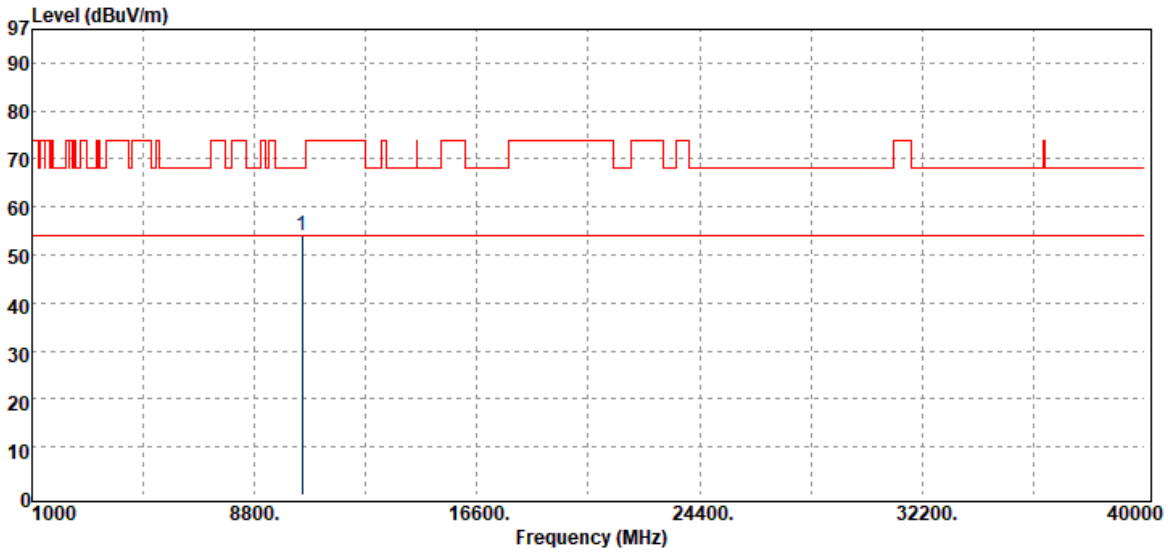

| Freq. MHz | Detector Mode PK/QP/AV | Spectrum Reading Level dB μ V | Factor dB | Actual FS dB μ V/m | Limit @3m dB μ V/m | Margin dB |
|--------------|------------------------------|---|--------------|------------------------------|------------------------------|--------------|
| 10480.00 | Peak | 34.59 | 19.56 | 54.15 | 68.20 | -14.05 |

Unless otherwise stated the results shown in this test report refer only to the sample(s) tested and such sample(s) are retained for 90 days only.

除非另有說明，此報告結果僅對測試之樣品負責，同時此樣品僅保留90天。本報告未經本公司書面許可，不可部份複製。

This document is issued by the Company subject to its General Conditions of Service printed overleaf, available on request or accessible at <http://www.sgs.com.tw/Terms-and-Conditions> and for electronic format documents, subject to Terms and Conditions for Electronic Documents at <http://www.sgs.com.tw/Terms-and-Conditions>. Attention is drawn to the limitation of liability, indemnification and jurisdiction issues defined therein. Any holder of this document is advised that information contained hereon reflects the Company's findings at the time of its intervention only and within the limits of Client's instructions, if any. The Company's sole responsibility is to its Client and this document does not exonerate parties to a transaction from exercising all their rights and obligations under the transaction documents. This document cannot be reproduced except in full, without prior written approval of the Company. Any unauthorized alteration, forgery or falsification of the content or appearance of this document is unlawful and offenders may be prosecuted to the fullest extent of the law.

Report Number :ER-2021-20085
 Operation Mode :802.11ax20
 Test Frequency :5240 MHz
 Test Mode :Tx CH High
 EUT Pol :H Plane

Test Site :SAC III Chamber
 Test Date :2021-03-17
 Temp./Humi. :22.8/65
 Antenna Pol. :HORIZONTAL
 Engineer :Ricky

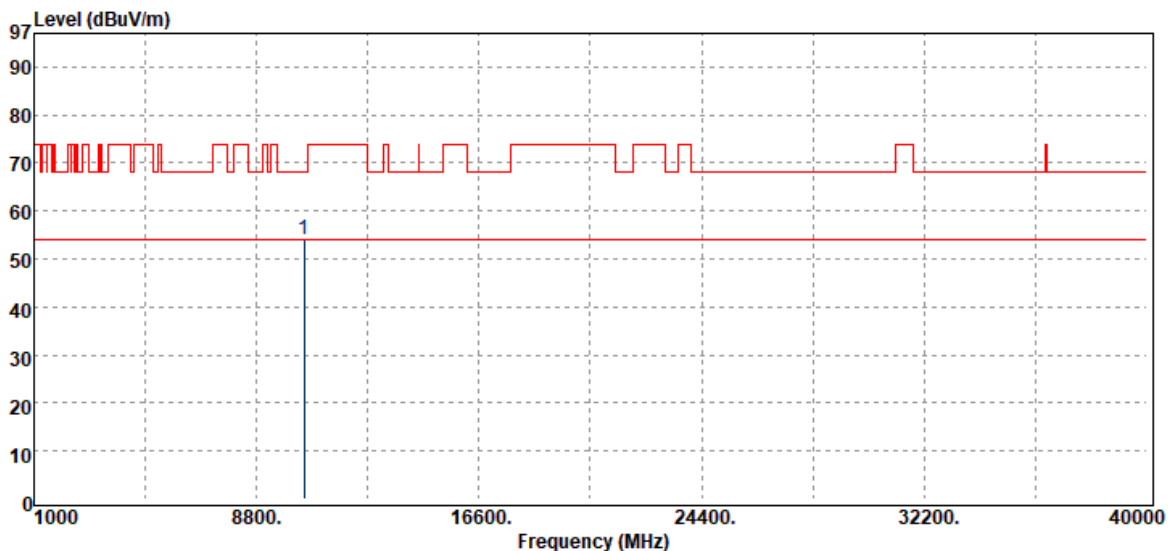

| Freq. MHz | Detector Mode PK/QP/AV | Spectrum Reading Level dB μ V | Factor dB | Actual FS dB μ V/m | Limit @3m dB μ V/m | Margin dB |
|--------------|------------------------------|---|--------------|------------------------------|------------------------------|--------------|
| 10480.00 | Peak | 34.57 | 19.56 | 54.13 | 68.20 | -14.07 |

Unless otherwise stated the results shown in this test report refer only to the sample(s) tested and such sample(s) are retained for 90 days only.

除非另有說明，此報告結果僅對測試之樣品負責，同時此樣品僅保留90天。本報告未經本公司書面許可，不可部份複製。

This document is issued by the Company subject to its General Conditions of Service printed overleaf, available on request or accessible at <http://www.sgs.com.tw/Terms-and-Conditions> and for electronic format documents, subject to Terms and Conditions for Electronic Documents at <http://www.sgs.com.tw/Terms-and-Conditions>. Attention is drawn to the limitation of liability, indemnification and jurisdiction issues defined therein. Any holder of this document is advised that information contained hereon reflects the Company's findings at the time of its intervention only and within the limits of Client's instructions, if any. The Company's sole responsibility is to its Client and this document does not exonerate parties to a transaction from exercising all their rights and obligations under the transaction documents. This document cannot be reproduced except in full, without prior written approval of the Company. Any unauthorized alteration, forgery or falsification of the content or appearance of this document is unlawful and offenders may be prosecuted to the fullest extent of the law.

Report Number :ER-2021-20085
 Operation Mode :802.11ax20
 Test Frequency :5260 MHz
 Test Mode :Tx CH Low
 EUT Pol :H Plane

Test Site :SAC III Chamber
 Test Date :2021-03-17
 Temp./Humi. :22.8/65
 Antenna Pol. :VERTICAL
 Engineer :Ricky

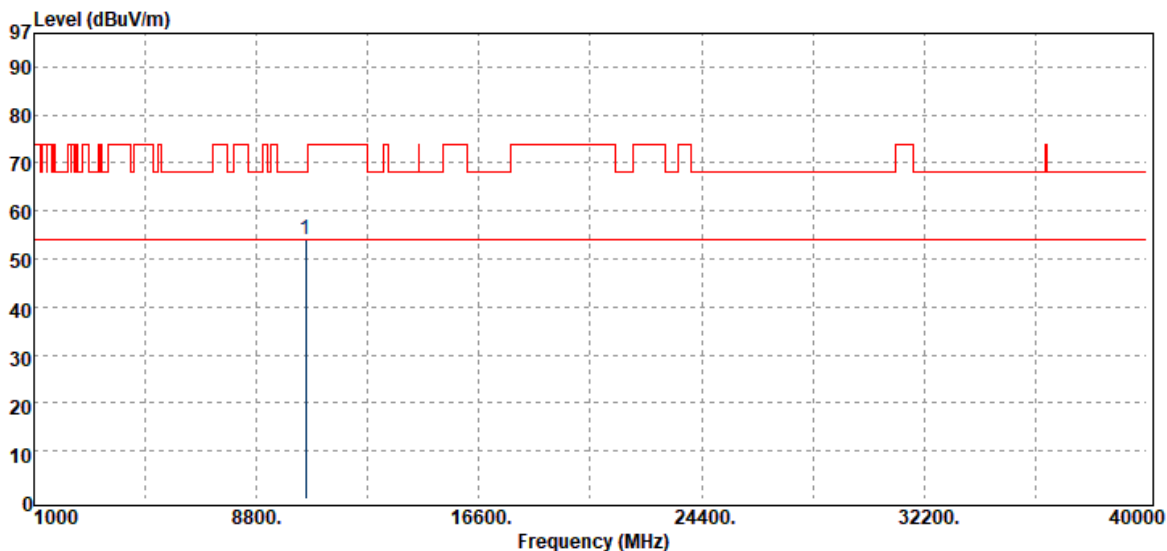

| Freq. MHz | Detector Mode PK/QP/AV | Spectrum Reading Level dB μ V | Factor dB | Actual FS dB μ V/m | Limit @3m dB μ V/m | Margin dB |
|--------------|------------------------------|---|--------------|------------------------------|------------------------------|--------------|
| 10520.00 | Peak | 34.33 | 19.84 | 54.17 | 68.20 | -14.03 |

Unless otherwise stated the results shown in this test report refer only to the sample(s) tested and such sample(s) are retained for 90 days only.

除非另有說明，此報告結果僅對測試之樣品負責，同時此樣品僅保留90天。本報告未經本公司書面許可，不可部份複製。

This document is issued by the Company subject to its General Conditions of Service printed overleaf, available on request or accessible at <http://www.sgs.com.tw/Terms-and-Conditions> and for electronic format documents, subject to Terms and Conditions for Electronic Documents at <http://www.sgs.com.tw/Terms-and-Conditions>. Attention is drawn to the limitation of liability, indemnification and jurisdiction issues defined therein. Any holder of this document is advised that information contained hereon reflects the Company's findings at the time of its intervention only and within the limits of Client's instructions, if any. The Company's sole responsibility is to its Client and this document does not exonerate parties to a transaction from exercising all their rights and obligations under the transaction documents. This document cannot be reproduced except in full, without prior written approval of the Company. Any unauthorized alteration, forgery or falsification of the content or appearance of this document is unlawful and offenders may be prosecuted to the fullest extent of the law.

Report Number :ER-2021-20085
 Operation Mode :802.11ax20
 Test Frequency :5260 MHz
 Test Mode :Tx CH Low
 EUT Pol :H Plane

Test Site :SAC III Chamber
 Test Date :2021-03-17
 Temp./Humi. :22.8/65
 Antenna Pol. :HORIZONTAL
 Engineer :Ricky

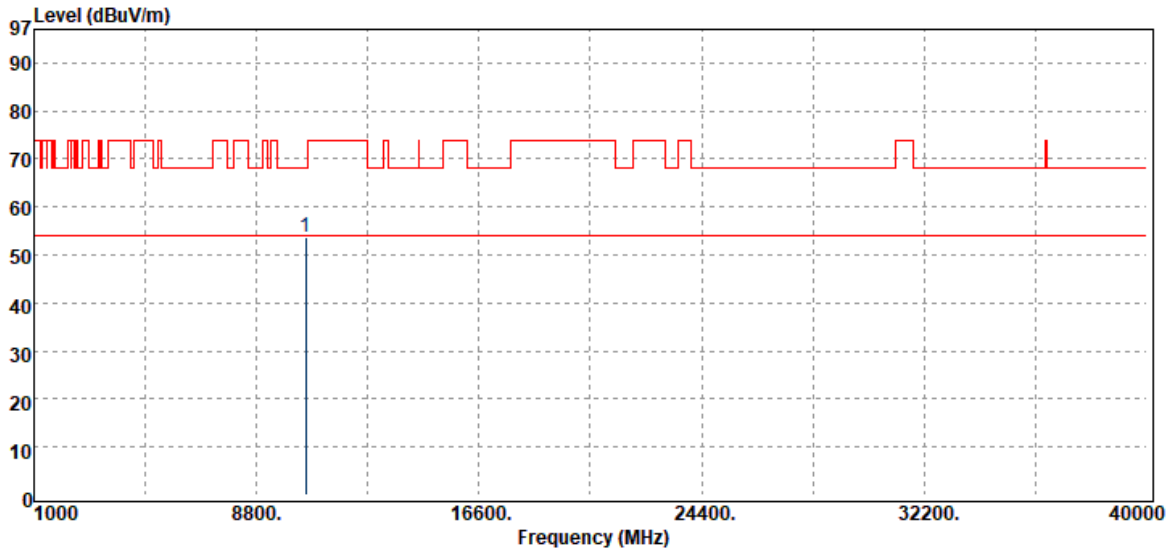

| Freq. MHz | Detector Mode PK/QP/AV | Spectrum Reading Level dB μ V | Factor dB | Actual FS dB μ V/m | Limit @3m dB μ V/m | Margin dB |
|--------------|------------------------------|---|--------------|------------------------------|------------------------------|--------------|
| 10520.00 | Peak | 33.96 | 19.84 | 53.80 | 68.20 | -14.40 |

Unless otherwise stated the results shown in this test report refer only to the sample(s) tested and such sample(s) are retained for 90 days only.

除非另有說明，此報告結果僅對測試之樣品負責，同時此樣品僅保留90天。本報告未經本公司書面許可，不可部份複製。

This document is issued by the Company subject to its General Conditions of Service printed overleaf, available on request or accessible at <http://www.sgs.com.tw/Terms-and-Conditions> and for electronic format documents, subject to Terms and Conditions for Electronic Documents at <http://www.sgs.com.tw/Terms-and-Conditions>. Attention is drawn to the limitation of liability, indemnification and jurisdiction issues defined therein. Any holder of this document is advised that information contained hereon reflects the Company's findings at the time of its intervention only and within the limits of Client's instructions, if any. The Company's sole responsibility is to its Client and this document does not exonerate parties to a transaction from exercising all their rights and obligations under the transaction documents. This document cannot be reproduced except in full, without prior written approval of the Company. Any unauthorized alteration, forgery or falsification of the content or appearance of this document is unlawful and offenders may be prosecuted to the fullest extent of the law.

Report Number :ER-2021-20085
 Operation Mode :802.11ax20
 Test Frequency :5300 MHz
 Test Mode :Tx CH Mid
 EUT Pol :H Plane

Test Site :SAC III Chamber
 Test Date :2021-03-17
 Temp./Humi. :22.8/65
 Antenna Pol. :VERTICAL
 Engineer :Ricky

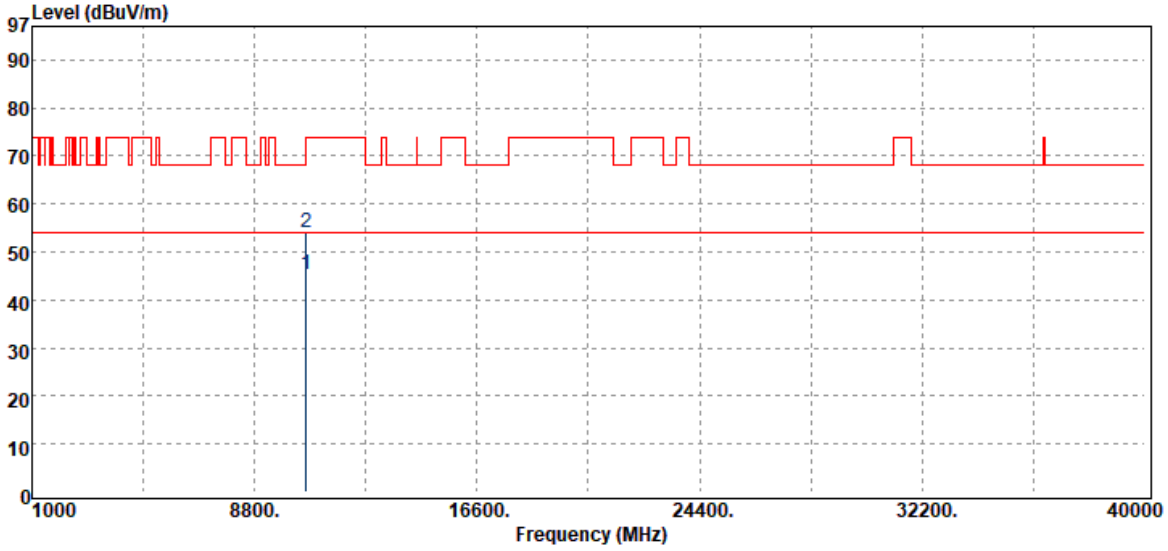

| Freq. MHz | Detector Mode PK/QP/AV | Spectrum Reading Level dB μ V | Factor dB | Actual FS dB μ V/m | Limit @3m dB μ V/m | Margin dB |
|--------------|------------------------------|---|--------------|------------------------------|------------------------------|--------------|
| 10600.00 | Average | 25.54 | 19.86 | 45.40 | 54.00 | -8.60 |
| 10600.00 | Peak | 34.18 | 19.86 | 54.04 | 74.00 | -19.96 |

Unless otherwise stated the results shown in this test report refer only to the sample(s) tested and such sample(s) are retained for 90 days only.

除非另有說明，此報告結果僅對測試之樣品負責，同時此樣品僅保留90天。本報告未經本公司書面許可，不可部份複製。

This document is issued by the Company subject to its General Conditions of Service printed overleaf, available on request or accessible at <http://www.sgs.com.tw/Terms-and-Conditions> and for electronic format documents, subject to Terms and Conditions for Electronic Documents at <http://www.sgs.com.tw/Terms-and-Conditions>. Attention is drawn to the limitation of liability, indemnification and jurisdiction issues defined therein. Any holder of this document is advised that information contained hereon reflects the Company's findings at the time of its intervention only and within the limits of Client's instructions, if any. The Company's sole responsibility is to its Client and this document does not exonerate parties to a transaction from exercising all their rights and obligations under the transaction documents. This document cannot be reproduced except in full, without prior written approval of the Company. Any unauthorized alteration, forgery or falsification of the content or appearance of this document is unlawful and offenders may be prosecuted to the fullest extent of the law.

Report Number :ER-2021-20085
 Operation Mode :802.11ax20
 Test Frequency :5300 MHz
 Test Mode :Tx CH Mid
 EUT Pol :H Plane

Test Site :SAC III Chamber
 Test Date :2021-03-17
 Temp./Humi. :22.8/65
 Antenna Pol. :HORIZONTAL
 Engineer :Ricky

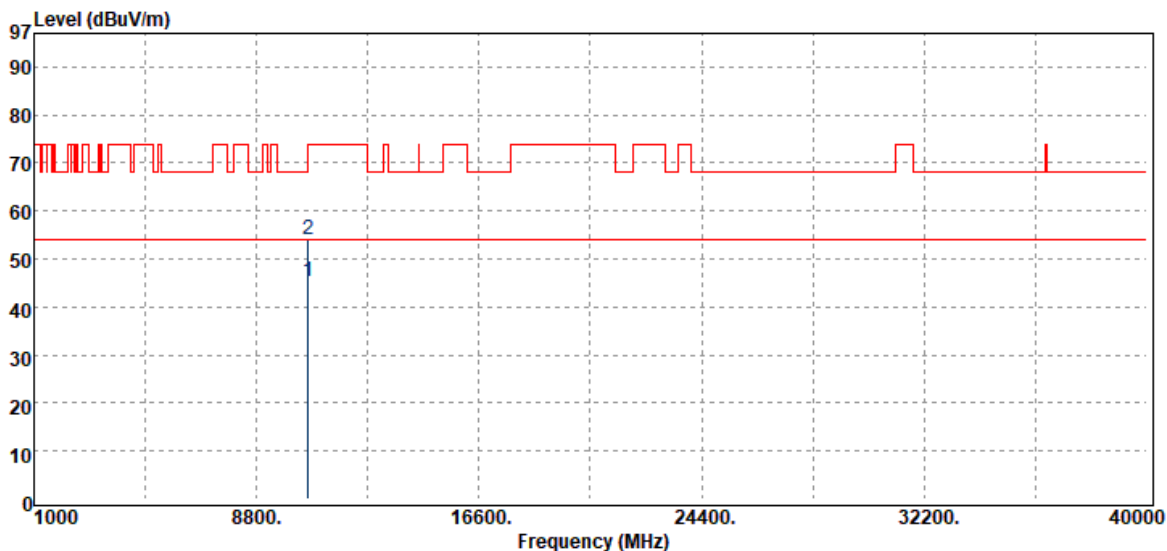

| Freq. MHz | Detector Mode PK/QP/AV | Spectrum Reading Level dB μ V | Factor dB | Actual FS dB μ V/m | Limit @3m dB μ V/m | Margin dB |
|--------------|------------------------------|---|--------------|------------------------------|------------------------------|--------------|
| 10600.00 | Average | 25.49 | 19.86 | 45.35 | 54.00 | -8.65 |
| 10600.00 | Peak | 34.11 | 19.86 | 53.97 | 74.00 | -20.03 |

Unless otherwise stated the results shown in this test report refer only to the sample(s) tested and such sample(s) are retained for 90 days only.

除非另有說明，此報告結果僅對測試之樣品負責，同時此樣品僅保留90天。本報告未經本公司書面許可，不可部份複製。

This document is issued by the Company subject to its General Conditions of Service printed overleaf, available on request or accessible at <http://www.sgs.com.tw/Terms-and-Conditions> and for electronic format documents, subject to Terms and Conditions for Electronic Documents at <http://www.sgs.com.tw/Terms-and-Conditions>. Attention is drawn to the limitation of liability, indemnification and jurisdiction issues defined therein. Any holder of this document is advised that information contained hereon reflects the Company's findings at the time of its intervention only and within the limits of Client's instructions, if any. The Company's sole responsibility is to its Client and this document does not exonerate parties to a transaction from exercising all their rights and obligations under the transaction documents. This document cannot be reproduced except in full, without prior written approval of the Company. Any unauthorized alteration, forgery or falsification of the content or appearance of this document is unlawful and offenders may be prosecuted to the fullest extent of the law.

Report Number :ER-2021-20085
 Operation Mode :802.11ax20
 Test Frequency :5320 MHz
 Test Mode :Tx CH High
 EUT Pol :H Plane

Test Site :SAC III Chamber
 Test Date :2021-03-17
 Temp./Humi. :22.8/65
 Antenna Pol. :VERTICAL
 Engineer :Ricky

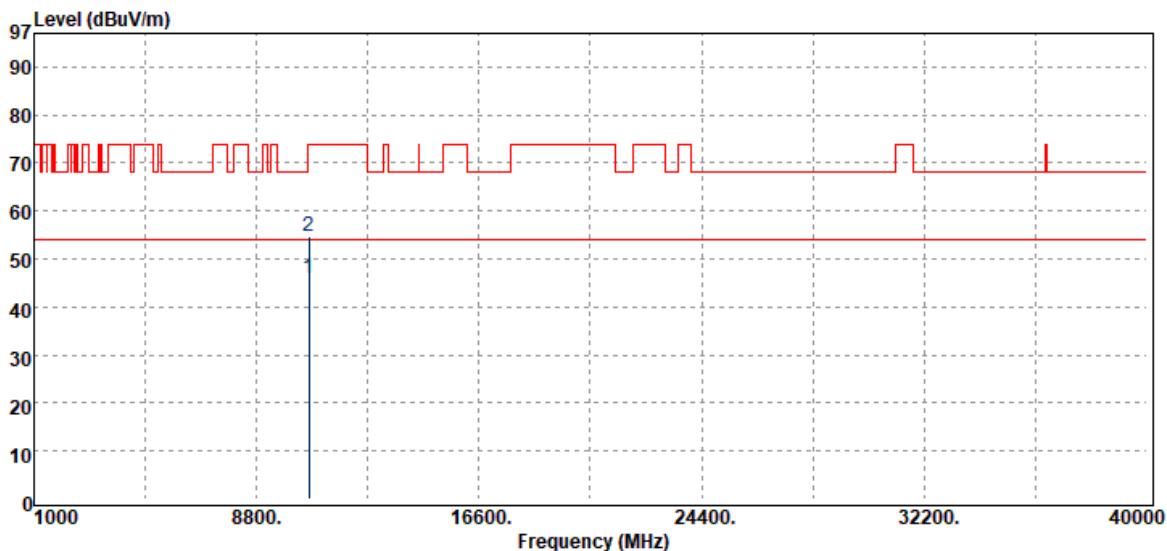

| Freq. MHz | Detector Mode PK/QP/AV | Spectrum Reading Level dBμV | Factor dB | Actual FS dBμV/m | Limit @3m dBμV/m | Margin dB |
|--------------|------------------------------|-----------------------------------|--------------|------------------------|------------------------|--------------|
| 10640.00 | Average | 25.58 | 20.37 | 45.95 | 54.00 | -8.05 |
| 10640.00 | Peak | 34.25 | 20.37 | 54.62 | 74.00 | -19.38 |

Unless otherwise stated the results shown in this test report refer only to the sample(s) tested and such sample(s) are retained for 90 days only.

除非另有說明，此報告結果僅對測試之樣品負責，同時此樣品僅保留90天。本報告未經本公司書面許可，不可部份複製。

This document is issued by the Company subject to its General Conditions of Service printed overleaf, available on request or accessible at <http://www.sgs.com.tw/Terms-and-Conditions> and for electronic format documents, subject to Terms and Conditions for Electronic Documents at <http://www.sgs.com.tw/Terms-and-Conditions>. Attention is drawn to the limitation of liability, indemnification and jurisdiction issues defined therein. Any holder of this document is advised that information contained hereon reflects the Company's findings at the time of its intervention only and within the limits of Client's instructions, if any. The Company's sole responsibility is to its Client and this document does not exonerate parties to a transaction from exercising all their rights and obligations under the transaction documents. This document cannot be reproduced except in full, without prior written approval of the Company. Any unauthorized alteration, forgery or falsification of the content or appearance of this document is unlawful and offenders may be prosecuted to the fullest extent of the law.

Report Number :ER-2021-20085
 Operation Mode :802.11ax20
 Test Frequency :5320 MHz
 Test Mode :Tx CH High
 EUT Pol :H Plane

Test Site :SAC III Chamber
 Test Date :2021-03-17
 Temp./Humi. :22.8/65
 Antenna Pol. :HORIZONTAL
 Engineer :Ricky

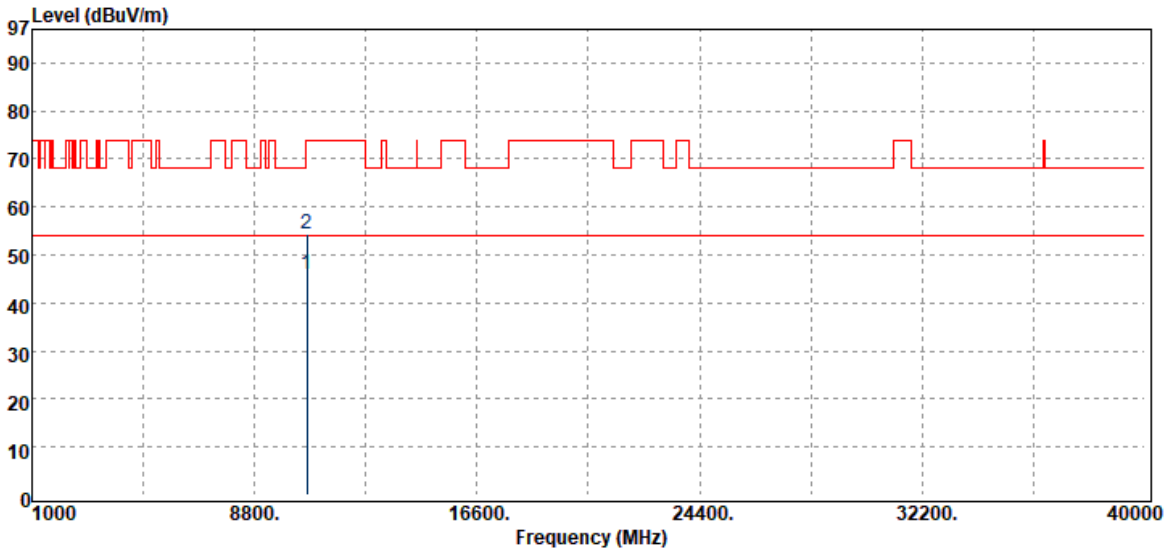

| Freq. MHz | Detector Mode PK/QP/AV | Spectrum Reading Level dB μ V | Factor dB | Actual FS dB μ V/m | Limit @3m dB μ V/m | Margin dB |
|--------------|------------------------------|---|--------------|------------------------------|------------------------------|--------------|
| 10640.00 | Average | 25.46 | 20.37 | 45.83 | 54.00 | -8.17 |
| 10640.00 | Peak | 34.10 | 20.37 | 54.47 | 74.00 | -19.53 |

Unless otherwise stated the results shown in this test report refer only to the sample(s) tested and such sample(s) are retained for 90 days only.

除非另有說明，此報告結果僅對測試之樣品負責，同時此樣品僅保留90天。本報告未經本公司書面許可，不可部份複製。

This document is issued by the Company subject to its General Conditions of Service printed overleaf, available on request or accessible at <http://www.sgs.com.tw/Terms-and-Conditions> and for electronic format documents, subject to Terms and Conditions for Electronic Documents at <http://www.sgs.com.tw/Terms-and-Conditions>. Attention is drawn to the limitation of liability, indemnification and jurisdiction issues defined therein. Any holder of this document is advised that information contained hereon reflects the Company's findings at the time of its intervention only and within the limits of Client's instructions, if any. The Company's sole responsibility is to its Client and this document does not exonerate parties to a transaction from exercising all their rights and obligations under the transaction documents. This document cannot be reproduced except in full, without prior written approval of the Company. Any unauthorized alteration, forgery or falsification of the content or appearance of this document is unlawful and offenders may be prosecuted to the fullest extent of the law.

Report Number :ER-2021-20085
 Operation Mode :802.11ax20
 Test Frequency :5500 MHz
 Test Mode :Tx CH Low
 EUT Pol :H Plane

Test Site :SAC III Chamber
 Test Date :2021-03-17
 Temp./Humi. :22.8/65
 Antenna Pol. :VERTICAL
 Engineer :Ricky

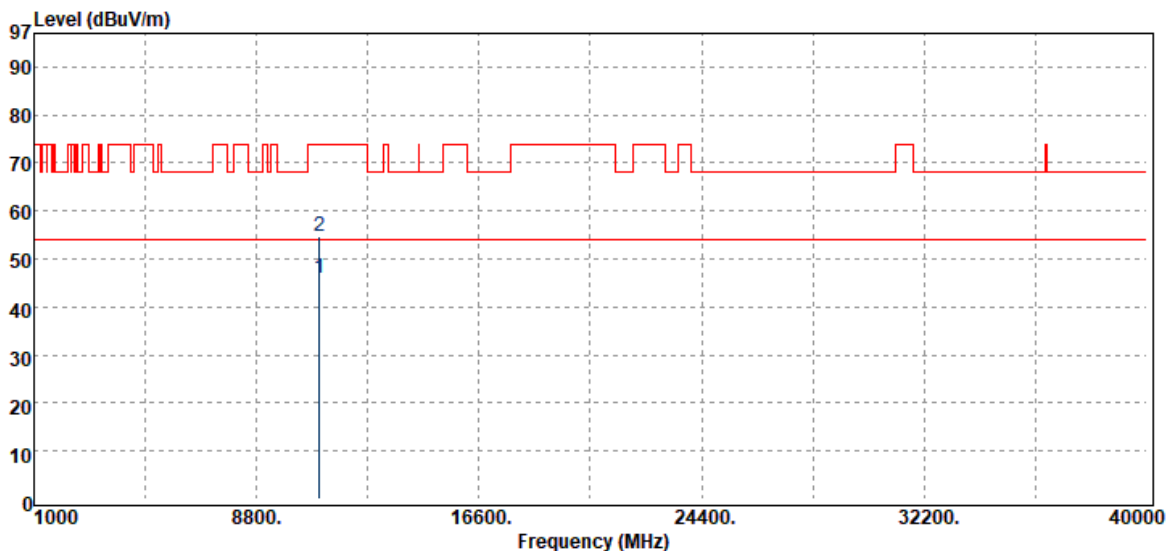

| Freq. MHz | Detector Mode PK/QP/AV | Spectrum Reading Level dBμV | Factor dB | Actual FS dBμV/m | Limit @3m dBμV/m | Margin dB |
|--------------|------------------------------|-----------------------------------|--------------|------------------------|------------------------|--------------|
| 11000.00 | Average | 25.24 | 20.90 | 46.14 | 54.00 | -7.86 |
| 11000.00 | Peak | 33.84 | 20.90 | 54.74 | 74.00 | -19.26 |

Unless otherwise stated the results shown in this test report refer only to the sample(s) tested and such sample(s) are retained for 90 days only.

除非另有說明，此報告結果僅對測試之樣品負責，同時此樣品僅保留90天。本報告未經本公司書面許可，不可部份複製。

This document is issued by the Company subject to its General Conditions of Service printed overleaf, available on request or accessible at <http://www.sgs.com.tw/Terms-and-Conditions> and for electronic format documents, subject to Terms and Conditions for Electronic Documents at <http://www.sgs.com.tw/Terms-and-Conditions>. Attention is drawn to the limitation of liability, indemnification and jurisdiction issues defined therein. Any holder of this document is advised that information contained hereon reflects the Company's findings at the time of its intervention only and within the limits of Client's instructions, if any. The Company's sole responsibility is to its Client and this document does not exonerate parties to a transaction from exercising all their rights and obligations under the transaction documents. This document cannot be reproduced except in full, without prior written approval of the Company. Any unauthorized alteration, forgery or falsification of the content or appearance of this document is unlawful and offenders may be prosecuted to the fullest extent of the law.

Report Number :ER-2021-20085
 Operation Mode :802.11ax20
 Test Frequency :5500 MHz
 Test Mode :Tx CH Low
 EUT Pol :H Plane

Test Site :SAC III Chamber
 Test Date :2021-03-17
 Temp./Humi. :22.8/65
 Antenna Pol. :HORIZONTAL
 Engineer :Ricky

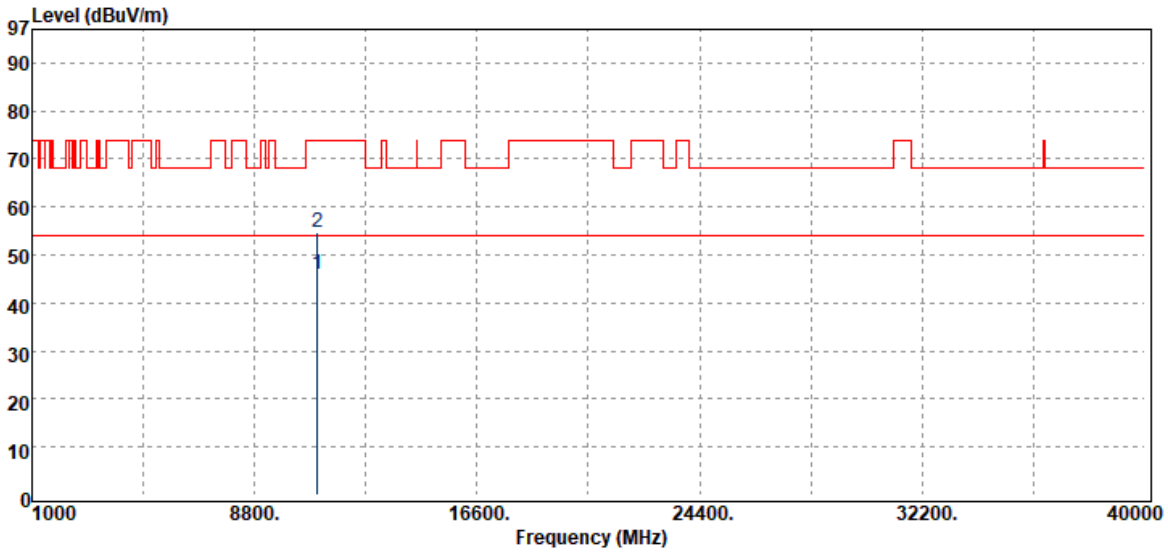

| Freq. MHz | Detector Mode PK/QP/AV | Spectrum Reading Level dB μ V | Factor dB | Actual FS dB μ V/m | Limit @3m dB μ V/m | Margin dB |
|--------------|------------------------------|---|--------------|------------------------------|------------------------------|--------------|
| 11000.00 | Average | 25.25 | 20.90 | 46.15 | 54.00 | -7.85 |
| 11000.00 | Peak | 33.84 | 20.90 | 54.74 | 74.00 | -19.26 |

Unless otherwise stated the results shown in this test report refer only to the sample(s) tested and such sample(s) are retained for 90 days only.

除非另有說明，此報告結果僅對測試之樣品負責，同時此樣品僅保留90天。本報告未經本公司書面許可，不可部份複製。

This document is issued by the Company subject to its General Conditions of Service printed overleaf, available on request or accessible at <http://www.sgs.com.tw/Terms-and-Conditions> and for electronic format documents, subject to Terms and Conditions for Electronic Documents at <http://www.sgs.com.tw/Terms-and-Conditions>. Attention is drawn to the limitation of liability, indemnification and jurisdiction issues defined therein. Any holder of this document is advised that information contained hereon reflects the Company's findings at the time of its intervention only and within the limits of Client's instructions, if any. The Company's sole responsibility is to its Client and this document does not exonerate parties to a transaction from exercising all their rights and obligations under the transaction documents. This document cannot be reproduced except in full, without prior written approval of the Company. Any unauthorized alteration, forgery or falsification of the content or appearance of this document is unlawful and offenders may be prosecuted to the fullest extent of the law.

Report Number :ER-2021-20085
 Operation Mode :802.11ax20
 Test Frequency :5580 MHz
 Test Mode :Tx CH Mid
 EUT Pol :H Plane

Test Site :SAC III Chamber
 Test Date :2021-03-17
 Temp./Humi. :22.8/65
 Antenna Pol. :VERTICAL
 Engineer :Ricky

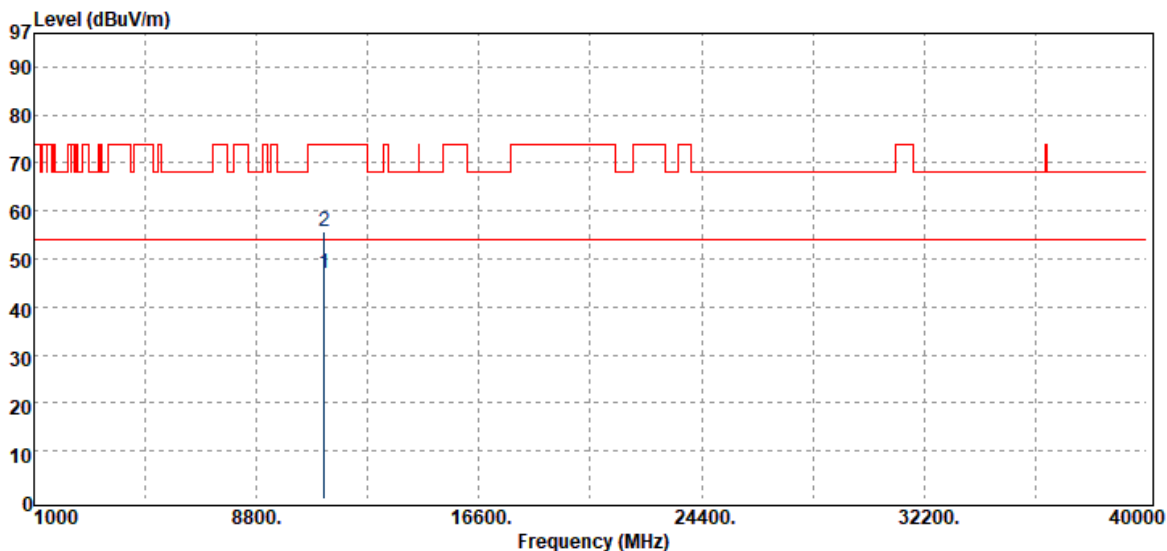

| Freq. MHz | Detector Mode PK/QP/AV | Spectrum Reading Level dB μ V | Factor dB | Actual FS dB μ V/m | Limit @3m dB μ V/m | Margin dB |
|--------------|------------------------------|---|--------------|------------------------------|------------------------------|--------------|
| 11160.00 | Average | 25.42 | 21.60 | 47.02 | 54.00 | -6.98 |
| 11160.00 | Peak | 34.27 | 21.60 | 55.87 | 74.00 | -18.13 |

Unless otherwise stated the results shown in this test report refer only to the sample(s) tested and such sample(s) are retained for 90 days only.

除非另有說明，此報告結果僅對測試之樣品負責，同時此樣品僅保留90天。本報告未經本公司書面許可，不可部份複製。

This document is issued by the Company subject to its General Conditions of Service printed overleaf, available on request or accessible at <http://www.sgs.com.tw/Terms-and-Conditions> and for electronic format documents, subject to Terms and Conditions for Electronic Documents at <http://www.sgs.com.tw/Terms-and-Conditions>. Attention is drawn to the limitation of liability, indemnification and jurisdiction issues defined therein. Any holder of this document is advised that information contained hereon reflects the Company's findings at the time of its intervention only and within the limits of Client's instructions, if any. The Company's sole responsibility is to its Client and this document does not exonerate parties to a transaction from exercising all their rights and obligations under the transaction documents. This document cannot be reproduced except in full, without prior written approval of the Company. Any unauthorized alteration, forgery or falsification of the content or appearance of this document is unlawful and offenders may be prosecuted to the fullest extent of the law.

Report Number :ER-2021-20085
 Operation Mode :802.11ax20
 Test Frequency :5580 MHz
 Test Mode :Tx CH Mid
 EUT Pol :H Plane

Test Site :SAC III Chamber
 Test Date :2021-03-17
 Temp./Humi. :22.8/65
 Antenna Pol. :HORIZONTAL
 Engineer :Ricky

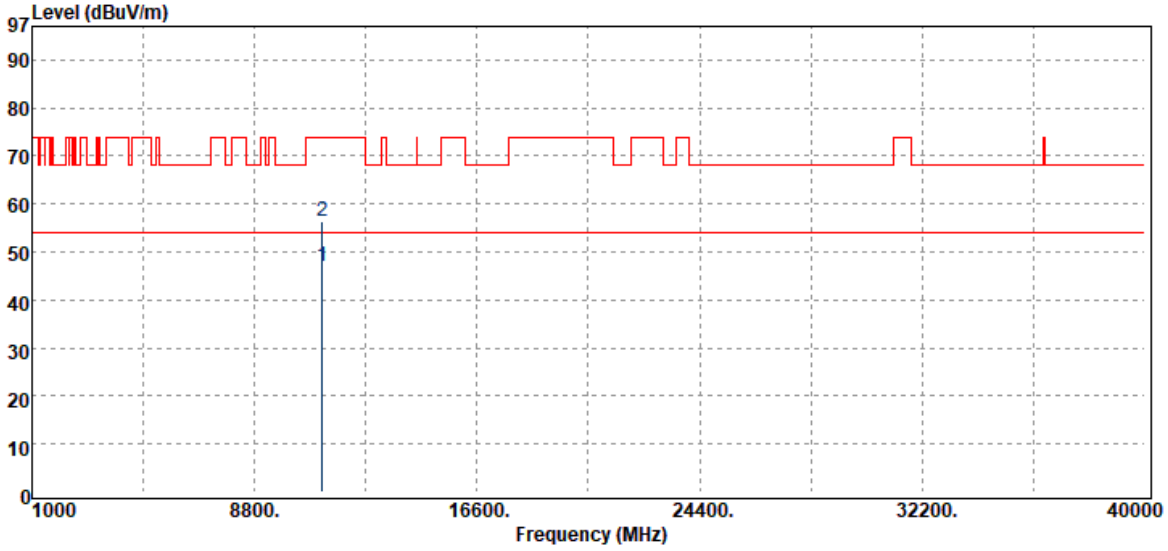

| Freq. MHz | Detector Mode PK/QP/AV | Spectrum Reading Level dB μ V | Factor dB | Actual FS dB μ V/m | Limit @3m dB μ V/m | Margin dB |
|--------------|------------------------------|---|--------------|------------------------------|------------------------------|--------------|
| 11160.00 | Average | 25.42 | 21.60 | 47.02 | 54.00 | -6.98 |
| 11160.00 | Peak | 34.65 | 21.60 | 56.25 | 74.00 | -17.75 |

Unless otherwise stated the results shown in this test report refer only to the sample(s) tested and such sample(s) are retained for 90 days only.

除非另有說明，此報告結果僅對測試之樣品負責，同時此樣品僅保留90天。本報告未經本公司書面許可，不可部份複製。

This document is issued by the Company subject to its General Conditions of Service printed overleaf, available on request or accessible at <http://www.sgs.com.tw/Terms-and-Conditions> and for electronic format documents, subject to Terms and Conditions for Electronic Documents at <http://www.sgs.com.tw/Terms-and-Conditions>. Attention is drawn to the limitation of liability, indemnification and jurisdiction issues defined therein. Any holder of this document is advised that information contained hereon reflects the Company's findings at the time of its intervention only and within the limits of Client's instructions, if any. The Company's sole responsibility is to its Client and this document does not exonerate parties to a transaction from exercising all their rights and obligations under the transaction documents. This document cannot be reproduced except in full, without prior written approval of the Company. Any unauthorized alteration, forgery or falsification of the content or appearance of this document is unlawful and offenders may be prosecuted to the fullest extent of the law.

Report Number :ER-2021-20085
 Operation Mode :802.11ax20
 Test Frequency :5700 MHz
 Test Mode :Tx CH High
 EUT Pol :H Plane

Test Site :SAC III Chamber
 Test Date :2021-03-17
 Temp./Humi. :22.8/65
 Antenna Pol. :VERTICAL
 Engineer :Ricky

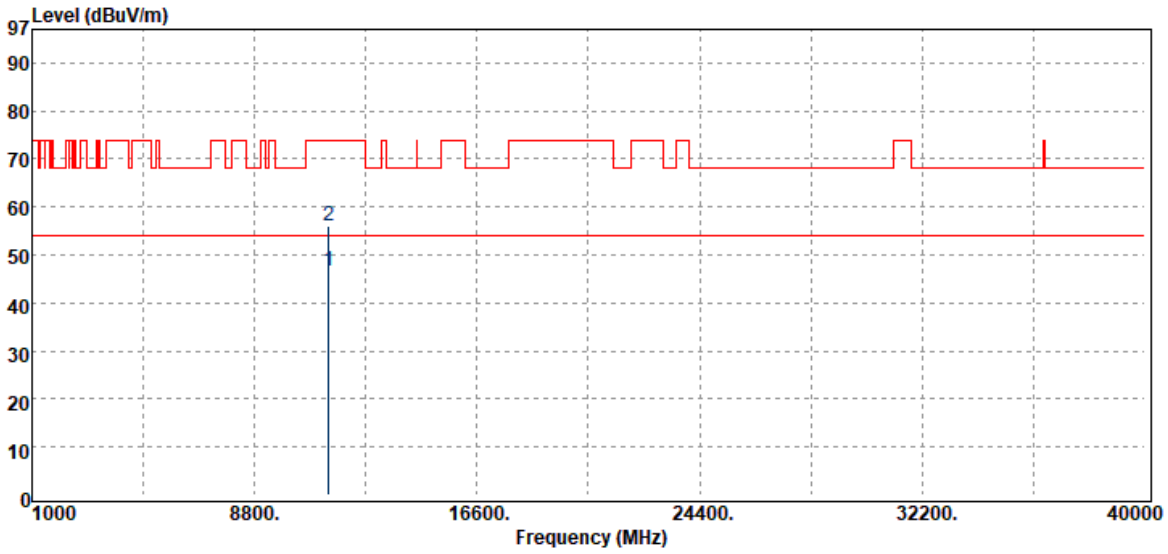

| Freq. MHz | Detector Mode PK/QP/AV | Spectrum Reading Level dB μ V | Factor dB | Actual FS dB μ V/m | Limit @3m dB μ V/m | Margin dB |
|--------------|------------------------------|---|--------------|------------------------------|------------------------------|--------------|
| 11400.00 | Average | 25.25 | 21.51 | 46.76 | 54.00 | -7.24 |
| 11400.00 | Peak | 34.58 | 21.51 | 56.09 | 74.00 | -17.91 |

Unless otherwise stated the results shown in this test report refer only to the sample(s) tested and such sample(s) are retained for 90 days only.

除非另有說明，此報告結果僅對測試之樣品負責，同時此樣品僅保留90天。本報告未經本公司書面許可，不可部份複製。

This document is issued by the Company subject to its General Conditions of Service printed overleaf, available on request or accessible at <http://www.sgs.com.tw/Terms-and-Conditions> and for electronic format documents, subject to Terms and Conditions for Electronic Documents at <http://www.sgs.com.tw/Terms-and-Conditions>. Attention is drawn to the limitation of liability, indemnification and jurisdiction issues defined therein. Any holder of this document is advised that information contained hereon reflects the Company's findings at the time of its intervention only and within the limits of Client's instructions, if any. The Company's sole responsibility is to its Client and this document does not exonerate parties to a transaction from exercising all their rights and obligations under the transaction documents. This document cannot be reproduced except in full, without prior written approval of the Company. Any unauthorized alteration, forgery or falsification of the content or appearance of this document is unlawful and offenders may be prosecuted to the fullest extent of the law.

Report Number :ER-2021-20085
 Operation Mode :802.11ax20
 Test Frequency :5700 MHz
 Test Mode :Tx CH High
 EUT Pol :H Plane

Test Site :SAC III Chamber
 Test Date :2021-03-17
 Temp./Humi. :22.8/65
 Antenna Pol. :HORIZONTAL
 Engineer :Ricky

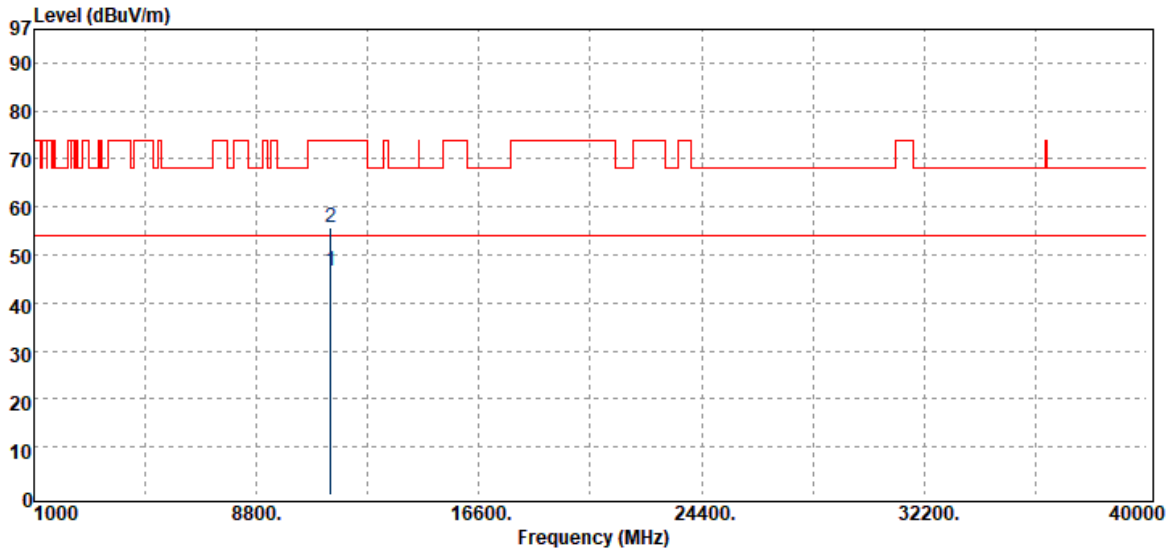

| Freq. MHz | Detector Mode PK/QP/AV | Spectrum Reading Level dB μ V | Factor dB | Actual FS dB μ V/m | Limit @3m dB μ V/m | Margin dB |
|--------------|------------------------------|---|--------------|------------------------------|------------------------------|--------------|
| 11400.00 | Average | 25.15 | 21.51 | 46.66 | 54.00 | -7.34 |
| 11400.00 | Peak | 34.26 | 21.51 | 55.77 | 74.00 | -18.23 |

Unless otherwise stated the results shown in this test report refer only to the sample(s) tested and such sample(s) are retained for 90 days only.

除非另有說明，此報告結果僅對測試之樣品負責，同時此樣品僅保留90天。本報告未經本公司書面許可，不可部份複製。

This document is issued by the Company subject to its General Conditions of Service printed overleaf, available on request or accessible at <http://www.sgs.com.tw/Terms-and-Conditions> and for electronic format documents, subject to Terms and Conditions for Electronic Documents at <http://www.sgs.com.tw/Terms-and-Conditions>. Attention is drawn to the limitation of liability, indemnification and jurisdiction issues defined therein. Any holder of this document is advised that information contained hereon reflects the Company's findings at the time of its intervention only and within the limits of Client's instructions, if any. The Company's sole responsibility is to its Client and this document does not exonerate parties to a transaction from exercising all their rights and obligations under the transaction documents. This document cannot be reproduced except in full, without prior written approval of the Company. Any unauthorized alteration, forgery or falsification of the content or appearance of this document is unlawful and offenders may be prosecuted to the fullest extent of the law.

Report Number :ER-2021-20085
 Operation Mode :802.11ax20
 Test Frequency :5720 MHz
 Test Mode :Tx CH High
 EUT Pol :H Plane

Test Site :SAC III Chamber
 Test Date :2021-03-17
 Temp./Humi. :22.8/65
 Antenna Pol. :VERTICAL
 Engineer :Ricky

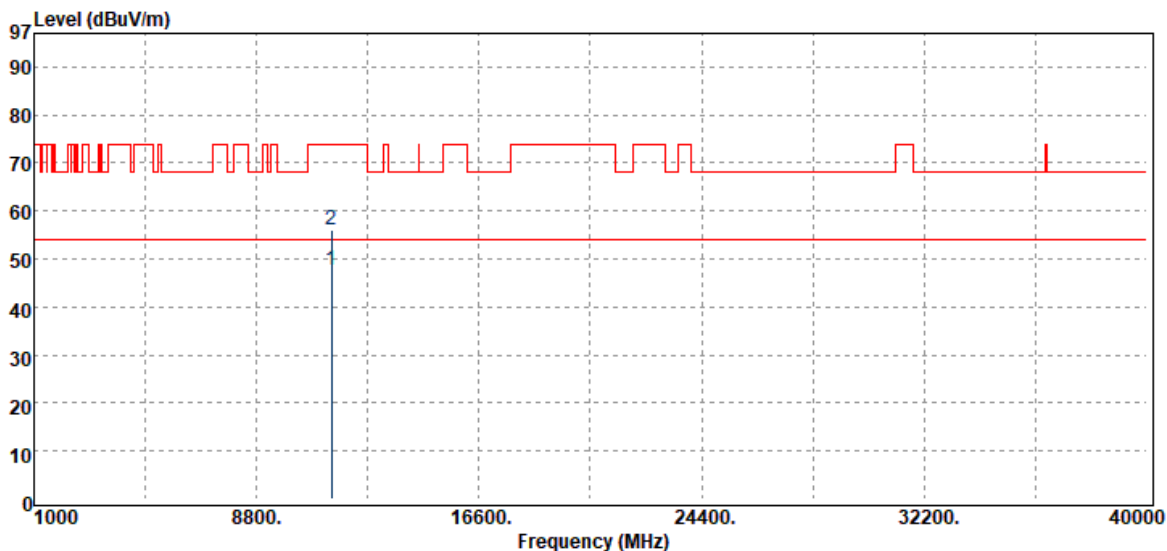

| Freq. MHz | Detector Mode PK/QP/AV | Spectrum Reading Level dB μ V | Factor dB | Actual FS dB μ V/m | Limit @3m dB μ V/m | Margin dB |
|--------------|------------------------------|---|--------------|------------------------------|------------------------------|--------------|
| 11440.00 | Average | 24.87 | 22.75 | 47.62 | 54.00 | -6.38 |
| 11440.00 | Peak | 33.43 | 22.75 | 56.18 | 74.00 | -17.82 |

Unless otherwise stated the results shown in this test report refer only to the sample(s) tested and such sample(s) are retained for 90 days only.

除非另有說明，此報告結果僅對測試之樣品負責，同時此樣品僅保留90天。本報告未經本公司書面許可，不可部份複製。

This document is issued by the Company subject to its General Conditions of Service printed overleaf, available on request or accessible at <http://www.sgs.com.tw/Terms-and-Conditions> and for electronic format documents, subject to Terms and Conditions for Electronic Documents at <http://www.sgs.com.tw/Terms-and-Conditions>. Attention is drawn to the limitation of liability, indemnification and jurisdiction issues defined therein. Any holder of this document is advised that information contained hereon reflects the Company's findings at the time of its intervention only and within the limits of Client's instructions, if any. The Company's sole responsibility is to its Client and this document does not exonerate parties to a transaction from exercising all their rights and obligations under the transaction documents. This document cannot be reproduced except in full, without prior written approval of the Company. Any unauthorized alteration, forgery or falsification of the content or appearance of this document is unlawful and offenders may be prosecuted to the fullest extent of the law.

Report Number :ER-2021-20085
 Operation Mode :802.11ax20
 Test Frequency :5720 MHz
 Test Mode :Tx CH High
 EUT Pol :H Plane

Test Site :SAC III Chamber
 Test Date :2021-03-17
 Temp./Humi. :22.8/65
 Antenna Pol. :HORIZONTAL
 Engineer :Ricky

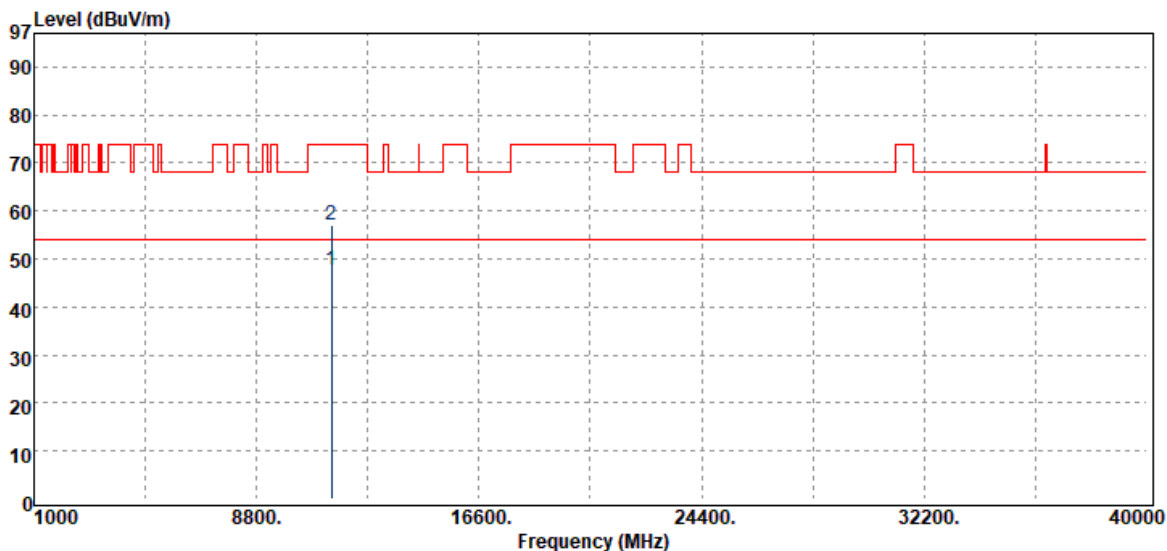

| Freq. MHz | Detector Mode PK/QP/AV | Spectrum Reading Level dB μ V | Factor dB | Actual FS dB μ V/m | Limit @3m dB μ V/m | Margin dB |
|--------------|------------------------------|---|--------------|------------------------------|------------------------------|--------------|
| 11440.00 | Average | 24.83 | 22.75 | 47.58 | 54.00 | -6.42 |
| 11440.00 | Peak | 34.37 | 22.75 | 57.12 | 74.00 | -16.88 |

Unless otherwise stated the results shown in this test report refer only to the sample(s) tested and such sample(s) are retained for 90 days only.

除非另有說明，此報告結果僅對測試之樣品負責，同時此樣品僅保留90天。本報告未經本公司書面許可，不可部份複製。

This document is issued by the Company subject to its General Conditions of Service printed overleaf, available on request or accessible at <http://www.sgs.com.tw/Terms-and-Conditions> and for electronic format documents, subject to Terms and Conditions for Electronic Documents at <http://www.sgs.com.tw/Terms-and-Conditions>. Attention is drawn to the limitation of liability, indemnification and jurisdiction issues defined therein. Any holder of this document is advised that information contained hereon reflects the Company's findings at the time of its intervention only and within the limits of Client's instructions, if any. The Company's sole responsibility is to its Client and this document does not exonerate parties to a transaction from exercising all their rights and obligations under the transaction documents. This document cannot be reproduced except in full, without prior written approval of the Company. Any unauthorized alteration, forgery or falsification of the content or appearance of this document is unlawful and offenders may be prosecuted to the fullest extent of the law.

Report Number :ER-2021-20085
 Operation Mode :802.11ax20
 Test Frequency :5745 MHz
 Test Mode :Tx CH Low
 EUT Pol :H Plane

Test Site :SAC III Chamber
 Test Date :2021-03-17
 Temp./Humi. :22.8/65
 Antenna Pol. :VERTICAL
 Engineer :Ricky

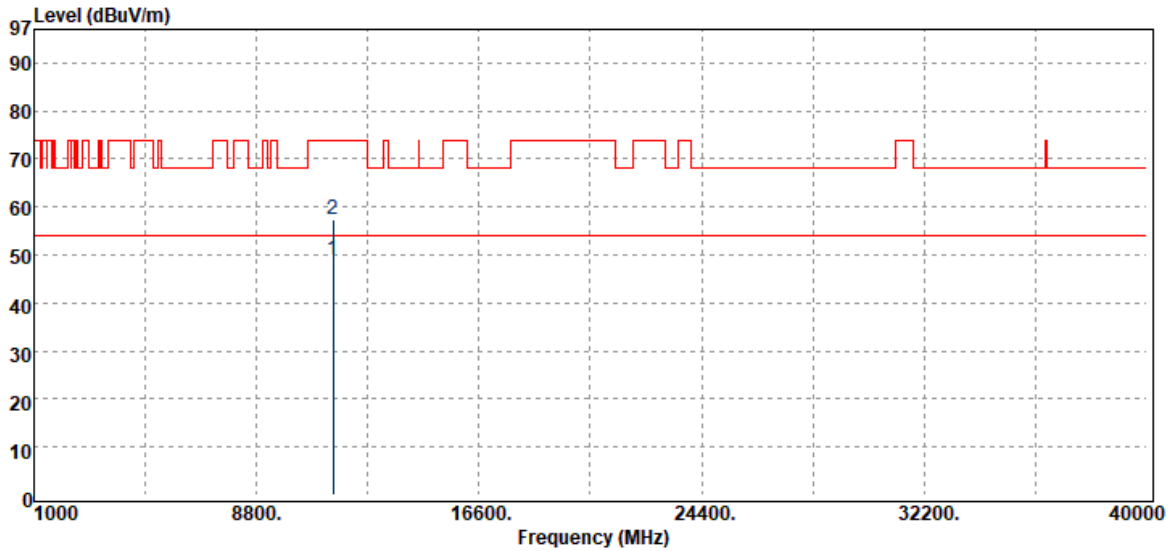

| Freq. MHz | Detector Mode PK/QP/AV | Spectrum Reading Level dB μ V | Factor dB | Actual FS dB μ V/m | Limit @3m dB μ V/m | Margin dB |
|--------------|------------------------------|---|--------------|------------------------------|------------------------------|--------------|
| 11490.00 | Average | 24.53 | 24.41 | 48.94 | 54.00 | -5.06 |
| 11490.00 | Peak | 32.98 | 24.41 | 57.39 | 74.00 | -16.61 |

Unless otherwise stated the results shown in this test report refer only to the sample(s) tested and such sample(s) are retained for 90 days only.

除非另有說明，此報告結果僅對測試之樣品負責，同時此樣品僅保留90天。本報告未經本公司書面許可，不可部份複製。

This document is issued by the Company subject to its General Conditions of Service printed overleaf, available on request or accessible at <http://www.sgs.com.tw/Terms-and-Conditions> and for electronic format documents, subject to Terms and Conditions for Electronic Documents at <http://www.sgs.com.tw/Terms-and-Conditions>. Attention is drawn to the limitation of liability, indemnification and jurisdiction issues defined therein. Any holder of this document is advised that information contained hereon reflects the Company's findings at the time of its intervention only and within the limits of Client's instructions, if any. The Company's sole responsibility is to its Client and this document does not exonerate parties to a transaction from exercising all their rights and obligations under the transaction documents. This document cannot be reproduced except in full, without prior written approval of the Company. Any unauthorized alteration, forgery or falsification of the content or appearance of this document is unlawful and offenders may be prosecuted to the fullest extent of the law.

Report Number :ER-2021-20085
Operation Mode :802.11ax20
Test Frequency :5745 MHz
Test Mode :Tx CH Low
EUT Pol :H Plane

Test Site :SAC III Chamber
Test Date :2021-03-17
Temp./Humi. :22.8/65
Antenna Pol. :HORIZONTAL
Engineer :Ricky

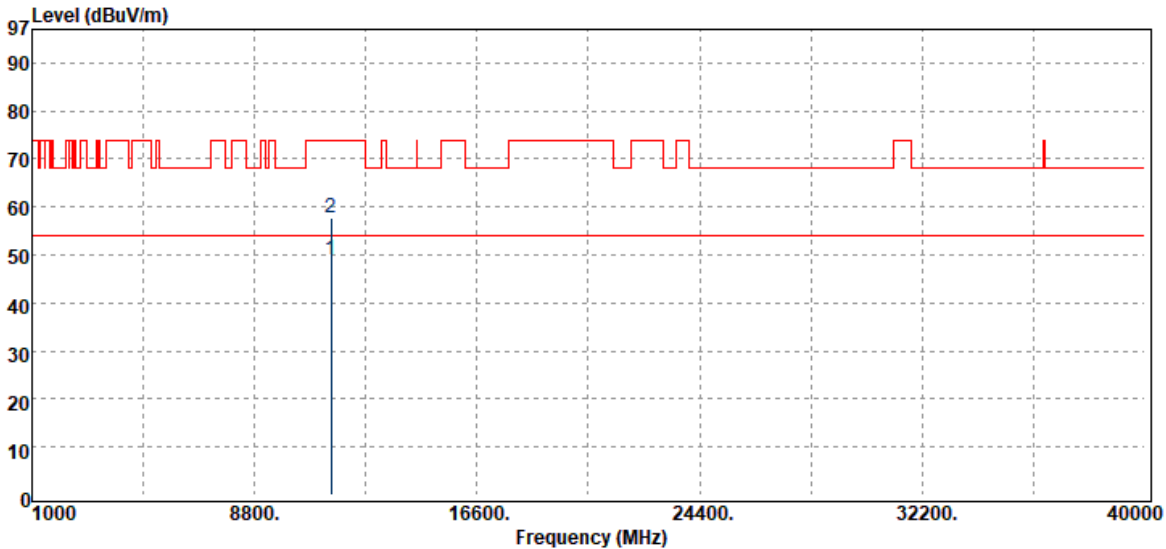

| Freq. MHz | Detector Mode PK/QP/AV | Spectrum Reading Level dB μ V | Factor dB | Actual FS dB μ V/m | Limit @3m dB μ V/m | Margin dB |
|--------------|------------------------------|---|--------------|------------------------------|------------------------------|--------------|
| 11490.00 | Average | 24.52 | 24.41 | 48.93 | 54.00 | -5.07 |
| 11490.00 | Peak | 33.45 | 24.41 | 57.86 | 74.00 | -16.14 |

Unless otherwise stated the results shown in this test report refer only to the sample(s) tested and such sample(s) are retained for 90 days only.

除非另有說明，此報告結果僅對測試之樣品負責，同時此樣品僅保留90天。本報告未經本公司書面許可，不可部份複製。

This document is issued by the Company subject to its General Conditions of Service printed overleaf, available on request or accessible at <http://www.sgs.com.tw/Terms-and-Conditions> and for electronic format documents, subject to Terms and Conditions for Electronic Documents at <http://www.sgs.com.tw/Terms-and-Conditions>. Attention is drawn to the limitation of liability, indemnification and jurisdiction issues defined therein. Any holder of this document is advised that information contained hereon reflects the Company's findings at the time of its intervention only and within the limits of Client's instructions, if any. The Company's sole responsibility is to its Client and this document does not exonerate parties to a transaction from exercising all their rights and obligations under the transaction documents. This document cannot be reproduced except in full, without prior written approval of the Company. Any unauthorized alteration, forgery or falsification of the content or appearance of this document is unlawful and offenders may be prosecuted to the fullest extent of the law.

Report Number :ER-2021-20085
 Operation Mode :802.11ax20
 Test Frequency :5785 MHz
 Test Mode :Tx CH Mid
 EUT Pol :H Plane

Test Site :SAC III Chamber
 Test Date :2021-03-17
 Temp./Humi. :22.8/65
 Antenna Pol. :VERTICAL
 Engineer :Ricky

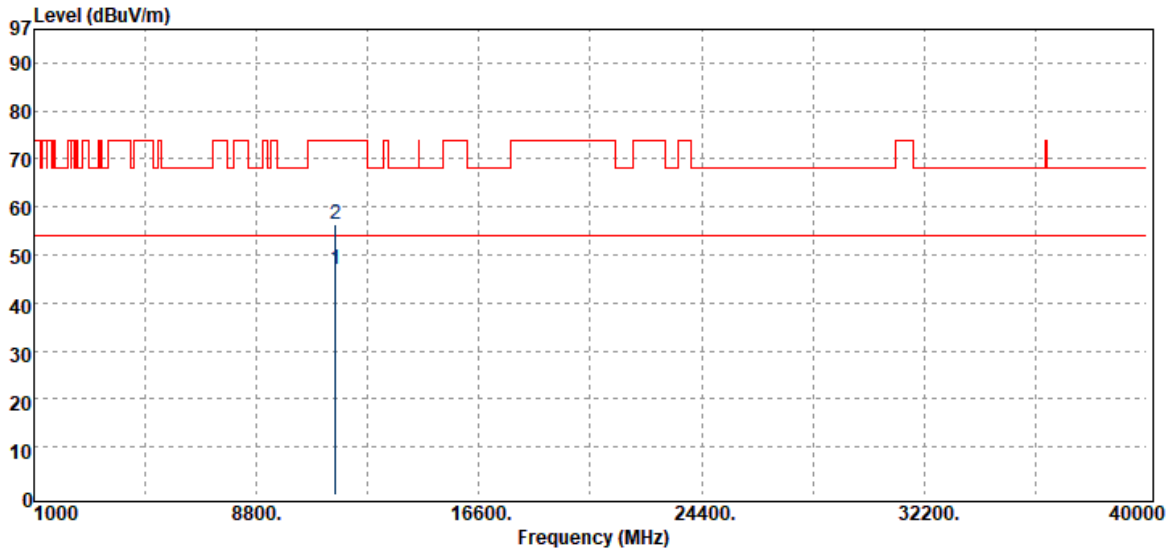

| Freq. MHz | Detector Mode PK/QP/AV | Spectrum Reading Level dB μ V | Factor dB | Actual FS dB μ V/m | Limit @3m dB μ V/m | Margin dB |
|--------------|------------------------------|---|--------------|------------------------------|------------------------------|--------------|
| 11570.00 | Average | 25.12 | 21.84 | 46.96 | 54.00 | -7.04 |
| 11570.00 | Peak | 34.50 | 21.84 | 56.34 | 74.00 | -17.66 |

Unless otherwise stated the results shown in this test report refer only to the sample(s) tested and such sample(s) are retained for 90 days only.

除非另有說明，此報告結果僅對測試之樣品負責，同時此樣品僅保留90天。本報告未經本公司書面許可，不可部份複製。

This document is issued by the Company subject to its General Conditions of Service printed overleaf, available on request or accessible at <http://www.sgs.com.tw/Terms-and-Conditions> and for electronic format documents, subject to Terms and Conditions for Electronic Documents at <http://www.sgs.com.tw/Terms-and-Conditions>. Attention is drawn to the limitation of liability, indemnification and jurisdiction issues defined therein. Any holder of this document is advised that information contained hereon reflects the Company's findings at the time of its intervention only and within the limits of Client's instructions, if any. The Company's sole responsibility is to its Client and this document does not exonerate parties to a transaction from exercising all their rights and obligations under the transaction documents. This document cannot be reproduced except in full, without prior written approval of the Company. Any unauthorized alteration, forgery or falsification of the content or appearance of this document is unlawful and offenders may be prosecuted to the fullest extent of the law.

Report Number :ER-2021-20085
 Operation Mode :802.11ax20
 Test Frequency :5785 MHz
 Test Mode :Tx CH Mid
 EUT Pol :H Plane

Test Site :SAC III Chamber
 Test Date :2021-03-17
 Temp./Humi. :22.8/65
 Antenna Pol. :HORIZONTAL
 Engineer :Ricky

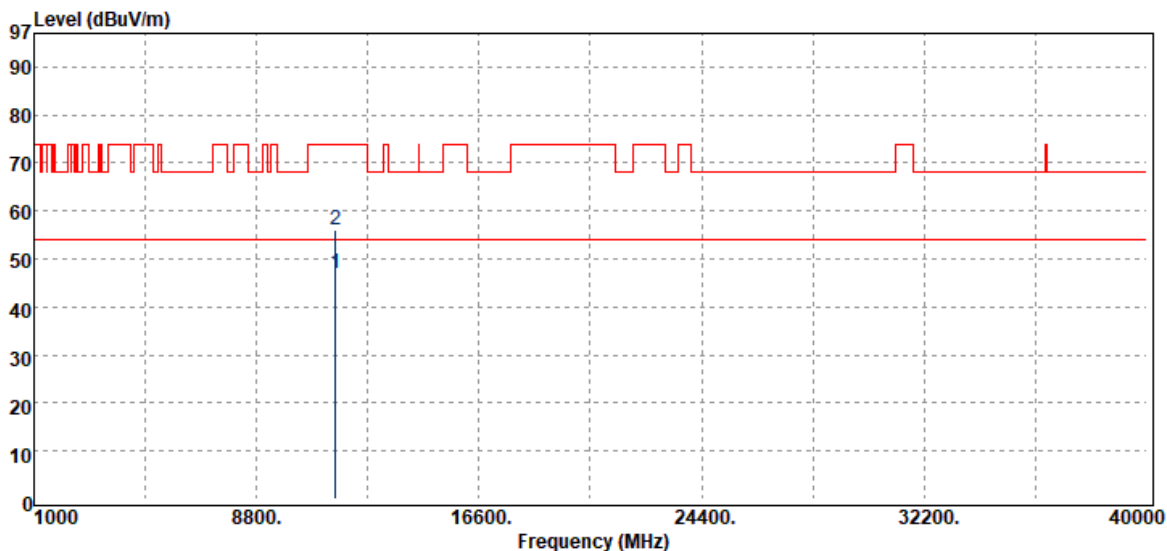

| Freq. MHz | Detector Mode PK/QP/AV | Spectrum Reading Level dB μ V | Factor dB | Actual FS dB μ V/m | Limit @3m dB μ V/m | Margin dB |
|--------------|------------------------------|---|--------------|------------------------------|------------------------------|--------------|
| 11570.00 | Average | 25.13 | 21.84 | 46.97 | 54.00 | -7.03 |
| 11570.00 | Peak | 34.21 | 21.84 | 56.05 | 74.00 | -17.95 |

Unless otherwise stated the results shown in this test report refer only to the sample(s) tested and such sample(s) are retained for 90 days only.

除非另有說明，此報告結果僅對測試之樣品負責，同時此樣品僅保留90天。本報告未經本公司書面許可，不可部份複製。

This document is issued by the Company subject to its General Conditions of Service printed overleaf, available on request or accessible at <http://www.sgs.com.tw/Terms-and-Conditions> and for electronic format documents, subject to Terms and Conditions for Electronic Documents at <http://www.sgs.com.tw/Terms-and-Conditions>. Attention is drawn to the limitation of liability, indemnification and jurisdiction issues defined therein. Any holder of this document is advised that information contained hereon reflects the Company's findings at the time of its intervention only and within the limits of Client's instructions, if any. The Company's sole responsibility is to its Client and this document does not exonerate parties to a transaction from exercising all their rights and obligations under the transaction documents. This document cannot be reproduced except in full, without prior written approval of the Company. Any unauthorized alteration, forgery or falsification of the content or appearance of this document is unlawful and offenders may be prosecuted to the fullest extent of the law.

Report Number :ER-2021-20085
 Operation Mode :802.11ax20
 Test Frequency :5825 MHz
 Test Mode :Tx CH High
 EUT Pol :H Plane

Test Site :SAC III Chamber
 Test Date :2021-03-17
 Temp./Humi. :22.8/65
 Antenna Pol. :VERTICAL
 Engineer :Ricky

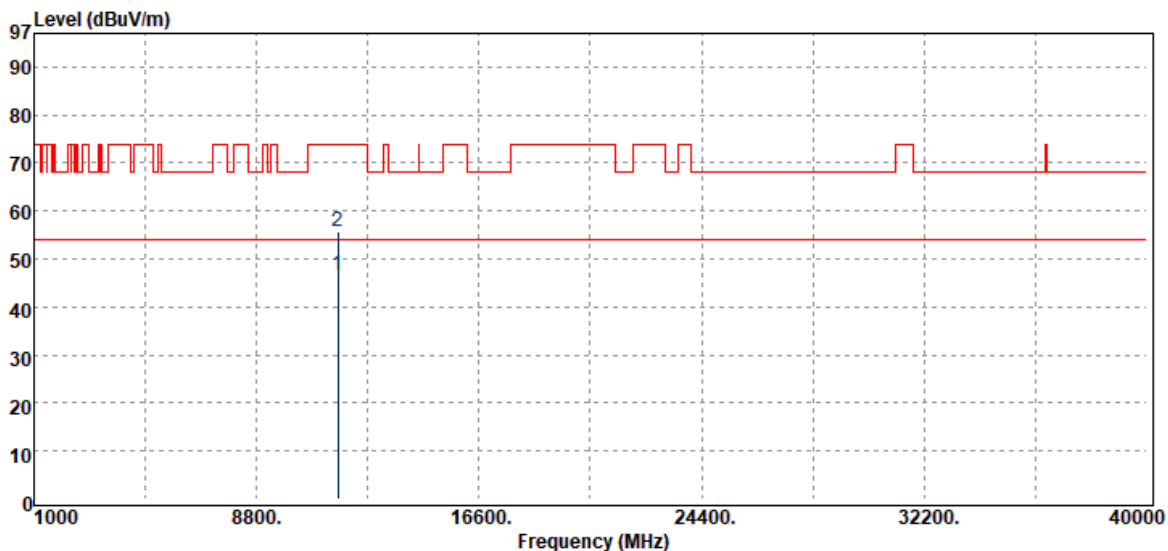

| Freq. MHz | Detector Mode PK/QP/AV | Spectrum Reading Level dB μ V | Factor dB | Actual FS dB μ V/m | Limit @3m dB μ V/m | Margin dB |
|--------------|------------------------------|---|--------------|------------------------------|------------------------------|--------------|
| 11650.00 | Average | 24.46 | 22.13 | 46.59 | 54.00 | -7.41 |
| 11650.00 | Peak | 33.56 | 22.13 | 55.69 | 74.00 | -18.31 |

Unless otherwise stated the results shown in this test report refer only to the sample(s) tested and such sample(s) are retained for 90 days only.

除非另有說明，此報告結果僅對測試之樣品負責，同時此樣品僅保留90天。本報告未經本公司書面許可，不可部份複製。

This document is issued by the Company subject to its General Conditions of Service printed overleaf, available on request or accessible at <http://www.sgs.com.tw/Terms-and-Conditions> and for electronic format documents, subject to Terms and Conditions for Electronic Documents at <http://www.sgs.com.tw/Terms-and-Conditions>. Attention is drawn to the limitation of liability, indemnification and jurisdiction issues defined therein. Any holder of this document is advised that information contained hereon reflects the Company's findings at the time of its intervention only and within the limits of Client's instructions, if any. The Company's sole responsibility is to its Client and this document does not exonerate parties to a transaction from exercising all their rights and obligations under the transaction documents. This document cannot be reproduced except in full, without prior written approval of the Company. Any unauthorized alteration, forgery or falsification of the content or appearance of this document is unlawful and offenders may be prosecuted to the fullest extent of the law.

Report Number :ER-2021-20085
 Operation Mode :802.11ax20
 Test Frequency :5825 MHz
 Test Mode :Tx CH High
 EUT Pol :H Plane

Test Site :SAC III Chamber
 Test Date :2021-03-17
 Temp./Humi. :22.8/65
 Antenna Pol. :HORIZONTAL
 Engineer :Ricky

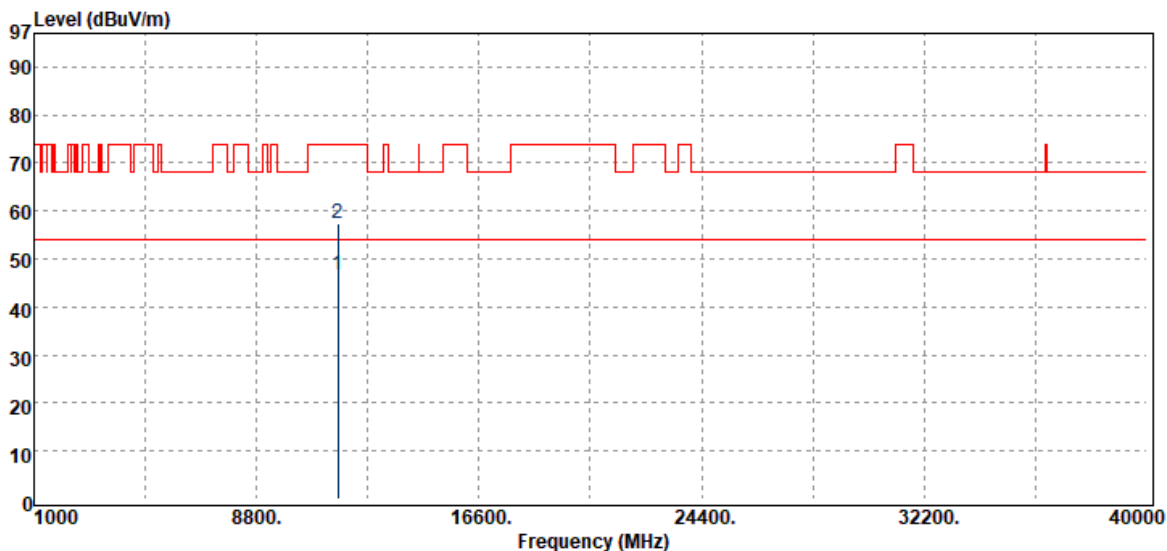

| Freq. MHz | Detector Mode PK/QP/AV | Spectrum Reading Level dB μ V | Factor dB | Actual FS dB μ V/m | Limit @3m dB μ V/m | Margin dB |
|--------------|------------------------------|---|--------------|------------------------------|------------------------------|--------------|
| 11650.00 | Average | 24.45 | 22.13 | 46.58 | 54.00 | -7.42 |
| 11650.00 | Peak | 35.36 | 22.13 | 57.49 | 74.00 | -16.51 |

Unless otherwise stated the results shown in this test report refer only to the sample(s) tested and such sample(s) are retained for 90 days only.

除非另有說明，此報告結果僅對測試之樣品負責，同時此樣品僅保留90天。本報告未經本公司書面許可，不可部份複製。

This document is issued by the Company subject to its General Conditions of Service printed overleaf, available on request or accessible at <http://www.sgs.com.tw/Terms-and-Conditions> and for electronic format documents, subject to Terms and Conditions for Electronic Documents at <http://www.sgs.com.tw/Terms-and-Conditions>. Attention is drawn to the limitation of liability, indemnification and jurisdiction issues defined therein. Any holder of this document is advised that information contained hereon reflects the Company's findings at the time of its intervention only and within the limits of Client's instructions, if any. The Company's sole responsibility is to its Client and this document does not exonerate parties to a transaction from exercising all their rights and obligations under the transaction documents. This document cannot be reproduced except in full, without prior written approval of the Company. Any unauthorized alteration, forgery or falsification of the content or appearance of this document is unlawful and offenders may be prosecuted to the fullest extent of the law.

Report Number :ER-2021-20085
 Operation Mode :802.11ax40
 Test Frequency :5190 MHz
 Test Mode :Tx CH Low
 EUT Pol :H Plane

Test Site :SAC III Chamber
 Test Date :2021-03-17
 Temp./Humi. :22.8/65
 Antenna Pol. :VERTICAL
 Engineer :Ricky



| Freq. MHz | Detector Mode PK/QP/AV | Spectrum Reading Level dB μ V | Factor dB | Actual FS dB μ V/m | Limit @3m dB μ V/m | Margin dB |
|--------------|------------------------------|---|--------------|------------------------------|------------------------------|--------------|
| 10380.00 | Peak | 35.59 | 19.70 | 55.29 | 68.20 | -12.91 |

Unless otherwise stated the results shown in this test report refer only to the sample(s) tested and such sample(s) are retained for 90 days only.

除非另有說明，此報告結果僅對測試之樣品負責，同時此樣品僅保留90天。本報告未經本公司書面許可，不可部份複製。

This document is issued by the Company subject to its General Conditions of Service printed overleaf, available on request or accessible at <http://www.sgs.com.tw/Terms-and-Conditions> and for electronic format documents, subject to Terms and Conditions for Electronic Documents at <http://www.sgs.com.tw/Terms-and-Conditions>. Attention is drawn to the limitation of liability, indemnification and jurisdiction issues defined therein. Any holder of this document is advised that information contained hereon reflects the Company's findings at the time of its intervention only and within the limits of Client's instructions, if any. The Company's sole responsibility is to its Client and this document does not exonerate parties to a transaction from exercising all their rights and obligations under the transaction documents. This document cannot be reproduced except in full, without prior written approval of the Company. Any unauthorized alteration, forgery or falsification of the content or appearance of this document is unlawful and offenders may be prosecuted to the fullest extent of the law.

Report Number :ER-2021-20085
 Operation Mode :802.11ax40
 Test Frequency :5190 MHz
 Test Mode :Tx CH Low
 EUT Pol :H Plane

Test Site :SAC III Chamber
 Test Date :2021-03-17
 Temp./Humi. :22.8/65
 Antenna Pol. :HORIZONTAL
 Engineer :Ricky

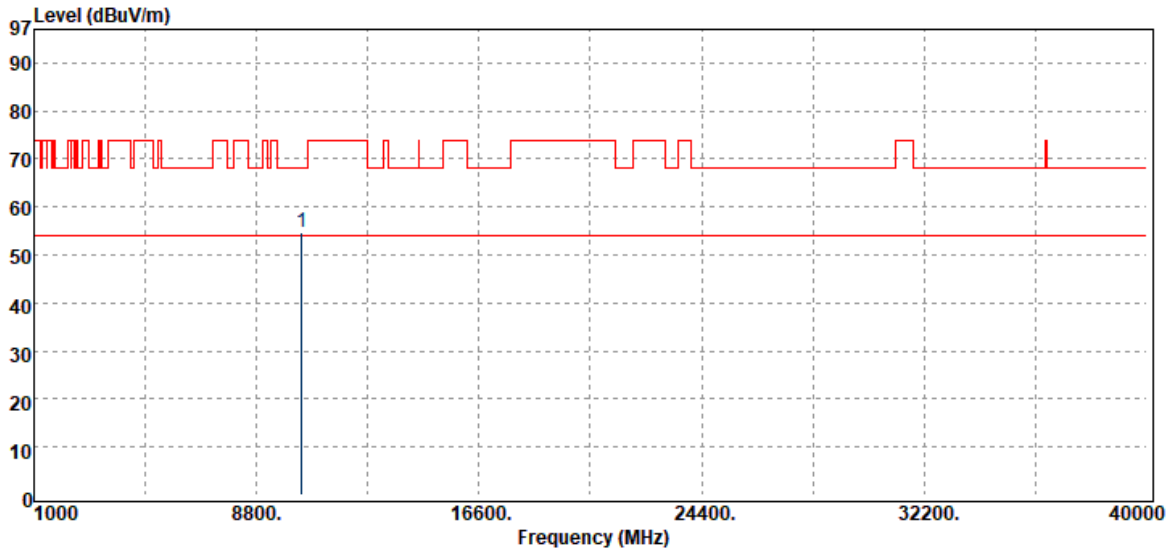

| Freq. MHz | Detector Mode PK/QP/AV | Spectrum Reading Level dB μ V | Factor dB | Actual FS dB μ V/m | Limit @3m dB μ V/m | Margin dB |
|--------------|------------------------------|---|--------------|------------------------------|------------------------------|--------------|
| 10380.00 | Peak | 35.13 | 19.70 | 54.83 | 68.20 | -13.37 |

Unless otherwise stated the results shown in this test report refer only to the sample(s) tested and such sample(s) are retained for 90 days only.

除非另有說明，此報告結果僅對測試之樣品負責，同時此樣品僅保留90天。本報告未經本公司書面許可，不可部份複製。

This document is issued by the Company subject to its General Conditions of Service printed overleaf, available on request or accessible at <http://www.sgs.com.tw/Terms-and-Conditions> and for electronic format documents, subject to Terms and Conditions for Electronic Documents at <http://www.sgs.com.tw/Terms-and-Conditions>. Attention is drawn to the limitation of liability, indemnification and jurisdiction issues defined therein. Any holder of this document is advised that information contained hereon reflects the Company's findings at the time of its intervention only and within the limits of Client's instructions, if any. The Company's sole responsibility is to its Client and this document does not exonerate parties to a transaction from exercising all their rights and obligations under the transaction documents. This document cannot be reproduced except in full, without prior written approval of the Company. Any unauthorized alteration, forgery or falsification of the content or appearance of this document is unlawful and offenders may be prosecuted to the fullest extent of the law.

Report Number :ER-2021-20085
 Operation Mode :802.11ax40
 Test Frequency :5230 MHz
 Test Mode :Tx CH High
 EUT Pol :H Plane

Test Site :SAC III Chamber
 Test Date :2021-03-17
 Temp./Humi. :22.8/65
 Antenna Pol. :VERTICAL
 Engineer :Ricky



| Freq. MHz | Detector Mode PK/QP/AV | Spectrum Reading Level dB μ V | Factor dB | Actual FS dB μ V/m | Limit @3m dB μ V/m | Margin dB |
|--------------|------------------------------|---|--------------|------------------------------|------------------------------|--------------|
| 10460.00 | Peak | 34.15 | 19.22 | 53.37 | 68.20 | -14.83 |

Unless otherwise stated the results shown in this test report refer only to the sample(s) tested and such sample(s) are retained for 90 days only.

除非另有說明，此報告結果僅對測試之樣品負責，同時此樣品僅保留90天。本報告未經本公司書面許可，不可部份複製。

This document is issued by the Company subject to its General Conditions of Service printed overleaf, available on request or accessible at <http://www.sgs.com.tw/Terms-and-Conditions> and for electronic format documents, subject to Terms and Conditions for Electronic Documents at <http://www.sgs.com.tw/Terms-and-Conditions>. Attention is drawn to the limitation of liability, indemnification and jurisdiction issues defined therein. Any holder of this document is advised that information contained hereon reflects the Company's findings at the time of its intervention only and within the limits of Client's instructions, if any. The Company's sole responsibility is to its Client and this document does not exonerate parties to a transaction from exercising all their rights and obligations under the transaction documents. This document cannot be reproduced except in full, without prior written approval of the Company. Any unauthorized alteration, forgery or falsification of the content or appearance of this document is unlawful and offenders may be prosecuted to the fullest extent of the law.

Report Number :ER-2021-20085
 Operation Mode :802.11ax40
 Test Frequency :5230 MHz
 Test Mode :Tx CH High
 EUT Pol :H Plane

Test Site :SAC III Chamber
 Test Date :2021-03-17
 Temp./Humi. :22.8/65
 Antenna Pol. :HORIZONTAL
 Engineer :Ricky

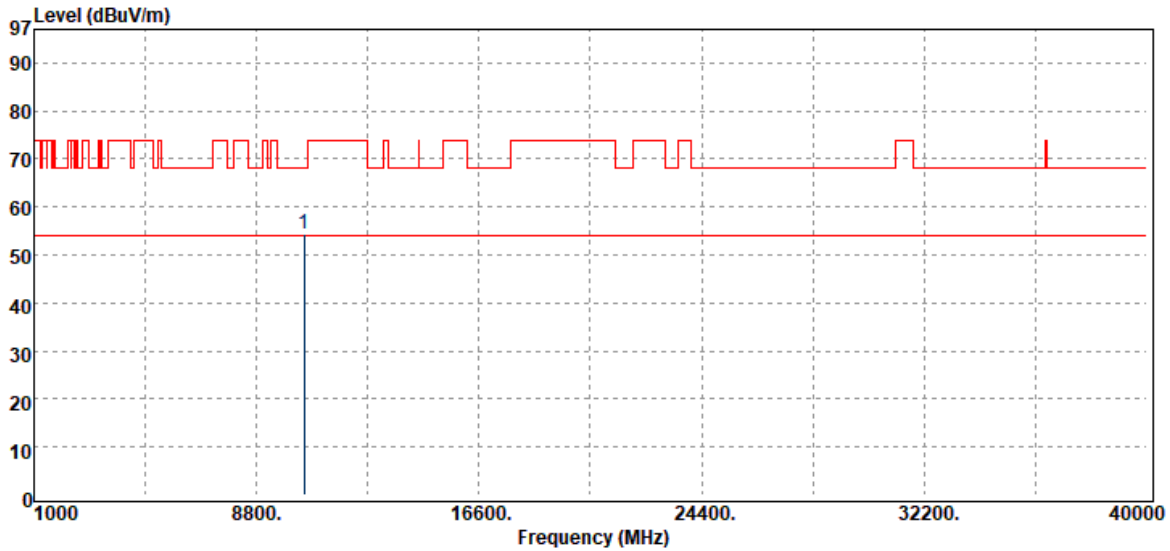

| Freq. MHz | Detector Mode PK/QP/AV | Spectrum Reading Level dB μ V | Factor dB | Actual FS dB μ V/m | Limit @3m dB μ V/m | Margin dB |
|--------------|------------------------------|---|--------------|------------------------------|------------------------------|--------------|
| 10460.00 | Peak | 35.19 | 19.22 | 54.41 | 68.20 | -13.79 |

Unless otherwise stated the results shown in this test report refer only to the sample(s) tested and such sample(s) are retained for 90 days only.

除非另有說明，此報告結果僅對測試之樣品負責，同時此樣品僅保留90天。本報告未經本公司書面許可，不可部份複製。

This document is issued by the Company subject to its General Conditions of Service printed overleaf, available on request or accessible at <http://www.sgs.com.tw/Terms-and-Conditions> and for electronic format documents, subject to Terms and Conditions for Electronic Documents at <http://www.sgs.com.tw/Terms-and-Conditions>. Attention is drawn to the limitation of liability, indemnification and jurisdiction issues defined therein. Any holder of this document is advised that information contained hereon reflects the Company's findings at the time of its intervention only and within the limits of Client's instructions, if any. The Company's sole responsibility is to its Client and this document does not exonerate parties to a transaction from exercising all their rights and obligations under the transaction documents. This document cannot be reproduced except in full, without prior written approval of the Company. Any unauthorized alteration, forgery or falsification of the content or appearance of this document is unlawful and offenders may be prosecuted to the fullest extent of the law.

Report Number :ER-2021-20085
 Operation Mode :802.11ax40
 Test Frequency :5270 MHz
 Test Mode :Tx CH Low
 EUT Pol :H Plane

Test Site :SAC III Chamber
 Test Date :2021-03-17
 Temp./Humi. :22.8/65
 Antenna Pol. :VERTICAL
 Engineer :Ricky

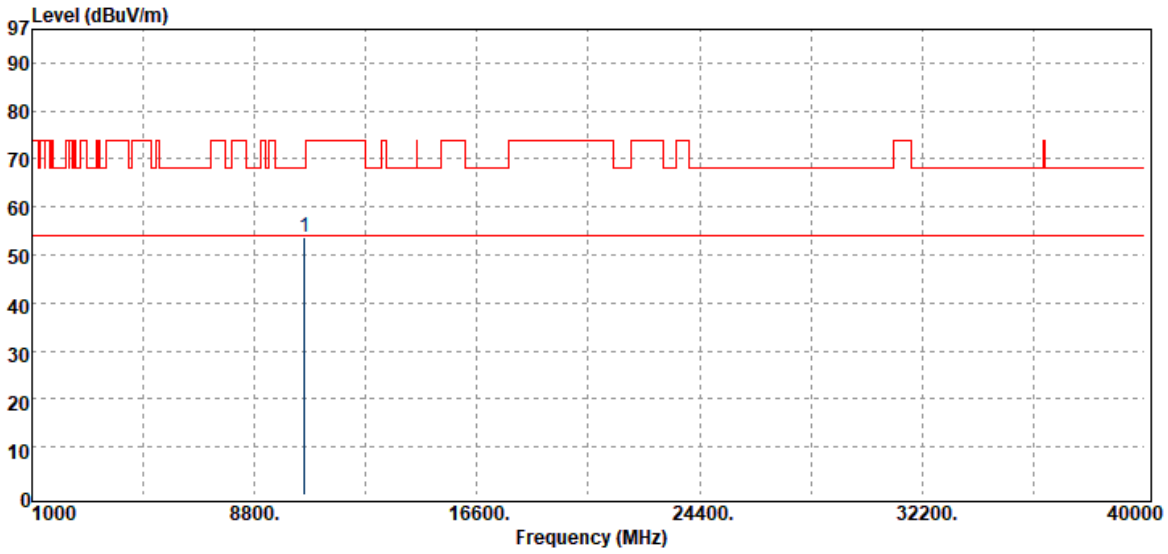

| Freq. MHz | Detector Mode PK/QP/AV | Spectrum Reading Level dB μ V | Factor dB | Actual FS dB μ V/m | Limit @3m dB μ V/m | Margin dB |
|--------------|------------------------------|---|--------------|------------------------------|------------------------------|--------------|
| 10540.00 | Peak | 33.93 | 19.78 | 53.71 | 68.20 | -14.49 |

Unless otherwise stated the results shown in this test report refer only to the sample(s) tested and such sample(s) are retained for 90 days only.

除非另有說明，此報告結果僅對測試之樣品負責，同時此樣品僅保留90天。本報告未經本公司書面許可，不可部份複製。

This document is issued by the Company subject to its General Conditions of Service printed overleaf, available on request or accessible at <http://www.sgs.com.tw/Terms-and-Conditions> and for electronic format documents, subject to Terms and Conditions for Electronic Documents at <http://www.sgs.com.tw/Terms-and-Conditions>. Attention is drawn to the limitation of liability, indemnification and jurisdiction issues defined therein. Any holder of this document is advised that information contained hereon reflects the Company's findings at the time of its intervention only and within the limits of Client's instructions, if any. The Company's sole responsibility is to its Client and this document does not exonerate parties to a transaction from exercising all their rights and obligations under the transaction documents. This document cannot be reproduced except in full, without prior written approval of the Company. Any unauthorized alteration, forgery or falsification of the content or appearance of this document is unlawful and offenders may be prosecuted to the fullest extent of the law.

Report Number :ER-2021-20085
 Operation Mode :802.11ax40
 Test Frequency :5270 MHz
 Test Mode :Tx CH Low
 EUT Pol :H Plane

Test Site :SAC III Chamber
 Test Date :2021-03-17
 Temp./Humi. :22.8/65
 Antenna Pol. :HORIZONTAL
 Engineer :Ricky

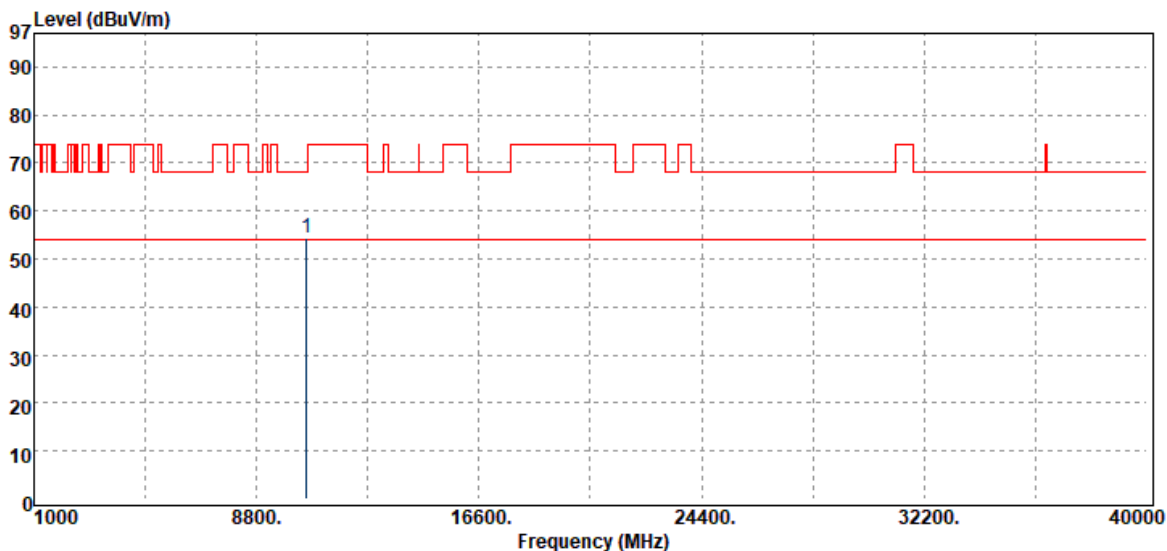

| Freq. MHz | Detector Mode PK/QP/AV | Spectrum Reading Level dB μ V | Factor dB | Actual FS dB μ V/m | Limit @3m dB μ V/m | Margin dB |
|--------------|------------------------------|---|--------------|------------------------------|------------------------------|--------------|
| 10540.00 | Peak | 34.68 | 19.78 | 54.46 | 68.20 | -13.74 |

Unless otherwise stated the results shown in this test report refer only to the sample(s) tested and such sample(s) are retained for 90 days only.

除非另有說明，此報告結果僅對測試之樣品負責，同時此樣品僅保留90天。本報告未經本公司書面許可，不可部份複製。

This document is issued by the Company subject to its General Conditions of Service printed overleaf, available on request or accessible at <http://www.sgs.com.tw/Terms-and-Conditions> and for electronic format documents, subject to Terms and Conditions for Electronic Documents at <http://www.sgs.com.tw/Terms-and-Conditions>. Attention is drawn to the limitation of liability, indemnification and jurisdiction issues defined therein. Any holder of this document is advised that information contained hereon reflects the Company's findings at the time of its intervention only and within the limits of Client's instructions, if any. The Company's sole responsibility is to its Client and this document does not exonerate parties to a transaction from exercising all their rights and obligations under the transaction documents. This document cannot be reproduced except in full, without prior written approval of the Company. Any unauthorized alteration, forgery or falsification of the content or appearance of this document is unlawful and offenders may be prosecuted to the fullest extent of the law.

Report Number :ER-2021-20085
 Operation Mode :802.11ax40
 Test Frequency :5310 MHz
 Test Mode :Tx CH High
 EUT Pol :H Plane

Test Site :SAC III Chamber
 Test Date :2021-03-17
 Temp./Humi. :22.8/65
 Antenna Pol. :VERTICAL
 Engineer :Ricky

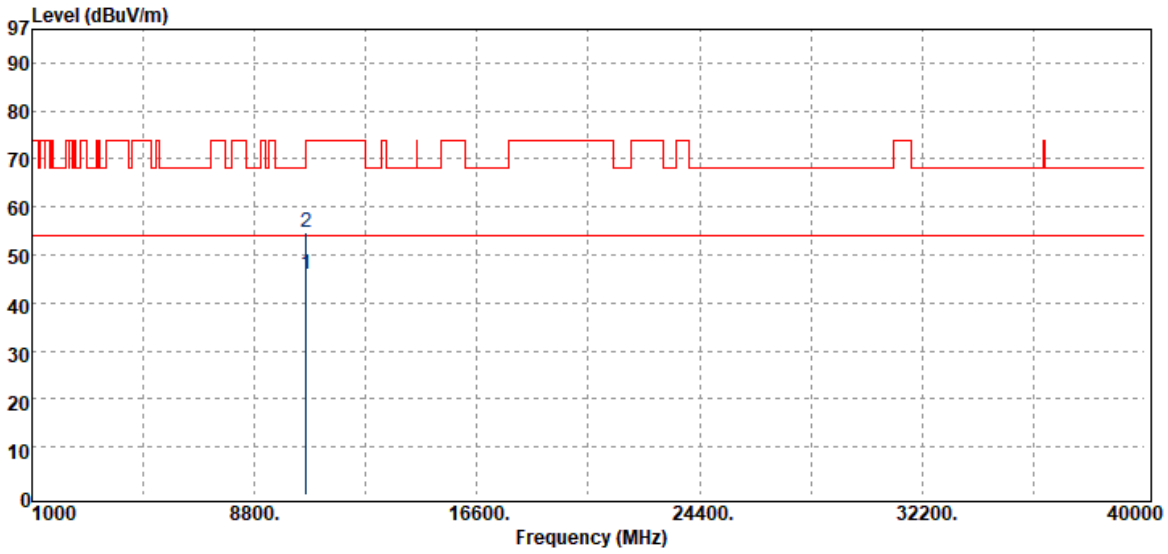

| Freq. MHz | Detector Mode PK/QP/AV | Spectrum Reading Level dBμV | Factor dB | Actual FS dBμV/m | Limit @3m dBμV/m | Margin dB |
|--------------|------------------------------|-----------------------------------|--------------|------------------------|------------------------|--------------|
| 10620.00 | Average | 25.84 | 20.12 | 45.96 | 54.00 | -8.04 |
| 10620.00 | Peak | 34.74 | 20.12 | 54.86 | 74.00 | -19.14 |

Unless otherwise stated the results shown in this test report refer only to the sample(s) tested and such sample(s) are retained for 90 days only.

除非另有說明，此報告結果僅對測試之樣品負責，同時此樣品僅保留90天。本報告未經本公司書面許可，不可部份複製。

This document is issued by the Company subject to its General Conditions of Service printed overleaf, available on request or accessible at <http://www.sgs.com.tw/Terms-and-Conditions> and for electronic format documents, subject to Terms and Conditions for Electronic Documents at <http://www.sgs.com.tw/Terms-and-Conditions>. Attention is drawn to the limitation of liability, indemnification and jurisdiction issues defined therein. Any holder of this document is advised that information contained hereon reflects the Company's findings at the time of its intervention only and within the limits of Client's instructions, if any. The Company's sole responsibility is to its Client and this document does not exonerate parties to a transaction from exercising all their rights and obligations under the transaction documents. This document cannot be reproduced except in full, without prior written approval of the Company. Any unauthorized alteration, forgery or falsification of the content or appearance of this document is unlawful and offenders may be prosecuted to the fullest extent of the law.

Report Number :ER-2021-20085
 Operation Mode :802.11ax40
 Test Frequency :5310 MHz
 Test Mode :Tx CH High
 EUT Pol :H Plane

Test Site :SAC III Chamber
 Test Date :2021-03-17
 Temp./Humi. :22.8/65
 Antenna Pol. :HORIZONTAL
 Engineer :Ricky

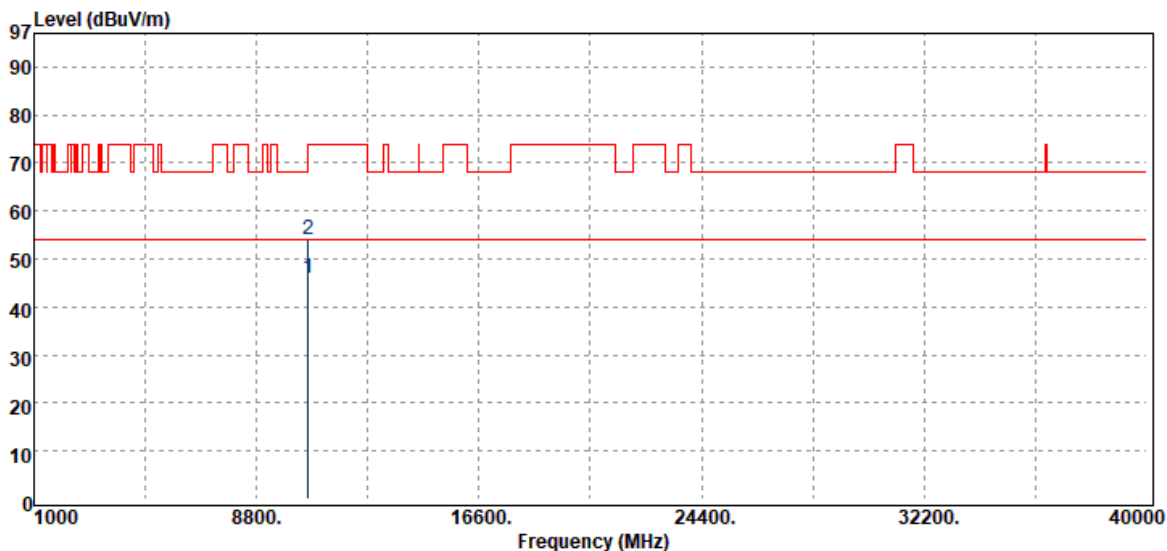

| Freq. MHz | Detector Mode PK/QP/AV | Spectrum Reading Level dB μ V | Factor dB | Actual FS dB μ V/m | Limit @3m dB μ V/m | Margin dB |
|--------------|------------------------------|---|--------------|------------------------------|------------------------------|--------------|
| 10620.00 | Average | 25.78 | 20.12 | 45.90 | 54.00 | -8.10 |
| 10620.00 | Peak | 33.98 | 20.12 | 54.10 | 74.00 | -19.90 |

Unless otherwise stated the results shown in this test report refer only to the sample(s) tested and such sample(s) are retained for 90 days only.

除非另有說明，此報告結果僅對測試之樣品負責，同時此樣品僅保留90天。本報告未經本公司書面許可，不可部份複製。

This document is issued by the Company subject to its General Conditions of Service printed overleaf, available on request or accessible at <http://www.sgs.com.tw/Terms-and-Conditions> and for electronic format documents, subject to Terms and Conditions for Electronic Documents at <http://www.sgs.com.tw/Terms-and-Conditions>. Attention is drawn to the limitation of liability, indemnification and jurisdiction issues defined therein. Any holder of this document is advised that information contained hereon reflects the Company's findings at the time of its intervention only and within the limits of Client's instructions, if any. The Company's sole responsibility is to its Client and this document does not exonerate parties to a transaction from exercising all their rights and obligations under the transaction documents. This document cannot be reproduced except in full, without prior written approval of the Company. Any unauthorized alteration, forgery or falsification of the content or appearance of this document is unlawful and offenders may be prosecuted to the fullest extent of the law.

Report Number :ER-2021-20085
 Operation Mode :802.11ax40
 Test Frequency :5510 MHz
 Test Mode :Tx CH Low
 EUT Pol :H Plane

Test Site :SAC III Chamber
 Test Date :2021-03-17
 Temp./Humi. :22.8/65
 Antenna Pol. :VERTICAL
 Engineer :Ricky

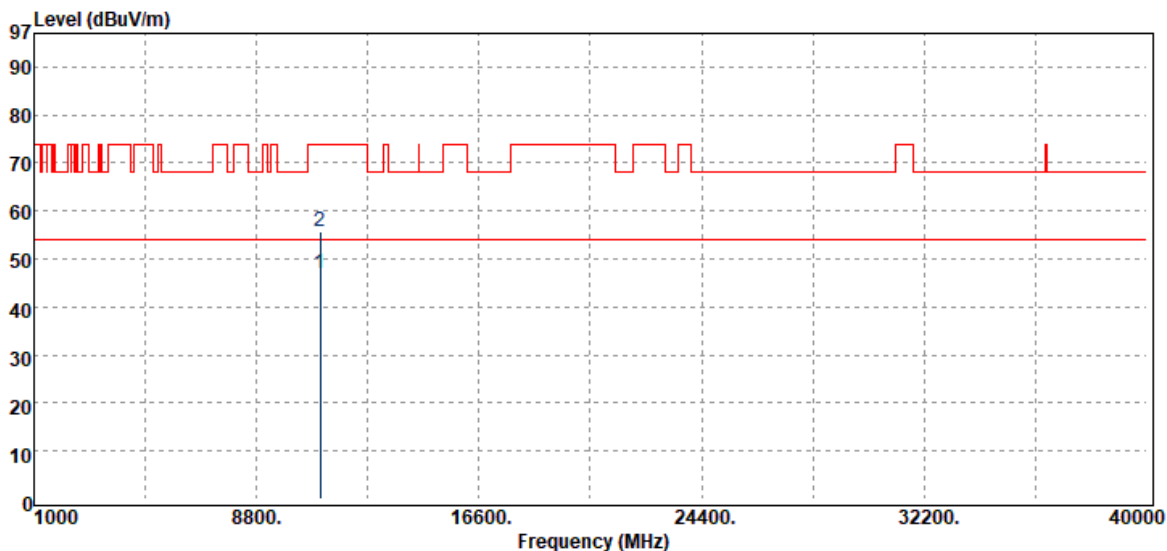

| Freq. MHz | Detector Mode PK/QP/AV | Spectrum Reading Level dB μ V | Factor dB | Actual FS dB μ V/m | Limit @3m dB μ V/m | Margin dB |
|--------------|------------------------------|---|--------------|------------------------------|------------------------------|--------------|
| 11020.00 | Average | 25.42 | 21.61 | 47.03 | 54.00 | -6.97 |
| 11020.00 | Peak | 34.15 | 21.61 | 55.76 | 74.00 | -18.24 |

Unless otherwise stated the results shown in this test report refer only to the sample(s) tested and such sample(s) are retained for 90 days only.

除非另有說明，此報告結果僅對測試之樣品負責，同時此樣品僅保留90天。本報告未經本公司書面許可，不可部份複製。

This document is issued by the Company subject to its General Conditions of Service printed overleaf, available on request or accessible at <http://www.sgs.com.tw/Terms-and-Conditions> and for electronic format documents, subject to Terms and Conditions for Electronic Documents at <http://www.sgs.com.tw/Terms-and-Conditions>. Attention is drawn to the limitation of liability, indemnification and jurisdiction issues defined therein. Any holder of this document is advised that information contained hereon reflects the Company's findings at the time of its intervention only and within the limits of Client's instructions, if any. The Company's sole responsibility is to its Client and this document does not exonerate parties to a transaction from exercising all their rights and obligations under the transaction documents. This document cannot be reproduced except in full, without prior written approval of the Company. Any unauthorized alteration, forgery or falsification of the content or appearance of this document is unlawful and offenders may be prosecuted to the fullest extent of the law.

Report Number :ER-2021-20085
 Operation Mode :802.11ax40
 Test Frequency :5510 MHz
 Test Mode :Tx CH Low
 EUT Pol :H Plane

Test Site :SAC III Chamber
 Test Date :2021-03-17
 Temp./Humi. :22.8/65
 Antenna Pol. :HORIZONTAL
 Engineer :Ricky

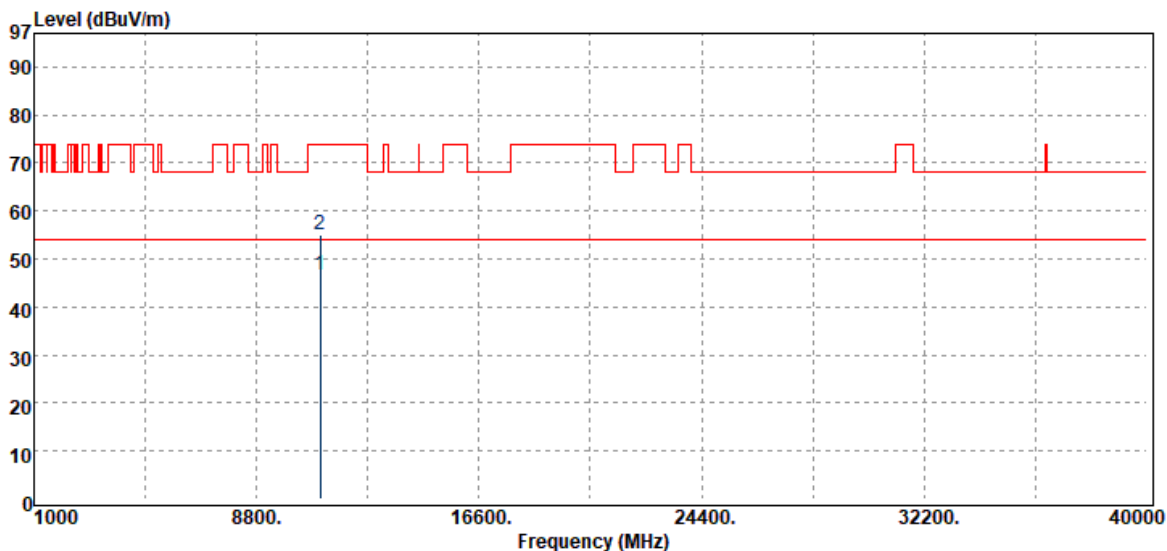

| Freq. MHz | Detector Mode PK/QP/AV | Spectrum Reading Level dB μ V | Factor dB | Actual FS dB μ V/m | Limit @3m dB μ V/m | Margin dB |
|--------------|------------------------------|---|--------------|------------------------------|------------------------------|--------------|
| 11020.00 | Average | 25.20 | 21.61 | 46.81 | 54.00 | -7.19 |
| 11020.00 | Peak | 33.39 | 21.61 | 55.00 | 74.00 | -19.00 |

Unless otherwise stated the results shown in this test report refer only to the sample(s) tested and such sample(s) are retained for 90 days only.

除非另有說明，此報告結果僅對測試之樣品負責，同時此樣品僅保留90天。本報告未經本公司書面許可，不可部份複製。

This document is issued by the Company subject to its General Conditions of Service printed overleaf, available on request or accessible at <http://www.sgs.com.tw/Terms-and-Conditions> and for electronic format documents, subject to Terms and Conditions for Electronic Documents at <http://www.sgs.com.tw/Terms-and-Conditions>. Attention is drawn to the limitation of liability, indemnification and jurisdiction issues defined therein. Any holder of this document is advised that information contained hereon reflects the Company's findings at the time of its intervention only and within the limits of Client's instructions, if any. The Company's sole responsibility is to its Client and this document does not exonerate parties to a transaction from exercising all their rights and obligations under the transaction documents. This document cannot be reproduced except in full, without prior written approval of the Company. Any unauthorized alteration, forgery or falsification of the content or appearance of this document is unlawful and offenders may be prosecuted to the fullest extent of the law.

Report Number :ER-2021-20085
 Operation Mode :802.11ax40
 Test Frequency :5550 MHz
 Test Mode :Tx CH Mid
 EUT Pol :H Plane

Test Site :SAC III Chamber
 Test Date :2021-03-17
 Temp./Humi. :22.8/65
 Antenna Pol. :VERTICAL
 Engineer :Ricky

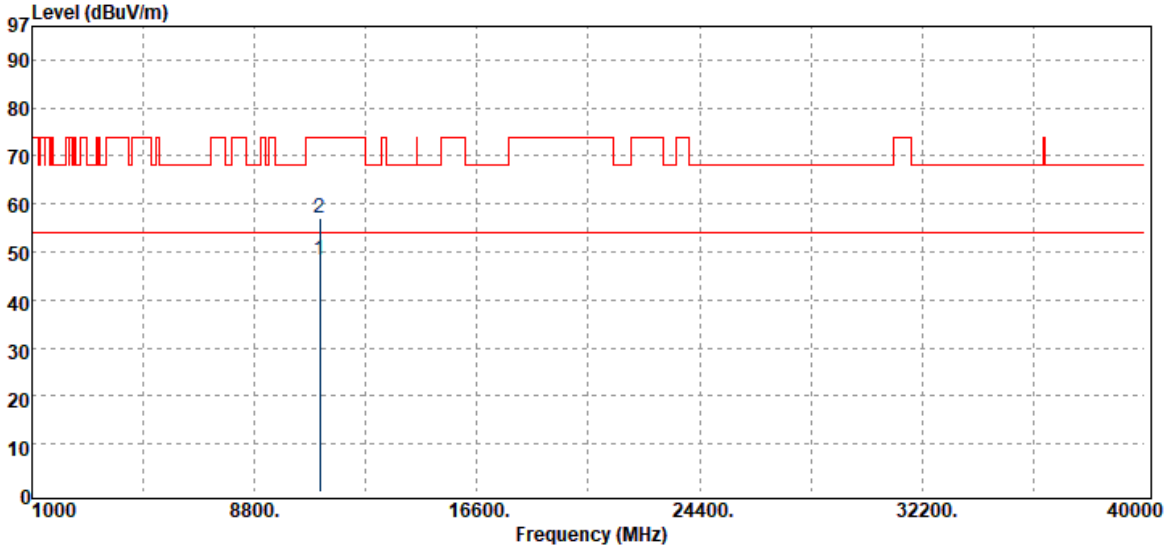

| Freq. MHz | Detector Mode PK/QP/AV | Spectrum Reading Level dB μ V | Factor dB | Actual FS dB μ V/m | Limit @3m dB μ V/m | Margin dB |
|--------------|------------------------------|---|--------------|------------------------------|------------------------------|--------------|
| 11100.00 | Average | 25.40 | 22.83 | 48.23 | 54.00 | -5.77 |
| 11100.00 | Peak | 34.22 | 22.83 | 57.05 | 74.00 | -16.95 |

Unless otherwise stated the results shown in this test report refer only to the sample(s) tested and such sample(s) are retained for 90 days only.

除非另有說明，此報告結果僅對測試之樣品負責，同時此樣品僅保留90天。本報告未經本公司書面許可，不可部份複製。

This document is issued by the Company subject to its General Conditions of Service printed overleaf, available on request or accessible at <http://www.sgs.com.tw/Terms-and-Conditions> and for electronic format documents, subject to Terms and Conditions for Electronic Documents at <http://www.sgs.com.tw/Terms-and-Conditions>. Attention is drawn to the limitation of liability, indemnification and jurisdiction issues defined therein. Any holder of this document is advised that information contained hereon reflects the Company's findings at the time of its intervention only and within the limits of Client's instructions, if any. The Company's sole responsibility is to its Client and this document does not exonerate parties to a transaction from exercising all their rights and obligations under the transaction documents. This document cannot be reproduced except in full, without prior written approval of the Company. Any unauthorized alteration, forgery or falsification of the content or appearance of this document is unlawful and offenders may be prosecuted to the fullest extent of the law.

Report Number :ER-2021-20085
 Operation Mode :802.11ax40
 Test Frequency :5550 MHz
 Test Mode :Tx CH Mid
 EUT Pol :H Plane

Test Site :SAC III Chamber
 Test Date :2021-03-17
 Temp./Humi. :22.8/65
 Antenna Pol. :HORIZONTAL
 Engineer :Ricky

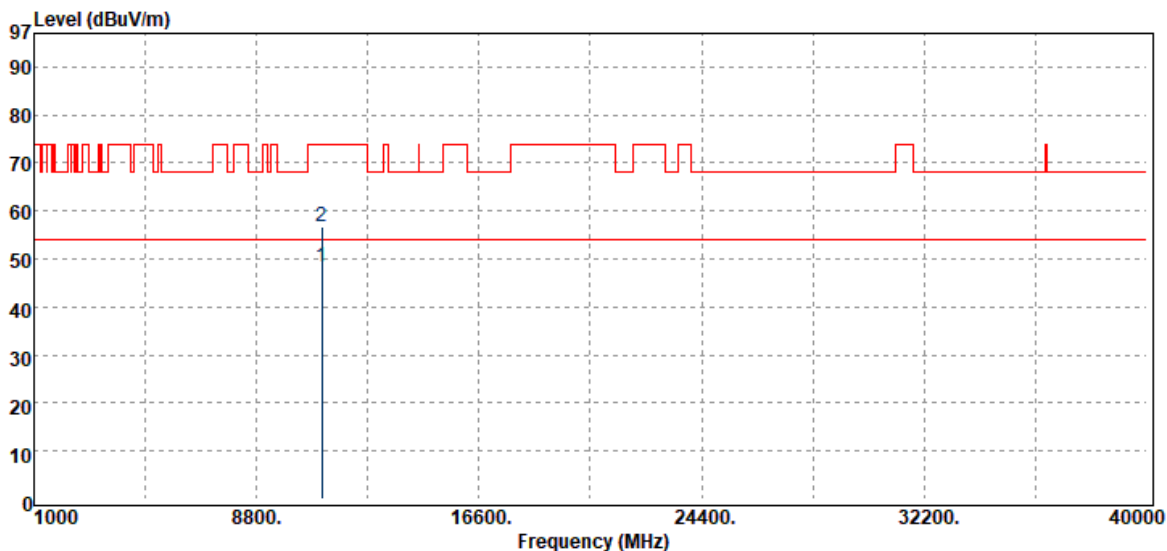

| Freq. MHz | Detector Mode PK/QP/AV | Spectrum Reading Level dBµV | Factor dB | Actual FS dBµV/m | Limit @3m dBµV/m | Margin dB |
|--------------|------------------------------|-----------------------------------|--------------|------------------------|------------------------|--------------|
| 11100.00 | Average | 25.40 | 22.83 | 48.23 | 54.00 | -5.77 |
| 11100.00 | Peak | 34.02 | 22.83 | 56.85 | 74.00 | -17.15 |

Unless otherwise stated the results shown in this test report refer only to the sample(s) tested and such sample(s) are retained for 90 days only.

除非另有說明，此報告結果僅對測試之樣品負責，同時此樣品僅保留90天。本報告未經本公司書面許可，不可部份複製。

This document is issued by the Company subject to its General Conditions of Service printed overleaf, available on request or accessible at <http://www.sgs.com.tw/Terms-and-Conditions> and for electronic format documents, subject to Terms and Conditions for Electronic Documents at <http://www.sgs.com.tw/Terms-and-Conditions>. Attention is drawn to the limitation of liability, indemnification and jurisdiction issues defined therein. Any holder of this document is advised that information contained hereon reflects the Company's findings at the time of its intervention only and within the limits of Client's instructions, if any. The Company's sole responsibility is to its Client and this document does not exonerate parties to a transaction from exercising all their rights and obligations under the transaction documents. This document cannot be reproduced except in full, without prior written approval of the Company. Any unauthorized alteration, forgery or falsification of the content or appearance of this document is unlawful and offenders may be prosecuted to the fullest extent of the law.

Report Number :ER-2021-20085
 Operation Mode :802.11ax40
 Test Frequency :5670 MHz
 Test Mode :Tx CH High
 EUT Pol :H Plane

Test Site :SAC III Chamber
 Test Date :2021-03-17
 Temp./Humi. :22.8/65
 Antenna Pol. :VERTICAL
 Engineer :Ricky

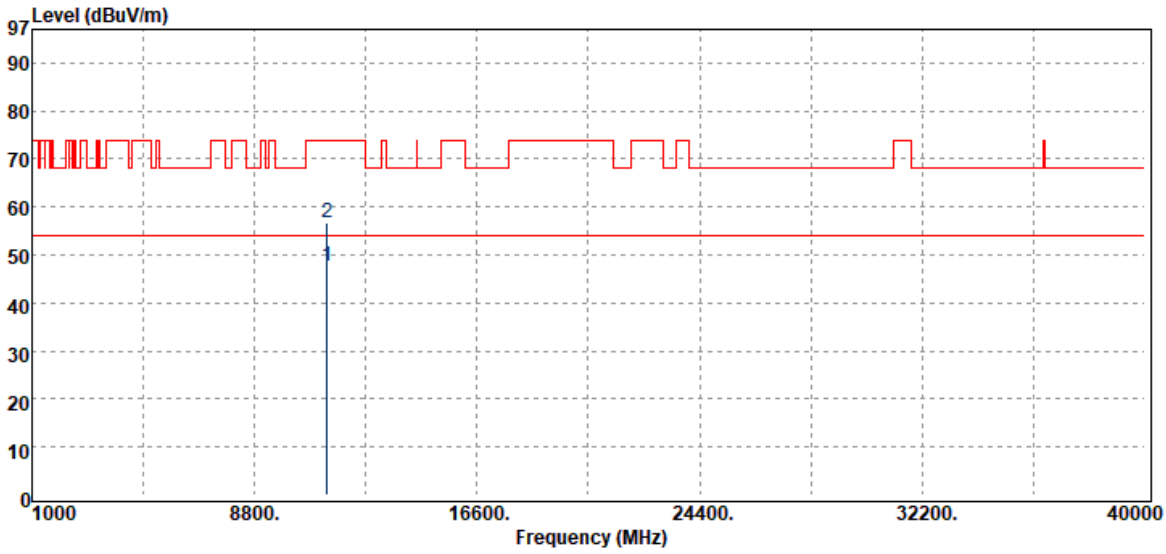

| Freq. MHz | Detector Mode PK/QP/AV | Spectrum Reading Level dB μ V | Factor dB | Actual FS dB μ V/m | Limit @3m dB μ V/m | Margin dB |
|--------------|------------------------------|---|--------------|------------------------------|------------------------------|--------------|
| 11340.00 | Average | 25.40 | 22.19 | 47.59 | 54.00 | -6.41 |
| 11340.00 | Peak | 34.40 | 22.19 | 56.59 | 74.00 | -17.41 |

Unless otherwise stated the results shown in this test report refer only to the sample(s) tested and such sample(s) are retained for 90 days only.

除非另有說明，此報告結果僅對測試之樣品負責，同時此樣品僅保留90天。本報告未經本公司書面許可，不可部份複製。

This document is issued by the Company subject to its General Conditions of Service printed overleaf, available on request or accessible at <http://www.sgs.com.tw/Terms-and-Conditions> and for electronic format documents, subject to Terms and Conditions for Electronic Documents at <http://www.sgs.com.tw/Terms-and-Conditions>. Attention is drawn to the limitation of liability, indemnification and jurisdiction issues defined therein. Any holder of this document is advised that information contained hereon reflects the Company's findings at the time of its intervention only and within the limits of Client's instructions, if any. The Company's sole responsibility is to its Client and this document does not exonerate parties to a transaction from exercising all their rights and obligations under the transaction documents. This document cannot be reproduced except in full, without prior written approval of the Company. Any unauthorized alteration, forgery or falsification of the content or appearance of this document is unlawful and offenders may be prosecuted to the fullest extent of the law.

Report Number :ER-2021-20085
 Operation Mode :802.11ax40
 Test Frequency :5670 MHz
 Test Mode :Tx CH High
 EUT Pol :H Plane

Test Site :SAC III Chamber
 Test Date :2021-03-17
 Temp./Humi. :22.8/65
 Antenna Pol. :HORIZONTAL
 Engineer :Ricky

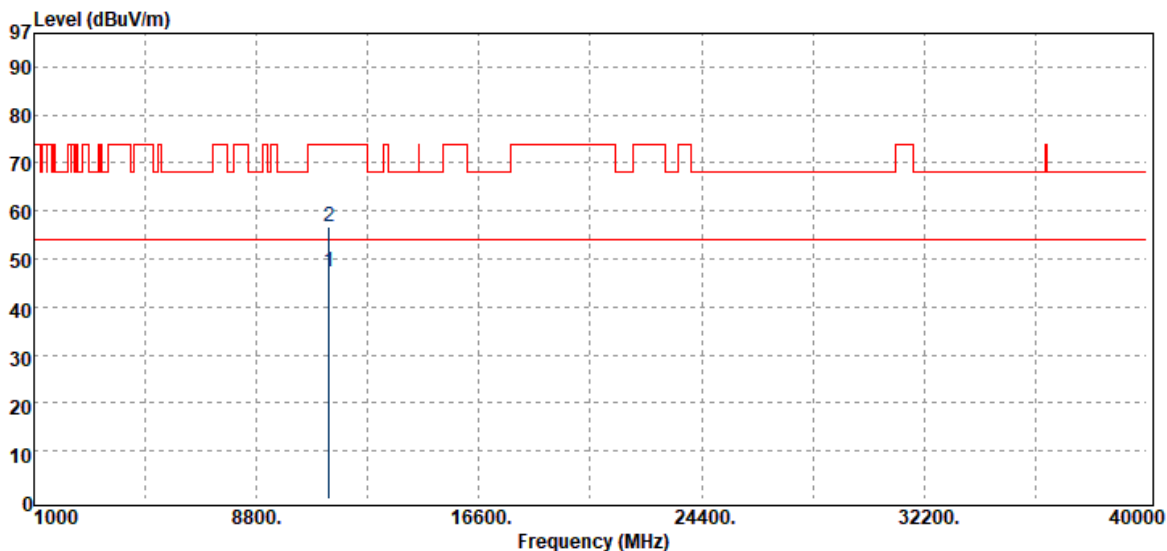

| Freq. MHz | Detector Mode PK/QP/AV | Spectrum Reading Level dB μ V | Factor dB | Actual FS dB μ V/m | Limit @3m dB μ V/m | Margin dB |
|--------------|------------------------------|---|--------------|------------------------------|------------------------------|--------------|
| 11340.00 | Average | 25.28 | 22.19 | 47.47 | 54.00 | -6.53 |
| 11340.00 | Peak | 34.69 | 22.19 | 56.88 | 74.00 | -17.12 |

Unless otherwise stated the results shown in this test report refer only to the sample(s) tested and such sample(s) are retained for 90 days only.

除非另有說明，此報告結果僅對測試之樣品負責，同時此樣品僅保留90天。本報告未經本公司書面許可，不可部份複製。

This document is issued by the Company subject to its General Conditions of Service printed overleaf, available on request or accessible at <http://www.sgs.com.tw/Terms-and-Conditions> and for electronic format documents, subject to Terms and Conditions for Electronic Documents at <http://www.sgs.com.tw/Terms-and-Conditions>. Attention is drawn to the limitation of liability, indemnification and jurisdiction issues defined therein. Any holder of this document is advised that information contained hereon reflects the Company's findings at the time of its intervention only and within the limits of Client's instructions, if any. The Company's sole responsibility is to its Client and this document does not exonerate parties to a transaction from exercising all their rights and obligations under the transaction documents. This document cannot be reproduced except in full, without prior written approval of the Company. Any unauthorized alteration, forgery or falsification of the content or appearance of this document is unlawful and offenders may be prosecuted to the fullest extent of the law.

Report Number :ER-2021-20085
 Operation Mode :802.11ax40
 Test Frequency :5710 MHz
 Test Mode :Tx CH High
 EUT Pol :H Plane

Test Site :SAC III Chamber
 Test Date :2021-03-17
 Temp./Humi. :22.8/65
 Antenna Pol. :VERTICAL
 Engineer :Ricky

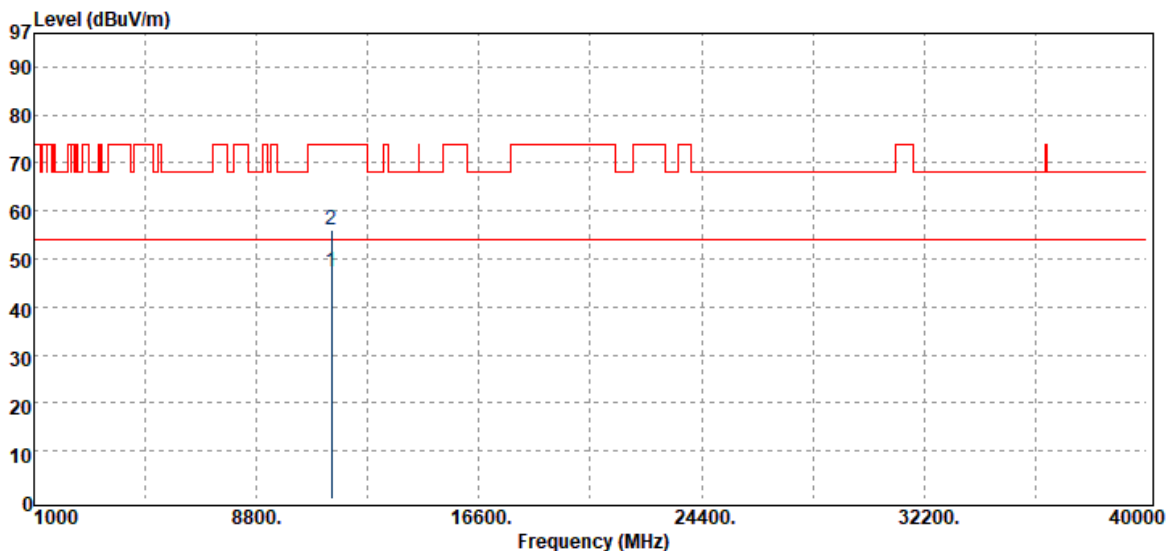

| Freq. MHz | Detector Mode PK/QP/AV | Spectrum Reading Level dBμV | Factor dB | Actual FS dBμV/m | Limit @3m dBμV/m | Margin dB |
|--------------|------------------------------|-----------------------------------|--------------|------------------------|------------------------|--------------|
| 11420.00 | Average | 25.22 | 22.13 | 47.35 | 54.00 | -6.65 |
| 11420.00 | Peak | 33.85 | 22.13 | 55.98 | 74.00 | -18.02 |

Unless otherwise stated the results shown in this test report refer only to the sample(s) tested and such sample(s) are retained for 90 days only.

除非另有說明，此報告結果僅對測試之樣品負責，同時此樣品僅保留90天。本報告未經本公司書面許可，不可部份複製。

This document is issued by the Company subject to its General Conditions of Service printed overleaf, available on request or accessible at <http://www.sgs.com.tw/Terms-and-Conditions> and for electronic format documents, subject to Terms and Conditions for Electronic Documents at <http://www.sgs.com.tw/Terms-and-Conditions>. Attention is drawn to the limitation of liability, indemnification and jurisdiction issues defined therein. Any holder of this document is advised that information contained hereon reflects the Company's findings at the time of its intervention only and within the limits of Client's instructions, if any. The Company's sole responsibility is to its Client and this document does not exonerate parties to a transaction from exercising all their rights and obligations under the transaction documents. This document cannot be reproduced except in full, without prior written approval of the Company. Any unauthorized alteration, forgery or falsification of the content or appearance of this document is unlawful and offenders may be prosecuted to the fullest extent of the law.

Report Number :ER-2021-20085
 Operation Mode :802.11ax40
 Test Frequency :5710 MHz
 Test Mode :Tx CH High
 EUT Pol :H Plane

Test Site :SAC III Chamber
 Test Date :2021-03-17
 Temp./Humi. :22.8/65
 Antenna Pol. :HORIZONTAL
 Engineer :Ricky

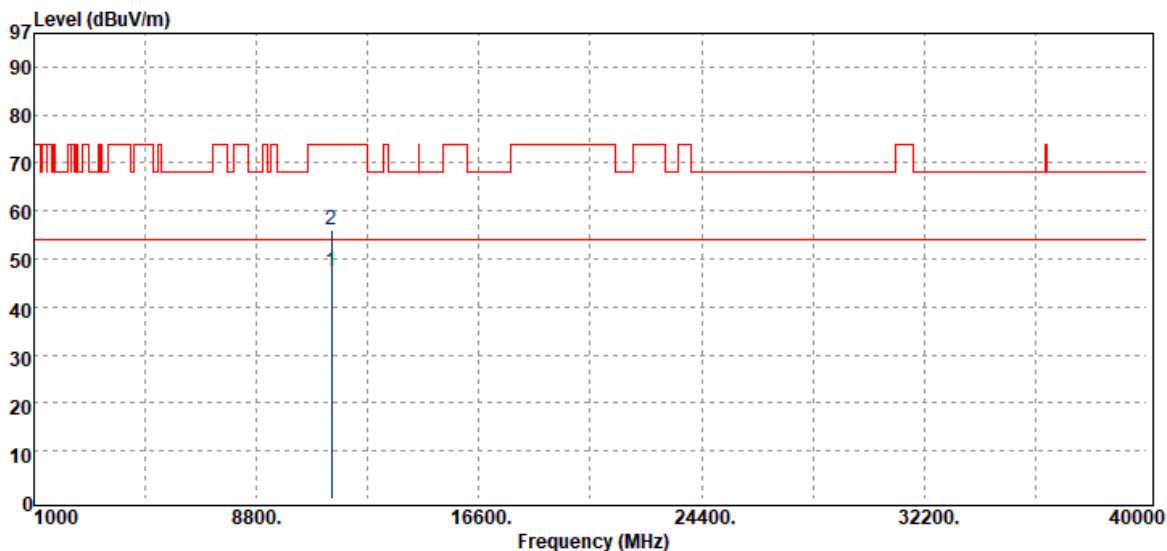

| Freq. MHz | Detector Mode PK/QP/AV | Spectrum Reading Level dB μ V | Factor dB | Actual FS dB μ V/m | Limit @3m dB μ V/m | Margin dB |
|--------------|------------------------------|---|--------------|------------------------------|------------------------------|--------------|
| 11420.00 | Average | 25.11 | 22.13 | 47.24 | 54.00 | -6.76 |
| 11420.00 | Peak | 33.86 | 22.13 | 55.99 | 74.00 | -18.01 |

Unless otherwise stated the results shown in this test report refer only to the sample(s) tested and such sample(s) are retained for 90 days only.

除非另有說明，此報告結果僅對測試之樣品負責，同時此樣品僅保留90天。本報告未經本公司書面許可，不可部份複製。

This document is issued by the Company subject to its General Conditions of Service printed overleaf, available on request or accessible at <http://www.sgs.com.tw/Terms-and-Conditions> and for electronic format documents, subject to Terms and Conditions for Electronic Documents at <http://www.sgs.com.tw/Terms-and-Conditions>. Attention is drawn to the limitation of liability, indemnification and jurisdiction issues defined therein. Any holder of this document is advised that information contained hereon reflects the Company's findings at the time of its intervention only and within the limits of Client's instructions, if any. The Company's sole responsibility is to its Client and this document does not exonerate parties to a transaction from exercising all their rights and obligations under the transaction documents. This document cannot be reproduced except in full, without prior written approval of the Company. Any unauthorized alteration, forgery or falsification of the content or appearance of this document is unlawful and offenders may be prosecuted to the fullest extent of the law.

Report Number :ER-2021-20085
 Operation Mode :802.11ax40
 Test Frequency :5755 MHz
 Test Mode :Tx CH Low
 EUT Pol :H Plane

Test Site :SAC III Chamber
 Test Date :2021-03-17
 Temp./Humi. :22.8/65
 Antenna Pol. :VERTICAL
 Engineer :Ricky

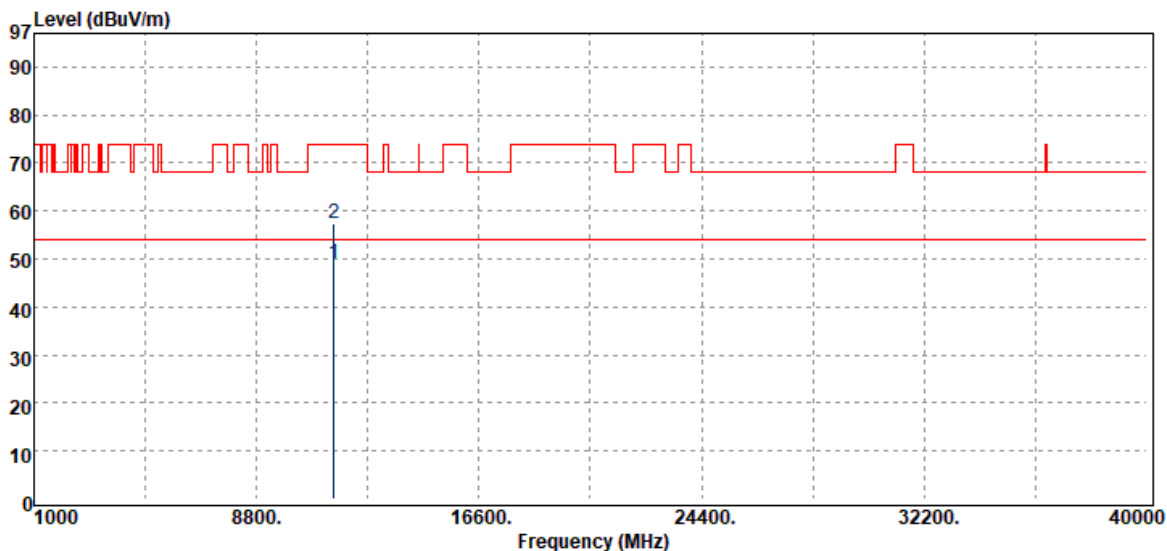

| Freq. MHz | Detector Mode PK/QP/AV | Spectrum Reading Level dB μ V | Factor dB | Actual FS dB μ V/m | Limit @3m dB μ V/m | Margin dB |
|--------------|------------------------------|---|--------------|------------------------------|------------------------------|--------------|
| 11510.00 | Average | 24.80 | 24.31 | 49.11 | 54.00 | -4.89 |
| 11510.00 | Peak | 33.22 | 24.31 | 57.53 | 74.00 | -16.47 |

Unless otherwise stated the results shown in this test report refer only to the sample(s) tested and such sample(s) are retained for 90 days only.

除非另有說明，此報告結果僅對測試之樣品負責，同時此樣品僅保留90天。本報告未經本公司書面許可，不可部份複製。

This document is issued by the Company subject to its General Conditions of Service printed overleaf, available on request or accessible at <http://www.sgs.com.tw/Terms-and-Conditions> and for electronic format documents, subject to Terms and Conditions for Electronic Documents at <http://www.sgs.com.tw/Terms-and-Conditions>. Attention is drawn to the limitation of liability, indemnification and jurisdiction issues defined therein. Any holder of this document is advised that information contained hereon reflects the Company's findings at the time of its intervention only and within the limits of Client's instructions, if any. The Company's sole responsibility is to its Client and this document does not exonerate parties to a transaction from exercising all their rights and obligations under the transaction documents. This document cannot be reproduced except in full, without prior written approval of the Company. Any unauthorized alteration, forgery or falsification of the content or appearance of this document is unlawful and offenders may be prosecuted to the fullest extent of the law.

Report Number :ER-2021-20085
 Operation Mode :802.11ax40
 Test Frequency :5755 MHz
 Test Mode :Tx CH Low
 EUT Pol :H Plane

Test Site :SAC III Chamber
 Test Date :2021-03-17
 Temp./Humi. :22.8/65
 Antenna Pol. :HORIZONTAL
 Engineer :Ricky

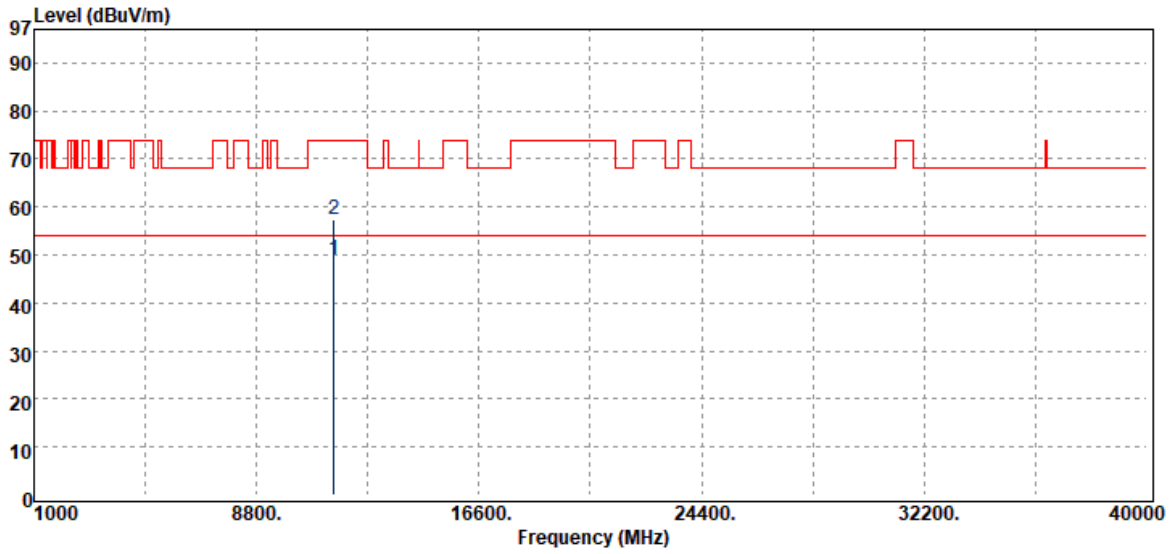

| Freq. MHz | Detector Mode PK/QP/AV | Spectrum Reading Level dB μ V | Factor dB | Actual FS dB μ V/m | Limit @3m dB μ V/m | Margin dB |
|--------------|------------------------------|---|--------------|------------------------------|------------------------------|--------------|
| 11510.00 | Average | 24.78 | 24.31 | 49.09 | 54.00 | -4.91 |
| 11510.00 | Peak | 32.92 | 24.31 | 57.23 | 74.00 | -16.77 |

Unless otherwise stated the results shown in this test report refer only to the sample(s) tested and such sample(s) are retained for 90 days only.

除非另有說明，此報告結果僅對測試之樣品負責，同時此樣品僅保留90天。本報告未經本公司書面許可，不可部份複製。

This document is issued by the Company subject to its General Conditions of Service printed overleaf, available on request or accessible at <http://www.sgs.com.tw/Terms-and-Conditions> and for electronic format documents, subject to Terms and Conditions for Electronic Documents at <http://www.sgs.com.tw/Terms-and-Conditions>. Attention is drawn to the limitation of liability, indemnification and jurisdiction issues defined therein. Any holder of this document is advised that information contained hereon reflects the Company's findings at the time of its intervention only and within the limits of Client's instructions, if any. The Company's sole responsibility is to its Client and this document does not exonerate parties to a transaction from exercising all their rights and obligations under the transaction documents. This document cannot be reproduced except in full, without prior written approval of the Company. Any unauthorized alteration, forgery or falsification of the content or appearance of this document is unlawful and offenders may be prosecuted to the fullest extent of the law.

Report Number :ER-2021-20085
 Operation Mode :802.11ax40
 Test Frequency :5795 MHz
 Test Mode :Tx CH High
 EUT Pol :H Plane

Test Site :SAC III Chamber
 Test Date :2021-03-17
 Temp./Humi. :22.8/65
 Antenna Pol. :VERTICAL
 Engineer :Ricky

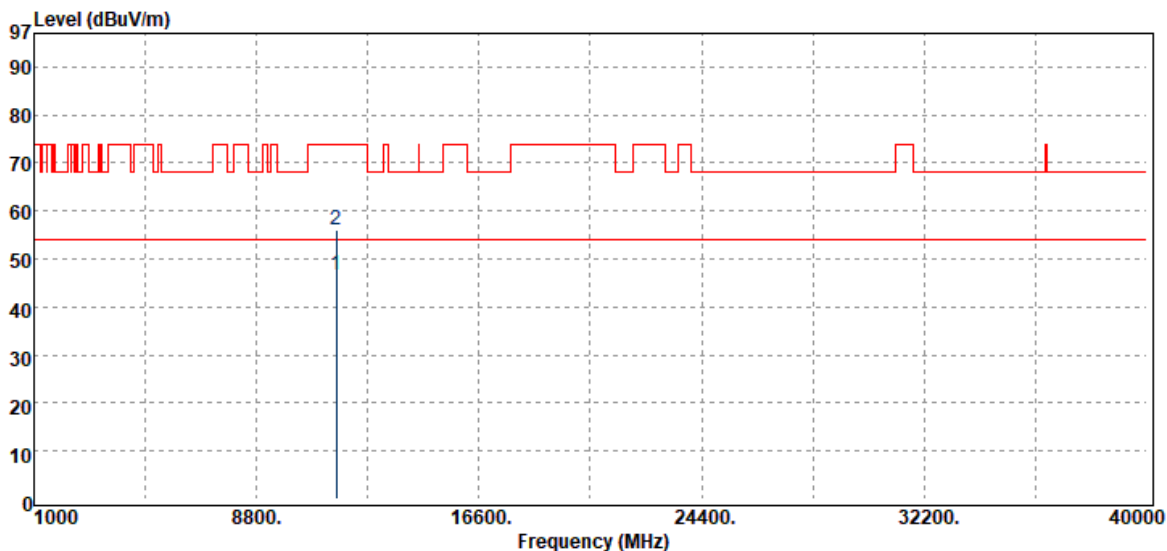

| Freq. MHz | Detector Mode PK/QP/AV | Spectrum Reading Level dB μ V | Factor dB | Actual FS dB μ V/m | Limit @3m dB μ V/m | Margin dB |
|--------------|------------------------------|---|--------------|------------------------------|------------------------------|--------------|
| 11590.00 | Average | 25.57 | 21.17 | 46.74 | 54.00 | -7.26 |
| 11590.00 | Peak | 34.98 | 21.17 | 56.15 | 74.00 | -17.85 |

Unless otherwise stated the results shown in this test report refer only to the sample(s) tested and such sample(s) are retained for 90 days only.

除非另有說明，此報告結果僅對測試之樣品負責，同時此樣品僅保留90天。本報告未經本公司書面許可，不可部份複製。

This document is issued by the Company subject to its General Conditions of Service printed overleaf, available on request or accessible at <http://www.sgs.com.tw/Terms-and-Conditions> and for electronic format documents, subject to Terms and Conditions for Electronic Documents at <http://www.sgs.com.tw/Terms-and-Conditions>. Attention is drawn to the limitation of liability, indemnification and jurisdiction issues defined therein. Any holder of this document is advised that information contained hereon reflects the Company's findings at the time of its intervention only and within the limits of Client's instructions, if any. The Company's sole responsibility is to its Client and this document does not exonerate parties to a transaction from exercising all their rights and obligations under the transaction documents. This document cannot be reproduced except in full, without prior written approval of the Company. Any unauthorized alteration, forgery or falsification of the content or appearance of this document is unlawful and offenders may be prosecuted to the fullest extent of the law.

Report Number :ER-2021-20085
 Operation Mode :802.11ax40
 Test Frequency :5795 MHz
 Test Mode :Tx CH High
 EUT Pol :H Plane

Test Site :SAC III Chamber
 Test Date :2021-03-17
 Temp./Humi. :22.8/65
 Antenna Pol. :HORIZONTAL
 Engineer :Ricky

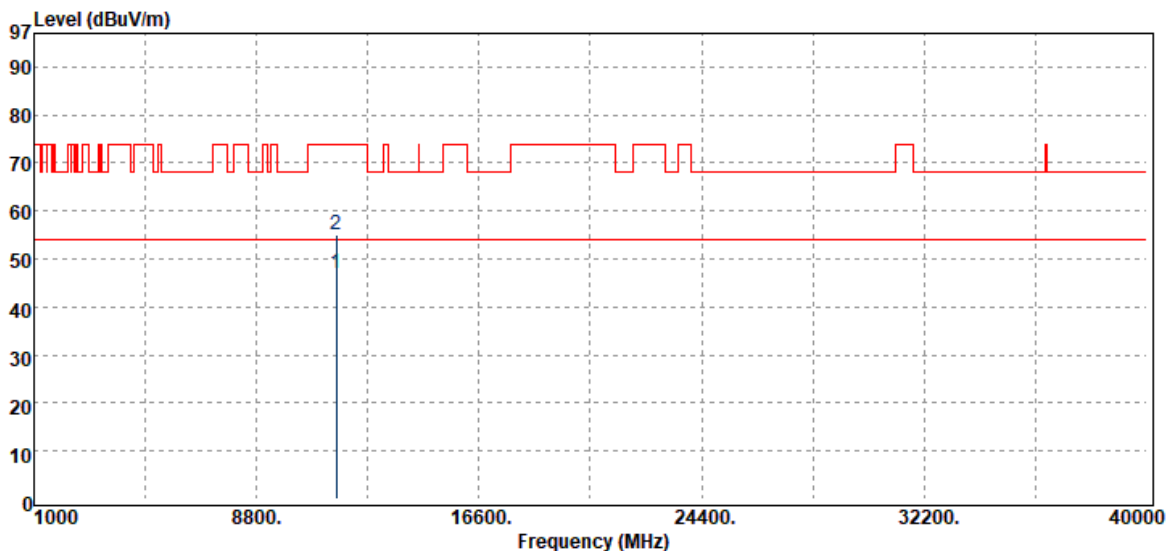

| Freq. MHz | Detector Mode PK/QP/AV | Spectrum Reading Level dB μ V | Factor dB | Actual FS dB μ V/m | Limit @3m dB μ V/m | Margin dB |
|--------------|------------------------------|---|--------------|------------------------------|------------------------------|--------------|
| 11590.00 | Average | 25.70 | 21.17 | 46.87 | 54.00 | -7.13 |
| 11590.00 | Peak | 34.01 | 21.17 | 55.18 | 74.00 | -18.82 |

Unless otherwise stated the results shown in this test report refer only to the sample(s) tested and such sample(s) are retained for 90 days only.

除非另有說明，此報告結果僅對測試之樣品負責，同時此樣品僅保留90天。本報告未經本公司書面許可，不可部份複製。

This document is issued by the Company subject to its General Conditions of Service printed overleaf, available on request or accessible at <http://www.sgs.com.tw/Terms-and-Conditions> and for electronic format documents, subject to Terms and Conditions for Electronic Documents at <http://www.sgs.com.tw/Terms-and-Conditions>. Attention is drawn to the limitation of liability, indemnification and jurisdiction issues defined therein. Any holder of this document is advised that information contained hereon reflects the Company's findings at the time of its intervention only and within the limits of Client's instructions, if any. The Company's sole responsibility is to its Client and this document does not exonerate parties to a transaction from exercising all their rights and obligations under the transaction documents. This document cannot be reproduced except in full, without prior written approval of the Company. Any unauthorized alteration, forgery or falsification of the content or appearance of this document is unlawful and offenders may be prosecuted to the fullest extent of the law.

Report Number :ER-2021-20085
 Operation Mode :802.11ax80
 Test Frequency :5210 MHz
 Test Mode :Tx CH Low
 EUT Pol :H Plane

Test Site :SAC III Chamber
 Test Date :2021-03-17
 Temp./Humi. :22.8/65
 Antenna Pol. :VERTICAL
 Engineer :Ricky

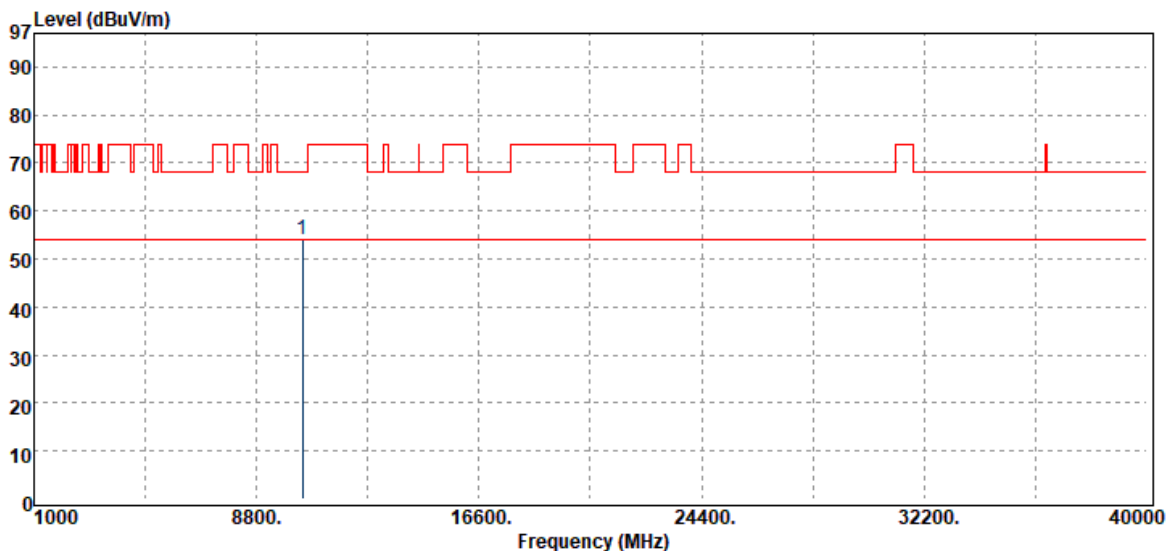

| Freq. MHz | Detector Mode PK/QP/AV | Spectrum Reading Level dB μ V | Factor dB | Actual FS dB μ V/m | Limit @3m dB μ V/m | Margin dB |
|--------------|------------------------------|---|--------------|------------------------------|------------------------------|--------------|
| 10420.00 | Peak | 34.67 | 19.35 | 54.02 | 68.20 | -14.18 |

Unless otherwise stated the results shown in this test report refer only to the sample(s) tested and such sample(s) are retained for 90 days only.

除非另有說明，此報告結果僅對測試之樣品負責，同時此樣品僅保留90天。本報告未經本公司書面許可，不可部份複製。

This document is issued by the Company subject to its General Conditions of Service printed overleaf, available on request or accessible at <http://www.sgs.com.tw/Terms-and-Conditions> and for electronic format documents, subject to Terms and Conditions for Electronic Documents at <http://www.sgs.com.tw/Terms-and-Conditions>. Attention is drawn to the limitation of liability, indemnification and jurisdiction issues defined therein. Any holder of this document is advised that information contained hereon reflects the Company's findings at the time of its intervention only and within the limits of Client's instructions, if any. The Company's sole responsibility is to its Client and this document does not exonerate parties to a transaction from exercising all their rights and obligations under the transaction documents. This document cannot be reproduced except in full, without prior written approval of the Company. Any unauthorized alteration, forgery or falsification of the content or appearance of this document is unlawful and offenders may be prosecuted to the fullest extent of the law.

Report Number :ER-2021-20085
 Operation Mode :802.11ax80
 Test Frequency :5210 MHz
 Test Mode :Tx CH Low
 EUT Pol :H Plane

Test Site :SAC III Chamber
 Test Date :2021-03-17
 Temp./Humi. :22.8/65
 Antenna Pol. :HORIZONTAL
 Engineer :Ricky

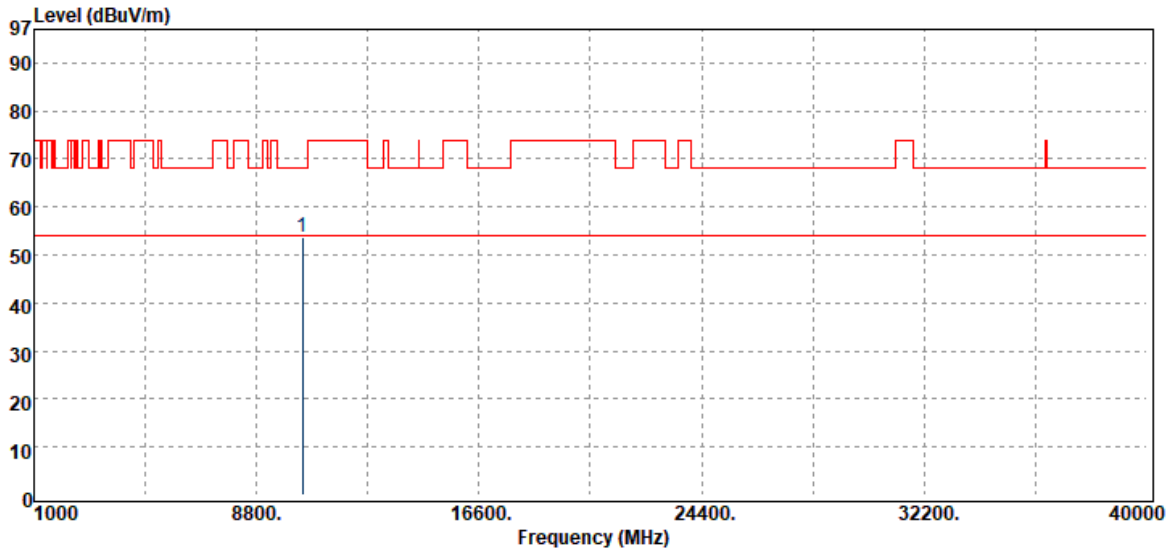

| Freq. MHz | Detector Mode PK/QP/AV | Spectrum Reading Level dB μ V | Factor dB | Actual FS dB μ V/m | Limit @3m dB μ V/m | Margin dB |
|--------------|------------------------------|---|--------------|------------------------------|------------------------------|--------------|
| 10420.00 | Peak | 34.32 | 19.35 | 53.67 | 68.20 | -14.53 |

Unless otherwise stated the results shown in this test report refer only to the sample(s) tested and such sample(s) are retained for 90 days only.

除非另有說明，此報告結果僅對測試之樣品負責，同時此樣品僅保留90天。本報告未經本公司書面許可，不可部份複製。

This document is issued by the Company subject to its General Conditions of Service printed overleaf, available on request or accessible at <http://www.sgs.com.tw/Terms-and-Conditions> and for electronic format documents, subject to Terms and Conditions for Electronic Documents at <http://www.sgs.com.tw/Terms-and-Conditions>. Attention is drawn to the limitation of liability, indemnification and jurisdiction issues defined therein. Any holder of this document is advised that information contained hereon reflects the Company's findings at the time of its intervention only and within the limits of Client's instructions, if any. The Company's sole responsibility is to its Client and this document does not exonerate parties to a transaction from exercising all their rights and obligations under the transaction documents. This document cannot be reproduced except in full, without prior written approval of the Company. Any unauthorized alteration, forgery or falsification of the content or appearance of this document is unlawful and offenders may be prosecuted to the fullest extent of the law.

Report Number :ER-2021-20085
 Operation Mode :802.11ax80
 Test Frequency :5290 MHz
 Test Mode :Tx CH Low
 EUT Pol :H Plane

Test Site :SAC III Chamber
 Test Date :2021-03-17
 Temp./Humi. :22.8/65
 Antenna Pol. :VERTICAL
 Engineer :Ricky

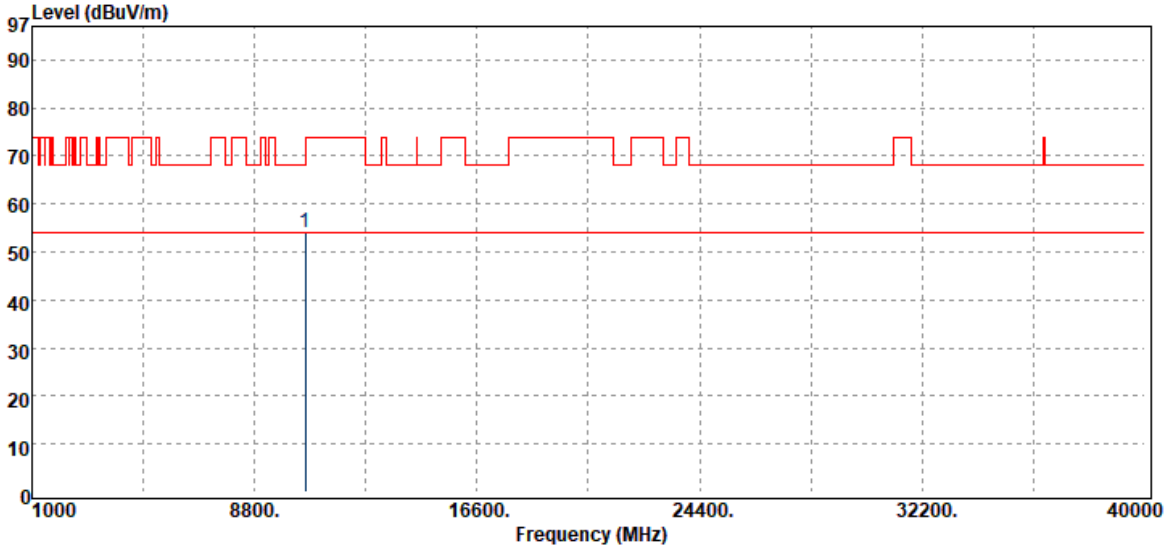

| Freq. MHz | Detector Mode PK/QP/AV | Spectrum Reading Level dB μ V | Factor dB | Actual FS dB μ V/m | Limit @3m dB μ V/m | Margin dB |
|--------------|------------------------------|---|--------------|------------------------------|------------------------------|--------------|
| 10580.00 | Peak | 34.25 | 19.82 | 54.07 | 68.20 | -14.13 |

Unless otherwise stated the results shown in this test report refer only to the sample(s) tested and such sample(s) are retained for 90 days only.

除非另有說明，此報告結果僅對測試之樣品負責，同時此樣品僅保留90天。本報告未經本公司書面許可，不可部份複製。

This document is issued by the Company subject to its General Conditions of Service printed overleaf, available on request or accessible at <http://www.sgs.com.tw/Terms-and-Conditions> and for electronic format documents, subject to Terms and Conditions for Electronic Documents at <http://www.sgs.com.tw/Terms-and-Conditions>. Attention is drawn to the limitation of liability, indemnification and jurisdiction issues defined therein. Any holder of this document is advised that information contained hereon reflects the Company's findings at the time of its intervention only and within the limits of Client's instructions, if any. The Company's sole responsibility is to its Client and this document does not exonerate parties to a transaction from exercising all their rights and obligations under the transaction documents. This document cannot be reproduced except in full, without prior written approval of the Company. Any unauthorized alteration, forgery or falsification of the content or appearance of this document is unlawful and offenders may be prosecuted to the fullest extent of the law.

Report Number :ER-2021-20085
 Operation Mode :802.11ax80
 Test Frequency :5290 MHz
 Test Mode :Tx CH Low
 EUT Pol :H Plane

Test Site :SAC III Chamber
 Test Date :2021-03-17
 Temp./Humi. :22.8/65
 Antenna Pol. :HORIZONTAL
 Engineer :Ricky

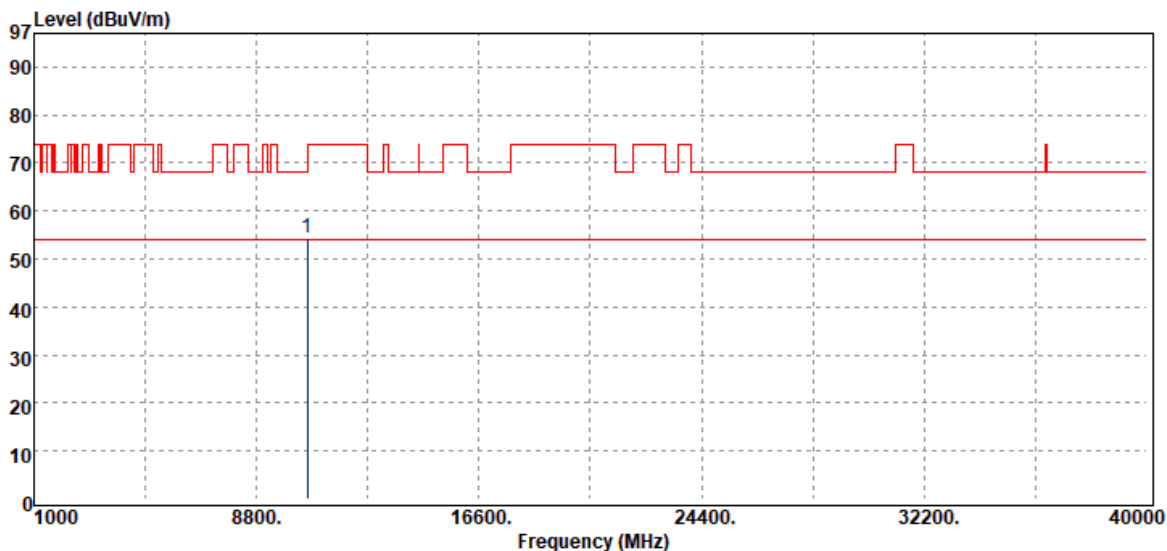

| Freq. MHz | Detector Mode PK/QP/AV | Spectrum Reading Level dB μ V | Factor dB | Actual FS dB μ V/m | Limit @3m dB μ V/m | Margin dB |
|--------------|------------------------------|---|--------------|------------------------------|------------------------------|--------------|
| 10580.00 | Peak | 34.51 | 19.82 | 54.33 | 68.20 | -13.87 |

Unless otherwise stated the results shown in this test report refer only to the sample(s) tested and such sample(s) are retained for 90 days only.

除非另有說明，此報告結果僅對測試之樣品負責，同時此樣品僅保留90天。本報告未經本公司書面許可，不可部份複製。

This document is issued by the Company subject to its General Conditions of Service printed overleaf, available on request or accessible at <http://www.sgs.com.tw/Terms-and-Conditions> and for electronic format documents, subject to Terms and Conditions for Electronic Documents at <http://www.sgs.com.tw/Terms-and-Conditions>. Attention is drawn to the limitation of liability, indemnification and jurisdiction issues defined therein. Any holder of this document is advised that information contained hereon reflects the Company's findings at the time of its intervention only and within the limits of Client's instructions, if any. The Company's sole responsibility is to its Client and this document does not exonerate parties to a transaction from exercising all their rights and obligations under the transaction documents. This document cannot be reproduced except in full, without prior written approval of the Company. Any unauthorized alteration, forgery or falsification of the content or appearance of this document is unlawful and offenders may be prosecuted to the fullest extent of the law.

Report Number :ER-2021-20085
 Operation Mode :802.11ax80
 Test Frequency :5530 MHz
 Test Mode :Tx CH Low
 EUT Pol :H Plane

Test Site :SAC III Chamber
 Test Date :2021-03-17
 Temp./Humi. :22.8/65
 Antenna Pol. :VERTICAL
 Engineer :Ricky

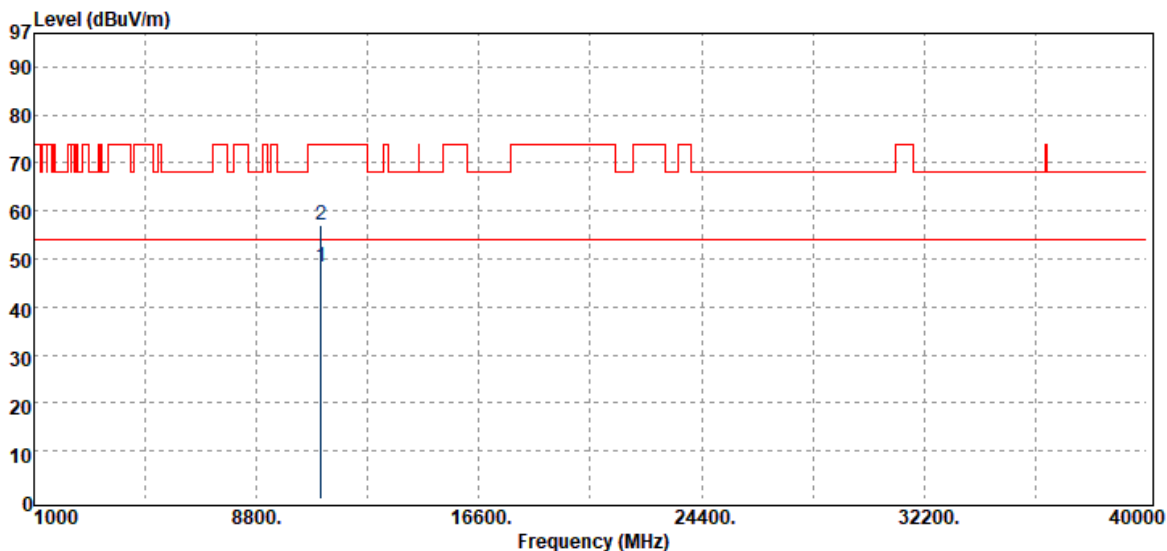

| Freq. MHz | Detector Mode PK/QP/AV | Spectrum Reading Level dB μ V | Factor dB | Actual FS dB μ V/m | Limit @3m dB μ V/m | Margin dB |
|--------------|------------------------------|---|--------------|------------------------------|------------------------------|--------------|
| 11060.00 | Average | 25.54 | 22.71 | 48.25 | 54.00 | -5.75 |
| 11060.00 | Peak | 34.20 | 22.71 | 56.91 | 74.00 | -17.09 |

Unless otherwise stated the results shown in this test report refer only to the sample(s) tested and such sample(s) are retained for 90 days only.

除非另有說明，此報告結果僅對測試之樣品負責，同時此樣品僅保留90天。本報告未經本公司書面許可，不可部份複製。

This document is issued by the Company subject to its General Conditions of Service printed overleaf, available on request or accessible at <http://www.sgs.com.tw/Terms-and-Conditions> and for electronic format documents, subject to Terms and Conditions for Electronic Documents at <http://www.sgs.com.tw/Terms-and-Conditions>. Attention is drawn to the limitation of liability, indemnification and jurisdiction issues defined therein. Any holder of this document is advised that information contained hereon reflects the Company's findings at the time of its intervention only and within the limits of Client's instructions, if any. The Company's sole responsibility is to its Client and this document does not exonerate parties to a transaction from exercising all their rights and obligations under the transaction documents. This document cannot be reproduced except in full, without prior written approval of the Company. Any unauthorized alteration, forgery or falsification of the content or appearance of this document is unlawful and offenders may be prosecuted to the fullest extent of the law.

Report Number :ER-2021-20085
 Operation Mode :802.11ax80
 Test Frequency :5530 MHz
 Test Mode :Tx CH Low
 EUT Pol :H Plane

Test Site :SAC III Chamber
 Test Date :2021-03-17
 Temp./Humi. :22.8/65
 Antenna Pol. :HORIZONTAL
 Engineer :Ricky

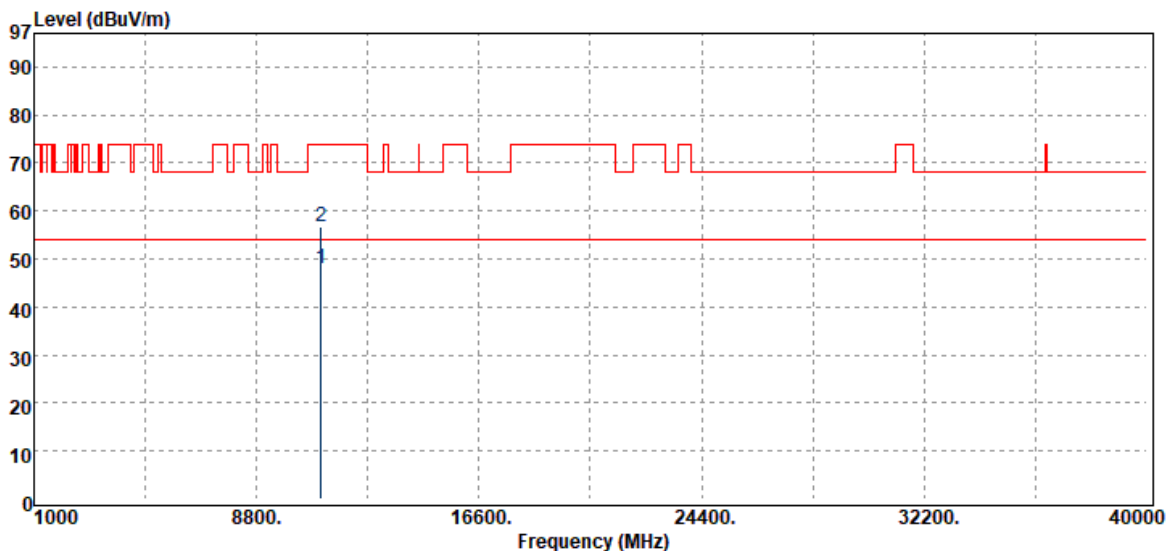

| Freq. MHz | Detector Mode PK/QP/AV | Spectrum Reading Level dB μ V | Factor dB | Actual FS dB μ V/m | Limit @3m dB μ V/m | Margin dB |
|--------------|------------------------------|---|--------------|------------------------------|------------------------------|--------------|
| 11060.00 | Average | 25.21 | 22.71 | 47.92 | 54.00 | -6.08 |
| 11060.00 | Peak | 34.10 | 22.71 | 56.81 | 74.00 | -17.19 |

Unless otherwise stated the results shown in this test report refer only to the sample(s) tested and such sample(s) are retained for 90 days only.

除非另有說明，此報告結果僅對測試之樣品負責，同時此樣品僅保留90天。本報告未經本公司書面許可，不可部份複製。

This document is issued by the Company subject to its General Conditions of Service printed overleaf, available on request or accessible at <http://www.sgs.com.tw/Terms-and-Conditions> and for electronic format documents, subject to Terms and Conditions for Electronic Documents at <http://www.sgs.com.tw/Terms-and-Conditions>. Attention is drawn to the limitation of liability, indemnification and jurisdiction issues defined therein. Any holder of this document is advised that information contained hereon reflects the Company's findings at the time of its intervention only and within the limits of Client's instructions, if any. The Company's sole responsibility is to its Client and this document does not exonerate parties to a transaction from exercising all their rights and obligations under the transaction documents. This document cannot be reproduced except in full, without prior written approval of the Company. Any unauthorized alteration, forgery or falsification of the content or appearance of this document is unlawful and offenders may be prosecuted to the fullest extent of the law.

Report Number :ER-2021-20085
 Operation Mode :802.11ax80
 Test Frequency :5610 MHz
 Test Mode :Tx CH Mid
 EUT Pol :H Plane

Test Site :SAC III Chamber
 Test Date :2021-03-17
 Temp./Humi. :22.8/65
 Antenna Pol. :VERTICAL
 Engineer :Ricky

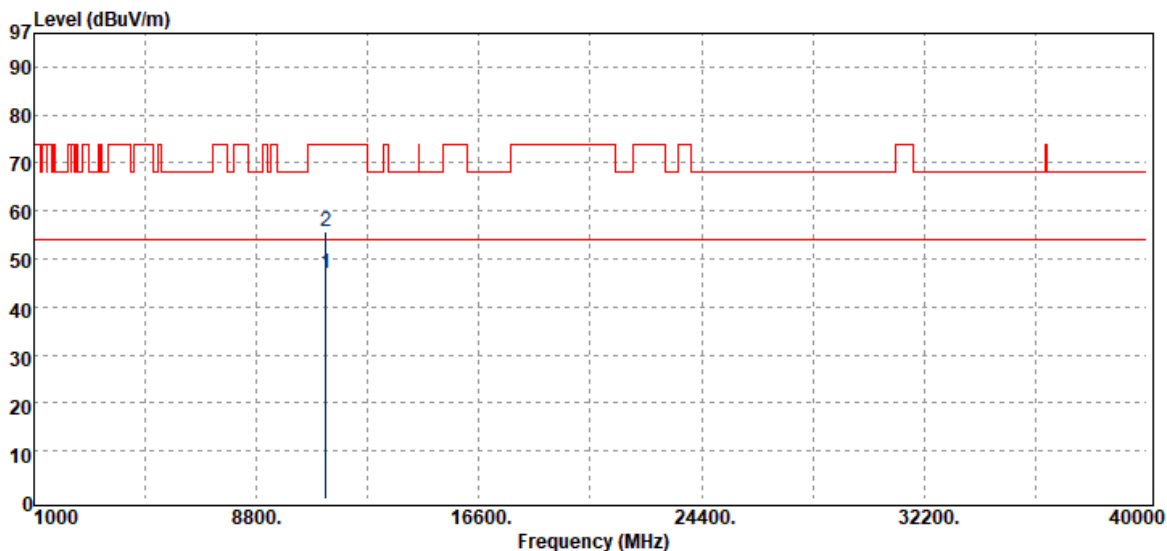

| Freq. MHz | Detector Mode PK/QP/AV | Spectrum Reading Level dB μ V | Factor dB | Actual FS dB μ V/m | Limit @3m dB μ V/m | Margin dB |
|--------------|------------------------------|---|--------------|------------------------------|------------------------------|--------------|
| 11220.00 | Average | 25.48 | 21.37 | 46.85 | 54.00 | -7.15 |
| 11220.00 | Peak | 34.18 | 21.37 | 55.55 | 74.00 | -18.45 |

Unless otherwise stated the results shown in this test report refer only to the sample(s) tested and such sample(s) are retained for 90 days only.

除非另有說明，此報告結果僅對測試之樣品負責，同時此樣品僅保留90天。本報告未經本公司書面許可，不可部份複製。

This document is issued by the Company subject to its General Conditions of Service printed overleaf, available on request or accessible at <http://www.sgs.com.tw/Terms-and-Conditions> and for electronic format documents, subject to Terms and Conditions for Electronic Documents at <http://www.sgs.com.tw/Terms-and-Conditions>. Attention is drawn to the limitation of liability, indemnification and jurisdiction issues defined therein. Any holder of this document is advised that information contained hereon reflects the Company's findings at the time of its intervention only and within the limits of Client's instructions, if any. The Company's sole responsibility is to its Client and this document does not exonerate parties to a transaction from exercising all their rights and obligations under the transaction documents. This document cannot be reproduced except in full, without prior written approval of the Company. Any unauthorized alteration, forgery or falsification of the content or appearance of this document is unlawful and offenders may be prosecuted to the fullest extent of the law.

Report Number :ER-2021-20085
 Operation Mode :802.11ax80
 Test Frequency :5610 MHz
 Test Mode :Tx CH Mid
 EUT Pol :H Plane

Test Site :SAC III Chamber
 Test Date :2021-03-17
 Temp./Humi. :22.8/65
 Antenna Pol. :HORIZONTAL
 Engineer :Ricky

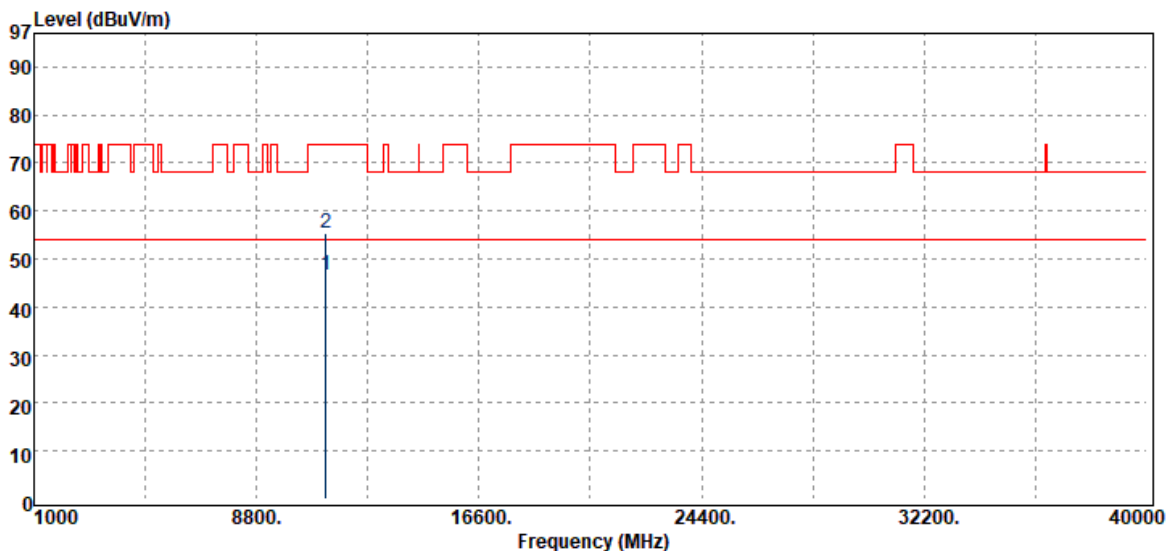

| Freq. MHz | Detector Mode PK/QP/AV | Spectrum Reading Level dB μ V | Factor dB | Actual FS dB μ V/m | Limit @3m dB μ V/m | Margin dB |
|--------------|------------------------------|---|--------------|------------------------------|------------------------------|--------------|
| 11220.00 | Average | 25.40 | 21.37 | 46.77 | 54.00 | -7.23 |
| 11220.00 | Peak | 34.07 | 21.37 | 55.44 | 74.00 | -18.56 |

Unless otherwise stated the results shown in this test report refer only to the sample(s) tested and such sample(s) are retained for 90 days only.

除非另有說明，此報告結果僅對測試之樣品負責，同時此樣品僅保留90天。本報告未經本公司書面許可，不可部份複製。

This document is issued by the Company subject to its General Conditions of Service printed overleaf, available on request or accessible at <http://www.sgs.com.tw/Terms-and-Conditions> and for electronic format documents, subject to Terms and Conditions for Electronic Documents at <http://www.sgs.com.tw/Terms-and-Conditions>. Attention is drawn to the limitation of liability, indemnification and jurisdiction issues defined therein. Any holder of this document is advised that information contained hereon reflects the Company's findings at the time of its intervention only and within the limits of Client's instructions, if any. The Company's sole responsibility is to its Client and this document does not exonerate parties to a transaction from exercising all their rights and obligations under the transaction documents. This document cannot be reproduced except in full, without prior written approval of the Company. Any unauthorized alteration, forgery or falsification of the content or appearance of this document is unlawful and offenders may be prosecuted to the fullest extent of the law.

Report Number :ER-2021-20085
 Operation Mode :802.11ax80
 Test Frequency :5690 MHz
 Test Mode :Tx CH High
 EUT Pol :H Plane

Test Site :SAC III Chamber
 Test Date :2021-03-17
 Temp./Humi. :22.8/65
 Antenna Pol. :VERTICAL
 Engineer :Ricky

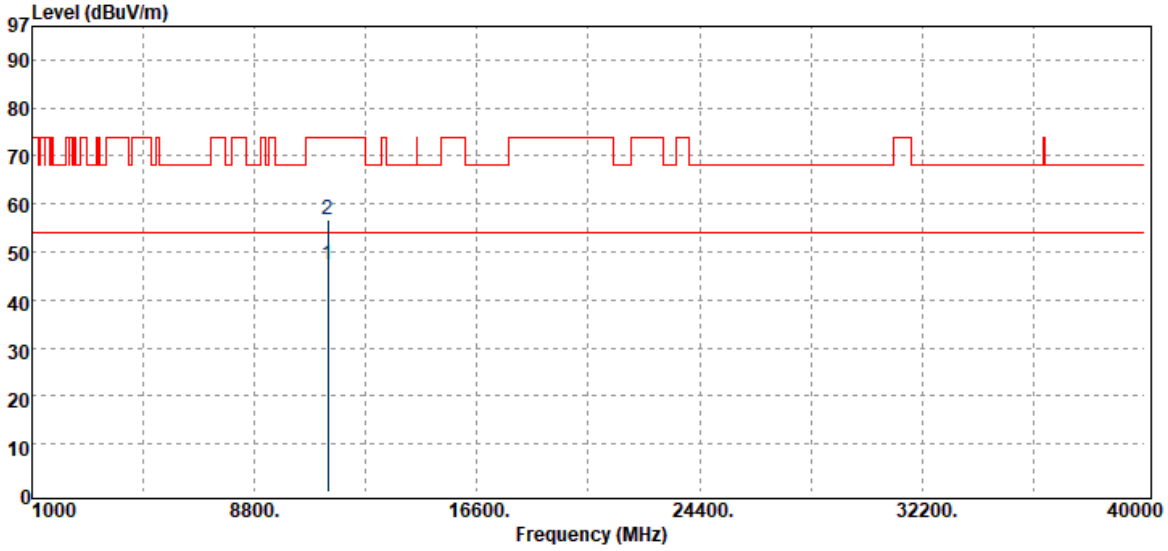

| Freq. MHz | Detector Mode PK/QP/AV | Spectrum Reading Level dBµV | Factor dB | Actual FS dBµV/m | Limit @3m dBµV/m | Margin dB |
|--------------|------------------------------|-----------------------------------|--------------|------------------------|------------------------|--------------|
| 11380.00 | Average | 25.43 | 21.81 | 47.24 | 54.00 | -6.76 |
| 11380.00 | Peak | 35.05 | 21.81 | 56.86 | 74.00 | -17.14 |

Unless otherwise stated the results shown in this test report refer only to the sample(s) tested and such sample(s) are retained for 90 days only.

除非另有說明，此報告結果僅對測試之樣品負責，同時此樣品僅保留90天。本報告未經本公司書面許可，不可部份複製。

This document is issued by the Company subject to its General Conditions of Service printed overleaf, available on request or accessible at <http://www.sgs.com.tw/Terms-and-Conditions> and for electronic format documents, subject to Terms and Conditions for Electronic Documents at <http://www.sgs.com.tw/Terms-and-Conditions>. Attention is drawn to the limitation of liability, indemnification and jurisdiction issues defined therein. Any holder of this document is advised that information contained hereon reflects the Company's findings at the time of its intervention only and within the limits of Client's instructions, if any. The Company's sole responsibility is to its Client and this document does not exonerate parties to a transaction from exercising all their rights and obligations under the transaction documents. This document cannot be reproduced except in full, without prior written approval of the Company. Any unauthorized alteration, forgery or falsification of the content or appearance of this document is unlawful and offenders may be prosecuted to the fullest extent of the law.

Report Number :ER-2021-20085
 Operation Mode :802.11ax80
 Test Frequency :5690 MHz
 Test Mode :Tx CH High
 EUT Pol :H Plane

Test Site :SAC III Chamber
 Test Date :2021-03-17
 Temp./Humi. :22.8/65
 Antenna Pol. :HORIZONTAL
 Engineer :Ricky

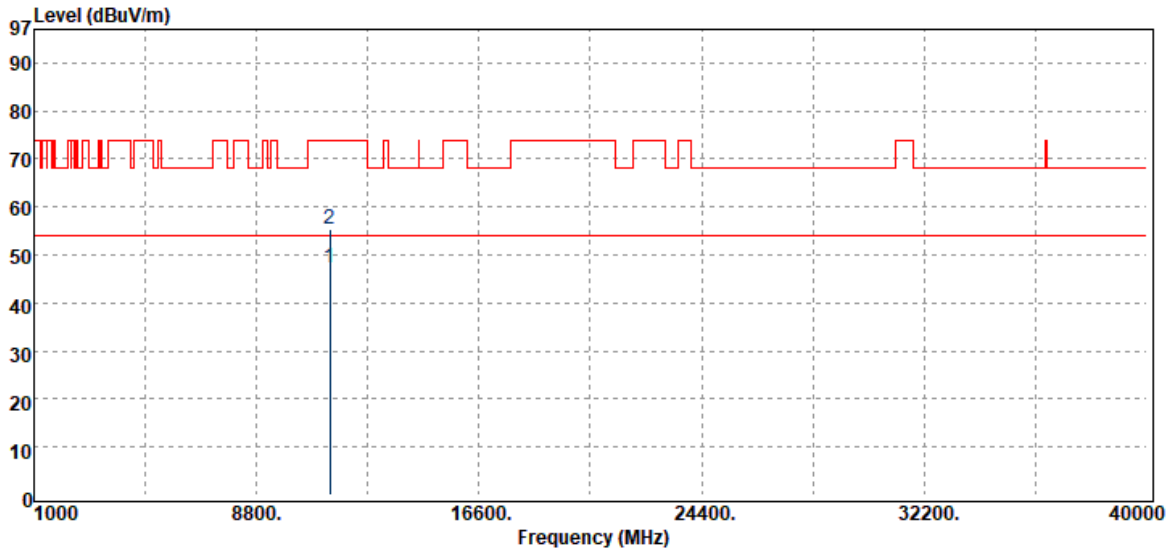

| Freq. MHz | Detector Mode PK/QP/AV | Spectrum Reading Level dB μ V | Factor dB | Actual FS dB μ V/m | Limit @3m dB μ V/m | Margin dB |
|--------------|------------------------------|---|--------------|------------------------------|------------------------------|--------------|
| 11380.00 | Average | 25.49 | 21.81 | 47.30 | 54.00 | -6.70 |
| 11380.00 | Peak | 33.63 | 21.81 | 55.44 | 74.00 | -18.56 |

Unless otherwise stated the results shown in this test report refer only to the sample(s) tested and such sample(s) are retained for 90 days only.

除非另有說明，此報告結果僅對測試之樣品負責，同時此樣品僅保留90天。本報告未經本公司書面許可，不可部份複製。

This document is issued by the Company subject to its General Conditions of Service printed overleaf, available on request or accessible at <http://www.sgs.com.tw/Terms-and-Conditions> and for electronic format documents, subject to Terms and Conditions for Electronic Documents at <http://www.sgs.com.tw/Terms-and-Conditions>. Attention is drawn to the limitation of liability, indemnification and jurisdiction issues defined therein. Any holder of this document is advised that information contained hereon reflects the Company's findings at the time of its intervention only and within the limits of Client's instructions, if any. The Company's sole responsibility is to its Client and this document does not exonerate parties to a transaction from exercising all their rights and obligations under the transaction documents. This document cannot be reproduced except in full, without prior written approval of the Company. Any unauthorized alteration, forgery or falsification of the content or appearance of this document is unlawful and offenders may be prosecuted to the fullest extent of the law.

Report Number :ER-2021-20085
 Operation Mode :802.11ax80
 Test Frequency :5775 MHz
 Test Mode :Tx CH Low
 EUT Pol :H Plane

Test Site :SAC III Chamber
 Test Date :2021-03-17
 Temp./Humi. :22.8/65
 Antenna Pol. :VERTICAL
 Engineer :Ricky

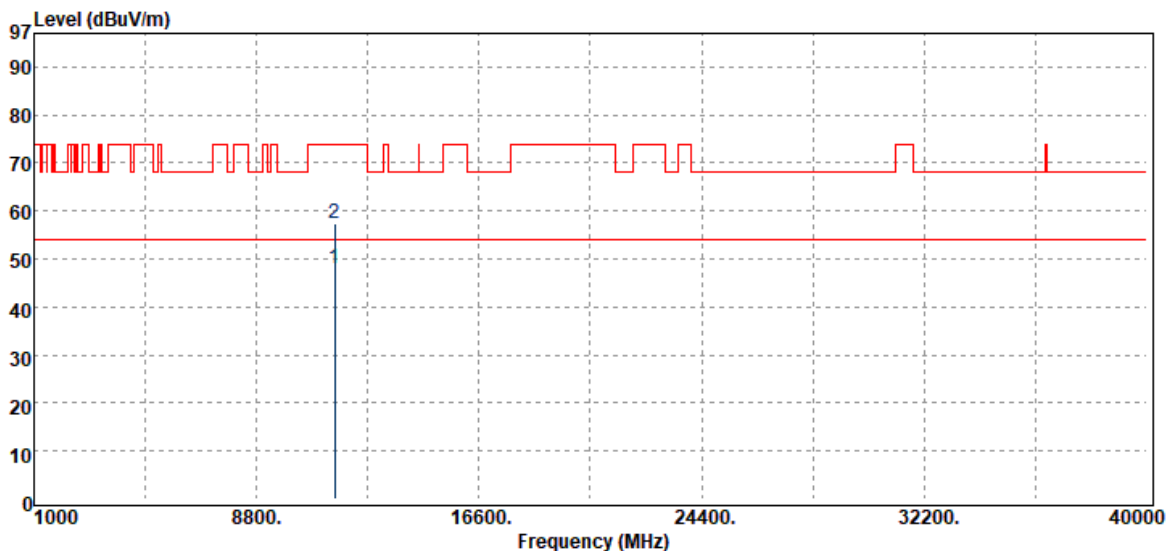

| Freq. MHz | Detector Mode PK/QP/AV | Spectrum Reading Level dB μ V | Factor dB | Actual FS dB μ V/m | Limit @3m dB μ V/m | Margin dB |
|--------------|------------------------------|---|--------------|------------------------------|------------------------------|--------------|
| 11550.00 | Average | 25.42 | 22.52 | 47.94 | 54.00 | -6.06 |
| 11550.00 | Peak | 34.80 | 22.52 | 57.32 | 74.00 | -16.68 |

Unless otherwise stated the results shown in this test report refer only to the sample(s) tested and such sample(s) are retained for 90 days only.

除非另有說明，此報告結果僅對測試之樣品負責，同時此樣品僅保留90天。本報告未經本公司書面許可，不可部份複製。

This document is issued by the Company subject to its General Conditions of Service printed overleaf, available on request or accessible at <http://www.sgs.com.tw/Terms-and-Conditions> and for electronic format documents, subject to Terms and Conditions for Electronic Documents at <http://www.sgs.com.tw/Terms-and-Conditions>. Attention is drawn to the limitation of liability, indemnification and jurisdiction issues defined therein. Any holder of this document is advised that information contained hereon reflects the Company's findings at the time of its intervention only and within the limits of Client's instructions, if any. The Company's sole responsibility is to its Client and this document does not exonerate parties to a transaction from exercising all their rights and obligations under the transaction documents. This document cannot be reproduced except in full, without prior written approval of the Company. Any unauthorized alteration, forgery or falsification of the content or appearance of this document is unlawful and offenders may be prosecuted to the fullest extent of the law.

Report Number :ER-2021-20085
 Operation Mode :802.11ax80
 Test Frequency :5775 MHz
 Test Mode :Tx CH Low
 EUT Pol :H Plane

Test Site :SAC III Chamber
 Test Date :2021-03-17
 Temp./Humi. :22.8/65
 Antenna Pol. :HORIZONTAL
 Engineer :Ricky

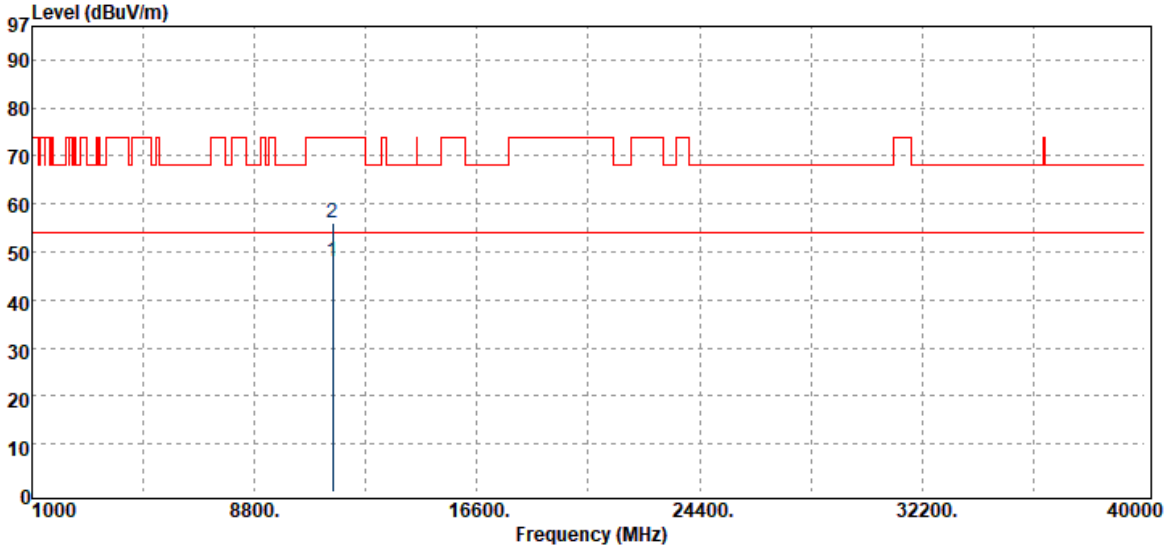

| Freq. MHz | Detector Mode PK/QP/AV | Spectrum Reading Level dB μ V | Factor dB | Actual FS dB μ V/m | Limit @3m dB μ V/m | Margin dB |
|--------------|------------------------------|---|--------------|------------------------------|------------------------------|--------------|
| 11550.00 | Average | 25.43 | 22.52 | 47.95 | 54.00 | -6.05 |
| 11550.00 | Peak | 33.62 | 22.52 | 56.14 | 74.00 | -17.86 |

Unless otherwise stated the results shown in this test report refer only to the sample(s) tested and such sample(s) are retained for 90 days only.

除非另有說明，此報告結果僅對測試之樣品負責，同時此樣品僅保留90天。本報告未經本公司書面許可，不可部份複製。

This document is issued by the Company subject to its General Conditions of Service printed overleaf, available on request or accessible at <http://www.sgs.com.tw/Terms-and-Conditions> and for electronic format documents, subject to Terms and Conditions for Electronic Documents at <http://www.sgs.com.tw/Terms-and-Conditions>. Attention is drawn to the limitation of liability, indemnification and jurisdiction issues defined therein. Any holder of this document is advised that information contained hereon reflects the Company's findings at the time of its intervention only and within the limits of Client's instructions, if any. The Company's sole responsibility is to its Client and this document does not exonerate parties to a transaction from exercising all their rights and obligations under the transaction documents. This document cannot be reproduced except in full, without prior written approval of the Company. Any unauthorized alteration, forgery or falsification of the content or appearance of this document is unlawful and offenders may be prosecuted to the fullest extent of the law.

11.7.3 Band edge falling to restricted band

| | | | |
|----------------|------------------|--------------|------------------|
| Report Number | :ER-2021-20085 | Test Site | :SAC III Chamber |
| Operation Mode | :802.11n20 | Test Date | :2021-03-15 |
| Test Frequency | :5180 MHz | Temp./Humi. | :22.4/61 |
| Test Mode | :Bandedge CH Low | Antenna Pol. | :VERTICAL |
| EUT Pol | :H Plane | Engineer | :Ricky |

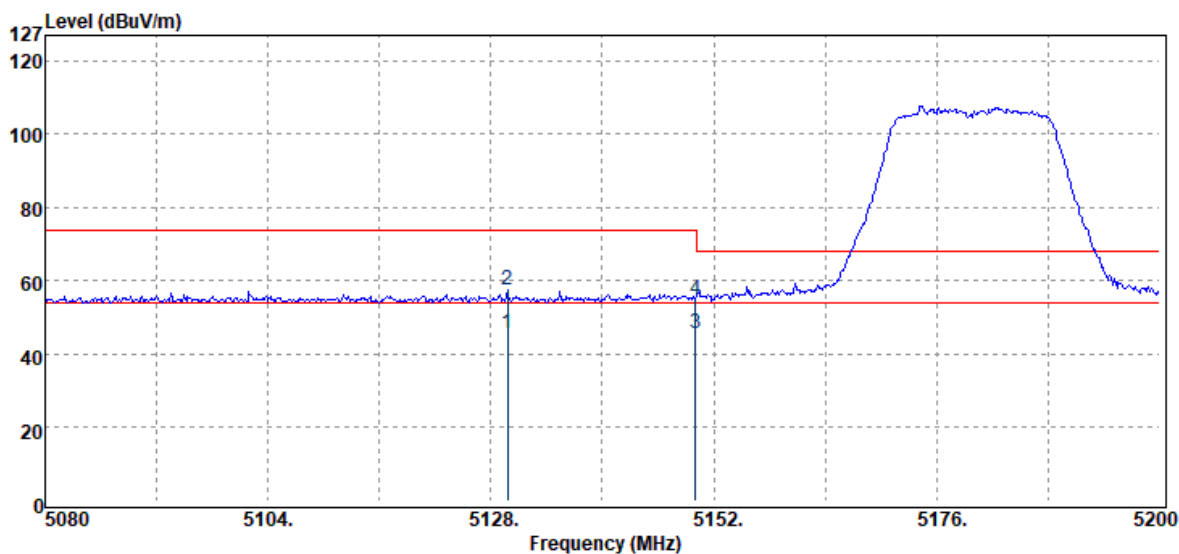

| Freq. MHz | Detector Mode PK/QP/AV | Spectrum Reading Level dB μ V | Factor dB | Actual FS dB μ V/m | Limit @3m dB μ V/m | Margin dB |
|--------------|------------------------------|---|--------------|------------------------------|------------------------------|--------------|
| 5129.80 | Average | 36.92 | 8.56 | 45.48 | 54.00 | -8.52 |
| 5129.80 | Peak | 48.86 | 8.56 | 57.42 | 74.00 | -16.58 |
| 5150.00 | Average | 37.32 | 8.53 | 45.85 | 54.00 | -8.15 |
| 5150.00 | Peak | 46.62 | 8.53 | 55.15 | 74.00 | -18.85 |

Unless otherwise stated the results shown in this test report refer only to the sample(s) tested and such sample(s) are retained for 90 days only.

除非另有說明，此報告結果僅對測試之樣品負責，同時此樣品僅保留90天。本報告未經本公司書面許可，不可部份複製。

This document is issued by the Company subject to its General Conditions of Service printed overleaf, available on request or accessible at <http://www.sgs.com.tw/Terms-and-Conditions> and for electronic format documents, subject to Terms and Conditions for Electronic Documents at <http://www.sgs.com.tw/Terms-and-Conditions>. Attention is drawn to the limitation of liability, indemnification and jurisdiction issues defined therein. Any holder of this document is advised that information contained hereon reflects the Company's findings at the time of its intervention only and within the limits of Client's instructions, if any. The Company's sole responsibility is to its Client and this document does not exonerate parties to a transaction from exercising all their rights and obligations under the transaction documents. This document cannot be reproduced except in full, without prior written approval of the Company. Any unauthorized alteration, forgery or falsification of the content or appearance of this document is unlawful and offenders may be prosecuted to the fullest extent of the law.

| | | | |
|----------------|------------------|--------------|------------------|
| Report Number | :ER-2021-20085 | Test Site | :SAC III Chamber |
| Operation Mode | :802.11n20 | Test Date | :2021-03-15 |
| Test Frequency | :5180 MHz | Temp./Humi. | :22.4/61 |
| Test Mode | :Bandedge CH Low | Antenna Pol. | :HORIZONTAL |
| EUT Pol | :H Plane | Engineer | :Ricky |

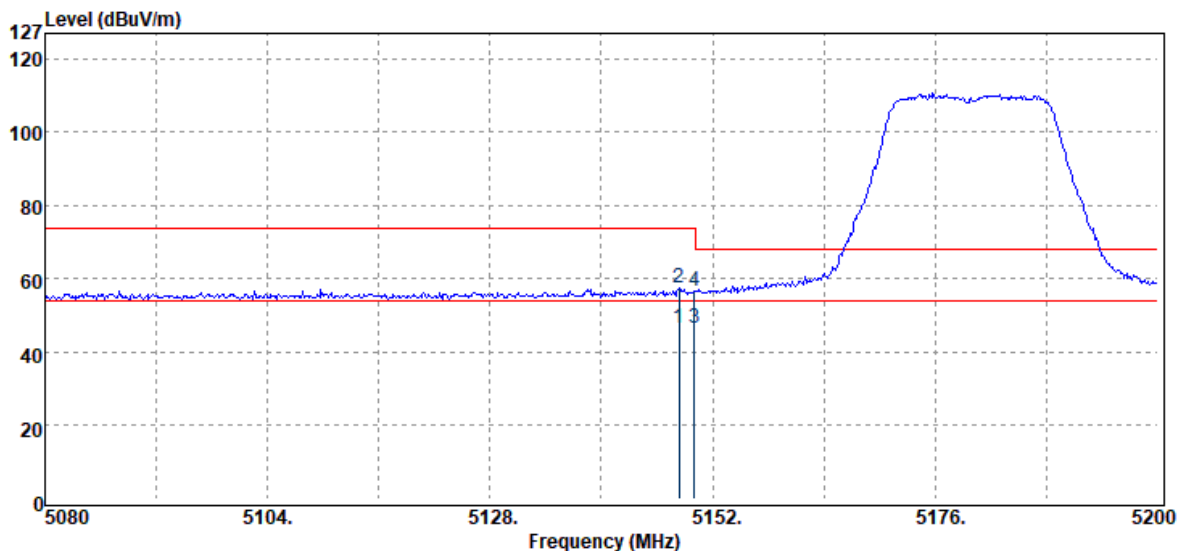

| Freq. MHz | Detector Mode PK/QP/AV | Spectrum Reading Level dB μ V | Factor dB | Actual FS dB μ V/m | Limit @3m dB μ V/m | Margin dB |
|--------------|------------------------------|---|--------------|------------------------------|------------------------------|--------------|
| 5148.40 | Average | 37.96 | 8.53 | 46.49 | 54.00 | -7.51 |
| 5148.40 | Peak | 48.93 | 8.53 | 57.46 | 74.00 | -16.54 |
| 5150.00 | Average | 38.06 | 8.53 | 46.59 | 54.00 | -7.41 |
| 5150.00 | Peak | 47.95 | 8.53 | 56.48 | 74.00 | -17.52 |

Unless otherwise stated the results shown in this test report refer only to the sample(s) tested and such sample(s) are retained for 90 days only.

除非另有說明，此報告結果僅對測試之樣品負責，同時此樣品僅保留90天。本報告未經本公司書面許可，不可部份複製。

This document is issued by the Company subject to its General Conditions of Service printed overleaf, available on request or accessible at <http://www.sgs.com.tw/Terms-and-Conditions> and for electronic format documents, subject to Terms and Conditions for Electronic Documents at <http://www.sgs.com.tw/Terms-and-Conditions>. Attention is drawn to the limitation of liability, indemnification and jurisdiction issues defined therein. Any holder of this document is advised that information contained hereon reflects the Company's findings at the time of its intervention only and within the limits of Client's instructions, if any. The Company's sole responsibility is to its Client and this document does not exonerate parties to a transaction from exercising all their rights and obligations under the transaction documents. This document cannot be reproduced except in full, without prior written approval of the Company. Any unauthorized alteration, forgery or falsification of the content or appearance of this document is unlawful and offenders may be prosecuted to the fullest extent of the law.

| | | | |
|----------------|-------------------|--------------|------------------|
| Report Number | :ER-2021-20085 | Test Site | :SAC III Chamber |
| Operation Mode | :802.11n20 | Test Date | :2021-03-15 |
| Test Frequency | :5320 MHz | Temp./Humi. | :22.4/61 |
| Test Mode | :Bandedge CH High | Antenna Pol. | :VERTICAL |
| EUT Pol | :H Plane | Engineer | :Ricky |

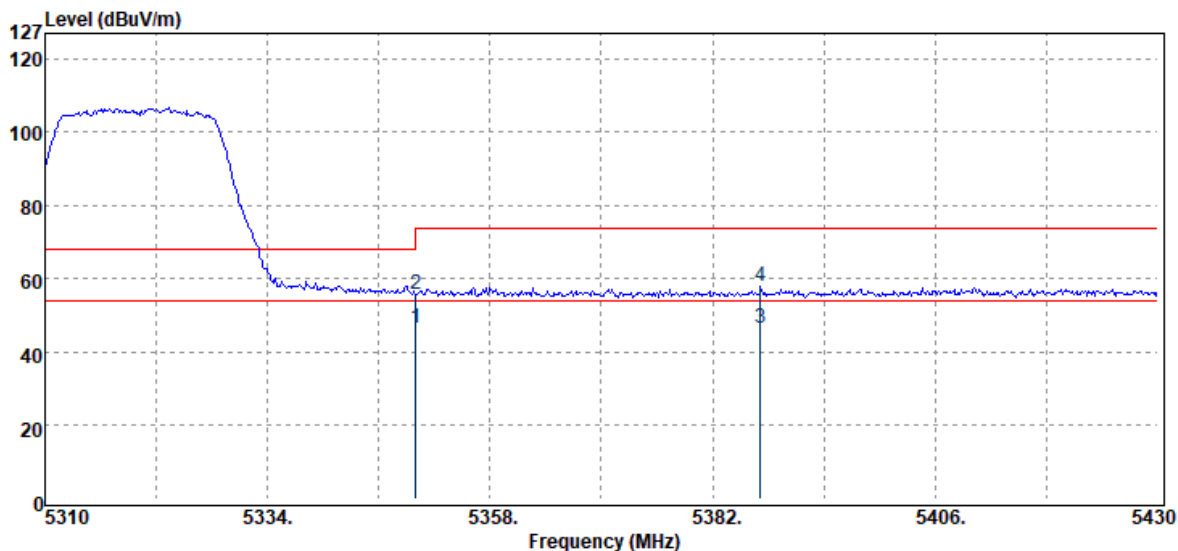

| Freq. MHz | Detector Mode PK/QP/AV | Spectrum Reading Level dB μ V | Factor dB | Actual FS dB μ V/m | Limit @3m dB μ V/m | Margin dB |
|--------------|------------------------------|---|--------------|------------------------------|------------------------------|--------------|
| 5350.00 | Average | 37.97 | 8.77 | 46.74 | 54.00 | -7.26 |
| 5350.00 | Peak | 47.22 | 8.77 | 55.99 | 74.00 | -18.01 |
| 5387.16 | Average | 37.29 | 9.25 | 46.54 | 54.00 | -7.46 |
| 5387.16 | Peak | 48.82 | 9.25 | 58.07 | 74.00 | -15.93 |

Unless otherwise stated the results shown in this test report refer only to the sample(s) tested and such sample(s) are retained for 90 days only.

除非另有說明，此報告結果僅對測試之樣品負責，同時此樣品僅保留90天。本報告未經本公司書面許可，不可部份複製。

This document is issued by the Company subject to its General Conditions of Service printed overleaf, available on request or accessible at <http://www.sgs.com.tw/Terms-and-Conditions> and for electronic format documents, subject to Terms and Conditions for Electronic Documents at <http://www.sgs.com.tw/Terms-and-Conditions>. Attention is drawn to the limitation of liability, indemnification and jurisdiction issues defined therein. Any holder of this document is advised that information contained hereon reflects the Company's findings at the time of its intervention only and within the limits of Client's instructions, if any. The Company's sole responsibility is to its Client and this document does not exonerate parties to a transaction from exercising all their rights and obligations under the transaction documents. This document cannot be reproduced except in full, without prior written approval of the Company. Any unauthorized alteration, forgery or falsification of the content or appearance of this document is unlawful and offenders may be prosecuted to the fullest extent of the law.

| | | | |
|----------------|-------------------|--------------|------------------|
| Report Number | :ER-2021-20085 | Test Site | :SAC III Chamber |
| Operation Mode | :802.11n20 | Test Date | :2021-03-15 |
| Test Frequency | :5320 MHz | Temp./Humi. | :22.4/61 |
| Test Mode | :Bandedge CH High | Antenna Pol. | :HORIZONTAL |
| EUT Pol | :H Plane | Engineer | :Ricky |

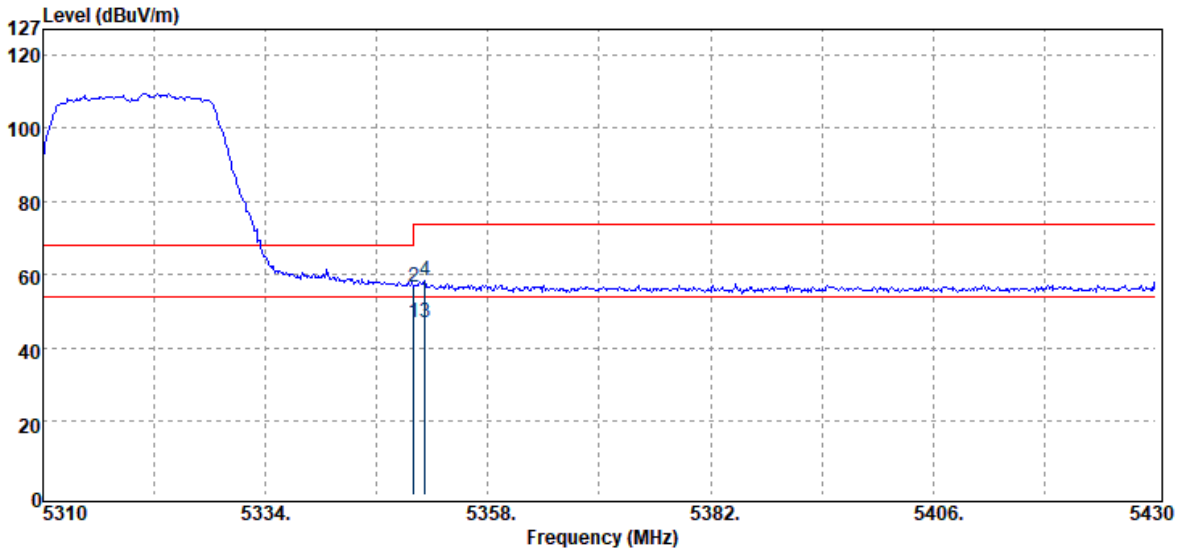

| Freq. MHz | Detector Mode PK/QP/AV | Spectrum Reading Level dB μ V | Factor dB | Actual FS dB μ V/m | Limit @3m dB μ V/m | Margin dB |
|--------------|------------------------------|---|--------------|------------------------------|------------------------------|--------------|
| 5350.00 | Average | 38.21 | 8.77 | 46.98 | 54.00 | -7.02 |
| 5350.00 | Peak | 48.12 | 8.77 | 56.89 | 74.00 | -17.11 |
| 5351.16 | Average | 38.08 | 8.78 | 46.86 | 54.00 | -7.14 |
| 5351.16 | Peak | 49.84 | 8.78 | 58.62 | 74.00 | -15.38 |

Unless otherwise stated the results shown in this test report refer only to the sample(s) tested and such sample(s) are retained for 90 days only.

除非另有說明，此報告結果僅對測試之樣品負責，同時此樣品僅保留90天。本報告未經本公司書面許可，不可部份複製。

This document is issued by the Company subject to its General Conditions of Service printed overleaf, available on request or accessible at <http://www.sgs.com.tw/Terms-and-Conditions> and for electronic format documents, subject to Terms and Conditions for Electronic Documents at <http://www.sgs.com.tw/Terms-and-Conditions>. Attention is drawn to the limitation of liability, indemnification and jurisdiction issues defined therein. Any holder of this document is advised that information contained hereon reflects the Company's findings at the time of its intervention only and within the limits of Client's instructions, if any. The Company's sole responsibility is to its Client and this document does not exonerate parties to a transaction from exercising all their rights and obligations under the transaction documents. This document cannot be reproduced except in full, without prior written approval of the Company. Any unauthorized alteration, forgery or falsification of the content or appearance of this document is unlawful and offenders may be prosecuted to the fullest extent of the law.

| | | | |
|----------------|------------------|--------------|------------------|
| Report Number | :ER-2021-20085 | Test Site | :SAC III Chamber |
| Operation Mode | :802.11n20 | Test Date | :2021-03-15 |
| Test Frequency | :5500 MHz | Temp./Humi. | :22.4/61 |
| Test Mode | :Bandedge CH Low | Antenna Pol. | :VERTICAL |
| EUT Pol | :H Plane | Engineer | :Ricky |

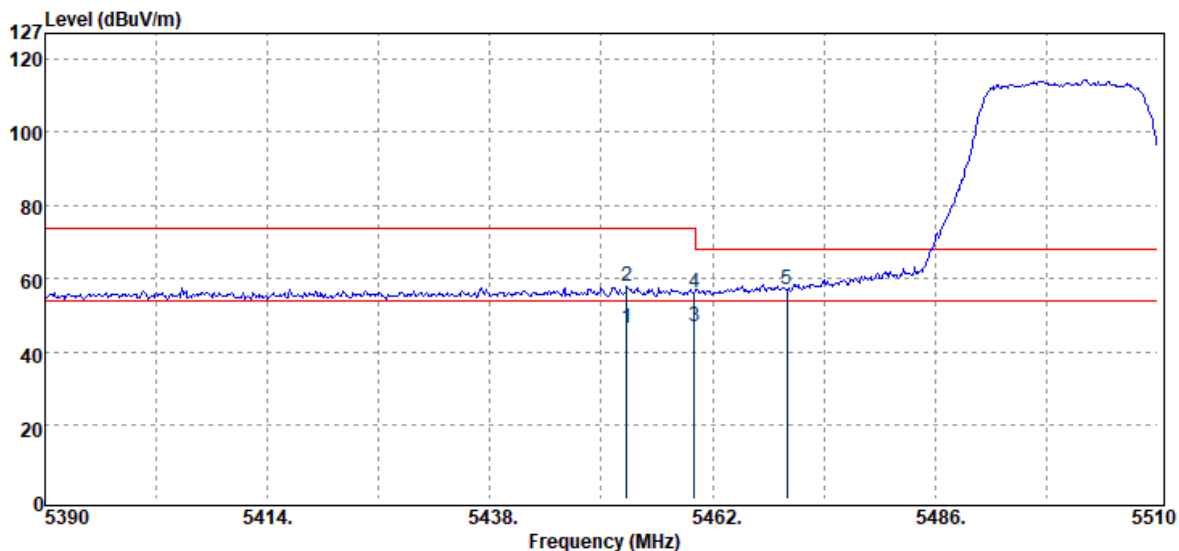

| Freq. MHz | Detector Mode PK/QP/AV | Spectrum Reading Level d μ V | Factor dB | Actual FS d μ V/m | Limit @3m d μ V/m | Margin dB |
|--------------|------------------------------|--|--------------|-----------------------------|-----------------------------|--------------|
| 5452.76 | Average | 37.16 | 9.59 | 46.75 | 54.00 | -7.25 |
| 5452.76 | Peak | 48.48 | 9.59 | 58.07 | 74.00 | -15.93 |
| 5460.00 | Average | 37.26 | 9.63 | 46.89 | 54.00 | -7.11 |
| 5460.00 | Peak | 46.47 | 9.63 | 56.10 | 74.00 | -17.90 |
| 5470.00 | Peak | 47.40 | 9.71 | 57.11 | 68.20 | -11.09 |

Unless otherwise stated the results shown in this test report refer only to the sample(s) tested and such sample(s) are retained for 90 days only.

除非另有說明，此報告結果僅對測試之樣品負責，同時此樣品僅保留90天。本報告未經本公司書面許可，不可部份複製。

This document is issued by the Company subject to its General Conditions of Service printed overleaf, available on request or accessible at <http://www.sgs.com.tw/Terms-and-Conditions> and for electronic format documents, subject to Terms and Conditions for Electronic Documents at <http://www.sgs.com.tw/Terms-and-Conditions>. Attention is drawn to the limitation of liability, indemnification and jurisdiction issues defined therein. Any holder of this document is advised that information contained hereon reflects the Company's findings at the time of its intervention only and within the limits of Client's instructions, if any. The Company's sole responsibility is to its Client and this document does not exonerate parties to a transaction from exercising all their rights and obligations under the transaction documents. This document cannot be reproduced except in full, without prior written approval of the Company. Any unauthorized alteration, forgery or falsification of the content or appearance of this document is unlawful and offenders may be prosecuted to the fullest extent of the law.

| | | | |
|----------------|------------------|--------------|------------------|
| Report Number | :ER-2021-20085 | Test Site | :SAC III Chamber |
| Operation Mode | :802.11n20 | Test Date | :2021-03-15 |
| Test Frequency | :5500 MHz | Temp./Humi. | :22.4/61 |
| Test Mode | :Bandedge CH Low | Antenna Pol. | :HORIZONTAL |
| EUT Pol | :H Plane | Engineer | :Ricky |

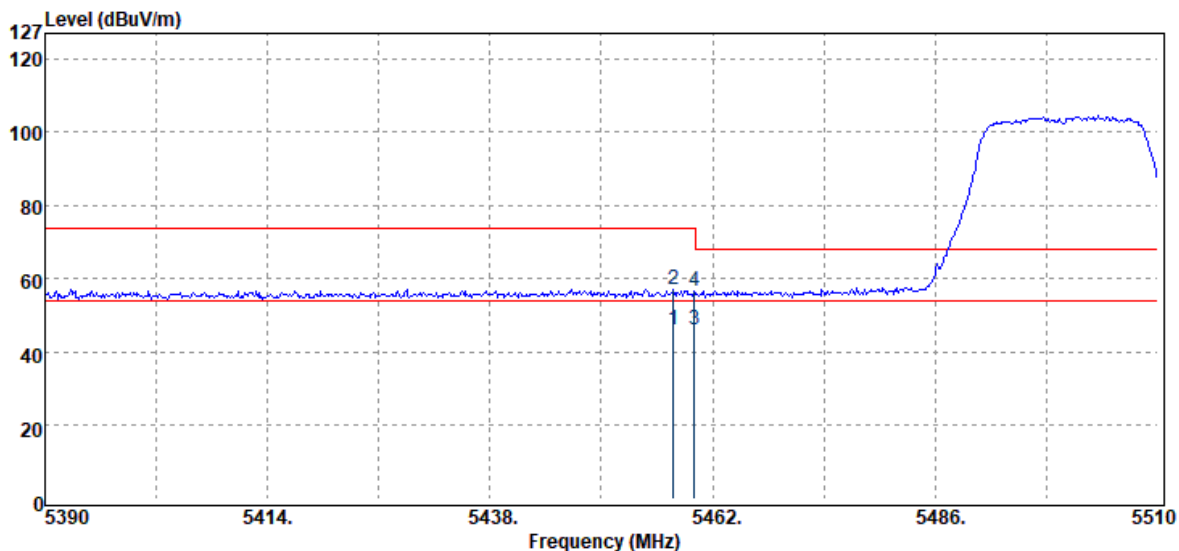

| Freq. MHz | Detector Mode PK/QP/AV | Spectrum Reading Level dB μ V | Factor dB | Actual FS dB μ V/m | Limit @3m dB μ V/m | Margin dB |
|--------------|------------------------------|---|--------------|------------------------------|------------------------------|--------------|
| 5457.80 | Average | 36.39 | 9.62 | 46.01 | 54.00 | -7.99 |
| 5457.80 | Peak | 47.63 | 9.62 | 57.25 | 74.00 | -16.75 |
| 5460.00 | Average | 36.46 | 9.63 | 46.09 | 54.00 | -7.91 |
| 5460.00 | Peak | 46.84 | 9.63 | 56.47 | 74.00 | -17.53 |

Unless otherwise stated the results shown in this test report refer only to the sample(s) tested and such sample(s) are retained for 90 days only.

除非另有說明，此報告結果僅對測試之樣品負責，同時此樣品僅保留90天。本報告未經本公司書面許可，不可部份複製。

This document is issued by the Company subject to its General Conditions of Service printed overleaf, available on request or accessible at <http://www.sgs.com.tw/Terms-and-Conditions> and for electronic format documents, subject to Terms and Conditions for Electronic Documents at <http://www.sgs.com.tw/Terms-and-Conditions>. Attention is drawn to the limitation of liability, indemnification and jurisdiction issues defined therein. Any holder of this document is advised that information contained hereon reflects the Company's findings at the time of its intervention only and within the limits of Client's instructions, if any. The Company's sole responsibility is to its Client and this document does not exonerate parties to a transaction from exercising all their rights and obligations under the transaction documents. This document cannot be reproduced except in full, without prior written approval of the Company. Any unauthorized alteration, forgery or falsification of the content or appearance of this document is unlawful and offenders may be prosecuted to the fullest extent of the law.

| | | | |
|----------------|-------------------|--------------|------------------|
| Report Number | :ER-2021-20085 | Test Site | :SAC III Chamber |
| Operation Mode | :802.11n20 | Test Date | :2021-03-15 |
| Test Frequency | :5700 MHz | Temp./Humi. | :22.4/61 |
| Test Mode | :Bandedge CH High | Antenna Pol. | :VERTICAL |
| EUT Pol | :H Plane | Engineer | :Ricky |

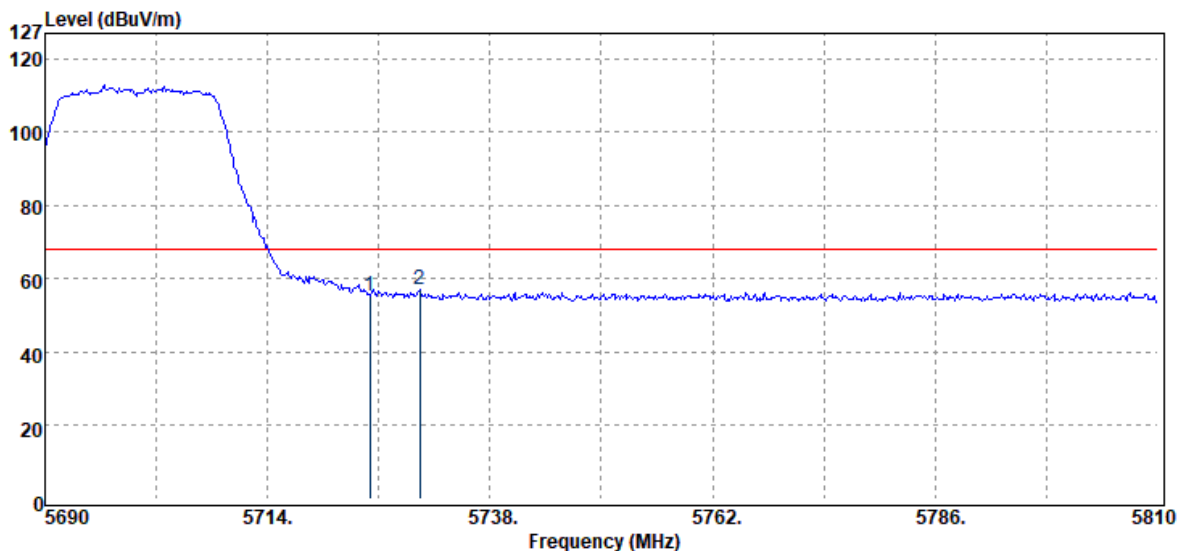

| Freq. MHz | Detector Mode PK/QP/AV | Spectrum Reading Level dB μ V | Factor dB | Actual FS dB μ V/m | Limit @3m dB μ V/m | Margin dB |
|--------------|------------------------------|---|--------------|------------------------------|------------------------------|--------------|
| 5725.00 | Peak | 47.46 | 8.12 | 55.58 | 68.20 | -12.62 |
| 5730.44 | Peak | 48.96 | 8.14 | 57.10 | 68.20 | -11.10 |

Unless otherwise stated the results shown in this test report refer only to the sample(s) tested and such sample(s) are retained for 90 days only.

除非另有說明，此報告結果僅對測試之樣品負責，同時此樣品僅保留90天。本報告未經本公司書面許可，不可部份複製。

This document is issued by the Company subject to its General Conditions of Service printed overleaf, available on request or accessible at <http://www.sgs.com.tw/Terms-and-Conditions> and for electronic format documents, subject to Terms and Conditions for Electronic Documents at <http://www.sgs.com.tw/Terms-and-Conditions>. Attention is drawn to the limitation of liability, indemnification and jurisdiction issues defined therein. Any holder of this document is advised that information contained hereon reflects the Company's findings at the time of its intervention only and within the limits of Client's instructions, if any. The Company's sole responsibility is to its Client and this document does not exonerate parties to a transaction from exercising all their rights and obligations under the transaction documents. This document cannot be reproduced except in full, without prior written approval of the Company. Any unauthorized alteration, forgery or falsification of the content or appearance of this document is unlawful and offenders may be prosecuted to the fullest extent of the law.

| | | | |
|----------------|-------------------|--------------|------------------|
| Report Number | :ER-2021-20085 | Test Site | :SAC III Chamber |
| Operation Mode | :802.11n20 | Test Date | :2021-03-15 |
| Test Frequency | :5700 MHz | Temp./Humi. | :22.4/61 |
| Test Mode | :Bandedge CH High | Antenna Pol. | :HORIZONTAL |
| EUT Pol | :H Plane | Engineer | :Ricky |

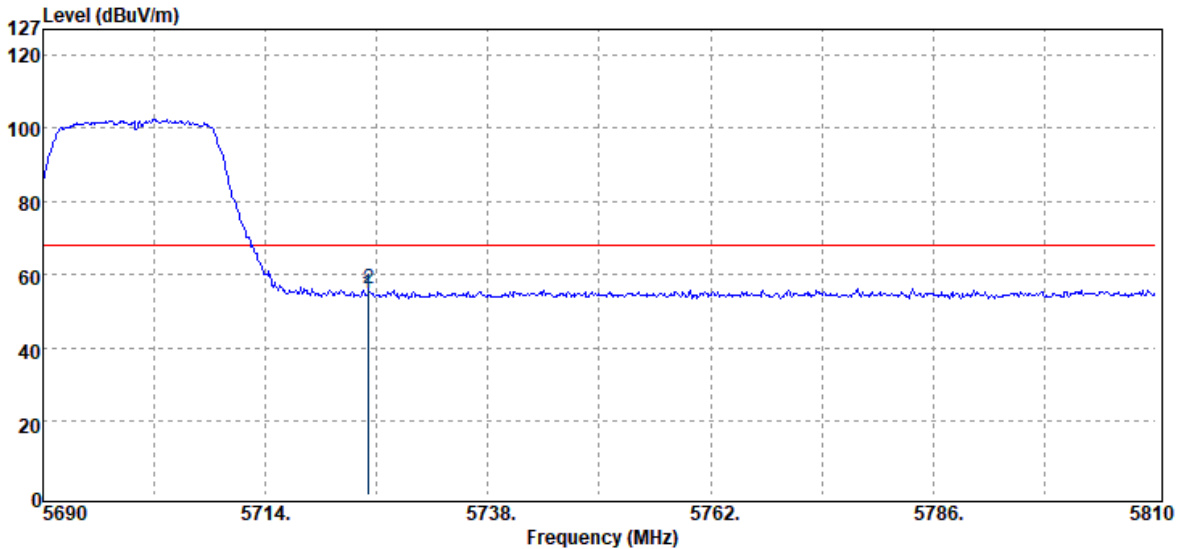

| Freq. MHz | Detector Mode PK/QP/AV | Spectrum Reading Level dB μ V | Factor dB | Actual FS dB μ V/m | Limit @3m dB μ V/m | Margin dB |
|--------------|------------------------------|---|--------------|------------------------------|------------------------------|--------------|
| 5725.00 | Peak | 46.61 | 8.12 | 54.73 | 68.20 | -13.47 |
| 5725.16 | Peak | 47.98 | 8.12 | 56.10 | 68.20 | -12.10 |

Unless otherwise stated the results shown in this test report refer only to the sample(s) tested and such sample(s) are retained for 90 days only.

除非另有說明，此報告結果僅對測試之樣品負責，同時此樣品僅保留90天。本報告未經本公司書面許可，不可部份複製。

This document is issued by the Company subject to its General Conditions of Service printed overleaf, available on request or accessible at <http://www.sgs.com.tw/Terms-and-Conditions> and for electronic format documents, subject to Terms and Conditions for Electronic Documents at <http://www.sgs.com.tw/Terms-and-Conditions>. Attention is drawn to the limitation of liability, indemnification and jurisdiction issues defined therein. Any holder of this document is advised that information contained hereon reflects the Company's findings at the time of its intervention only and within the limits of Client's instructions, if any. The Company's sole responsibility is to its Client and this document does not exonerate parties to a transaction from exercising all their rights and obligations under the transaction documents. This document cannot be reproduced except in full, without prior written approval of the Company. Any unauthorized alteration, forgery or falsification of the content or appearance of this document is unlawful and offenders may be prosecuted to the fullest extent of the law.

| | | | |
|----------------|------------------|--------------|------------------|
| Report Number | :ER-2021-20085 | Test Site | :SAC III Chamber |
| Operation Mode | :802.11n20 | Test Date | :2021-03-15 |
| Test Frequency | :5745 MHz | Temp./Humi. | :22.4/61 |
| Test Mode | :Bandedge CH Low | Antenna Pol. | :VERTICAL |
| EUT Pol | :H Plane | Engineer | :Ricky |

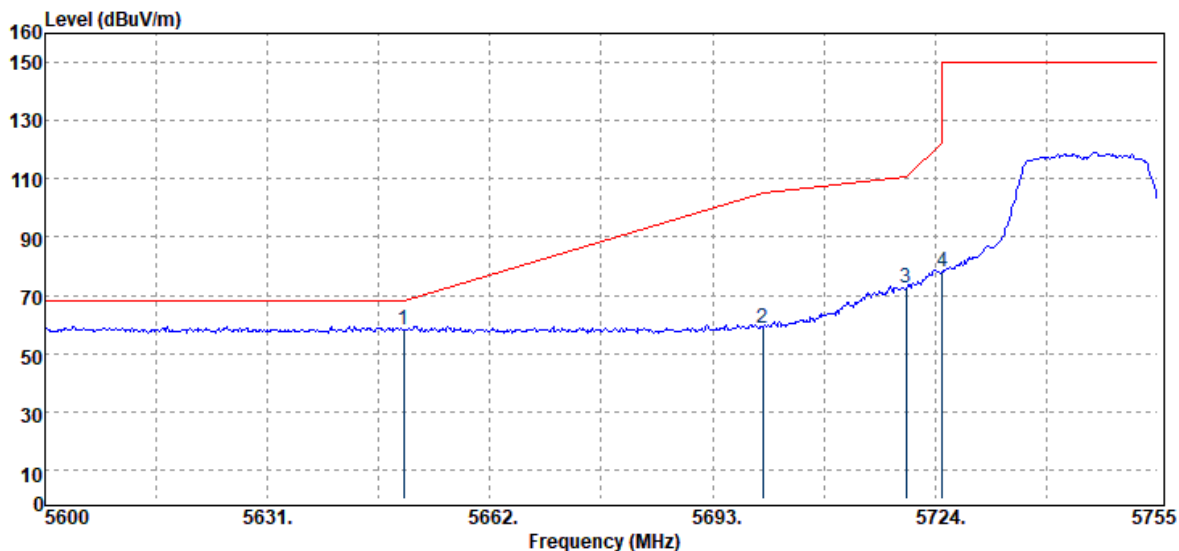

| Freq. MHz | Detector Mode PK/QP/AV | Spectrum Reading Level dBμV | Factor dB | Actual FS dBμV/m | Limit @3m dBμV/m | Margin dB |
|--------------|------------------------------|-----------------------------------|--------------|------------------------|------------------------|--------------|
| 5650.00 | Peak | 49.83 | 8.08 | 57.91 | 68.20 | -10.29 |
| 5700.00 | Peak | 50.62 | 8.02 | 58.64 | 105.20 | -46.56 |
| 5720.00 | Peak | 64.48 | 8.10 | 72.58 | 110.80 | -38.22 |
| 5725.00 | Peak | 69.89 | 8.12 | 78.01 | 122.20 | -44.19 |

Unless otherwise stated the results shown in this test report refer only to the sample(s) tested and such sample(s) are retained for 90 days only.

除非另有說明，此報告結果僅對測試之樣品負責，同時此樣品僅保留90天。本報告未經本公司書面許可，不可部份複製。

This document is issued by the Company subject to its General Conditions of Service printed overleaf, available on request or accessible at <http://www.sgs.com.tw/Terms-and-Conditions> and for electronic format documents, subject to Terms and Conditions for Electronic Documents at <http://www.sgs.com.tw/Terms-and-Conditions>. Attention is drawn to the limitation of liability, indemnification and jurisdiction issues defined therein. Any holder of this document is advised that information contained hereon reflects the Company's findings at the time of its intervention only and within the limits of Client's instructions, if any. The Company's sole responsibility is to its Client and this document does not exonerate parties to a transaction from exercising all their rights and obligations under the transaction documents. This document cannot be reproduced except in full, without prior written approval of the Company. Any unauthorized alteration, forgery or falsification of the content or appearance of this document is unlawful and offenders may be prosecuted to the fullest extent of the law.

| | | | |
|----------------|------------------|--------------|------------------|
| Report Number | :ER-2021-20085 | Test Site | :SAC III Chamber |
| Operation Mode | :802.11n20 | Test Date | :2021-03-15 |
| Test Frequency | :5745 MHz | Temp./Humi. | :22.4/61 |
| Test Mode | :Bandedge CH Low | Antenna Pol. | :HORIZONTAL |
| EUT Pol | :H Plane | Engineer | :Ricky |

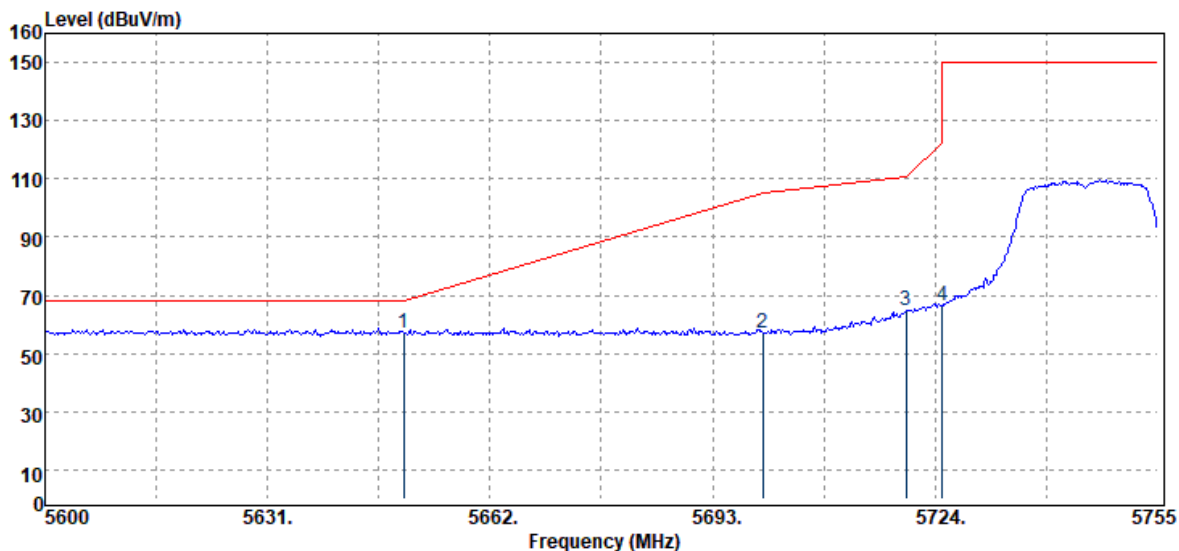

| Freq. MHz | Detector Mode PK/QP/AV | Spectrum Reading Level dB μ V | Factor dB | Actual FS dB μ V/m | Limit @3m dB μ V/m | Margin dB |
|--------------|------------------------------|---|--------------|------------------------------|------------------------------|--------------|
| 5650.00 | Peak | 48.93 | 8.08 | 57.01 | 68.20 | -11.19 |
| 5700.00 | Peak | 49.18 | 8.02 | 57.20 | 105.20 | -48.00 |
| 5720.00 | Peak | 56.42 | 8.10 | 64.52 | 110.80 | -46.28 |
| 5725.00 | Peak | 58.50 | 8.12 | 66.62 | 122.20 | -55.58 |

Unless otherwise stated the results shown in this test report refer only to the sample(s) tested and such sample(s) are retained for 90 days only.

除非另有說明，此報告結果僅對測試之樣品負責，同時此樣品僅保留90天。本報告未經本公司書面許可，不可部份複製。

This document is issued by the Company subject to its General Conditions of Service printed overleaf, available on request or accessible at <http://www.sgs.com.tw/Terms-and-Conditions> and for electronic format documents, subject to Terms and Conditions for Electronic Documents at <http://www.sgs.com.tw/Terms-and-Conditions>. Attention is drawn to the limitation of liability, indemnification and jurisdiction issues defined therein. Any holder of this document is advised that information contained hereon reflects the Company's findings at the time of its intervention only and within the limits of Client's instructions, if any. The Company's sole responsibility is to its Client and this document does not exonerate parties to a transaction from exercising all their rights and obligations under the transaction documents. This document cannot be reproduced except in full, without prior written approval of the Company. Any unauthorized alteration, forgery or falsification of the content or appearance of this document is unlawful and offenders may be prosecuted to the fullest extent of the law.

| | | | |
|----------------|-------------------|--------------|------------------|
| Report Number | :ER-2021-20085 | Test Site | :SAC III Chamber |
| Operation Mode | :802.11n20 | Test Date | :2021-03-15 |
| Test Frequency | :5825 MHz | Temp./Humi. | :22.4/61 |
| Test Mode | :Bandedge CH High | Antenna Pol. | :VERTICAL |
| EUT Pol | :H Plane | Engineer | :Ricky |

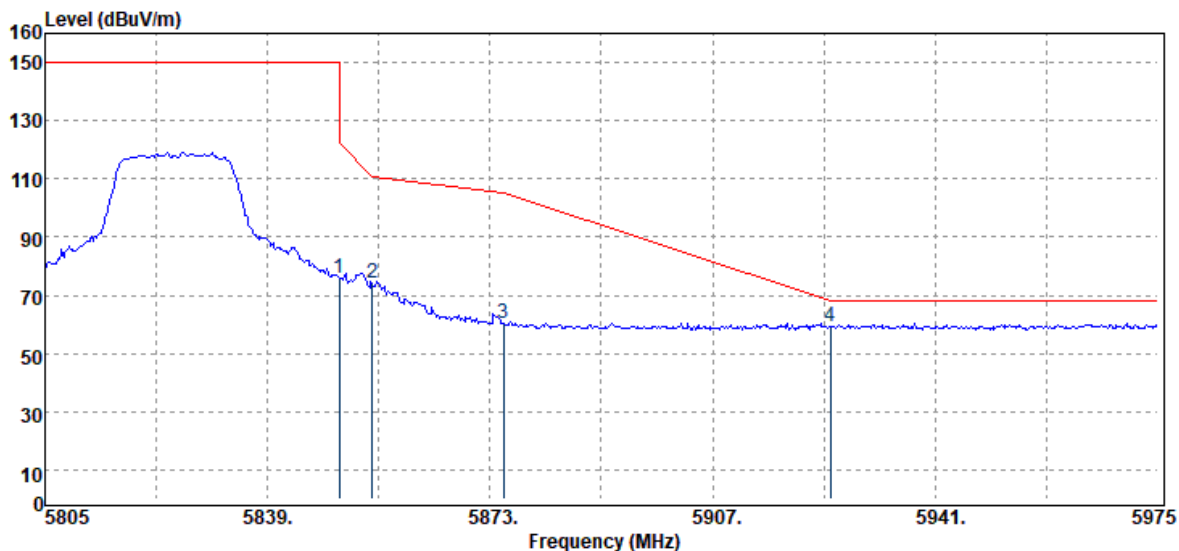

| Freq. MHz | Detector Mode PK/QP/AV | Spectrum Reading Level d μ V | Factor dB | Actual FS d μ V/m | Limit @3m d μ V/m | Margin dB |
|--------------|------------------------------|--|--------------|-----------------------------|-----------------------------|--------------|
| 5850.00 | Peak | 66.92 | 9.02 | 75.94 | 122.20 | -46.26 |
| 5855.00 | Peak | 64.93 | 9.07 | 74.00 | 110.80 | -36.80 |
| 5875.00 | Peak | 51.29 | 9.27 | 60.56 | 105.20 | -44.64 |
| 5925.00 | Peak | 49.42 | 9.70 | 59.12 | 68.20 | -9.08 |

Unless otherwise stated the results shown in this test report refer only to the sample(s) tested and such sample(s) are retained for 90 days only.

除非另有說明，此報告結果僅對測試之樣品負責，同時此樣品僅保留90天。本報告未經本公司書面許可，不可部份複製。

This document is issued by the Company subject to its General Conditions of Service printed overleaf, available on request or accessible at <http://www.sgs.com.tw/Terms-and-Conditions> and for electronic format documents, subject to Terms and Conditions for Electronic Documents at <http://www.sgs.com.tw/Terms-and-Conditions>. Attention is drawn to the limitation of liability, indemnification and jurisdiction issues defined therein. Any holder of this document is advised that information contained hereon reflects the Company's findings at the time of its intervention only and within the limits of Client's instructions, if any. The Company's sole responsibility is to its Client and this document does not exonerate parties to a transaction from exercising all their rights and obligations under the transaction documents. This document cannot be reproduced except in full, without prior written approval of the Company. Any unauthorized alteration, forgery or falsification of the content or appearance of this document is unlawful and offenders may be prosecuted to the fullest extent of the law.

| | | | |
|----------------|-------------------|--------------|------------------|
| Report Number | :ER-2021-20085 | Test Site | :SAC III Chamber |
| Operation Mode | :802.11n20 | Test Date | :2021-03-15 |
| Test Frequency | :5825 MHz | Temp./Humi. | :22.4/61 |
| Test Mode | :Bandedge CH High | Antenna Pol. | :HORIZONTAL |
| EUT Pol | :H Plane | Engineer | :Ricky |

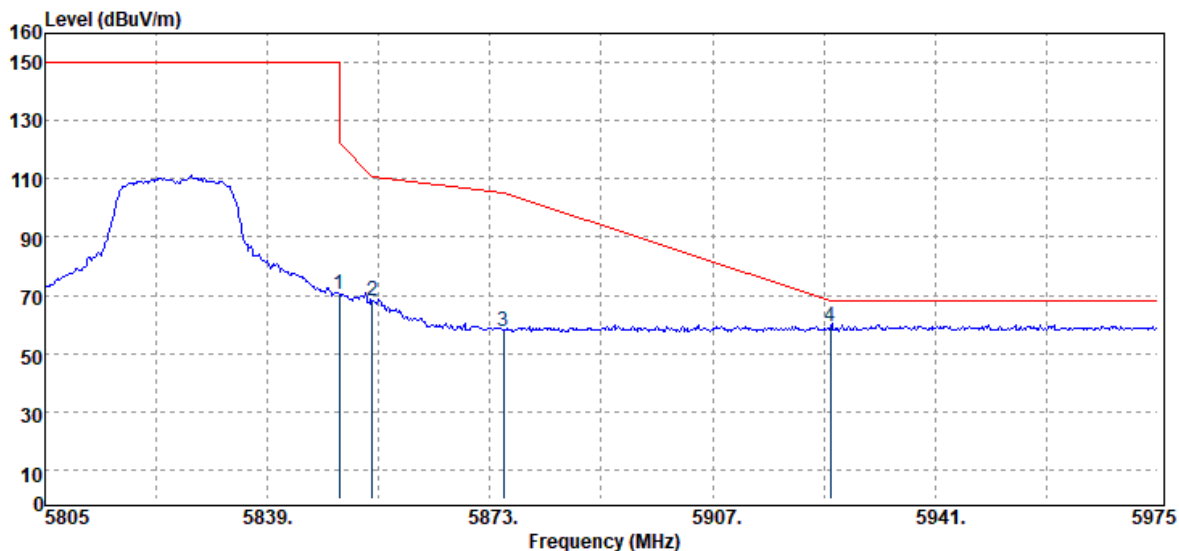

| Freq. MHz | Detector Mode PK/QP/AV | Spectrum Reading Level dB μ V | Factor dB | Actual FS dB μ V/m | Limit @3m dB μ V/m | Margin dB |
|--------------|------------------------------|---|--------------|------------------------------|------------------------------|--------------|
| 5850.00 | Peak | 61.40 | 9.02 | 70.42 | 122.20 | -51.78 |
| 5855.00 | Peak | 59.24 | 9.07 | 68.31 | 110.80 | -42.49 |
| 5875.00 | Peak | 48.30 | 9.27 | 57.57 | 105.20 | -47.63 |
| 5925.00 | Peak | 49.65 | 9.70 | 59.35 | 68.20 | -8.85 |

Unless otherwise stated the results shown in this test report refer only to the sample(s) tested and such sample(s) are retained for 90 days only.

除非另有說明，此報告結果僅對測試之樣品負責，同時此樣品僅保留90天。本報告未經本公司書面許可，不可部份複製。

This document is issued by the Company subject to its General Conditions of Service printed overleaf, available on request or accessible at <http://www.sgs.com.tw/Terms-and-Conditions> and for electronic format documents, subject to Terms and Conditions for Electronic Documents at <http://www.sgs.com.tw/Terms-and-Conditions>. Attention is drawn to the limitation of liability, indemnification and jurisdiction issues defined therein. Any holder of this document is advised that information contained hereon reflects the Company's findings at the time of its intervention only and within the limits of Client's instructions, if any. The Company's sole responsibility is to its Client and this document does not exonerate parties to a transaction from exercising all their rights and obligations under the transaction documents. This document cannot be reproduced except in full, without prior written approval of the Company. Any unauthorized alteration, forgery or falsification of the content or appearance of this document is unlawful and offenders may be prosecuted to the fullest extent of the law.

| | | | |
|----------------|------------------|--------------|------------------|
| Report Number | :ER-2021-20085 | Test Site | :SAC III Chamber |
| Operation Mode | :802.11n40 | Test Date | :2021-03-15 |
| Test Frequency | :5190 MHz | Temp./Humi. | :22.4/61 |
| Test Mode | :Bandedge CH Low | Antenna Pol. | :VERTICAL |
| EUT Pol | :H Plane | Engineer | :Ricky |

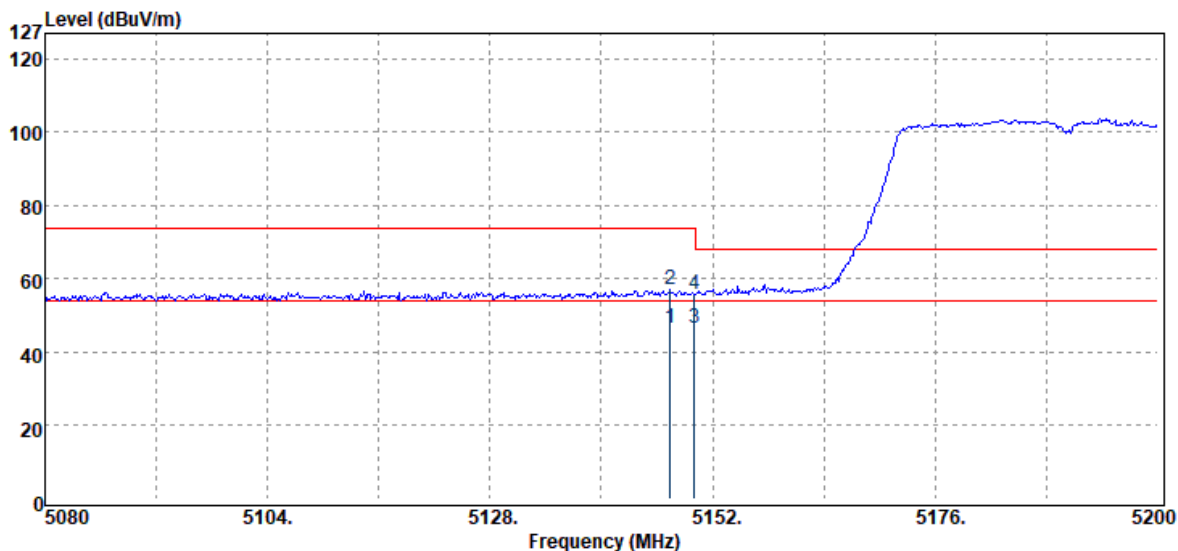

| Freq. MHz | Detector Mode PK/QP/AV | Spectrum Reading Level dB μ V | Factor dB | Actual FS dB μ V/m | Limit @3m dB μ V/m | Margin dB |
|--------------|------------------------------|---|--------------|------------------------------|------------------------------|--------------|
| 5147.44 | Average | 37.96 | 8.54 | 46.50 | 54.00 | -7.50 |
| 5147.44 | Peak | 48.71 | 8.54 | 57.25 | 74.00 | -16.75 |
| 5150.00 | Average | 37.89 | 8.53 | 46.42 | 54.00 | -7.58 |
| 5150.00 | Peak | 47.13 | 8.53 | 55.66 | 74.00 | -18.34 |

Unless otherwise stated the results shown in this test report refer only to the sample(s) tested and such sample(s) are retained for 90 days only.

除非另有說明，此報告結果僅對測試之樣品負責，同時此樣品僅保留90天。本報告未經本公司書面許可，不可部份複製。

This document is issued by the Company subject to its General Conditions of Service printed overleaf, available on request or accessible at <http://www.sgs.com.tw/Terms-and-Conditions> and for electronic format documents, subject to Terms and Conditions for Electronic Documents at <http://www.sgs.com.tw/Terms-and-Conditions>. Attention is drawn to the limitation of liability, indemnification and jurisdiction issues defined therein. Any holder of this document is advised that information contained hereon reflects the Company's findings at the time of its intervention only and within the limits of Client's instructions, if any. The Company's sole responsibility is to its Client and this document does not exonerate parties to a transaction from exercising all their rights and obligations under the transaction documents. This document cannot be reproduced except in full, without prior written approval of the Company. Any unauthorized alteration, forgery or falsification of the content or appearance of this document is unlawful and offenders may be prosecuted to the fullest extent of the law.

| | | | |
|----------------|------------------|--------------|------------------|
| Report Number | :ER-2021-20085 | Test Site | :SAC III Chamber |
| Operation Mode | :802.11n40 | Test Date | :2021-03-15 |
| Test Frequency | :5190 MHz | Temp./Humi. | :22.4/61 |
| Test Mode | :Bandedge CH Low | Antenna Pol. | :HORIZONTAL |
| EUT Pol | :H Plane | Engineer | :Ricky |

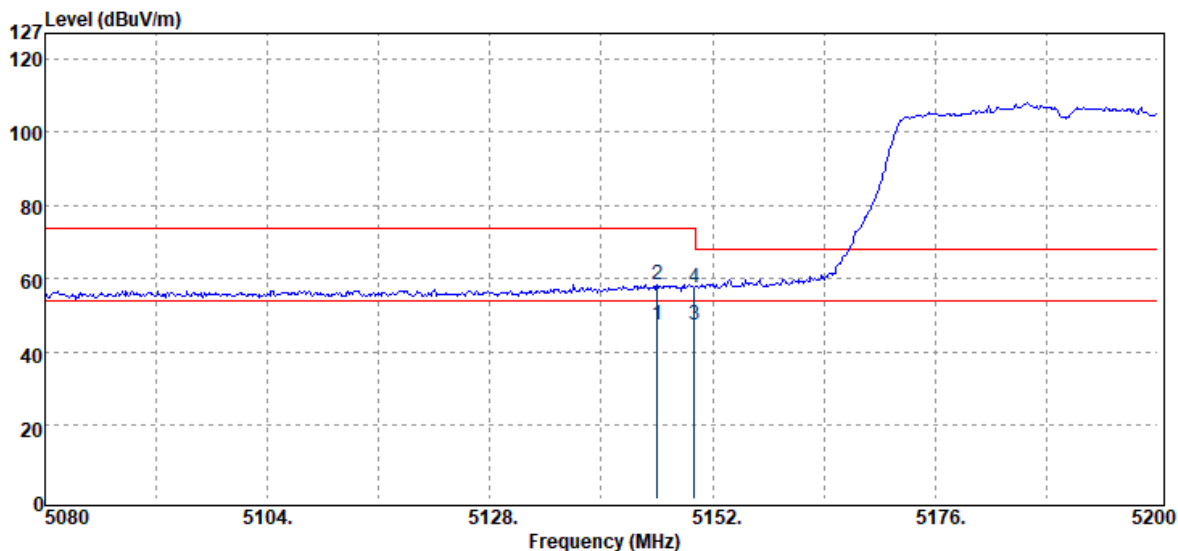

| Freq. MHz | Detector Mode PK/QP/AV | Spectrum Reading Level dB μ V | Factor dB | Actual FS dB μ V/m | Limit @3m dB μ V/m | Margin dB |
|--------------|------------------------------|---|--------------|------------------------------|------------------------------|--------------|
| 5146.00 | Average | 38.92 | 8.53 | 47.45 | 54.00 | -6.55 |
| 5146.00 | Peak | 50.11 | 8.53 | 58.64 | 74.00 | -15.36 |
| 5150.00 | Average | 39.09 | 8.53 | 47.62 | 54.00 | -6.38 |
| 5150.00 | Peak | 49.02 | 8.53 | 57.55 | 74.00 | -16.45 |

Unless otherwise stated the results shown in this test report refer only to the sample(s) tested and such sample(s) are retained for 90 days only.

除非另有說明，此報告結果僅對測試之樣品負責，同時此樣品僅保留90天。本報告未經本公司書面許可，不可部份複製。

This document is issued by the Company subject to its General Conditions of Service printed overleaf, available on request or accessible at <http://www.sgs.com.tw/Terms-and-Conditions> and for electronic format documents, subject to Terms and Conditions for Electronic Documents at <http://www.sgs.com.tw/Terms-and-Conditions>. Attention is drawn to the limitation of liability, indemnification and jurisdiction issues defined therein. Any holder of this document is advised that information contained hereon reflects the Company's findings at the time of its intervention only and within the limits of Client's instructions, if any. The Company's sole responsibility is to its Client and this document does not exonerate parties to a transaction from exercising all their rights and obligations under the transaction documents. This document cannot be reproduced except in full, without prior written approval of the Company. Any unauthorized alteration, forgery or falsification of the content or appearance of this document is unlawful and offenders may be prosecuted to the fullest extent of the law.

| | | | |
|----------------|-------------------|--------------|------------------|
| Report Number | :ER-2021-20085 | Test Site | :SAC III Chamber |
| Operation Mode | :802.11n40 | Test Date | :2021-03-15 |
| Test Frequency | :5310 MHz | Temp./Humi. | :22.4/61 |
| Test Mode | :Bandedge CH High | Antenna Pol. | :VERTICAL |
| EUT Pol | :H Plane | Engineer | :Ricky |

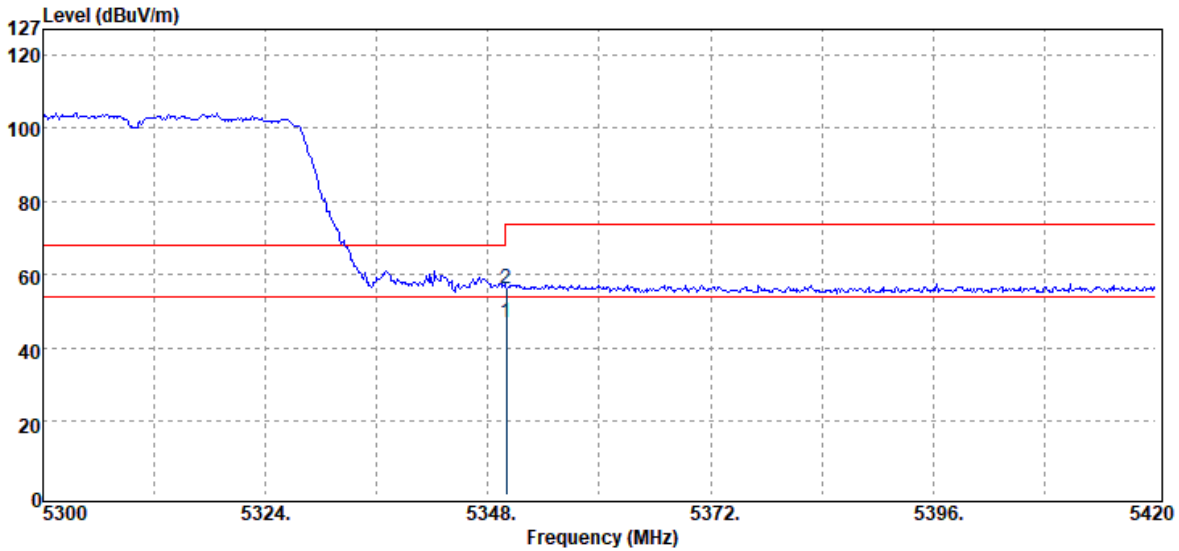

| Freq. MHz | Detector Mode PK/QP/AV | Spectrum Reading Level dB μ V | Factor dB | Actual FS dB μ V/m | Limit @3m dB μ V/m | Margin dB |
|--------------|------------------------------|---|--------------|------------------------------|------------------------------|--------------|
| 5350.00 | Average | 38.18 | 8.77 | 46.95 | 54.00 | -7.05 |
| 5350.00 | Peak | 47.58 | 8.77 | 56.35 | 74.00 | -17.65 |

Unless otherwise stated the results shown in this test report refer only to the sample(s) tested and such sample(s) are retained for 90 days only.

除非另有說明，此報告結果僅對測試之樣品負責，同時此樣品僅保留90天。本報告未經本公司書面許可，不可部份複製。

This document is issued by the Company subject to its General Conditions of Service printed overleaf, available on request or accessible at <http://www.sgs.com.tw/Terms-and-Conditions> and for electronic format documents, subject to Terms and Conditions for Electronic Documents at <http://www.sgs.com.tw/Terms-and-Conditions>. Attention is drawn to the limitation of liability, indemnification and jurisdiction issues defined therein. Any holder of this document is advised that information contained hereon reflects the Company's findings at the time of its intervention only and within the limits of Client's instructions, if any. The Company's sole responsibility is to its Client and this document does not exonerate parties to a transaction from exercising all their rights and obligations under the transaction documents. This document cannot be reproduced except in full, without prior written approval of the Company. Any unauthorized alteration, forgery or falsification of the content or appearance of this document is unlawful and offenders may be prosecuted to the fullest extent of the law.

| | | | |
|----------------|-------------------|--------------|------------------|
| Report Number | :ER-2021-20085 | Test Site | :SAC III Chamber |
| Operation Mode | :802.11n40 | Test Date | :2021-03-15 |
| Test Frequency | :5310 MHz | Temp./Humi. | :22.4/61 |
| Test Mode | :Bandedge CH High | Antenna Pol. | :HORIZONTAL |
| EUT Pol | :H Plane | Engineer | :Ricky |

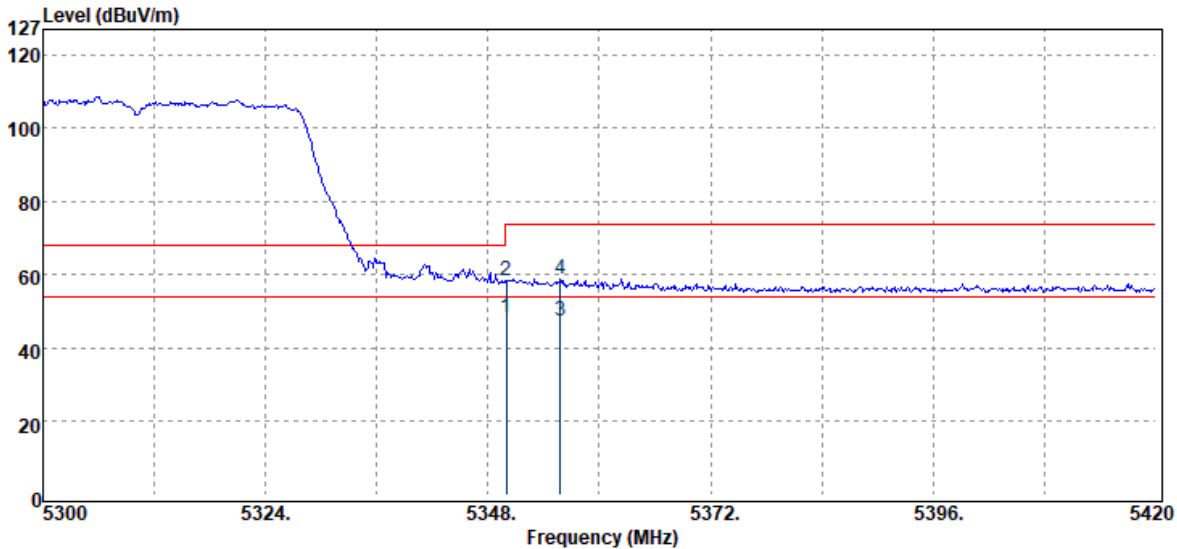

| Freq. MHz | Detector Mode PK/QP/AV | Spectrum Reading Level dB μ V | Factor dB | Actual FS dB μ V/m | Limit @3m dB μ V/m | Margin dB |
|--------------|------------------------------|---|--------------|------------------------------|------------------------------|--------------|
| 5350.00 | Average | 39.51 | 8.77 | 48.28 | 54.00 | -5.72 |
| 5350.00 | Peak | 49.89 | 8.77 | 58.66 | 74.00 | -15.34 |
| 5355.80 | Average | 38.69 | 8.83 | 47.52 | 54.00 | -6.48 |
| 5355.80 | Peak | 50.26 | 8.83 | 59.09 | 74.00 | -14.91 |

Unless otherwise stated the results shown in this test report refer only to the sample(s) tested and such sample(s) are retained for 90 days only.

除非另有說明，此報告結果僅對測試之樣品負責，同時此樣品僅保留90天。本報告未經本公司書面許可，不可部份複製。

This document is issued by the Company subject to its General Conditions of Service printed overleaf, available on request or accessible at <http://www.sgs.com.tw/Terms-and-Conditions> and for electronic format documents, subject to Terms and Conditions for Electronic Documents at <http://www.sgs.com.tw/Terms-and-Conditions>. Attention is drawn to the limitation of liability, indemnification and jurisdiction issues defined therein. Any holder of this document is advised that information contained hereon reflects the Company's findings at the time of its intervention only and within the limits of Client's instructions, if any. The Company's sole responsibility is to its Client and this document does not exonerate parties to a transaction from exercising all their rights and obligations under the transaction documents. This document cannot be reproduced except in full, without prior written approval of the Company. Any unauthorized alteration, forgery or falsification of the content or appearance of this document is unlawful and offenders may be prosecuted to the fullest extent of the law.

| | | | |
|----------------|------------------|--------------|------------------|
| Report Number | :ER-2021-20085 | Test Site | :SAC III Chamber |
| Operation Mode | :802.11n40 | Test Date | :2021-03-15 |
| Test Frequency | :5510 MHz | Temp./Humi. | :22.4/61 |
| Test Mode | :Bandedge CH Low | Antenna Pol. | :VERTICAL |
| EUT Pol | :H Plane | Engineer | :Ricky |

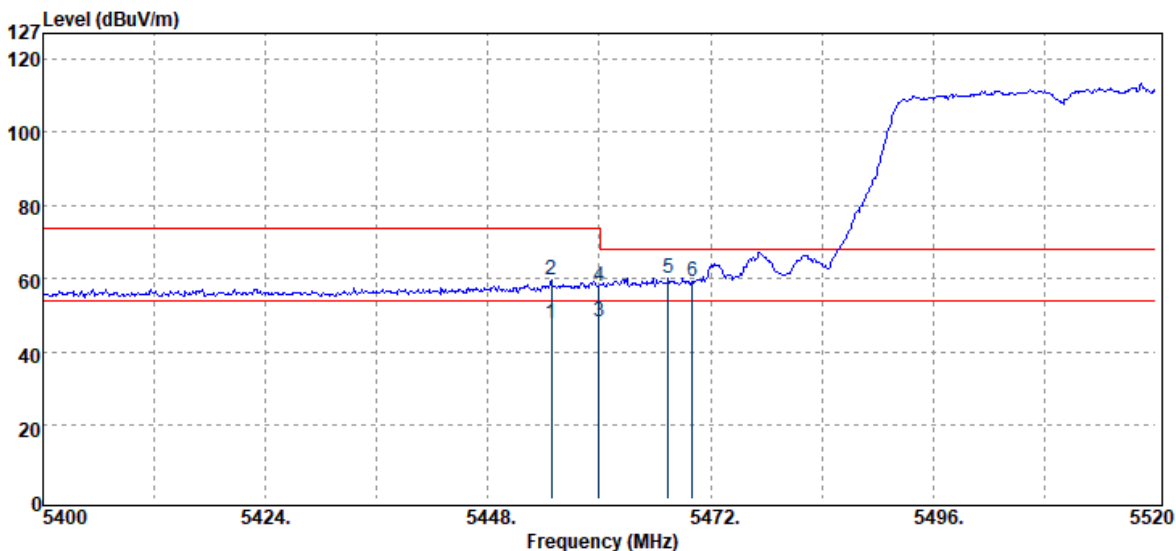

| Freq. MHz | Detector Mode PK/QP/AV | Spectrum Reading Level dB μ V | Factor dB | Actual FS dB μ V/m | Limit @3m dB μ V/m | Margin dB |
|--------------|------------------------------|---|--------------|------------------------------|------------------------------|--------------|
| 5454.84 | Average | 38.27 | 9.60 | 47.87 | 54.00 | -6.13 |
| 5454.84 | Peak | 50.23 | 9.60 | 59.83 | 74.00 | -14.17 |
| 5460.00 | Average | 38.72 | 9.63 | 48.35 | 54.00 | -5.65 |
| 5460.00 | Peak | 48.54 | 9.63 | 58.17 | 74.00 | -15.83 |
| 5467.44 | Peak | 50.61 | 9.68 | 60.29 | 68.20 | -7.91 |
| 5470.00 | Peak | 49.77 | 9.71 | 59.48 | 68.20 | -8.72 |

Unless otherwise stated the results shown in this test report refer only to the sample(s) tested and such sample(s) are retained for 90 days only.

除非另有說明，此報告結果僅對測試之樣品負責，同時此樣品僅保留90天。本報告未經本公司書面許可，不可部份複製。

This document is issued by the Company subject to its General Conditions of Service printed overleaf, available on request or accessible at <http://www.sgs.com.tw/Terms-and-Conditions> and for electronic format documents, subject to Terms and Conditions for Electronic Documents at <http://www.sgs.com.tw/Terms-and-Conditions>. Attention is drawn to the limitation of liability, indemnification and jurisdiction issues defined therein. Any holder of this document is advised that information contained hereon reflects the Company's findings at the time of its intervention only and within the limits of Client's instructions, if any. The Company's sole responsibility is to its Client and this document does not exonerate parties to a transaction from exercising all their rights and obligations under the transaction documents. This document cannot be reproduced except in full, without prior written approval of the Company. Any unauthorized alteration, forgery or falsification of the content or appearance of this document is unlawful and offenders may be prosecuted to the fullest extent of the law.

| | | | |
|----------------|------------------|--------------|------------------|
| Report Number | :ER-2021-20085 | Test Site | :SAC III Chamber |
| Operation Mode | :802.11n40 | Test Date | :2021-03-15 |
| Test Frequency | :5510 MHz | Temp./Humi. | :22.4/61 |
| Test Mode | :Bandedge CH Low | Antenna Pol. | :HORIZONTAL |
| EUT Pol | :H Plane | Engineer | :Ricky |

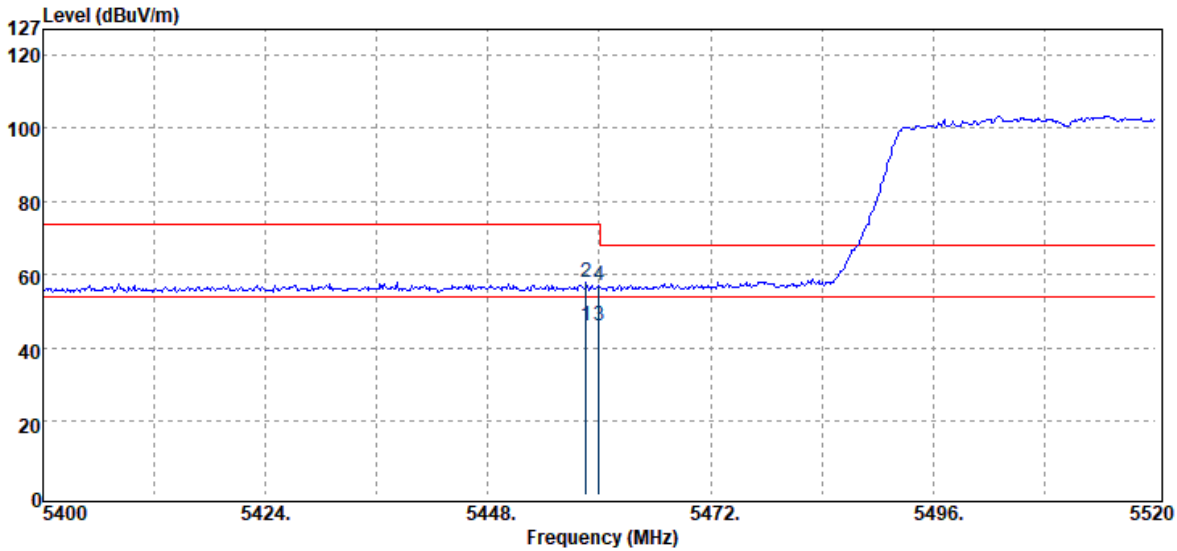

| Freq. MHz | Detector Mode PK/QP/AV | Spectrum Reading Level dB μ V | Factor dB | Actual FS dB μ V/m | Limit @3m dB μ V/m | Margin dB |
|--------------|------------------------------|---|--------------|------------------------------|------------------------------|--------------|
| 5458.56 | Average | 36.62 | 9.62 | 46.24 | 54.00 | -7.76 |
| 5458.56 | Peak | 48.44 | 9.62 | 58.06 | 74.00 | -15.94 |
| 5460.00 | Average | 36.63 | 9.63 | 46.26 | 54.00 | -7.74 |
| 5460.00 | Peak | 47.33 | 9.63 | 56.96 | 74.00 | -17.04 |

Unless otherwise stated the results shown in this test report refer only to the sample(s) tested and such sample(s) are retained for 90 days only.

除非另有說明，此報告結果僅對測試之樣品負責，同時此樣品僅保留90天。本報告未經本公司書面許可，不可部份複製。

This document is issued by the Company subject to its General Conditions of Service printed overleaf, available on request or accessible at <http://www.sgs.com.tw/Terms-and-Conditions> and for electronic format documents, subject to Terms and Conditions for Electronic Documents at <http://www.sgs.com.tw/Terms-and-Conditions>. Attention is drawn to the limitation of liability, indemnification and jurisdiction issues defined therein. Any holder of this document is advised that information contained hereon reflects the Company's findings at the time of its intervention only and within the limits of Client's instructions, if any. The Company's sole responsibility is to its Client and this document does not exonerate parties to a transaction from exercising all their rights and obligations under the transaction documents. This document cannot be reproduced except in full, without prior written approval of the Company. Any unauthorized alteration, forgery or falsification of the content or appearance of this document is unlawful and offenders may be prosecuted to the fullest extent of the law.

| | | | |
|----------------|-------------------|--------------|------------------|
| Report Number | :ER-2021-20085 | Test Site | :SAC III Chamber |
| Operation Mode | :802.11n40 | Test Date | :2021-03-15 |
| Test Frequency | :5670 MHz | Temp./Humi. | :22.4/61 |
| Test Mode | :Bandedge CH High | Antenna Pol. | :VERTICAL |
| EUT Pol | :H Plane | Engineer | :Ricky |

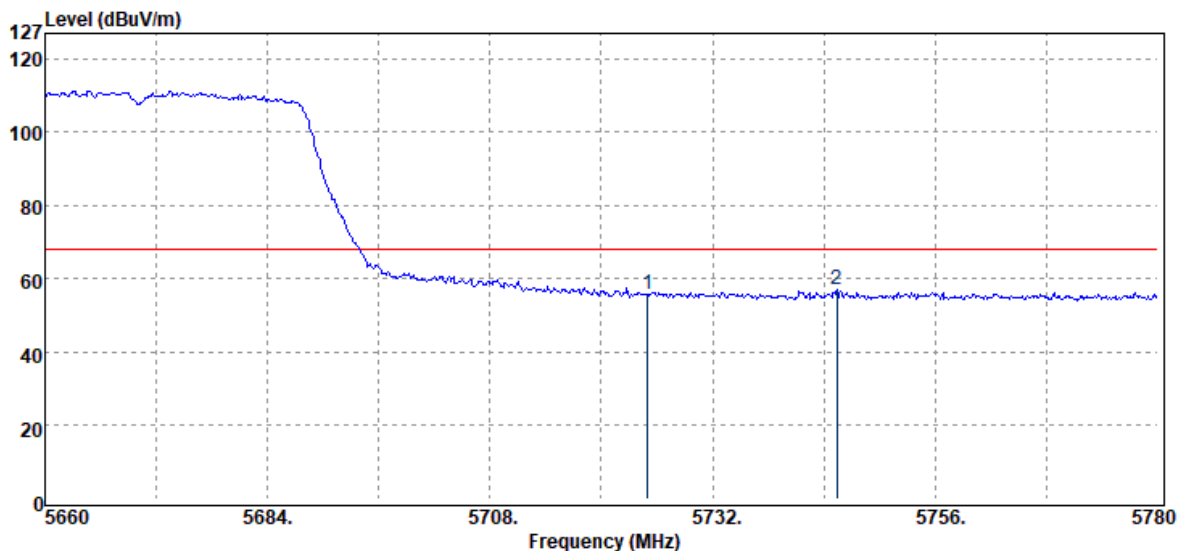

| Freq. MHz | Detector Mode PK/QP/AV | Spectrum Reading Level dB μ V | Factor dB | Actual FS dB μ V/m | Limit @3m dB μ V/m | Margin dB |
|--------------|------------------------------|---|--------------|------------------------------|------------------------------|--------------|
| 5725.00 | Peak | 47.82 | 8.12 | 55.94 | 68.20 | -12.26 |
| 5745.44 | Peak | 49.14 | 8.19 | 57.33 | 68.20 | -10.87 |

Unless otherwise stated the results shown in this test report refer only to the sample(s) tested and such sample(s) are retained for 90 days only.

除非另有說明，此報告結果僅對測試之樣品負責，同時此樣品僅保留90天。本報告未經本公司書面許可，不可部份複製。

This document is issued by the Company subject to its General Conditions of Service printed overleaf, available on request or accessible at <http://www.sgs.com.tw/Terms-and-Conditions> and for electronic format documents, subject to Terms and Conditions for Electronic Documents at <http://www.sgs.com.tw/Terms-and-Conditions>. Attention is drawn to the limitation of liability, indemnification and jurisdiction issues defined therein. Any holder of this document is advised that information contained hereon reflects the Company's findings at the time of its intervention only and within the limits of Client's instructions, if any. The Company's sole responsibility is to its Client and this document does not exonerate parties to a transaction from exercising all their rights and obligations under the transaction documents. This document cannot be reproduced except in full, without prior written approval of the Company. Any unauthorized alteration, forgery or falsification of the content or appearance of this document is unlawful and offenders may be prosecuted to the fullest extent of the law.

| | | | |
|----------------|-------------------|--------------|------------------|
| Report Number | :ER-2021-20085 | Test Site | :SAC III Chamber |
| Operation Mode | :802.11n40 | Test Date | :2021-03-15 |
| Test Frequency | :5670 MHz | Temp./Humi. | :22.4/61 |
| Test Mode | :Bandedge CH High | Antenna Pol. | :HORIZONTAL |
| EUT Pol | :H Plane | Engineer | :Ricky |

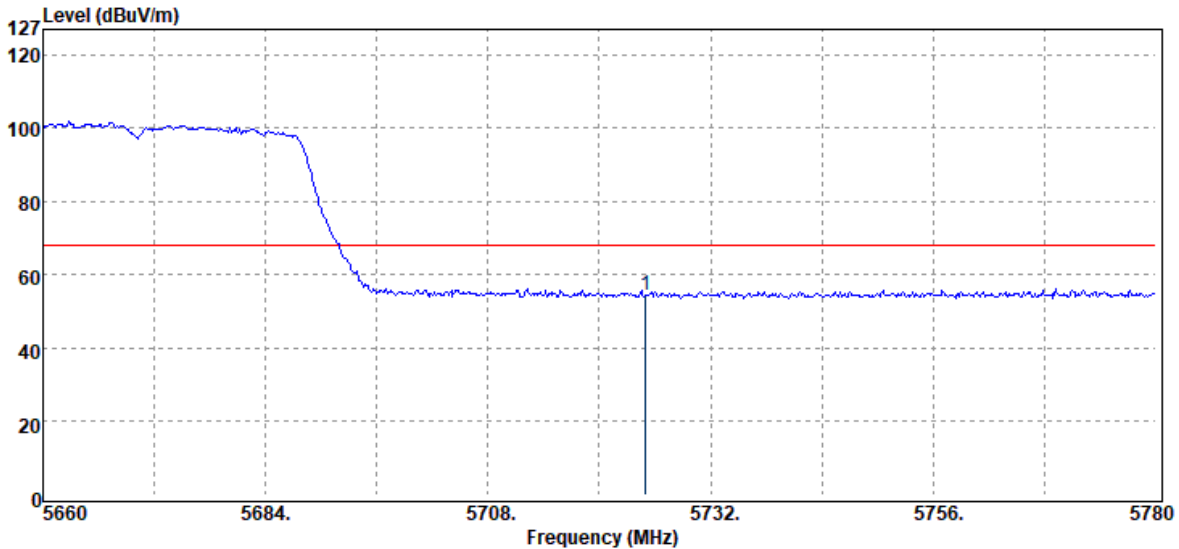

| Freq. MHz | Detector Mode PK/QP/AV | Spectrum Reading Level dB μ V | Factor dB | Actual FS dB μ V/m | Limit @3m dB μ V/m | Margin dB |
|--------------|------------------------------|---|--------------|------------------------------|------------------------------|--------------|
| 5725.00 | Peak | 46.51 | 8.12 | 54.63 | 68.20 | -13.57 |

Unless otherwise stated the results shown in this test report refer only to the sample(s) tested and such sample(s) are retained for 90 days only.

除非另有說明，此報告結果僅對測試之樣品負責，同時此樣品僅保留90天。本報告未經本公司書面許可，不可部份複製。

This document is issued by the Company subject to its General Conditions of Service printed overleaf, available on request or accessible at <http://www.sgs.com.tw/Terms-and-Conditions> and for electronic format documents, subject to Terms and Conditions for Electronic Documents at <http://www.sgs.com.tw/Terms-and-Conditions>. Attention is drawn to the limitation of liability, indemnification and jurisdiction issues defined therein. Any holder of this document is advised that information contained hereon reflects the Company's findings at the time of its intervention only and within the limits of Client's instructions, if any. The Company's sole responsibility is to its Client and this document does not exonerate parties to a transaction from exercising all their rights and obligations under the transaction documents. This document cannot be reproduced except in full, without prior written approval of the Company. Any unauthorized alteration, forgery or falsification of the content or appearance of this document is unlawful and offenders may be prosecuted to the fullest extent of the law.

| | | | |
|----------------|------------------|--------------|------------------|
| Report Number | :ER-2021-20085 | Test Site | :SAC III Chamber |
| Operation Mode | :802.11n40 | Test Date | :2021-03-15 |
| Test Frequency | :5755 MHz | Temp./Humi. | :22.4/61 |
| Test Mode | :Bandedge CH Low | Antenna Pol. | :VERTICAL |
| EUT Pol | :H Plane | Engineer | :Ricky |

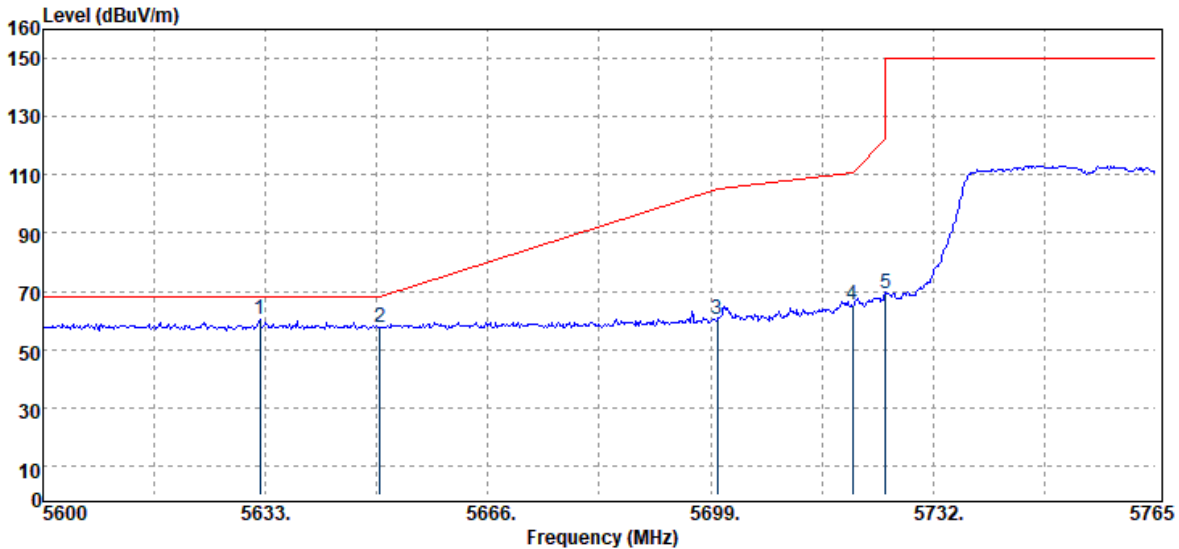

| Freq. MHz | Detector Mode PK/QP/AV | Spectrum Reading Level dB μ V | Factor dB | Actual FS dB μ V/m | Limit @3m dB μ V/m | Margin dB |
|--------------|------------------------------|---|--------------|------------------------------|------------------------------|--------------|
| 5632.18 | Peak | 52.17 | 8.21 | 60.38 | 68.20 | -7.82 |
| 5650.00 | Peak | 49.60 | 8.08 | 57.68 | 68.20 | -10.52 |
| 5700.00 | Peak | 52.49 | 8.02 | 60.51 | 105.20 | -44.69 |
| 5720.00 | Peak | 57.04 | 8.10 | 65.14 | 110.80 | -45.66 |
| 5725.00 | Peak | 60.95 | 8.12 | 69.07 | 122.20 | -53.13 |

Unless otherwise stated the results shown in this test report refer only to the sample(s) tested and such sample(s) are retained for 90 days only.

除非另有說明，此報告結果僅對測試之樣品負責，同時此樣品僅保留90天。本報告未經本公司書面許可，不可部份複製。

This document is issued by the Company subject to its General Conditions of Service printed overleaf, available on request or accessible at <http://www.sgs.com.tw/Terms-and-Conditions> and for electronic format documents, subject to Terms and Conditions for Electronic Documents at <http://www.sgs.com.tw/Terms-and-Conditions>. Attention is drawn to the limitation of liability, indemnification and jurisdiction issues defined therein. Any holder of this document is advised that information contained hereon reflects the Company's findings at the time of its intervention only and within the limits of Client's instructions, if any. The Company's sole responsibility is to its Client and this document does not exonerate parties to a transaction from exercising all their rights and obligations under the transaction documents. This document cannot be reproduced except in full, without prior written approval of the Company. Any unauthorized alteration, forgery or falsification of the content or appearance of this document is unlawful and offenders may be prosecuted to the fullest extent of the law.

| | | | |
|----------------|------------------|--------------|------------------|
| Report Number | :ER-2021-20085 | Test Site | :SAC III Chamber |
| Operation Mode | :802.11n40 | Test Date | :2021-03-15 |
| Test Frequency | :5755 MHz | Temp./Humi. | :22.4/61 |
| Test Mode | :Bandedge CH Low | Antenna Pol. | :HORIZONTAL |
| EUT Pol | :H Plane | Engineer | :Ricky |

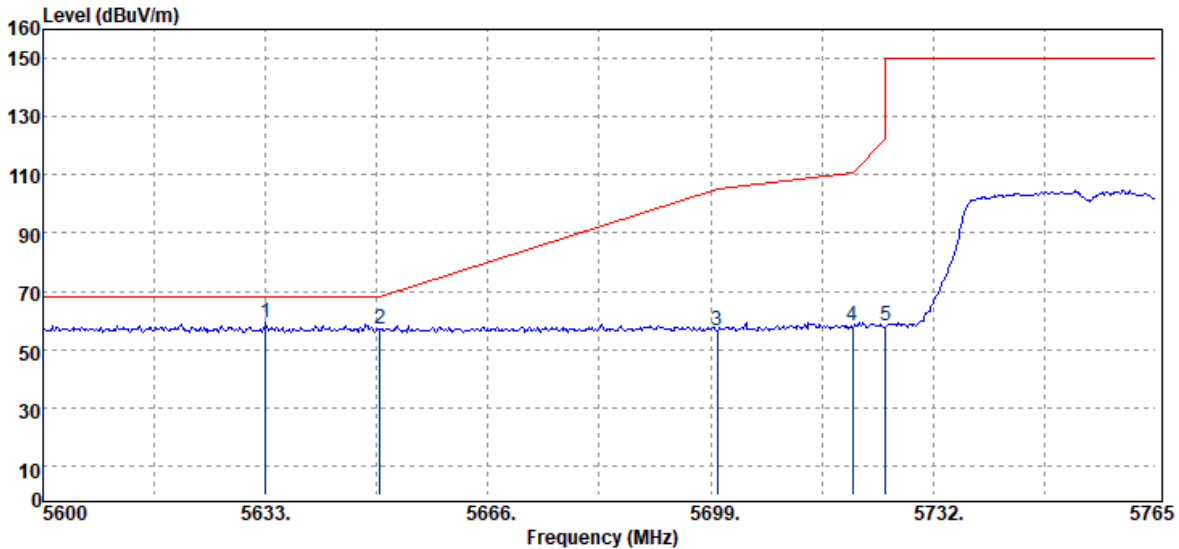

| Freq. MHz | Detector Mode PK/QP/AV | Spectrum Reading Level dB μ V | Factor dB | Actual FS dB μ V/m | Limit @3m dB μ V/m | Margin dB |
|--------------|------------------------------|---|--------------|------------------------------|------------------------------|--------------|
| 5633.00 | Peak | 50.93 | 8.20 | 59.13 | 68.20 | -9.07 |
| 5650.00 | Peak | 48.75 | 8.08 | 56.83 | 68.20 | -11.37 |
| 5700.00 | Peak | 48.33 | 8.02 | 56.35 | 105.20 | -48.85 |
| 5720.00 | Peak | 49.83 | 8.10 | 57.93 | 110.80 | -52.87 |
| 5725.00 | Peak | 49.77 | 8.12 | 57.89 | 122.20 | -64.31 |

Unless otherwise stated the results shown in this test report refer only to the sample(s) tested and such sample(s) are retained for 90 days only.

除非另有說明，此報告結果僅對測試之樣品負責，同時此樣品僅保留90天。本報告未經本公司書面許可，不可部份複製。

This document is issued by the Company subject to its General Conditions of Service printed overleaf, available on request or accessible at <http://www.sgs.com.tw/Terms-and-Conditions> and for electronic format documents, subject to Terms and Conditions for Electronic Documents at <http://www.sgs.com.tw/Terms-and-Conditions>. Attention is drawn to the limitation of liability, indemnification and jurisdiction issues defined therein. Any holder of this document is advised that information contained hereon reflects the Company's findings at the time of its intervention only and within the limits of Client's instructions, if any. The Company's sole responsibility is to its Client and this document does not exonerate parties to a transaction from exercising all their rights and obligations under the transaction documents. This document cannot be reproduced except in full, without prior written approval of the Company. Any unauthorized alteration, forgery or falsification of the content or appearance of this document is unlawful and offenders may be prosecuted to the fullest extent of the law.

| | | | |
|----------------|-------------------|--------------|------------------|
| Report Number | :ER-2021-20085 | Test Site | :SAC III Chamber |
| Operation Mode | :802.11n40 | Test Date | :2021-03-15 |
| Test Frequency | :5795 MHz | Temp./Humi. | :22.4/61 |
| Test Mode | :Bandedge CH High | Antenna Pol. | :VERTICAL |
| EUT Pol | :H Plane | Engineer | :Ricky |

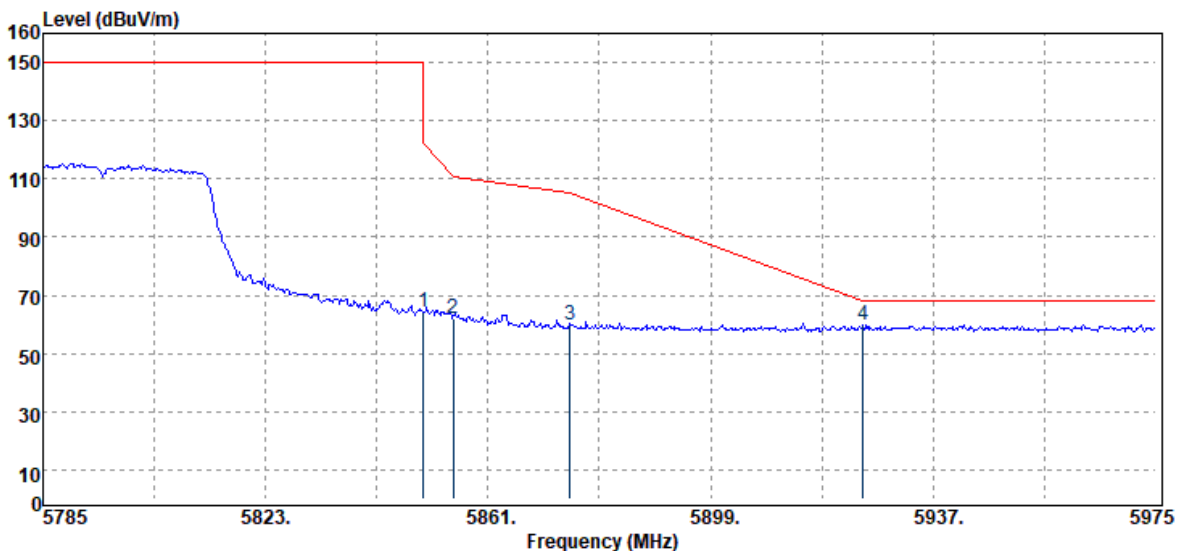

| Freq. MHz | Detector Mode PK/QP/AV | Spectrum Reading Level dB μ V | Factor dB | Actual FS dB μ V/m | Limit @3m dB μ V/m | Margin dB |
|--------------|------------------------------|---|--------------|------------------------------|------------------------------|--------------|
| 5850.00 | Peak | 55.13 | 9.02 | 64.15 | 122.20 | -58.05 |
| 5855.00 | Peak | 52.98 | 9.07 | 62.05 | 110.80 | -48.75 |
| 5875.00 | Peak | 50.78 | 9.27 | 60.05 | 105.20 | -45.15 |
| 5925.00 | Peak | 50.05 | 9.70 | 59.75 | 68.20 | -8.45 |

Unless otherwise stated the results shown in this test report refer only to the sample(s) tested and such sample(s) are retained for 90 days only.

除非另有說明，此報告結果僅對測試之樣品負責，同時此樣品僅保留90天。本報告未經本公司書面許可，不可部份複製。

This document is issued by the Company subject to its General Conditions of Service printed overleaf, available on request or accessible at <http://www.sgs.com.tw/Terms-and-Conditions> and for electronic format documents, subject to Terms and Conditions for Electronic Documents at <http://www.sgs.com.tw/Terms-and-Conditions>. Attention is drawn to the limitation of liability, indemnification and jurisdiction issues defined therein. Any holder of this document is advised that information contained hereon reflects the Company's findings at the time of its intervention only and within the limits of Client's instructions, if any. The Company's sole responsibility is to its Client and this document does not exonerate parties to a transaction from exercising all their rights and obligations under the transaction documents. This document cannot be reproduced except in full, without prior written approval of the Company. Any unauthorized alteration, forgery or falsification of the content or appearance of this document is unlawful and offenders may be prosecuted to the fullest extent of the law.

| | | | |
|----------------|-------------------|--------------|------------------|
| Report Number | :ER-2021-20085 | Test Site | :SAC III Chamber |
| Operation Mode | :802.11n40 | Test Date | :2021-03-15 |
| Test Frequency | :5795 MHz | Temp./Humi. | :22.4/61 |
| Test Mode | :Bandedge CH High | Antenna Pol. | :HORIZONTAL |
| EUT Pol | :H Plane | Engineer | :Ricky |

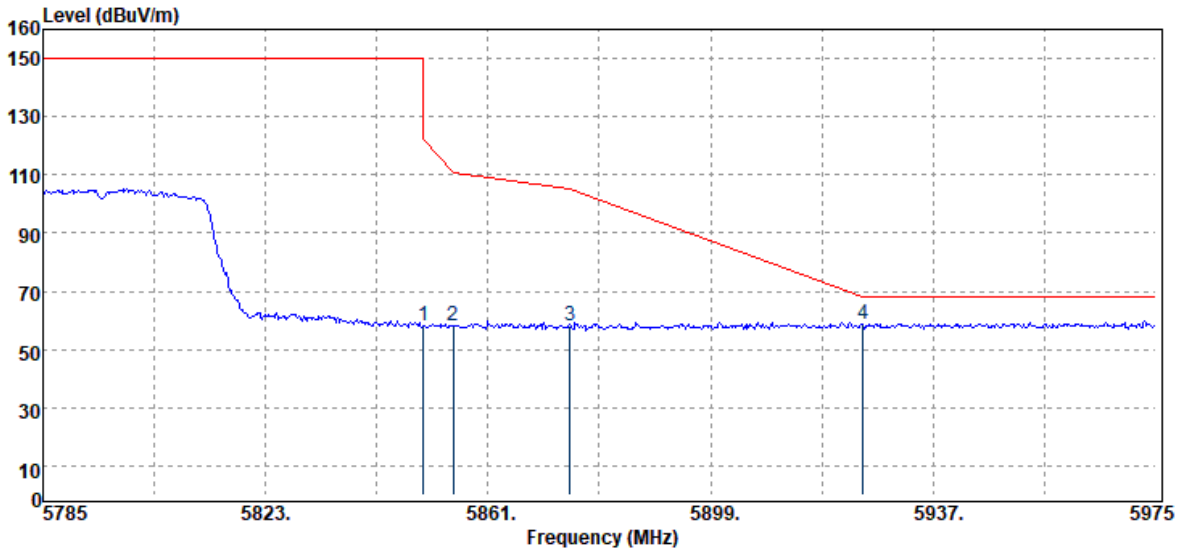

| Freq. MHz | Detector Mode PK/QP/AV | Spectrum Reading Level dB μ V | Factor dB | Actual FS dB μ V/m | Limit @3m dB μ V/m | Margin dB |
|--------------|------------------------------|---|--------------|------------------------------|------------------------------|--------------|
| 5850.00 | Peak | 49.16 | 9.02 | 58.18 | 122.20 | -64.02 |
| 5855.00 | Peak | 49.15 | 9.07 | 58.22 | 110.80 | -52.58 |
| 5875.00 | Peak | 48.72 | 9.27 | 57.99 | 105.20 | -47.21 |
| 5925.00 | Peak | 48.80 | 9.70 | 58.50 | 68.20 | -9.70 |

Unless otherwise stated the results shown in this test report refer only to the sample(s) tested and such sample(s) are retained for 90 days only.

除非另有說明，此報告結果僅對測試之樣品負責，同時此樣品僅保留90天。本報告未經本公司書面許可，不可部份複製。

This document is issued by the Company subject to its General Conditions of Service printed overleaf, available on request or accessible at <http://www.sgs.com.tw/Terms-and-Conditions> and for electronic format documents, subject to Terms and Conditions for Electronic Documents at <http://www.sgs.com.tw/Terms-and-Conditions>. Attention is drawn to the limitation of liability, indemnification and jurisdiction issues defined therein. Any holder of this document is advised that information contained hereon reflects the Company's findings at the time of its intervention only and within the limits of Client's instructions, if any. The Company's sole responsibility is to its Client and this document does not exonerate parties to a transaction from exercising all their rights and obligations under the transaction documents. This document cannot be reproduced except in full, without prior written approval of the Company. Any unauthorized alteration, forgery or falsification of the content or appearance of this document is unlawful and offenders may be prosecuted to the fullest extent of the law.

| | | | |
|----------------|------------------|--------------|------------------|
| Report Number | :ER-2021-20085 | Test Site | :SAC III Chamber |
| Operation Mode | :802.11ac80 | Test Date | :2021-03-15 |
| Test Frequency | :5210 MHz | Temp./Humi. | :22.4/61 |
| Test Mode | :Bandedge CH Low | Antenna Pol. | :VERTICAL |
| EUT Pol | :H Plane | Engineer | :Ricky |

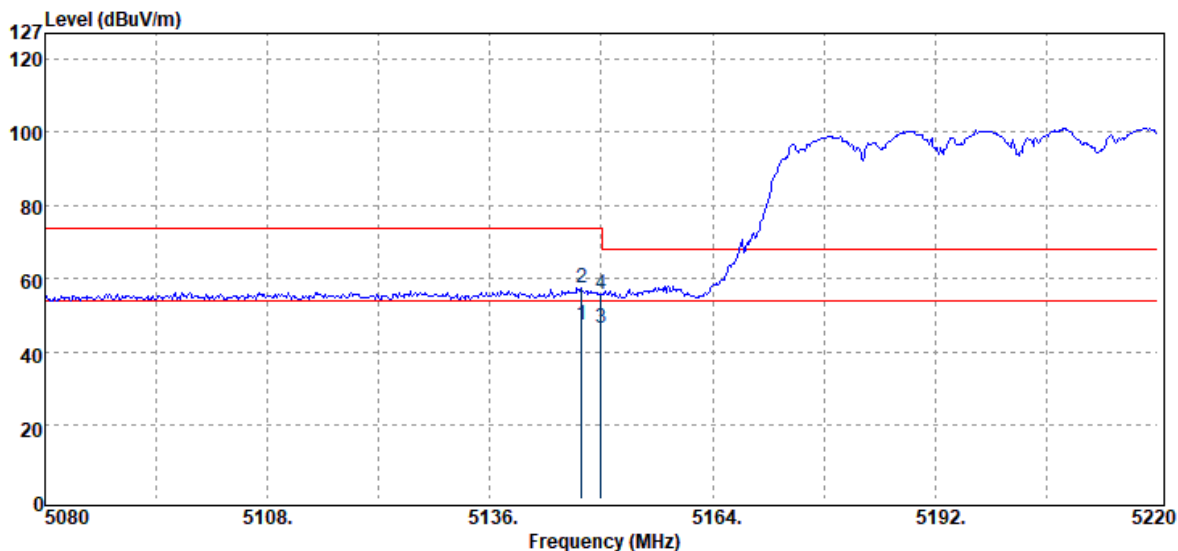

| Freq. MHz | Detector Mode PK/QP/AV | Spectrum Reading Level dB μ V | Factor dB | Actual FS dB μ V/m | Limit @3m dB μ V/m | Margin dB |
|--------------|------------------------------|---|--------------|------------------------------|------------------------------|--------------|
| 5147.48 | Average | 38.91 | 8.54 | 47.45 | 54.00 | -6.55 |
| 5147.48 | Peak | 49.09 | 8.54 | 57.63 | 74.00 | -16.37 |
| 5150.00 | Average | 38.13 | 8.53 | 46.66 | 54.00 | -7.34 |
| 5150.00 | Peak | 47.37 | 8.53 | 55.90 | 74.00 | -18.10 |

Unless otherwise stated the results shown in this test report refer only to the sample(s) tested and such sample(s) are retained for 90 days only.

除非另有說明，此報告結果僅對測試之樣品負責，同時此樣品僅保留90天。本報告未經本公司書面許可，不可部份複製。

This document is issued by the Company subject to its General Conditions of Service printed overleaf, available on request or accessible at <http://www.sgs.com.tw/Terms-and-Conditions> and for electronic format documents, subject to Terms and Conditions for Electronic Documents at <http://www.sgs.com.tw/Terms-and-Conditions>. Attention is drawn to the limitation of liability, indemnification and jurisdiction issues defined therein. Any holder of this document is advised that information contained hereon reflects the Company's findings at the time of its intervention only and within the limits of Client's instructions, if any. The Company's sole responsibility is to its Client and this document does not exonerate parties to a transaction from exercising all their rights and obligations under the transaction documents. This document cannot be reproduced except in full, without prior written approval of the Company. Any unauthorized alteration, forgery or falsification of the content or appearance of this document is unlawful and offenders may be prosecuted to the fullest extent of the law.

| | | | |
|----------------|------------------|--------------|------------------|
| Report Number | :ER-2021-20085 | Test Site | :SAC III Chamber |
| Operation Mode | :802.11ac80 | Test Date | :2021-03-15 |
| Test Frequency | :5210 MHz | Temp./Humi. | :22.4/61 |
| Test Mode | :Bandedge CH Low | Antenna Pol. | :HORIZONTAL |
| EUT Pol | :H Plane | Engineer | :Ricky |

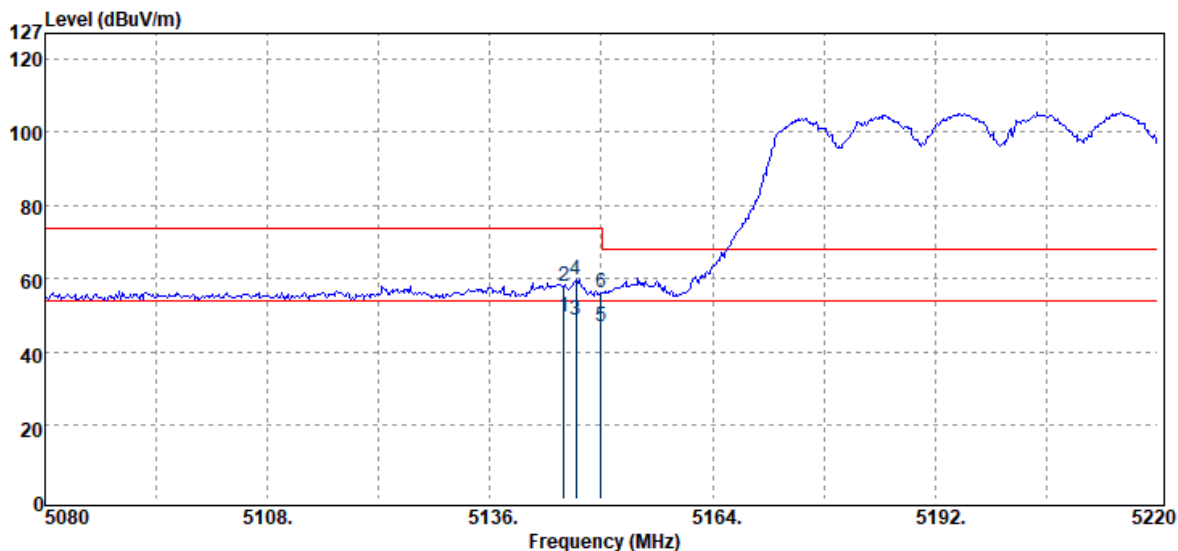

| Freq. MHz | Detector Mode PK/QP/AV | Spectrum Reading Level dB μ V | Factor dB | Actual FS dB μ V/m | Limit @3m dB μ V/m | Margin dB |
|--------------|------------------------------|---|--------------|------------------------------|------------------------------|--------------|
| 5145.30 | Average | 41.02 | 8.54 | 49.56 | 54.00 | -4.44 |
| 5145.30 | Peak | 49.46 | 8.54 | 58.00 | 74.00 | -16.00 |
| 5146.78 | Average | 40.22 | 8.53 | 48.75 | 54.00 | -5.25 |
| 5146.78 | Peak | 51.06 | 8.53 | 59.59 | 74.00 | -14.41 |
| 5150.00 | Average | 38.32 | 8.53 | 46.85 | 54.00 | -7.15 |
| 5150.00 | Peak | 47.66 | 8.53 | 56.19 | 74.00 | -17.81 |

Unless otherwise stated the results shown in this test report refer only to the sample(s) tested and such sample(s) are retained for 90 days only.

除非另有說明，此報告結果僅對測試之樣品負責，同時此樣品僅保留90天。本報告未經本公司書面許可，不可部份複製。

This document is issued by the Company subject to its General Conditions of Service printed overleaf, available on request or accessible at <http://www.sgs.com.tw/Terms-and-Conditions> and for electronic format documents, subject to Terms and Conditions for Electronic Documents at <http://www.sgs.com.tw/Terms-and-Conditions>. Attention is drawn to the limitation of liability, indemnification and jurisdiction issues defined therein. Any holder of this document is advised that information contained hereon reflects the Company's findings at the time of its intervention only and within the limits of Client's instructions, if any. The Company's sole responsibility is to its Client and this document does not exonerate parties to a transaction from exercising all their rights and obligations under the transaction documents. This document cannot be reproduced except in full, without prior written approval of the Company. Any unauthorized alteration, forgery or falsification of the content or appearance of this document is unlawful and offenders may be prosecuted to the fullest extent of the law.

| | | | |
|----------------|------------------|--------------|------------------|
| Report Number | :ER-2021-20085 | Test Site | :SAC III Chamber |
| Operation Mode | :802.11ac80 | Test Date | :2021-03-15 |
| Test Frequency | :5290 MHz | Temp./Humi. | :22.4/61 |
| Test Mode | :Bandedge CH Low | Antenna Pol. | :VERTICAL |
| EUT Pol | :H Plane | Engineer | :Ricky |

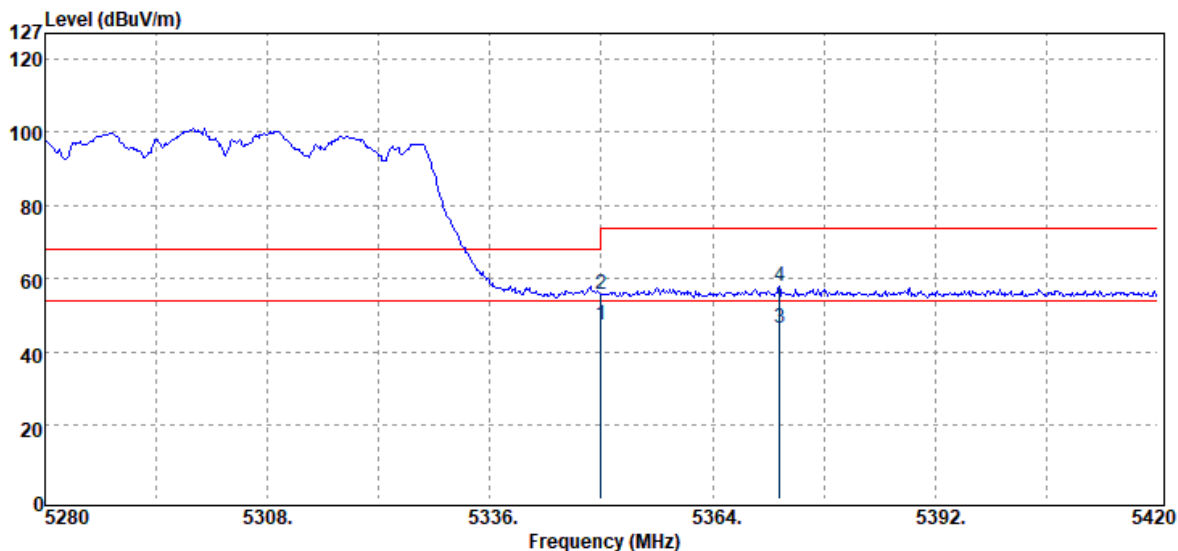

| Freq. MHz | Detector Mode PK/QP/AV | Spectrum Reading Level dB μ V | Factor dB | Actual FS dB μ V/m | Limit @3m dB μ V/m | Margin dB |
|--------------|------------------------------|---|--------------|------------------------------|------------------------------|--------------|
| 5350.00 | Average | 38.61 | 8.77 | 47.38 | 54.00 | -6.62 |
| 5350.00 | Peak | 47.02 | 8.77 | 55.79 | 74.00 | -18.21 |
| 5372.40 | Average | 37.64 | 9.05 | 46.69 | 54.00 | -7.31 |
| 5372.40 | Peak | 48.98 | 9.05 | 58.03 | 74.00 | -15.97 |

Unless otherwise stated the results shown in this test report refer only to the sample(s) tested and such sample(s) are retained for 90 days only.

除非另有說明，此報告結果僅對測試之樣品負責，同時此樣品僅保留90天。本報告未經本公司書面許可，不可部份複製。

This document is issued by the Company subject to its General Conditions of Service printed overleaf, available on request or accessible at <http://www.sgs.com.tw/Terms-and-Conditions> and for electronic format documents, subject to Terms and Conditions for Electronic Documents at <http://www.sgs.com.tw/Terms-and-Conditions>. Attention is drawn to the limitation of liability, indemnification and jurisdiction issues defined therein. Any holder of this document is advised that information contained hereon reflects the Company's findings at the time of its intervention only and within the limits of Client's instructions, if any. The Company's sole responsibility is to its Client and this document does not exonerate parties to a transaction from exercising all their rights and obligations under the transaction documents. This document cannot be reproduced except in full, without prior written approval of the Company. Any unauthorized alteration, forgery or falsification of the content or appearance of this document is unlawful and offenders may be prosecuted to the fullest extent of the law.

| | | | |
|----------------|------------------|--------------|------------------|
| Report Number | :ER-2021-20085 | Test Site | :SAC III Chamber |
| Operation Mode | :802.11ac80 | Test Date | :2021-03-15 |
| Test Frequency | :5290 MHz | Temp./Humi. | :22.4/61 |
| Test Mode | :Bandedge CH Low | Antenna Pol. | :HORIZONTAL |
| EUT Pol | :H Plane | Engineer | :Ricky |

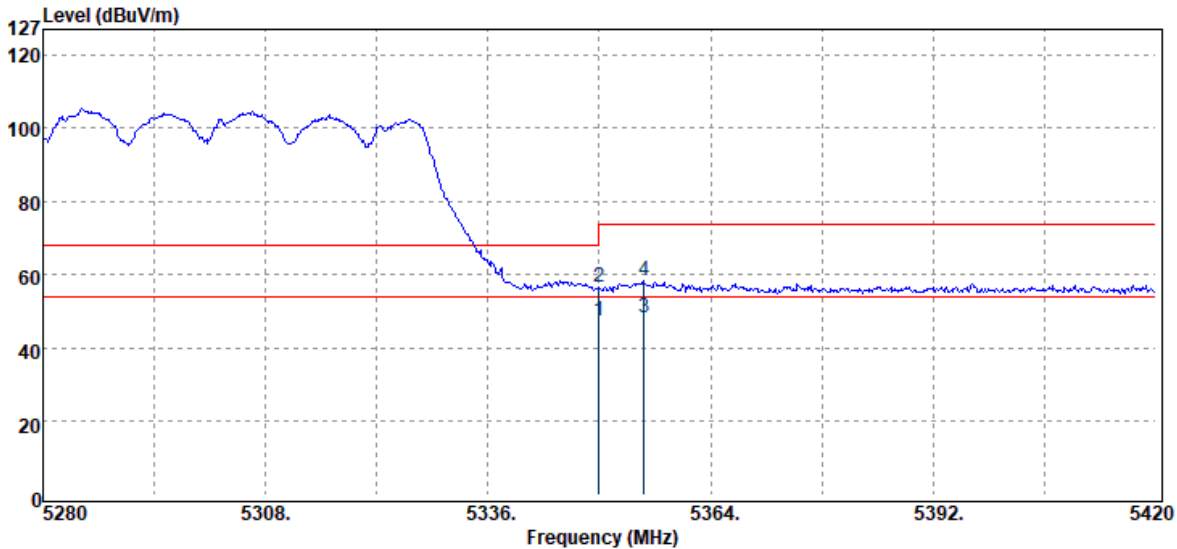

| Freq. MHz | Detector Mode PK/QP/AV | Spectrum Reading Level dB μ V | Factor dB | Actual FS dB μ V/m | Limit @3m dB μ V/m | Margin dB |
|--------------|------------------------------|---|--------------|------------------------------|------------------------------|--------------|
| 5350.00 | Average | 38.61 | 8.77 | 47.38 | 54.00 | -6.62 |
| 5350.00 | Peak | 48.01 | 8.77 | 56.78 | 74.00 | -17.22 |
| 5355.60 | Average | 39.40 | 8.83 | 48.23 | 54.00 | -5.77 |
| 5355.60 | Peak | 49.45 | 8.83 | 58.28 | 74.00 | -15.72 |

Unless otherwise stated the results shown in this test report refer only to the sample(s) tested and such sample(s) are retained for 90 days only.

除非另有說明，此報告結果僅對測試之樣品負責，同時此樣品僅保留90天。本報告未經本公司書面許可，不可部份複製。

This document is issued by the Company subject to its General Conditions of Service printed overleaf, available on request or accessible at <http://www.sgs.com.tw/Terms-and-Conditions> and for electronic format documents, subject to Terms and Conditions for Electronic Documents at <http://www.sgs.com.tw/Terms-and-Conditions>. Attention is drawn to the limitation of liability, indemnification and jurisdiction issues defined therein. Any holder of this document is advised that information contained hereon reflects the Company's findings at the time of its intervention only and within the limits of Client's instructions, if any. The Company's sole responsibility is to its Client and this document does not exonerate parties to a transaction from exercising all their rights and obligations under the transaction documents. This document cannot be reproduced except in full, without prior written approval of the Company. Any unauthorized alteration, forgery or falsification of the content or appearance of this document is unlawful and offenders may be prosecuted to the fullest extent of the law.

| | | | |
|----------------|------------------|--------------|------------------|
| Report Number | :ER-2021-20085 | Test Site | :SAC III Chamber |
| Operation Mode | :802.11ac80 | Test Date | :2021-03-15 |
| Test Frequency | :5530 MHz | Temp./Humi. | :22.4/61 |
| Test Mode | :Bandedge CH Low | Antenna Pol. | :VERTICAL |
| EUT Pol | :H Plane | Engineer | :Ricky |

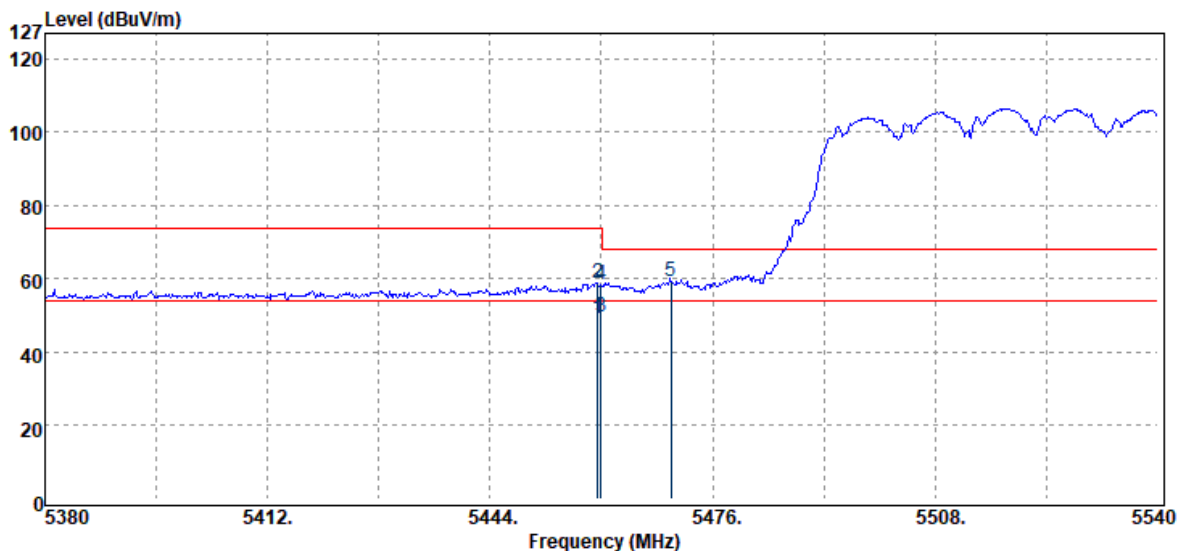

| Freq. MHz | Detector Mode PK/QP/AV | Spectrum Reading Level dB μ V | Factor dB | Actual FS dB μ V/m | Limit @3m dB μ V/m | Margin dB |
|--------------|------------------------------|---|--------------|------------------------------|------------------------------|--------------|
| 5459.52 | Average | 39.46 | 9.63 | 49.09 | 54.00 | -4.91 |
| 5459.52 | Peak | 49.31 | 9.63 | 58.94 | 74.00 | -15.06 |
| 5460.00 | Average | 39.90 | 9.63 | 49.53 | 54.00 | -4.47 |
| 5460.00 | Peak | 48.77 | 9.63 | 58.40 | 74.00 | -15.60 |
| 5470.00 | Peak | 49.53 | 9.71 | 59.24 | 68.20 | -8.96 |

Unless otherwise stated the results shown in this test report refer only to the sample(s) tested and such sample(s) are retained for 90 days only.

除非另有說明，此報告結果僅對測試之樣品負責，同時此樣品僅保留90天。本報告未經本公司書面許可，不可部份複製。

This document is issued by the Company subject to its General Conditions of Service printed overleaf, available on request or accessible at <http://www.sgs.com.tw/Terms-and-Conditions> and for electronic format documents, subject to Terms and Conditions for Electronic Documents at <http://www.sgs.com.tw/Terms-and-Conditions>. Attention is drawn to the limitation of liability, indemnification and jurisdiction issues defined therein. Any holder of this document is advised that information contained hereon reflects the Company's findings at the time of its intervention only and within the limits of Client's instructions, if any. The Company's sole responsibility is to its Client and this document does not exonerate parties to a transaction from exercising all their rights and obligations under the transaction documents. This document cannot be reproduced except in full, without prior written approval of the Company. Any unauthorized alteration, forgery or falsification of the content or appearance of this document is unlawful and offenders may be prosecuted to the fullest extent of the law.

| | | | |
|----------------|------------------|--------------|------------------|
| Report Number | :ER-2021-20085 | Test Site | :SAC III Chamber |
| Operation Mode | :802.11ac80 | Test Date | :2021-03-15 |
| Test Frequency | :5530 MHz | Temp./Humi. | :22.4/61 |
| Test Mode | :Bandedge CH Low | Antenna Pol. | :HORIZONTAL |
| EUT Pol | :H Plane | Engineer | :Ricky |

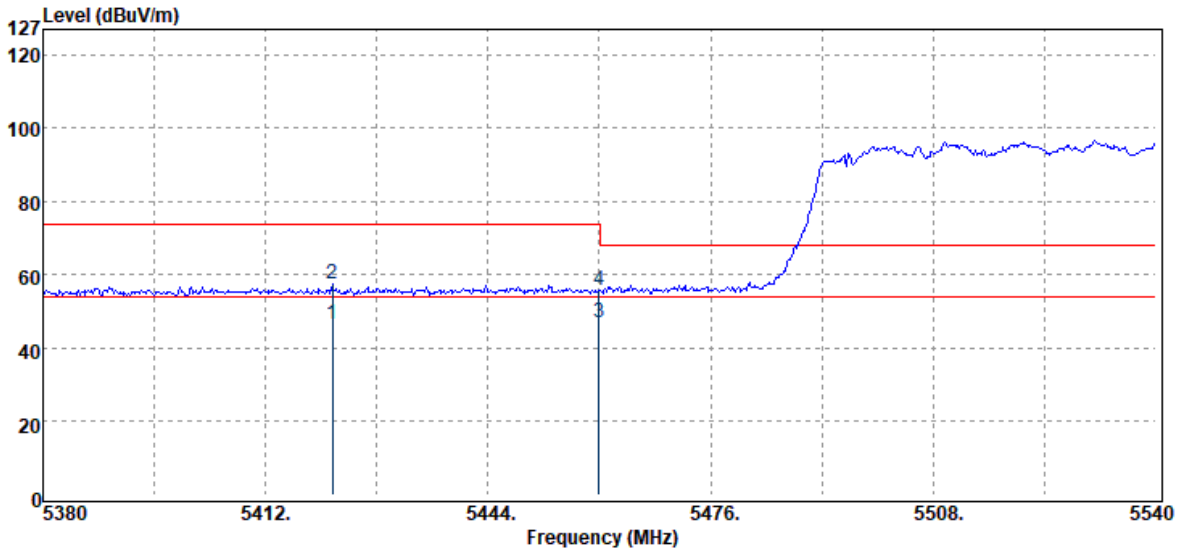

| Freq. MHz | Detector Mode PK/QP/AV | Spectrum Reading Level dB μ V | Factor dB | Actual FS dB μ V/m | Limit @3m dB μ V/m | Margin dB |
|--------------|------------------------------|---|--------------|------------------------------|------------------------------|--------------|
| 5421.60 | Average | 37.16 | 9.48 | 46.64 | 54.00 | -7.36 |
| 5421.60 | Peak | 47.91 | 9.48 | 57.39 | 74.00 | -16.61 |
| 5460.00 | Average | 37.24 | 9.63 | 46.87 | 54.00 | -7.13 |
| 5460.00 | Peak | 46.10 | 9.63 | 55.73 | 74.00 | -18.27 |

Unless otherwise stated the results shown in this test report refer only to the sample(s) tested and such sample(s) are retained for 90 days only.

除非另有說明，此報告結果僅對測試之樣品負責，同時此樣品僅保留90天。本報告未經本公司書面許可，不可部份複製。

This document is issued by the Company subject to its General Conditions of Service printed overleaf, available on request or accessible at <http://www.sgs.com.tw/Terms-and-Conditions> and for electronic format documents, subject to Terms and Conditions for Electronic Documents at <http://www.sgs.com.tw/Terms-and-Conditions>. Attention is drawn to the limitation of liability, indemnification and jurisdiction issues defined therein. Any holder of this document is advised that information contained hereon reflects the Company's findings at the time of its intervention only and within the limits of Client's instructions, if any. The Company's sole responsibility is to its Client and this document does not exonerate parties to a transaction from exercising all their rights and obligations under the transaction documents. This document cannot be reproduced except in full, without prior written approval of the Company. Any unauthorized alteration, forgery or falsification of the content or appearance of this document is unlawful and offenders may be prosecuted to the fullest extent of the law.

| | | | |
|----------------|------------------|--------------|------------------|
| Report Number | :ER-2021-20085 | Test Site | :SAC III Chamber |
| Operation Mode | :802.11ac80 | Test Date | :2021-03-15 |
| Test Frequency | :5610 MHz | Temp./Humi. | :22.4/61 |
| Test Mode | :Bandedge CH Mid | Antenna Pol. | :VERTICAL |
| EUT Pol | :H Plane | Engineer | :Ricky |

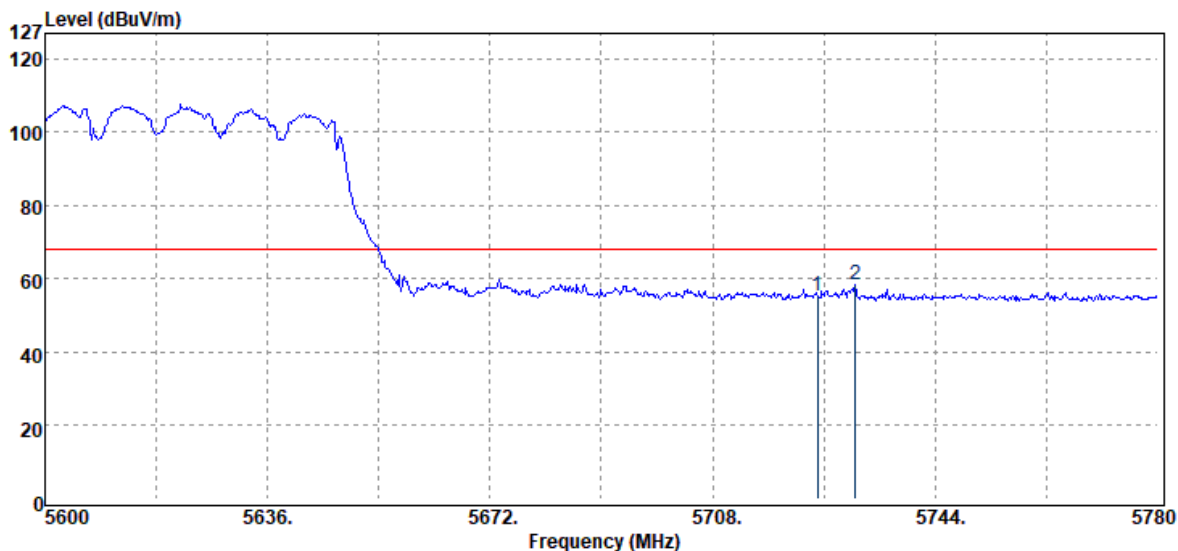

| Freq. MHz | Detector Mode PK/QP/AV | Spectrum Reading Level dBμV | Factor dB | Actual FS dBμV/m | Limit @3m dBμV/m | Margin dB |
|--------------|------------------------------|-----------------------------------|--------------|------------------------|------------------------|--------------|
| 5725.00 | Peak | 47.17 | 8.12 | 55.29 | 68.20 | -12.91 |
| 5731.04 | Peak | 50.27 | 8.14 | 58.41 | 68.20 | -9.79 |

Unless otherwise stated the results shown in this test report refer only to the sample(s) tested and such sample(s) are retained for 90 days only.

除非另有說明，此報告結果僅對測試之樣品負責，同時此樣品僅保留90天。本報告未經本公司書面許可，不可部份複製。

This document is issued by the Company subject to its General Conditions of Service printed overleaf, available on request or accessible at <http://www.sgs.com.tw/Terms-and-Conditions> and for electronic format documents, subject to Terms and Conditions for Electronic Documents at <http://www.sgs.com.tw/Terms-and-Conditions>. Attention is drawn to the limitation of liability, indemnification and jurisdiction issues defined therein. Any holder of this document is advised that information contained hereon reflects the Company's findings at the time of its intervention only and within the limits of Client's instructions, if any. The Company's sole responsibility is to its Client and this document does not exonerate parties to a transaction from exercising all their rights and obligations under the transaction documents. This document cannot be reproduced except in full, without prior written approval of the Company. Any unauthorized alteration, forgery or falsification of the content or appearance of this document is unlawful and offenders may be prosecuted to the fullest extent of the law.

| | | | |
|----------------|------------------|--------------|------------------|
| Report Number | :ER-2021-20085 | Test Site | :SAC III Chamber |
| Operation Mode | :802.11ac80 | Test Date | :2021-03-15 |
| Test Frequency | :5610 MHz | Temp./Humi. | :22.4/61 |
| Test Mode | :Bandedge CH Mid | Antenna Pol. | :HORIZONTAL |
| EUT Pol | :H Plane | Engineer | :Ricky |

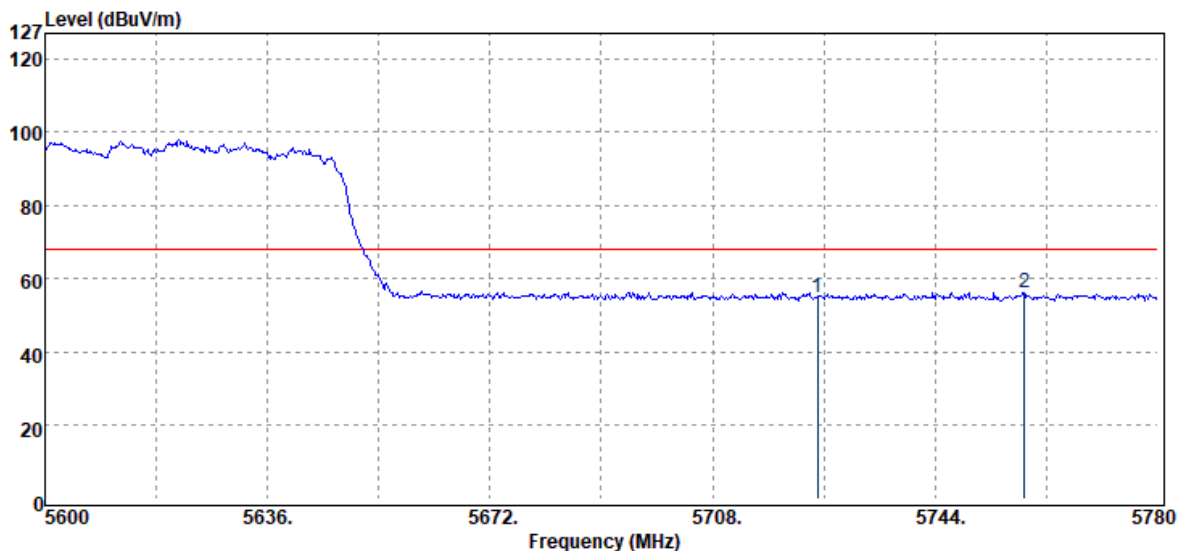

| Freq. MHz | Detector Mode PK/QP/AV | Spectrum Reading Level dB μ V | Factor dB | Actual FS dB μ V/m | Limit @3m dB μ V/m | Margin dB |
|--------------|------------------------------|---|--------------|------------------------------|------------------------------|--------------|
| 5725.00 | Peak | 46.99 | 8.12 | 55.11 | 68.20 | -13.09 |
| 5758.40 | Peak | 48.13 | 8.26 | 56.39 | 68.20 | -11.81 |

Unless otherwise stated the results shown in this test report refer only to the sample(s) tested and such sample(s) are retained for 90 days only.

除非另有說明，此報告結果僅對測試之樣品負責，同時此樣品僅保留90天。本報告未經本公司書面許可，不可部份複製。

This document is issued by the Company subject to its General Conditions of Service printed overleaf, available on request or accessible at <http://www.sgs.com.tw/Terms-and-Conditions> and for electronic format documents, subject to Terms and Conditions for Electronic Documents at <http://www.sgs.com.tw/Terms-and-Conditions>. Attention is drawn to the limitation of liability, indemnification and jurisdiction issues defined therein. Any holder of this document is advised that information contained hereon reflects the Company's findings at the time of its intervention only and within the limits of Client's instructions, if any. The Company's sole responsibility is to its Client and this document does not exonerate parties to a transaction from exercising all their rights and obligations under the transaction documents. This document cannot be reproduced except in full, without prior written approval of the Company. Any unauthorized alteration, forgery or falsification of the content or appearance of this document is unlawful and offenders may be prosecuted to the fullest extent of the law.

| | | | |
|----------------|------------------|--------------|------------------|
| Report Number | :ER-2021-20085 | Test Site | :SAC III Chamber |
| Operation Mode | :802.11ac80 | Test Date | :2021-03-15 |
| Test Frequency | :5775 MHz | Temp./Humi. | :22.4/61 |
| Test Mode | :Bandedge CH Low | Antenna Pol. | :VERTICAL |
| EUT Pol | :H Plane | Engineer | :Ricky |

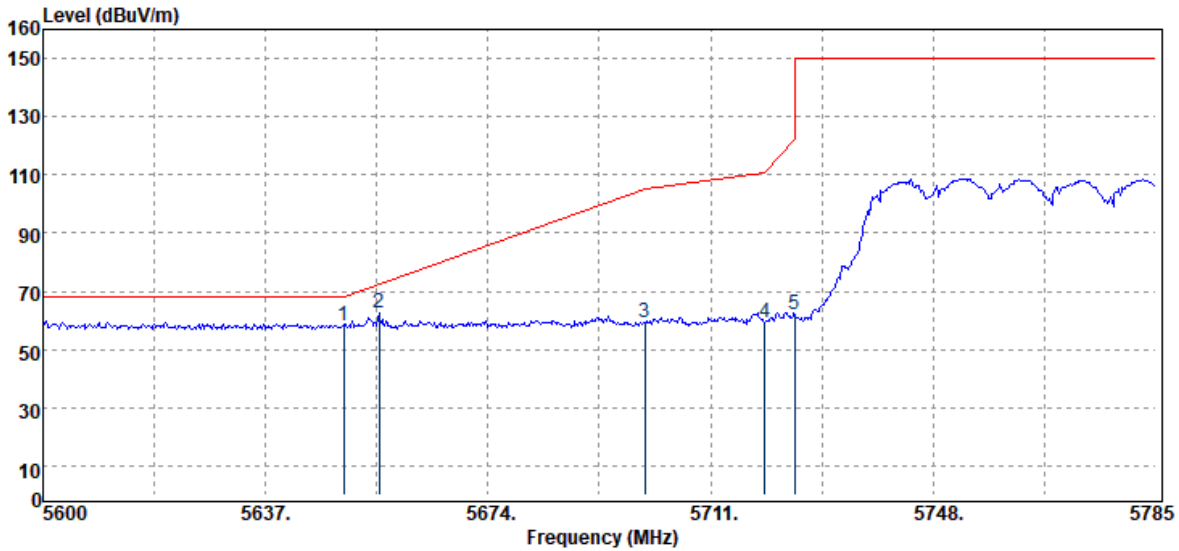

| Freq. MHz | Detector Mode PK/QP/AV | Spectrum Reading Level d μ V | Factor dB | Actual FS d μ V/m | Limit @3m d μ V/m | Margin dB |
|--------------|------------------------------|--|--------------|-----------------------------|-----------------------------|--------------|
| 5650.00 | Peak | 50.27 | 8.08 | 58.35 | 68.20 | -9.85 |
| 5655.87 | Peak | 54.45 | 8.07 | 62.52 | 72.54 | -10.02 |
| 5700.00 | Peak | 51.37 | 8.02 | 59.39 | 105.20 | -45.81 |
| 5720.00 | Peak | 51.33 | 8.10 | 59.43 | 110.80 | -51.37 |
| 5725.00 | Peak | 53.63 | 8.12 | 61.75 | 122.20 | -60.45 |

Unless otherwise stated the results shown in this test report refer only to the sample(s) tested and such sample(s) are retained for 90 days only.

除非另有說明，此報告結果僅對測試之樣品負責，同時此樣品僅保留90天。本報告未經本公司書面許可，不可部份複製。

This document is issued by the Company subject to its General Conditions of Service printed overleaf, available on request or accessible at <http://www.sgs.com.tw/Terms-and-Conditions> and for electronic format documents, subject to Terms and Conditions for Electronic Documents at <http://www.sgs.com.tw/Terms-and-Conditions>. Attention is drawn to the limitation of liability, indemnification and jurisdiction issues defined therein. Any holder of this document is advised that information contained hereon reflects the Company's findings at the time of its intervention only and within the limits of Client's instructions, if any. The Company's sole responsibility is to its Client and this document does not exonerate parties to a transaction from exercising all their rights and obligations under the transaction documents. This document cannot be reproduced except in full, without prior written approval of the Company. Any unauthorized alteration, forgery or falsification of the content or appearance of this document is unlawful and offenders may be prosecuted to the fullest extent of the law.

| | | | |
|----------------|------------------|--------------|------------------|
| Report Number | :ER-2021-20085 | Test Site | :SAC III Chamber |
| Operation Mode | :802.11ac80 | Test Date | :2021-03-15 |
| Test Frequency | :5775 MHz | Temp./Humi. | :22.4/61 |
| Test Mode | :Bandedge CH Low | Antenna Pol. | :HORIZONTAL |
| EUT Pol | :H Plane | Engineer | :Ricky |

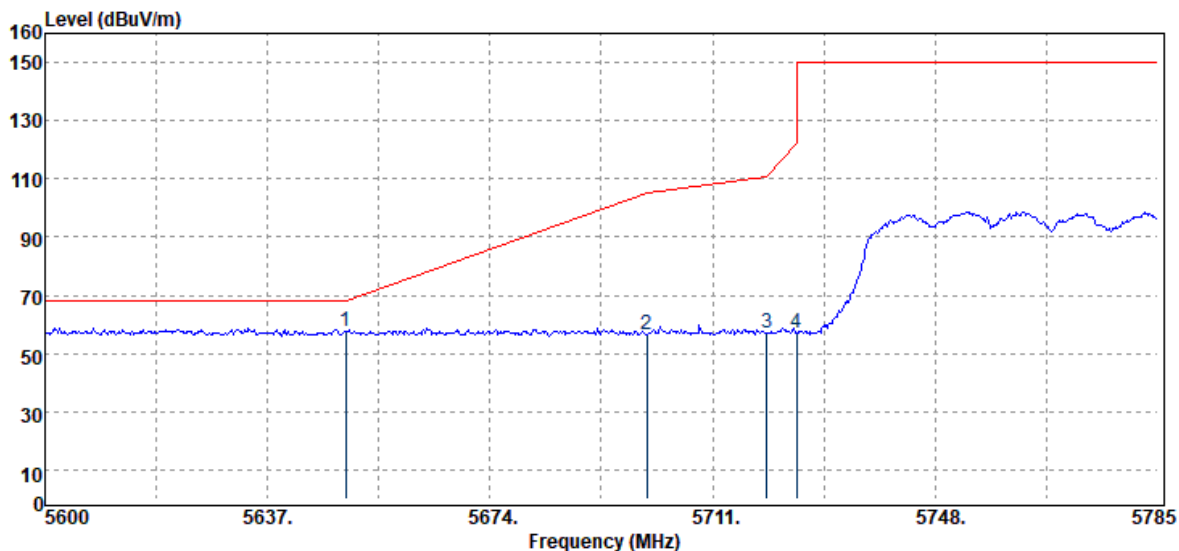

| Freq. MHz | Detector Mode PK/QP/AV | Spectrum Reading Level dB μ V | Factor dB | Actual FS dB μ V/m | Limit @3m dB μ V/m | Margin dB |
|--------------|------------------------------|---|--------------|------------------------------|------------------------------|--------------|
| 5650.00 | Peak | 49.63 | 8.08 | 57.71 | 68.20 | -10.49 |
| 5700.00 | Peak | 48.70 | 8.02 | 56.72 | 105.20 | -48.48 |
| 5720.00 | Peak | 49.01 | 8.10 | 57.11 | 110.80 | -53.69 |
| 5725.00 | Peak | 48.70 | 8.12 | 56.82 | 122.20 | -65.38 |

Unless otherwise stated the results shown in this test report refer only to the sample(s) tested and such sample(s) are retained for 90 days only.

除非另有說明，此報告結果僅對測試之樣品負責，同時此樣品僅保留90天。本報告未經本公司書面許可，不可部份複製。

This document is issued by the Company subject to its General Conditions of Service printed overleaf, available on request or accessible at <http://www.sgs.com.tw/Terms-and-Conditions> and for electronic format documents, subject to Terms and Conditions for Electronic Documents at <http://www.sgs.com.tw/Terms-and-Conditions>. Attention is drawn to the limitation of liability, indemnification and jurisdiction issues defined therein. Any holder of this document is advised that information contained hereon reflects the Company's findings at the time of its intervention only and within the limits of Client's instructions, if any. The Company's sole responsibility is to its Client and this document does not exonerate parties to a transaction from exercising all their rights and obligations under the transaction documents. This document cannot be reproduced except in full, without prior written approval of the Company. Any unauthorized alteration, forgery or falsification of the content or appearance of this document is unlawful and offenders may be prosecuted to the fullest extent of the law.

| | | | |
|----------------|------------------|--------------|------------------|
| Report Number | :ER-2021-20085 | Test Site | :SAC III Chamber |
| Operation Mode | :802.11ac80 | Test Date | :2021-03-15 |
| Test Frequency | :5775 MHz | Temp./Humi. | :22.4/61 |
| Test Mode | :Bandedge CH Low | Antenna Pol. | :VERTICAL |
| EUT Pol | :H Plane | Engineer | :Ricky |

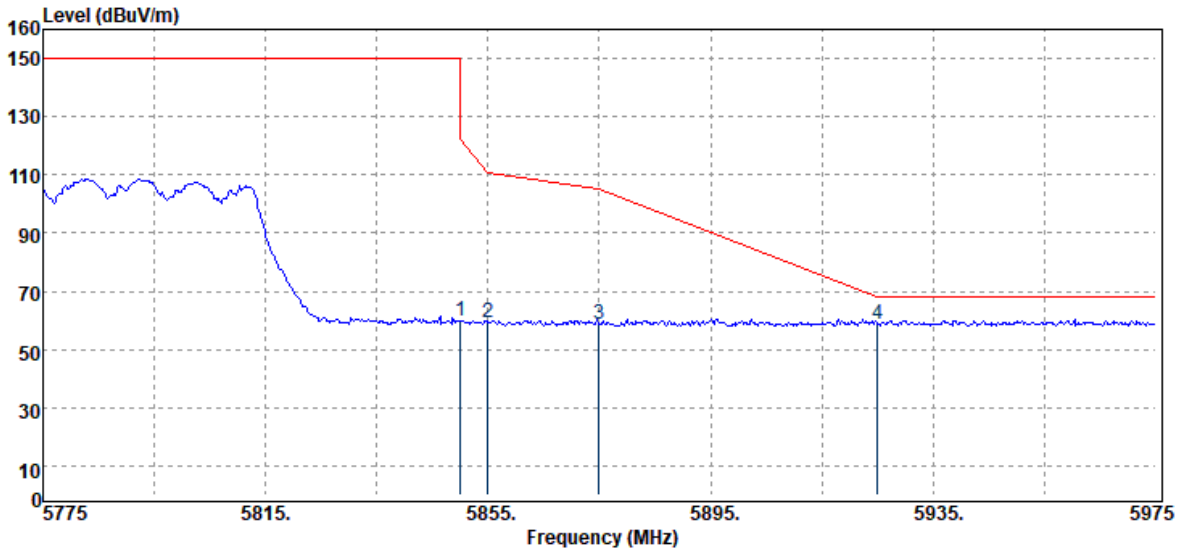

| Freq. MHz | Detector Mode PK/QP/AV | Spectrum Reading Level dB μ V | Factor dB | Actual FS dB μ V/m | Limit @3m dB μ V/m | Margin dB |
|--------------|------------------------------|---|--------------|------------------------------|------------------------------|--------------|
| 5850.00 | Peak | 50.90 | 9.02 | 59.92 | 122.20 | -62.28 |
| 5855.00 | Peak | 50.39 | 9.07 | 59.46 | 110.80 | -51.34 |
| 5875.00 | Peak | 49.18 | 9.27 | 58.45 | 105.20 | -46.75 |
| 5925.00 | Peak | 48.90 | 9.70 | 58.60 | 68.20 | -9.60 |

Unless otherwise stated the results shown in this test report refer only to the sample(s) tested and such sample(s) are retained for 90 days only.

除非另有說明，此報告結果僅對測試之樣品負責，同時此樣品僅保留90天。本報告未經本公司書面許可，不可部份複製。

This document is issued by the Company subject to its General Conditions of Service printed overleaf, available on request or accessible at <http://www.sgs.com.tw/Terms-and-Conditions> and for electronic format documents, subject to Terms and Conditions for Electronic Documents at <http://www.sgs.com.tw/Terms-and-Conditions>. Attention is drawn to the limitation of liability, indemnification and jurisdiction issues defined therein. Any holder of this document is advised that information contained hereon reflects the Company's findings at the time of its intervention only and within the limits of Client's instructions, if any. The Company's sole responsibility is to its Client and this document does not exonerate parties to a transaction from exercising all their rights and obligations under the transaction documents. This document cannot be reproduced except in full, without prior written approval of the Company. Any unauthorized alteration, forgery or falsification of the content or appearance of this document is unlawful and offenders may be prosecuted to the fullest extent of the law.

| | | | |
|----------------|------------------|--------------|------------------|
| Report Number | :ER-2021-20085 | Test Site | :SAC III Chamber |
| Operation Mode | :802.11ac80 | Test Date | :2021-03-15 |
| Test Frequency | :5775 MHz | Temp./Humi. | :22.4/61 |
| Test Mode | :Bandedge CH Low | Antenna Pol. | :HORIZONTAL |
| EUT Pol | :H Plane | Engineer | :Ricky |

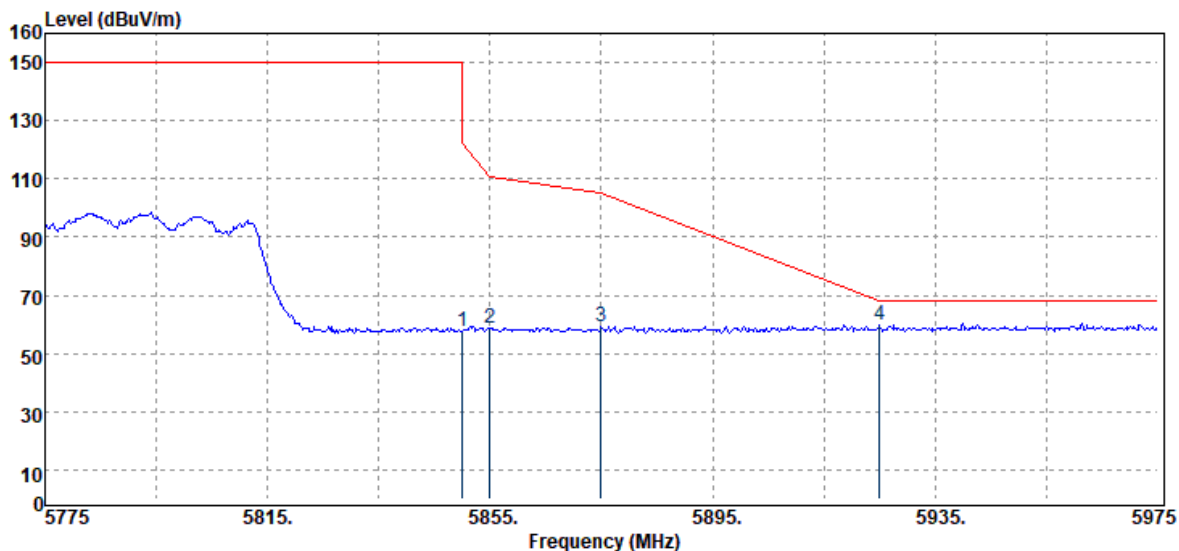

| Freq. MHz | Detector Mode PK/QP/AV | Spectrum Reading Level dB μ V | Factor dB | Actual FS dB μ V/m | Limit @3m dB μ V/m | Margin dB |
|--------------|------------------------------|---|--------------|------------------------------|------------------------------|--------------|
| 5850.00 | Peak | 48.76 | 9.02 | 57.78 | 122.20 | -64.42 |
| 5855.00 | Peak | 49.67 | 9.07 | 58.74 | 110.80 | -52.06 |
| 5875.00 | Peak | 49.71 | 9.27 | 58.98 | 105.20 | -46.22 |
| 5925.00 | Peak | 50.15 | 9.70 | 59.85 | 68.20 | -8.35 |

Unless otherwise stated the results shown in this test report refer only to the sample(s) tested and such sample(s) are retained for 90 days only.

除非另有說明，此報告結果僅對測試之樣品負責，同時此樣品僅保留90天。本報告未經本公司書面許可，不可部份複製。

This document is issued by the Company subject to its General Conditions of Service printed overleaf, available on request or accessible at <http://www.sgs.com.tw/Terms-and-Conditions> and for electronic format documents, subject to Terms and Conditions for Electronic Documents at <http://www.sgs.com.tw/Terms-and-Conditions>. Attention is drawn to the limitation of liability, indemnification and jurisdiction issues defined therein. Any holder of this document is advised that information contained hereon reflects the Company's findings at the time of its intervention only and within the limits of Client's instructions, if any. The Company's sole responsibility is to its Client and this document does not exonerate parties to a transaction from exercising all their rights and obligations under the transaction documents. This document cannot be reproduced except in full, without prior written approval of the Company. Any unauthorized alteration, forgery or falsification of the content or appearance of this document is unlawful and offenders may be prosecuted to the fullest extent of the law.

Report Number :ER-2021-20085
 Operation Mode :802.11ax20 RU full
 Test Frequency :5180 MHz
 Test Mode :Bandedge CH Low
 EUT Pol :H Plane

Test Site :SAC III Chamber
 Test Date :2021-03-16
 Temp./Humi. :22.7/63
 Antenna Pol. :VERTICAL
 Engineer :Ricky

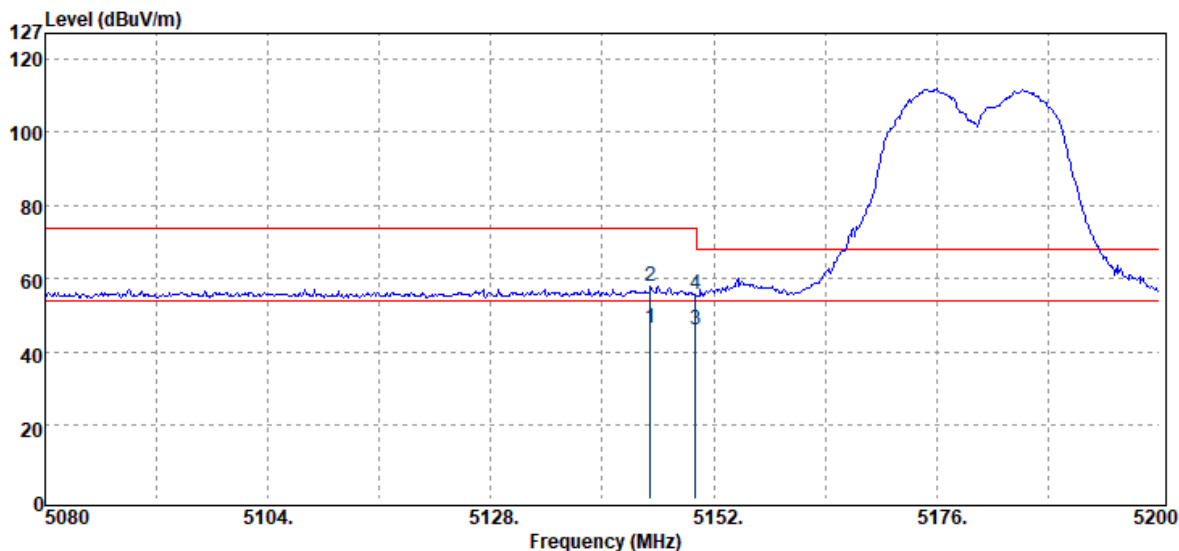

| Freq. MHz | Detector Mode PK/QP/AV | Spectrum Reading Level d μ V | Factor dB | Actual FS d μ V/m | Limit @3m d μ V/m | Margin dB |
|--------------|------------------------------|--|--------------|-----------------------------|-----------------------------|--------------|
| 5145.16 | Average | 38.08 | 8.54 | 46.62 | 54.00 | -7.38 |
| 5145.16 | Peak | 49.44 | 8.54 | 57.98 | 74.00 | -16.02 |
| 5150.00 | Average | 37.51 | 8.53 | 46.04 | 54.00 | -7.96 |
| 5150.00 | Peak | 47.19 | 8.53 | 55.72 | 74.00 | -18.28 |

Unless otherwise stated the results shown in this test report refer only to the sample(s) tested and such sample(s) are retained for 90 days only.

除非另有說明，此報告結果僅對測試之樣品負責，同時此樣品僅保留90天。本報告未經本公司書面許可，不可部份複製。

This document is issued by the Company subject to its General Conditions of Service printed overleaf, available on request or accessible at <http://www.sgs.com.tw/Terms-and-Conditions> and for electronic format documents, subject to Terms and Conditions for Electronic Documents at <http://www.sgs.com.tw/Terms-and-Conditions>. Attention is drawn to the limitation of liability, indemnification and jurisdiction issues defined therein. Any holder of this document is advised that information contained hereon reflects the Company's findings at the time of its intervention only and within the limits of Client's instructions, if any. The Company's sole responsibility is to its Client and this document does not exonerate parties to a transaction from exercising all their rights and obligations under the transaction documents. This document cannot be reproduced except in full, without prior written approval of the Company. Any unauthorized alteration, forgery or falsification of the content or appearance of this document is unlawful and offenders may be prosecuted to the fullest extent of the law.

Report Number :ER-2021-20085
 Operation Mode :802.11ax20 RU full
 Test Frequency :5180 MHz
 Test Mode :Bandedge CH Low
 EUT Pol :H Plane

Test Site :SAC III Chamber
 Test Date :2021-03-16
 Temp./Humi. :22.7/63
 Antenna Pol. :HORIZONTAL
 Engineer :Ricky

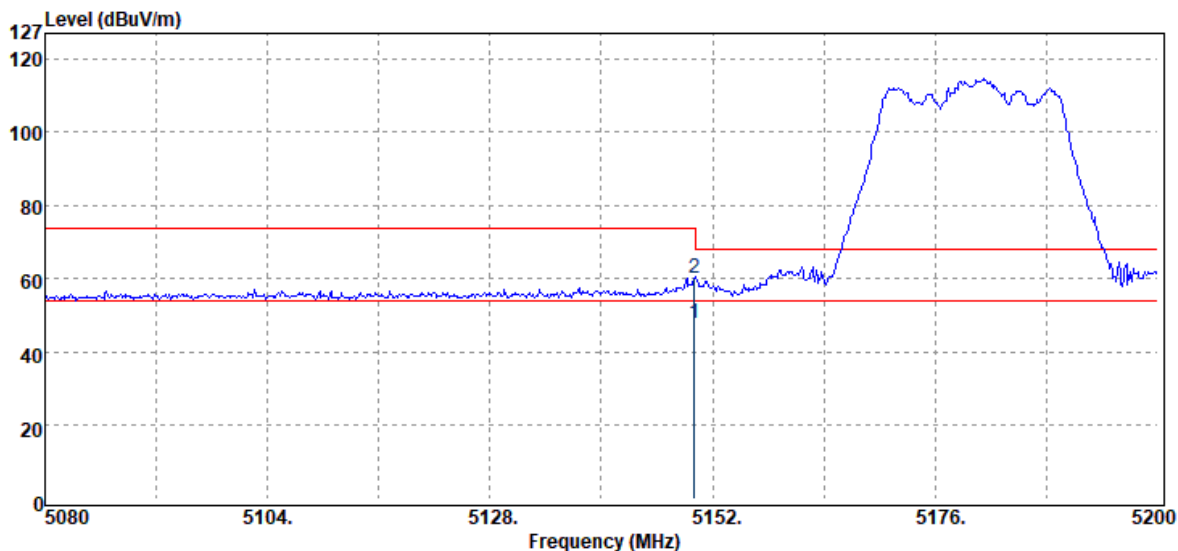

| Freq. MHz | Detector Mode PK/QP/AV | Spectrum Reading Level dB μ V | Factor dB | Actual FS dB μ V/m | Limit @3m dB μ V/m | Margin dB |
|--------------|------------------------------|---|--------------|------------------------------|------------------------------|--------------|
| 5150.00 | Average | 39.40 | 8.53 | 47.93 | 54.00 | -6.07 |
| 5150.00 | Peak | 51.71 | 8.53 | 60.24 | 74.00 | -13.76 |

Unless otherwise stated the results shown in this test report refer only to the sample(s) tested and such sample(s) are retained for 90 days only.

除非另有說明，此報告結果僅對測試之樣品負責，同時此樣品僅保留90天。本報告未經本公司書面許可，不可部份複製。

This document is issued by the Company subject to its General Conditions of Service printed overleaf, available on request or accessible at <http://www.sgs.com.tw/Terms-and-Conditions> and for electronic format documents, subject to Terms and Conditions for Electronic Documents at <http://www.sgs.com.tw/Terms-and-Conditions>. Attention is drawn to the limitation of liability, indemnification and jurisdiction issues defined therein. Any holder of this document is advised that information contained hereon reflects the Company's findings at the time of its intervention only and within the limits of Client's instructions, if any. The Company's sole responsibility is to its Client and this document does not exonerate parties to a transaction from exercising all their rights and obligations under the transaction documents. This document cannot be reproduced except in full, without prior written approval of the Company. Any unauthorized alteration, forgery or falsification of the content or appearance of this document is unlawful and offenders may be prosecuted to the fullest extent of the law.

Report Number :ER-2021-20085
 Operation Mode :802.11ax20 RU 26/0
 Test Frequency :5180 MHz
 Test Mode :Bandedge CH Low
 EUT Pol :H Plane

Test Site :SAC III Chamber
 Test Date :2021-03-16
 Temp./Humi. :22.7/63
 Antenna Pol. :VERTICAL
 Engineer :Ricky

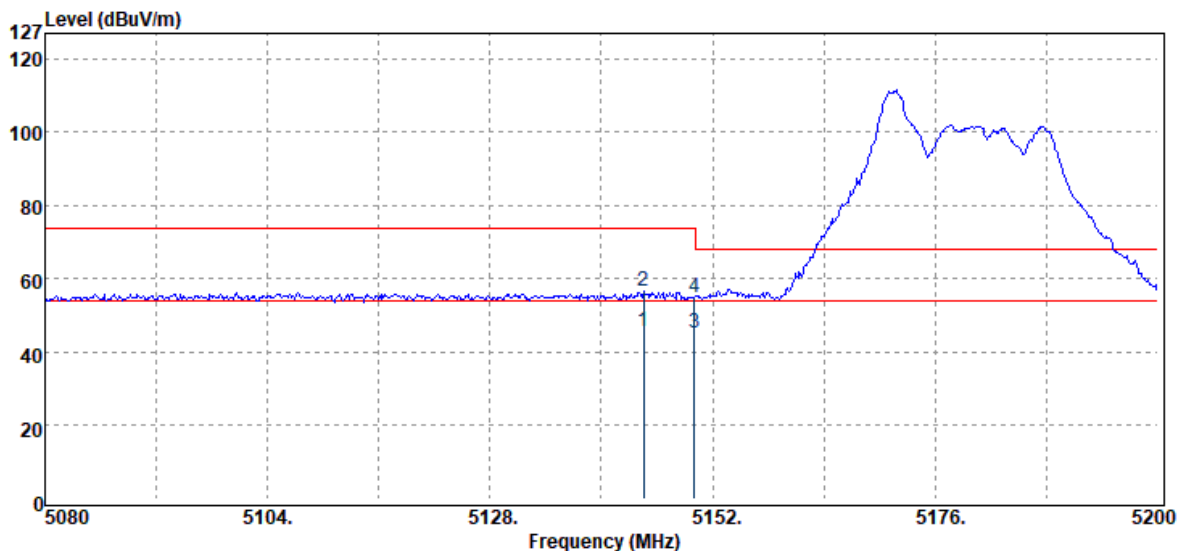

| Freq. MHz | Detector Mode PK/QP/AV | Spectrum Reading Level dB μ V | Factor dB | Actual FS dB μ V/m | Limit @3m dB μ V/m | Margin dB |
|--------------|------------------------------|---|--------------|------------------------------|------------------------------|--------------|
| 5144.56 | Average | 36.99 | 8.54 | 45.53 | 54.00 | -8.47 |
| 5144.56 | Peak | 48.00 | 8.54 | 56.54 | 74.00 | -17.46 |
| 5150.00 | Average | 36.89 | 8.53 | 45.42 | 54.00 | -8.58 |
| 5150.00 | Peak | 46.53 | 8.53 | 55.06 | 74.00 | -18.94 |

Unless otherwise stated the results shown in this test report refer only to the sample(s) tested and such sample(s) are retained for 90 days only.

除非另有說明，此報告結果僅對測試之樣品負責，同時此樣品僅保留90天。本報告未經本公司書面許可，不可部份複製。

This document is issued by the Company subject to its General Conditions of Service printed overleaf, available on request or accessible at <http://www.sgs.com.tw/Terms-and-Conditions> and for electronic format documents, subject to Terms and Conditions for Electronic Documents at <http://www.sgs.com.tw/Terms-and-Conditions>. Attention is drawn to the limitation of liability, indemnification and jurisdiction issues defined therein. Any holder of this document is advised that information contained hereon reflects the Company's findings at the time of its intervention only and within the limits of Client's instructions, if any. The Company's sole responsibility is to its Client and this document does not exonerate parties to a transaction from exercising all their rights and obligations under the transaction documents. This document cannot be reproduced except in full, without prior written approval of the Company. Any unauthorized alteration, forgery or falsification of the content or appearance of this document is unlawful and offenders may be prosecuted to the fullest extent of the law.

Report Number :ER-2021-20085
 Operation Mode :802.11ax20 RU 26/0
 Test Frequency :5180 MHz
 Test Mode :Bandedge CH Low
 EUT Pol :H Plane

Test Site :SAC III Chamber
 Test Date :2021-03-16
 Temp./Humi. :22.7/63
 Antenna Pol. :HORIZONTAL
 Engineer :Ricky

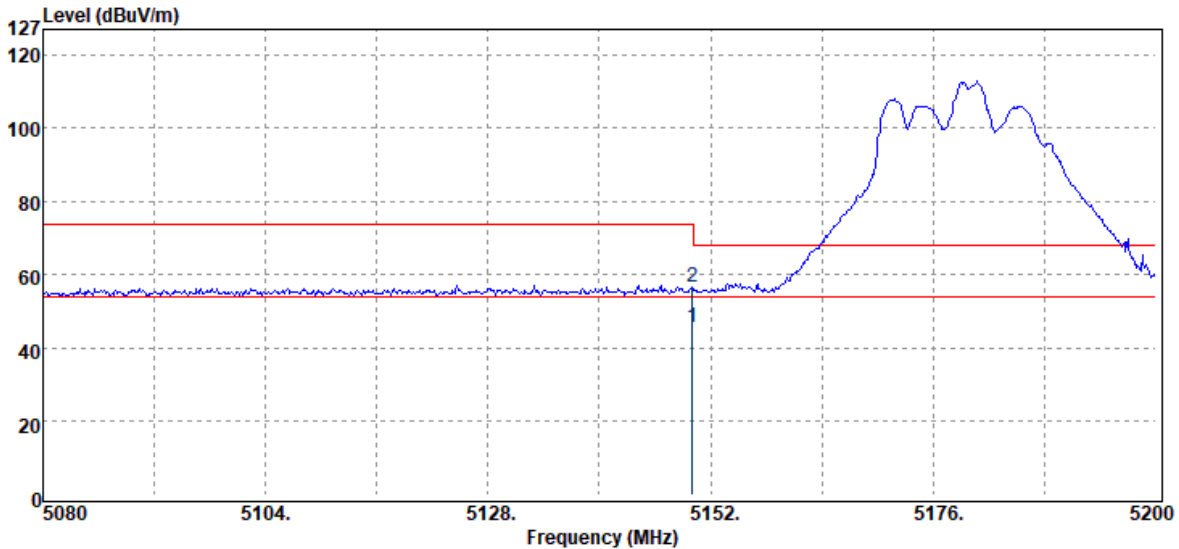

| Freq. MHz | Detector Mode PK/QP/AV | Spectrum Reading Level dB μ V | Factor dB | Actual FS dB μ V/m | Limit @3m dB μ V/m | Margin dB |
|--------------|------------------------------|---|--------------|------------------------------|------------------------------|--------------|
| 5150.00 | Average | 37.06 | 8.53 | 45.59 | 54.00 | -8.41 |
| 5150.00 | Peak | 48.31 | 8.53 | 56.84 | 74.00 | -17.16 |

Unless otherwise stated the results shown in this test report refer only to the sample(s) tested and such sample(s) are retained for 90 days only.

除非另有說明，此報告結果僅對測試之樣品負責，同時此樣品僅保留90天。本報告未經本公司書面許可，不可部份複製。

This document is issued by the Company subject to its General Conditions of Service printed overleaf, available on request or accessible at <http://www.sgs.com.tw/Terms-and-Conditions> and for electronic format documents, subject to Terms and Conditions for Electronic Documents at <http://www.sgs.com.tw/Terms-and-Conditions>. Attention is drawn to the limitation of liability, indemnification and jurisdiction issues defined therein. Any holder of this document is advised that information contained hereon reflects the Company's findings at the time of its intervention only and within the limits of Client's instructions, if any. The Company's sole responsibility is to its Client and this document does not exonerate parties to a transaction from exercising all their rights and obligations under the transaction documents. This document cannot be reproduced except in full, without prior written approval of the Company. Any unauthorized alteration, forgery or falsification of the content or appearance of this document is unlawful and offenders may be prosecuted to the fullest extent of the law.

| | | | |
|----------------|----------------------|--------------|------------------|
| Report Number | :ER-2021-20085 | Test Site | :SAC III Chamber |
| Operation Mode | :802.11ax20 RU 52/37 | Test Date | :2021-03-16 |
| Test Frequency | :5180 MHz | Temp./Humi. | :22.7/63 |
| Test Mode | :Bandedge CH Low | Antenna Pol. | :VERTICAL |
| EUT Pol | :H Plane | Engineer | :Ricky |

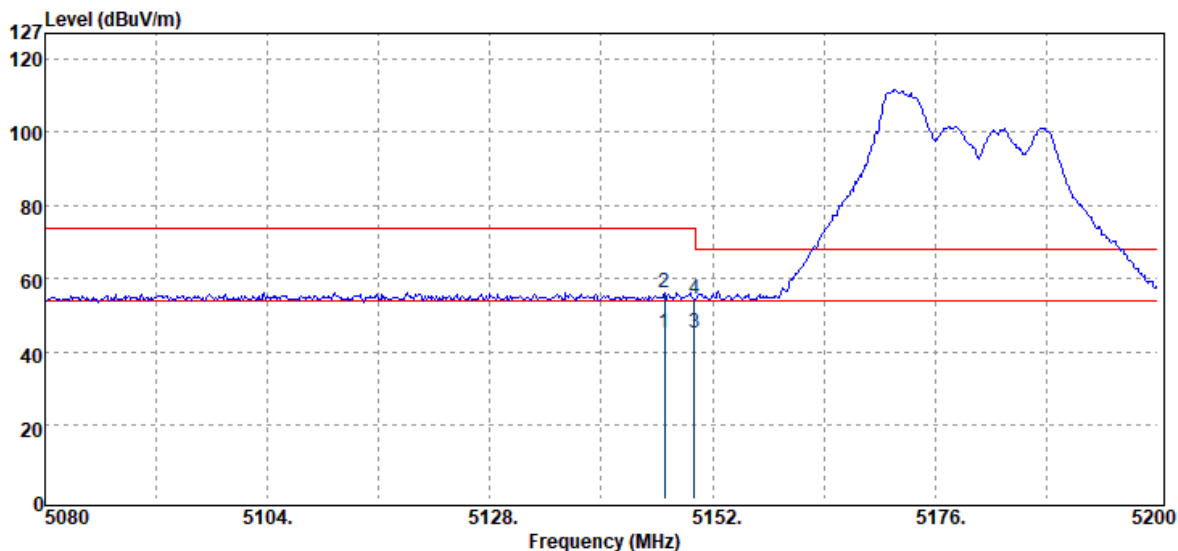

| Freq. MHz | Detector Mode PK/QP/AV | Spectrum Reading Level dB μ V | Factor dB | Actual FS dB μ V/m | Limit @3m dB μ V/m | Margin dB |
|--------------|------------------------------|---|--------------|------------------------------|------------------------------|--------------|
| 5146.84 | Average | 36.92 | 8.53 | 45.45 | 54.00 | -8.55 |
| 5146.84 | Peak | 47.77 | 8.53 | 56.30 | 74.00 | -17.70 |
| 5150.00 | Average | 36.88 | 8.53 | 45.41 | 54.00 | -8.59 |
| 5150.00 | Peak | 46.11 | 8.53 | 54.64 | 74.00 | -19.36 |

Unless otherwise stated the results shown in this test report refer only to the sample(s) tested and such sample(s) are retained for 90 days only.

除非另有說明，此報告結果僅對測試之樣品負責，同時此樣品僅保留90天。本報告未經本公司書面許可，不可部份複製。

This document is issued by the Company subject to its General Conditions of Service printed overleaf, available on request or accessible at <http://www.sgs.com.tw/Terms-and-Conditions> and for electronic format documents, subject to Terms and Conditions for Electronic Documents at <http://www.sgs.com.tw/Terms-and-Conditions>. Attention is drawn to the limitation of liability, indemnification and jurisdiction issues defined therein. Any holder of this document is advised that information contained hereon reflects the Company's findings at the time of its intervention only and within the limits of Client's instructions, if any. The Company's sole responsibility is to its Client and this document does not exonerate parties to a transaction from exercising all their rights and obligations under the transaction documents. This document cannot be reproduced except in full, without prior written approval of the Company. Any unauthorized alteration, forgery or falsification of the content or appearance of this document is unlawful and offenders may be prosecuted to the fullest extent of the law.

| | | | |
|----------------|----------------------|--------------|------------------|
| Report Number | :ER-2021-20085 | Test Site | :SAC III Chamber |
| Operation Mode | :802.11ax20 RU 52/37 | Test Date | :2021-03-16 |
| Test Frequency | :5180 MHz | Temp./Humi. | :22.7/63 |
| Test Mode | :Bandedge CH Low | Antenna Pol. | :HORIZONTAL |
| EUT Pol | :H Plane | Engineer | :Ricky |

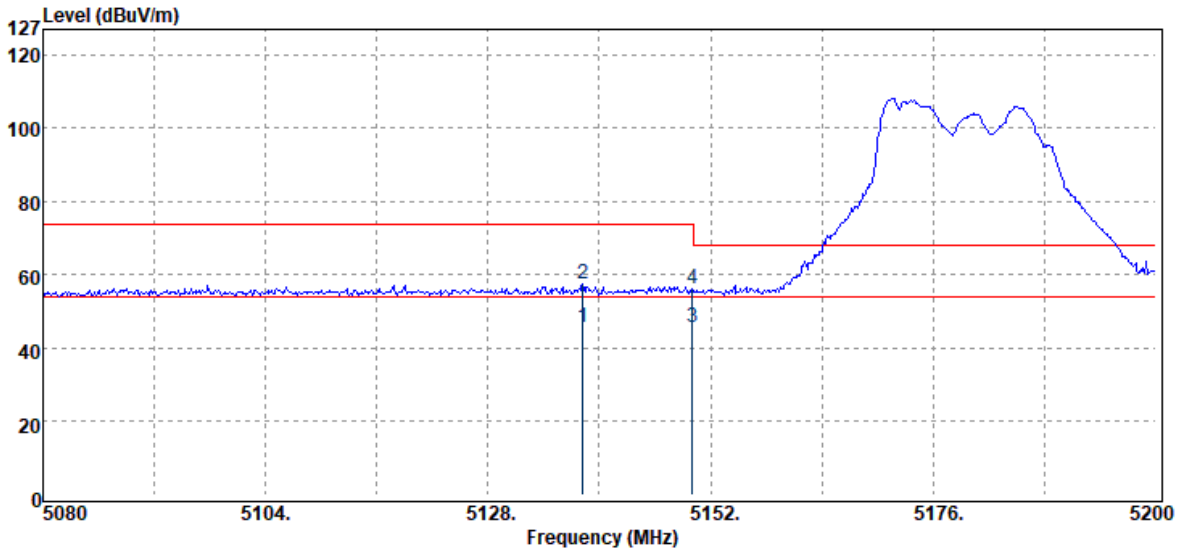

| Freq. MHz | Detector Mode PK/QP/AV | Spectrum Reading Level dB μ V | Factor dB | Actual FS dB μ V/m | Limit @3m dB μ V/m | Margin dB |
|--------------|------------------------------|---|--------------|------------------------------|------------------------------|--------------|
| 5138.20 | Average | 37.23 | 8.54 | 45.77 | 54.00 | -8.23 |
| 5138.20 | Peak | 48.81 | 8.54 | 57.35 | 74.00 | -16.65 |
| 5150.00 | Average | 37.24 | 8.53 | 45.77 | 54.00 | -8.23 |
| 5150.00 | Peak | 47.91 | 8.53 | 56.44 | 74.00 | -17.56 |

Unless otherwise stated the results shown in this test report refer only to the sample(s) tested and such sample(s) are retained for 90 days only.

除非另有說明，此報告結果僅對測試之樣品負責，同時此樣品僅保留90天。本報告未經本公司書面許可，不可部份複製。

This document is issued by the Company subject to its General Conditions of Service printed overleaf, available on request or accessible at <http://www.sgs.com.tw/Terms-and-Conditions> and for electronic format documents, subject to Terms and Conditions for Electronic Documents at <http://www.sgs.com.tw/Terms-and-Conditions>. Attention is drawn to the limitation of liability, indemnification and jurisdiction issues defined therein. Any holder of this document is advised that information contained hereon reflects the Company's findings at the time of its intervention only and within the limits of Client's instructions, if any. The Company's sole responsibility is to its Client and this document does not exonerate parties to a transaction from exercising all their rights and obligations under the transaction documents. This document cannot be reproduced except in full, without prior written approval of the Company. Any unauthorized alteration, forgery or falsification of the content or appearance of this document is unlawful and offenders may be prosecuted to the fullest extent of the law.

Report Number :ER-2021-20085
 Operation Mode :802.11ax20 RU 106.53
 Test Frequency :5180 MHz
 Test Mode :Bandedge CH Low
 EUT Pol :H Plane

Test Site :SAC III Chamber
 Test Date :2021-03-16
 Temp./Humi. :22.7/63
 Antenna Pol. :VERTICAL
 Engineer :Ricky

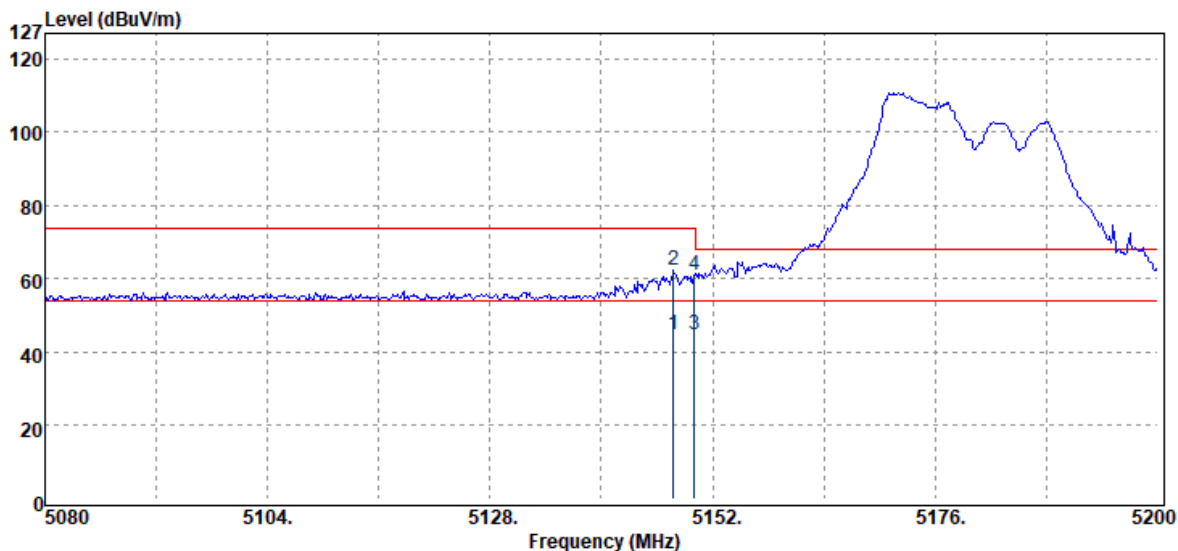

| Freq. MHz | Detector Mode PK/QP/AV | Spectrum Reading Level dB μ V | Factor dB | Actual FS dB μ V/m | Limit @3m dB μ V/m | Margin dB |
|--------------|------------------------------|---|--------------|------------------------------|------------------------------|--------------|
| 5147.80 | Average | 36.49 | 8.53 | 45.02 | 54.00 | -8.98 |
| 5147.80 | Peak | 53.69 | 8.53 | 62.22 | 74.00 | -11.78 |
| 5150.00 | Average | 36.45 | 8.53 | 44.98 | 54.00 | -9.02 |
| 5150.00 | Peak | 52.35 | 8.53 | 60.88 | 74.00 | -13.12 |

Unless otherwise stated the results shown in this test report refer only to the sample(s) tested and such sample(s) are retained for 90 days only.

除非另有說明，此報告結果僅對測試之樣品負責，同時此樣品僅保留90天。本報告未經本公司書面許可，不可部份複製。

This document is issued by the Company subject to its General Conditions of Service printed overleaf, available on request or accessible at <http://www.sgs.com.tw/Terms-and-Conditions> and for electronic format documents, subject to Terms and Conditions for Electronic Documents at <http://www.sgs.com.tw/Terms-and-Conditions>. Attention is drawn to the limitation of liability, indemnification and jurisdiction issues defined therein. Any holder of this document is advised that information contained hereon reflects the Company's findings at the time of its intervention only and within the limits of Client's instructions, if any. The Company's sole responsibility is to its Client and this document does not exonerate parties to a transaction from exercising all their rights and obligations under the transaction documents. This document cannot be reproduced except in full, without prior written approval of the Company. Any unauthorized alteration, forgery or falsification of the content or appearance of this document is unlawful and offenders may be prosecuted to the fullest extent of the law.

Report Number :ER-2021-20085
 Operation Mode :802.11ax20 RU 106.53
 Test Frequency :5180 MHz
 Test Mode :Bandedge CH Low
 EUT Pol :H Plane

Test Site :SAC III Chamber
 Test Date :2021-03-16
 Temp./Humi. :22.7/63
 Antenna Pol. :HORIZONTAL
 Engineer :Ricky

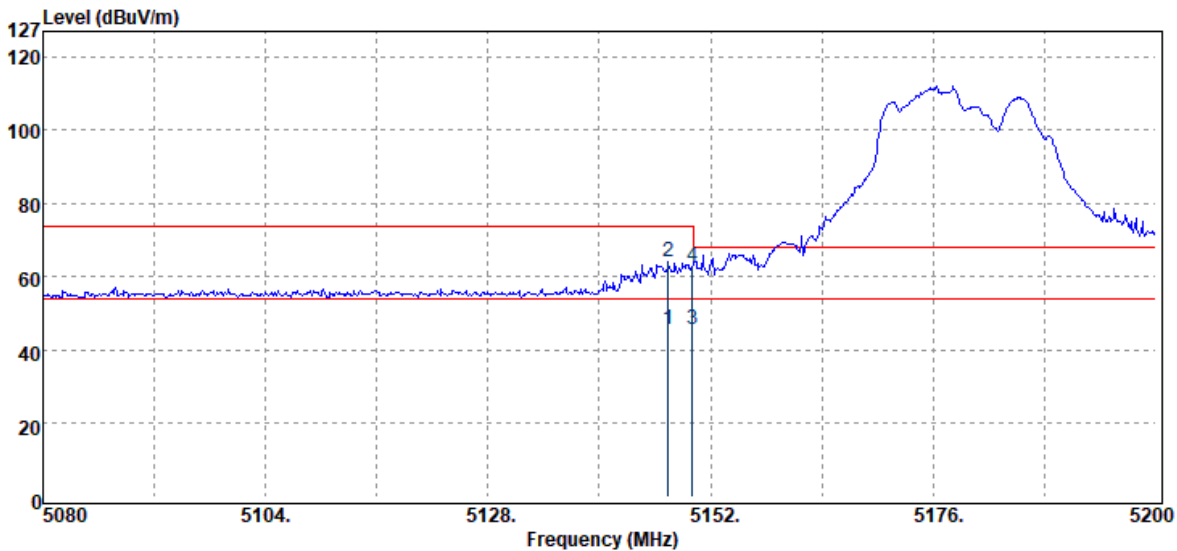

| Freq. MHz | Detector Mode PK/QP/AV | Spectrum Reading Level dB μ V | Factor dB | Actual FS dB μ V/m | Limit @3m dB μ V/m | Margin dB |
|--------------|------------------------------|---|--------------|------------------------------|------------------------------|--------------|
| 5147.44 | Average | 37.14 | 8.54 | 45.68 | 54.00 | -8.32 |
| 5147.44 | Peak | 55.78 | 8.54 | 64.32 | 74.00 | -9.68 |
| 5150.00 | Average | 37.22 | 8.53 | 45.75 | 54.00 | -8.25 |
| 5150.00 | Peak | 54.25 | 8.53 | 62.78 | 74.00 | -11.22 |

Unless otherwise stated the results shown in this test report refer only to the sample(s) tested and such sample(s) are retained for 90 days only.

除非另有說明，此報告結果僅對測試之樣品負責，同時此樣品僅保留90天。本報告未經本公司書面許可，不可部份複製。

This document is issued by the Company subject to its General Conditions of Service printed overleaf, available on request or accessible at <http://www.sgs.com.tw/Terms-and-Conditions> and for electronic format documents, subject to Terms and Conditions for Electronic Documents at <http://www.sgs.com.tw/Terms-and-Conditions>. Attention is drawn to the limitation of liability, indemnification and jurisdiction issues defined therein. Any holder of this document is advised that information contained hereon reflects the Company's findings at the time of its intervention only and within the limits of Client's instructions, if any. The Company's sole responsibility is to its Client and this document does not exonerate parties to a transaction from exercising all their rights and obligations under the transaction documents. This document cannot be reproduced except in full, without prior written approval of the Company. Any unauthorized alteration, forgery or falsification of the content or appearance of this document is unlawful and offenders may be prosecuted to the fullest extent of the law.

| | | | |
|----------------|---------------------|--------------|------------------|
| Report Number | :ER-2021-20085 | Test Site | :SAC III Chamber |
| Operation Mode | :802.11ax20 RU full | Test Date | :2021-03-16 |
| Test Frequency | :5320 MHz | Temp./Humi. | :22.7/63 |
| Test Mode | :Bandedge CH High | Antenna Pol. | :VERTICAL |
| EUT Pol | :H Plane | Engineer | :Ricky |

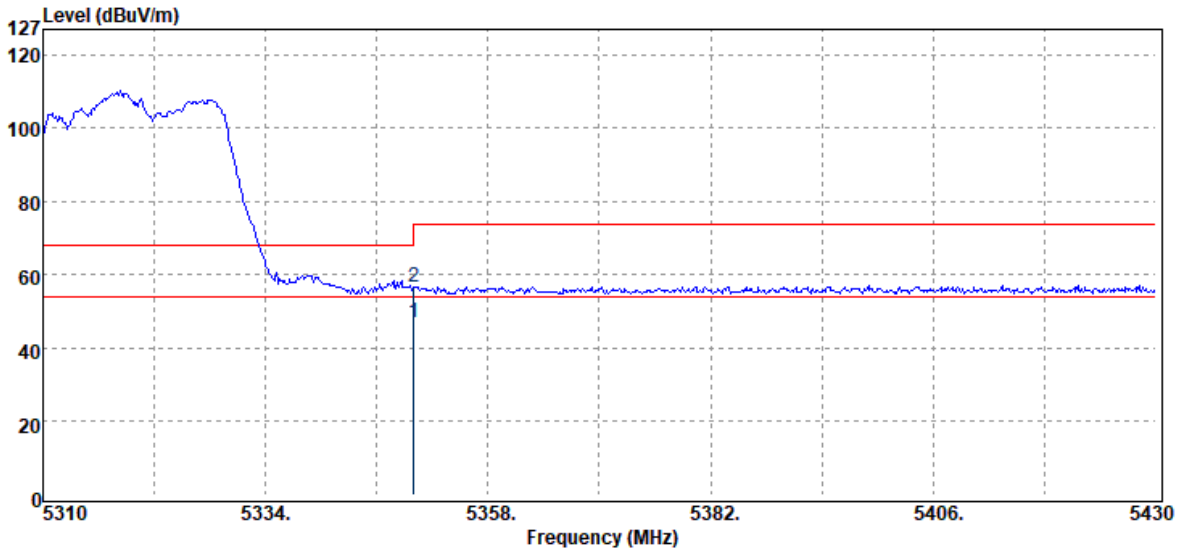

| Freq. MHz | Detector Mode PK/QP/AV | Spectrum Reading Level dBUV | Factor dB | Actual FS dBUV/m | Limit @3m dBUV/m | Margin dB |
|--------------|------------------------------|-----------------------------------|--------------|------------------------|------------------------|--------------|
| 5350.00 | Average | 38.38 | 8.77 | 47.15 | 54.00 | -6.85 |
| 5350.00 | Peak | 47.92 | 8.77 | 56.69 | 74.00 | -17.31 |

Unless otherwise stated the results shown in this test report refer only to the sample(s) tested and such sample(s) are retained for 90 days only.

除非另有說明，此報告結果僅對測試之樣品負責，同時此樣品僅保留90天。本報告未經本公司書面許可，不可部份複製。

This document is issued by the Company subject to its General Conditions of Service printed overleaf, available on request or accessible at <http://www.sgs.com.tw/Terms-and-Conditions> and for electronic format documents, subject to Terms and Conditions for Electronic Documents at <http://www.sgs.com.tw/Terms-and-Conditions>. Attention is drawn to the limitation of liability, indemnification and jurisdiction issues defined therein. Any holder of this document is advised that information contained hereon reflects the Company's findings at the time of its intervention only and within the limits of Client's instructions, if any. The Company's sole responsibility is to its Client and this document does not exonerate parties to a transaction from exercising all their rights and obligations under the transaction documents. This document cannot be reproduced except in full, without prior written approval of the Company. Any unauthorized alteration, forgery or falsification of the content or appearance of this document is unlawful and offenders may be prosecuted to the fullest extent of the law.

| | | | |
|----------------|---------------------|--------------|------------------|
| Report Number | :ER-2021-20085 | Test Site | :SAC III Chamber |
| Operation Mode | :802.11ax20 RU full | Test Date | :2021-03-16 |
| Test Frequency | :5320 MHz | Temp./Humi. | :22.7/63 |
| Test Mode | :Bandedge CH High | Antenna Pol. | :HORIZONTAL |
| EUT Pol | :H Plane | Engineer | :Ricky |

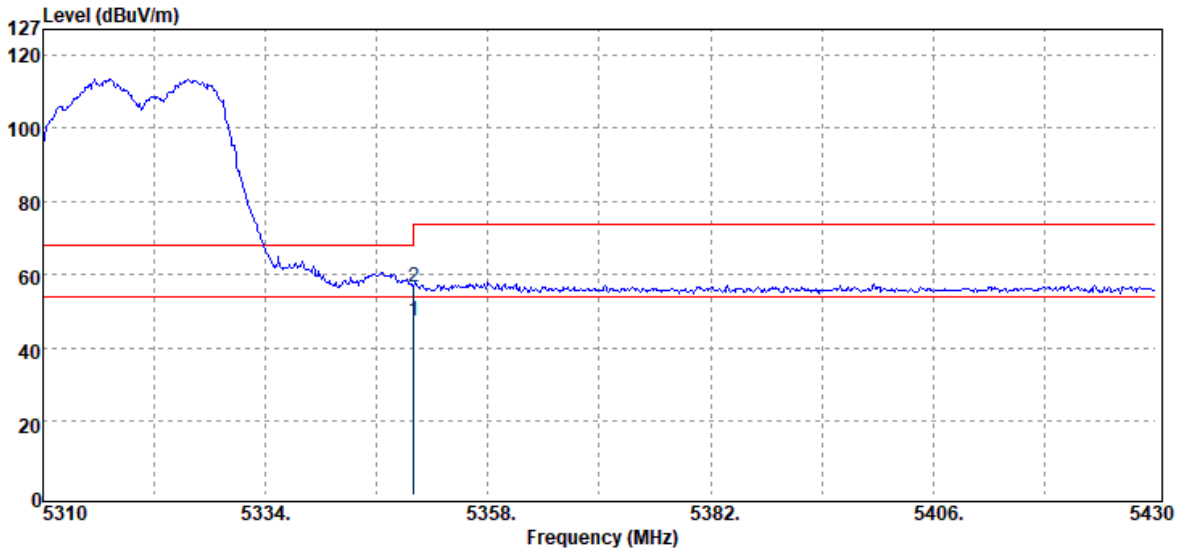

| Freq. MHz | Detector Mode PK/QP/AV | Spectrum Reading Level dBUV | Factor dB | Actual FS dBUV/m | Limit @3m dBUV/m | Margin dB |
|--------------|------------------------------|-----------------------------------|--------------|------------------------|------------------------|--------------|
| 5350.00 | Average | 38.57 | 8.77 | 47.34 | 54.00 | -6.66 |
| 5350.00 | Peak | 48.11 | 8.77 | 56.88 | 74.00 | -17.12 |

Unless otherwise stated the results shown in this test report refer only to the sample(s) tested and such sample(s) are retained for 90 days only.

除非另有說明，此報告結果僅對測試之樣品負責，同時此樣品僅保留90天。本報告未經本公司書面許可，不可部份複製。

This document is issued by the Company subject to its General Conditions of Service printed overleaf, available on request or accessible at <http://www.sgs.com.tw/Terms-and-Conditions> and for electronic format documents, subject to Terms and Conditions for Electronic Documents at <http://www.sgs.com.tw/Terms-and-Conditions>. Attention is drawn to the limitation of liability, indemnification and jurisdiction issues defined therein. Any holder of this document is advised that information contained hereon reflects the Company's findings at the time of its intervention only and within the limits of Client's instructions, if any. The Company's sole responsibility is to its Client and this document does not exonerate parties to a transaction from exercising all their rights and obligations under the transaction documents. This document cannot be reproduced except in full, without prior written approval of the Company. Any unauthorized alteration, forgery or falsification of the content or appearance of this document is unlawful and offenders may be prosecuted to the fullest extent of the law.

| | | | |
|----------------|---------------------|--------------|------------------|
| Report Number | :ER-2021-20085 | Test Site | :SAC III Chamber |
| Operation Mode | :802.11ax20 RU 26/8 | Test Date | :2021-03-16 |
| Test Frequency | :5320 MHz | Temp./Humi. | :22.7/63 |
| Test Mode | :Bandedge CH High | Antenna Pol. | :VERTICAL |
| EUT Pol | :H Plane | Engineer | :Ricky |

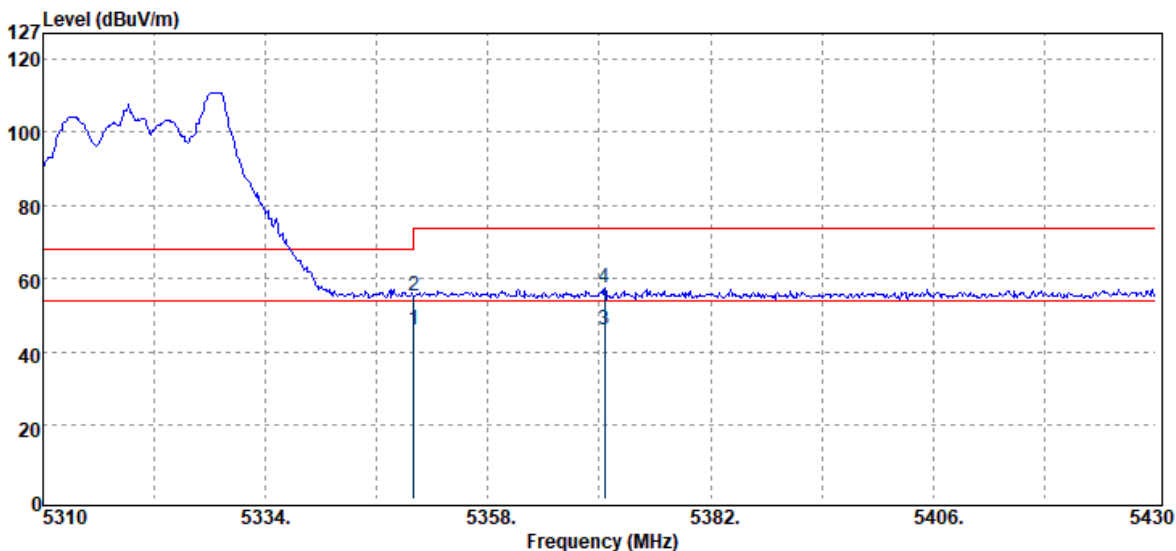

| Freq. MHz | Detector Mode PK/QP/AV | Spectrum Reading Level dB μ V | Factor dB | Actual FS dB μ V/m | Limit @3m dB μ V/m | Margin dB |
|--------------|------------------------------|---|--------------|------------------------------|------------------------------|--------------|
| 5350.00 | Average | 37.40 | 8.77 | 46.17 | 54.00 | -7.83 |
| 5350.00 | Peak | 46.64 | 8.77 | 55.41 | 74.00 | -18.59 |
| 5370.60 | Average | 37.09 | 9.03 | 46.12 | 54.00 | -7.88 |
| 5370.60 | Peak | 48.50 | 9.03 | 57.53 | 74.00 | -16.47 |

Unless otherwise stated the results shown in this test report refer only to the sample(s) tested and such sample(s) are retained for 90 days only.

除非另有說明，此報告結果僅對測試之樣品負責，同時此樣品僅保留90天。本報告未經本公司書面許可，不可部份複製。

This document is issued by the Company subject to its General Conditions of Service printed overleaf, available on request or accessible at <http://www.sgs.com.tw/Terms-and-Conditions> and for electronic format documents, subject to Terms and Conditions for Electronic Documents at <http://www.sgs.com.tw/Terms-and-Conditions>. Attention is drawn to the limitation of liability, indemnification and jurisdiction issues defined therein. Any holder of this document is advised that information contained hereon reflects the Company's findings at the time of its intervention only and within the limits of Client's instructions, if any. The Company's sole responsibility is to its Client and this document does not exonerate parties to a transaction from exercising all their rights and obligations under the transaction documents. This document cannot be reproduced except in full, without prior written approval of the Company. Any unauthorized alteration, forgery or falsification of the content or appearance of this document is unlawful and offenders may be prosecuted to the fullest extent of the law.

| | | | |
|----------------|---------------------|--------------|------------------|
| Report Number | :ER-2021-20085 | Test Site | :SAC III Chamber |
| Operation Mode | :802.11ax20 RU 26/8 | Test Date | :2021-03-16 |
| Test Frequency | :5320 MHz | Temp./Humi. | :22.7/63 |
| Test Mode | :Bandedge CH High | Antenna Pol. | :HORIZONTAL |
| EUT Pol | :H Plane | Engineer | :Ricky |

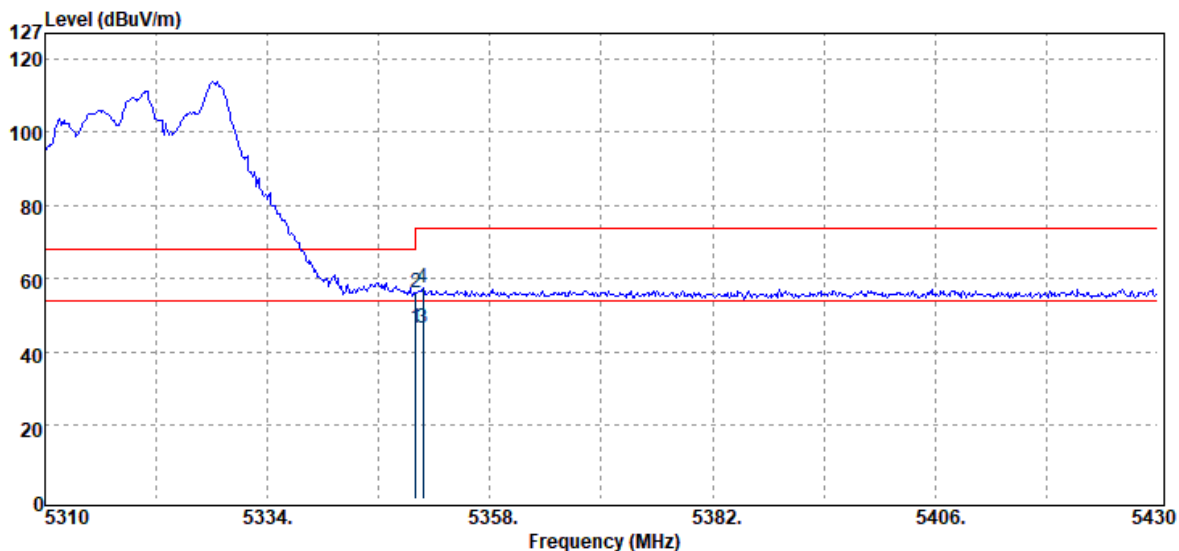

| Freq. MHz | Detector Mode PK/QP/AV | Spectrum Reading Level dB μ V | Factor dB | Actual FS dB μ V/m | Limit @3m dB μ V/m | Margin dB |
|--------------|------------------------------|---|--------------|------------------------------|------------------------------|--------------|
| 5350.00 | Average | 37.71 | 8.77 | 46.48 | 54.00 | -7.52 |
| 5350.00 | Peak | 47.30 | 8.77 | 56.07 | 74.00 | -17.93 |
| 5350.80 | Average | 37.78 | 8.76 | 46.54 | 54.00 | -7.46 |
| 5350.80 | Peak | 48.94 | 8.76 | 57.70 | 74.00 | -16.30 |

Unless otherwise stated the results shown in this test report refer only to the sample(s) tested and such sample(s) are retained for 90 days only.

除非另有說明，此報告結果僅對測試之樣品負責，同時此樣品僅保留90天。本報告未經本公司書面許可，不可部份複製。

This document is issued by the Company subject to its General Conditions of Service printed overleaf, available on request or accessible at <http://www.sgs.com.tw/Terms-and-Conditions> and for electronic format documents, subject to Terms and Conditions for Electronic Documents at <http://www.sgs.com.tw/Terms-and-Conditions>. Attention is drawn to the limitation of liability, indemnification and jurisdiction issues defined therein. Any holder of this document is advised that information contained hereon reflects the Company's findings at the time of its intervention only and within the limits of Client's instructions, if any. The Company's sole responsibility is to its Client and this document does not exonerate parties to a transaction from exercising all their rights and obligations under the transaction documents. This document cannot be reproduced except in full, without prior written approval of the Company. Any unauthorized alteration, forgery or falsification of the content or appearance of this document is unlawful and offenders may be prosecuted to the fullest extent of the law.

| | | | |
|----------------|----------------------|--------------|------------------|
| Report Number | :ER-2021-20085 | Test Site | :SAC III Chamber |
| Operation Mode | :802.11ax20 RU 52/40 | Test Date | :2021-03-16 |
| Test Frequency | :5320 MHz | Temp./Humi. | :22.7/63 |
| Test Mode | :Bandedge CH High | Antenna Pol. | :VERTICAL |
| EUT Pol | :H Plane | Engineer | :Ricky |

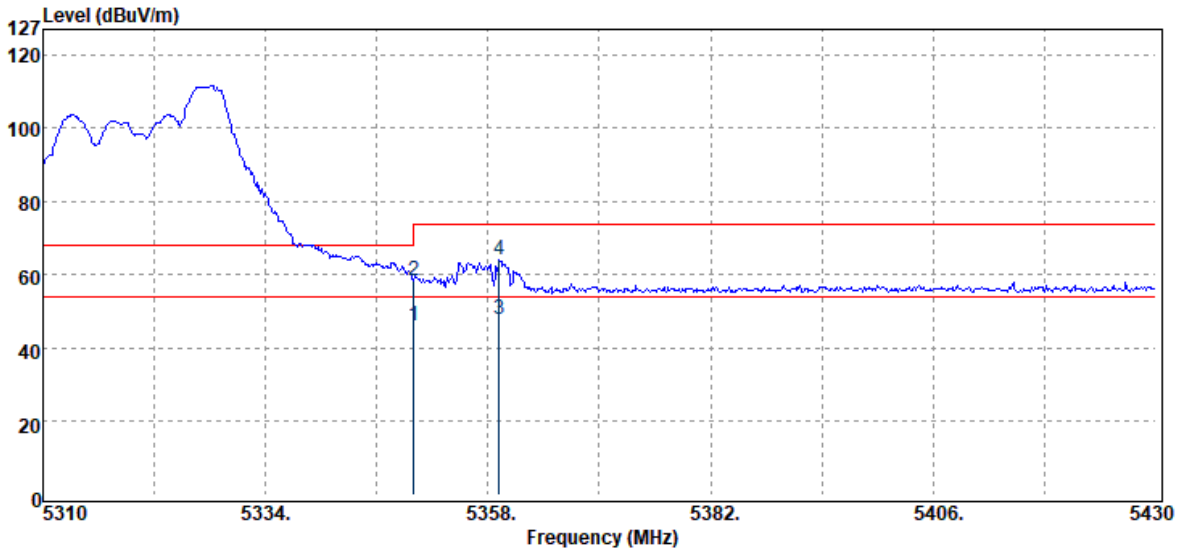

| Freq. MHz | Detector Mode PK/QP/AV | Spectrum Reading Level dB μ V | Factor dB | Actual FS dB μ V/m | Limit @3m dB μ V/m | Margin dB |
|--------------|------------------------------|---|--------------|------------------------------|------------------------------|--------------|
| 5350.00 | Average | 37.20 | 8.77 | 45.97 | 54.00 | -8.03 |
| 5350.00 | Peak | 49.74 | 8.77 | 58.51 | 74.00 | -15.49 |
| 5359.20 | Average | 39.08 | 8.89 | 47.97 | 54.00 | -6.03 |
| 5359.20 | Peak | 55.11 | 8.89 | 64.00 | 74.00 | -10.00 |

Unless otherwise stated the results shown in this test report refer only to the sample(s) tested and such sample(s) are retained for 90 days only.

除非另有說明，此報告結果僅對測試之樣品負責，同時此樣品僅保留90天。本報告未經本公司書面許可，不可部份複製。

This document is issued by the Company subject to its General Conditions of Service printed overleaf, available on request or accessible at <http://www.sgs.com.tw/Terms-and-Conditions> and for electronic format documents, subject to Terms and Conditions for Electronic Documents at <http://www.sgs.com.tw/Terms-and-Conditions>. Attention is drawn to the limitation of liability, indemnification and jurisdiction issues defined therein. Any holder of this document is advised that information contained hereon reflects the Company's findings at the time of its intervention only and within the limits of Client's instructions, if any. The Company's sole responsibility is to its Client and this document does not exonerate parties to a transaction from exercising all their rights and obligations under the transaction documents. This document cannot be reproduced except in full, without prior written approval of the Company. Any unauthorized alteration, forgery or falsification of the content or appearance of this document is unlawful and offenders may be prosecuted to the fullest extent of the law.

| | | | |
|----------------|----------------------|--------------|------------------|
| Report Number | :ER-2021-20085 | Test Site | :SAC III Chamber |
| Operation Mode | :802.11ax20 RU 52/40 | Test Date | :2021-03-16 |
| Test Frequency | :5320 MHz | Temp./Humi. | :22.7/63 |
| Test Mode | :Bandedge CH High | Antenna Pol. | :HORIZONTAL |
| EUT Pol | :H Plane | Engineer | :Ricky |

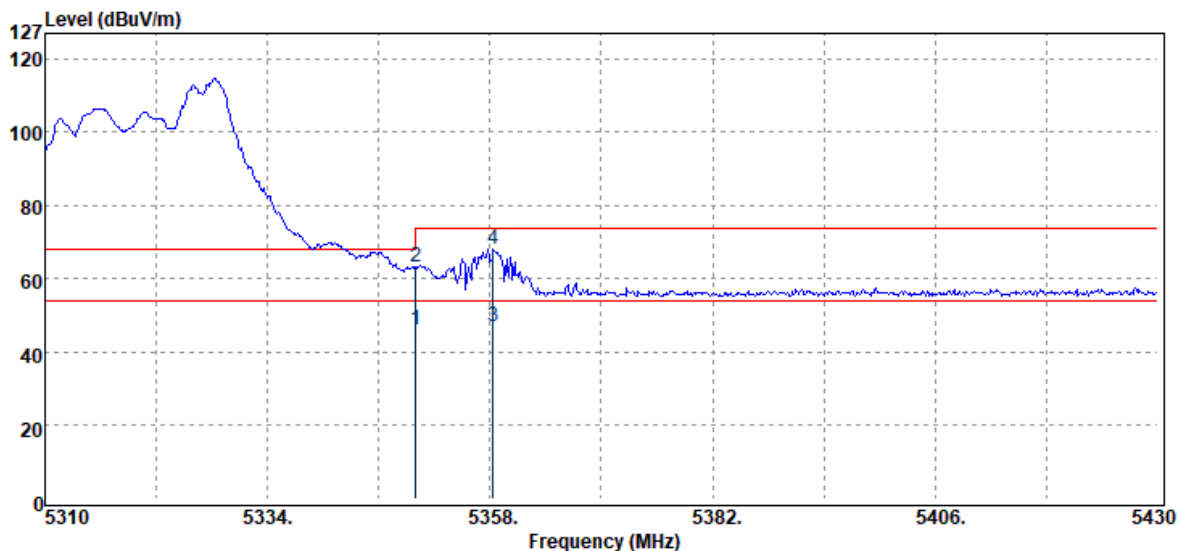

| Freq. MHz | Detector Mode PK/QP/AV | Spectrum Reading Level dB μ V | Factor dB | Actual FS dB μ V/m | Limit @3m dB μ V/m | Margin dB |
|--------------|------------------------------|---|--------------|------------------------------|------------------------------|--------------|
| 5350.00 | Average | 37.45 | 8.77 | 46.22 | 54.00 | -7.78 |
| 5350.00 | Peak | 54.65 | 8.77 | 63.42 | 74.00 | -10.58 |
| 5358.36 | Average | 38.35 | 8.87 | 47.22 | 54.00 | -6.78 |
| 5358.36 | Peak | 59.38 | 8.87 | 68.25 | 74.00 | -5.75 |

Unless otherwise stated the results shown in this test report refer only to the sample(s) tested and such sample(s) are retained for 90 days only.

除非另有說明，此報告結果僅對測試之樣品負責，同時此樣品僅保留90天。本報告未經本公司書面許可，不可部份複製。

This document is issued by the Company subject to its General Conditions of Service printed overleaf, available on request or accessible at <http://www.sgs.com.tw/Terms-and-Conditions> and for electronic format documents, subject to Terms and Conditions for Electronic Documents at <http://www.sgs.com.tw/Terms-and-Conditions>. Attention is drawn to the limitation of liability, indemnification and jurisdiction issues defined therein. Any holder of this document is advised that information contained hereon reflects the Company's findings at the time of its intervention only and within the limits of Client's instructions, if any. The Company's sole responsibility is to its Client and this document does not exonerate parties to a transaction from exercising all their rights and obligations under the transaction documents. This document cannot be reproduced except in full, without prior written approval of the Company. Any unauthorized alteration, forgery or falsification of the content or appearance of this document is unlawful and offenders may be prosecuted to the fullest extent of the law.

| | | | |
|----------------|-----------------------|--------------|------------------|
| Report Number | :ER-2021-20085 | Test Site | :SAC III Chamber |
| Operation Mode | :802.11ax20 RU 106/54 | Test Date | :2021-03-16 |
| Test Frequency | :5320 MHz | Temp./Humi. | :22.7/63 |
| Test Mode | :Bandedge CH High | Antenna Pol. | :VERTICAL |
| EUT Pol | :H Plane | Engineer | :Ricky |

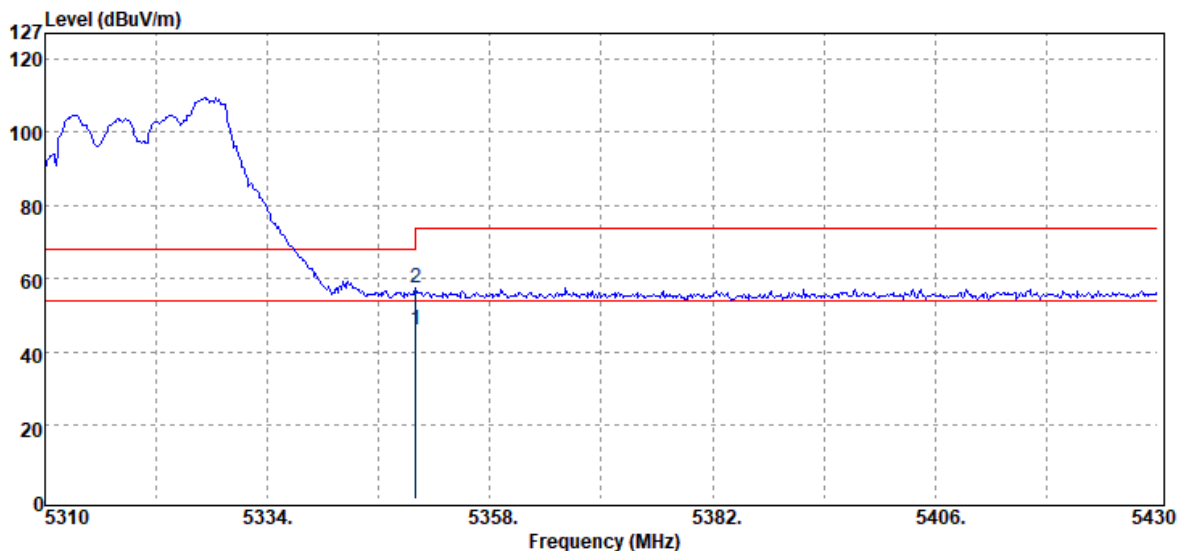

| Freq. MHz | Detector Mode PK/QP/AV | Spectrum Reading Level dBUV | Factor dB | Actual FS dBUV/m | Limit @3m dBUV/m | Margin dB |
|--------------|------------------------------|-----------------------------------|--------------|------------------------|------------------------|--------------|
| 5350.00 | Average | 37.50 | 8.77 | 46.27 | 54.00 | -7.73 |
| 5350.00 | Peak | 48.78 | 8.77 | 57.55 | 74.00 | -16.45 |

Unless otherwise stated the results shown in this test report refer only to the sample(s) tested and such sample(s) are retained for 90 days only.

除非另有說明，此報告結果僅對測試之樣品負責，同時此樣品僅保留90天。本報告未經本公司書面許可，不可部份複製。

This document is issued by the Company subject to its General Conditions of Service printed overleaf, available on request or accessible at <http://www.sgs.com.tw/Terms-and-Conditions> and for electronic format documents, subject to Terms and Conditions for Electronic Documents at <http://www.sgs.com.tw/Terms-and-Conditions>. Attention is drawn to the limitation of liability, indemnification and jurisdiction issues defined therein. Any holder of this document is advised that information contained hereon reflects the Company's findings at the time of its intervention only and within the limits of Client's instructions, if any. The Company's sole responsibility is to its Client and this document does not exonerate parties to a transaction from exercising all their rights and obligations under the transaction documents. This document cannot be reproduced except in full, without prior written approval of the Company. Any unauthorized alteration, forgery or falsification of the content or appearance of this document is unlawful and offenders may be prosecuted to the fullest extent of the law.

| | | | |
|----------------|-----------------------|--------------|------------------|
| Report Number | :ER-2021-20085 | Test Site | :SAC III Chamber |
| Operation Mode | :802.11ax20 RU 106/54 | Test Date | :2021-03-16 |
| Test Frequency | :5320 MHz | Temp./Humi. | :22.7/63 |
| Test Mode | :Bandedge CH High | Antenna Pol. | :HORIZONTAL |
| EUT Pol | :H Plane | Engineer | :Ricky |

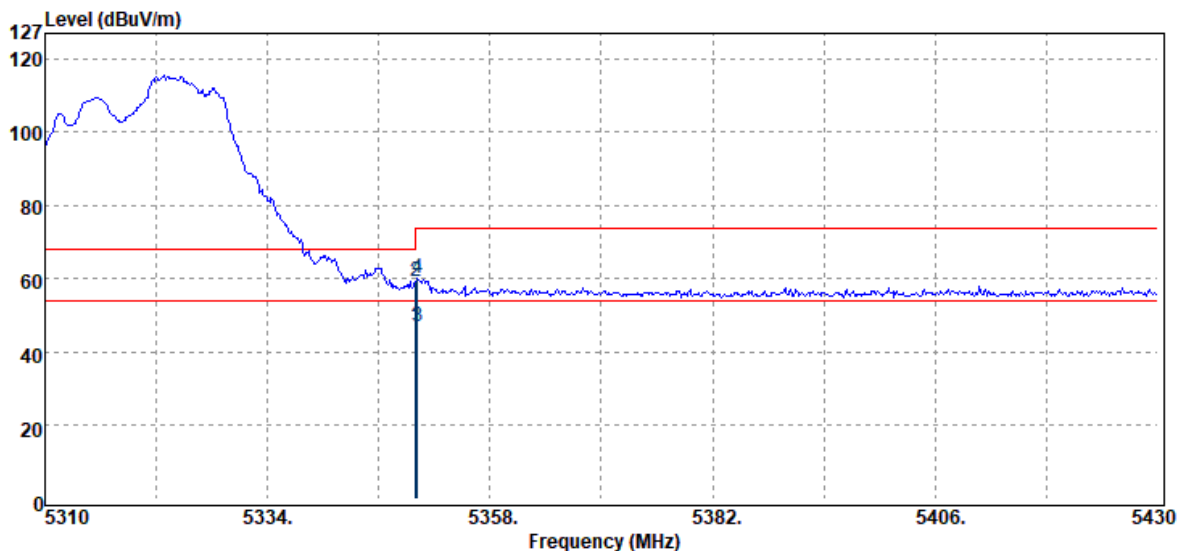

| Freq. MHz | Detector Mode PK/QP/AV | Spectrum Reading Level dB μ V | Factor dB | Actual FS dB μ V/m | Limit @3m dB μ V/m | Margin dB |
|--------------|------------------------------|---|--------------|------------------------------|------------------------------|--------------|
| 5350.00 | Average | 38.09 | 8.77 | 46.86 | 54.00 | -7.14 |
| 5350.00 | Peak | 50.61 | 8.77 | 59.38 | 74.00 | -14.62 |
| 5350.20 | Average | 38.13 | 8.77 | 46.90 | 54.00 | -7.10 |
| 5350.20 | Peak | 51.37 | 8.77 | 60.14 | 74.00 | -13.86 |

Unless otherwise stated the results shown in this test report refer only to the sample(s) tested and such sample(s) are retained for 90 days only.

除非另有說明，此報告結果僅對測試之樣品負責，同時此樣品僅保留90天。本報告未經本公司書面許可，不可部份複製。

This document is issued by the Company subject to its General Conditions of Service printed overleaf, available on request or accessible at <http://www.sgs.com.tw/Terms-and-Conditions> and for electronic format documents, subject to Terms and Conditions for Electronic Documents at <http://www.sgs.com.tw/Terms-and-Conditions>. Attention is drawn to the limitation of liability, indemnification and jurisdiction issues defined therein. Any holder of this document is advised that information contained hereon reflects the Company's findings at the time of its intervention only and within the limits of Client's instructions, if any. The Company's sole responsibility is to its Client and this document does not exonerate parties to a transaction from exercising all their rights and obligations under the transaction documents. This document cannot be reproduced except in full, without prior written approval of the Company. Any unauthorized alteration, forgery or falsification of the content or appearance of this document is unlawful and offenders may be prosecuted to the fullest extent of the law.

| | | | |
|----------------|---------------------|--------------|------------------|
| Report Number | :ER-2021-20085 | Test Site | :SAC III Chamber |
| Operation Mode | :802.11ax20 RU full | Test Date | :2021-03-16 |
| Test Frequency | :5500 MHz | Temp./Humi. | :22.7/63 |
| Test Mode | :Bandedge CH Low | Antenna Pol. | :VERTICAL |
| EUT Pol | :H Plane | Engineer | :Ricky |

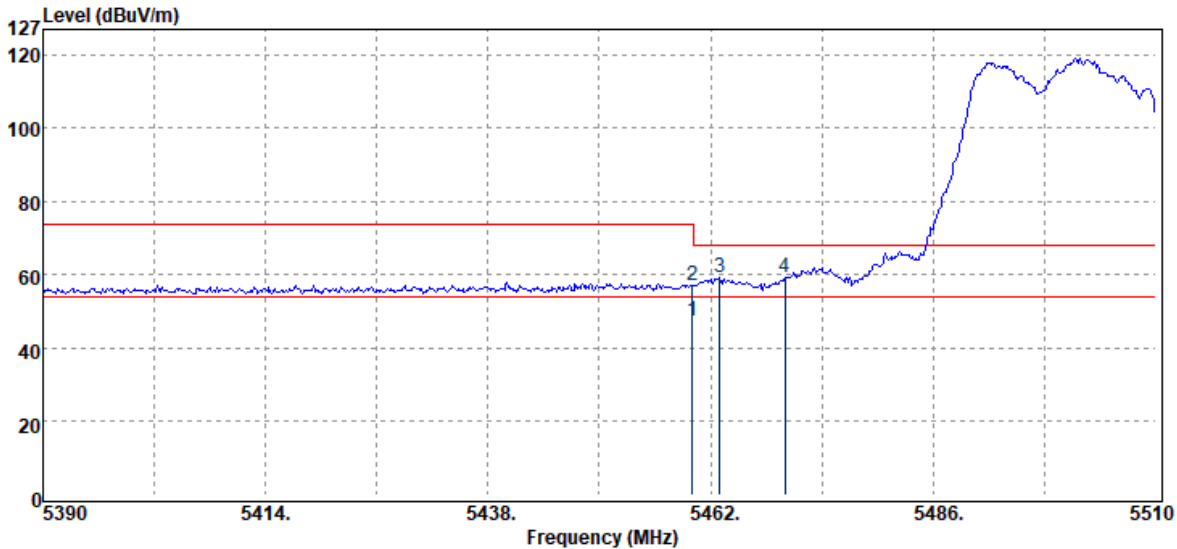

| Freq. MHz | Detector Mode PK/QP/AV | Spectrum Reading Level dB μ V | Factor dB | Actual FS dB μ V/m | Limit @3m dB μ V/m | Margin dB |
|--------------|------------------------------|---|--------------|------------------------------|------------------------------|--------------|
| 5460.00 | Average | 38.03 | 9.63 | 47.66 | 54.00 | -6.34 |
| 5460.00 | Peak | 47.53 | 9.63 | 57.16 | 74.00 | -16.84 |
| 5462.96 | Peak | 49.46 | 9.65 | 59.11 | 68.20 | -9.09 |
| 5470.00 | Peak | 49.55 | 9.71 | 59.26 | 68.20 | -8.94 |

Unless otherwise stated the results shown in this test report refer only to the sample(s) tested and such sample(s) are retained for 90 days only.

除非另有說明，此報告結果僅對測試之樣品負責，同時此樣品僅保留90天。本報告未經本公司書面許可，不可部份複製。

This document is issued by the Company subject to its General Conditions of Service printed overleaf, available on request or accessible at <http://www.sgs.com.tw/Terms-and-Conditions> and for electronic format documents, subject to Terms and Conditions for Electronic Documents at <http://www.sgs.com.tw/Terms-and-Conditions>. Attention is drawn to the limitation of liability, indemnification and jurisdiction issues defined therein. Any holder of this document is advised that information contained hereon reflects the Company's findings at the time of its intervention only and within the limits of Client's instructions, if any. The Company's sole responsibility is to its Client and this document does not exonerate parties to a transaction from exercising all their rights and obligations under the transaction documents. This document cannot be reproduced except in full, without prior written approval of the Company. Any unauthorized alteration, forgery or falsification of the content or appearance of this document is unlawful and offenders may be prosecuted to the fullest extent of the law.

| | | | |
|----------------|---------------------|--------------|------------------|
| Report Number | :ER-2021-20085 | Test Site | :SAC III Chamber |
| Operation Mode | :802.11ax20 RU full | Test Date | :2021-03-16 |
| Test Frequency | :5500 MHz | Temp./Humi. | :22.7/63 |
| Test Mode | :Bandedge CH Low | Antenna Pol. | :HORIZONTAL |
| EUT Pol | :H Plane | Engineer | :Ricky |

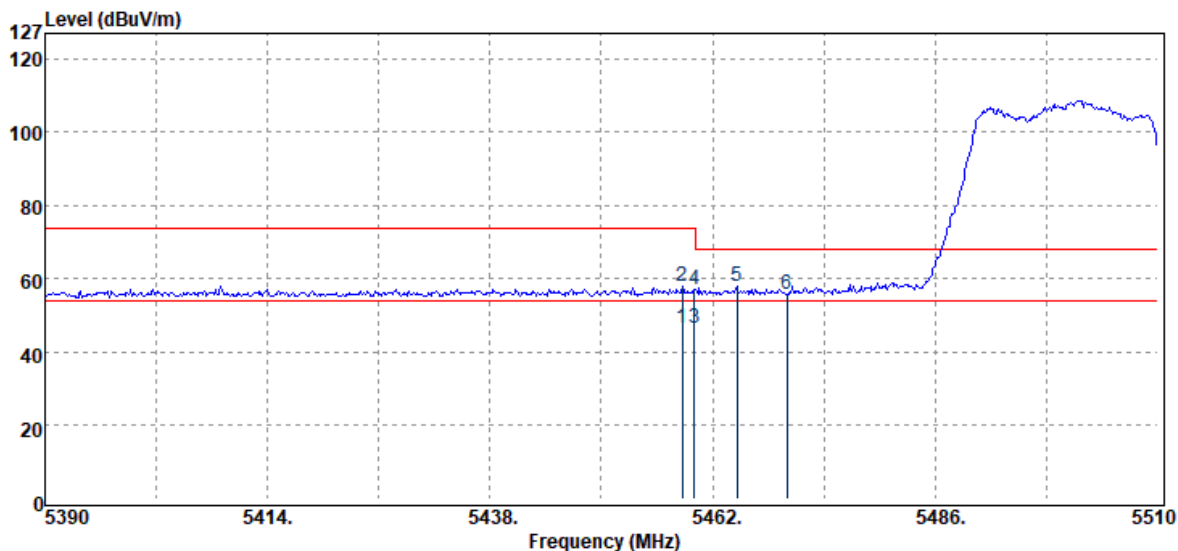

| Freq. MHz | Detector Mode PK/QP/AV | Spectrum Reading Level dB μ V | Factor dB | Actual FS dB μ V/m | Limit @3m dB μ V/m | Margin dB |
|--------------|------------------------------|---|--------------|------------------------------|------------------------------|--------------|
| 5458.76 | Average | 36.89 | 9.63 | 46.52 | 54.00 | -7.48 |
| 5458.76 | Peak | 48.17 | 9.63 | 57.80 | 74.00 | -16.20 |
| 5460.00 | Average | 36.92 | 9.63 | 46.55 | 54.00 | -7.45 |
| 5460.00 | Peak | 47.30 | 9.63 | 56.93 | 74.00 | -17.07 |
| 5464.64 | Peak | 48.19 | 9.67 | 57.86 | 68.20 | -10.34 |
| 5470.00 | Peak | 46.17 | 9.71 | 55.88 | 68.20 | -12.32 |

Unless otherwise stated the results shown in this test report refer only to the sample(s) tested and such sample(s) are retained for 90 days only.

除非另有說明，此報告結果僅對測試之樣品負責，同時此樣品僅保留90天。本報告未經本公司書面許可，不可部份複製。

This document is issued by the Company subject to its General Conditions of Service printed overleaf, available on request or accessible at <http://www.sgs.com.tw/Terms-and-Conditions> and for electronic format documents, subject to Terms and Conditions for Electronic Documents at <http://www.sgs.com.tw/Terms-and-Conditions>. Attention is drawn to the limitation of liability, indemnification and jurisdiction issues defined therein. Any holder of this document is advised that information contained hereon reflects the Company's findings at the time of its intervention only and within the limits of Client's instructions, if any. The Company's sole responsibility is to its Client and this document does not exonerate parties to a transaction from exercising all their rights and obligations under the transaction documents. This document cannot be reproduced except in full, without prior written approval of the Company. Any unauthorized alteration, forgery or falsification of the content or appearance of this document is unlawful and offenders may be prosecuted to the fullest extent of the law.

Report Number :ER-2021-20085
 Operation Mode :802.11ax20 RU 26/0
 Test Frequency :5500 MHz
 Test Mode :Bandedge CH Low
 EUT Pol :H Plane

Test Site :SAC III Chamber
 Test Date :2021-03-16
 Temp./Humi. :22.7/63
 Antenna Pol. :VERTICAL
 Engineer :Ricky

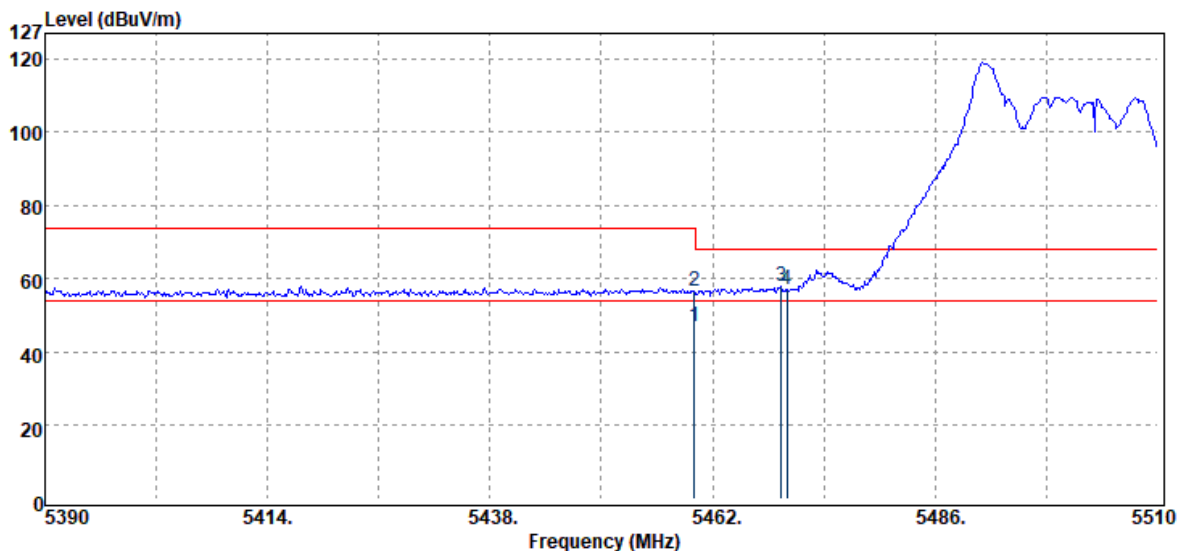

| Freq. MHz | Detector Mode PK/QP/AV | Spectrum Reading Level dB μ V | Factor dB | Actual FS dB μ V/m | Limit @3m dB μ V/m | Margin dB |
|--------------|------------------------------|---|--------------|------------------------------|------------------------------|--------------|
| 5460.00 | Average | 37.29 | 9.63 | 46.92 | 54.00 | -7.08 |
| 5460.00 | Peak | 47.16 | 9.63 | 56.79 | 74.00 | -17.21 |
| 5469.44 | Peak | 48.52 | 9.70 | 58.22 | 68.20 | -9.98 |
| 5470.00 | Peak | 47.60 | 9.71 | 57.31 | 68.20 | -10.89 |

Unless otherwise stated the results shown in this test report refer only to the sample(s) tested and such sample(s) are retained for 90 days only.

除非另有說明，此報告結果僅對測試之樣品負責，同時此樣品僅保留90天。本報告未經本公司書面許可，不可部份複製。

This document is issued by the Company subject to its General Conditions of Service printed overleaf, available on request or accessible at <http://www.sgs.com.tw/Terms-and-Conditions> and for electronic format documents, subject to Terms and Conditions for Electronic Documents at <http://www.sgs.com.tw/Terms-and-Conditions>. Attention is drawn to the limitation of liability, indemnification and jurisdiction issues defined therein. Any holder of this document is advised that information contained hereon reflects the Company's findings at the time of its intervention only and within the limits of Client's instructions, if any. The Company's sole responsibility is to its Client and this document does not exonerate parties to a transaction from exercising all their rights and obligations under the transaction documents. This document cannot be reproduced except in full, without prior written approval of the Company. Any unauthorized alteration, forgery or falsification of the content or appearance of this document is unlawful and offenders may be prosecuted to the fullest extent of the law.

Report Number :ER-2021-20085
 Operation Mode :802.11ax20 RU 26/0
 Test Frequency :5500 MHz
 Test Mode :Bandedge CH Low
 EUT Pol :H Plane

Test Site :SAC III Chamber
 Test Date :2021-03-16
 Temp./Humi. :22.7/63
 Antenna Pol. :HORIZONTAL
 Engineer :Ricky

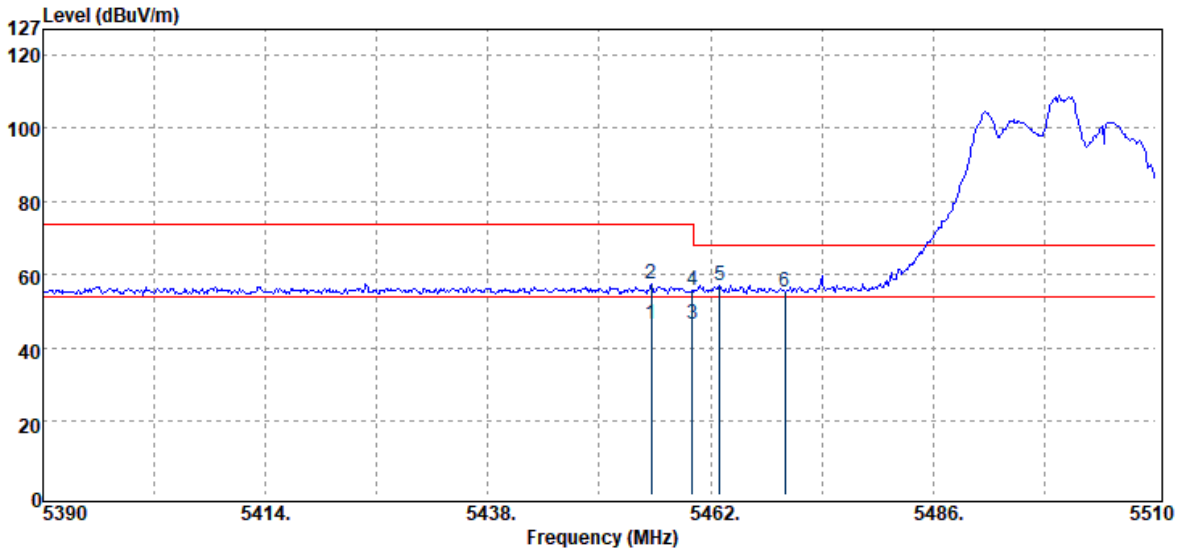

| Freq. MHz | Detector Mode PK/QP/AV | Spectrum Reading Level dB μ V | Factor dB | Actual FS dB μ V/m | Limit @3m dB μ V/m | Margin dB |
|--------------|------------------------------|---|--------------|------------------------------|------------------------------|--------------|
| 5455.64 | Average | 36.94 | 9.60 | 46.54 | 54.00 | -7.46 |
| 5455.64 | Peak | 48.13 | 9.60 | 57.73 | 74.00 | -16.27 |
| 5460.00 | Average | 36.79 | 9.63 | 46.42 | 54.00 | -7.58 |
| 5460.00 | Peak | 46.24 | 9.63 | 55.87 | 74.00 | -18.13 |
| 5462.96 | Peak | 47.56 | 9.65 | 57.21 | 68.20 | -10.99 |
| 5470.00 | Peak | 45.69 | 9.71 | 55.40 | 68.20 | -12.80 |

Unless otherwise stated the results shown in this test report refer only to the sample(s) tested and such sample(s) are retained for 90 days only.

除非另有說明，此報告結果僅對測試之樣品負責，同時此樣品僅保留90天。本報告未經本公司書面許可，不可部份複製。

This document is issued by the Company subject to its General Conditions of Service printed overleaf, available on request or accessible at <http://www.sgs.com.tw/Terms-and-Conditions> and for electronic format documents, subject to Terms and Conditions for Electronic Documents at <http://www.sgs.com.tw/Terms-and-Conditions>. Attention is drawn to the limitation of liability, indemnification and jurisdiction issues defined therein. Any holder of this document is advised that information contained hereon reflects the Company's findings at the time of its intervention only and within the limits of Client's instructions, if any. The Company's sole responsibility is to its Client and this document does not exonerate parties to a transaction from exercising all their rights and obligations under the transaction documents. This document cannot be reproduced except in full, without prior written approval of the Company. Any unauthorized alteration, forgery or falsification of the content or appearance of this document is unlawful and offenders may be prosecuted to the fullest extent of the law.

Report Number :ER-2021-20085
 Operation Mode :802.11ax20 RU 52/37
 Test Frequency :5500 MHz
 Test Mode :Bandedge CH Low
 EUT Pol :H Plane

Test Site :SAC III Chamber
 Test Date :2021-03-16
 Temp./Humi. :22.7/63
 Antenna Pol. :VERTICAL
 Engineer :Ricky

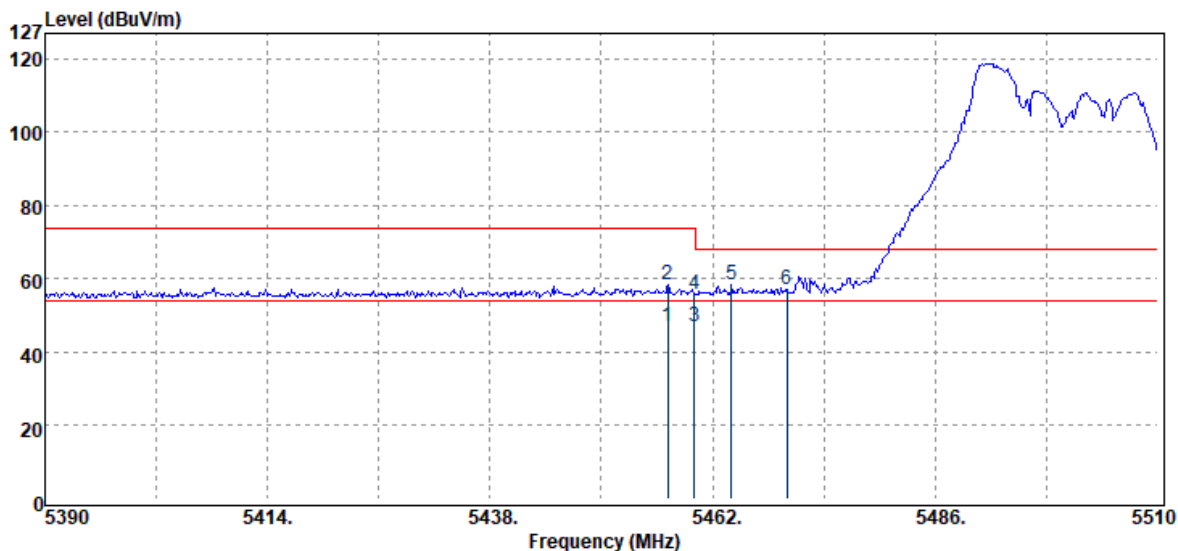

| Freq. MHz | Detector Mode PK/QP/AV | Spectrum Reading Level dB μ V | Factor dB | Actual FS dB μ V/m | Limit @3m dB μ V/m | Margin dB |
|--------------|------------------------------|---|--------------|------------------------------|------------------------------|--------------|
| 5457.20 | Average | 37.47 | 9.62 | 47.09 | 54.00 | -6.91 |
| 5457.20 | Peak | 49.01 | 9.62 | 58.63 | 74.00 | -15.37 |
| 5460.00 | Average | 37.38 | 9.63 | 47.01 | 54.00 | -6.99 |
| 5460.00 | Peak | 46.38 | 9.63 | 56.01 | 74.00 | -17.99 |
| 5464.04 | Peak | 48.59 | 9.66 | 58.25 | 68.20 | -9.95 |
| 5470.00 | Peak | 47.45 | 9.71 | 57.16 | 68.20 | -11.04 |

Unless otherwise stated the results shown in this test report refer only to the sample(s) tested and such sample(s) are retained for 90 days only.

除非另有說明，此報告結果僅對測試之樣品負責，同時此樣品僅保留90天。本報告未經本公司書面許可，不可部份複製。

This document is issued by the Company subject to its General Conditions of Service printed overleaf, available on request or accessible at <http://www.sgs.com.tw/Terms-and-Conditions> and for electronic format documents, subject to Terms and Conditions for Electronic Documents at <http://www.sgs.com.tw/Terms-and-Conditions>. Attention is drawn to the limitation of liability, indemnification and jurisdiction issues defined therein. Any holder of this document is advised that information contained hereon reflects the Company's findings at the time of its intervention only and within the limits of Client's instructions, if any. The Company's sole responsibility is to its Client and this document does not exonerate parties to a transaction from exercising all their rights and obligations under the transaction documents. This document cannot be reproduced except in full, without prior written approval of the Company. Any unauthorized alteration, forgery or falsification of the content or appearance of this document is unlawful and offenders may be prosecuted to the fullest extent of the law.

| | | | |
|----------------|----------------------|--------------|------------------|
| Report Number | :ER-2021-20085 | Test Site | :SAC III Chamber |
| Operation Mode | :802.11ax20 RU 52/37 | Test Date | :2021-03-16 |
| Test Frequency | :5500 MHz | Temp./Humi. | :22.7/63 |
| Test Mode | :Bandedge CH Low | Antenna Pol. | :HORIZONTAL |
| EUT Pol | :H Plane | Engineer | :Ricky |

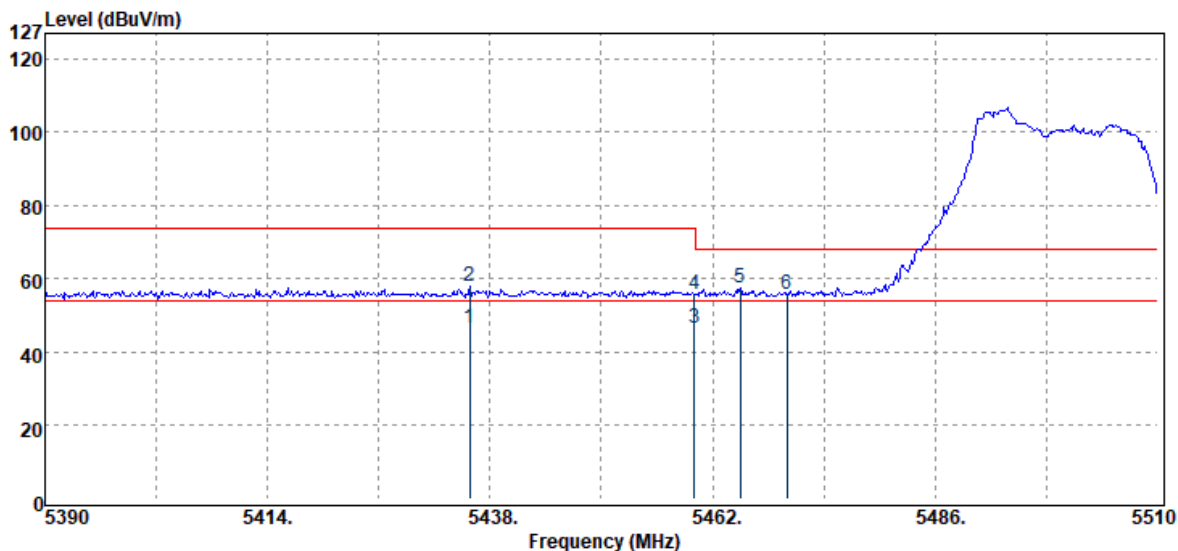

| Freq. MHz | Detector Mode PK/QP/AV | Spectrum Reading Level dB μ V | Factor dB | Actual FS dB μ V/m | Limit @3m dB μ V/m | Margin dB |
|--------------|------------------------------|---|--------------|------------------------------|------------------------------|--------------|
| 5435.84 | Average | 36.92 | 9.53 | 46.45 | 54.00 | -7.55 |
| 5435.84 | Peak | 48.36 | 9.53 | 57.89 | 74.00 | -16.11 |
| 5460.00 | Average | 36.79 | 9.63 | 46.42 | 54.00 | -7.58 |
| 5460.00 | Peak | 46.21 | 9.63 | 55.84 | 74.00 | -18.16 |
| 5465.00 | Peak | 47.69 | 9.67 | 57.36 | 68.20 | -10.84 |
| 5470.00 | Peak | 46.08 | 9.71 | 55.79 | 68.20 | -12.41 |

Unless otherwise stated the results shown in this test report refer only to the sample(s) tested and such sample(s) are retained for 90 days only.

除非另有說明，此報告結果僅對測試之樣品負責，同時此樣品僅保留90天。本報告未經本公司書面許可，不可部份複製。

This document is issued by the Company subject to its General Conditions of Service printed overleaf, available on request or accessible at <http://www.sgs.com.tw/Terms-and-Conditions> and for electronic format documents, subject to Terms and Conditions for Electronic Documents at <http://www.sgs.com.tw/Terms-and-Conditions>. Attention is drawn to the limitation of liability, indemnification and jurisdiction issues defined therein. Any holder of this document is advised that information contained hereon reflects the Company's findings at the time of its intervention only and within the limits of Client's instructions, if any. The Company's sole responsibility is to its Client and this document does not exonerate parties to a transaction from exercising all their rights and obligations under the transaction documents. This document cannot be reproduced except in full, without prior written approval of the Company. Any unauthorized alteration, forgery or falsification of the content or appearance of this document is unlawful and offenders may be prosecuted to the fullest extent of the law.

| | | | |
|----------------|-----------------------|--------------|------------------|
| Report Number | :ER-2021-20085 | Test Site | :SAC III Chamber |
| Operation Mode | :802.11ax20 RU 106/53 | Test Date | :2021-03-16 |
| Test Frequency | :5500 MHz | Temp./Humi. | :22.7/63 |
| Test Mode | :Bandedge CH Low | Antenna Pol. | :VERTICAL |
| EUT Pol | :H Plane | Engineer | :Ricky |

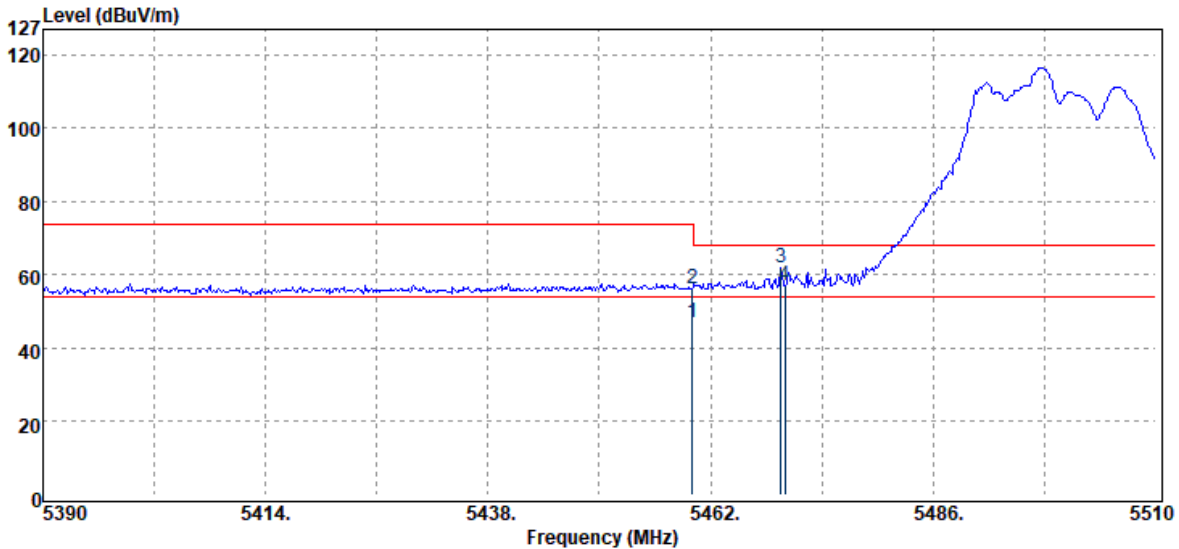

| Freq. MHz | Detector Mode PK/QP/AV | Spectrum Reading Level dB μ V | Factor dB | Actual FS dB μ V/m | Limit @3m dB μ V/m | Margin dB |
|--------------|------------------------------|---|--------------|------------------------------|------------------------------|--------------|
| 5460.00 | Average | 37.38 | 9.63 | 47.01 | 54.00 | -6.99 |
| 5460.00 | Peak | 46.61 | 9.63 | 56.24 | 74.00 | -17.76 |
| 5469.56 | Peak | 52.31 | 9.70 | 62.01 | 68.20 | -6.19 |
| 5470.00 | Peak | 47.24 | 9.71 | 56.95 | 68.20 | -11.25 |

Unless otherwise stated the results shown in this test report refer only to the sample(s) tested and such sample(s) are retained for 90 days only.

除非另有說明，此報告結果僅對測試之樣品負責，同時此樣品僅保留90天。本報告未經本公司書面許可，不可部份複製。

This document is issued by the Company subject to its General Conditions of Service printed overleaf, available on request or accessible at <http://www.sgs.com.tw/Terms-and-Conditions> and for electronic format documents, subject to Terms and Conditions for Electronic Documents at <http://www.sgs.com.tw/Terms-and-Conditions>. Attention is drawn to the limitation of liability, indemnification and jurisdiction issues defined therein. Any holder of this document is advised that information contained hereon reflects the Company's findings at the time of its intervention only and within the limits of Client's instructions, if any. The Company's sole responsibility is to its Client and this document does not exonerate parties to a transaction from exercising all their rights and obligations under the transaction documents. This document cannot be reproduced except in full, without prior written approval of the Company. Any unauthorized alteration, forgery or falsification of the content or appearance of this document is unlawful and offenders may be prosecuted to the fullest extent of the law.

| | | | |
|----------------|-----------------------|--------------|------------------|
| Report Number | :ER-2021-20085 | Test Site | :SAC III Chamber |
| Operation Mode | :802.11ax20 RU 106/53 | Test Date | :2021-03-16 |
| Test Frequency | :5500 MHz | Temp./Humi. | :22.7/63 |
| Test Mode | :Bandedge CH Low | Antenna Pol. | :HORIZONTAL |
| EUT Pol | :H Plane | Engineer | :Ricky |

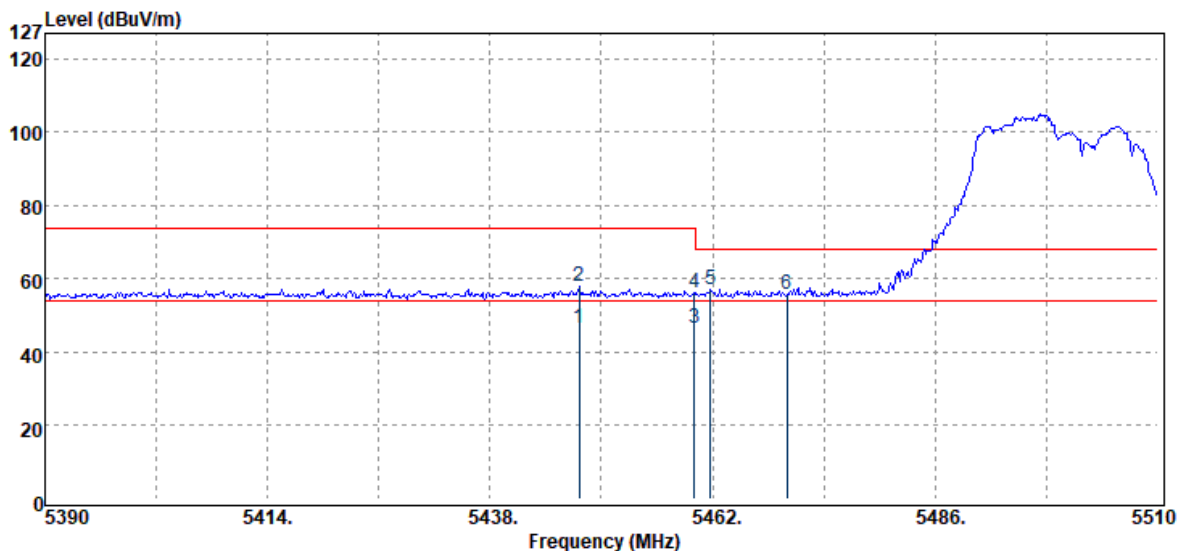

| Freq. MHz | Detector Mode PK/QP/AV | Spectrum Reading Level dB μ V | Factor dB | Actual FS dB μ V/m | Limit @3m dB μ V/m | Margin dB |
|--------------|------------------------------|---|--------------|------------------------------|------------------------------|--------------|
| 5447.60 | Average | 37.01 | 9.56 | 46.57 | 54.00 | -7.43 |
| 5447.60 | Peak | 48.36 | 9.56 | 57.92 | 74.00 | -16.08 |
| 5460.00 | Average | 36.89 | 9.63 | 46.52 | 54.00 | -7.48 |
| 5460.00 | Peak | 46.58 | 9.63 | 56.21 | 74.00 | -17.79 |
| 5461.76 | Peak | 47.65 | 9.65 | 57.30 | 68.20 | -10.90 |
| 5470.00 | Peak | 46.01 | 9.71 | 55.72 | 68.20 | -12.48 |

Unless otherwise stated the results shown in this test report refer only to the sample(s) tested and such sample(s) are retained for 90 days only.

除非另有說明，此報告結果僅對測試之樣品負責，同時此樣品僅保留90天。本報告未經本公司書面許可，不可部份複製。

This document is issued by the Company subject to its General Conditions of Service printed overleaf, available on request or accessible at <http://www.sgs.com.tw/Terms-and-Conditions> and for electronic format documents, subject to Terms and Conditions for Electronic Documents at <http://www.sgs.com.tw/Terms-and-Conditions>. Attention is drawn to the limitation of liability, indemnification and jurisdiction issues defined therein. Any holder of this document is advised that information contained hereon reflects the Company's findings at the time of its intervention only and within the limits of Client's instructions, if any. The Company's sole responsibility is to its Client and this document does not exonerate parties to a transaction from exercising all their rights and obligations under the transaction documents. This document cannot be reproduced except in full, without prior written approval of the Company. Any unauthorized alteration, forgery or falsification of the content or appearance of this document is unlawful and offenders may be prosecuted to the fullest extent of the law.

| | | | |
|----------------|---------------------|--------------|------------------|
| Report Number | :ER-2021-20085 | Test Site | :SAC III Chamber |
| Operation Mode | :802.11ax20 RU full | Test Date | :2021-03-16 |
| Test Frequency | :5700 MHz | Temp./Humi. | :22.7/63 |
| Test Mode | :Bandedge CH High | Antenna Pol. | :VERTICAL |
| EUT Pol | :H Plane | Engineer | :Ricky |

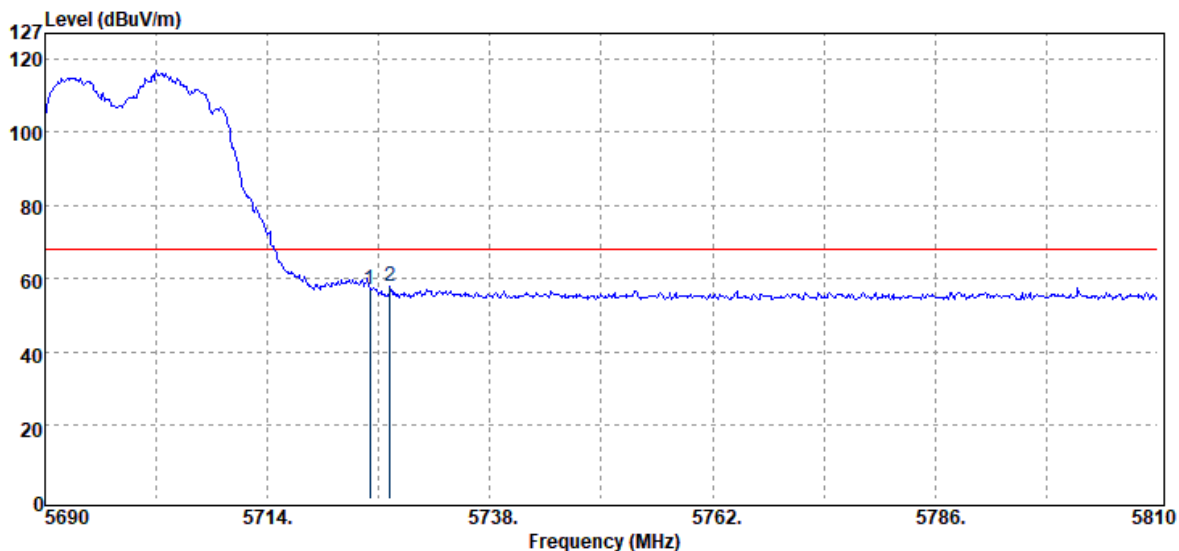

| Freq. MHz | Detector Mode PK/QP/AV | Spectrum Reading Level dBμV | Factor dB | Actual FS dBμV/m | Limit @3m dBμV/m | Margin dB |
|--------------|------------------------------|-----------------------------------|--------------|------------------------|------------------------|--------------|
| 5725.00 | Peak | 49.04 | 8.12 | 57.16 | 68.20 | -11.04 |
| 5727.20 | Peak | 49.74 | 8.12 | 57.86 | 68.20 | -10.34 |

Unless otherwise stated the results shown in this test report refer only to the sample(s) tested and such sample(s) are retained for 90 days only.

除非另有說明，此報告結果僅對測試之樣品負責，同時此樣品僅保留90天。本報告未經本公司書面許可，不可部份複製。

This document is issued by the Company subject to its General Conditions of Service printed overleaf, available on request or accessible at <http://www.sgs.com.tw/Terms-and-Conditions> and for electronic format documents, subject to Terms and Conditions for Electronic Documents at <http://www.sgs.com.tw/Terms-and-Conditions>. Attention is drawn to the limitation of liability, indemnification and jurisdiction issues defined therein. Any holder of this document is advised that information contained hereon reflects the Company's findings at the time of its intervention only and within the limits of Client's instructions, if any. The Company's sole responsibility is to its Client and this document does not exonerate parties to a transaction from exercising all their rights and obligations under the transaction documents. This document cannot be reproduced except in full, without prior written approval of the Company. Any unauthorized alteration, forgery or falsification of the content or appearance of this document is unlawful and offenders may be prosecuted to the fullest extent of the law.

| | | | |
|----------------|---------------------|--------------|------------------|
| Report Number | :ER-2021-20085 | Test Site | :SAC III Chamber |
| Operation Mode | :802.11ax20 RU full | Test Date | :2021-03-16 |
| Test Frequency | :5700 MHz | Temp./Humi. | :22.7/63 |
| Test Mode | :Bandedge CH High | Antenna Pol. | :HORIZONTAL |
| EUT Pol | :H Plane | Engineer | :Ricky |

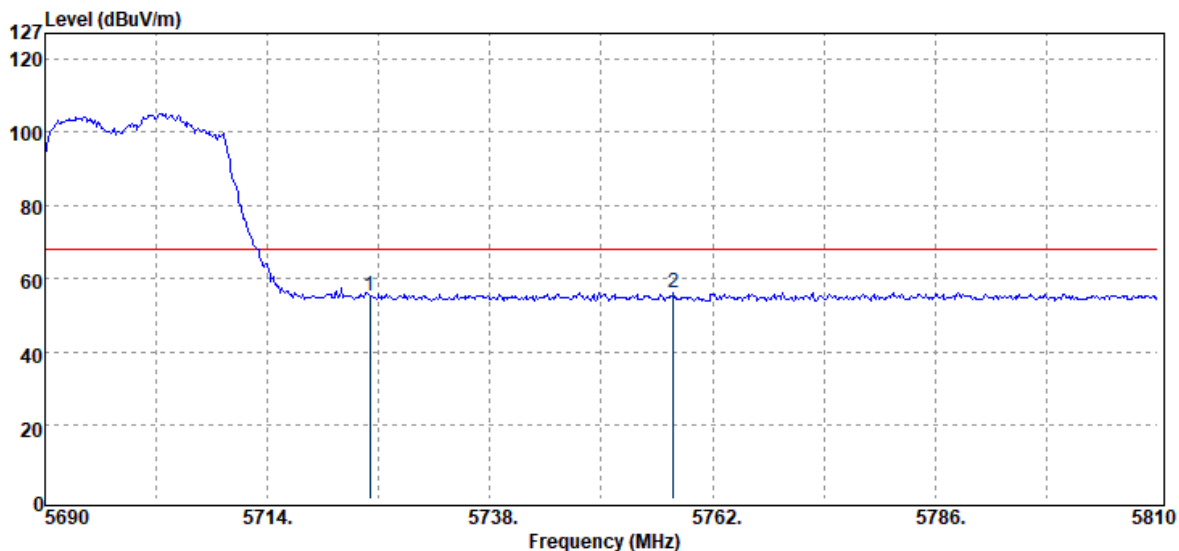

| Freq. MHz | Detector Mode PK/QP/AV | Spectrum Reading Level dB μ V | Factor dB | Actual FS dB μ V/m | Limit @3m dB μ V/m | Margin dB |
|--------------|------------------------------|---|--------------|------------------------------|------------------------------|--------------|
| 5725.00 | Peak | 47.12 | 8.12 | 55.24 | 68.20 | -12.96 |
| 5757.80 | Peak | 48.17 | 8.26 | 56.43 | 68.20 | -11.77 |

Unless otherwise stated the results shown in this test report refer only to the sample(s) tested and such sample(s) are retained for 90 days only.

除非另有說明，此報告結果僅對測試之樣品負責，同時此樣品僅保留90天。本報告未經本公司書面許可，不可部份複製。

This document is issued by the Company subject to its General Conditions of Service printed overleaf, available on request or accessible at <http://www.sgs.com.tw/Terms-and-Conditions> and for electronic format documents, subject to Terms and Conditions for Electronic Documents at <http://www.sgs.com.tw/Terms-and-Conditions>. Attention is drawn to the limitation of liability, indemnification and jurisdiction issues defined therein. Any holder of this document is advised that information contained hereon reflects the Company's findings at the time of its intervention only and within the limits of Client's instructions, if any. The Company's sole responsibility is to its Client and this document does not exonerate parties to a transaction from exercising all their rights and obligations under the transaction documents. This document cannot be reproduced except in full, without prior written approval of the Company. Any unauthorized alteration, forgery or falsification of the content or appearance of this document is unlawful and offenders may be prosecuted to the fullest extent of the law.

| | | | |
|----------------|---------------------|--------------|------------------|
| Report Number | :ER-2021-20085 | Test Site | :SAC III Chamber |
| Operation Mode | :802.11ax20 RU 26/8 | Test Date | :2021-03-16 |
| Test Frequency | :5700 MHz | Temp./Humi. | :22.7/63 |
| Test Mode | :Bandedge CH High | Antenna Pol. | :VERTICAL |
| EUT Pol | :H Plane | Engineer | :Ricky |

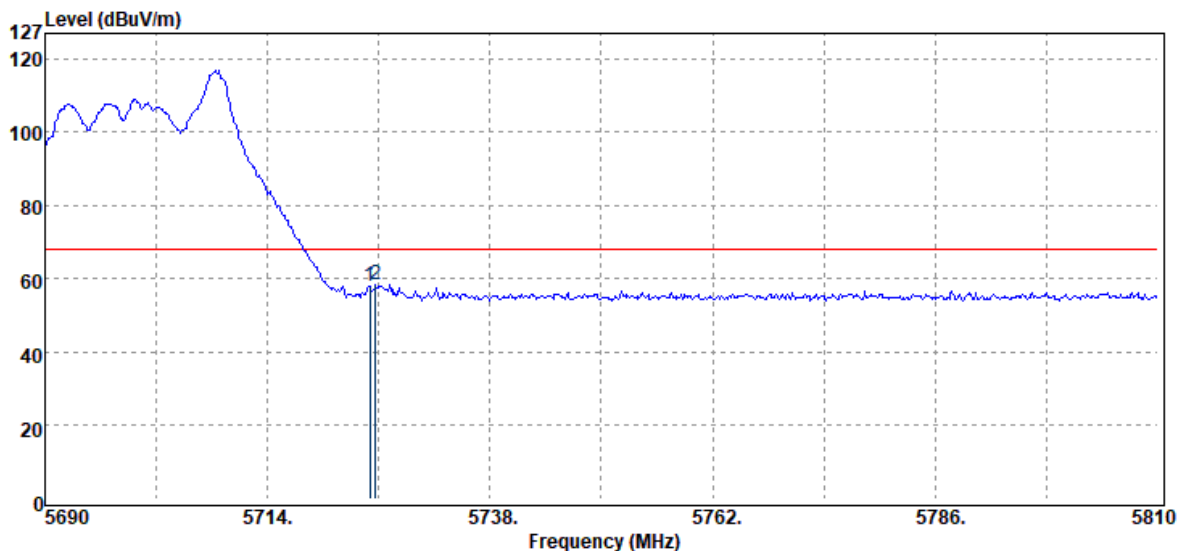

| Freq. MHz | Detector Mode PK/QP/AV | Spectrum Reading Level dB μ V | Factor dB | Actual FS dB μ V/m | Limit @3m dB μ V/m | Margin dB |
|--------------|------------------------------|---|--------------|------------------------------|------------------------------|--------------|
| 5725.00 | Peak | 50.08 | 8.12 | 58.20 | 68.20 | -10.00 |
| 5725.64 | Peak | 50.26 | 8.12 | 58.38 | 68.20 | -9.82 |

Unless otherwise stated the results shown in this test report refer only to the sample(s) tested and such sample(s) are retained for 90 days only.

除非另有說明，此報告結果僅對測試之樣品負責，同時此樣品僅保留90天。本報告未經本公司書面許可，不可部份複製。

This document is issued by the Company subject to its General Conditions of Service printed overleaf, available on request or accessible at <http://www.sgs.com.tw/Terms-and-Conditions> and for electronic format documents, subject to Terms and Conditions for Electronic Documents at <http://www.sgs.com.tw/Terms-and-Conditions>. Attention is drawn to the limitation of liability, indemnification and jurisdiction issues defined therein. Any holder of this document is advised that information contained hereon reflects the Company's findings at the time of its intervention only and within the limits of Client's instructions, if any. The Company's sole responsibility is to its Client and this document does not exonerate parties to a transaction from exercising all their rights and obligations under the transaction documents. This document cannot be reproduced except in full, without prior written approval of the Company. Any unauthorized alteration, forgery or falsification of the content or appearance of this document is unlawful and offenders may be prosecuted to the fullest extent of the law.

| | | | |
|----------------|---------------------|--------------|------------------|
| Report Number | :ER-2021-20085 | Test Site | :SAC III Chamber |
| Operation Mode | :802.11ax20 RU 26/8 | Test Date | :2021-03-16 |
| Test Frequency | :5700 MHz | Temp./Humi. | :22.7/63 |
| Test Mode | :Bandedge CH High | Antenna Pol. | :HORIZONTAL |
| EUT Pol | :H Plane | Engineer | :Ricky |

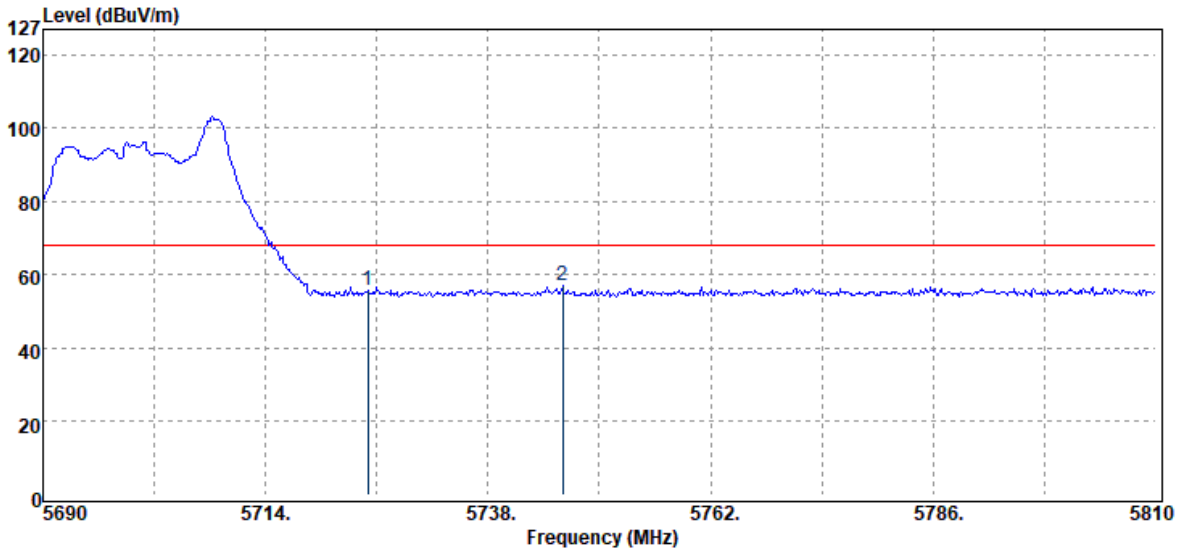

| Freq. MHz | Detector Mode PK/QP/AV | Spectrum Reading Level dB μ V | Factor dB | Actual FS dB μ V/m | Limit @3m dB μ V/m | Margin dB |
|--------------|------------------------------|---|--------------|------------------------------|------------------------------|--------------|
| 5725.00 | Peak | 47.62 | 8.12 | 55.74 | 68.20 | -12.46 |
| 5746.04 | Peak | 48.74 | 8.19 | 56.93 | 68.20 | -11.27 |

Unless otherwise stated the results shown in this test report refer only to the sample(s) tested and such sample(s) are retained for 90 days only.

除非另有說明，此報告結果僅對測試之樣品負責，同時此樣品僅保留90天。本報告未經本公司書面許可，不可部份複製。

This document is issued by the Company subject to its General Conditions of Service printed overleaf, available on request or accessible at <http://www.sgs.com.tw/Terms-and-Conditions> and for electronic format documents, subject to Terms and Conditions for Electronic Documents at <http://www.sgs.com.tw/Terms-and-Conditions>. Attention is drawn to the limitation of liability, indemnification and jurisdiction issues defined therein. Any holder of this document is advised that information contained hereon reflects the Company's findings at the time of its intervention only and within the limits of Client's instructions, if any. The Company's sole responsibility is to its Client and this document does not exonerate parties to a transaction from exercising all their rights and obligations under the transaction documents. This document cannot be reproduced except in full, without prior written approval of the Company. Any unauthorized alteration, forgery or falsification of the content or appearance of this document is unlawful and offenders may be prosecuted to the fullest extent of the law.

| | | | |
|----------------|----------------------|--------------|------------------|
| Report Number | :ER-2021-20085 | Test Site | :SAC III Chamber |
| Operation Mode | :802.11ax20 RU 52/40 | Test Date | :2021-03-16 |
| Test Frequency | :5700 MHz | Temp./Humi. | :22.7/63 |
| Test Mode | :Bandedge CH High | Antenna Pol. | :VERTICAL |
| EUT Pol | :H Plane | Engineer | :Ricky |

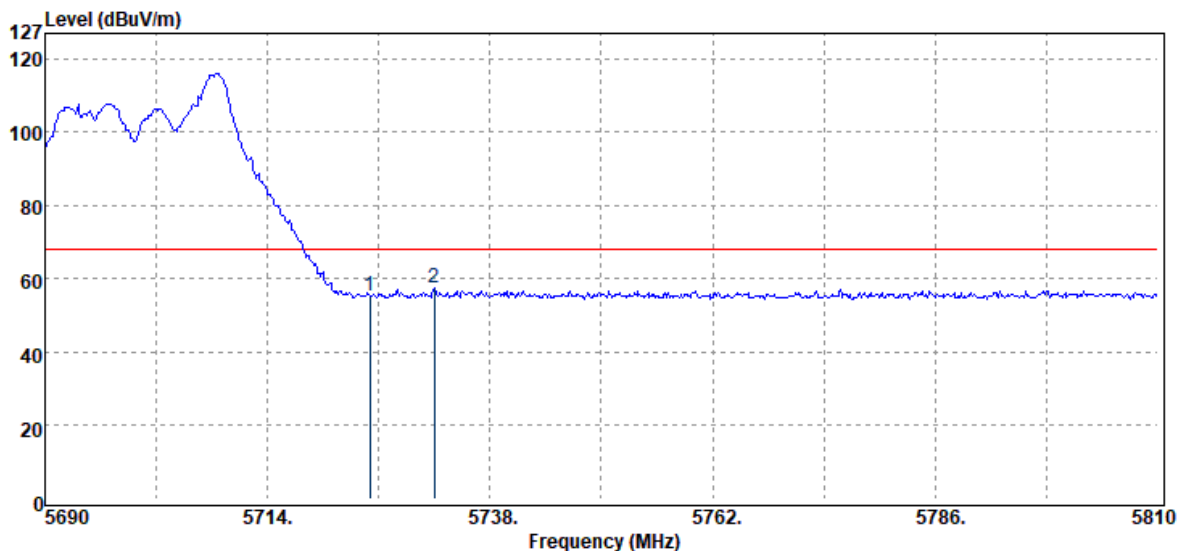

| Freq. MHz | Detector Mode PK/QP/AV | Spectrum Reading Level dBμV | Factor dB | Actual FS dBμV/m | Limit @3m dBμV/m | Margin dB |
|--------------|------------------------------|-----------------------------------|--------------|------------------------|------------------------|--------------|
| 5725.00 | Peak | 47.24 | 8.12 | 55.36 | 68.20 | -12.84 |
| 5732.00 | Peak | 49.30 | 8.14 | 57.44 | 68.20 | -10.76 |

Unless otherwise stated the results shown in this test report refer only to the sample(s) tested and such sample(s) are retained for 90 days only.

除非另有說明，此報告結果僅對測試之樣品負責，同時此樣品僅保留90天。本報告未經本公司書面許可，不可部份複製。

This document is issued by the Company subject to its General Conditions of Service printed overleaf, available on request or accessible at <http://www.sgs.com.tw/Terms-and-Conditions> and for electronic format documents, subject to Terms and Conditions for Electronic Documents at <http://www.sgs.com.tw/Terms-and-Conditions>. Attention is drawn to the limitation of liability, indemnification and jurisdiction issues defined therein. Any holder of this document is advised that information contained hereon reflects the Company's findings at the time of its intervention only and within the limits of Client's instructions, if any. The Company's sole responsibility is to its Client and this document does not exonerate parties to a transaction from exercising all their rights and obligations under the transaction documents. This document cannot be reproduced except in full, without prior written approval of the Company. Any unauthorized alteration, forgery or falsification of the content or appearance of this document is unlawful and offenders may be prosecuted to the fullest extent of the law.

| | | | |
|----------------|----------------------|--------------|------------------|
| Report Number | :ER-2021-20085 | Test Site | :SAC III Chamber |
| Operation Mode | :802.11ax20 RU 52/40 | Test Date | :2021-03-16 |
| Test Frequency | :5700 MHz | Temp./Humi. | :22.7/63 |
| Test Mode | :Bandedge CH High | Antenna Pol. | :HORIZONTAL |
| EUT Pol | :H Plane | Engineer | :Ricky |

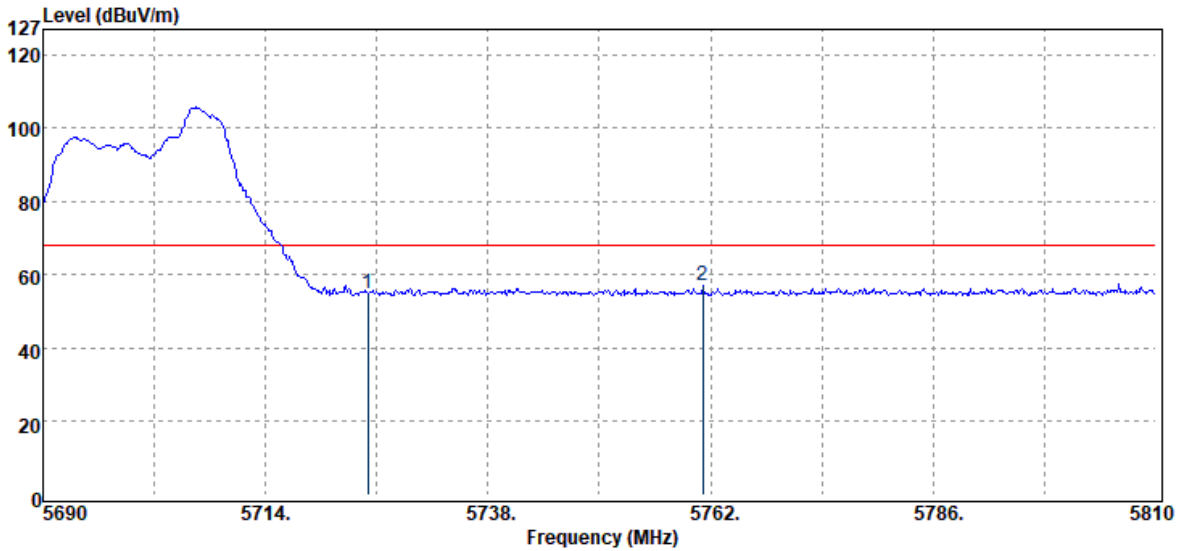

| Freq. MHz | Detector Mode PK/QP/AV | Spectrum Reading Level dBμV | Factor dB | Actual FS dBμV/m | Limit @3m dBμV/m | Margin dB |
|--------------|------------------------------|-----------------------------------|--------------|------------------------|------------------------|--------------|
| 5725.00 | Peak | 46.60 | 8.12 | 54.72 | 68.20 | -13.48 |
| 5761.16 | Peak | 48.98 | 8.26 | 57.24 | 68.20 | -10.96 |

Unless otherwise stated the results shown in this test report refer only to the sample(s) tested and such sample(s) are retained for 90 days only.

除非另有說明，此報告結果僅對測試之樣品負責，同時此樣品僅保留90天。本報告未經本公司書面許可，不可部份複製。

This document is issued by the Company subject to its General Conditions of Service printed overleaf, available on request or accessible at <http://www.sgs.com.tw/Terms-and-Conditions> and for electronic format documents, subject to Terms and Conditions for Electronic Documents at <http://www.sgs.com.tw/Terms-and-Conditions>. Attention is drawn to the limitation of liability, indemnification and jurisdiction issues defined therein. Any holder of this document is advised that information contained hereon reflects the Company's findings at the time of its intervention only and within the limits of Client's instructions, if any. The Company's sole responsibility is to its Client and this document does not exonerate parties to a transaction from exercising all their rights and obligations under the transaction documents. This document cannot be reproduced except in full, without prior written approval of the Company. Any unauthorized alteration, forgery or falsification of the content or appearance of this document is unlawful and offenders may be prosecuted to the fullest extent of the law.

| | | | |
|----------------|-----------------------|--------------|------------------|
| Report Number | :ER-2021-20085 | Test Site | :SAC III Chamber |
| Operation Mode | :802.11ax20 RU 106/54 | Test Date | :2021-03-16 |
| Test Frequency | :5700 MHz | Temp./Humi. | :22.7/63 |
| Test Mode | :Bandedge CH High | Antenna Pol. | :VERTICAL |
| EUT Pol | :H Plane | Engineer | :Ricky |

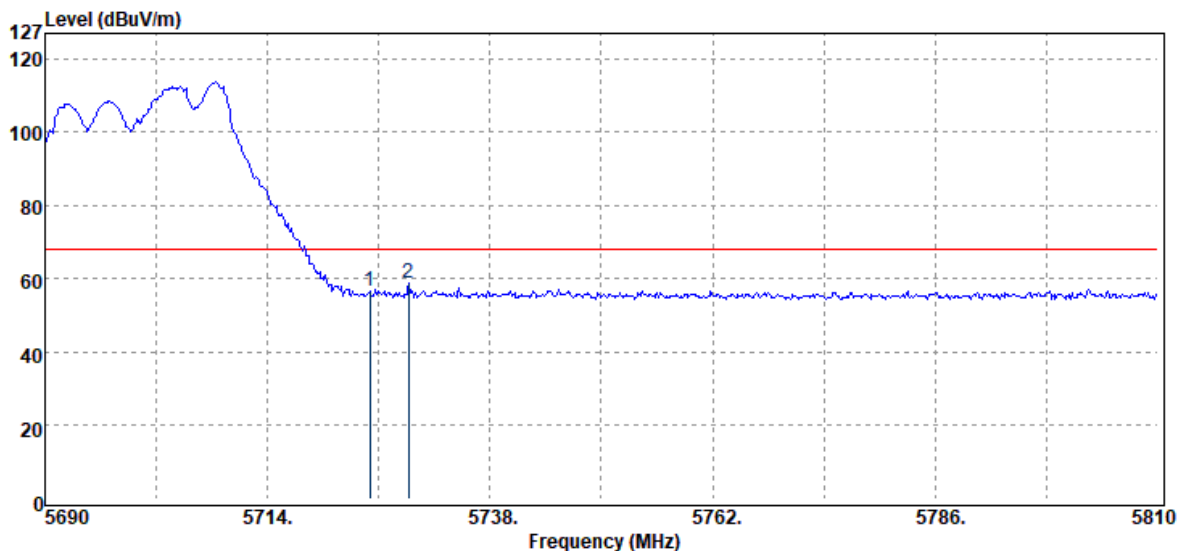

| Freq. MHz | Detector Mode PK/QP/AV | Spectrum Reading Level d μ V | Factor dB | Actual FS d μ V/m | Limit @3m d μ V/m | Margin dB |
|--------------|------------------------------|--|--------------|-----------------------------|-----------------------------|--------------|
| 5725.00 | Peak | 48.51 | 8.12 | 56.63 | 68.20 | -11.57 |
| 5729.24 | Peak | 50.80 | 8.14 | 58.94 | 68.20 | -9.26 |

Unless otherwise stated the results shown in this test report refer only to the sample(s) tested and such sample(s) are retained for 90 days only.

除非另有說明，此報告結果僅對測試之樣品負責，同時此樣品僅保留90天。本報告未經本公司書面許可，不可部份複製。

This document is issued by the Company subject to its General Conditions of Service printed overleaf, available on request or accessible at <http://www.sgs.com.tw/Terms-and-Conditions> and for electronic format documents, subject to Terms and Conditions for Electronic Documents at <http://www.sgs.com.tw/Terms-and-Conditions>. Attention is drawn to the limitation of liability, indemnification and jurisdiction issues defined therein. Any holder of this document is advised that information contained hereon reflects the Company's findings at the time of its intervention only and within the limits of Client's instructions, if any. The Company's sole responsibility is to its Client and this document does not exonerate parties to a transaction from exercising all their rights and obligations under the transaction documents. This document cannot be reproduced except in full, without prior written approval of the Company. Any unauthorized alteration, forgery or falsification of the content or appearance of this document is unlawful and offenders may be prosecuted to the fullest extent of the law.

| | | | |
|----------------|-----------------------|--------------|------------------|
| Report Number | :ER-2021-20085 | Test Site | :SAC III Chamber |
| Operation Mode | :802.11ax20 RU 106/54 | Test Date | :2021-03-16 |
| Test Frequency | :5700 MHz | Temp./Humi. | :22.7/63 |
| Test Mode | :Bandedge CH High | Antenna Pol. | :HORIZONTAL |
| EUT Pol | :H Plane | Engineer | :Ricky |

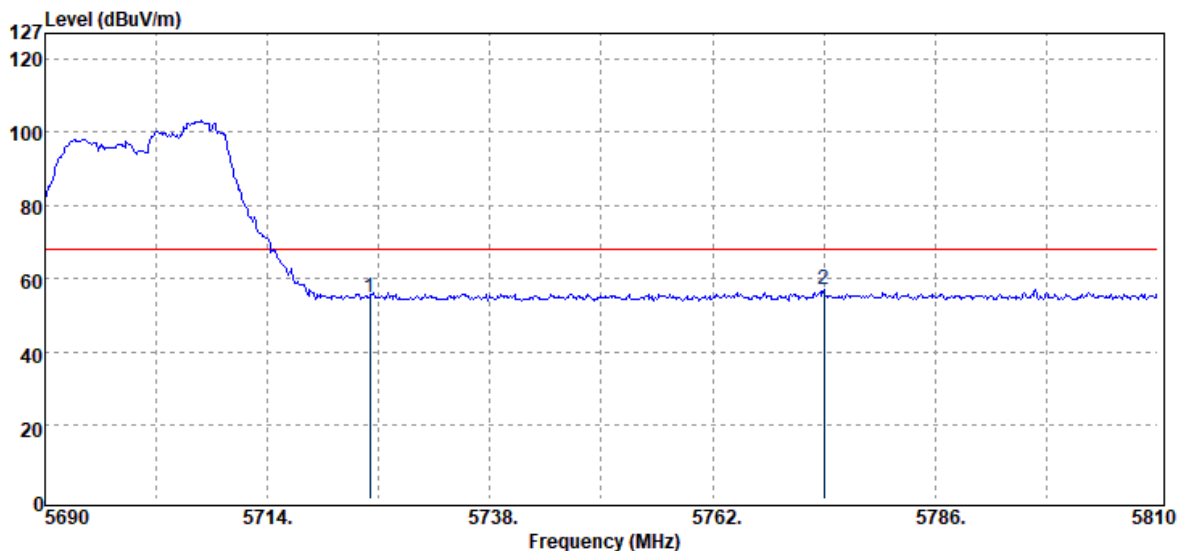

| Freq. MHz | Detector Mode PK/QP/AV | Spectrum Reading Level dB μ V | Factor dB | Actual FS dB μ V/m | Limit @3m dB μ V/m | Margin dB |
|--------------|------------------------------|---|--------------|------------------------------|------------------------------|--------------|
| 5725.00 | Peak | 46.93 | 8.12 | 55.05 | 68.20 | -13.15 |
| 5774.00 | Peak | 48.86 | 8.31 | 57.17 | 68.20 | -11.03 |

Unless otherwise stated the results shown in this test report refer only to the sample(s) tested and such sample(s) are retained for 90 days only.

除非另有說明，此報告結果僅對測試之樣品負責，同時此樣品僅保留90天。本報告未經本公司書面許可，不可部份複製。

This document is issued by the Company subject to its General Conditions of Service printed overleaf, available on request or accessible at <http://www.sgs.com.tw/Terms-and-Conditions> and for electronic format documents, subject to Terms and Conditions for Electronic Documents at <http://www.sgs.com.tw/Terms-and-Conditions>. Attention is drawn to the limitation of liability, indemnification and jurisdiction issues defined therein. Any holder of this document is advised that information contained hereon reflects the Company's findings at the time of its intervention only and within the limits of Client's instructions, if any. The Company's sole responsibility is to its Client and this document does not exonerate parties to a transaction from exercising all their rights and obligations under the transaction documents. This document cannot be reproduced except in full, without prior written approval of the Company. Any unauthorized alteration, forgery or falsification of the content or appearance of this document is unlawful and offenders may be prosecuted to the fullest extent of the law.

| | | | |
|----------------|---------------------|--------------|------------------|
| Report Number | :ER-2021-20085 | Test Site | :SAC III Chamber |
| Operation Mode | :802.11ax20 RU full | Test Date | :2021-03-16 |
| Test Frequency | :5745 MHz | Temp./Humi. | :22.7/63 |
| Test Mode | :Bandedge CH Low | Antenna Pol. | :VERTICAL |
| EUT Pol | :H Plane | Engineer | :Ricky |

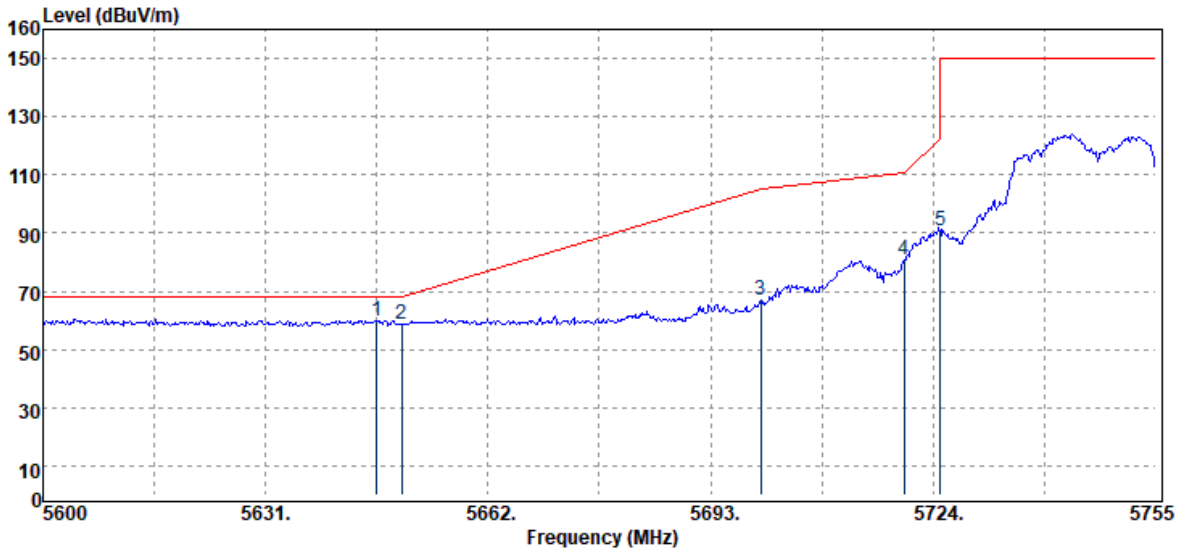

| Freq. MHz | Detector Mode PK/QP/AV | Spectrum Reading Level d μ V | Factor dB | Actual FS d μ V/m | Limit @3m d μ V/m | Margin dB |
|--------------|------------------------------|--|--------------|-----------------------------|-----------------------------|--------------|
| 5646.50 | Peak | 51.94 | 8.11 | 60.05 | 68.20 | -8.15 |
| 5650.00 | Peak | 50.65 | 8.08 | 58.73 | 68.20 | -9.47 |
| 5700.00 | Peak | 59.03 | 8.02 | 67.05 | 105.20 | -38.15 |
| 5720.00 | Peak | 72.55 | 8.10 | 80.65 | 110.80 | -30.15 |
| 5725.00 | Peak | 82.54 | 8.12 | 90.66 | 122.20 | -31.54 |

Unless otherwise stated the results shown in this test report refer only to the sample(s) tested and such sample(s) are retained for 90 days only.

除非另有說明，此報告結果僅對測試之樣品負責，同時此樣品僅保留90天。本報告未經本公司書面許可，不可部份複製。

This document is issued by the Company subject to its General Conditions of Service printed overleaf, available on request or accessible at <http://www.sgs.com.tw/Terms-and-Conditions> and for electronic format documents, subject to Terms and Conditions for Electronic Documents at <http://www.sgs.com.tw/Terms-and-Conditions>. Attention is drawn to the limitation of liability, indemnification and jurisdiction issues defined therein. Any holder of this document is advised that information contained hereon reflects the Company's findings at the time of its intervention only and within the limits of Client's instructions, if any. The Company's sole responsibility is to its Client and this document does not exonerate parties to a transaction from exercising all their rights and obligations under the transaction documents. This document cannot be reproduced except in full, without prior written approval of the Company. Any unauthorized alteration, forgery or falsification of the content or appearance of this document is unlawful and offenders may be prosecuted to the fullest extent of the law.

| | | | |
|----------------|---------------------|--------------|------------------|
| Report Number | :ER-2021-20085 | Test Site | :SAC III Chamber |
| Operation Mode | :802.11ax20 RU full | Test Date | :2021-03-16 |
| Test Frequency | :5745 MHz | Temp./Humi. | :22.7/63 |
| Test Mode | :Bandedge CH Low | Antenna Pol. | :HORIZONTAL |
| EUT Pol | :H Plane | Engineer | :Ricky |

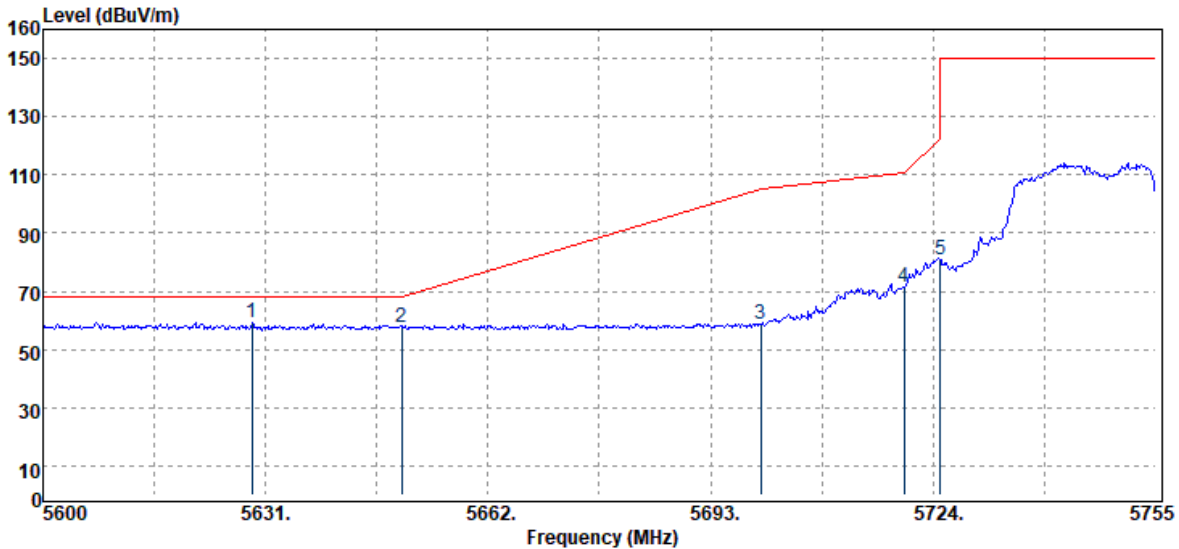

| Freq. MHz | Detector Mode PK/QP/AV | Spectrum Reading Level dB μ V | Factor dB | Actual FS dB μ V/m | Limit @3m dB μ V/m | Margin dB |
|--------------|------------------------------|---|--------------|------------------------------|------------------------------|--------------|
| 5629.14 | Peak | 51.13 | 8.23 | 59.36 | 68.20 | -8.84 |
| 5650.00 | Peak | 49.66 | 8.08 | 57.74 | 68.20 | -10.46 |
| 5700.00 | Peak | 50.72 | 8.02 | 58.74 | 105.20 | -46.46 |
| 5720.00 | Peak | 63.52 | 8.10 | 71.62 | 110.80 | -39.18 |
| 5725.00 | Peak | 72.96 | 8.12 | 81.08 | 122.20 | -41.12 |

Unless otherwise stated the results shown in this test report refer only to the sample(s) tested and such sample(s) are retained for 90 days only.

除非另有說明，此報告結果僅對測試之樣品負責，同時此樣品僅保留90天。本報告未經本公司書面許可，不可部份複製。

This document is issued by the Company subject to its General Conditions of Service printed overleaf, available on request or accessible at <http://www.sgs.com.tw/Terms-and-Conditions> and for electronic format documents, subject to Terms and Conditions for Electronic Documents at <http://www.sgs.com.tw/Terms-and-Conditions>. Attention is drawn to the limitation of liability, indemnification and jurisdiction issues defined therein. Any holder of this document is advised that information contained hereon reflects the Company's findings at the time of its intervention only and within the limits of Client's instructions, if any. The Company's sole responsibility is to its Client and this document does not exonerate parties to a transaction from exercising all their rights and obligations under the transaction documents. This document cannot be reproduced except in full, without prior written approval of the Company. Any unauthorized alteration, forgery or falsification of the content or appearance of this document is unlawful and offenders may be prosecuted to the fullest extent of the law.

| | | | |
|----------------|---------------------|--------------|------------------|
| Report Number | :ER-2021-20085 | Test Site | :SAC III Chamber |
| Operation Mode | :802.11ax20 RU 26/0 | Test Date | :2021-03-16 |
| Test Frequency | :5745 MHz | Temp./Humi. | :22.7/63 |
| Test Mode | :Bandedge CH Low | Antenna Pol. | :VERTICAL |
| EUT Pol | :H Plane | Engineer | :Ricky |

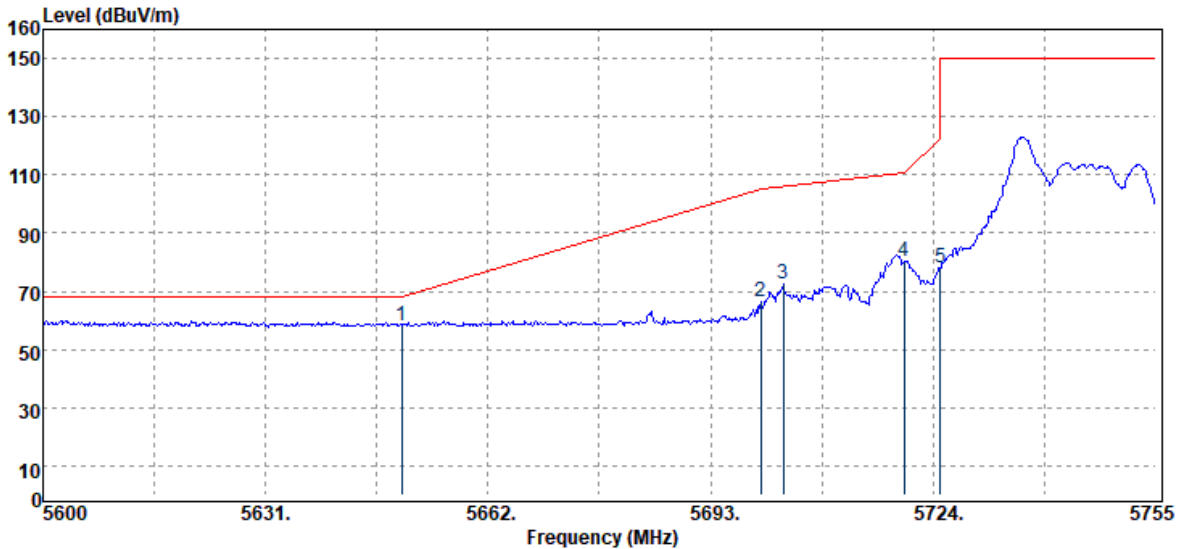

| Freq. MHz | Detector Mode PK/QP/AV | Spectrum Reading Level dBμV | Factor dB | Actual FS dBμV/m | Limit @3m dBμV/m | Margin dB |
|--------------|------------------------------|-----------------------------------|--------------|------------------------|------------------------|--------------|
| 5650.00 | Peak | 50.29 | 8.08 | 58.37 | 68.20 | -9.83 |
| 5700.00 | Peak | 58.34 | 8.02 | 66.36 | 105.20 | -38.84 |
| 5703.08 | Peak | 64.33 | 8.04 | 72.37 | 106.06 | -33.69 |
| 5720.00 | Peak | 71.97 | 8.10 | 80.07 | 110.80 | -30.73 |
| 5725.00 | Peak | 69.85 | 8.12 | 77.97 | 122.20 | -44.23 |

Unless otherwise stated the results shown in this test report refer only to the sample(s) tested and such sample(s) are retained for 90 days only.

除非另有說明，此報告結果僅對測試之樣品負責，同時此樣品僅保留90天。本報告未經本公司書面許可，不可部份複製。

This document is issued by the Company subject to its General Conditions of Service printed overleaf, available on request or accessible at <http://www.sgs.com.tw/Terms-and-Conditions> and for electronic format documents, subject to Terms and Conditions for Electronic Documents at <http://www.sgs.com.tw/Terms-and-Conditions>. Attention is drawn to the limitation of liability, indemnification and jurisdiction issues defined therein. Any holder of this document is advised that information contained hereon reflects the Company's findings at the time of its intervention only and within the limits of Client's instructions, if any. The Company's sole responsibility is to its Client and this document does not exonerate parties to a transaction from exercising all their rights and obligations under the transaction documents. This document cannot be reproduced except in full, without prior written approval of the Company. Any unauthorized alteration, forgery or falsification of the content or appearance of this document is unlawful and offenders may be prosecuted to the fullest extent of the law.

| | | | |
|----------------|---------------------|--------------|------------------|
| Report Number | :ER-2021-20085 | Test Site | :SAC III Chamber |
| Operation Mode | :802.11ax20 RU 26/0 | Test Date | :2021-03-16 |
| Test Frequency | :5745 MHz | Temp./Humi. | :22.7/63 |
| Test Mode | :Bandedge CH Low | Antenna Pol. | :HORIZONTAL |
| EUT Pol | :H Plane | Engineer | :Ricky |

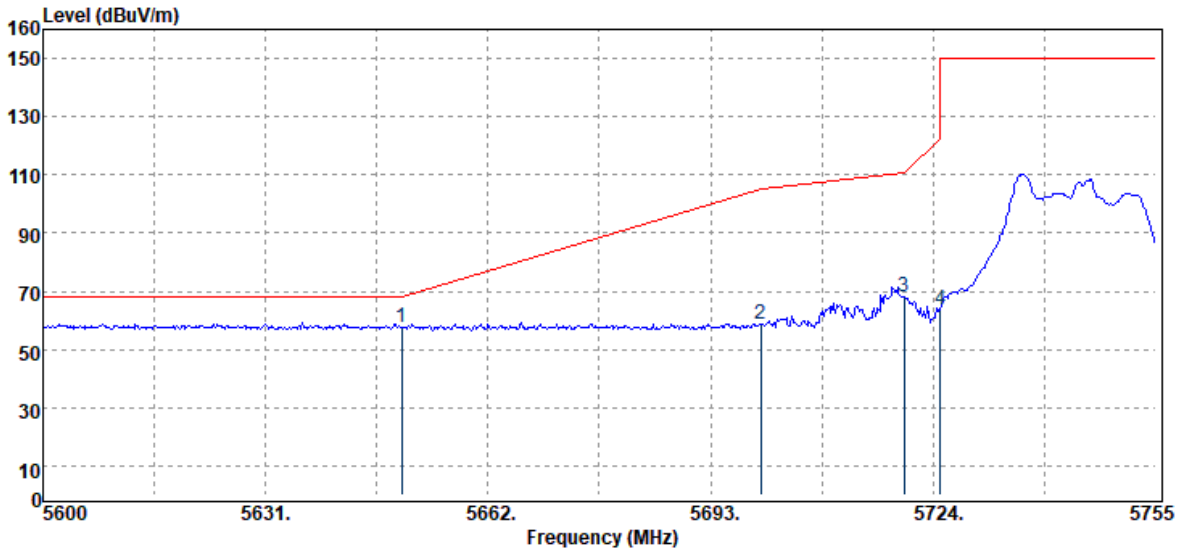

| Freq. MHz | Detector Mode PK/QP/AV | Spectrum Reading Level dB μ V | Factor dB | Actual FS dB μ V/m | Limit @3m dB μ V/m | Margin dB |
|--------------|------------------------------|---|--------------|------------------------------|------------------------------|--------------|
| 5650.00 | Peak | 49.42 | 8.08 | 57.50 | 68.20 | -10.70 |
| 5700.00 | Peak | 50.77 | 8.02 | 58.79 | 105.20 | -46.41 |
| 5720.00 | Peak | 59.86 | 8.10 | 67.96 | 110.80 | -42.84 |
| 5725.00 | Peak | 55.76 | 8.12 | 63.88 | 122.20 | -58.32 |

Unless otherwise stated the results shown in this test report refer only to the sample(s) tested and such sample(s) are retained for 90 days only.

除非另有說明，此報告結果僅對測試之樣品負責，同時此樣品僅保留90天。本報告未經本公司書面許可，不可部份複製。

This document is issued by the Company subject to its General Conditions of Service printed overleaf, available on request or accessible at <http://www.sgs.com.tw/Terms-and-Conditions> and for electronic format documents, subject to Terms and Conditions for Electronic Documents at <http://www.sgs.com.tw/Terms-and-Conditions>. Attention is drawn to the limitation of liability, indemnification and jurisdiction issues defined therein. Any holder of this document is advised that information contained hereon reflects the Company's findings at the time of its intervention only and within the limits of Client's instructions, if any. The Company's sole responsibility is to its Client and this document does not exonerate parties to a transaction from exercising all their rights and obligations under the transaction documents. This document cannot be reproduced except in full, without prior written approval of the Company. Any unauthorized alteration, forgery or falsification of the content or appearance of this document is unlawful and offenders may be prosecuted to the fullest extent of the law.

| | | | |
|----------------|----------------------|--------------|------------------|
| Report Number | :ER-2021-20085 | Test Site | :SAC III Chamber |
| Operation Mode | :802.11ax20 RU 52/37 | Test Date | :2021-03-16 |
| Test Frequency | :5745 MHz | Temp./Humi. | :22.7/63 |
| Test Mode | :Bandedge CH Low | Antenna Pol. | :VERTICAL |
| EUT Pol | :H Plane | Engineer | :Ricky |

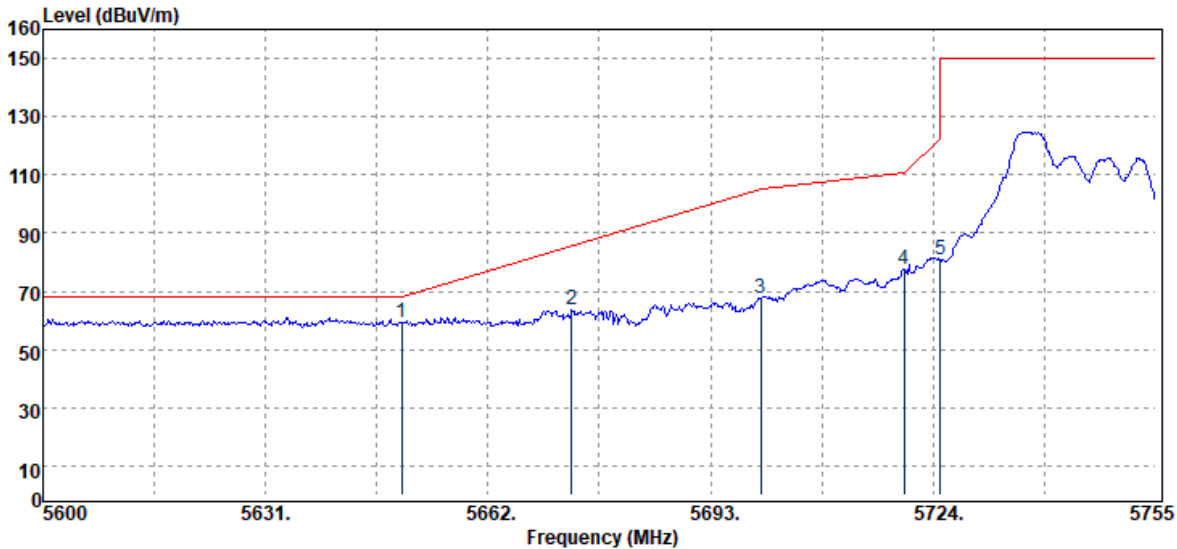

| Freq. MHz | Detector Mode PK/QP/AV | Spectrum Reading Level dB μ V | Factor dB | Actual FS dB μ V/m | Limit @3m dB μ V/m | Margin dB |
|--------------|------------------------------|---|--------------|------------------------------|------------------------------|--------------|
| 5650.00 | Peak | 50.91 | 8.08 | 58.99 | 68.20 | -9.21 |
| 5673.63 | Peak | 55.68 | 8.05 | 63.73 | 85.68 | -21.95 |
| 5700.00 | Peak | 59.42 | 8.02 | 67.44 | 105.20 | -37.76 |
| 5720.00 | Peak | 69.17 | 8.10 | 77.27 | 110.80 | -33.53 |
| 5725.00 | Peak | 72.57 | 8.12 | 80.69 | 122.20 | -41.51 |

Unless otherwise stated the results shown in this test report refer only to the sample(s) tested and such sample(s) are retained for 90 days only.

除非另有說明，此報告結果僅對測試之樣品負責，同時此樣品僅保留90天。本報告未經本公司書面許可，不可部份複製。

This document is issued by the Company subject to its General Conditions of Service printed overleaf, available on request or accessible at <http://www.sgs.com.tw/Terms-and-Conditions> and for electronic format documents, subject to Terms and Conditions for Electronic Documents at <http://www.sgs.com.tw/Terms-and-Conditions>. Attention is drawn to the limitation of liability, indemnification and jurisdiction issues defined therein. Any holder of this document is advised that information contained hereon reflects the Company's findings at the time of its intervention only and within the limits of Client's instructions, if any. The Company's sole responsibility is to its Client and this document does not exonerate parties to a transaction from exercising all their rights and obligations under the transaction documents. This document cannot be reproduced except in full, without prior written approval of the Company. Any unauthorized alteration, forgery or falsification of the content or appearance of this document is unlawful and offenders may be prosecuted to the fullest extent of the law.

| | | | |
|----------------|----------------------|--------------|------------------|
| Report Number | :ER-2021-20085 | Test Site | :SAC III Chamber |
| Operation Mode | :802.11ax20 RU 52/37 | Test Date | :2021-03-16 |
| Test Frequency | :5745 MHz | Temp./Humi. | :22.7/63 |
| Test Mode | :Bandedge CH Low | Antenna Pol. | :HORIZONTAL |
| EUT Pol | :H Plane | Engineer | :Ricky |

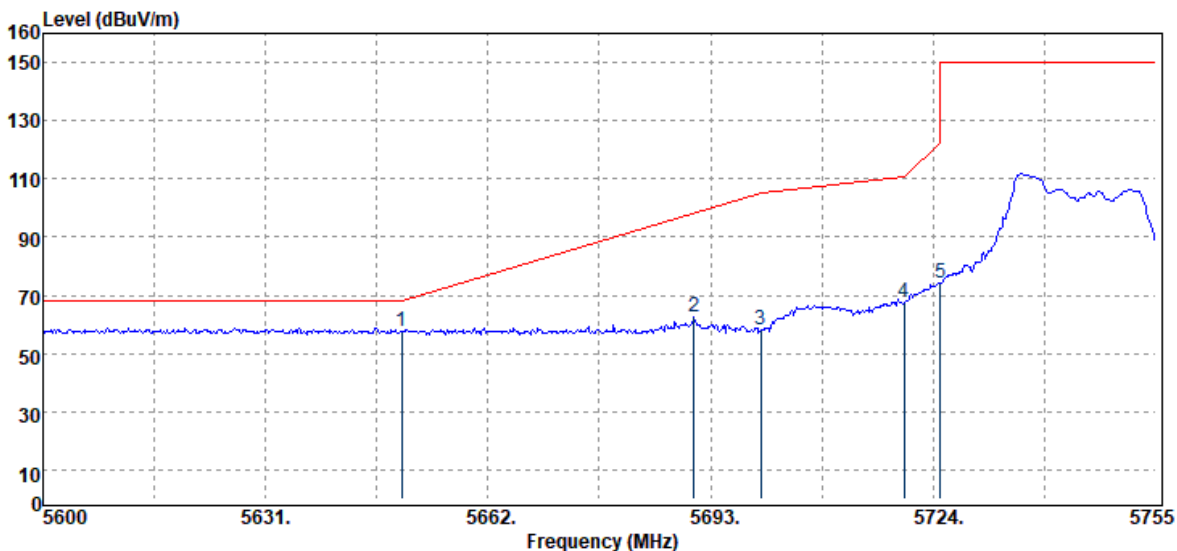

| Freq. MHz | Detector Mode PK/QP/AV | Spectrum Reading Level dB μ V | Factor dB | Actual FS dB μ V/m | Limit @3m dB μ V/m | Margin dB |
|--------------|------------------------------|---|--------------|------------------------------|------------------------------|--------------|
| 5650.00 | Peak | 49.61 | 8.08 | 57.69 | 68.20 | -10.51 |
| 5690.68 | Peak | 54.37 | 8.03 | 62.40 | 98.30 | -35.90 |
| 5700.00 | Peak | 49.99 | 8.02 | 58.01 | 105.20 | -47.19 |
| 5720.00 | Peak | 59.46 | 8.10 | 67.56 | 110.80 | -43.24 |
| 5725.00 | Peak | 66.22 | 8.12 | 74.34 | 122.20 | -47.86 |

Unless otherwise stated the results shown in this test report refer only to the sample(s) tested and such sample(s) are retained for 90 days only.

除非另有說明，此報告結果僅對測試之樣品負責，同時此樣品僅保留90天。本報告未經本公司書面許可，不可部份複製。

This document is issued by the Company subject to its General Conditions of Service printed overleaf, available on request or accessible at <http://www.sgs.com.tw/Terms-and-Conditions> and for electronic format documents, subject to Terms and Conditions for Electronic Documents at <http://www.sgs.com.tw/Terms-and-Conditions>. Attention is drawn to the limitation of liability, indemnification and jurisdiction issues defined therein. Any holder of this document is advised that information contained hereon reflects the Company's findings at the time of its intervention only and within the limits of Client's instructions, if any. The Company's sole responsibility is to its Client and this document does not exonerate parties to a transaction from exercising all their rights and obligations under the transaction documents. This document cannot be reproduced except in full, without prior written approval of the Company. Any unauthorized alteration, forgery or falsification of the content or appearance of this document is unlawful and offenders may be prosecuted to the fullest extent of the law.

| | | | |
|----------------|-----------------------|--------------|------------------|
| Report Number | :ER-2021-20085 | Test Site | :SAC III Chamber |
| Operation Mode | :802.11ax20 RU 106/54 | Test Date | :2021-03-16 |
| Test Frequency | :5745 MHz | Temp./Humi. | :22.7/63 |
| Test Mode | :Bandedge CH Low | Antenna Pol. | :VERTICAL |
| EUT Pol | :H Plane | Engineer | :Ricky |

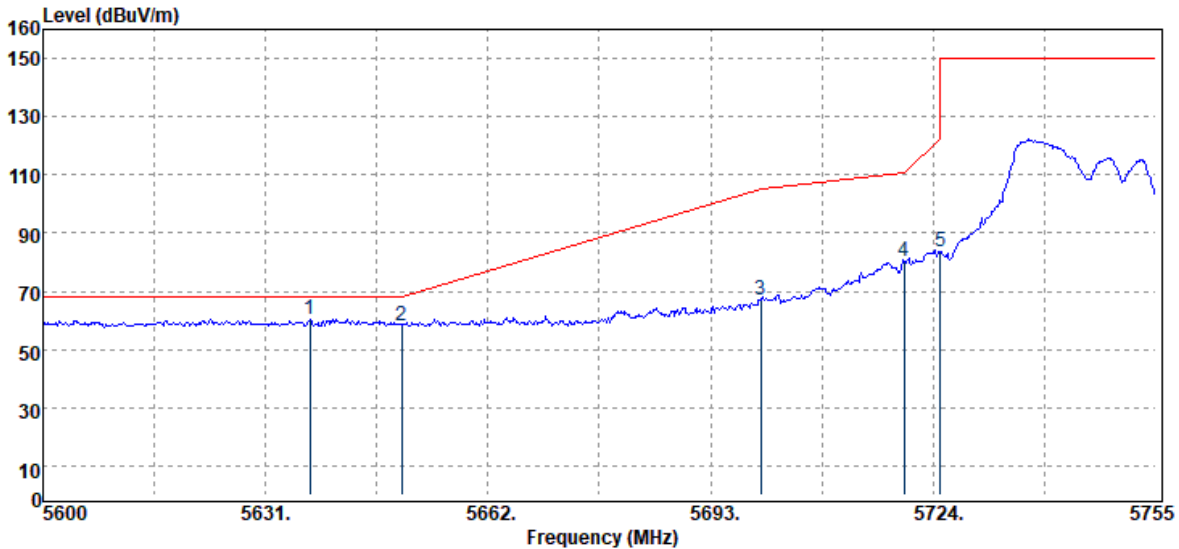

| Freq. MHz | Detector Mode PK/QP/AV | Spectrum Reading Level dBµV | Factor dB | Actual FS dBµV/m | Limit @3m dBµV/m | Margin dB |
|--------------|------------------------------|-----------------------------------|--------------|------------------------|------------------------|--------------|
| 5637.20 | Peak | 52.23 | 8.18 | 60.41 | 68.20 | -7.79 |
| 5650.00 | Peak | 50.24 | 8.08 | 58.32 | 68.20 | -9.88 |
| 5700.00 | Peak | 58.88 | 8.02 | 66.90 | 105.20 | -38.30 |
| 5720.00 | Peak | 71.92 | 8.10 | 80.02 | 110.80 | -30.78 |
| 5725.00 | Peak | 75.54 | 8.12 | 83.66 | 122.20 | -38.54 |

Unless otherwise stated the results shown in this test report refer only to the sample(s) tested and such sample(s) are retained for 90 days only.

除非另有說明，此報告結果僅對測試之樣品負責，同時此樣品僅保留90天。本報告未經本公司書面許可，不可部份複製。

This document is issued by the Company subject to its General Conditions of Service printed overleaf, available on request or accessible at <http://www.sgs.com.tw/Terms-and-Conditions> and for electronic format documents, subject to Terms and Conditions for Electronic Documents at <http://www.sgs.com.tw/Terms-and-Conditions>. Attention is drawn to the limitation of liability, indemnification and jurisdiction issues defined therein. Any holder of this document is advised that information contained hereon reflects the Company's findings at the time of its intervention only and within the limits of Client's instructions, if any. The Company's sole responsibility is to its Client and this document does not exonerate parties to a transaction from exercising all their rights and obligations under the transaction documents. This document cannot be reproduced except in full, without prior written approval of the Company. Any unauthorized alteration, forgery or falsification of the content or appearance of this document is unlawful and offenders may be prosecuted to the fullest extent of the law.

| | | | |
|----------------|-----------------------|--------------|------------------|
| Report Number | :ER-2021-20085 | Test Site | :SAC III Chamber |
| Operation Mode | :802.11ax20 RU 106/54 | Test Date | :2021-03-16 |
| Test Frequency | :5745 MHz | Temp./Humi. | :22.7/63 |
| Test Mode | :Bandedge CH Low | Antenna Pol. | :HORIZONTAL |
| EUT Pol | :H Plane | Engineer | :Ricky |

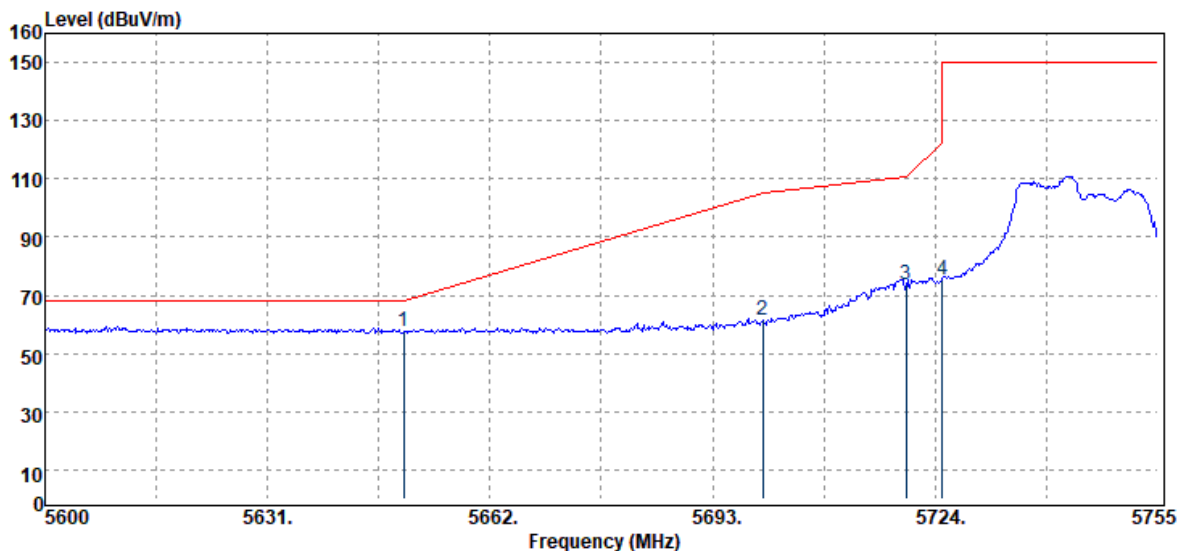

| Freq. MHz | Detector Mode PK/QP/AV | Spectrum Reading Level dB μ V | Factor dB | Actual FS dB μ V/m | Limit @3m dB μ V/m | Margin dB |
|--------------|------------------------------|---|--------------|------------------------------|------------------------------|--------------|
| 5650.00 | Peak | 49.55 | 8.08 | 57.63 | 68.20 | -10.57 |
| 5700.00 | Peak | 53.21 | 8.02 | 61.23 | 105.20 | -43.97 |
| 5720.00 | Peak | 65.37 | 8.10 | 73.47 | 110.80 | -37.33 |
| 5725.00 | Peak | 67.37 | 8.12 | 75.49 | 122.20 | -46.71 |

Unless otherwise stated the results shown in this test report refer only to the sample(s) tested and such sample(s) are retained for 90 days only.

除非另有說明，此報告結果僅對測試之樣品負責，同時此樣品僅保留90天。本報告未經本公司書面許可，不可部份複製。

This document is issued by the Company subject to its General Conditions of Service printed overleaf, available on request or accessible at <http://www.sgs.com.tw/Terms-and-Conditions> and for electronic format documents, subject to Terms and Conditions for Electronic Documents at <http://www.sgs.com.tw/Terms-and-Conditions>. Attention is drawn to the limitation of liability, indemnification and jurisdiction issues defined therein. Any holder of this document is advised that information contained hereon reflects the Company's findings at the time of its intervention only and within the limits of Client's instructions, if any. The Company's sole responsibility is to its Client and this document does not exonerate parties to a transaction from exercising all their rights and obligations under the transaction documents. This document cannot be reproduced except in full, without prior written approval of the Company. Any unauthorized alteration, forgery or falsification of the content or appearance of this document is unlawful and offenders may be prosecuted to the fullest extent of the law.

| | | | |
|----------------|---------------------|--------------|------------------|
| Report Number | :ER-2021-20085 | Test Site | :SAC III Chamber |
| Operation Mode | :802.11ax20 RU full | Test Date | :2021-03-16 |
| Test Frequency | :5825 MHz | Temp./Humi. | :22.7/63 |
| Test Mode | :Bandedge CH High | Antenna Pol. | :VERTICAL |
| EUT Pol | :H Plane | Engineer | :Ricky |

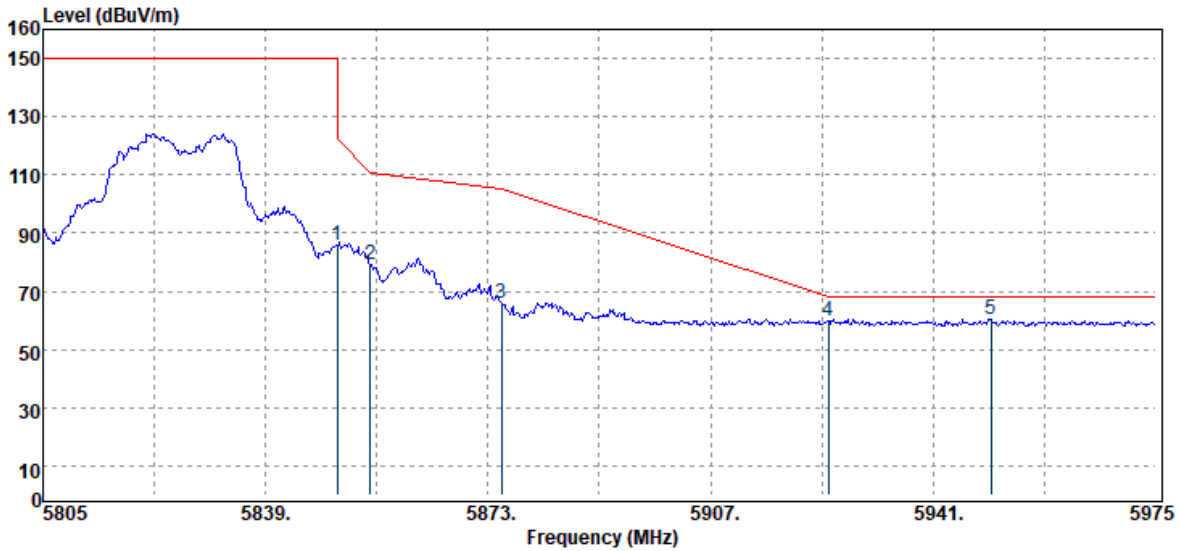

| Freq. MHz | Detector Mode PK/QP/AV | Spectrum Reading Level dB μ V | Factor dB | Actual FS dB μ V/m | Limit @3m dB μ V/m | Margin dB |
|--------------|------------------------------|---|--------------|------------------------------|------------------------------|--------------|
| 5850.00 | Peak | 76.63 | 9.02 | 85.65 | 122.20 | -36.55 |
| 5855.00 | Peak | 70.27 | 9.07 | 79.34 | 110.80 | -31.46 |
| 5875.00 | Peak | 56.67 | 9.27 | 65.94 | 105.20 | -39.26 |
| 5925.00 | Peak | 50.07 | 9.70 | 59.77 | 68.20 | -8.43 |
| 5949.84 | Peak | 50.69 | 9.88 | 60.57 | 68.20 | -7.63 |

Unless otherwise stated the results shown in this test report refer only to the sample(s) tested and such sample(s) are retained for 90 days only.

除非另有說明，此報告結果僅對測試之樣品負責，同時此樣品僅保留90天。本報告未經本公司書面許可，不可部份複製。

This document is issued by the Company subject to its General Conditions of Service printed overleaf, available on request or accessible at <http://www.sgs.com.tw/Terms-and-Conditions> and for electronic format documents, subject to Terms and Conditions for Electronic Documents at <http://www.sgs.com.tw/Terms-and-Conditions>. Attention is drawn to the limitation of liability, indemnification and jurisdiction issues defined therein. Any holder of this document is advised that information contained hereon reflects the Company's findings at the time of its intervention only and within the limits of Client's instructions, if any. The Company's sole responsibility is to its Client and this document does not exonerate parties to a transaction from exercising all their rights and obligations under the transaction documents. This document cannot be reproduced except in full, without prior written approval of the Company. Any unauthorized alteration, forgery or falsification of the content or appearance of this document is unlawful and offenders may be prosecuted to the fullest extent of the law.

| | | | |
|----------------|---------------------|--------------|------------------|
| Report Number | :ER-2021-20085 | Test Site | :SAC III Chamber |
| Operation Mode | :802.11ax20 RU full | Test Date | :2021-03-16 |
| Test Frequency | :5825 MHz | Temp./Humi. | :22.7/63 |
| Test Mode | :Bandedge CH High | Antenna Pol. | :HORIZONTAL |
| EUT Pol | :H Plane | Engineer | :Ricky |

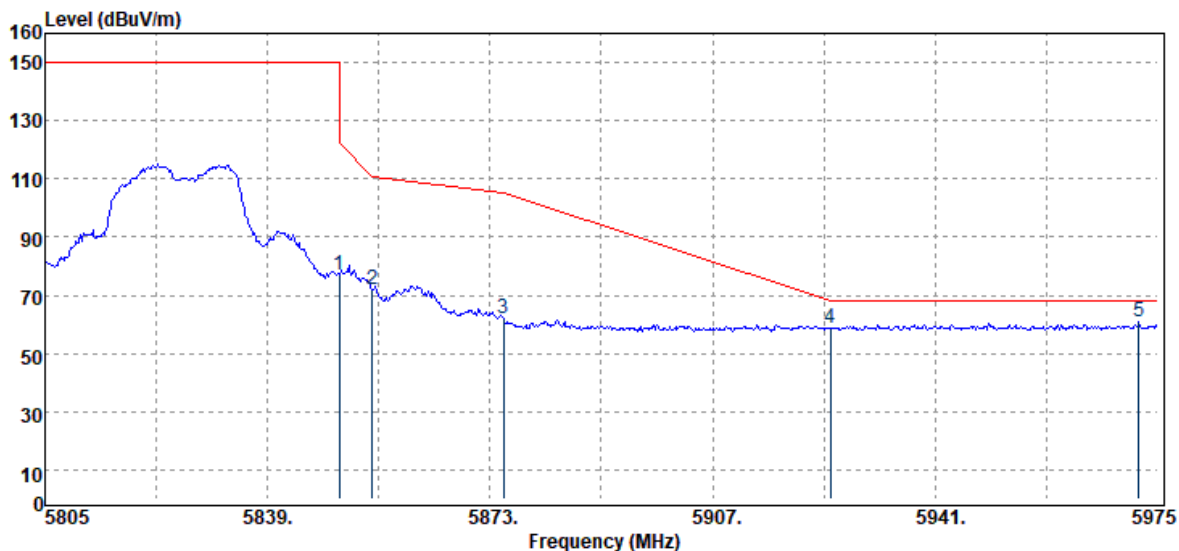

| Freq. MHz | Detector Mode PK/QP/AV | Spectrum Reading Level dB μ V | Factor dB | Actual FS dB μ V/m | Limit @3m dB μ V/m | Margin dB |
|--------------|------------------------------|---|--------------|------------------------------|------------------------------|--------------|
| 5850.00 | Peak | 68.17 | 9.02 | 77.19 | 122.20 | -45.01 |
| 5855.00 | Peak | 63.16 | 9.07 | 72.23 | 110.80 | -38.57 |
| 5875.00 | Peak | 52.58 | 9.27 | 61.85 | 105.20 | -43.35 |
| 5925.00 | Peak | 49.02 | 9.70 | 58.72 | 68.20 | -9.48 |
| 5972.11 | Peak | 51.16 | 9.99 | 61.15 | 68.20 | -7.05 |

Unless otherwise stated the results shown in this test report refer only to the sample(s) tested and such sample(s) are retained for 90 days only.

除非另有說明，此報告結果僅對測試之樣品負責，同時此樣品僅保留90天。本報告未經本公司書面許可，不可部份複製。

This document is issued by the Company subject to its General Conditions of Service printed overleaf, available on request or accessible at <http://www.sgs.com.tw/Terms-and-Conditions> and for electronic format documents, subject to Terms and Conditions for Electronic Documents at <http://www.sgs.com.tw/Terms-and-Conditions>. Attention is drawn to the limitation of liability, indemnification and jurisdiction issues defined therein. Any holder of this document is advised that information contained hereon reflects the Company's findings at the time of its intervention only and within the limits of Client's instructions, if any. The Company's sole responsibility is to its Client and this document does not exonerate parties to a transaction from exercising all their rights and obligations under the transaction documents. This document cannot be reproduced except in full, without prior written approval of the Company. Any unauthorized alteration, forgery or falsification of the content or appearance of this document is unlawful and offenders may be prosecuted to the fullest extent of the law.

| | | | |
|----------------|---------------------|--------------|------------------|
| Report Number | :ER-2021-20085 | Test Site | :SAC III Chamber |
| Operation Mode | :802.11ax20 RU 26/8 | Test Date | :2021-03-16 |
| Test Frequency | :5825 MHz | Temp./Humi. | :22.7/63 |
| Test Mode | :Bandedge CH High | Antenna Pol. | :VERTICAL |
| EUT Pol | :H Plane | Engineer | :Ricky |

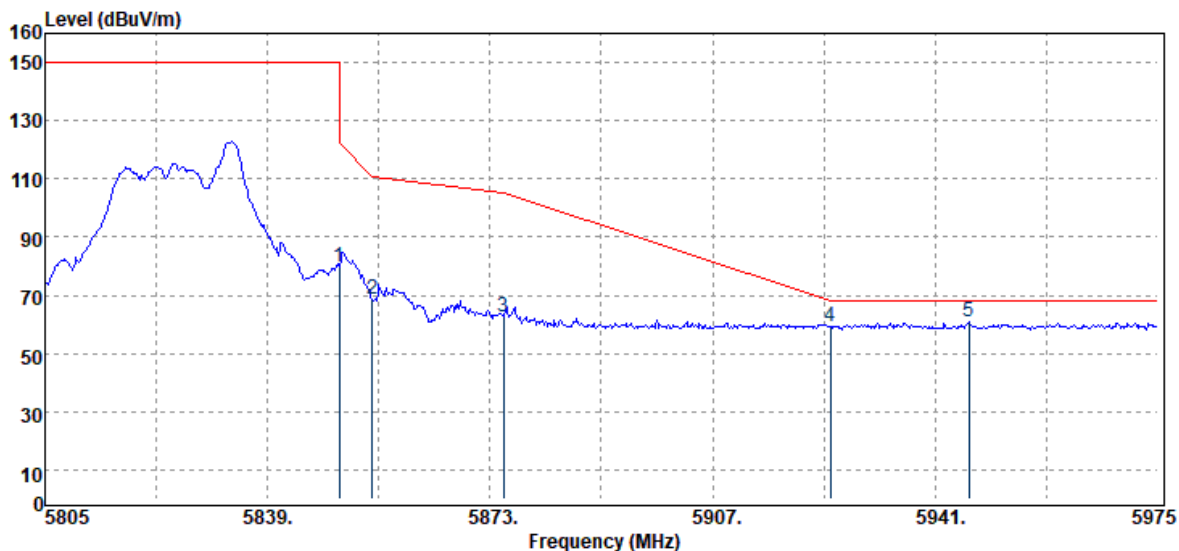

| Freq. MHz | Detector Mode PK/QP/AV | Spectrum Reading Level dB μ V | Factor dB | Actual FS dB μ V/m | Limit @3m dB μ V/m | Margin dB |
|--------------|------------------------------|---|--------------|------------------------------|------------------------------|--------------|
| 5850.00 | Peak | 70.85 | 9.02 | 79.87 | 122.20 | -42.33 |
| 5855.00 | Peak | 59.83 | 9.07 | 68.90 | 110.80 | -41.90 |
| 5875.00 | Peak | 53.14 | 9.27 | 62.41 | 105.20 | -42.79 |
| 5925.00 | Peak | 49.32 | 9.70 | 59.02 | 68.20 | -9.18 |
| 5946.10 | Peak | 51.03 | 9.85 | 60.88 | 68.20 | -7.32 |

Unless otherwise stated the results shown in this test report refer only to the sample(s) tested and such sample(s) are retained for 90 days only.

除非另有說明，此報告結果僅對測試之樣品負責，同時此樣品僅保留90天。本報告未經本公司書面許可，不可部份複製。

This document is issued by the Company subject to its General Conditions of Service printed overleaf, available on request or accessible at <http://www.sgs.com.tw/Terms-and-Conditions> and for electronic format documents, subject to Terms and Conditions for Electronic Documents at <http://www.sgs.com.tw/Terms-and-Conditions>. Attention is drawn to the limitation of liability, indemnification and jurisdiction issues defined therein. Any holder of this document is advised that information contained hereon reflects the Company's findings at the time of its intervention only and within the limits of Client's instructions, if any. The Company's sole responsibility is to its Client and this document does not exonerate parties to a transaction from exercising all their rights and obligations under the transaction documents. This document cannot be reproduced except in full, without prior written approval of the Company. Any unauthorized alteration, forgery or falsification of the content or appearance of this document is unlawful and offenders may be prosecuted to the fullest extent of the law.

Report Number :ER-2021-20085
 Operation Mode :802.11ax20 RU 26/8
 Test Frequency :5825 MHz
 Test Mode :Bandedge CH High
 EUT Pol :H Plane

Test Site :SAC III Chamber
 Test Date :2021-03-16
 Temp./Humi. :22.7/63
 Antenna Pol. :HORIZONTAL
 Engineer :Ricky

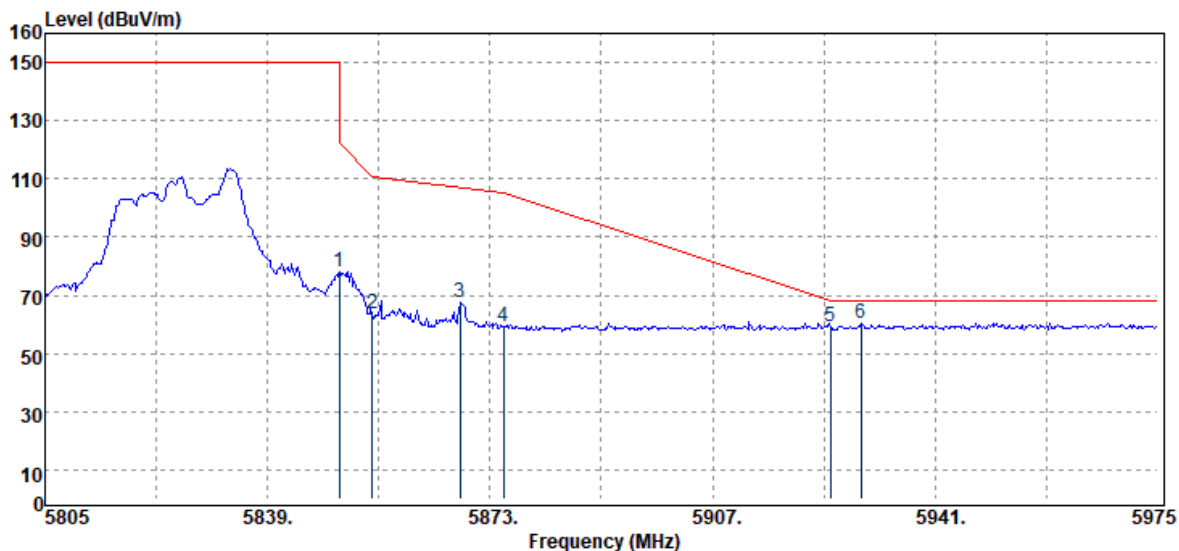

| Freq. MHz | Detector Mode PK/QP/AV | Spectrum Reading Level dB μ V | Factor dB | Actual FS dB μ V/m | Limit @3m dB μ V/m | Margin dB |
|--------------|------------------------------|---|--------------|------------------------------|------------------------------|--------------|
| 5850.00 | Peak | 69.28 | 9.02 | 78.30 | 122.20 | -43.90 |
| 5855.00 | Peak | 54.84 | 9.07 | 63.91 | 110.80 | -46.89 |
| 5868.41 | Peak | 58.53 | 9.21 | 67.74 | 107.05 | -39.31 |
| 5875.00 | Peak | 49.80 | 9.27 | 59.07 | 105.20 | -46.13 |
| 5925.00 | Peak | 49.49 | 9.70 | 59.19 | 68.20 | -9.01 |
| 5929.61 | Peak | 50.66 | 9.74 | 60.40 | 68.20 | -7.80 |

Unless otherwise stated the results shown in this test report refer only to the sample(s) tested and such sample(s) are retained for 90 days only.

除非另有說明，此報告結果僅對測試之樣品負責，同時此樣品僅保留90天。本報告未經本公司書面許可，不可部份複製。

This document is issued by the Company subject to its General Conditions of Service printed overleaf, available on request or accessible at <http://www.sgs.com.tw/Terms-and-Conditions> and for electronic format documents, subject to Terms and Conditions for Electronic Documents at <http://www.sgs.com.tw/Terms-and-Conditions>. Attention is drawn to the limitation of liability, indemnification and jurisdiction issues defined therein. Any holder of this document is advised that information contained hereon reflects the Company's findings at the time of its intervention only and within the limits of Client's instructions, if any. The Company's sole responsibility is to its Client and this document does not exonerate parties to a transaction from exercising all their rights and obligations under the transaction documents. This document cannot be reproduced except in full, without prior written approval of the Company. Any unauthorized alteration, forgery or falsification of the content or appearance of this document is unlawful and offenders may be prosecuted to the fullest extent of the law.

| | | | |
|----------------|----------------------|--------------|------------------|
| Report Number | :ER-2021-20085 | Test Site | :SAC III Chamber |
| Operation Mode | :802.11ax20 RU 52/40 | Test Date | :2021-03-16 |
| Test Frequency | :5825 MHz | Temp./Humi. | :22.7/63 |
| Test Mode | :Bandedge CH High | Antenna Pol. | :VERTICAL |
| EUT Pol | :H Plane | Engineer | :Ricky |

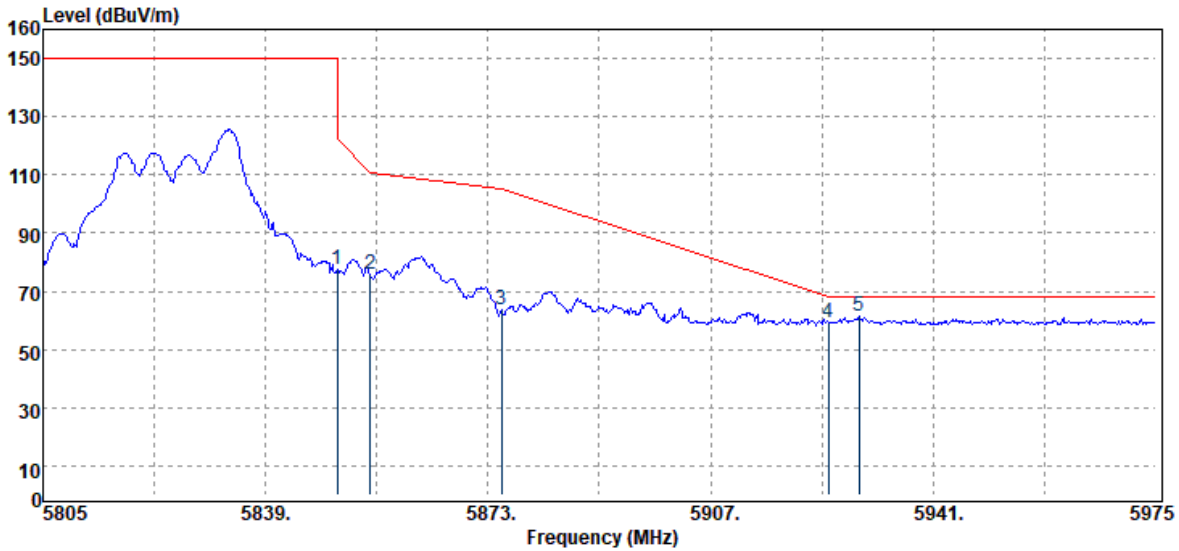

| Freq. MHz | Detector Mode PK/QP/AV | Spectrum Reading Level dB μ V | Factor dB | Actual FS dB μ V/m | Limit @3m dB μ V/m | Margin dB |
|--------------|------------------------------|---|--------------|------------------------------|------------------------------|--------------|
| 5850.00 | Peak | 68.70 | 9.02 | 77.72 | 122.20 | -44.48 |
| 5855.00 | Peak | 66.57 | 9.07 | 75.64 | 110.80 | -35.16 |
| 5875.00 | Peak | 54.54 | 9.27 | 63.81 | 105.20 | -41.39 |
| 5925.00 | Peak | 49.72 | 9.70 | 59.42 | 68.20 | -8.78 |
| 5929.61 | Peak | 51.46 | 9.74 | 61.20 | 68.20 | -7.00 |

Unless otherwise stated the results shown in this test report refer only to the sample(s) tested and such sample(s) are retained for 90 days only.

除非另有說明，此報告結果僅對測試之樣品負責，同時此樣品僅保留90天。本報告未經本公司書面許可，不可部份複製。

This document is issued by the Company subject to its General Conditions of Service printed overleaf, available on request or accessible at <http://www.sgs.com.tw/Terms-and-Conditions> and for electronic format documents, subject to Terms and Conditions for Electronic Documents at <http://www.sgs.com.tw/Terms-and-Conditions>. Attention is drawn to the limitation of liability, indemnification and jurisdiction issues defined therein. Any holder of this document is advised that information contained hereon reflects the Company's findings at the time of its intervention only and within the limits of Client's instructions, if any. The Company's sole responsibility is to its Client and this document does not exonerate parties to a transaction from exercising all their rights and obligations under the transaction documents. This document cannot be reproduced except in full, without prior written approval of the Company. Any unauthorized alteration, forgery or falsification of the content or appearance of this document is unlawful and offenders may be prosecuted to the fullest extent of the law.

Report Number :ER-2021-20085
 Operation Mode :802.11ax20 RU 52/40
 Test Frequency :5825 MHz
 Test Mode :Bandedge CH High
 EUT Pol :H Plane

Test Site :SAC III Chamber
 Test Date :2021-03-16
 Temp./Humi. :22.7/63
 Antenna Pol. :HORIZONTAL
 Engineer :Ricky

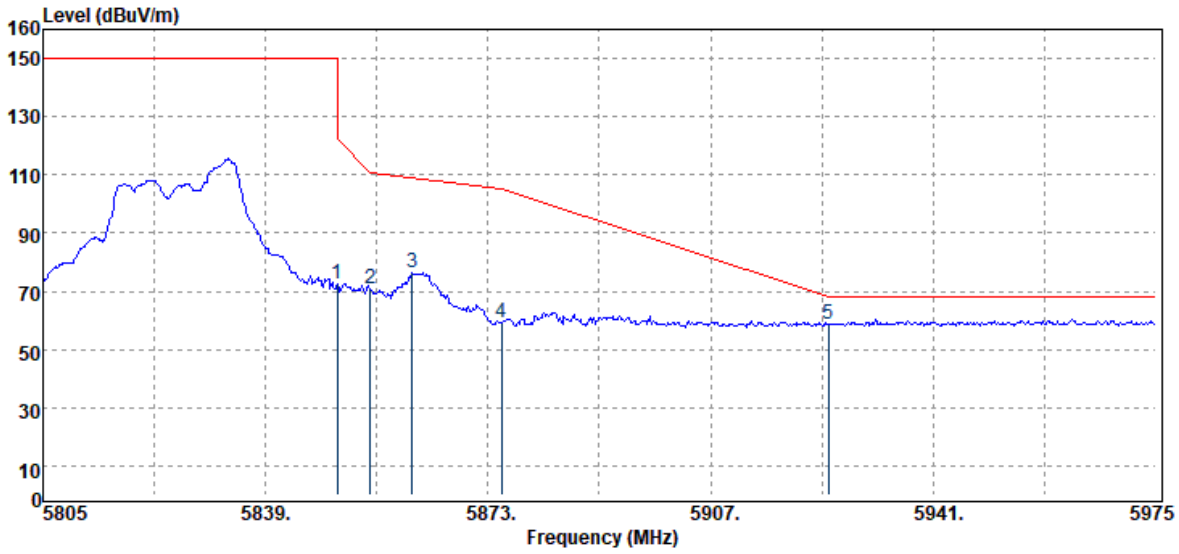

| Freq. MHz | Detector Mode PK/QP/AV | Spectrum Reading Level dB μ V | Factor dB | Actual FS dB μ V/m | Limit @3m dB μ V/m | Margin dB |
|--------------|------------------------------|---|--------------|------------------------------|------------------------------|--------------|
| 5850.00 | Peak | 63.52 | 9.02 | 72.54 | 122.20 | -49.66 |
| 5855.00 | Peak | 61.92 | 9.07 | 70.99 | 110.80 | -39.81 |
| 5861.44 | Peak | 67.20 | 9.14 | 76.34 | 109.00 | -32.66 |
| 5875.00 | Peak | 49.79 | 9.27 | 59.06 | 105.20 | -46.14 |
| 5925.00 | Peak | 48.91 | 9.70 | 58.61 | 68.20 | -9.59 |

Unless otherwise stated the results shown in this test report refer only to the sample(s) tested and such sample(s) are retained for 90 days only.

除非另有說明，此報告結果僅對測試之樣品負責，同時此樣品僅保留90天。本報告未經本公司書面許可，不可部份複製。

This document is issued by the Company subject to its General Conditions of Service printed overleaf, available on request or accessible at <http://www.sgs.com.tw/Terms-and-Conditions> and for electronic format documents, subject to Terms and Conditions for Electronic Documents at <http://www.sgs.com.tw/Terms-and-Conditions>. Attention is drawn to the limitation of liability, indemnification and jurisdiction issues defined therein. Any holder of this document is advised that information contained hereon reflects the Company's findings at the time of its intervention only and within the limits of Client's instructions, if any. The Company's sole responsibility is to its Client and this document does not exonerate parties to a transaction from exercising all their rights and obligations under the transaction documents. This document cannot be reproduced except in full, without prior written approval of the Company. Any unauthorized alteration, forgery or falsification of the content or appearance of this document is unlawful and offenders may be prosecuted to the fullest extent of the law.

| | | | |
|----------------|-----------------------|--------------|------------------|
| Report Number | :ER-2021-20085 | Test Site | :SAC III Chamber |
| Operation Mode | :802.11ax20 RU 106/54 | Test Date | :2021-03-16 |
| Test Frequency | :5825 MHz | Temp./Humi. | :22.7/63 |
| Test Mode | :Bandedge CH High | Antenna Pol. | :VERTICAL |
| EUT Pol | :H Plane | Engineer | :Ricky |

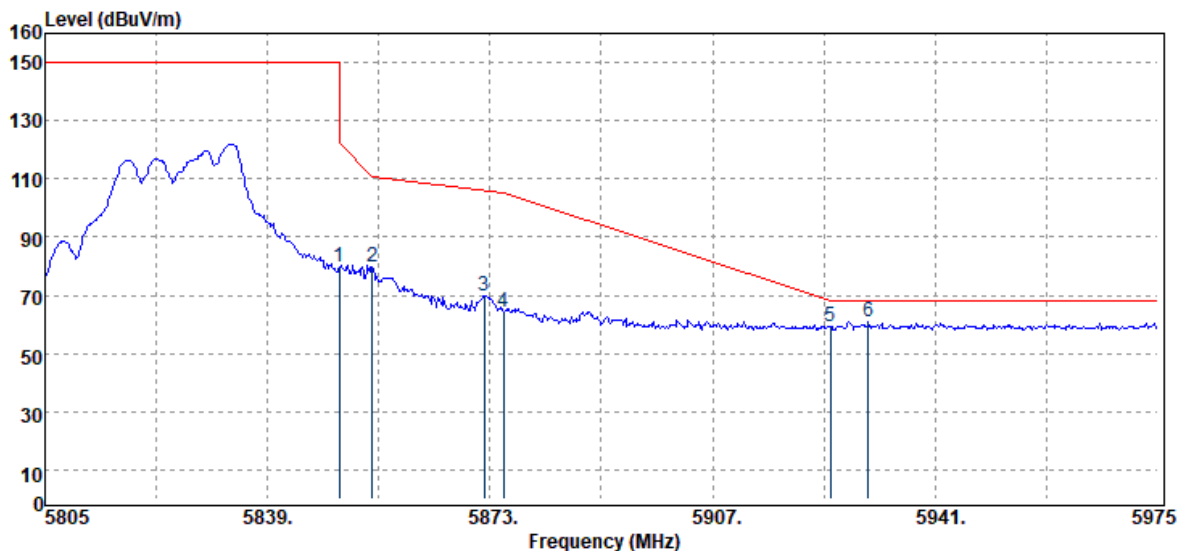

| Freq. MHz | Detector Mode PK/QP/AV | Spectrum Reading Level dB μ V | Factor dB | Actual FS dB μ V/m | Limit @3m dB μ V/m | Margin dB |
|--------------|------------------------------|---|--------------|------------------------------|------------------------------|--------------|
| 5850.00 | Peak | 70.49 | 9.02 | 79.51 | 122.20 | -42.69 |
| 5855.00 | Peak | 70.41 | 9.07 | 79.48 | 110.80 | -31.32 |
| 5872.15 | Peak | 60.71 | 9.24 | 69.95 | 106.00 | -36.05 |
| 5875.00 | Peak | 55.11 | 9.27 | 64.38 | 105.20 | -40.82 |
| 5925.00 | Peak | 49.43 | 9.70 | 59.13 | 68.20 | -9.07 |
| 5930.80 | Peak | 51.28 | 9.74 | 61.02 | 68.20 | -7.18 |

Unless otherwise stated the results shown in this test report refer only to the sample(s) tested and such sample(s) are retained for 90 days only.

除非另有說明，此報告結果僅對測試之樣品負責，同時此樣品僅保留90天。本報告未經本公司書面許可，不可部份複製。

This document is issued by the Company subject to its General Conditions of Service printed overleaf, available on request or accessible at <http://www.sgs.com.tw/Terms-and-Conditions> and for electronic format documents, subject to Terms and Conditions for Electronic Documents at <http://www.sgs.com.tw/Terms-and-Conditions>. Attention is drawn to the limitation of liability, indemnification and jurisdiction issues defined therein. Any holder of this document is advised that information contained hereon reflects the Company's findings at the time of its intervention only and within the limits of Client's instructions, if any. The Company's sole responsibility is to its Client and this document does not exonerate parties to a transaction from exercising all their rights and obligations under the transaction documents. This document cannot be reproduced except in full, without prior written approval of the Company. Any unauthorized alteration, forgery or falsification of the content or appearance of this document is unlawful and offenders may be prosecuted to the fullest extent of the law.

| | | | |
|----------------|-----------------------|--------------|------------------|
| Report Number | :ER-2021-20085 | Test Site | :SAC III Chamber |
| Operation Mode | :802.11ax20 RU 106/54 | Test Date | :2021-03-16 |
| Test Frequency | :5825 MHz | Temp./Humi. | :22.7/63 |
| Test Mode | :Bandedge CH High | Antenna Pol. | :HORIZONTAL |
| EUT Pol | :H Plane | Engineer | :Ricky |

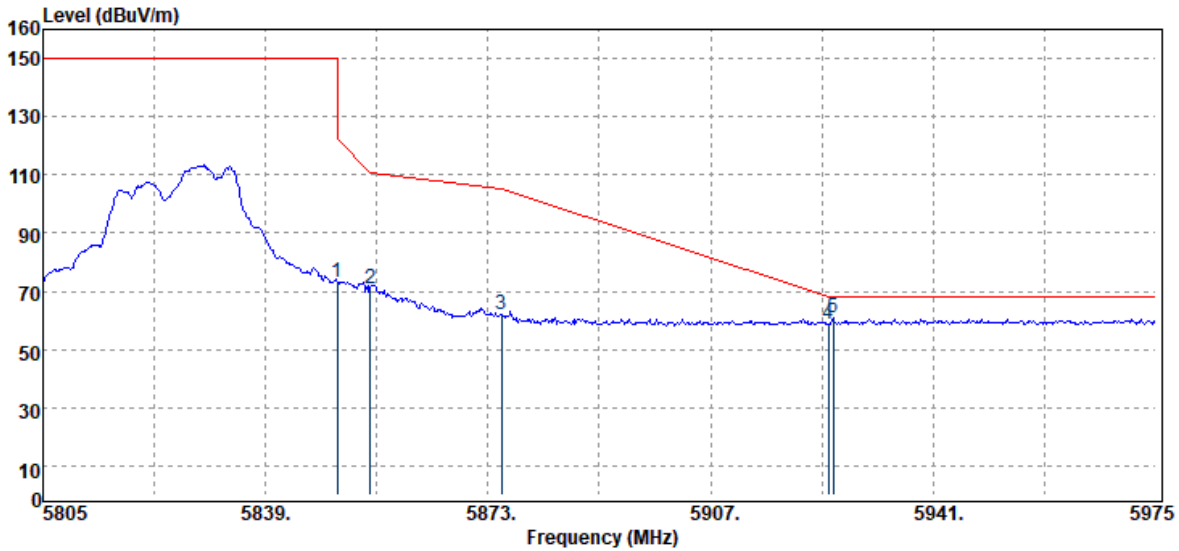

| Freq. MHz | Detector Mode PK/QP/AV | Spectrum Reading Level dB μ V | Factor dB | Actual FS dB μ V/m | Limit @3m dB μ V/m | Margin dB |
|--------------|------------------------------|---|--------------|------------------------------|------------------------------|--------------|
| 5850.00 | Peak | 63.97 | 9.02 | 72.99 | 122.20 | -49.21 |
| 5855.00 | Peak | 61.83 | 9.07 | 70.90 | 110.80 | -39.90 |
| 5875.00 | Peak | 52.85 | 9.27 | 62.12 | 105.20 | -43.08 |
| 5925.00 | Peak | 49.13 | 9.70 | 58.83 | 68.20 | -9.37 |
| 5925.70 | Peak | 51.15 | 9.71 | 60.86 | 68.20 | -7.34 |

Unless otherwise stated the results shown in this test report refer only to the sample(s) tested and such sample(s) are retained for 90 days only.

除非另有說明，此報告結果僅對測試之樣品負責，同時此樣品僅保留90天。本報告未經本公司書面許可，不可部份複製。

This document is issued by the Company subject to its General Conditions of Service printed overleaf, available on request or accessible at <http://www.sgs.com.tw/Terms-and-Conditions> and for electronic format documents, subject to Terms and Conditions for Electronic Documents at <http://www.sgs.com.tw/Terms-and-Conditions>. Attention is drawn to the limitation of liability, indemnification and jurisdiction issues defined therein. Any holder of this document is advised that information contained hereon reflects the Company's findings at the time of its intervention only and within the limits of Client's instructions, if any. The Company's sole responsibility is to its Client and this document does not exonerate parties to a transaction from exercising all their rights and obligations under the transaction documents. This document cannot be reproduced except in full, without prior written approval of the Company. Any unauthorized alteration, forgery or falsification of the content or appearance of this document is unlawful and offenders may be prosecuted to the fullest extent of the law.

| | | | |
|----------------|---------------------|--------------|------------------|
| Report Number | :ER-2021-20085 | Test Site | :SAC III Chamber |
| Operation Mode | :802.11ax40 RU full | Test Date | :2021-03-16 |
| Test Frequency | :5190 MHz | Temp./Humi. | :22.7/63 |
| Test Mode | :Bandedge CH Low | Antenna Pol. | :VERTICAL |
| EUT Pol | :H Plane | Engineer | :Ricky |

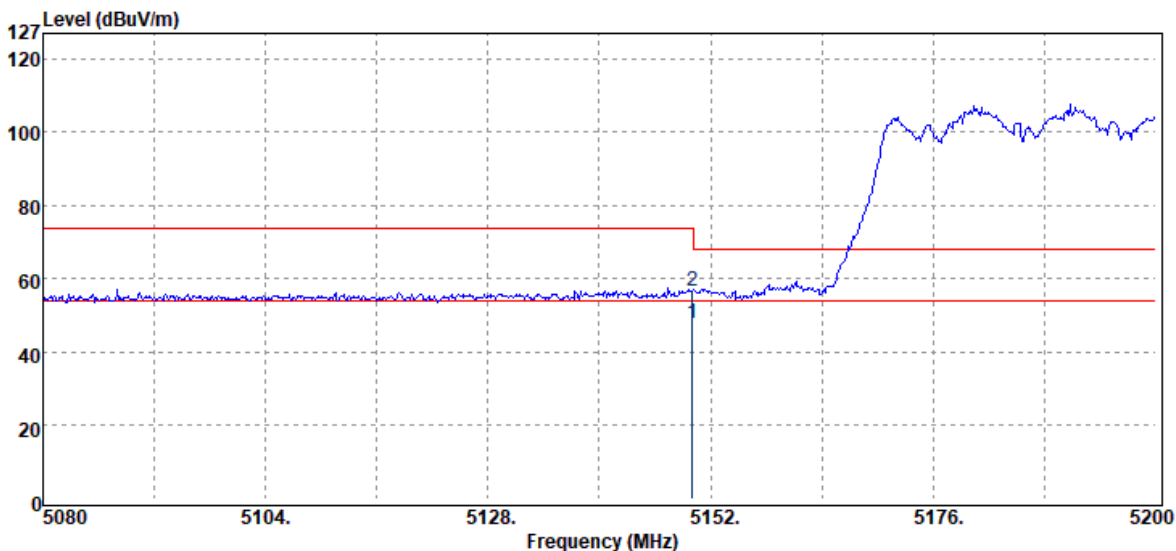

| Freq. MHz | Detector Mode PK/QP/AV | Spectrum Reading Level dB μ V | Factor dB | Actual FS dB μ V/m | Limit @3m dB μ V/m | Margin dB |
|--------------|------------------------------|---|--------------|------------------------------|------------------------------|--------------|
| 5150.00 | Average | 39.35 | 8.53 | 47.88 | 54.00 | -6.12 |
| 5150.00 | Peak | 48.36 | 8.53 | 56.89 | 74.00 | -17.11 |

Unless otherwise stated the results shown in this test report refer only to the sample(s) tested and such sample(s) are retained for 90 days only.

除非另有說明，此報告結果僅對測試之樣品負責，同時此樣品僅保留90天。本報告未經本公司書面許可，不可部份複製。

This document is issued by the Company subject to its General Conditions of Service printed overleaf, available on request or accessible at <http://www.sgs.com.tw/Terms-and-Conditions> and for electronic format documents, subject to Terms and Conditions for Electronic Documents at <http://www.sgs.com.tw/Terms-and-Conditions>. Attention is drawn to the limitation of liability, indemnification and jurisdiction issues defined therein. Any holder of this document is advised that information contained hereon reflects the Company's findings at the time of its intervention only and within the limits of Client's instructions, if any. The Company's sole responsibility is to its Client and this document does not exonerate parties to a transaction from exercising all their rights and obligations under the transaction documents. This document cannot be reproduced except in full, without prior written approval of the Company. Any unauthorized alteration, forgery or falsification of the content or appearance of this document is unlawful and offenders may be prosecuted to the fullest extent of the law.

| | | | |
|----------------|---------------------|--------------|------------------|
| Report Number | :ER-2021-20085 | Test Site | :SAC III Chamber |
| Operation Mode | :802.11ax40 RU full | Test Date | :2021-03-16 |
| Test Frequency | :5190 MHz | Temp./Humi. | :22.7/63 |
| Test Mode | :Bandedge CH Low | Antenna Pol. | :HORIZONTAL |
| EUT Pol | :H Plane | Engineer | :Ricky |

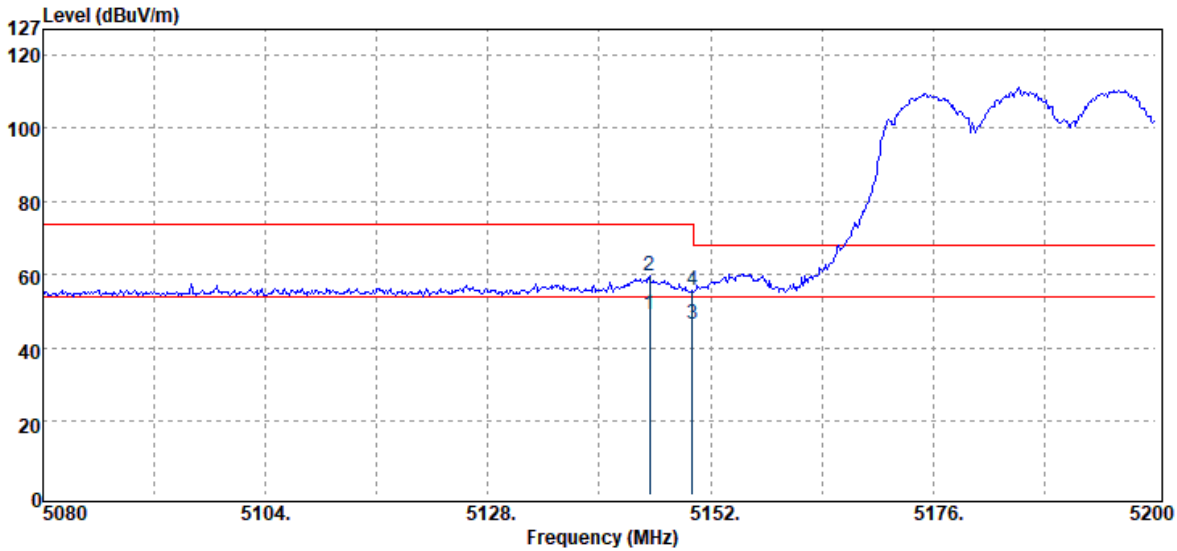

| Freq. MHz | Detector Mode PK/QP/AV | Spectrum Reading Level dB μ V | Factor dB | Actual FS dB μ V/m | Limit @3m dB μ V/m | Margin dB |
|--------------|------------------------------|---|--------------|------------------------------|------------------------------|--------------|
| 5145.40 | Average | 40.77 | 8.54 | 49.31 | 54.00 | -4.69 |
| 5145.40 | Peak | 51.12 | 8.54 | 59.66 | 74.00 | -14.34 |
| 5150.00 | Average | 38.06 | 8.53 | 46.59 | 54.00 | -7.41 |
| 5150.00 | Peak | 47.32 | 8.53 | 55.85 | 74.00 | -18.15 |

Unless otherwise stated the results shown in this test report refer only to the sample(s) tested and such sample(s) are retained for 90 days only.

除非另有說明，此報告結果僅對測試之樣品負責，同時此樣品僅保留90天。本報告未經本公司書面許可，不可部份複製。

This document is issued by the Company subject to its General Conditions of Service printed overleaf, available on request or accessible at <http://www.sgs.com.tw/Terms-and-Conditions> and for electronic format documents, subject to Terms and Conditions for Electronic Documents at <http://www.sgs.com.tw/Terms-and-Conditions>. Attention is drawn to the limitation of liability, indemnification and jurisdiction issues defined therein. Any holder of this document is advised that information contained hereon reflects the Company's findings at the time of its intervention only and within the limits of Client's instructions, if any. The Company's sole responsibility is to its Client and this document does not exonerate parties to a transaction from exercising all their rights and obligations under the transaction documents. This document cannot be reproduced except in full, without prior written approval of the Company. Any unauthorized alteration, forgery or falsification of the content or appearance of this document is unlawful and offenders may be prosecuted to the fullest extent of the law.

| | | | |
|----------------|-----------------------|--------------|------------------|
| Report Number | :ER-2021-20085 | Test Site | :SAC III Chamber |
| Operation Mode | :802.11ax40 RU 242/61 | Test Date | :2021-03-16 |
| Test Frequency | :5190 MHz | Temp./Humi. | :22.7/63 |
| Test Mode | :Bandedge CH Low | Antenna Pol. | :VERTICAL |
| EUT Pol | :H Plane | Engineer | :Ricky |

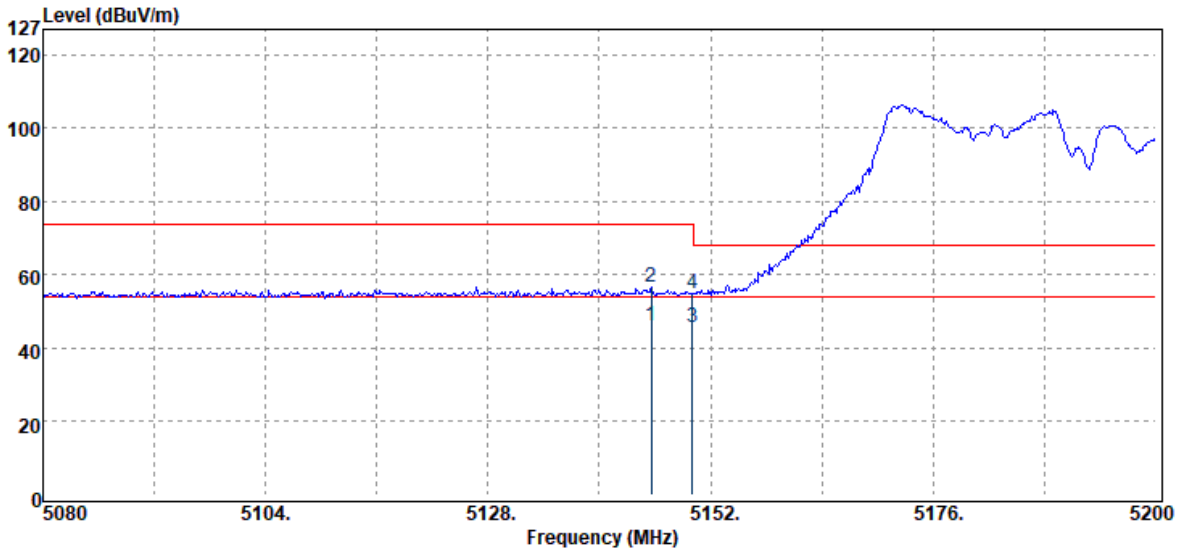

| Freq. MHz | Detector Mode PK/QP/AV | Spectrum Reading Level dBμV | Factor dB | Actual FS dBμV/m | Limit @3m dBμV/m | Margin dB |
|--------------|------------------------------|-----------------------------------|--------------|------------------------|------------------------|--------------|
| 5145.64 | Average | 37.62 | 8.54 | 46.16 | 54.00 | -7.84 |
| 5145.64 | Peak | 48.10 | 8.54 | 56.64 | 74.00 | -17.36 |
| 5150.00 | Average | 37.34 | 8.53 | 45.87 | 54.00 | -8.13 |
| 5150.00 | Peak | 46.46 | 8.53 | 54.99 | 74.00 | -19.01 |

Unless otherwise stated the results shown in this test report refer only to the sample(s) tested and such sample(s) are retained for 90 days only.

除非另有說明，此報告結果僅對測試之樣品負責，同時此樣品僅保留90天。本報告未經本公司書面許可，不可部份複製。

This document is issued by the Company subject to its General Conditions of Service printed overleaf, available on request or accessible at <http://www.sgs.com.tw/Terms-and-Conditions> and for electronic format documents, subject to Terms and Conditions for Electronic Documents at <http://www.sgs.com.tw/Terms-and-Conditions>. Attention is drawn to the limitation of liability, indemnification and jurisdiction issues defined therein. Any holder of this document is advised that information contained hereon reflects the Company's findings at the time of its intervention only and within the limits of Client's instructions, if any. The Company's sole responsibility is to its Client and this document does not exonerate parties to a transaction from exercising all their rights and obligations under the transaction documents. This document cannot be reproduced except in full, without prior written approval of the Company. Any unauthorized alteration, forgery or falsification of the content or appearance of this document is unlawful and offenders may be prosecuted to the fullest extent of the law.

| | | | |
|----------------|-----------------------|--------------|------------------|
| Report Number | :ER-2021-20085 | Test Site | :SAC III Chamber |
| Operation Mode | :802.11ax40 RU 242/61 | Test Date | :2021-03-16 |
| Test Frequency | :5190 MHz | Temp./Humi. | :22.7/63 |
| Test Mode | :Bandedge CH Low | Antenna Pol. | :HORIZONTAL |
| EUT Pol | :H Plane | Engineer | :Ricky |

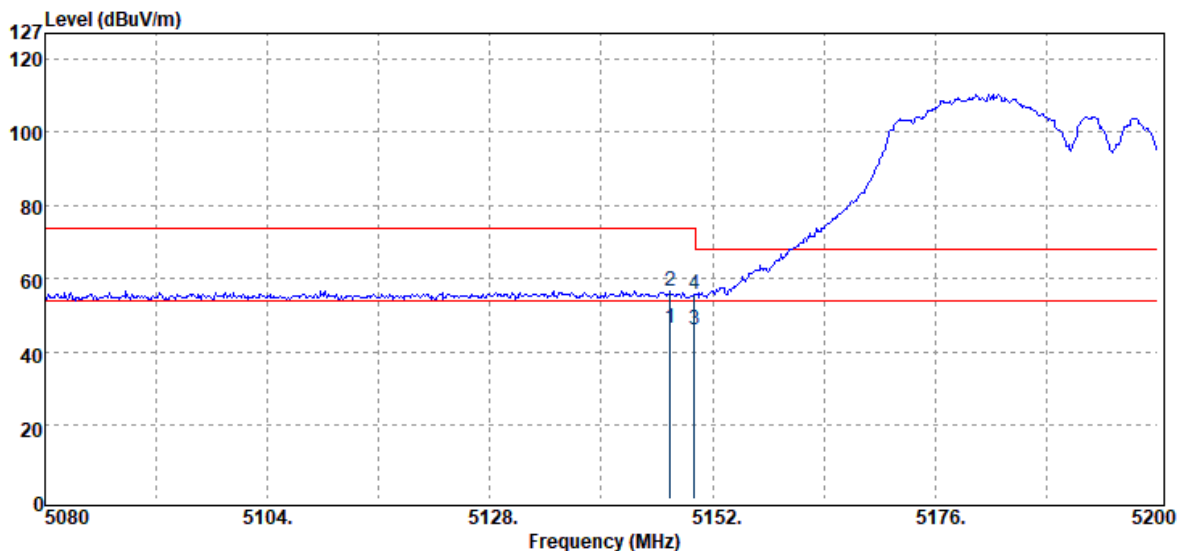

| Freq. MHz | Detector Mode PK/QP/AV | Spectrum Reading Level dB μ V | Factor dB | Actual FS dB μ V/m | Limit @3m dB μ V/m | Margin dB |
|--------------|------------------------------|---|--------------|------------------------------|------------------------------|--------------|
| 5147.44 | Average | 37.88 | 8.54 | 46.42 | 54.00 | -7.58 |
| 5147.44 | Peak | 48.16 | 8.54 | 56.70 | 74.00 | -17.30 |
| 5150.00 | Average | 37.61 | 8.53 | 46.14 | 54.00 | -7.86 |
| 5150.00 | Peak | 47.20 | 8.53 | 55.73 | 74.00 | -18.27 |

Unless otherwise stated the results shown in this test report refer only to the sample(s) tested and such sample(s) are retained for 90 days only.

除非另有說明，此報告結果僅對測試之樣品負責，同時此樣品僅保留90天。本報告未經本公司書面許可，不可部份複製。

This document is issued by the Company subject to its General Conditions of Service printed overleaf, available on request or accessible at <http://www.sgs.com.tw/Terms-and-Conditions> and for electronic format documents, subject to Terms and Conditions for Electronic Documents at <http://www.sgs.com.tw/Terms-and-Conditions>. Attention is drawn to the limitation of liability, indemnification and jurisdiction issues defined therein. Any holder of this document is advised that information contained hereon reflects the Company's findings at the time of its intervention only and within the limits of Client's instructions, if any. The Company's sole responsibility is to its Client and this document does not exonerate parties to a transaction from exercising all their rights and obligations under the transaction documents. This document cannot be reproduced except in full, without prior written approval of the Company. Any unauthorized alteration, forgery or falsification of the content or appearance of this document is unlawful and offenders may be prosecuted to the fullest extent of the law.

| | | | |
|----------------|---------------------|--------------|------------------|
| Report Number | :ER-2021-20085 | Test Site | :SAC III Chamber |
| Operation Mode | :802.11ax40 RU full | Test Date | :2021-03-16 |
| Test Frequency | :5310 MHz | Temp./Humi. | :22.7/63 |
| Test Mode | :Bandedge CH High | Antenna Pol. | :VERTICAL |
| EUT Pol | :H Plane | Engineer | :Ricky |

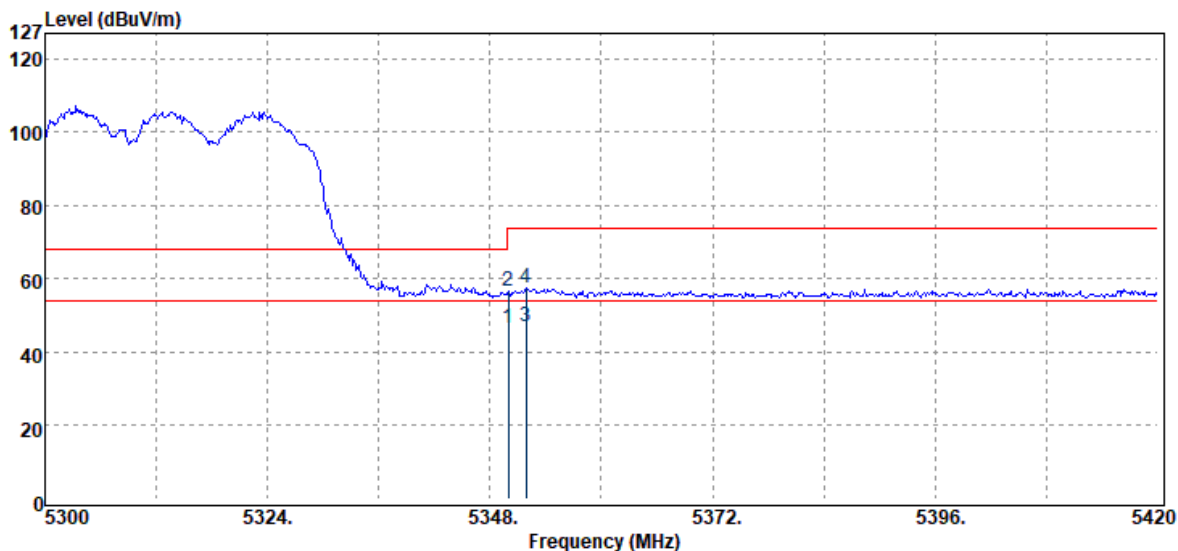

| Freq. MHz | Detector Mode PK/QP/AV | Spectrum Reading Level dB μ V | Factor dB | Actual FS dB μ V/m | Limit @3m dB μ V/m | Margin dB |
|--------------|------------------------------|---|--------------|------------------------------|------------------------------|--------------|
| 5350.00 | Average | 37.61 | 8.77 | 46.38 | 54.00 | -7.62 |
| 5350.00 | Peak | 47.89 | 8.77 | 56.66 | 74.00 | -17.34 |
| 5351.84 | Average | 38.39 | 8.78 | 47.17 | 54.00 | -6.83 |
| 5351.84 | Peak | 48.90 | 8.78 | 57.68 | 74.00 | -16.32 |

Unless otherwise stated the results shown in this test report refer only to the sample(s) tested and such sample(s) are retained for 90 days only.

除非另有說明，此報告結果僅對測試之樣品負責，同時此樣品僅保留90天。本報告未經本公司書面許可，不可部份複製。

This document is issued by the Company subject to its General Conditions of Service printed overleaf, available on request or accessible at <http://www.sgs.com.tw/Terms-and-Conditions> and for electronic format documents, subject to Terms and Conditions for Electronic Documents at <http://www.sgs.com.tw/Terms-and-Conditions>. Attention is drawn to the limitation of liability, indemnification and jurisdiction issues defined therein. Any holder of this document is advised that information contained hereon reflects the Company's findings at the time of its intervention only and within the limits of Client's instructions, if any. The Company's sole responsibility is to its Client and this document does not exonerate parties to a transaction from exercising all their rights and obligations under the transaction documents. This document cannot be reproduced except in full, without prior written approval of the Company. Any unauthorized alteration, forgery or falsification of the content or appearance of this document is unlawful and offenders may be prosecuted to the fullest extent of the law.

| | | | |
|----------------|---------------------|--------------|------------------|
| Report Number | :ER-2021-20085 | Test Site | :SAC III Chamber |
| Operation Mode | :802.11ax40 RU full | Test Date | :2021-03-16 |
| Test Frequency | :5310 MHz | Temp./Humi. | :22.7/63 |
| Test Mode | :Bandedge CH High | Antenna Pol. | :HORIZONTAL |
| EUT Pol | :H Plane | Engineer | :Ricky |

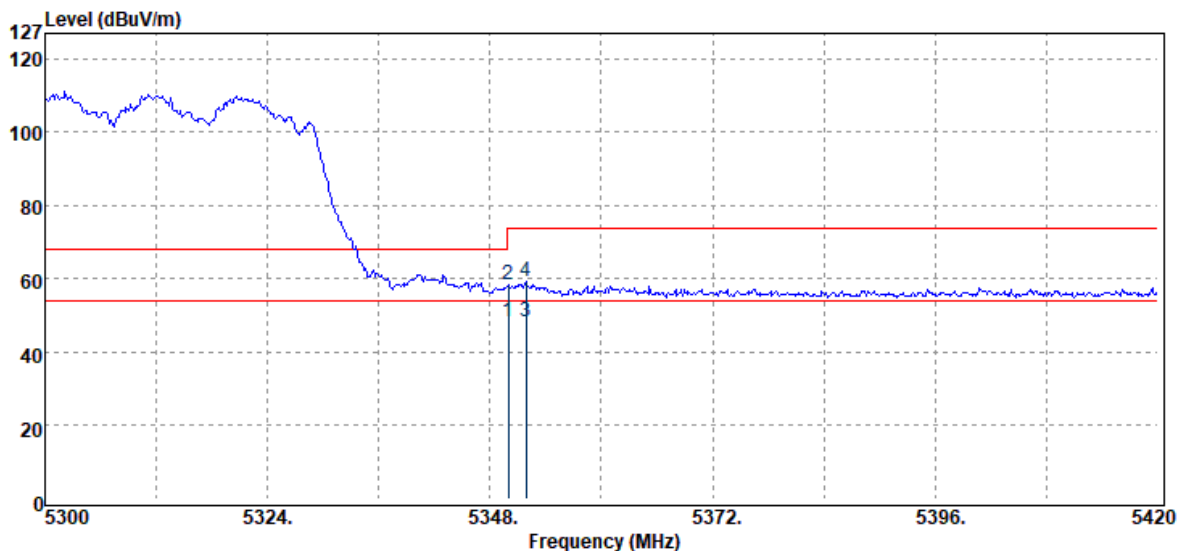

| Freq. MHz | Detector Mode PK/QP/AV | Spectrum Reading Level dB μ V | Factor dB | Actual FS dB μ V/m | Limit @3m dB μ V/m | Margin dB |
|--------------|------------------------------|---|--------------|------------------------------|------------------------------|--------------|
| 5350.00 | Average | 39.42 | 8.77 | 48.19 | 54.00 | -5.81 |
| 5350.00 | Peak | 49.50 | 8.77 | 58.27 | 74.00 | -15.73 |
| 5351.84 | Average | 39.66 | 8.78 | 48.44 | 54.00 | -5.56 |
| 5351.84 | Peak | 50.64 | 8.78 | 59.42 | 74.00 | -14.58 |

Unless otherwise stated the results shown in this test report refer only to the sample(s) tested and such sample(s) are retained for 90 days only.

除非另有說明，此報告結果僅對測試之樣品負責，同時此樣品僅保留90天。本報告未經本公司書面許可，不可部份複製。

This document is issued by the Company subject to its General Conditions of Service printed overleaf, available on request or accessible at <http://www.sgs.com.tw/Terms-and-Conditions> and for electronic format documents, subject to Terms and Conditions for Electronic Documents at <http://www.sgs.com.tw/Terms-and-Conditions>. Attention is drawn to the limitation of liability, indemnification and jurisdiction issues defined therein. Any holder of this document is advised that information contained hereon reflects the Company's findings at the time of its intervention only and within the limits of Client's instructions, if any. The Company's sole responsibility is to its Client and this document does not exonerate parties to a transaction from exercising all their rights and obligations under the transaction documents. This document cannot be reproduced except in full, without prior written approval of the Company. Any unauthorized alteration, forgery or falsification of the content or appearance of this document is unlawful and offenders may be prosecuted to the fullest extent of the law.

| | | | |
|----------------|-----------------------|--------------|------------------|
| Report Number | :ER-2021-20085 | Test Site | :SAC III Chamber |
| Operation Mode | :802.11ax40 RU 242/62 | Test Date | :2021-03-16 |
| Test Frequency | :5310 MHz | Temp./Humi. | :22.7/63 |
| Test Mode | :Bandedge CH High | Antenna Pol. | :VERTICAL |
| EUT Pol | :H Plane | Engineer | :Ricky |

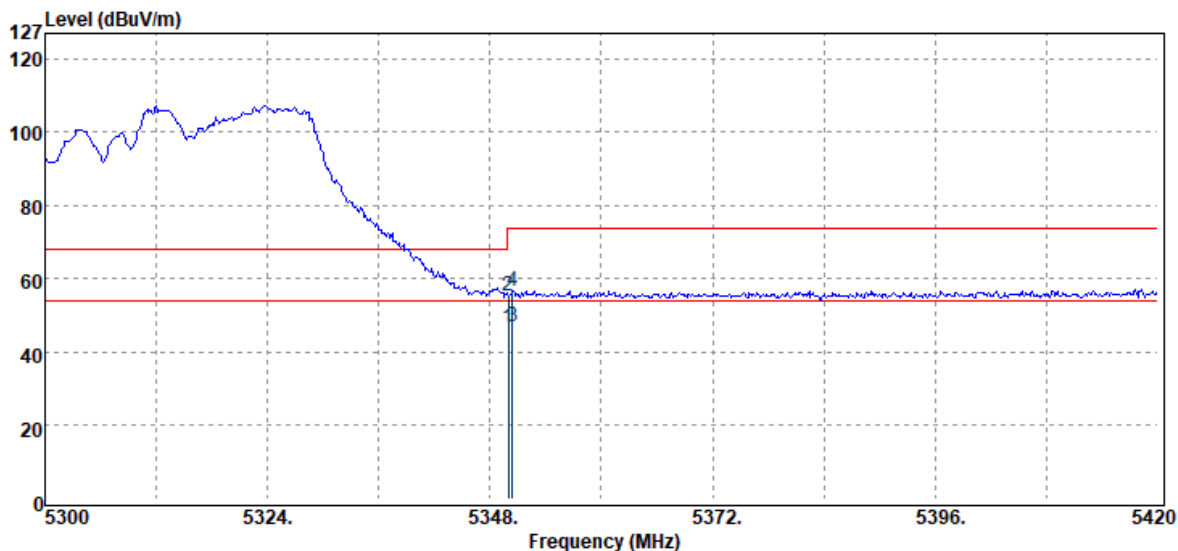

| Freq. MHz | Detector Mode PK/QP/AV | Spectrum Reading Level dBμV | Factor dB | Actual FS dBμV/m | Limit @3m dBμV/m | Margin dB |
|--------------|------------------------------|-----------------------------------|--------------|------------------------|------------------------|--------------|
| 5350.00 | Average | 37.90 | 8.77 | 46.67 | 54.00 | -7.33 |
| 5350.00 | Peak | 46.60 | 8.77 | 55.37 | 74.00 | -18.63 |
| 5350.40 | Average | 38.08 | 8.76 | 46.84 | 54.00 | -7.16 |
| 5350.40 | Peak | 48.08 | 8.76 | 56.84 | 74.00 | -17.16 |

Unless otherwise stated the results shown in this test report refer only to the sample(s) tested and such sample(s) are retained for 90 days only.

除非另有說明，此報告結果僅對測試之樣品負責，同時此樣品僅保留90天。本報告未經本公司書面許可，不可部份複製。

This document is issued by the Company subject to its General Conditions of Service printed overleaf, available on request or accessible at <http://www.sgs.com.tw/Terms-and-Conditions> and for electronic format documents, subject to Terms and Conditions for Electronic Documents at <http://www.sgs.com.tw/Terms-and-Conditions>. Attention is drawn to the limitation of liability, indemnification and jurisdiction issues defined therein. Any holder of this document is advised that information contained hereon reflects the Company's findings at the time of its intervention only and within the limits of Client's instructions, if any. The Company's sole responsibility is to its Client and this document does not exonerate parties to a transaction from exercising all their rights and obligations under the transaction documents. This document cannot be reproduced except in full, without prior written approval of the Company. Any unauthorized alteration, forgery or falsification of the content or appearance of this document is unlawful and offenders may be prosecuted to the fullest extent of the law.

Report Number :ER-2021-20085
 Operation Mode :802.11ax40 RU 242/62
 Test Frequency :5310 MHz
 Test Mode :Bandedge CH High
 EUT Pol :H Plane

Test Site :SAC III Chamber
 Test Date :2021-03-16
 Temp./Humi. :22.7/63
 Antenna Pol. :HORIZONTAL
 Engineer :Ricky

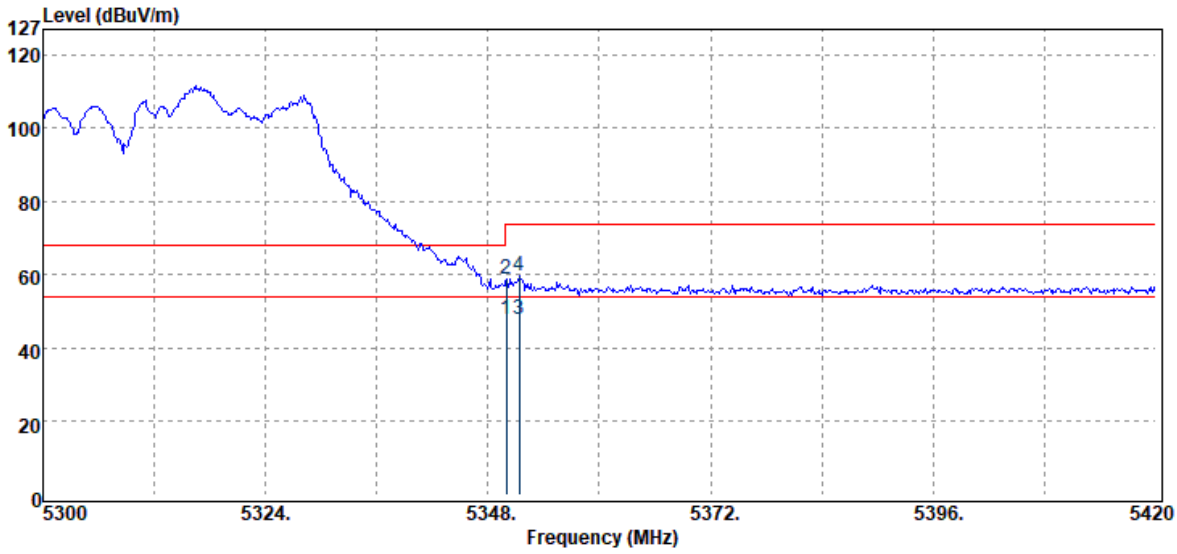

| Freq. MHz | Detector Mode PK/QP/AV | Spectrum Reading Level dB μ V | Factor dB | Actual FS dB μ V/m | Limit @3m dB μ V/m | Margin dB |
|--------------|------------------------------|---|--------------|------------------------------|------------------------------|--------------|
| 5350.00 | Average | 39.27 | 8.77 | 48.04 | 54.00 | -5.96 |
| 5350.00 | Peak | 50.08 | 8.77 | 58.85 | 74.00 | -15.15 |
| 5351.36 | Average | 39.04 | 8.78 | 47.82 | 54.00 | -6.18 |
| 5351.36 | Peak | 51.17 | 8.78 | 59.95 | 74.00 | -14.05 |

Unless otherwise stated the results shown in this test report refer only to the sample(s) tested and such sample(s) are retained for 90 days only.

除非另有說明，此報告結果僅對測試之樣品負責，同時此樣品僅保留90天。本報告未經本公司書面許可，不可部份複製。

This document is issued by the Company subject to its General Conditions of Service printed overleaf, available on request or accessible at <http://www.sgs.com.tw/Terms-and-Conditions> and for electronic format documents, subject to Terms and Conditions for Electronic Documents at <http://www.sgs.com.tw/Terms-and-Conditions>. Attention is drawn to the limitation of liability, indemnification and jurisdiction issues defined therein. Any holder of this document is advised that information contained hereon reflects the Company's findings at the time of its intervention only and within the limits of Client's instructions, if any. The Company's sole responsibility is to its Client and this document does not exonerate parties to a transaction from exercising all their rights and obligations under the transaction documents. This document cannot be reproduced except in full, without prior written approval of the Company. Any unauthorized alteration, forgery or falsification of the content or appearance of this document is unlawful and offenders may be prosecuted to the fullest extent of the law.

Report Number :ER-2021-20085
 Operation Mode :802.11ax40 RU full
 Test Frequency :5510 MHz
 Test Mode :Bandedge CH Low
 EUT Pol :H Plane

Test Site :SAC III Chamber
 Test Date :2021-03-16
 Temp./Humi. :22.7/63
 Antenna Pol. :VERTICAL
 Engineer :Ricky

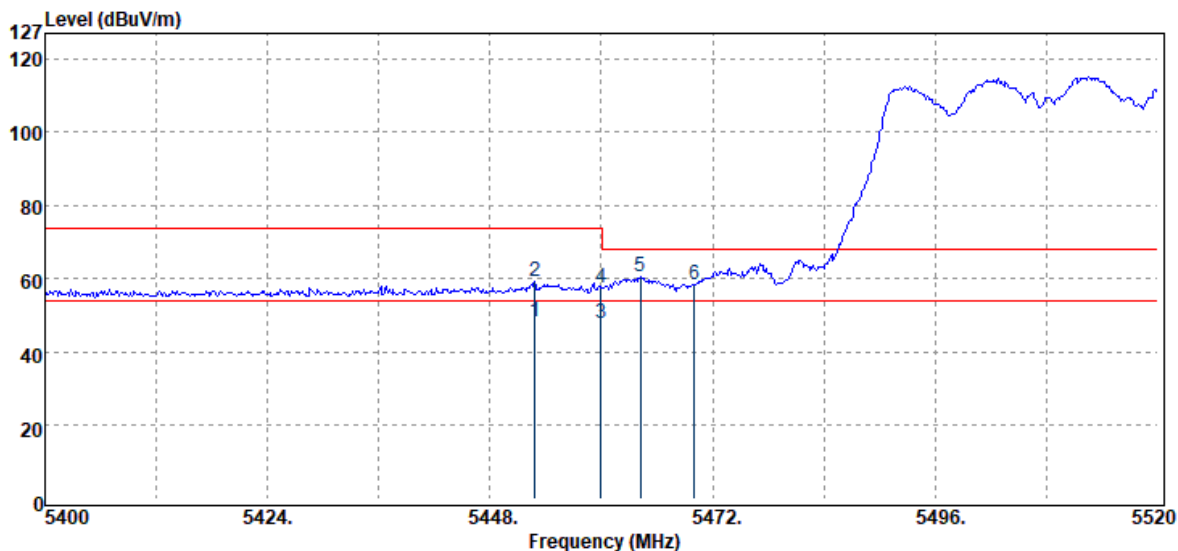

| Freq. MHz | Detector Mode PK/QP/AV | Spectrum Reading Level dB μ V | Factor dB | Actual FS dB μ V/m | Limit @3m dB μ V/m | Margin dB |
|--------------|------------------------------|---|--------------|------------------------------|------------------------------|--------------|
| 5452.80 | Average | 38.81 | 9.59 | 48.40 | 54.00 | -5.60 |
| 5452.80 | Peak | 49.58 | 9.59 | 59.17 | 74.00 | -14.83 |
| 5460.00 | Average | 38.42 | 9.63 | 48.05 | 54.00 | -5.95 |
| 5460.00 | Peak | 48.07 | 9.63 | 57.70 | 74.00 | -16.30 |
| 5464.20 | Peak | 51.05 | 9.67 | 60.72 | 68.20 | -7.48 |
| 5470.00 | Peak | 48.68 | 9.71 | 58.39 | 68.20 | -9.81 |

Unless otherwise stated the results shown in this test report refer only to the sample(s) tested and such sample(s) are retained for 90 days only.

除非另有說明，此報告結果僅對測試之樣品負責，同時此樣品僅保留90天。本報告未經本公司書面許可，不可部份複製。

This document is issued by the Company subject to its General Conditions of Service printed overleaf, available on request or accessible at <http://www.sgs.com.tw/Terms-and-Conditions> and for electronic format documents, subject to Terms and Conditions for Electronic Documents at <http://www.sgs.com.tw/Terms-and-Conditions>. Attention is drawn to the limitation of liability, indemnification and jurisdiction issues defined therein. Any holder of this document is advised that information contained hereon reflects the Company's findings at the time of its intervention only and within the limits of Client's instructions, if any. The Company's sole responsibility is to its Client and this document does not exonerate parties to a transaction from exercising all their rights and obligations under the transaction documents. This document cannot be reproduced except in full, without prior written approval of the Company. Any unauthorized alteration, forgery or falsification of the content or appearance of this document is unlawful and offenders may be prosecuted to the fullest extent of the law.

Report Number :ER-2021-20085
 Operation Mode :802.11ax40 RU full
 Test Frequency :5510 MHz
 Test Mode :Bandedge CH Low
 EUT Pol :H Plane

Test Site :SAC III Chamber
 Test Date :2021-03-16
 Temp./Humi. :22.7/63
 Antenna Pol. :HORIZONTAL
 Engineer :Ricky

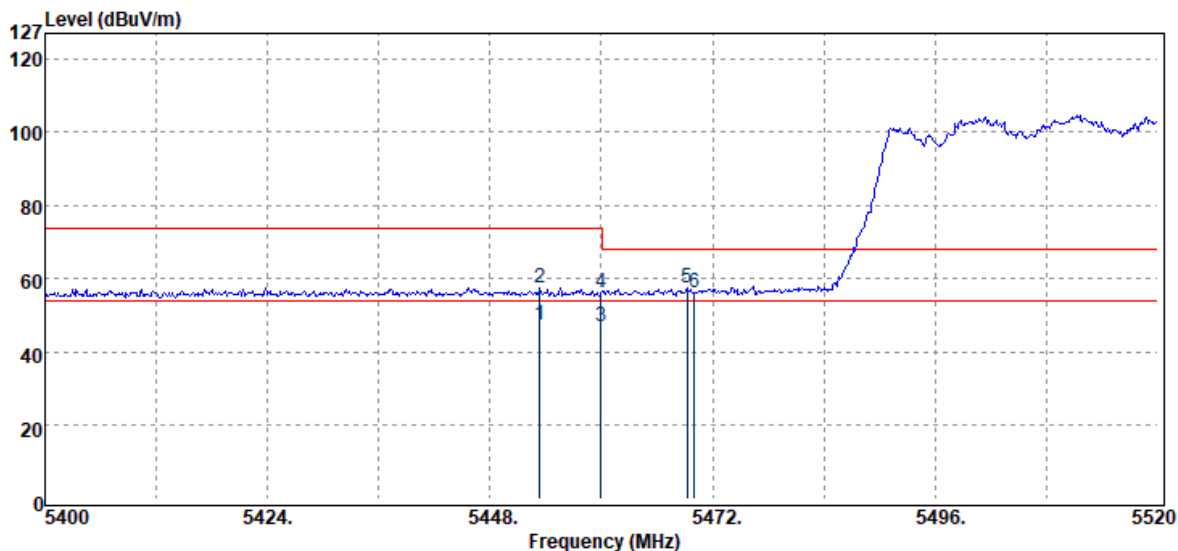

| Freq. MHz | Detector Mode PK/QP/AV | Spectrum Reading Level dB μ V | Factor dB | Actual FS dB μ V/m | Limit @3m dB μ V/m | Margin dB |
|--------------|------------------------------|---|--------------|------------------------------|------------------------------|--------------|
| 5453.40 | Average | 37.73 | 9.59 | 47.32 | 54.00 | -6.68 |
| 5453.40 | Peak | 47.96 | 9.59 | 57.55 | 74.00 | -16.45 |
| 5460.00 | Average | 37.60 | 9.63 | 47.23 | 54.00 | -6.77 |
| 5460.00 | Peak | 46.77 | 9.63 | 56.40 | 74.00 | -17.60 |
| 5469.24 | Peak | 47.80 | 9.70 | 57.50 | 68.20 | -10.70 |
| 5470.00 | Peak | 46.36 | 9.71 | 56.07 | 68.20 | -12.13 |

Unless otherwise stated the results shown in this test report refer only to the sample(s) tested and such sample(s) are retained for 90 days only.

除非另有說明，此報告結果僅對測試之樣品負責，同時此樣品僅保留90天。本報告未經本公司書面許可，不可部份複製。

This document is issued by the Company subject to its General Conditions of Service printed overleaf, available on request or accessible at <http://www.sgs.com.tw/Terms-and-Conditions> and for electronic format documents, subject to Terms and Conditions for Electronic Documents at <http://www.sgs.com.tw/Terms-and-Conditions>. Attention is drawn to the limitation of liability, indemnification and jurisdiction issues defined therein. Any holder of this document is advised that information contained hereon reflects the Company's findings at the time of its intervention only and within the limits of Client's instructions, if any. The Company's sole responsibility is to its Client and this document does not exonerate parties to a transaction from exercising all their rights and obligations under the transaction documents. This document cannot be reproduced except in full, without prior written approval of the Company. Any unauthorized alteration, forgery or falsification of the content or appearance of this document is unlawful and offenders may be prosecuted to the fullest extent of the law.

| | | | |
|----------------|-----------------------|--------------|------------------|
| Report Number | :ER-2021-20085 | Test Site | :SAC III Chamber |
| Operation Mode | :802.11ax40 RU 242/61 | Test Date | :2021-03-16 |
| Test Frequency | :5510 MHz | Temp./Humi. | :22.7/63 |
| Test Mode | :Bandedge CH Low | Antenna Pol. | :VERTICAL |
| EUT Pol | :H Plane | Engineer | :Ricky |

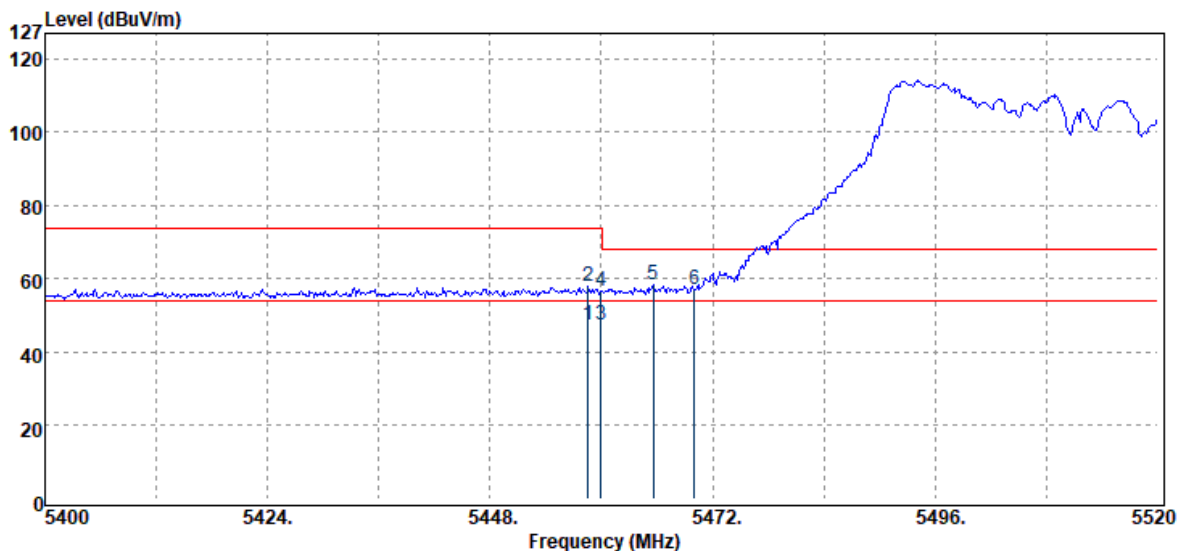

| Freq. MHz | Detector Mode PK/QP/AV | Spectrum Reading Level dB μ V | Factor dB | Actual FS dB μ V/m | Limit @3m dB μ V/m | Margin dB |
|--------------|------------------------------|---|--------------|------------------------------|------------------------------|--------------|
| 5458.56 | Average | 37.94 | 9.62 | 47.56 | 54.00 | -6.44 |
| 5458.56 | Peak | 48.21 | 9.62 | 57.83 | 74.00 | -16.17 |
| 5460.00 | Average | 37.99 | 9.63 | 47.62 | 54.00 | -6.38 |
| 5460.00 | Peak | 47.10 | 9.63 | 56.73 | 74.00 | -17.27 |
| 5465.64 | Peak | 48.62 | 9.67 | 58.29 | 68.20 | -9.91 |
| 5470.00 | Peak | 47.25 | 9.71 | 56.96 | 68.20 | -11.24 |

Unless otherwise stated the results shown in this test report refer only to the sample(s) tested and such sample(s) are retained for 90 days only.

除非另有說明，此報告結果僅對測試之樣品負責，同時此樣品僅保留90天。本報告未經本公司書面許可，不可部份複製。

This document is issued by the Company subject to its General Conditions of Service printed overleaf, available on request or accessible at <http://www.sgs.com.tw/Terms-and-Conditions> and for electronic format documents, subject to Terms and Conditions for Electronic Documents at <http://www.sgs.com.tw/Terms-and-Conditions>. Attention is drawn to the limitation of liability, indemnification and jurisdiction issues defined therein. Any holder of this document is advised that information contained hereon reflects the Company's findings at the time of its intervention only and within the limits of Client's instructions, if any. The Company's sole responsibility is to its Client and this document does not exonerate parties to a transaction from exercising all their rights and obligations under the transaction documents. This document cannot be reproduced except in full, without prior written approval of the Company. Any unauthorized alteration, forgery or falsification of the content or appearance of this document is unlawful and offenders may be prosecuted to the fullest extent of the law.

| | | | |
|----------------|-----------------------|--------------|------------------|
| Report Number | :ER-2021-20085 | Test Site | :SAC III Chamber |
| Operation Mode | :802.11ax40 RU 242/61 | Test Date | :2021-03-16 |
| Test Frequency | :5510 MHz | Temp./Humi. | :22.7/63 |
| Test Mode | :Bandedge CH Low | Antenna Pol. | :HORIZONTAL |
| EUT Pol | :H Plane | Engineer | :Ricky |

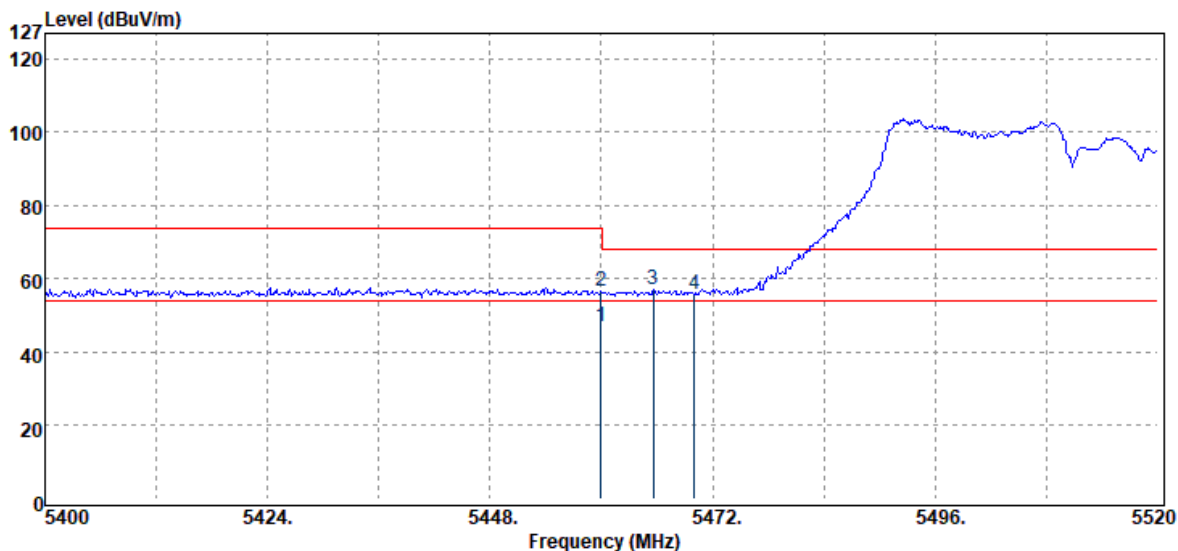

| Freq. MHz | Detector Mode PK/QP/AV | Spectrum Reading Level dB μ V | Factor dB | Actual FS dB μ V/m | Limit @3m dB μ V/m | Margin dB |
|--------------|------------------------------|---|--------------|------------------------------|------------------------------|--------------|
| 5460.00 | Average | 37.26 | 9.63 | 46.89 | 54.00 | -7.11 |
| 5460.00 | Peak | 46.85 | 9.63 | 56.48 | 74.00 | -17.52 |
| 5465.64 | Peak | 47.41 | 9.67 | 57.08 | 68.20 | -11.12 |
| 5470.00 | Peak | 45.90 | 9.71 | 55.61 | 68.20 | -12.59 |

Unless otherwise stated the results shown in this test report refer only to the sample(s) tested and such sample(s) are retained for 90 days only.

除非另有說明，此報告結果僅對測試之樣品負責，同時此樣品僅保留90天。本報告未經本公司書面許可，不可部份複製。

This document is issued by the Company subject to its General Conditions of Service printed overleaf, available on request or accessible at <http://www.sgs.com.tw/Terms-and-Conditions> and for electronic format documents, subject to Terms and Conditions for Electronic Documents at <http://www.sgs.com.tw/Terms-and-Conditions>. Attention is drawn to the limitation of liability, indemnification and jurisdiction issues defined therein. Any holder of this document is advised that information contained hereon reflects the Company's findings at the time of its intervention only and within the limits of Client's instructions, if any. The Company's sole responsibility is to its Client and this document does not exonerate parties to a transaction from exercising all their rights and obligations under the transaction documents. This document cannot be reproduced except in full, without prior written approval of the Company. Any unauthorized alteration, forgery or falsification of the content or appearance of this document is unlawful and offenders may be prosecuted to the fullest extent of the law.

| | | | |
|----------------|---------------------|--------------|------------------|
| Report Number | :ER-2021-20085 | Test Site | :SAC III Chamber |
| Operation Mode | :802.11ax40 RU full | Test Date | :2021-03-16 |
| Test Frequency | :5670 MHz | Temp./Humi. | :22.7/63 |
| Test Mode | :Bandedge CH High | Antenna Pol. | :VERTICAL |
| EUT Pol | :H Plane | Engineer | :Ricky |

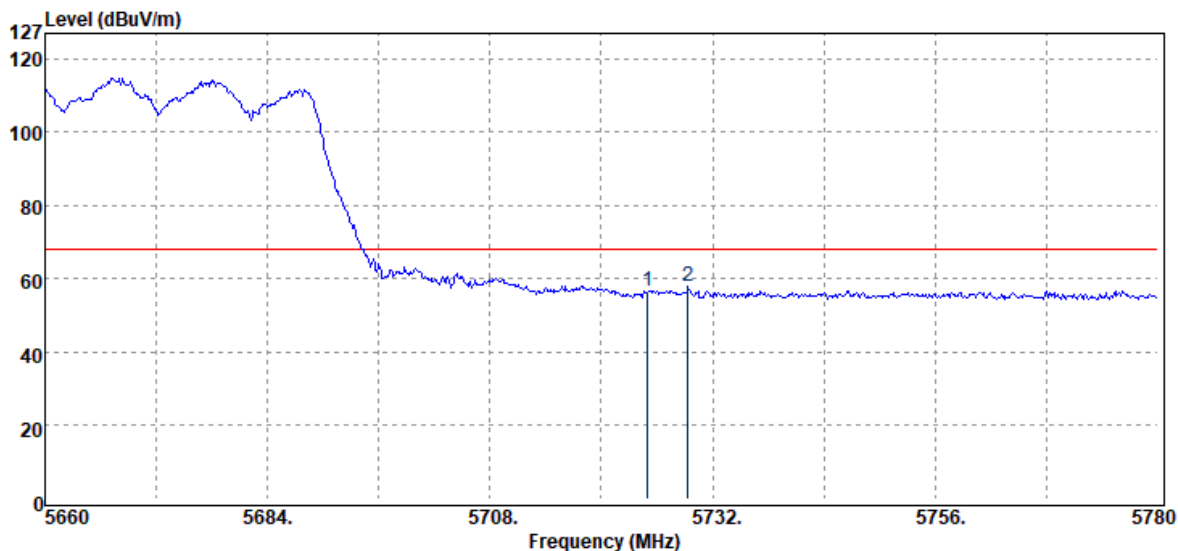

| Freq. MHz | Detector Mode PK/QP/AV | Spectrum Reading Level dBμV | Factor dB | Actual FS dBμV/m | Limit @3m dBμV/m | Margin dB |
|--------------|------------------------------|-----------------------------------|--------------|------------------------|------------------------|--------------|
| 5725.00 | Peak | 48.36 | 8.12 | 56.48 | 68.20 | -11.72 |
| 5729.36 | Peak | 49.98 | 8.14 | 58.12 | 68.20 | -10.08 |

Unless otherwise stated the results shown in this test report refer only to the sample(s) tested and such sample(s) are retained for 90 days only.

除非另有說明，此報告結果僅對測試之樣品負責，同時此樣品僅保留90天。本報告未經本公司書面許可，不可部份複製。

This document is issued by the Company subject to its General Conditions of Service printed overleaf, available on request or accessible at <http://www.sgs.com.tw/Terms-and-Conditions> and for electronic format documents, subject to Terms and Conditions for Electronic Documents at <http://www.sgs.com.tw/Terms-and-Conditions>. Attention is drawn to the limitation of liability, indemnification and jurisdiction issues defined therein. Any holder of this document is advised that information contained hereon reflects the Company's findings at the time of its intervention only and within the limits of Client's instructions, if any. The Company's sole responsibility is to its Client and this document does not exonerate parties to a transaction from exercising all their rights and obligations under the transaction documents. This document cannot be reproduced except in full, without prior written approval of the Company. Any unauthorized alteration, forgery or falsification of the content or appearance of this document is unlawful and offenders may be prosecuted to the fullest extent of the law.

| | | | |
|----------------|---------------------|--------------|------------------|
| Report Number | :ER-2021-20085 | Test Site | :SAC III Chamber |
| Operation Mode | :802.11ax40 RU full | Test Date | :2021-03-16 |
| Test Frequency | :5670 MHz | Temp./Humi. | :22.7/63 |
| Test Mode | :Bandedge CH High | Antenna Pol. | :HORIZONTAL |
| EUT Pol | :H Plane | Engineer | :Ricky |

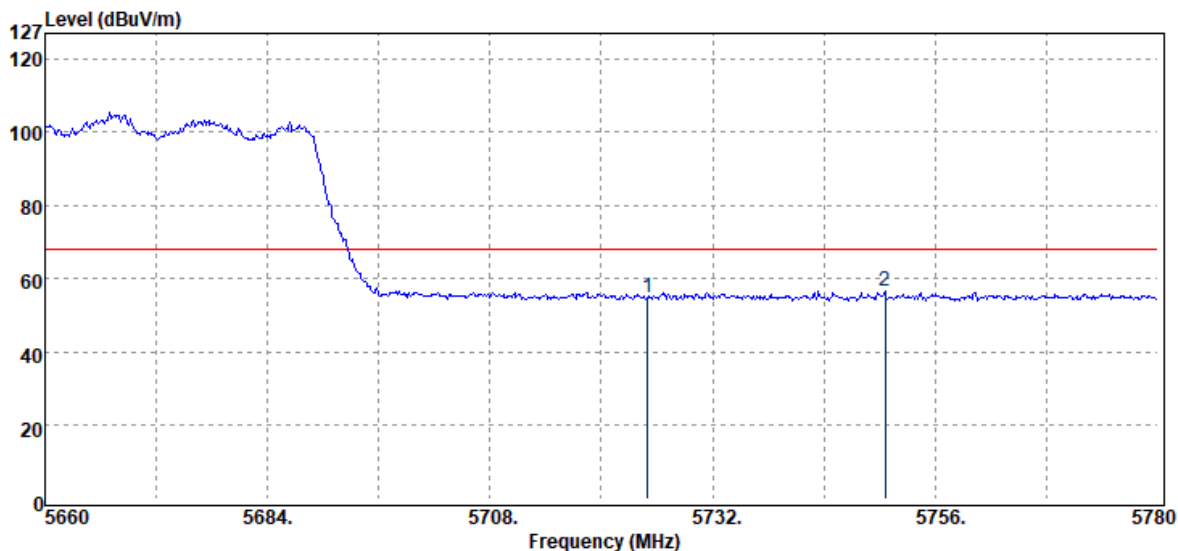

| Freq. MHz | Detector Mode PK/QP/AV | Spectrum Reading Level dB μ V | Factor dB | Actual FS dB μ V/m | Limit @3m dB μ V/m | Margin dB |
|--------------|------------------------------|---|--------------|------------------------------|------------------------------|--------------|
| 5725.00 | Peak | 46.99 | 8.12 | 55.11 | 68.20 | -13.09 |
| 5750.60 | Peak | 48.37 | 8.22 | 56.59 | 68.20 | -11.61 |

Unless otherwise stated the results shown in this test report refer only to the sample(s) tested and such sample(s) are retained for 90 days only.

除非另有說明，此報告結果僅對測試之樣品負責，同時此樣品僅保留90天。本報告未經本公司書面許可，不可部份複製。

This document is issued by the Company subject to its General Conditions of Service printed overleaf, available on request or accessible at <http://www.sgs.com.tw/Terms-and-Conditions> and for electronic format documents, subject to Terms and Conditions for Electronic Documents at <http://www.sgs.com.tw/Terms-and-Conditions>. Attention is drawn to the limitation of liability, indemnification and jurisdiction issues defined therein. Any holder of this document is advised that information contained hereon reflects the Company's findings at the time of its intervention only and within the limits of Client's instructions, if any. The Company's sole responsibility is to its Client and this document does not exonerate parties to a transaction from exercising all their rights and obligations under the transaction documents. This document cannot be reproduced except in full, without prior written approval of the Company. Any unauthorized alteration, forgery or falsification of the content or appearance of this document is unlawful and offenders may be prosecuted to the fullest extent of the law.

| | | | |
|----------------|-----------------------|--------------|------------------|
| Report Number | :ER-2021-20085 | Test Site | :SAC III Chamber |
| Operation Mode | :802.11ax40 RU 242/62 | Test Date | :2021-03-16 |
| Test Frequency | :5670 MHz | Temp./Humi. | :22.7/63 |
| Test Mode | :Bandedge CH High | Antenna Pol. | :VERTICAL |
| EUT Pol | :H Plane | Engineer | :Ricky |

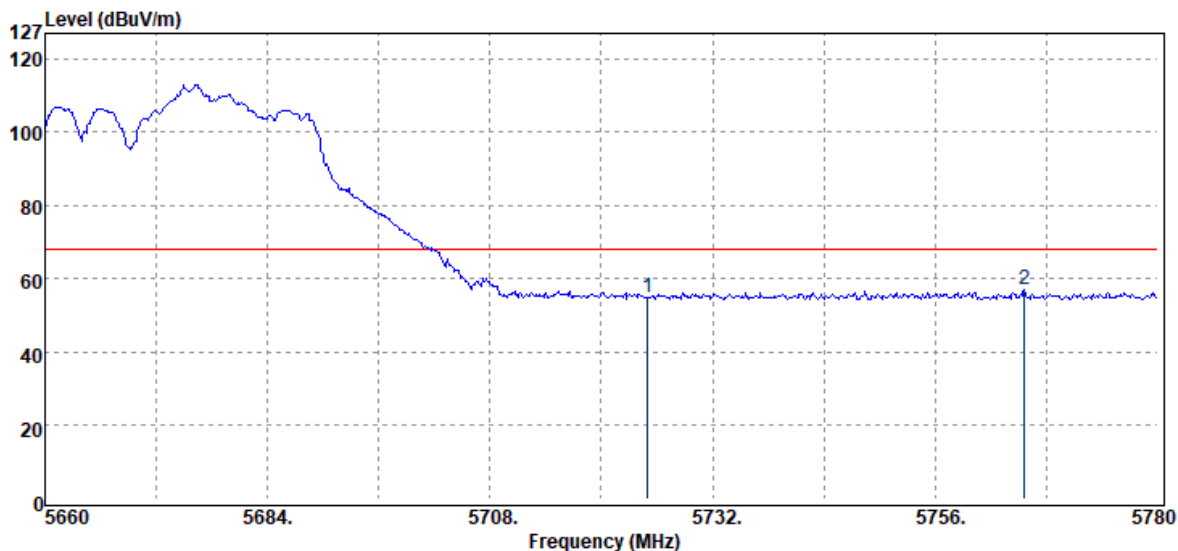

| Freq. MHz | Detector Mode PK/QP/AV | Spectrum Reading Level dB μ V | Factor dB | Actual FS dB μ V/m | Limit @3m dB μ V/m | Margin dB |
|--------------|------------------------------|---|--------------|------------------------------|------------------------------|--------------|
| 5725.00 | Peak | 46.98 | 8.12 | 55.10 | 68.20 | -13.10 |
| 5765.60 | Peak | 48.98 | 8.28 | 57.26 | 68.20 | -10.94 |

Unless otherwise stated the results shown in this test report refer only to the sample(s) tested and such sample(s) are retained for 90 days only.

除非另有說明，此報告結果僅對測試之樣品負責，同時此樣品僅保留90天。本報告未經本公司書面許可，不可部份複製。

This document is issued by the Company subject to its General Conditions of Service printed overleaf, available on request or accessible at <http://www.sgs.com.tw/Terms-and-Conditions> and for electronic format documents, subject to Terms and Conditions for Electronic Documents at <http://www.sgs.com.tw/Terms-and-Conditions>. Attention is drawn to the limitation of liability, indemnification and jurisdiction issues defined therein. Any holder of this document is advised that information contained hereon reflects the Company's findings at the time of its intervention only and within the limits of Client's instructions, if any. The Company's sole responsibility is to its Client and this document does not exonerate parties to a transaction from exercising all their rights and obligations under the transaction documents. This document cannot be reproduced except in full, without prior written approval of the Company. Any unauthorized alteration, forgery or falsification of the content or appearance of this document is unlawful and offenders may be prosecuted to the fullest extent of the law.

| | | | |
|----------------|-----------------------|--------------|------------------|
| Report Number | :ER-2021-20085 | Test Site | :SAC III Chamber |
| Operation Mode | :802.11ax40 RU 242/62 | Test Date | :2021-03-16 |
| Test Frequency | :5670 MHz | Temp./Humi. | :22.7/63 |
| Test Mode | :Bandedge CH High | Antenna Pol. | :HORIZONTAL |
| EUT Pol | :H Plane | Engineer | :Ricky |

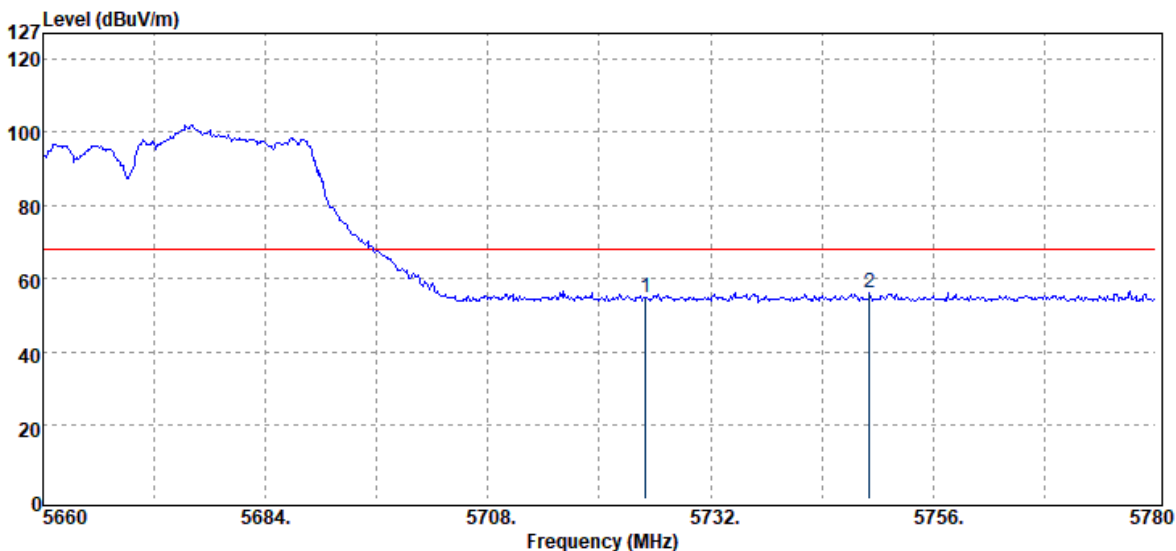

| Freq. MHz | Detector Mode PK/QP/AV | Spectrum Reading Level dBµV | Factor dB | Actual FS dBµV/m | Limit @3m dBµV/m | Margin dB |
|--------------|------------------------------|-----------------------------------|--------------|------------------------|------------------------|--------------|
| 5725.00 | Peak | 46.70 | 8.12 | 54.82 | 68.20 | -13.38 |
| 5749.16 | Peak | 48.25 | 8.21 | 56.46 | 68.20 | -11.74 |

Unless otherwise stated the results shown in this test report refer only to the sample(s) tested and such sample(s) are retained for 90 days only.

除非另有說明，此報告結果僅對測試之樣品負責，同時此樣品僅保留90天。本報告未經本公司書面許可，不可部份複製。

This document is issued by the Company subject to its General Conditions of Service printed overleaf, available on request or accessible at <http://www.sgs.com.tw/Terms-and-Conditions> and for electronic format documents, subject to Terms and Conditions for Electronic Documents at <http://www.sgs.com.tw/Terms-and-Conditions>. Attention is drawn to the limitation of liability, indemnification and jurisdiction issues defined therein. Any holder of this document is advised that information contained hereon reflects the Company's findings at the time of its intervention only and within the limits of Client's instructions, if any. The Company's sole responsibility is to its Client and this document does not exonerate parties to a transaction from exercising all their rights and obligations under the transaction documents. This document cannot be reproduced except in full, without prior written approval of the Company. Any unauthorized alteration, forgery or falsification of the content or appearance of this document is unlawful and offenders may be prosecuted to the fullest extent of the law.

Report Number :ER-2021-20085
 Operation Mode :802.11ax40 RU full
 Test Frequency :5755 MHz
 Test Mode :Bandedge CH Low
 EUT Pol :H Plane

Test Site :SAC III Chamber
 Test Date :2021-03-16
 Temp./Humi. :22.7/63
 Antenna Pol. :VERTICAL
 Engineer :Ricky

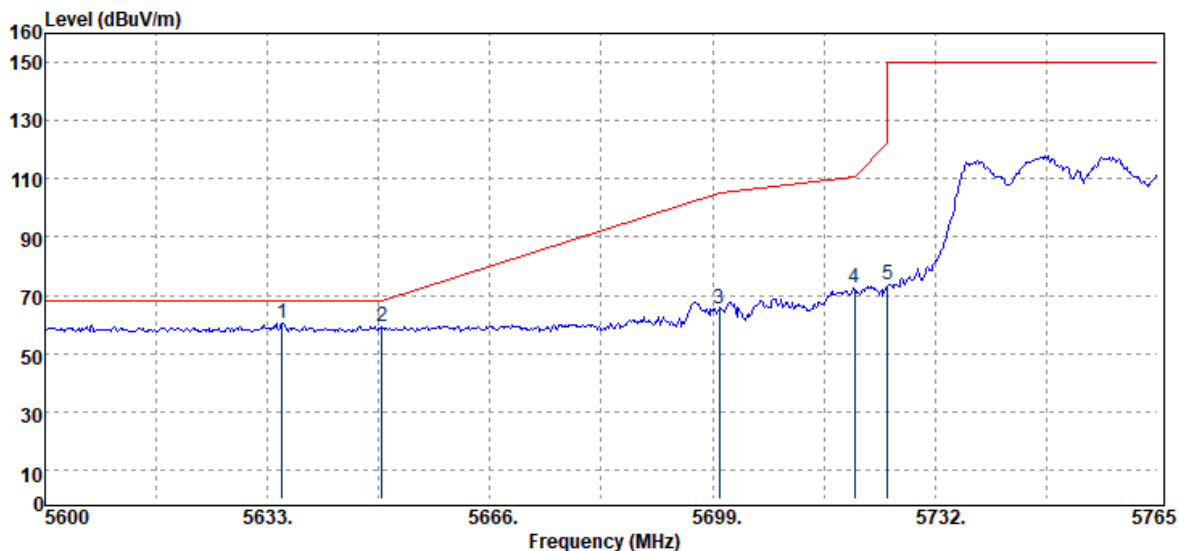

| Freq. MHz | Detector Mode PK/QP/AV | Spectrum Reading Level dBμV | Factor dB | Actual FS dBμV/m | Limit @3m dBμV/m | Margin dB |
|--------------|------------------------------|-----------------------------------|--------------|------------------------|------------------------|--------------|
| 5635.15 | Peak | 52.35 | 8.19 | 60.54 | 68.20 | -7.66 |
| 5650.00 | Peak | 51.13 | 8.08 | 59.21 | 68.20 | -8.99 |
| 5700.00 | Peak | 57.36 | 8.02 | 65.38 | 105.20 | -39.82 |
| 5720.00 | Peak | 64.47 | 8.10 | 72.57 | 110.80 | -38.23 |
| 5725.00 | Peak | 65.42 | 8.12 | 73.54 | 122.20 | -48.66 |

Unless otherwise stated the results shown in this test report refer only to the sample(s) tested and such sample(s) are retained for 90 days only.

除非另有說明，此報告結果僅對測試之樣品負責，同時此樣品僅保留90天。本報告未經本公司書面許可，不可部份複製。

This document is issued by the Company subject to its General Conditions of Service printed overleaf, available on request or accessible at <http://www.sgs.com.tw/Terms-and-Conditions> and for electronic format documents, subject to Terms and Conditions for Electronic Documents at <http://www.sgs.com.tw/Terms-and-Conditions>. Attention is drawn to the limitation of liability, indemnification and jurisdiction issues defined therein. Any holder of this document is advised that information contained hereon reflects the Company's findings at the time of its intervention only and within the limits of Client's instructions, if any. The Company's sole responsibility is to its Client and this document does not exonerate parties to a transaction from exercising all their rights and obligations under the transaction documents. This document cannot be reproduced except in full, without prior written approval of the Company. Any unauthorized alteration, forgery or falsification of the content or appearance of this document is unlawful and offenders may be prosecuted to the fullest extent of the law.

Report Number :ER-2021-20085
 Operation Mode :802.11ax40 RU full
 Test Frequency :5755 MHz
 Test Mode :Bandedge CH Low
 EUT Pol :H Plane

Test Site :SAC III Chamber
 Test Date :2021-03-16
 Temp./Humi. :22.7/63
 Antenna Pol. :HORIZONTAL
 Engineer :Ricky

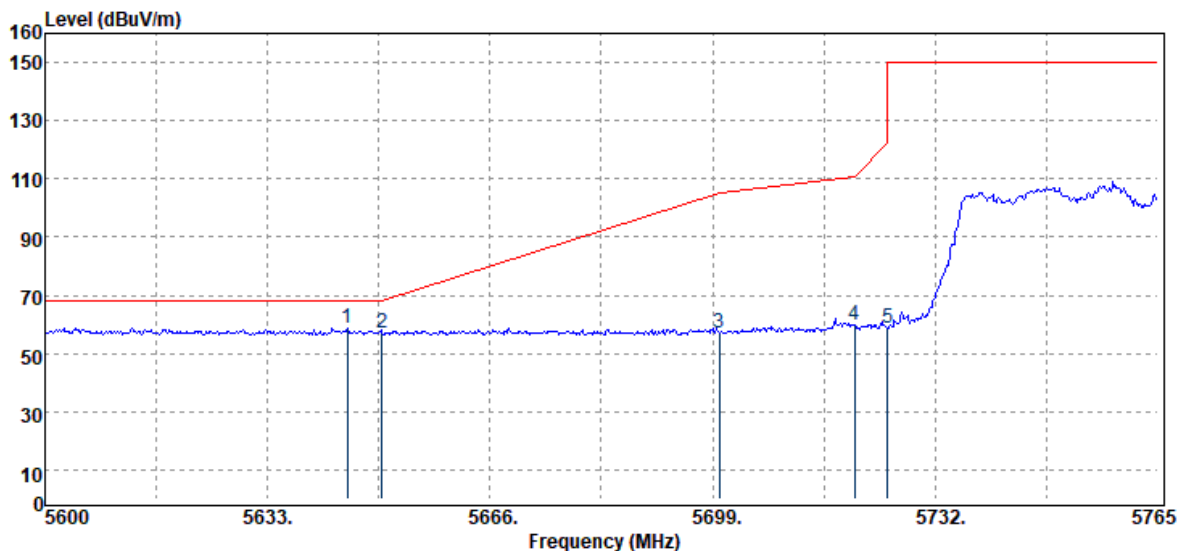

| Freq. MHz | Detector Mode PK/QP/AV | Spectrum Reading Level dB μ V | Factor dB | Actual FS dB μ V/m | Limit @3m dB μ V/m | Margin dB |
|--------------|------------------------------|---|--------------|------------------------------|------------------------------|--------------|
| 5644.88 | Peak | 50.50 | 8.12 | 58.62 | 68.20 | -9.58 |
| 5650.00 | Peak | 48.70 | 8.08 | 56.78 | 68.20 | -11.42 |
| 5700.00 | Peak | 49.15 | 8.02 | 57.17 | 105.20 | -48.03 |
| 5720.00 | Peak | 51.52 | 8.10 | 59.62 | 110.80 | -51.18 |
| 5725.00 | Peak | 50.57 | 8.12 | 58.69 | 122.20 | -63.51 |

Unless otherwise stated the results shown in this test report refer only to the sample(s) tested and such sample(s) are retained for 90 days only.

除非另有說明，此報告結果僅對測試之樣品負責，同時此樣品僅保留90天。本報告未經本公司書面許可，不可部份複製。

This document is issued by the Company subject to its General Conditions of Service printed overleaf, available on request or accessible at <http://www.sgs.com.tw/Terms-and-Conditions> and for electronic format documents, subject to Terms and Conditions for Electronic Documents at <http://www.sgs.com.tw/Terms-and-Conditions>. Attention is drawn to the limitation of liability, indemnification and jurisdiction issues defined therein. Any holder of this document is advised that information contained hereon reflects the Company's findings at the time of its intervention only and within the limits of Client's instructions, if any. The Company's sole responsibility is to its Client and this document does not exonerate parties to a transaction from exercising all their rights and obligations under the transaction documents. This document cannot be reproduced except in full, without prior written approval of the Company. Any unauthorized alteration, forgery or falsification of the content or appearance of this document is unlawful and offenders may be prosecuted to the fullest extent of the law.

Report Number :ER-2021-20085
 Operation Mode :802.11ax40 RU 242/61
 Test Frequency :5755 MHz
 Test Mode :Bandedge CH Low
 EUT Pol :H Plane

Test Site :SAC III Chamber
 Test Date :2021-03-16
 Temp./Humi. :22.7/63
 Antenna Pol. :VERTICAL
 Engineer :Ricky

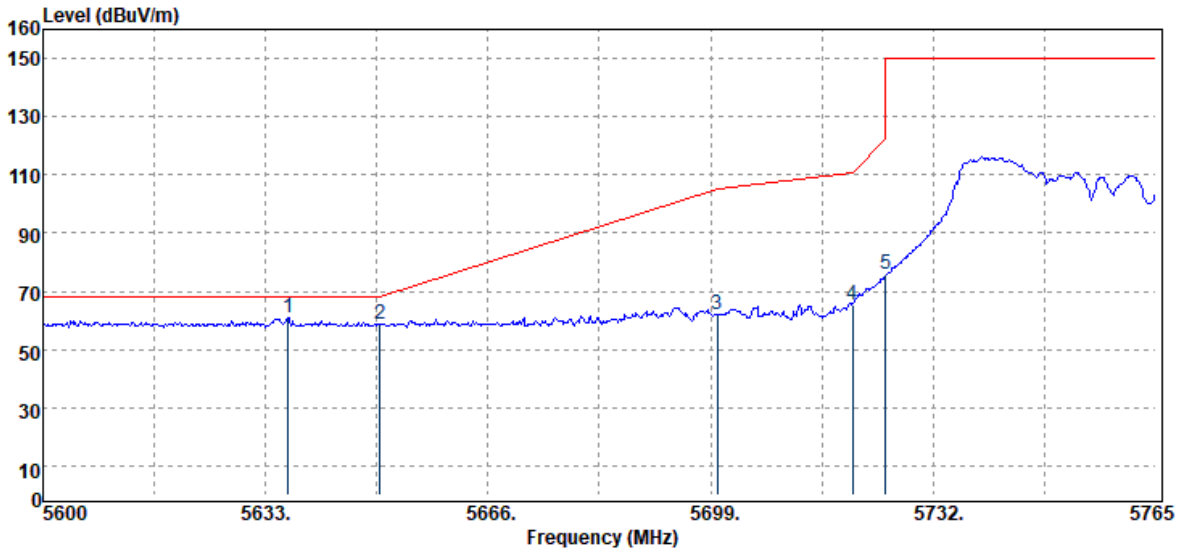

| Freq. MHz | Detector Mode PK/QP/AV | Spectrum Reading Level dB μ V | Factor dB | Actual FS dB μ V/m | Limit @3m dB μ V/m | Margin dB |
|--------------|------------------------------|---|--------------|------------------------------|------------------------------|--------------|
| 5636.30 | Peak | 52.97 | 8.18 | 61.15 | 68.20 | -7.05 |
| 5650.00 | Peak | 50.34 | 8.08 | 58.42 | 68.20 | -9.78 |
| 5700.00 | Peak | 53.83 | 8.02 | 61.85 | 105.20 | -43.35 |
| 5720.00 | Peak | 57.34 | 8.10 | 65.44 | 110.80 | -45.36 |
| 5725.00 | Peak | 67.55 | 8.12 | 75.67 | 122.20 | -46.53 |

Unless otherwise stated the results shown in this test report refer only to the sample(s) tested and such sample(s) are retained for 90 days only.

除非另有說明，此報告結果僅對測試之樣品負責，同時此樣品僅保留90天。本報告未經本公司書面許可，不可部份複製。

This document is issued by the Company subject to its General Conditions of Service printed overleaf, available on request or accessible at <http://www.sgs.com.tw/Terms-and-Conditions> and for electronic format documents, subject to Terms and Conditions for Electronic Documents at <http://www.sgs.com.tw/Terms-and-Conditions>. Attention is drawn to the limitation of liability, indemnification and jurisdiction issues defined therein. Any holder of this document is advised that information contained hereon reflects the Company's findings at the time of its intervention only and within the limits of Client's instructions, if any. The Company's sole responsibility is to its Client and this document does not exonerate parties to a transaction from exercising all their rights and obligations under the transaction documents. This document cannot be reproduced except in full, without prior written approval of the Company. Any unauthorized alteration, forgery or falsification of the content or appearance of this document is unlawful and offenders may be prosecuted to the fullest extent of the law.

| | | | |
|----------------|-----------------------|--------------|------------------|
| Report Number | :ER-2021-20085 | Test Site | :SAC III Chamber |
| Operation Mode | :802.11ax40 RU 242/61 | Test Date | :2021-03-16 |
| Test Frequency | :5755 MHz | Temp./Humi. | :22.7/63 |
| Test Mode | :Bandedge CH Low | Antenna Pol. | :HORIZONTAL |
| EUT Pol | :H Plane | Engineer | :Ricky |

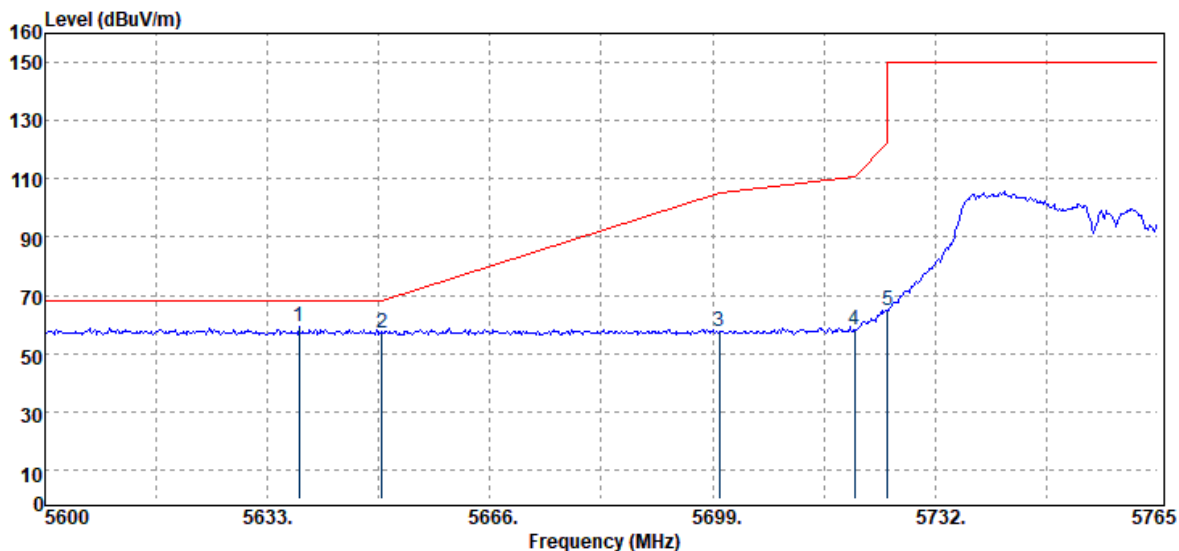

| Freq. MHz | Detector Mode PK/QP/AV | Spectrum Reading Level dB μ V | Factor dB | Actual FS dB μ V/m | Limit @3m dB μ V/m | Margin dB |
|--------------|------------------------------|---|--------------|------------------------------|------------------------------|--------------|
| 5637.62 | Peak | 51.21 | 8.17 | 59.38 | 68.20 | -8.82 |
| 5650.00 | Peak | 48.81 | 8.08 | 56.89 | 68.20 | -11.31 |
| 5700.00 | Peak | 49.46 | 8.02 | 57.48 | 105.20 | -47.72 |
| 5720.00 | Peak | 49.90 | 8.10 | 58.00 | 110.80 | -52.80 |
| 5725.00 | Peak | 56.82 | 8.12 | 64.94 | 122.20 | -57.26 |

Unless otherwise stated the results shown in this test report refer only to the sample(s) tested and such sample(s) are retained for 90 days only.

除非另有說明，此報告結果僅對測試之樣品負責，同時此樣品僅保留90天。本報告未經本公司書面許可，不可部份複製。

This document is issued by the Company subject to its General Conditions of Service printed overleaf, available on request or accessible at <http://www.sgs.com.tw/Terms-and-Conditions> and for electronic format documents, subject to Terms and Conditions for Electronic Documents at <http://www.sgs.com.tw/Terms-and-Conditions>. Attention is drawn to the limitation of liability, indemnification and jurisdiction issues defined therein. Any holder of this document is advised that information contained hereon reflects the Company's findings at the time of its intervention only and within the limits of Client's instructions, if any. The Company's sole responsibility is to its Client and this document does not exonerate parties to a transaction from exercising all their rights and obligations under the transaction documents. This document cannot be reproduced except in full, without prior written approval of the Company. Any unauthorized alteration, forgery or falsification of the content or appearance of this document is unlawful and offenders may be prosecuted to the fullest extent of the law.

| | | | |
|----------------|---------------------|--------------|------------------|
| Report Number | :ER-2021-20085 | Test Site | :SAC III Chamber |
| Operation Mode | :802.11ax40 RU full | Test Date | :2021-03-16 |
| Test Frequency | :5795 MHz | Temp./Humi. | :22.7/63 |
| Test Mode | :Bandedge CH High | Antenna Pol. | :VERTICAL |
| EUT Pol | :H Plane | Engineer | :Ricky |

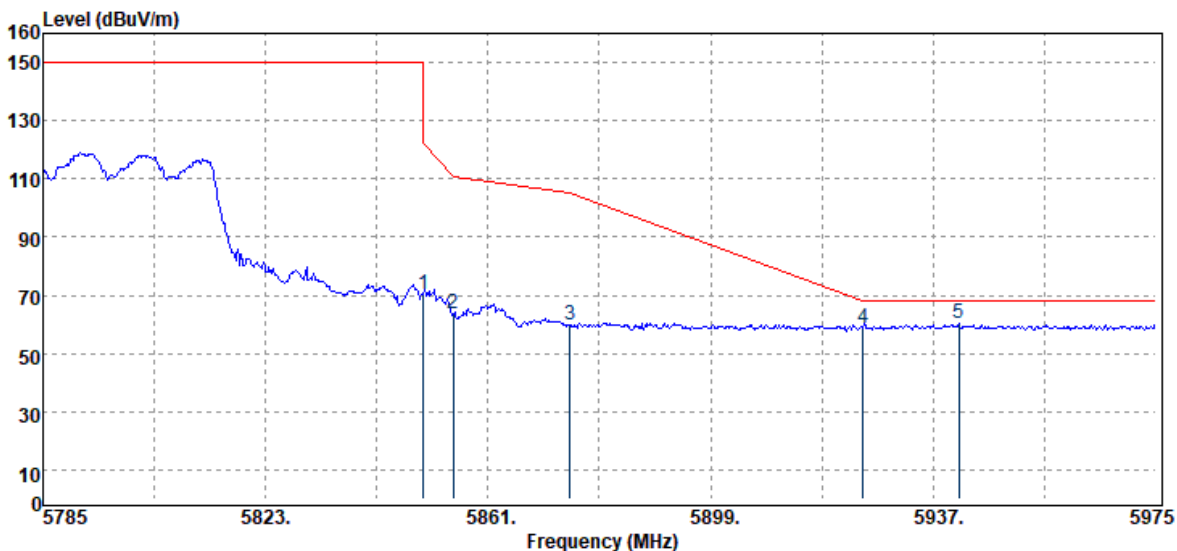

| Freq. MHz | Detector Mode PK/QP/AV | Spectrum Reading Level dB μ V | Factor dB | Actual FS dB μ V/m | Limit @3m dB μ V/m | Margin dB |
|--------------|------------------------------|---|--------------|------------------------------|------------------------------|--------------|
| 5850.00 | Peak | 61.02 | 9.02 | 70.04 | 122.20 | -52.16 |
| 5855.00 | Peak | 54.36 | 9.07 | 63.43 | 110.80 | -47.37 |
| 5875.00 | Peak | 50.35 | 9.27 | 59.62 | 105.20 | -45.58 |
| 5925.00 | Peak | 49.25 | 9.70 | 58.95 | 68.20 | -9.25 |
| 5941.37 | Peak | 50.54 | 9.82 | 60.36 | 68.20 | -7.84 |

Unless otherwise stated the results shown in this test report refer only to the sample(s) tested and such sample(s) are retained for 90 days only.

除非另有說明，此報告結果僅對測試之樣品負責，同時此樣品僅保留90天。本報告未經本公司書面許可，不可部份複製。

This document is issued by the Company subject to its General Conditions of Service printed overleaf, available on request or accessible at <http://www.sgs.com.tw/Terms-and-Conditions> and for electronic format documents, subject to Terms and Conditions for Electronic Documents at <http://www.sgs.com.tw/Terms-and-Conditions>. Attention is drawn to the limitation of liability, indemnification and jurisdiction issues defined therein. Any holder of this document is advised that information contained hereon reflects the Company's findings at the time of its intervention only and within the limits of Client's instructions, if any. The Company's sole responsibility is to its Client and this document does not exonerate parties to a transaction from exercising all their rights and obligations under the transaction documents. This document cannot be reproduced except in full, without prior written approval of the Company. Any unauthorized alteration, forgery or falsification of the content or appearance of this document is unlawful and offenders may be prosecuted to the fullest extent of the law.

| | | | |
|----------------|---------------------|--------------|------------------|
| Report Number | :ER-2021-20085 | Test Site | :SAC III Chamber |
| Operation Mode | :802.11ax40 RU full | Test Date | :2021-03-16 |
| Test Frequency | :5795 MHz | Temp./Humi. | :22.7/63 |
| Test Mode | :Bandedge CH High | Antenna Pol. | :HORIZONTAL |
| EUT Pol | :H Plane | Engineer | :Ricky |

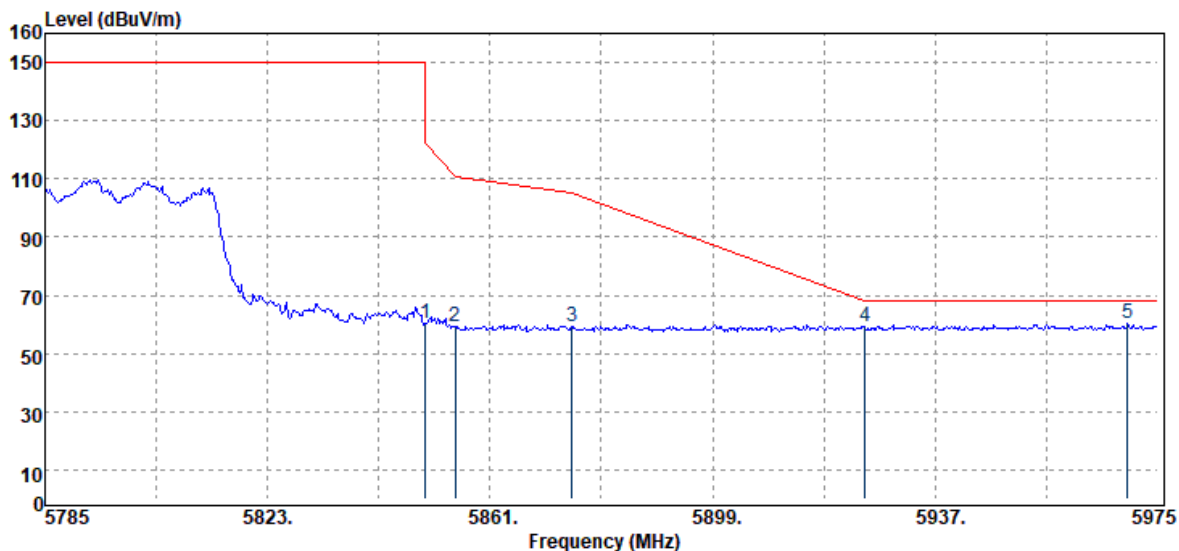

| Freq. MHz | Detector Mode PK/QP/AV | Spectrum Reading Level dB μ V | Factor dB | Actual FS dB μ V/m | Limit @3m dB μ V/m | Margin dB |
|--------------|------------------------------|---|--------------|------------------------------|------------------------------|--------------|
| 5850.00 | Peak | 51.37 | 9.02 | 60.39 | 122.20 | -61.81 |
| 5855.00 | Peak | 50.26 | 9.07 | 59.33 | 110.80 | -51.47 |
| 5875.00 | Peak | 49.79 | 9.27 | 59.06 | 105.20 | -46.14 |
| 5925.00 | Peak | 49.34 | 9.70 | 59.04 | 68.20 | -9.16 |
| 5969.87 | Peak | 50.56 | 9.98 | 60.54 | 68.20 | -7.66 |

Unless otherwise stated the results shown in this test report refer only to the sample(s) tested and such sample(s) are retained for 90 days only.

除非另有說明，此報告結果僅對測試之樣品負責，同時此樣品僅保留90天。本報告未經本公司書面許可，不可部份複製。

This document is issued by the Company subject to its General Conditions of Service printed overleaf, available on request or accessible at <http://www.sgs.com.tw/Terms-and-Conditions> and for electronic format documents, subject to Terms and Conditions for Electronic Documents at <http://www.sgs.com.tw/Terms-and-Conditions>. Attention is drawn to the limitation of liability, indemnification and jurisdiction issues defined therein. Any holder of this document is advised that information contained hereon reflects the Company's findings at the time of its intervention only and within the limits of Client's instructions, if any. The Company's sole responsibility is to its Client and this document does not exonerate parties to a transaction from exercising all their rights and obligations under the transaction documents. This document cannot be reproduced except in full, without prior written approval of the Company. Any unauthorized alteration, forgery or falsification of the content or appearance of this document is unlawful and offenders may be prosecuted to the fullest extent of the law.

| | | | |
|----------------|-----------------------|--------------|------------------|
| Report Number | :ER-2021-20085 | Test Site | :SAC III Chamber |
| Operation Mode | :802.11ax40 RU 242/62 | Test Date | :2021-03-16 |
| Test Frequency | :5795 MHz | Temp./Humi. | :22.7/63 |
| Test Mode | :Bandedge CH High | Antenna Pol. | :VERTICAL |
| EUT Pol | :H Plane | Engineer | :Ricky |

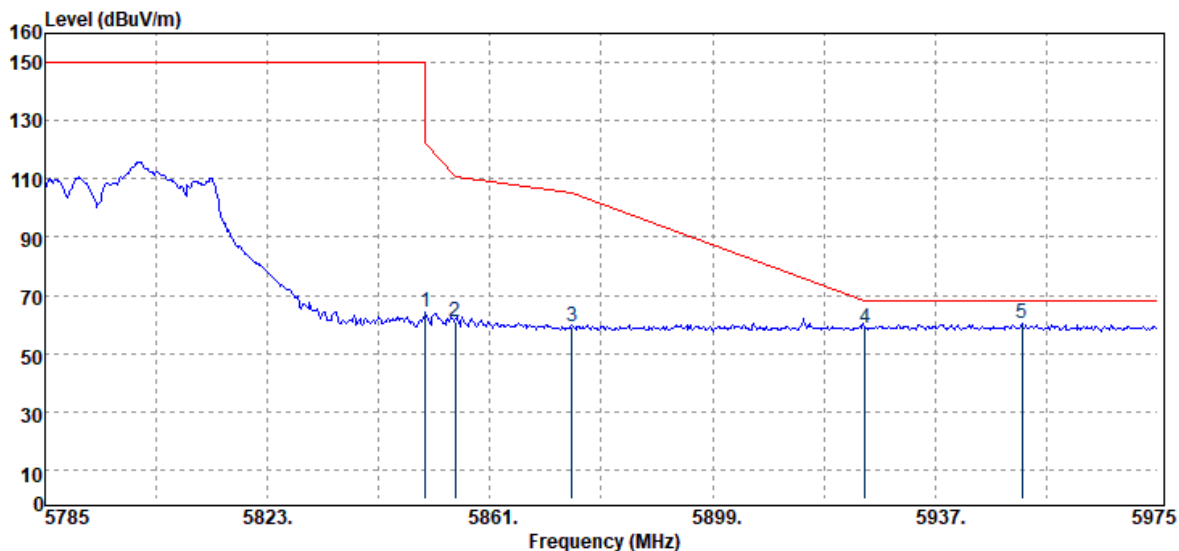

| Freq. MHz | Detector Mode PK/QP/AV | Spectrum Reading Level dB μ V | Factor dB | Actual FS dB μ V/m | Limit @3m dB μ V/m | Margin dB |
|--------------|------------------------------|---|--------------|------------------------------|------------------------------|--------------|
| 5850.00 | Peak | 55.02 | 9.02 | 64.04 | 122.20 | -58.16 |
| 5855.00 | Peak | 51.78 | 9.07 | 60.85 | 110.80 | -49.95 |
| 5875.00 | Peak | 50.17 | 9.27 | 59.44 | 105.20 | -45.76 |
| 5925.00 | Peak | 48.97 | 9.70 | 58.67 | 68.20 | -9.53 |
| 5951.82 | Peak | 50.37 | 9.89 | 60.26 | 68.20 | -7.94 |

Unless otherwise stated the results shown in this test report refer only to the sample(s) tested and such sample(s) are retained for 90 days only.

除非另有說明，此報告結果僅對測試之樣品負責，同時此樣品僅保留90天。本報告未經本公司書面許可，不可部份複製。

This document is issued by the Company subject to its General Conditions of Service printed overleaf, available on request or accessible at <http://www.sgs.com.tw/Terms-and-Conditions> and for electronic format documents, subject to Terms and Conditions for Electronic Documents at <http://www.sgs.com.tw/Terms-and-Conditions>. Attention is drawn to the limitation of liability, indemnification and jurisdiction issues defined therein. Any holder of this document is advised that information contained hereon reflects the Company's findings at the time of its intervention only and within the limits of Client's instructions, if any. The Company's sole responsibility is to its Client and this document does not exonerate parties to a transaction from exercising all their rights and obligations under the transaction documents. This document cannot be reproduced except in full, without prior written approval of the Company. Any unauthorized alteration, forgery or falsification of the content or appearance of this document is unlawful and offenders may be prosecuted to the fullest extent of the law.

| | | | |
|----------------|-----------------------|--------------|------------------|
| Report Number | :ER-2021-20085 | Test Site | :SAC III Chamber |
| Operation Mode | :802.11ax40 RU 242/62 | Test Date | :2021-03-16 |
| Test Frequency | :5795 MHz | Temp./Humi. | :22.7/63 |
| Test Mode | :Bandedge CH High | Antenna Pol. | :HORIZONTAL |
| EUT Pol | :H Plane | Engineer | :Ricky |

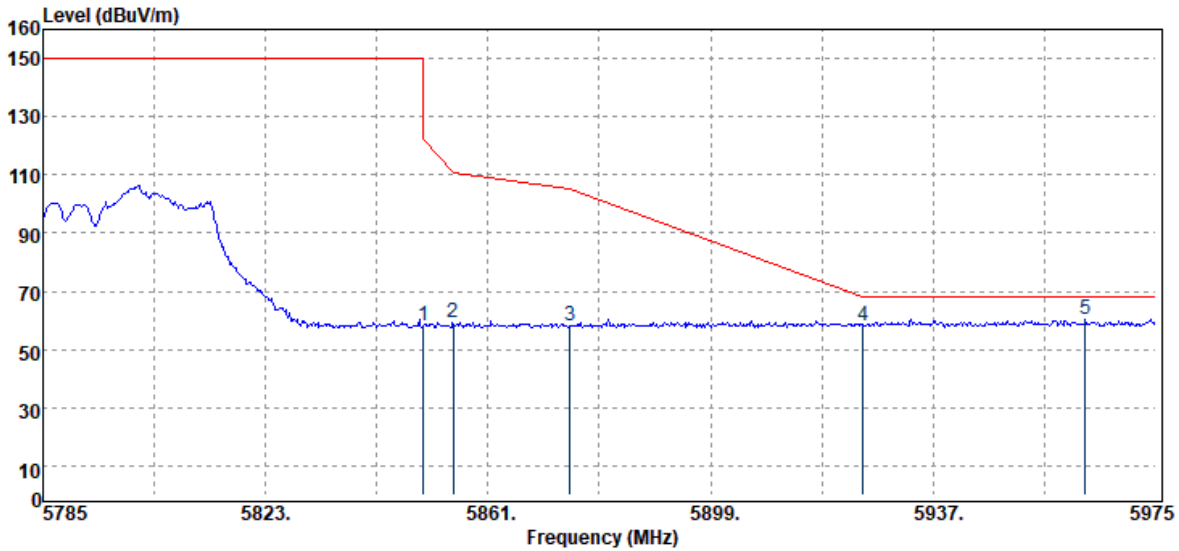

| Freq. MHz | Detector Mode PK/QP/AV | Spectrum Reading Level dB μ V | Factor dB | Actual FS dB μ V/m | Limit @3m dB μ V/m | Margin dB |
|--------------|------------------------------|---|--------------|------------------------------|------------------------------|--------------|
| 5850.00 | Peak | 49.02 | 9.02 | 58.04 | 122.20 | -64.16 |
| 5855.00 | Peak | 49.97 | 9.07 | 59.04 | 110.80 | -51.76 |
| 5875.00 | Peak | 49.05 | 9.27 | 58.32 | 105.20 | -46.88 |
| 5925.00 | Peak | 48.52 | 9.70 | 58.22 | 68.20 | -9.98 |
| 5963.03 | Peak | 50.30 | 9.95 | 60.25 | 68.20 | -7.95 |

Unless otherwise stated the results shown in this test report refer only to the sample(s) tested and such sample(s) are retained for 90 days only.

除非另有說明，此報告結果僅對測試之樣品負責，同時此樣品僅保留90天。本報告未經本公司書面許可，不可部份複製。

This document is issued by the Company subject to its General Conditions of Service printed overleaf, available on request or accessible at <http://www.sgs.com.tw/Terms-and-Conditions> and for electronic format documents, subject to Terms and Conditions for Electronic Documents at <http://www.sgs.com.tw/Terms-and-Conditions>. Attention is drawn to the limitation of liability, indemnification and jurisdiction issues defined therein. Any holder of this document is advised that information contained hereon reflects the Company's findings at the time of its intervention only and within the limits of Client's instructions, if any. The Company's sole responsibility is to its Client and this document does not exonerate parties to a transaction from exercising all their rights and obligations under the transaction documents. This document cannot be reproduced except in full, without prior written approval of the Company. Any unauthorized alteration, forgery or falsification of the content or appearance of this document is unlawful and offenders may be prosecuted to the fullest extent of the law.

| | | | |
|----------------|---------------------|--------------|------------------|
| Report Number | :ER-2021-20085 | Test Site | :SAC III Chamber |
| Operation Mode | :802.11ax80 RU full | Test Date | :2021-03-16 |
| Test Frequency | :5210 MHz | Temp./Humi. | :22.7/63 |
| Test Mode | :Bandedge CH Low | Antenna Pol. | :VERTICAL |
| EUT Pol | :H Plane | Engineer | :Ricky |

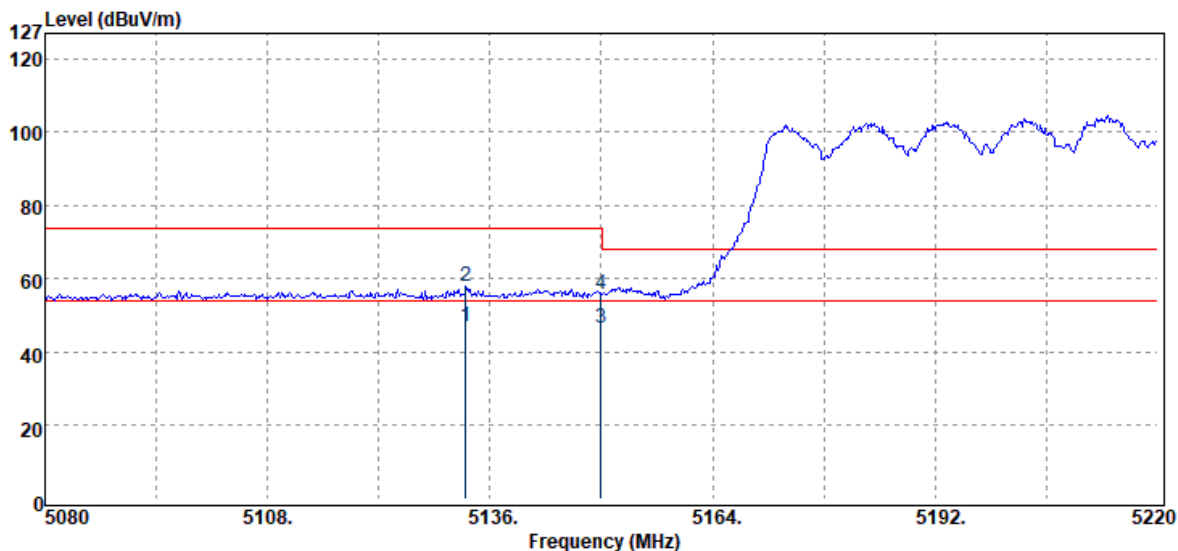

| Freq. MHz | Detector Mode PK/QP/AV | Spectrum Reading Level dB μ V | Factor dB | Actual FS dB μ V/m | Limit @3m dB μ V/m | Margin dB |
|--------------|------------------------------|---|--------------|------------------------------|------------------------------|--------------|
| 5132.92 | Average | 38.39 | 8.55 | 46.94 | 54.00 | -7.06 |
| 5132.92 | Peak | 49.42 | 8.55 | 57.97 | 74.00 | -16.03 |
| 5150.00 | Average | 38.22 | 8.53 | 46.75 | 54.00 | -7.25 |
| 5150.00 | Peak | 47.12 | 8.53 | 55.65 | 74.00 | -18.35 |

Unless otherwise stated the results shown in this test report refer only to the sample(s) tested and such sample(s) are retained for 90 days only.

除非另有說明，此報告結果僅對測試之樣品負責，同時此樣品僅保留90天。本報告未經本公司書面許可，不可部份複製。

This document is issued by the Company subject to its General Conditions of Service printed overleaf, available on request or accessible at <http://www.sgs.com.tw/Terms-and-Conditions> and for electronic format documents, subject to Terms and Conditions for Electronic Documents at <http://www.sgs.com.tw/Terms-and-Conditions>. Attention is drawn to the limitation of liability, indemnification and jurisdiction issues defined therein. Any holder of this document is advised that information contained hereon reflects the Company's findings at the time of its intervention only and within the limits of Client's instructions, if any. The Company's sole responsibility is to its Client and this document does not exonerate parties to a transaction from exercising all their rights and obligations under the transaction documents. This document cannot be reproduced except in full, without prior written approval of the Company. Any unauthorized alteration, forgery or falsification of the content or appearance of this document is unlawful and offenders may be prosecuted to the fullest extent of the law.

| | | | |
|----------------|---------------------|--------------|------------------|
| Report Number | :ER-2021-20085 | Test Site | :SAC III Chamber |
| Operation Mode | :802.11ax80 RU full | Test Date | :2021-03-16 |
| Test Frequency | :5210 MHz | Temp./Humi. | :22.7/63 |
| Test Mode | :Bandedge CH Low | Antenna Pol. | :HORIZONTAL |
| EUT Pol | :H Plane | Engineer | :Ricky |

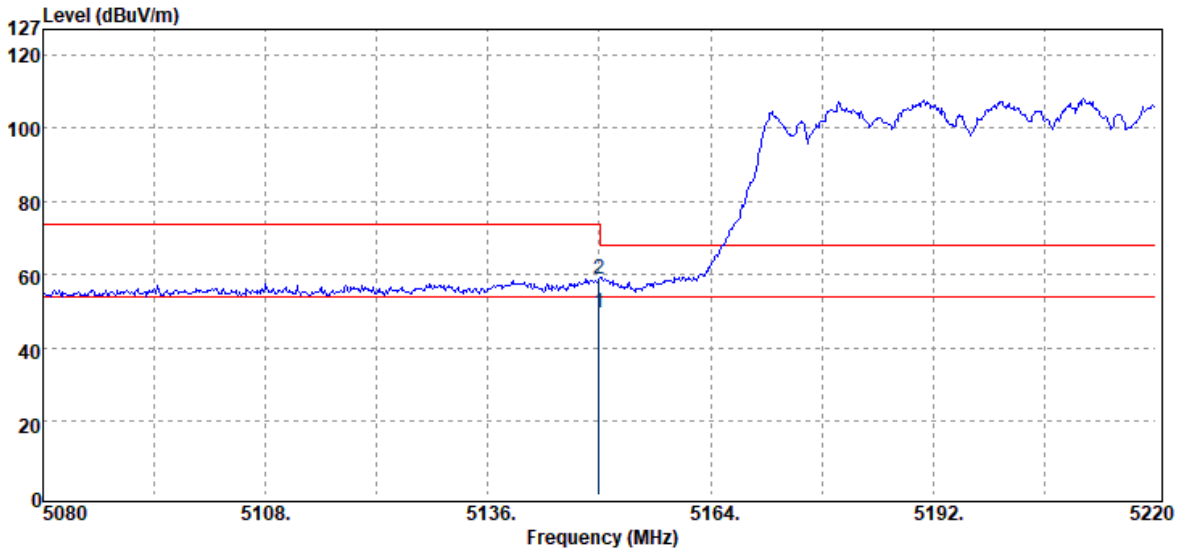

| Freq. MHz | Detector Mode PK/QP/AV | Spectrum Reading Level dB μ V | Factor dB | Actual FS dB μ V/m | Limit @3m dB μ V/m | Margin dB |
|--------------|------------------------------|---|--------------|------------------------------|------------------------------|--------------|
| 5150.00 | Average | 40.93 | 8.53 | 49.46 | 54.00 | -4.54 |
| 5150.00 | Peak | 50.42 | 8.53 | 58.95 | 74.00 | -15.05 |

Unless otherwise stated the results shown in this test report refer only to the sample(s) tested and such sample(s) are retained for 90 days only.

除非另有說明，此報告結果僅對測試之樣品負責，同時此樣品僅保留90天。本報告未經本公司書面許可，不可部份複製。

This document is issued by the Company subject to its General Conditions of Service printed overleaf, available on request or accessible at <http://www.sgs.com.tw/Terms-and-Conditions> and for electronic format documents, subject to Terms and Conditions for Electronic Documents at <http://www.sgs.com.tw/Terms-and-Conditions>. Attention is drawn to the limitation of liability, indemnification and jurisdiction issues defined therein. Any holder of this document is advised that information contained hereon reflects the Company's findings at the time of its intervention only and within the limits of Client's instructions, if any. The Company's sole responsibility is to its Client and this document does not exonerate parties to a transaction from exercising all their rights and obligations under the transaction documents. This document cannot be reproduced except in full, without prior written approval of the Company. Any unauthorized alteration, forgery or falsification of the content or appearance of this document is unlawful and offenders may be prosecuted to the fullest extent of the law.

| | | | |
|----------------|-----------------------|--------------|------------------|
| Report Number | :ER-2021-20085 | Test Site | :SAC III Chamber |
| Operation Mode | :802.11ax80 RU 484/65 | Test Date | :2021-03-16 |
| Test Frequency | :5210 MHz | Temp./Humi. | :22.7/63 |
| Test Mode | :Bandedge CH Low | Antenna Pol. | :VERTICAL |
| EUT Pol | :H Plane | Engineer | :Ricky |

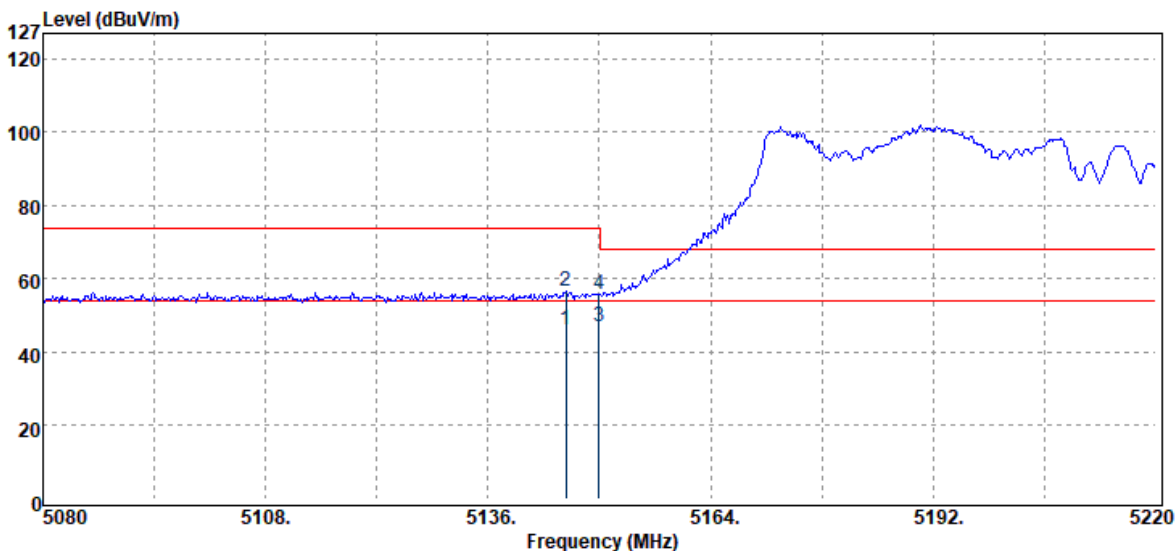

| Freq. MHz | Detector Mode PK/QP/AV | Spectrum Reading Level dB μ V | Factor dB | Actual FS dB μ V/m | Limit @3m dB μ V/m | Margin dB |
|--------------|------------------------------|---|--------------|------------------------------|------------------------------|--------------|
| 5145.80 | Average | 37.77 | 8.54 | 46.31 | 54.00 | -7.69 |
| 5145.80 | Peak | 47.96 | 8.54 | 56.50 | 74.00 | -17.50 |
| 5150.00 | Average | 38.43 | 8.53 | 46.96 | 54.00 | -7.04 |
| 5150.00 | Peak | 47.25 | 8.53 | 55.78 | 74.00 | -18.22 |

Unless otherwise stated the results shown in this test report refer only to the sample(s) tested and such sample(s) are retained for 90 days only.

除非另有說明，此報告結果僅對測試之樣品負責，同時此樣品僅保留90天。本報告未經本公司書面許可，不可部份複製。

This document is issued by the Company subject to its General Conditions of Service printed overleaf, available on request or accessible at <http://www.sgs.com.tw/Terms-and-Conditions> and for electronic format documents, subject to Terms and Conditions for Electronic Documents at <http://www.sgs.com.tw/Terms-and-Conditions>. Attention is drawn to the limitation of liability, indemnification and jurisdiction issues defined therein. Any holder of this document is advised that information contained hereon reflects the Company's findings at the time of its intervention only and within the limits of Client's instructions, if any. The Company's sole responsibility is to its Client and this document does not exonerate parties to a transaction from exercising all their rights and obligations under the transaction documents. This document cannot be reproduced except in full, without prior written approval of the Company. Any unauthorized alteration, forgery or falsification of the content or appearance of this document is unlawful and offenders may be prosecuted to the fullest extent of the law.

| | | | |
|----------------|-----------------------|--------------|------------------|
| Report Number | :ER-2021-20085 | Test Site | :SAC III Chamber |
| Operation Mode | :802.11ax80 RU 484/65 | Test Date | :2021-03-16 |
| Test Frequency | :5210 MHz | Temp./Humi. | :22.7/63 |
| Test Mode | :Bandedge CH Low | Antenna Pol. | :HORIZONTAL |
| EUT Pol | :H Plane | Engineer | :Ricky |

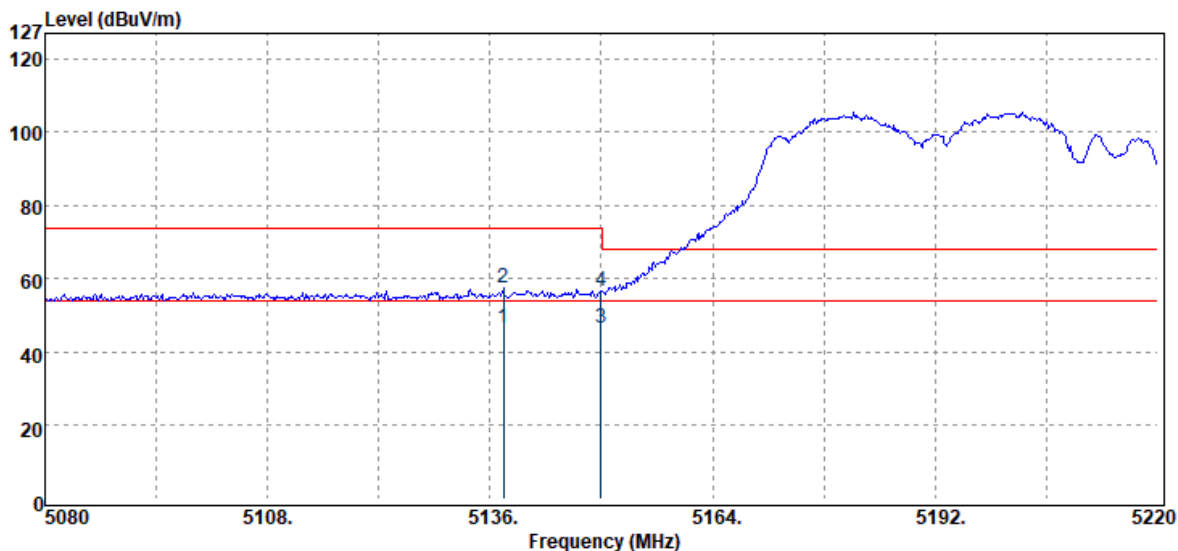

| Freq. MHz | Detector Mode PK/QP/AV | Spectrum Reading Level dB μ V | Factor dB | Actual FS dB μ V/m | Limit @3m dB μ V/m | Margin dB |
|--------------|------------------------------|---|--------------|------------------------------|------------------------------|--------------|
| 5137.68 | Average | 38.06 | 8.55 | 46.61 | 54.00 | -7.39 |
| 5137.68 | Peak | 49.07 | 8.55 | 57.62 | 74.00 | -16.38 |
| 5150.00 | Average | 38.03 | 8.53 | 46.56 | 54.00 | -7.44 |
| 5150.00 | Peak | 48.19 | 8.53 | 56.72 | 74.00 | -17.28 |

Unless otherwise stated the results shown in this test report refer only to the sample(s) tested and such sample(s) are retained for 90 days only.

除非另有說明，此報告結果僅對測試之樣品負責，同時此樣品僅保留90天。本報告未經本公司書面許可，不可部份複製。

This document is issued by the Company subject to its General Conditions of Service printed overleaf, available on request or accessible at <http://www.sgs.com.tw/Terms-and-Conditions> and for electronic format documents, subject to Terms and Conditions for Electronic Documents at <http://www.sgs.com.tw/Terms-and-Conditions>. Attention is drawn to the limitation of liability, indemnification and jurisdiction issues defined therein. Any holder of this document is advised that information contained hereon reflects the Company's findings at the time of its intervention only and within the limits of Client's instructions, if any. The Company's sole responsibility is to its Client and this document does not exonerate parties to a transaction from exercising all their rights and obligations under the transaction documents. This document cannot be reproduced except in full, without prior written approval of the Company. Any unauthorized alteration, forgery or falsification of the content or appearance of this document is unlawful and offenders may be prosecuted to the fullest extent of the law.

Report Number :ER-2021-20085
 Operation Mode :802.11ax80 RU full
 Test Frequency :5290 MHz
 Test Mode :Bandedge CH Low
 EUT Pol :H Plane

Test Site :SAC III Chamber
 Test Date :2021-03-16
 Temp./Humi. :22.7/63
 Antenna Pol. :VERTICAL
 Engineer :Ricky

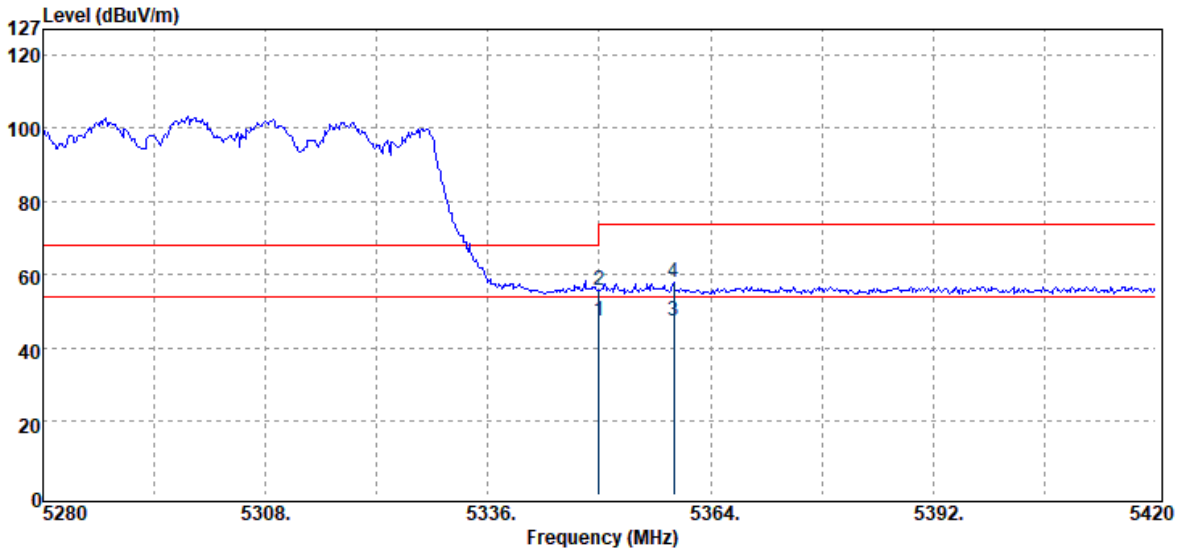

| Freq. MHz | Detector Mode PK/QP/AV | Spectrum Reading Level dB μ V | Factor dB | Actual FS dB μ V/m | Limit @3m dB μ V/m | Margin dB |
|--------------|------------------------------|---|--------------|------------------------------|------------------------------|--------------|
| 5350.00 | Average | 38.60 | 8.77 | 47.37 | 54.00 | -6.63 |
| 5350.00 | Peak | 47.12 | 8.77 | 55.89 | 74.00 | -18.11 |
| 5359.38 | Average | 38.48 | 8.89 | 47.37 | 54.00 | -6.63 |
| 5359.38 | Peak | 49.30 | 8.89 | 58.19 | 74.00 | -15.81 |

Unless otherwise stated the results shown in this test report refer only to the sample(s) tested and such sample(s) are retained for 90 days only.

除非另有說明，此報告結果僅對測試之樣品負責，同時此樣品僅保留90天。本報告未經本公司書面許可，不可部份複製。

This document is issued by the Company subject to its General Conditions of Service printed overleaf, available on request or accessible at <http://www.sgs.com.tw/Terms-and-Conditions> and for electronic format documents, subject to Terms and Conditions for Electronic Documents at <http://www.sgs.com.tw/Terms-and-Conditions>. Attention is drawn to the limitation of liability, indemnification and jurisdiction issues defined therein. Any holder of this document is advised that information contained hereon reflects the Company's findings at the time of its intervention only and within the limits of Client's instructions, if any. The Company's sole responsibility is to its Client and this document does not exonerate parties to a transaction from exercising all their rights and obligations under the transaction documents. This document cannot be reproduced except in full, without prior written approval of the Company. Any unauthorized alteration, forgery or falsification of the content or appearance of this document is unlawful and offenders may be prosecuted to the fullest extent of the law.

| | | | |
|----------------|---------------------|--------------|------------------|
| Report Number | :ER-2021-20085 | Test Site | :SAC III Chamber |
| Operation Mode | :802.11ax80 RU full | Test Date | :2021-03-16 |
| Test Frequency | :5290 MHz | Temp./Humi. | :22.7/63 |
| Test Mode | :Bandedge CH Low | Antenna Pol. | :HORIZONTAL |
| EUT Pol | :H Plane | Engineer | :Ricky |

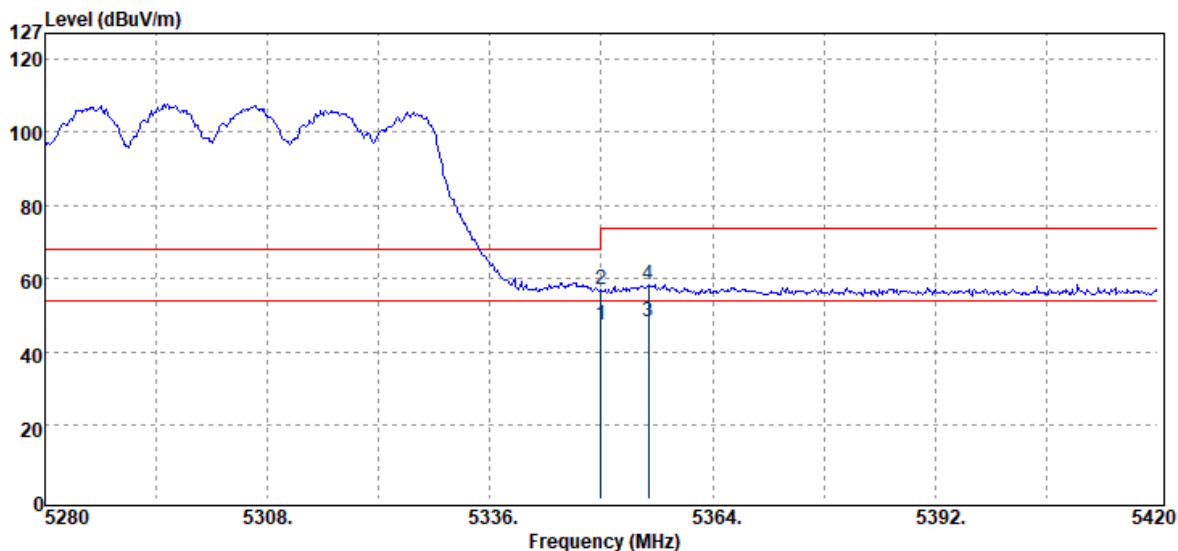

| Freq. MHz | Detector Mode PK/QP/AV | Spectrum Reading Level dB μ V | Factor dB | Actual FS dB μ V/m | Limit @3m dB μ V/m | Margin dB |
|--------------|------------------------------|---|--------------|------------------------------|------------------------------|--------------|
| 5350.00 | Average | 38.60 | 8.77 | 47.37 | 54.00 | -6.63 |
| 5350.00 | Peak | 48.14 | 8.77 | 56.91 | 74.00 | -17.09 |
| 5355.88 | Average | 39.37 | 8.84 | 48.21 | 54.00 | -5.79 |
| 5355.88 | Peak | 49.63 | 8.84 | 58.47 | 74.00 | -15.53 |

Unless otherwise stated the results shown in this test report refer only to the sample(s) tested and such sample(s) are retained for 90 days only.

除非另有說明，此報告結果僅對測試之樣品負責，同時此樣品僅保留90天。本報告未經本公司書面許可，不可部份複製。

This document is issued by the Company subject to its General Conditions of Service printed overleaf, available on request or accessible at <http://www.sgs.com.tw/Terms-and-Conditions> and for electronic format documents, subject to Terms and Conditions for Electronic Documents at <http://www.sgs.com.tw/Terms-and-Conditions>. Attention is drawn to the limitation of liability, indemnification and jurisdiction issues defined therein. Any holder of this document is advised that information contained hereon reflects the Company's findings at the time of its intervention only and within the limits of Client's instructions, if any. The Company's sole responsibility is to its Client and this document does not exonerate parties to a transaction from exercising all their rights and obligations under the transaction documents. This document cannot be reproduced except in full, without prior written approval of the Company. Any unauthorized alteration, forgery or falsification of the content or appearance of this document is unlawful and offenders may be prosecuted to the fullest extent of the law.

| | | | |
|----------------|-----------------------|--------------|------------------|
| Report Number | :ER-2021-20085 | Test Site | :SAC III Chamber |
| Operation Mode | :802.11ax80 RU 484/66 | Test Date | :2021-03-16 |
| Test Frequency | :5290 MHz | Temp./Humi. | :22.7/63 |
| Test Mode | :Bandedge CH Low | Antenna Pol. | :VERTICAL |
| EUT Pol | :H Plane | Engineer | :Ricky |

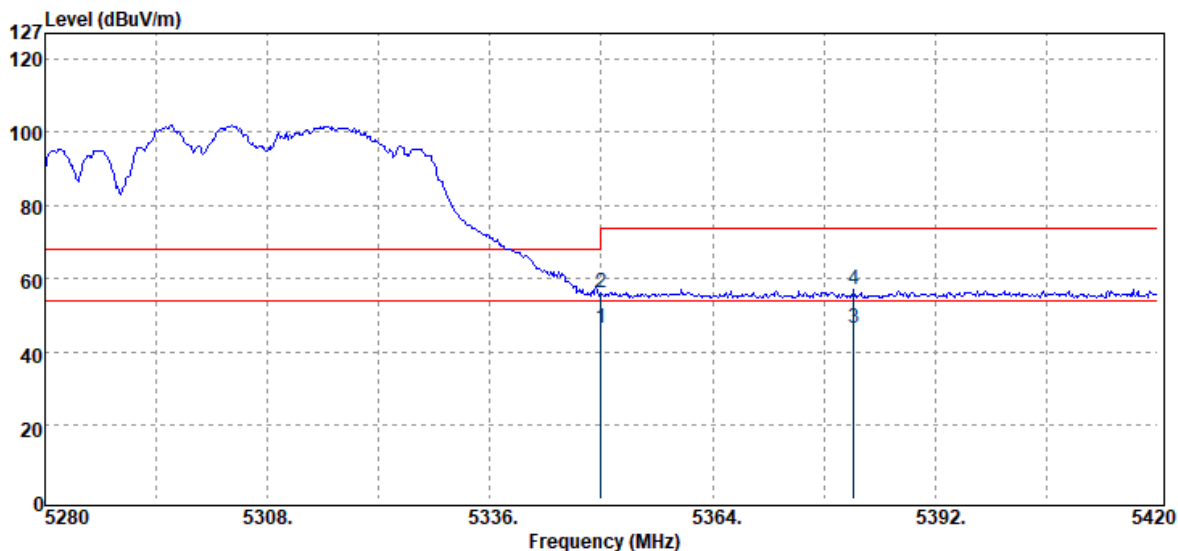

| Freq. MHz | Detector Mode PK/QP/AV | Spectrum Reading Level dB μ V | Factor dB | Actual FS dB μ V/m | Limit @3m dB μ V/m | Margin dB |
|--------------|------------------------------|---|--------------|------------------------------|------------------------------|--------------|
| 5350.00 | Average | 37.93 | 8.77 | 46.70 | 54.00 | -7.30 |
| 5350.00 | Peak | 47.59 | 8.77 | 56.36 | 74.00 | -17.64 |
| 5381.78 | Average | 37.49 | 9.18 | 46.67 | 54.00 | -7.33 |
| 5381.78 | Peak | 47.91 | 9.18 | 57.09 | 74.00 | -16.91 |

Unless otherwise stated the results shown in this test report refer only to the sample(s) tested and such sample(s) are retained for 90 days only.

除非另有說明，此報告結果僅對測試之樣品負責，同時此樣品僅保留90天。本報告未經本公司書面許可，不可部份複製。

This document is issued by the Company subject to its General Conditions of Service printed overleaf, available on request or accessible at <http://www.sgs.com.tw/Terms-and-Conditions> and for electronic format documents, subject to Terms and Conditions for Electronic Documents at <http://www.sgs.com.tw/Terms-and-Conditions>. Attention is drawn to the limitation of liability, indemnification and jurisdiction issues defined therein. Any holder of this document is advised that information contained hereon reflects the Company's findings at the time of its intervention only and within the limits of Client's instructions, if any. The Company's sole responsibility is to its Client and this document does not exonerate parties to a transaction from exercising all their rights and obligations under the transaction documents. This document cannot be reproduced except in full, without prior written approval of the Company. Any unauthorized alteration, forgery or falsification of the content or appearance of this document is unlawful and offenders may be prosecuted to the fullest extent of the law.

| | | | |
|----------------|-----------------------|--------------|------------------|
| Report Number | :ER-2021-20085 | Test Site | :SAC III Chamber |
| Operation Mode | :802.11ax80 RU 484/66 | Test Date | :2021-03-16 |
| Test Frequency | :5290 MHz | Temp./Humi. | :22.7/63 |
| Test Mode | :Bandedge CH Low | Antenna Pol. | :HORIZONTAL |
| EUT Pol | :H Plane | Engineer | :Ricky |

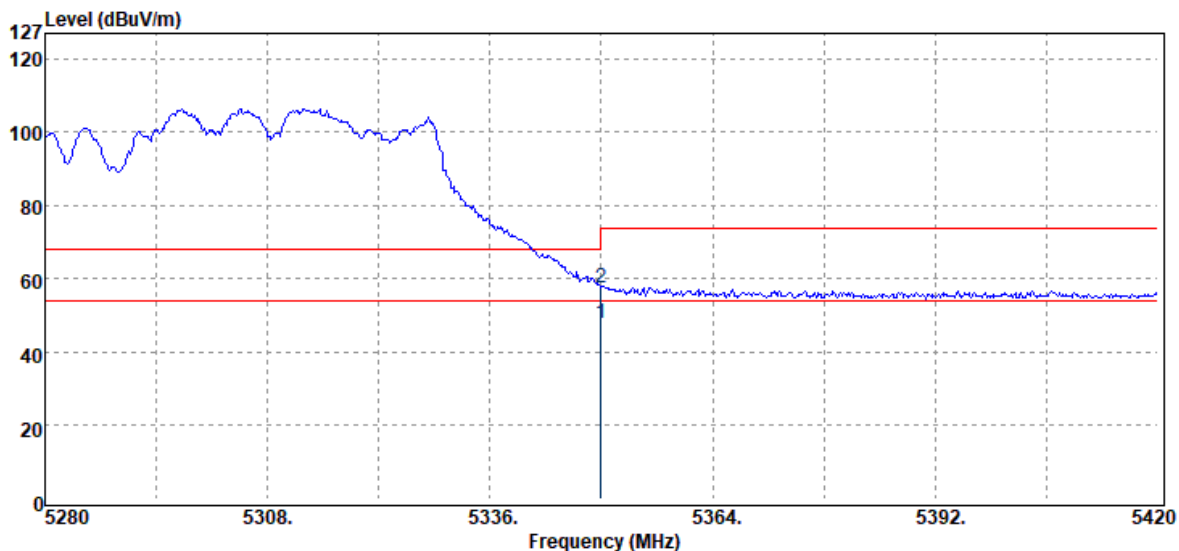

| Freq. MHz | Detector Mode PK/QP/AV | Spectrum Reading Level dB μ V | Factor dB | Actual FS dB μ V/m | Limit @3m dB μ V/m | Margin dB |
|--------------|------------------------------|---|--------------|------------------------------|------------------------------|--------------|
| 5350.00 | Average | 39.22 | 8.77 | 47.99 | 54.00 | -6.01 |
| 5350.00 | Peak | 48.78 | 8.77 | 57.55 | 74.00 | -16.45 |

Unless otherwise stated the results shown in this test report refer only to the sample(s) tested and such sample(s) are retained for 90 days only.

除非另有說明，此報告結果僅對測試之樣品負責，同時此樣品僅保留90天。本報告未經本公司書面許可，不可部份複製。

This document is issued by the Company subject to its General Conditions of Service printed overleaf, available on request or accessible at <http://www.sgs.com.tw/Terms-and-Conditions> and for electronic format documents, subject to Terms and Conditions for Electronic Documents at <http://www.sgs.com.tw/Terms-and-Conditions>. Attention is drawn to the limitation of liability, indemnification and jurisdiction issues defined therein. Any holder of this document is advised that information contained hereon reflects the Company's findings at the time of its intervention only and within the limits of Client's instructions, if any. The Company's sole responsibility is to its Client and this document does not exonerate parties to a transaction from exercising all their rights and obligations under the transaction documents. This document cannot be reproduced except in full, without prior written approval of the Company. Any unauthorized alteration, forgery or falsification of the content or appearance of this document is unlawful and offenders may be prosecuted to the fullest extent of the law.

| | | | |
|----------------|---------------------|--------------|------------------|
| Report Number | :ER-2021-20085 | Test Site | :SAC III Chamber |
| Operation Mode | :802.11ax80 RU full | Test Date | :2021-03-16 |
| Test Frequency | :5530 MHz | Temp./Humi. | :22.7/63 |
| Test Mode | :Bandedge CH Low | Antenna Pol. | :VERTICAL |
| EUT Pol | :H Plane | Engineer | :Ricky |

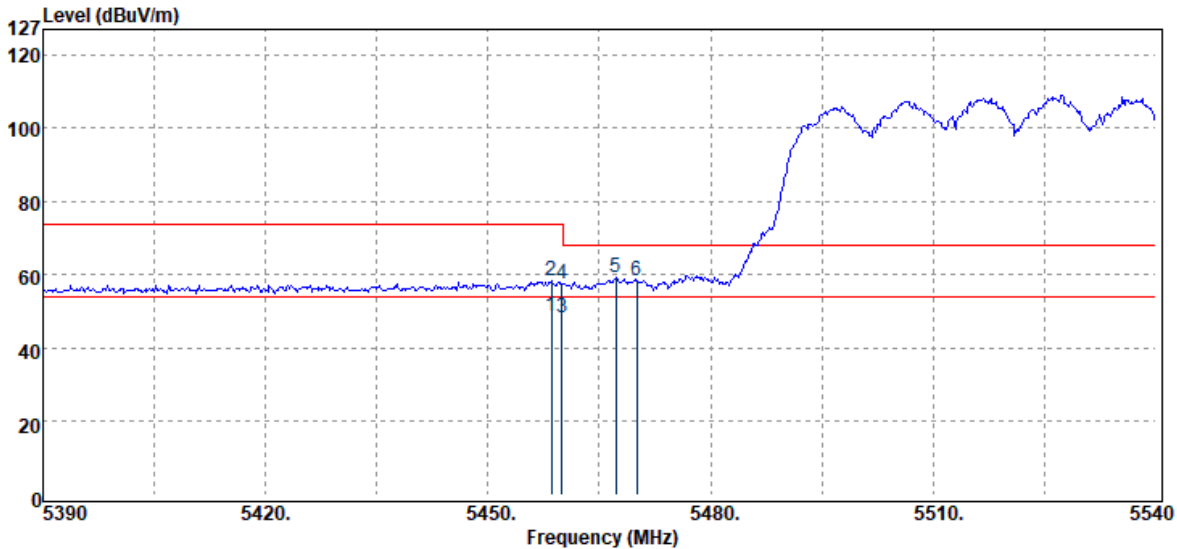

| Freq. MHz | Detector Mode PK/QP/AV | Spectrum Reading Level dBµV | Factor dB | Actual FS dBµV/m | Limit @3m dBµV/m | Margin dB |
|--------------|------------------------------|-----------------------------------|--------------|------------------------|------------------------|--------------|
| 5458.55 | Average | 39.02 | 9.62 | 48.64 | 54.00 | -5.36 |
| 5458.55 | Peak | 48.76 | 9.62 | 58.38 | 74.00 | -15.62 |
| 5460.00 | Average | 38.68 | 9.63 | 48.31 | 54.00 | -5.69 |
| 5460.00 | Peak | 48.10 | 9.63 | 57.73 | 74.00 | -16.27 |
| 5467.25 | Peak | 49.45 | 9.68 | 59.13 | 68.20 | -9.07 |
| 5470.00 | Peak | 48.93 | 9.71 | 58.64 | 68.20 | -9.56 |

Unless otherwise stated the results shown in this test report refer only to the sample(s) tested and such sample(s) are retained for 90 days only.

除非另有說明，此報告結果僅對測試之樣品負責，同時此樣品僅保留90天。本報告未經本公司書面許可，不可部份複製。

This document is issued by the Company subject to its General Conditions of Service printed overleaf, available on request or accessible at <http://www.sgs.com.tw/Terms-and-Conditions> and for electronic format documents, subject to Terms and Conditions for Electronic Documents at <http://www.sgs.com.tw/Terms-and-Conditions>. Attention is drawn to the limitation of liability, indemnification and jurisdiction issues defined therein. Any holder of this document is advised that information contained hereon reflects the Company's findings at the time of its intervention only and within the limits of Client's instructions, if any. The Company's sole responsibility is to its Client and this document does not exonerate parties to a transaction from exercising all their rights and obligations under the transaction documents. This document cannot be reproduced except in full, without prior written approval of the Company. Any unauthorized alteration, forgery or falsification of the content or appearance of this document is unlawful and offenders may be prosecuted to the fullest extent of the law.

| | | | |
|----------------|---------------------|--------------|------------------|
| Report Number | :ER-2021-20085 | Test Site | :SAC III Chamber |
| Operation Mode | :802.11ax80 RU full | Test Date | :2021-03-16 |
| Test Frequency | :5530 MHz | Temp./Humi. | :22.7/63 |
| Test Mode | :Bandedge CH Low | Antenna Pol. | :HORIZONTAL |
| EUT Pol | :H Plane | Engineer | :Ricky |

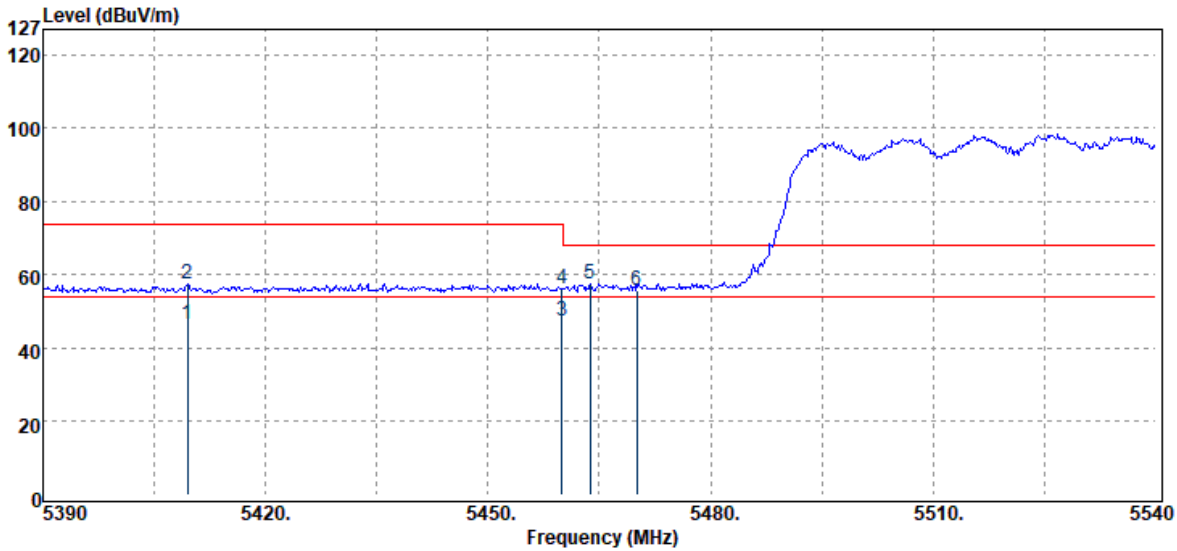

| Freq. MHz | Detector Mode PK/QP/AV | Spectrum Reading Level dB μ V | Factor dB | Actual FS dB μ V/m | Limit @3m dB μ V/m | Margin dB |
|--------------|------------------------------|---|--------------|------------------------------|------------------------------|--------------|
| 5409.50 | Average | 37.26 | 9.45 | 46.71 | 54.00 | -7.29 |
| 5409.50 | Peak | 48.33 | 9.45 | 57.78 | 74.00 | -16.22 |
| 5460.00 | Average | 37.70 | 9.63 | 47.33 | 54.00 | -6.67 |
| 5460.00 | Peak | 46.66 | 9.63 | 56.29 | 74.00 | -17.71 |
| 5463.80 | Peak | 48.05 | 9.66 | 57.71 | 68.20 | -10.49 |
| 5470.00 | Peak | 45.91 | 9.71 | 55.62 | 68.20 | -12.58 |

Unless otherwise stated the results shown in this test report refer only to the sample(s) tested and such sample(s) are retained for 90 days only.

除非另有說明，此報告結果僅對測試之樣品負責，同時此樣品僅保留90天。本報告未經本公司書面許可，不可部份複製。

This document is issued by the Company subject to its General Conditions of Service printed overleaf, available on request or accessible at <http://www.sgs.com.tw/Terms-and-Conditions> and for electronic format documents, subject to Terms and Conditions for Electronic Documents at <http://www.sgs.com.tw/Terms-and-Conditions>. Attention is drawn to the limitation of liability, indemnification and jurisdiction issues defined therein. Any holder of this document is advised that information contained hereon reflects the Company's findings at the time of its intervention only and within the limits of Client's instructions, if any. The Company's sole responsibility is to its Client and this document does not exonerate parties to a transaction from exercising all their rights and obligations under the transaction documents. This document cannot be reproduced except in full, without prior written approval of the Company. Any unauthorized alteration, forgery or falsification of the content or appearance of this document is unlawful and offenders may be prosecuted to the fullest extent of the law.

| | | | |
|----------------|-----------------------|--------------|------------------|
| Report Number | :ER-2021-20085 | Test Site | :SAC III Chamber |
| Operation Mode | :802.11ax80 RU 484/65 | Test Date | :2021-03-16 |
| Test Frequency | :5530 MHz | Temp./Humi. | :22.7/63 |
| Test Mode | :Bandedge CH Low | Antenna Pol. | :VERTICAL |
| EUT Pol | :H Plane | Engineer | :Ricky |

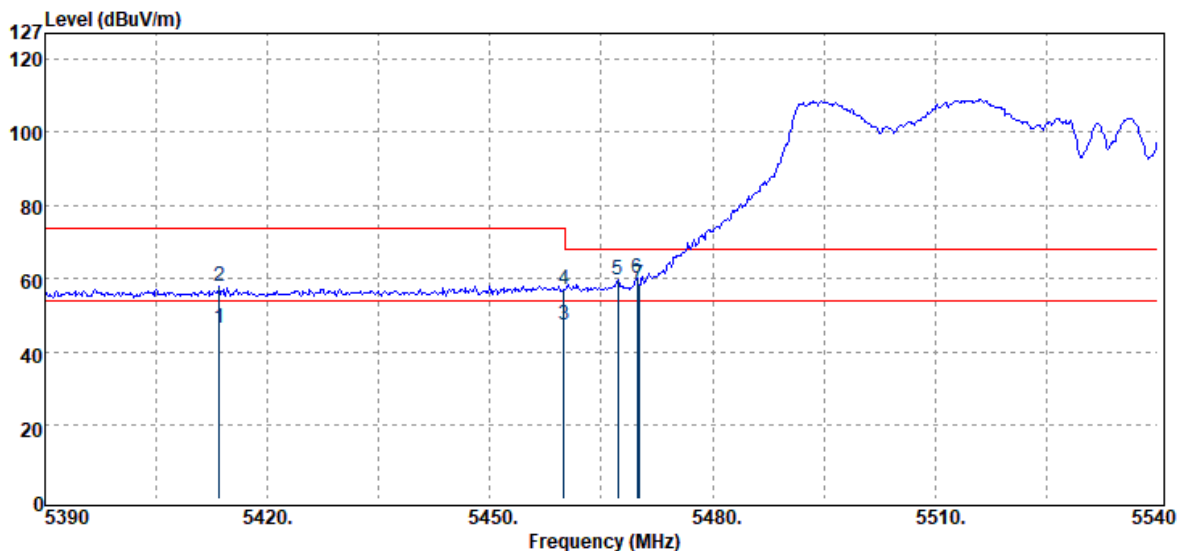

| Freq. MHz | Detector Mode PK/QP/AV | Spectrum Reading Level dB μ V | Factor dB | Actual FS dB μ V/m | Limit @3m dB μ V/m | Margin dB |
|--------------|------------------------------|---|--------------|------------------------------|------------------------------|--------------|
| 5413.55 | Average | 37.13 | 9.46 | 46.59 | 54.00 | -7.41 |
| 5413.55 | Peak | 48.70 | 9.46 | 58.16 | 74.00 | -15.84 |
| 5460.00 | Average | 38.04 | 9.63 | 47.67 | 54.00 | -6.33 |
| 5460.00 | Peak | 47.51 | 9.63 | 57.14 | 74.00 | -16.86 |
| 5467.25 | Peak | 49.88 | 9.68 | 59.56 | 68.20 | -8.64 |
| 5469.80 | Peak | 50.38 | 9.70 | 60.08 | 68.20 | -8.12 |
| 5470.00 | Peak | 48.91 | 9.71 | 58.62 | 68.20 | -9.58 |

Unless otherwise stated the results shown in this test report refer only to the sample(s) tested and such sample(s) are retained for 90 days only.

除非另有說明，此報告結果僅對測試之樣品負責，同時此樣品僅保留90天。本報告未經本公司書面許可，不可部份複製。

This document is issued by the Company subject to its General Conditions of Service printed overleaf, available on request or accessible at <http://www.sgs.com.tw/Terms-and-Conditions> and for electronic format documents, subject to Terms and Conditions for Electronic Documents at <http://www.sgs.com.tw/Terms-and-Conditions>. Attention is drawn to the limitation of liability, indemnification and jurisdiction issues defined therein. Any holder of this document is advised that information contained hereon reflects the Company's findings at the time of its intervention only and within the limits of Client's instructions, if any. The Company's sole responsibility is to its Client and this document does not exonerate parties to a transaction from exercising all their rights and obligations under the transaction documents. This document cannot be reproduced except in full, without prior written approval of the Company. Any unauthorized alteration, forgery or falsification of the content or appearance of this document is unlawful and offenders may be prosecuted to the fullest extent of the law.

| | | | |
|----------------|-----------------------|--------------|------------------|
| Report Number | :ER-2021-20085 | Test Site | :SAC III Chamber |
| Operation Mode | :802.11ax80 RU 484/65 | Test Date | :2021-03-16 |
| Test Frequency | :5530 MHz | Temp./Humi. | :22.7/63 |
| Test Mode | :Bandedge CH Low | Antenna Pol. | :HORIZONTAL |
| EUT Pol | :H Plane | Engineer | :Ricky |

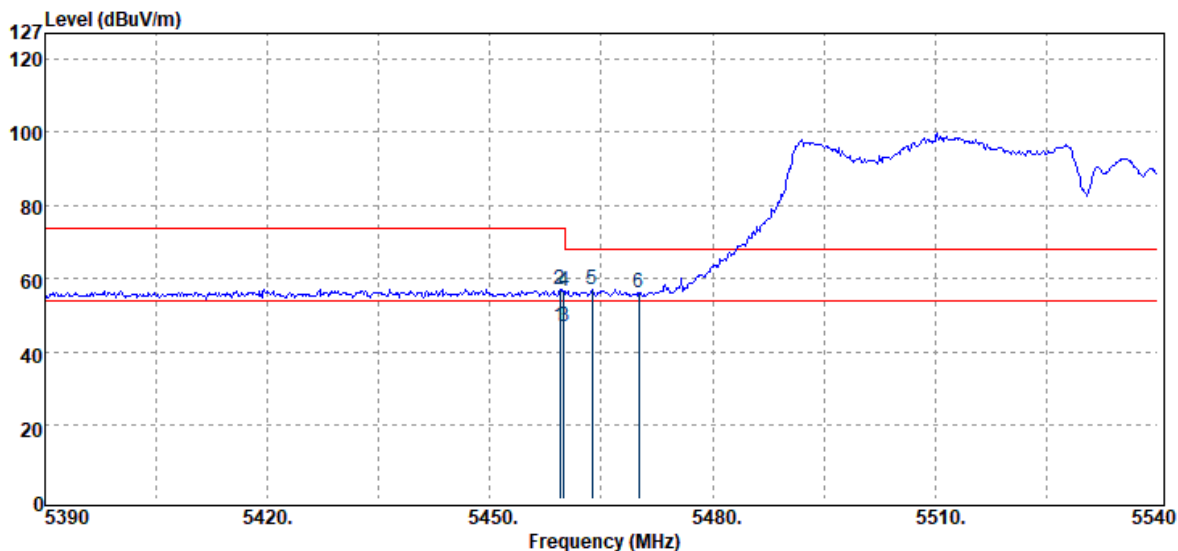

| Freq. MHz | Detector Mode PK/QP/AV | Spectrum Reading Level dB μ V | Factor dB | Actual FS dB μ V/m | Limit @3m dB μ V/m | Margin dB |
|--------------|------------------------------|---|--------------|------------------------------|------------------------------|--------------|
| 5459.45 | Average | 37.53 | 9.63 | 47.16 | 54.00 | -6.84 |
| 5459.45 | Peak | 47.52 | 9.63 | 57.15 | 74.00 | -16.85 |
| 5460.00 | Average | 37.45 | 9.63 | 47.08 | 54.00 | -6.92 |
| 5460.00 | Peak | 47.24 | 9.63 | 56.87 | 74.00 | -17.13 |
| 5463.80 | Peak | 47.42 | 9.66 | 57.08 | 68.20 | -11.12 |
| 5470.00 | Peak | 46.71 | 9.71 | 56.42 | 68.20 | -11.78 |

Unless otherwise stated the results shown in this test report refer only to the sample(s) tested and such sample(s) are retained for 90 days only.

除非另有說明，此報告結果僅對測試之樣品負責，同時此樣品僅保留90天。本報告未經本公司書面許可，不可部份複製。

This document is issued by the Company subject to its General Conditions of Service printed overleaf, available on request or accessible at <http://www.sgs.com.tw/Terms-and-Conditions> and for electronic format documents, subject to Terms and Conditions for Electronic Documents at <http://www.sgs.com.tw/Terms-and-Conditions>. Attention is drawn to the limitation of liability, indemnification and jurisdiction issues defined therein. Any holder of this document is advised that information contained hereon reflects the Company's findings at the time of its intervention only and within the limits of Client's instructions, if any. The Company's sole responsibility is to its Client and this document does not exonerate parties to a transaction from exercising all their rights and obligations under the transaction documents. This document cannot be reproduced except in full, without prior written approval of the Company. Any unauthorized alteration, forgery or falsification of the content or appearance of this document is unlawful and offenders may be prosecuted to the fullest extent of the law.

| | | | |
|----------------|---------------------|--------------|------------------|
| Report Number | :ER-2021-20085 | Test Site | :SAC III Chamber |
| Operation Mode | :802.11ax80 RU full | Test Date | :2021-03-16 |
| Test Frequency | :5610 MHz | Temp./Humi. | :22.7/63 |
| Test Mode | :Bandedge CH Mid | Antenna Pol. | :VERTICAL |
| EUT Pol | :H Plane | Engineer | :Ricky |

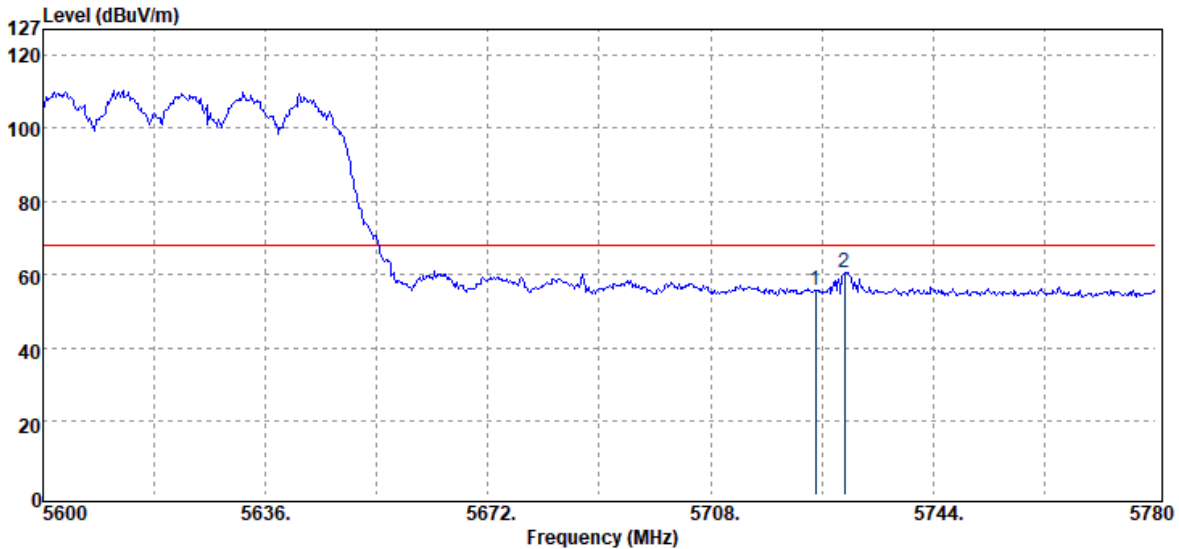

| Freq. MHz | Detector Mode PK/QP/AV | Spectrum Reading Level dB μ V | Factor dB | Actual FS dB μ V/m | Limit @3m dB μ V/m | Margin dB |
|--------------|------------------------------|---|--------------|------------------------------|------------------------------|--------------|
| 5725.00 | Peak | 47.70 | 8.12 | 55.82 | 68.20 | -12.38 |
| 5729.60 | Peak | 52.71 | 8.14 | 60.85 | 68.20 | -7.35 |

Unless otherwise stated the results shown in this test report refer only to the sample(s) tested and such sample(s) are retained for 90 days only.

除非另有說明，此報告結果僅對測試之樣品負責，同時此樣品僅保留90天。本報告未經本公司書面許可，不可部份複製。

This document is issued by the Company subject to its General Conditions of Service printed overleaf, available on request or accessible at <http://www.sgs.com.tw/Terms-and-Conditions> and for electronic format documents, subject to Terms and Conditions for Electronic Documents at <http://www.sgs.com.tw/Terms-and-Conditions>. Attention is drawn to the limitation of liability, indemnification and jurisdiction issues defined therein. Any holder of this document is advised that information contained hereon reflects the Company's findings at the time of its intervention only and within the limits of Client's instructions, if any. The Company's sole responsibility is to its Client and this document does not exonerate parties to a transaction from exercising all their rights and obligations under the transaction documents. This document cannot be reproduced except in full, without prior written approval of the Company. Any unauthorized alteration, forgery or falsification of the content or appearance of this document is unlawful and offenders may be prosecuted to the fullest extent of the law.

| | | | |
|----------------|---------------------|--------------|------------------|
| Report Number | :ER-2021-20085 | Test Site | :SAC III Chamber |
| Operation Mode | :802.11ax80 RU full | Test Date | :2021-03-16 |
| Test Frequency | :5610 MHz | Temp./Humi. | :22.7/63 |
| Test Mode | :Bandedge CH Mid | Antenna Pol. | :HORIZONTAL |
| EUT Pol | :H Plane | Engineer | :Ricky |

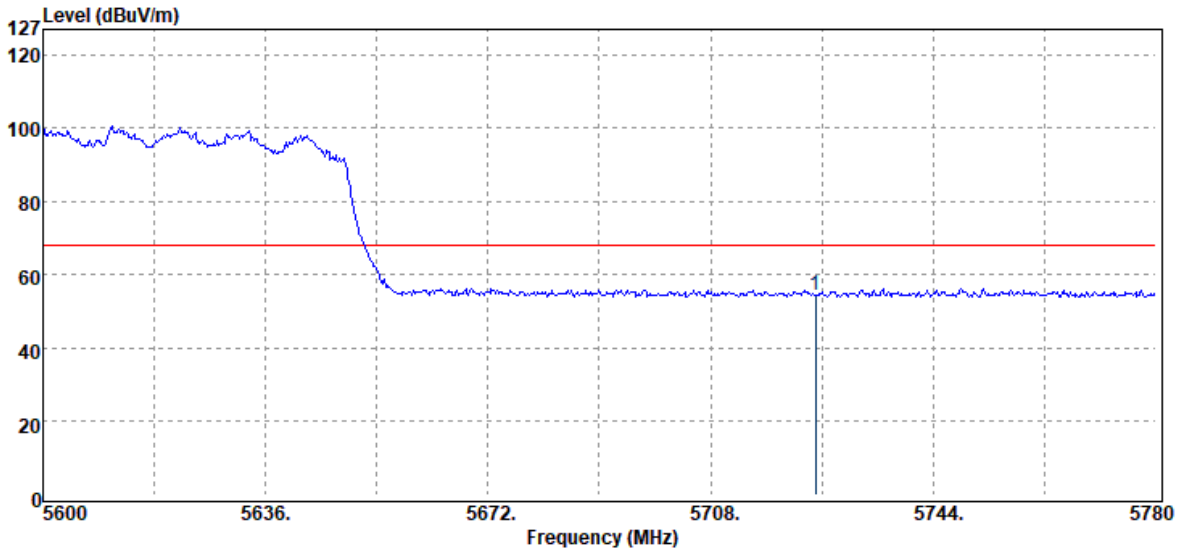

| Freq. MHz | Detector Mode PK/QP/AV | Spectrum Reading Level dB μ V | Factor dB | Actual FS dB μ V/m | Limit @3m dB μ V/m | Margin dB |
|--------------|------------------------------|---|--------------|------------------------------|------------------------------|--------------|
| 5725.00 | Peak | 46.41 | 8.12 | 54.53 | 68.20 | -13.67 |

Unless otherwise stated the results shown in this test report refer only to the sample(s) tested and such sample(s) are retained for 90 days only.

除非另有說明，此報告結果僅對測試之樣品負責，同時此樣品僅保留90天。本報告未經本公司書面許可，不可部份複製。

This document is issued by the Company subject to its General Conditions of Service printed overleaf, available on request or accessible at <http://www.sgs.com.tw/Terms-and-Conditions> and for electronic format documents, subject to Terms and Conditions for Electronic Documents at <http://www.sgs.com.tw/Terms-and-Conditions>. Attention is drawn to the limitation of liability, indemnification and jurisdiction issues defined therein. Any holder of this document is advised that information contained hereon reflects the Company's findings at the time of its intervention only and within the limits of Client's instructions, if any. The Company's sole responsibility is to its Client and this document does not exonerate parties to a transaction from exercising all their rights and obligations under the transaction documents. This document cannot be reproduced except in full, without prior written approval of the Company. Any unauthorized alteration, forgery or falsification of the content or appearance of this document is unlawful and offenders may be prosecuted to the fullest extent of the law.

| | | | |
|----------------|---------------------|--------------|------------------|
| Report Number | :ER-2021-20085 | Test Site | :SAC III Chamber |
| Operation Mode | :802.11ax80 RU full | Test Date | :2021-03-16 |
| Test Frequency | :5775 MHz | Temp./Humi. | :22.7/63 |
| Test Mode | :Bandedge CH Low | Antenna Pol. | :VERTICAL |
| EUT Pol | :H Plane | Engineer | :Ricky |

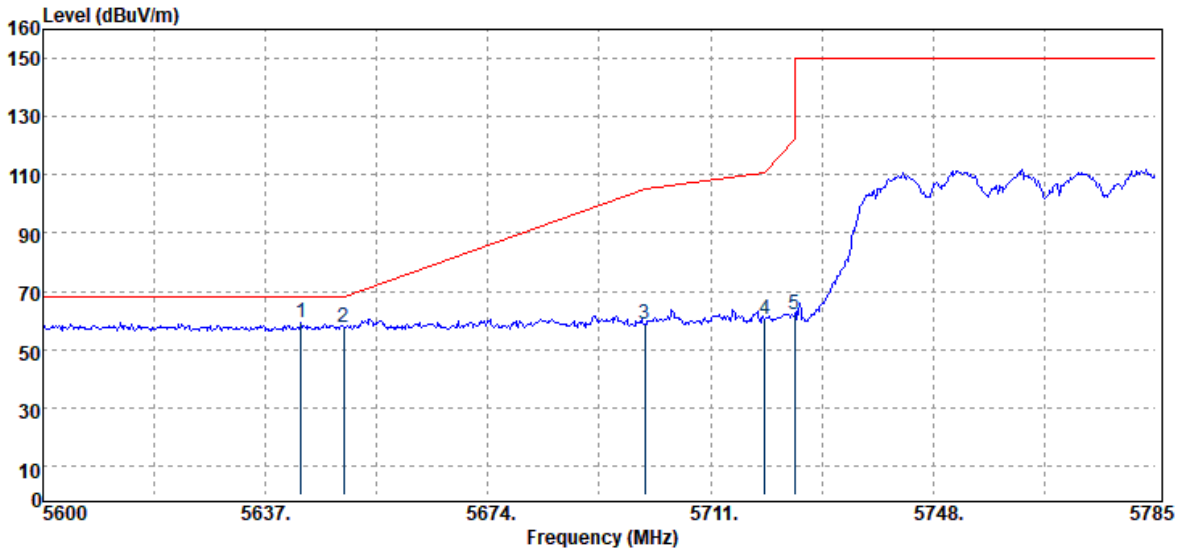

| Freq. MHz | Detector Mode PK/QP/AV | Spectrum Reading Level dB μ V | Factor dB | Actual FS dB μ V/m | Limit @3m dB μ V/m | Margin dB |
|--------------|------------------------------|---|--------------|------------------------------|------------------------------|--------------|
| 5642.92 | Peak | 51.11 | 8.13 | 59.24 | 68.20 | -8.96 |
| 5650.00 | Peak | 49.75 | 8.08 | 57.83 | 68.20 | -10.37 |
| 5700.00 | Peak | 50.68 | 8.02 | 58.70 | 105.20 | -46.50 |
| 5720.00 | Peak | 52.24 | 8.10 | 60.34 | 110.80 | -50.46 |
| 5725.00 | Peak | 54.13 | 8.12 | 62.25 | 122.20 | -59.95 |

Unless otherwise stated the results shown in this test report refer only to the sample(s) tested and such sample(s) are retained for 90 days only.

除非另有說明，此報告結果僅對測試之樣品負責，同時此樣品僅保留90天。本報告未經本公司書面許可，不可部份複製。

This document is issued by the Company subject to its General Conditions of Service printed overleaf, available on request or accessible at <http://www.sgs.com.tw/Terms-and-Conditions> and for electronic format documents, subject to Terms and Conditions for Electronic Documents at <http://www.sgs.com.tw/Terms-and-Conditions>. Attention is drawn to the limitation of liability, indemnification and jurisdiction issues defined therein. Any holder of this document is advised that information contained hereon reflects the Company's findings at the time of its intervention only and within the limits of Client's instructions, if any. The Company's sole responsibility is to its Client and this document does not exonerate parties to a transaction from exercising all their rights and obligations under the transaction documents. This document cannot be reproduced except in full, without prior written approval of the Company. Any unauthorized alteration, forgery or falsification of the content or appearance of this document is unlawful and offenders may be prosecuted to the fullest extent of the law.

| | | | |
|----------------|---------------------|--------------|------------------|
| Report Number | :ER-2021-20085 | Test Site | :SAC III Chamber |
| Operation Mode | :802.11ax80 RU full | Test Date | :2021-03-16 |
| Test Frequency | :5775 MHz | Temp./Humi. | :22.7/63 |
| Test Mode | :Bandedge CH Low | Antenna Pol. | :HORIZONTAL |
| EUT Pol | :H Plane | Engineer | :Ricky |

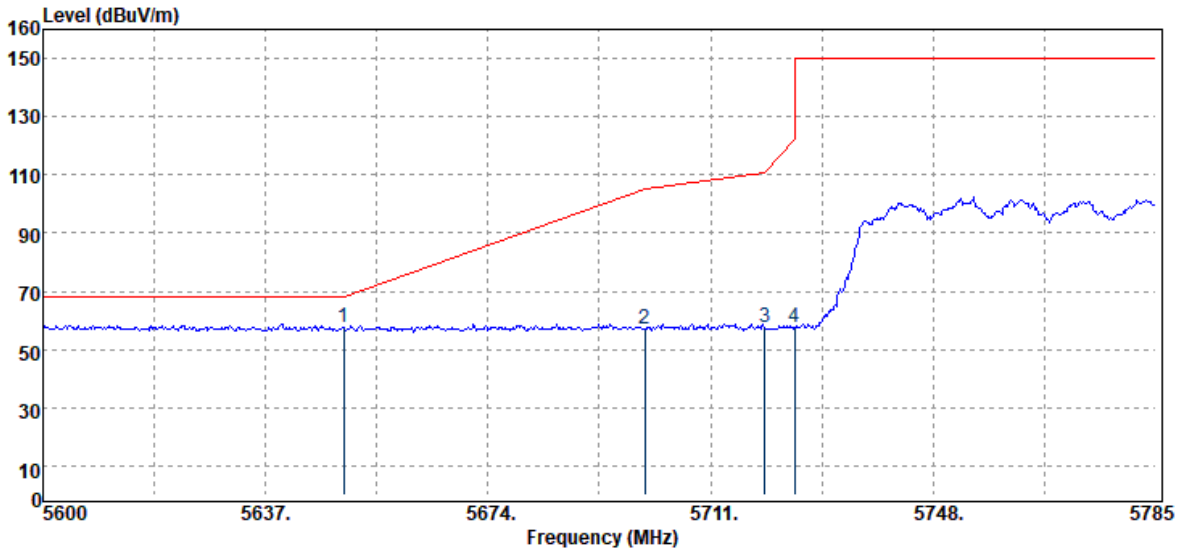

| Freq. MHz | Detector Mode PK/QP/AV | Spectrum Reading Level dB μ V | Factor dB | Actual FS dB μ V/m | Limit @3m dB μ V/m | Margin dB |
|--------------|------------------------------|---|--------------|------------------------------|------------------------------|--------------|
| 5650.00 | Peak | 49.43 | 8.08 | 57.51 | 68.20 | -10.69 |
| 5700.00 | Peak | 49.24 | 8.02 | 57.26 | 105.20 | -47.94 |
| 5720.00 | Peak | 49.30 | 8.10 | 57.40 | 110.80 | -53.40 |
| 5725.00 | Peak | 49.25 | 8.12 | 57.37 | 122.20 | -64.83 |

Unless otherwise stated the results shown in this test report refer only to the sample(s) tested and such sample(s) are retained for 90 days only.

除非另有說明，此報告結果僅對測試之樣品負責，同時此樣品僅保留90天。本報告未經本公司書面許可，不可部份複製。

This document is issued by the Company subject to its General Conditions of Service printed overleaf, available on request or accessible at <http://www.sgs.com.tw/Terms-and-Conditions> and for electronic format documents, subject to Terms and Conditions for Electronic Documents at <http://www.sgs.com.tw/Terms-and-Conditions>. Attention is drawn to the limitation of liability, indemnification and jurisdiction issues defined therein. Any holder of this document is advised that information contained hereon reflects the Company's findings at the time of its intervention only and within the limits of Client's instructions, if any. The Company's sole responsibility is to its Client and this document does not exonerate parties to a transaction from exercising all their rights and obligations under the transaction documents. This document cannot be reproduced except in full, without prior written approval of the Company. Any unauthorized alteration, forgery or falsification of the content or appearance of this document is unlawful and offenders may be prosecuted to the fullest extent of the law.

| | | | |
|----------------|-----------------------|--------------|------------------|
| Report Number | :ER-2021-20085 | Test Site | :SAC III Chamber |
| Operation Mode | :802.11ax80 RU 484/65 | Test Date | :2021-03-16 |
| Test Frequency | :5775 MHz | Temp./Humi. | :22.7/63 |
| Test Mode | :Bandedge CH Low | Antenna Pol. | :VERTICAL |
| EUT Pol | :H Plane | Engineer | :Ricky |

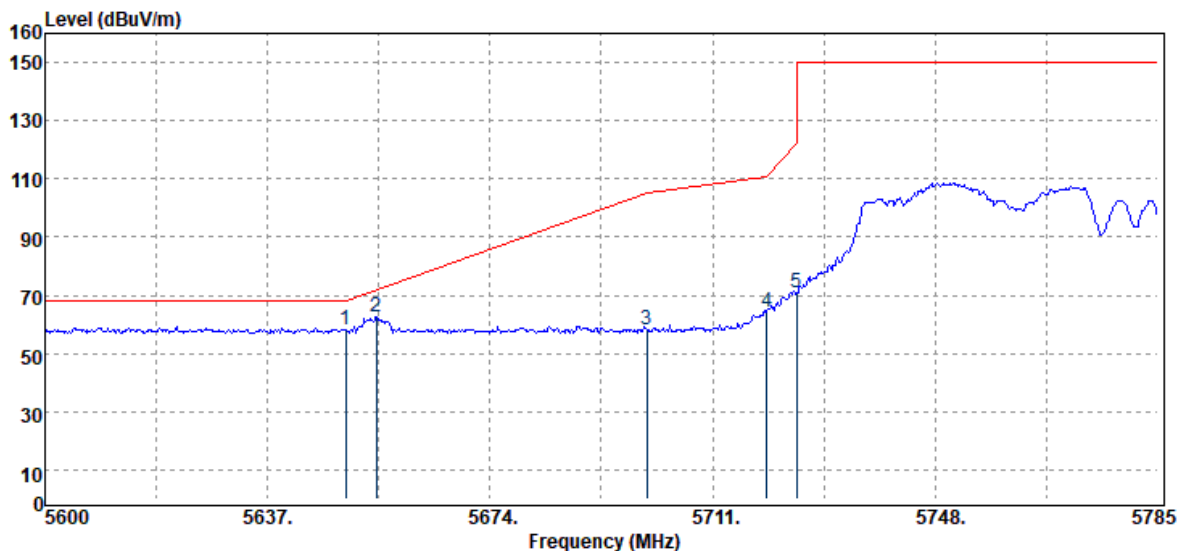

| Freq. MHz | Detector Mode PK/QP/AV | Spectrum Reading Level dB μ V | Factor dB | Actual FS dB μ V/m | Limit @3m dB μ V/m | Margin dB |
|--------------|------------------------------|---|--------------|------------------------------|------------------------------|--------------|
| 5650.00 | Peak | 50.08 | 8.08 | 58.16 | 68.20 | -10.04 |
| 5655.13 | Peak | 54.46 | 8.07 | 62.53 | 72.00 | -9.47 |
| 5700.00 | Peak | 50.23 | 8.02 | 58.25 | 105.20 | -46.95 |
| 5720.00 | Peak | 56.32 | 8.10 | 64.42 | 110.80 | -46.38 |
| 5725.00 | Peak | 62.59 | 8.12 | 70.71 | 122.20 | -51.49 |

Unless otherwise stated the results shown in this test report refer only to the sample(s) tested and such sample(s) are retained for 90 days only.

除非另有說明，此報告結果僅對測試之樣品負責，同時此樣品僅保留90天。本報告未經本公司書面許可，不可部份複製。

This document is issued by the Company subject to its General Conditions of Service printed overleaf, available on request or accessible at <http://www.sgs.com.tw/Terms-and-Conditions> and for electronic format documents, subject to Terms and Conditions for Electronic Documents at <http://www.sgs.com.tw/Terms-and-Conditions>. Attention is drawn to the limitation of liability, indemnification and jurisdiction issues defined therein. Any holder of this document is advised that information contained hereon reflects the Company's findings at the time of its intervention only and within the limits of Client's instructions, if any. The Company's sole responsibility is to its Client and this document does not exonerate parties to a transaction from exercising all their rights and obligations under the transaction documents. This document cannot be reproduced except in full, without prior written approval of the Company. Any unauthorized alteration, forgery or falsification of the content or appearance of this document is unlawful and offenders may be prosecuted to the fullest extent of the law.

| | | | |
|----------------|-----------------------|--------------|------------------|
| Report Number | :ER-2021-20085 | Test Site | :SAC III Chamber |
| Operation Mode | :802.11ax80 RU 484/65 | Test Date | :2021-03-16 |
| Test Frequency | :5775 MHz | Temp./Humi. | :22.7/63 |
| Test Mode | :Bandedge CH Low | Antenna Pol. | :HORIZONTAL |
| EUT Pol | :H Plane | Engineer | :Ricky |

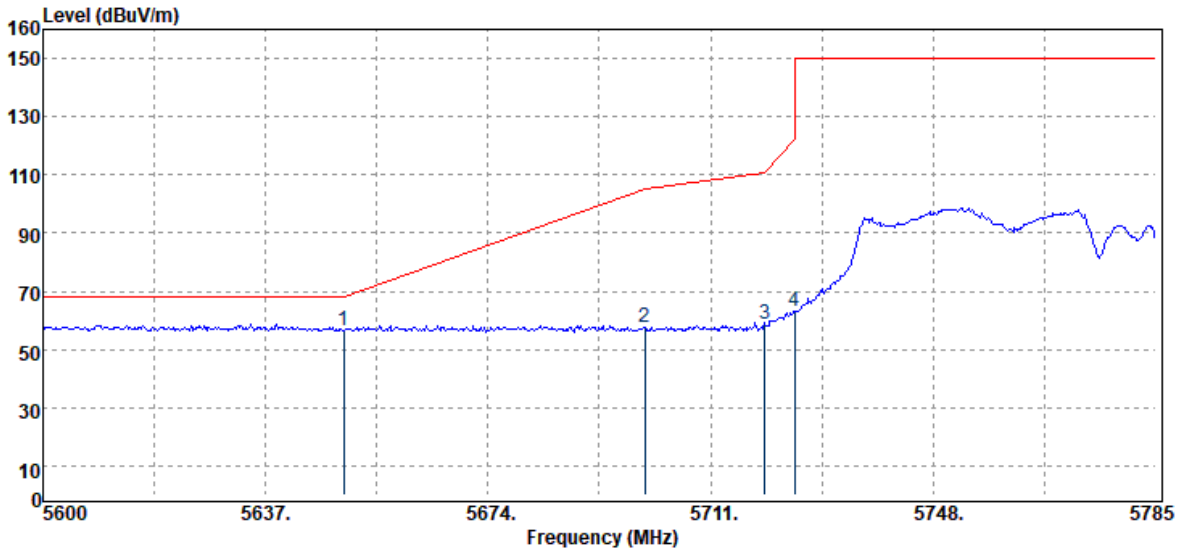

| Freq. MHz | Detector Mode PK/QP/AV | Spectrum Reading Level dB μ V | Factor dB | Actual FS dB μ V/m | Limit @3m dB μ V/m | Margin dB |
|--------------|------------------------------|---|--------------|------------------------------|------------------------------|--------------|
| 5650.00 | Peak | 48.22 | 8.08 | 56.30 | 68.20 | -11.90 |
| 5700.00 | Peak | 49.31 | 8.02 | 57.33 | 105.20 | -47.87 |
| 5720.00 | Peak | 50.63 | 8.10 | 58.73 | 110.80 | -52.07 |
| 5725.00 | Peak | 55.14 | 8.12 | 63.26 | 122.20 | -58.94 |

Unless otherwise stated the results shown in this test report refer only to the sample(s) tested and such sample(s) are retained for 90 days only.

除非另有說明，此報告結果僅對測試之樣品負責，同時此樣品僅保留90天。本報告未經本公司書面許可，不可部份複製。

This document is issued by the Company subject to its General Conditions of Service printed overleaf, available on request or accessible at <http://www.sgs.com.tw/Terms-and-Conditions> and for electronic format documents, subject to Terms and Conditions for Electronic Documents at <http://www.sgs.com.tw/Terms-and-Conditions>. Attention is drawn to the limitation of liability, indemnification and jurisdiction issues defined therein. Any holder of this document is advised that information contained hereon reflects the Company's findings at the time of its intervention only and within the limits of Client's instructions, if any. The Company's sole responsibility is to its Client and this document does not exonerate parties to a transaction from exercising all their rights and obligations under the transaction documents. This document cannot be reproduced except in full, without prior written approval of the Company. Any unauthorized alteration, forgery or falsification of the content or appearance of this document is unlawful and offenders may be prosecuted to the fullest extent of the law.

| | | | |
|----------------|---------------------|--------------|------------------|
| Report Number | :ER-2021-20085 | Test Site | :SAC III Chamber |
| Operation Mode | :802.11ax80 RU full | Test Date | :2021-03-16 |
| Test Frequency | :5775 MHz | Temp./Humi. | :22.7/63 |
| Test Mode | :Bandedge CH Low | Antenna Pol. | :VERTICAL |
| EUT Pol | :H Plane | Engineer | :Ricky |

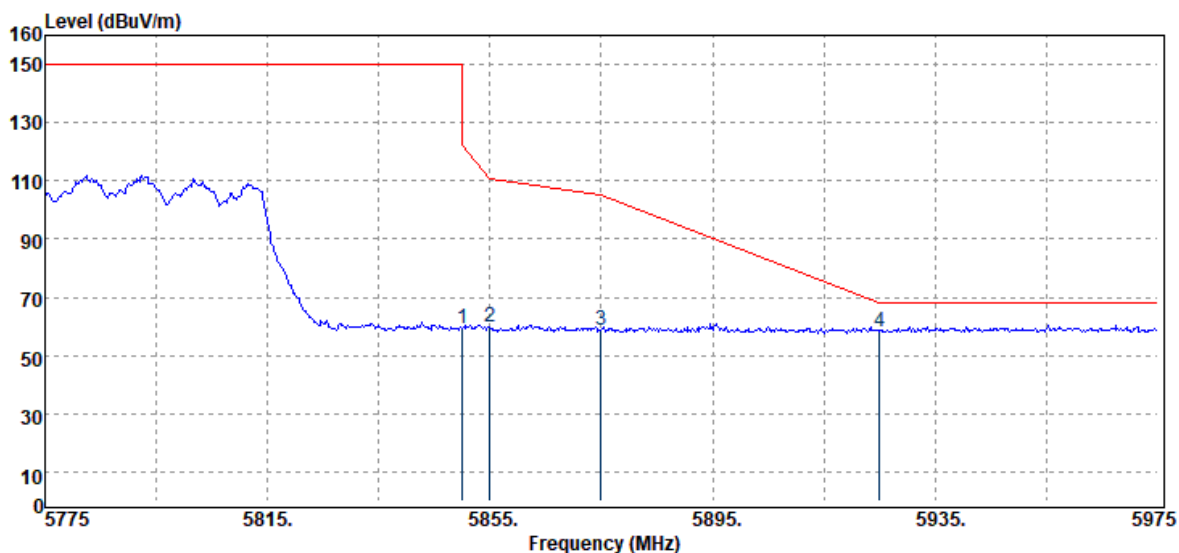

| Freq. MHz | Detector Mode PK/QP/AV | Spectrum Reading Level dB μ V | Factor dB | Actual FS dB μ V/m | Limit @3m dB μ V/m | Margin dB |
|--------------|------------------------------|---|--------------|------------------------------|------------------------------|--------------|
| 5850.00 | Peak | 50.46 | 9.02 | 59.48 | 122.20 | -62.72 |
| 5855.00 | Peak | 50.78 | 9.07 | 59.85 | 110.80 | -50.95 |
| 5875.00 | Peak | 49.24 | 9.27 | 58.51 | 105.20 | -46.69 |
| 5925.00 | Peak | 48.68 | 9.70 | 58.38 | 68.20 | -9.82 |

Unless otherwise stated the results shown in this test report refer only to the sample(s) tested and such sample(s) are retained for 90 days only.

除非另有說明，此報告結果僅對測試之樣品負責，同時此樣品僅保留90天。本報告未經本公司書面許可，不可部份複製。

This document is issued by the Company subject to its General Conditions of Service printed overleaf, available on request or accessible at <http://www.sgs.com.tw/Terms-and-Conditions> and for electronic format documents, subject to Terms and Conditions for Electronic Documents at <http://www.sgs.com.tw/Terms-and-Conditions>. Attention is drawn to the limitation of liability, indemnification and jurisdiction issues defined therein. Any holder of this document is advised that information contained hereon reflects the Company's findings at the time of its intervention only and within the limits of Client's instructions, if any. The Company's sole responsibility is to its Client and this document does not exonerate parties to a transaction from exercising all their rights and obligations under the transaction documents. This document cannot be reproduced except in full, without prior written approval of the Company. Any unauthorized alteration, forgery or falsification of the content or appearance of this document is unlawful and offenders may be prosecuted to the fullest extent of the law.

| | | | |
|----------------|---------------------|--------------|------------------|
| Report Number | :ER-2021-20085 | Test Site | :SAC III Chamber |
| Operation Mode | :802.11ax80 RU full | Test Date | :2021-03-16 |
| Test Frequency | :5775 MHz | Temp./Humi. | :22.7/63 |
| Test Mode | :Bandedge CH Low | Antenna Pol. | :HORIZONTAL |
| EUT Pol | :H Plane | Engineer | :Ricky |

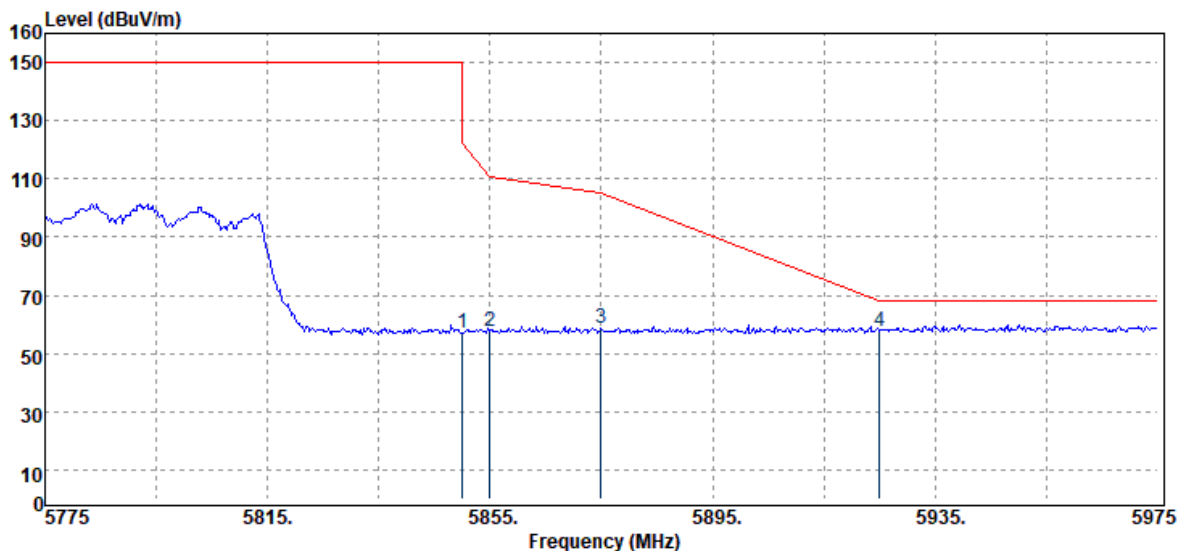

| Freq. MHz | Detector Mode PK/QP/AV | Spectrum Reading Level dB μ V | Factor dB | Actual FS dB μ V/m | Limit @3m dB μ V/m | Margin dB |
|--------------|------------------------------|---|--------------|------------------------------|------------------------------|--------------|
| 5850.00 | Peak | 47.97 | 9.02 | 56.99 | 122.20 | -65.21 |
| 5855.00 | Peak | 48.43 | 9.07 | 57.50 | 110.80 | -53.30 |
| 5875.00 | Peak | 49.29 | 9.27 | 58.56 | 105.20 | -46.64 |
| 5925.00 | Peak | 47.91 | 9.70 | 57.61 | 68.20 | -10.59 |

Unless otherwise stated the results shown in this test report refer only to the sample(s) tested and such sample(s) are retained for 90 days only.

除非另有說明，此報告結果僅對測試之樣品負責，同時此樣品僅保留90天。本報告未經本公司書面許可，不可部份複製。

This document is issued by the Company subject to its General Conditions of Service printed overleaf, available on request or accessible at <http://www.sgs.com.tw/Terms-and-Conditions> and for electronic format documents, subject to Terms and Conditions for Electronic Documents at <http://www.sgs.com.tw/Terms-and-Conditions>. Attention is drawn to the limitation of liability, indemnification and jurisdiction issues defined therein. Any holder of this document is advised that information contained hereon reflects the Company's findings at the time of its intervention only and within the limits of Client's instructions, if any. The Company's sole responsibility is to its Client and this document does not exonerate parties to a transaction from exercising all their rights and obligations under the transaction documents. This document cannot be reproduced except in full, without prior written approval of the Company. Any unauthorized alteration, forgery or falsification of the content or appearance of this document is unlawful and offenders may be prosecuted to the fullest extent of the law.

| | | | |
|----------------|-----------------------|--------------|------------------|
| Report Number | :ER-2021-20085 | Test Site | :SAC III Chamber |
| Operation Mode | :802.11ax80 RU 484/66 | Test Date | :2021-03-16 |
| Test Frequency | :5775 MHz | Temp./Humi. | :22.7/63 |
| Test Mode | :Bandedge CH Low | Antenna Pol. | :VERTICAL |
| EUT Pol | :H Plane | Engineer | :Ricky |

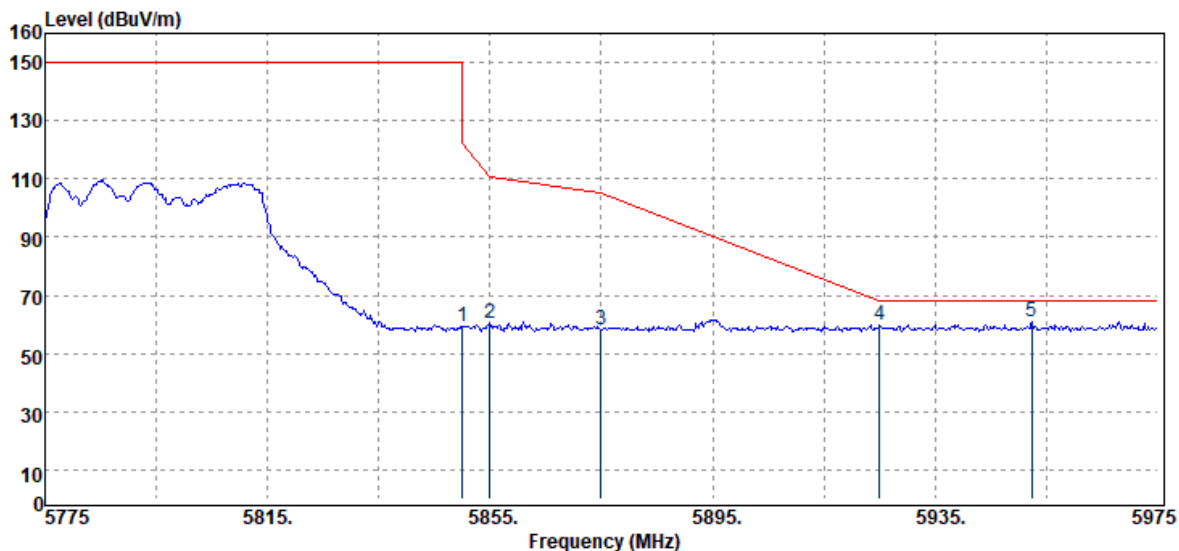

| Freq. MHz | Detector Mode PK/QP/AV | Spectrum Reading Level dB μ V | Factor dB | Actual FS dB μ V/m | Limit @3m dB μ V/m | Margin dB |
|--------------|------------------------------|---|--------------|------------------------------|------------------------------|--------------|
| 5850.00 | Peak | 50.48 | 9.02 | 59.50 | 122.20 | -62.70 |
| 5855.00 | Peak | 51.43 | 9.07 | 60.50 | 110.80 | -50.30 |
| 5875.00 | Peak | 48.76 | 9.27 | 58.03 | 105.20 | -47.17 |
| 5925.00 | Peak | 49.87 | 9.70 | 59.57 | 68.20 | -8.63 |
| 5952.40 | Peak | 50.97 | 9.89 | 60.86 | 68.20 | -7.34 |

Unless otherwise stated the results shown in this test report refer only to the sample(s) tested and such sample(s) are retained for 90 days only.

除非另有說明，此報告結果僅對測試之樣品負責，同時此樣品僅保留90天。本報告未經本公司書面許可，不可部份複製。

This document is issued by the Company subject to its General Conditions of Service printed overleaf, available on request or accessible at <http://www.sgs.com.tw/Terms-and-Conditions> and for electronic format documents, subject to Terms and Conditions for Electronic Documents at <http://www.sgs.com.tw/Terms-and-Conditions>. Attention is drawn to the limitation of liability, indemnification and jurisdiction issues defined therein. Any holder of this document is advised that information contained hereon reflects the Company's findings at the time of its intervention only and within the limits of Client's instructions, if any. The Company's sole responsibility is to its Client and this document does not exonerate parties to a transaction from exercising all their rights and obligations under the transaction documents. This document cannot be reproduced except in full, without prior written approval of the Company. Any unauthorized alteration, forgery or falsification of the content or appearance of this document is unlawful and offenders may be prosecuted to the fullest extent of the law.

| | | | |
|----------------|-----------------------|--------------|------------------|
| Report Number | :ER-2021-20085 | Test Site | :SAC III Chamber |
| Operation Mode | :802.11ax80 RU 484/66 | Test Date | :2021-03-16 |
| Test Frequency | :5775 MHz | Temp./Humi. | :22.7/63 |
| Test Mode | :Bandedge CH Low | Antenna Pol. | :HORIZONTAL |
| EUT Pol | :H Plane | Engineer | :Ricky |

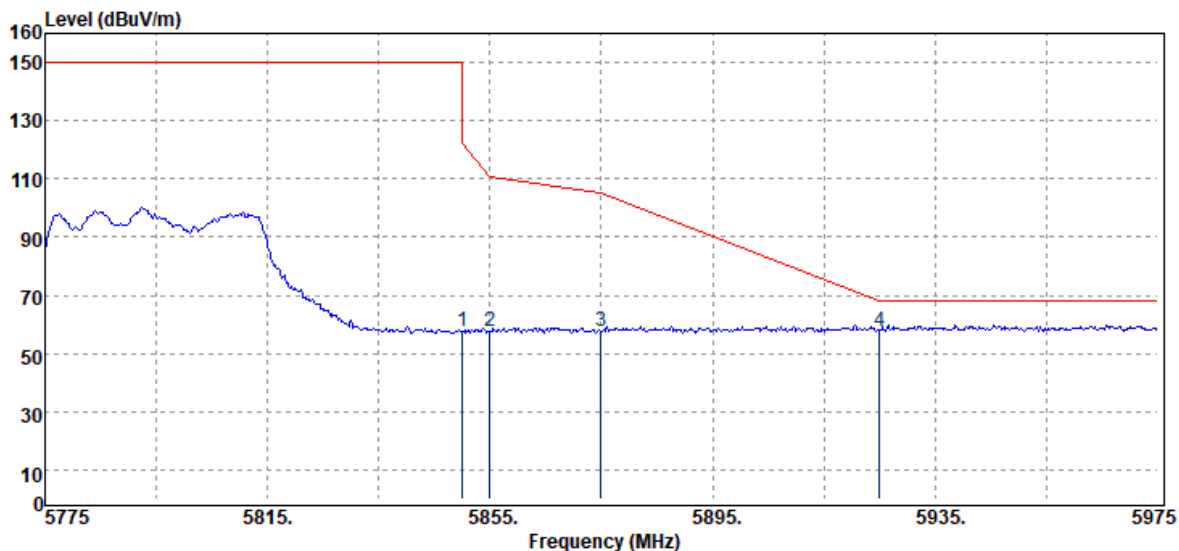

| Freq. MHz | Detector Mode PK/QP/AV | Spectrum Reading Level dB μ V | Factor dB | Actual FS dB μ V/m | Limit @3m dB μ V/m | Margin dB |
|--------------|------------------------------|---|--------------|------------------------------|------------------------------|--------------|
| 5850.00 | Peak | 48.78 | 9.02 | 57.80 | 122.20 | -64.40 |
| 5855.00 | Peak | 48.54 | 9.07 | 57.61 | 110.80 | -53.19 |
| 5875.00 | Peak | 48.23 | 9.27 | 57.50 | 105.20 | -47.70 |
| 5925.00 | Peak | 48.09 | 9.70 | 57.79 | 68.20 | -10.41 |

Unless otherwise stated the results shown in this test report refer only to the sample(s) tested and such sample(s) are retained for 90 days only.

除非另有說明，此報告結果僅對測試之樣品負責，同時此樣品僅保留90天。本報告未經本公司書面許可，不可部份複製。

This document is issued by the Company subject to its General Conditions of Service printed overleaf, available on request or accessible at <http://www.sgs.com.tw/Terms-and-Conditions> and for electronic format documents, subject to Terms and Conditions for Electronic Documents at <http://www.sgs.com.tw/Terms-and-Conditions>. Attention is drawn to the limitation of liability, indemnification and jurisdiction issues defined therein. Any holder of this document is advised that information contained hereon reflects the Company's findings at the time of its intervention only and within the limits of Client's instructions, if any. The Company's sole responsibility is to its Client and this document does not exonerate parties to a transaction from exercising all their rights and obligations under the transaction documents. This document cannot be reproduced except in full, without prior written approval of the Company. Any unauthorized alteration, forgery or falsification of the content or appearance of this document is unlawful and offenders may be prosecuted to the fullest extent of the law.

11.8 CDD Mode Radiated Spurious Emission Measurement Result

11.8.1 Below 1GHz Worst-Case Data:

| | | | |
|----------------|----------------|--------------|------------------|
| Report Number | :ER-2021-20085 | Test Site | :SAC III Chamber |
| Operation Mode | :802.11a | Test Date | :2021-03-05 |
| Test Frequency | :5220 MHz | Temp./Humi. | :21.8/63 |
| Test Mode | :Tx CH Mid | Antenna Pol. | :VERTICAL |
| EUT Pol | :H Plane | Engineer | :Ricky |

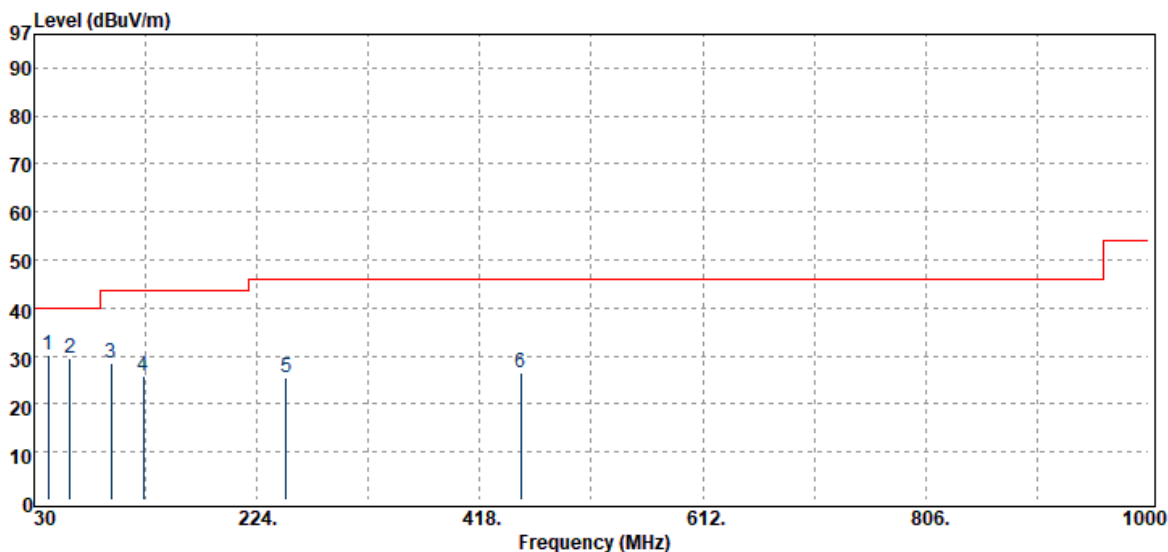

| Freq. MHz | Detector Mode PK/QP/AV | Spectrum Reading Level d μ V | Factor dB | Actual FS dBUV/m | Limit @3m dBUV/m | Margin dB |
|--------------|------------------------------|--|--------------|------------------------|------------------------|--------------|
| 42.61 | Peak | 38.83 | -8.72 | 30.11 | 40.00 | -9.89 |
| 61.04 | Peak | 38.67 | -9.19 | 29.48 | 40.00 | -10.52 |
| 96.93 | Peak | 42.05 | -13.61 | 28.44 | 43.50 | -15.06 |
| 125.06 | Peak | 35.41 | -9.47 | 25.94 | 43.50 | -17.56 |
| 249.22 | Peak | 34.24 | -8.82 | 25.42 | 46.00 | -20.58 |
| 453.89 | Peak | 29.85 | -3.17 | 26.68 | 46.00 | -19.32 |

Unless otherwise stated the results shown in this test report refer only to the sample(s) tested and such sample(s) are retained for 90 days only.

除非另有說明，此報告結果僅對測試之樣品負責，同時此樣品僅保留90天。本報告未經本公司書面許可，不可部份複製。

This document is issued by the Company subject to its General Conditions of Service printed overleaf, available on request or accessible at <http://www.sgs.com.tw/Terms-and-Conditions> and for electronic format documents, subject to Terms and Conditions for Electronic Documents at <http://www.sgs.com.tw/Terms-and-Conditions>. Attention is drawn to the limitation of liability, indemnification and jurisdiction issues defined therein. Any holder of this document is advised that information contained hereon reflects the Company's findings at the time of its intervention only and within the limits of Client's instructions, if any. The Company's sole responsibility is to its Client and this document does not exonerate parties to a transaction from exercising all their rights and obligations under the transaction documents. This document cannot be reproduced except in full, without prior written approval of the Company. Any unauthorized alteration, forgery or falsification of the content or appearance of this document is unlawful and offenders may be prosecuted to the fullest extent of the law.

Report Number :ER-2021-20085
 Operation Mode :802.11a
 Test Frequency :5220 MHz
 Test Mode :Tx CH Mid
 EUT Pol :H Plane

Test Site :SAC III Chamber
 Test Date :2021-03-05
 Temp./Humi. :21.8/63
 Antenna Pol. :HORIZONTAL
 Engineer :Ricky

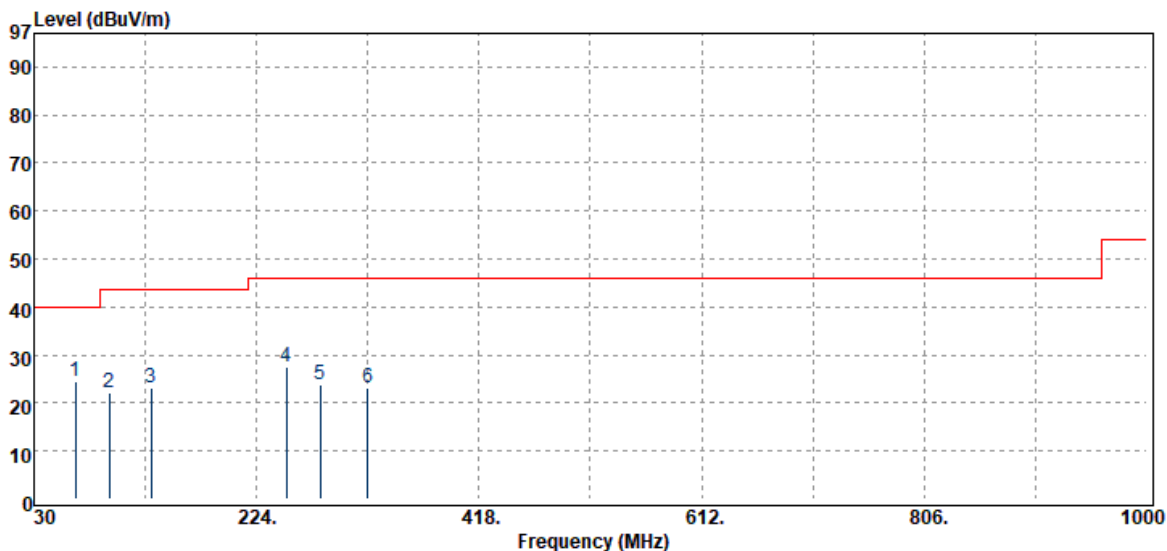

| Freq. MHz | Detector Mode PK/QP/AV | Spectrum Reading Level dB μ V | Factor dB | Actual FS dB μ V/m | Limit @3m dB μ V/m | Margin dB |
|--------------|------------------------------|---|--------------|------------------------------|------------------------------|--------------|
| 65.89 | Peak | 34.61 | -9.96 | 24.65 | 40.00 | -15.35 |
| 95.96 | Peak | 36.26 | -13.99 | 22.27 | 43.50 | -21.23 |
| 131.85 | Peak | 31.96 | -8.81 | 23.15 | 43.50 | -20.35 |
| 250.19 | Peak | 36.30 | -8.79 | 27.51 | 46.00 | -18.49 |
| 279.29 | Peak | 30.94 | -7.24 | 23.70 | 46.00 | -22.30 |
| 321.00 | Peak | 29.14 | -6.04 | 23.10 | 46.00 | -22.90 |

Unless otherwise stated the results shown in this test report refer only to the sample(s) tested and such sample(s) are retained for 90 days only.

除非另有說明，此報告結果僅對測試之樣品負責，同時此樣品僅保留90天。本報告未經本公司書面許可，不可部份複製。

This document is issued by the Company subject to its General Conditions of Service printed overleaf, available on request or accessible at <http://www.sgs.com.tw/Terms-and-Conditions> and for electronic format documents, subject to Terms and Conditions for Electronic Documents at <http://www.sgs.com.tw/Terms-and-Conditions>. Attention is drawn to the limitation of liability, indemnification and jurisdiction issues defined therein. Any holder of this document is advised that information contained hereon reflects the Company's findings at the time of its intervention only and within the limits of Client's instructions, if any. The Company's sole responsibility is to its Client and this document does not exonerate parties to a transaction from exercising all their rights and obligations under the transaction documents. This document cannot be reproduced except in full, without prior written approval of the Company. Any unauthorized alteration, forgery or falsification of the content or appearance of this document is unlawful and offenders may be prosecuted to the fullest extent of the law.

Report Number :ER-2021-20085
 Operation Mode :802.11a
 Test Frequency :5300 MHz
 Test Mode :Tx CH Mid
 EUT Pol :H Plane

Test Site :SAC III Chamber
 Test Date :2021-03-05
 Temp./Humi. :21.8/63
 Antenna Pol. :VERTICAL
 Engineer :Ricky

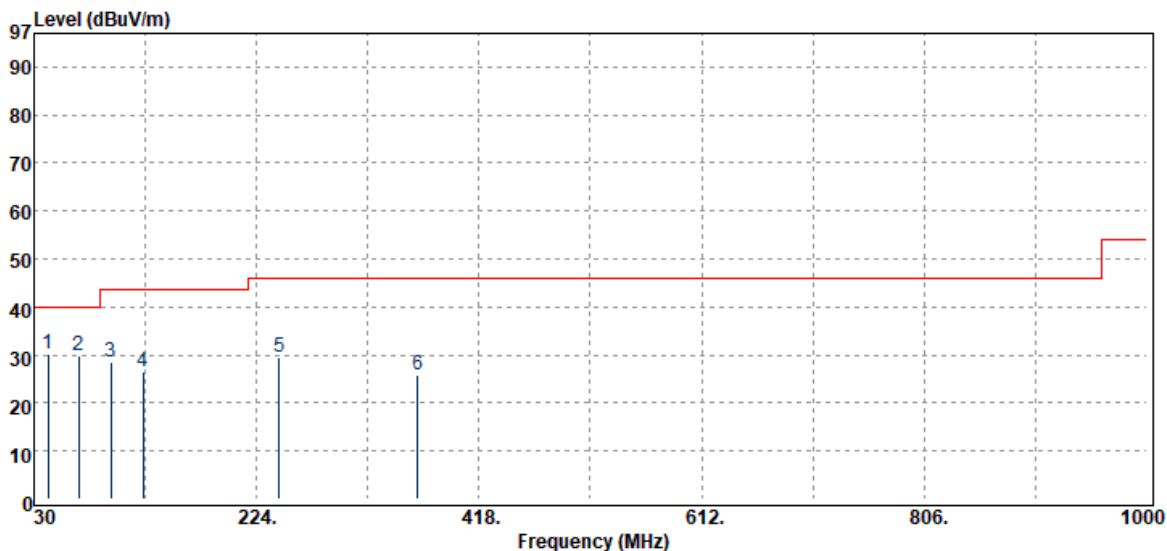

| Freq. MHz | Detector Mode PK/QP/AV | Spectrum Reading Level dBμV | Factor dB | Actual FS dBμV/m | Limit @3m dBμV/m | Margin dB |
|--------------|------------------------------|-----------------------------------|--------------|------------------------|------------------------|--------------|
| 42.61 | Peak | 38.83 | -8.72 | 30.11 | 40.00 | -9.89 |
| 68.80 | Peak | 40.18 | -10.18 | 30.00 | 40.00 | -10.00 |
| 96.93 | Peak | 42.13 | -13.61 | 28.52 | 43.50 | -14.98 |
| 125.06 | Peak | 35.82 | -9.47 | 26.35 | 43.50 | -17.15 |
| 243.40 | Peak | 38.55 | -9.00 | 29.55 | 46.00 | -16.45 |
| 364.65 | Peak | 31.18 | -5.47 | 25.71 | 46.00 | -20.29 |

Unless otherwise stated the results shown in this test report refer only to the sample(s) tested and such sample(s) are retained for 90 days only.

除非另有說明，此報告結果僅對測試之樣品負責，同時此樣品僅保留90天。本報告未經本公司書面許可，不可部份複製。

This document is issued by the Company subject to its General Conditions of Service printed overleaf, available on request or accessible at <http://www.sgs.com.tw/Terms-and-Conditions> and for electronic format documents, subject to Terms and Conditions for Electronic Documents at <http://www.sgs.com.tw/Terms-and-Conditions>. Attention is drawn to the limitation of liability, indemnification and jurisdiction issues defined therein. Any holder of this document is advised that information contained hereon reflects the Company's findings at the time of its intervention only and within the limits of Client's instructions, if any. The Company's sole responsibility is to its Client and this document does not exonerate parties to a transaction from exercising all their rights and obligations under the transaction documents. This document cannot be reproduced except in full, without prior written approval of the Company. Any unauthorized alteration, forgery or falsification of the content or appearance of this document is unlawful and offenders may be prosecuted to the fullest extent of the law.

Report Number :ER-2021-20085
 Operation Mode :802.11a
 Test Frequency :5300 MHz
 Test Mode :Tx CH Mid
 EUT Pol :H Plane

Test Site :SAC III Chamber
 Test Date :2021-03-05
 Temp./Humi. :21.8/63
 Antenna Pol. :HORIZONTAL
 Engineer :Ricky

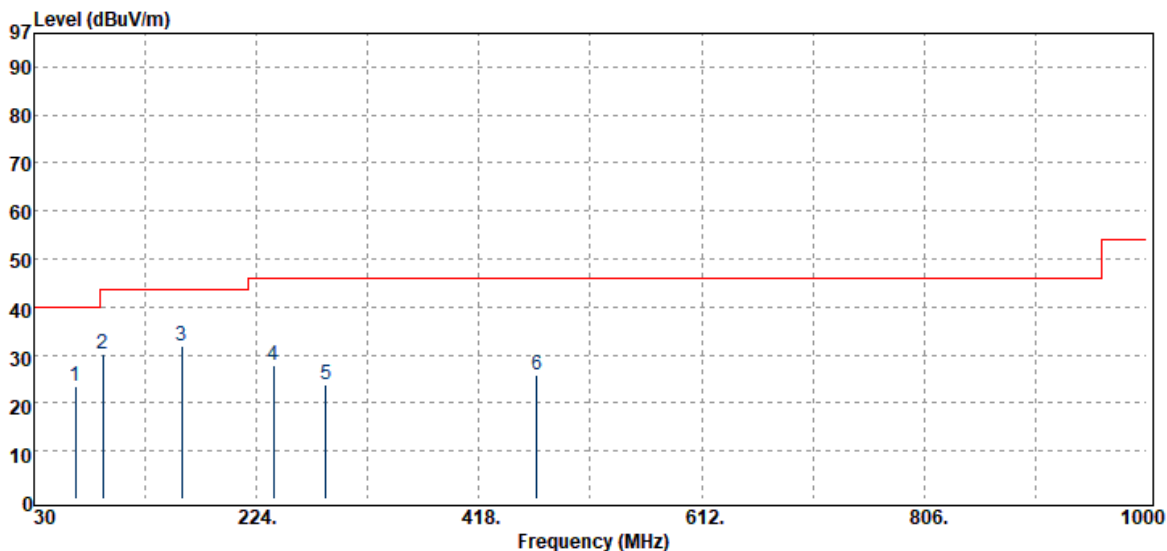

| Freq. MHz | Detector Mode PK/QP/AV | Spectrum Reading Level dB μ V | Factor dB | Actual FS dB μ V/m | Limit @3m dB μ V/m | Margin dB |
|--------------|------------------------------|---|--------------|------------------------------|------------------------------|--------------|
| 65.89 | Peak | 33.58 | -9.96 | 23.62 | 40.00 | -16.38 |
| 90.14 | Peak | 44.35 | -14.26 | 30.09 | 43.50 | -13.41 |
| 159.01 | Peak | 39.66 | -7.91 | 31.75 | 43.50 | -11.75 |
| 238.55 | Peak | 36.82 | -9.12 | 27.70 | 46.00 | -18.30 |
| 284.14 | Peak | 31.08 | -7.10 | 23.98 | 46.00 | -22.02 |
| 468.44 | Peak | 29.07 | -3.06 | 26.01 | 46.00 | -19.99 |

Unless otherwise stated the results shown in this test report refer only to the sample(s) tested and such sample(s) are retained for 90 days only.

除非另有說明，此報告結果僅對測試之樣品負責，同時此樣品僅保留90天。本報告未經本公司書面許可，不可部份複製。

This document is issued by the Company subject to its General Conditions of Service printed overleaf, available on request or accessible at <http://www.sgs.com.tw/Terms-and-Conditions> and for electronic format documents, subject to Terms and Conditions for Electronic Documents at <http://www.sgs.com.tw/Terms-and-Conditions>. Attention is drawn to the limitation of liability, indemnification and jurisdiction issues defined therein. Any holder of this document is advised that information contained hereon reflects the Company's findings at the time of its intervention only and within the limits of Client's instructions, if any. The Company's sole responsibility is to its Client and this document does not exonerate parties to a transaction from exercising all their rights and obligations under the transaction documents. This document cannot be reproduced except in full, without prior written approval of the Company. Any unauthorized alteration, forgery or falsification of the content or appearance of this document is unlawful and offenders may be prosecuted to the fullest extent of the law.

Report Number :ER-2021-20085
 Operation Mode :802.11a
 Test Frequency :5580 MHz
 Test Mode :Tx CH Mid
 EUT Pol :H Plane

Test Site :SAC III Chamber
 Test Date :2021-03-05
 Temp./Humi. :21.8/63
 Antenna Pol. :VERTICAL
 Engineer :Ricky

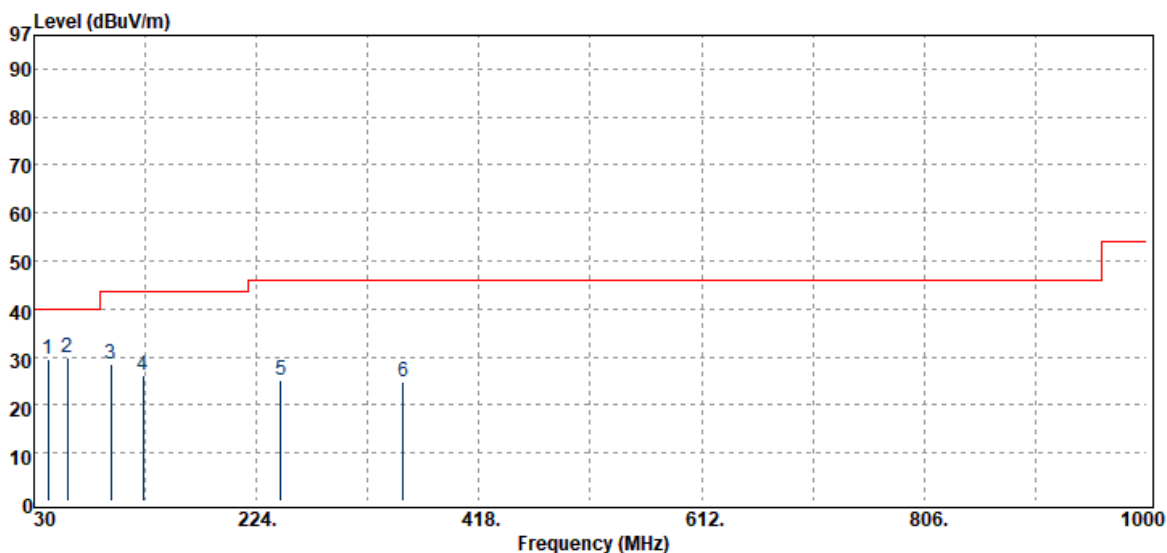

| Freq. MHz | Detector Mode PK/QP/AV | Spectrum Reading Level dBuV | Factor dB | Actual FS dBuV/m | Limit @3m dBuV/m | Margin dB |
|--------------|------------------------------|-----------------------------------|--------------|------------------------|------------------------|--------------|
| 42.61 | Peak | 38.30 | -8.72 | 29.58 | 40.00 | -10.42 |
| 59.10 | Peak | 39.07 | -9.27 | 29.80 | 40.00 | -10.20 |
| 96.93 | Peak | 42.01 | -13.61 | 28.40 | 43.50 | -15.10 |
| 125.06 | Peak | 35.74 | -9.47 | 26.27 | 43.50 | -17.23 |
| 245.34 | Peak | 33.98 | -8.96 | 25.02 | 46.00 | -20.98 |
| 352.04 | Peak | 30.53 | -5.80 | 24.73 | 46.00 | -21.27 |

Unless otherwise stated the results shown in this test report refer only to the sample(s) tested and such sample(s) are retained for 90 days only.

除非另有說明，此報告結果僅對測試之樣品負責，同時此樣品僅保留90天。本報告未經本公司書面許可，不可部份複製。

This document is issued by the Company subject to its General Conditions of Service printed overleaf, available on request or accessible at <http://www.sgs.com.tw/Terms-and-Conditions> and for electronic format documents, subject to Terms and Conditions for Electronic Documents at <http://www.sgs.com.tw/Terms-and-Conditions>. Attention is drawn to the limitation of liability, indemnification and jurisdiction issues defined therein. Any holder of this document is advised that information contained hereon reflects the Company's findings at the time of its intervention only and within the limits of Client's instructions, if any. The Company's sole responsibility is to its Client and this document does not exonerate parties to a transaction from exercising all their rights and obligations under the transaction documents. This document cannot be reproduced except in full, without prior written approval of the Company. Any unauthorized alteration, forgery or falsification of the content or appearance of this document is unlawful and offenders may be prosecuted to the fullest extent of the law.

Report Number :ER-2021-20085
 Operation Mode :802.11a
 Test Frequency :5580 MHz
 Test Mode :Tx CH Mid
 EUT Pol :H Plane

Test Site :SAC III Chamber
 Test Date :2021-03-05
 Temp./Humi. :21.8/63
 Antenna Pol. :HORIZONTAL
 Engineer :Ricky

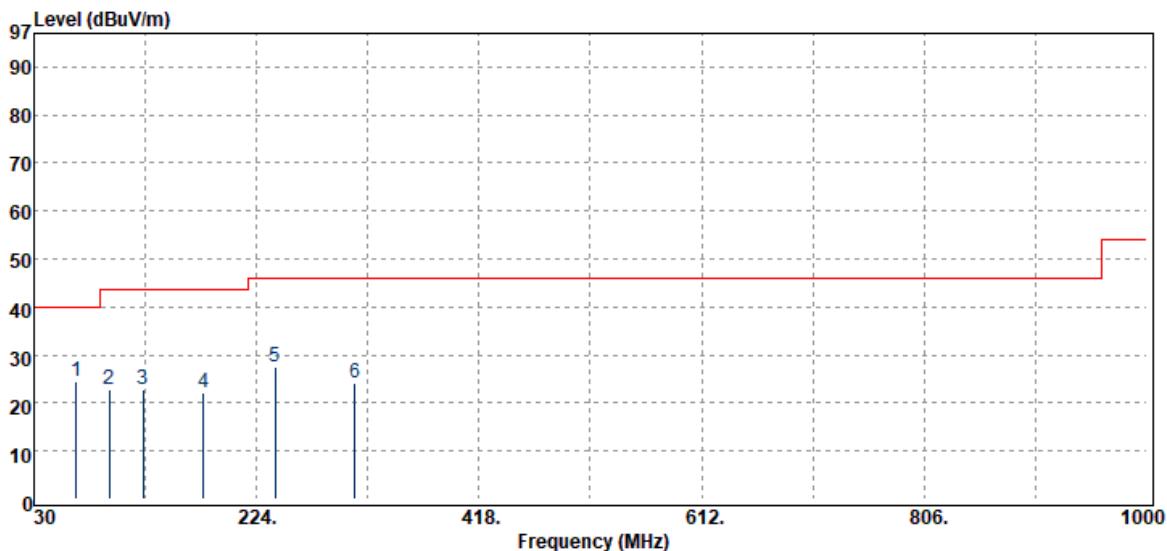

| Freq. MHz | Detector Mode PK/QP/AV | Spectrum Reading Level dB μ V | Factor dB | Actual FS dB μ V/m | Limit @3m dB μ V/m | Margin dB |
|--------------|------------------------------|---|--------------|------------------------------|------------------------------|--------------|
| 66.86 | Peak | 34.57 | -9.98 | 24.59 | 40.00 | -15.41 |
| 95.96 | Peak | 36.67 | -13.99 | 22.68 | 43.50 | -20.82 |
| 125.06 | Peak | 32.19 | -9.47 | 22.72 | 43.50 | -20.78 |
| 177.44 | Peak | 31.13 | -8.98 | 22.15 | 43.50 | -21.35 |
| 240.49 | Peak | 36.69 | -9.04 | 27.65 | 46.00 | -18.35 |
| 309.36 | Peak | 30.57 | -6.49 | 24.08 | 46.00 | -21.92 |

Unless otherwise stated the results shown in this test report refer only to the sample(s) tested and such sample(s) are retained for 90 days only.

除非另有說明，此報告結果僅對測試之樣品負責，同時此樣品僅保留90天。本報告未經本公司書面許可，不可部份複製。

This document is issued by the Company subject to its General Conditions of Service printed overleaf, available on request or accessible at <http://www.sgs.com.tw/Terms-and-Conditions> and for electronic format documents, subject to Terms and Conditions for Electronic Documents at <http://www.sgs.com.tw/Terms-and-Conditions>. Attention is drawn to the limitation of liability, indemnification and jurisdiction issues defined therein. Any holder of this document is advised that information contained hereon reflects the Company's findings at the time of its intervention only and within the limits of Client's instructions, if any. The Company's sole responsibility is to its Client and this document does not exonerate parties to a transaction from exercising all their rights and obligations under the transaction documents. This document cannot be reproduced except in full, without prior written approval of the Company. Any unauthorized alteration, forgery or falsification of the content or appearance of this document is unlawful and offenders may be prosecuted to the fullest extent of the law.

Report Number :ER-2021-20085
 Operation Mode :802.11a
 Test Frequency :5785 MHz
 Test Mode :Tx CH Mid
 EUT Pol :H Plane

Test Site :SAC III Chamber
 Test Date :2021-03-05
 Temp./Humi. :21.8/63
 Antenna Pol. :VERTICAL
 Engineer :Ricky

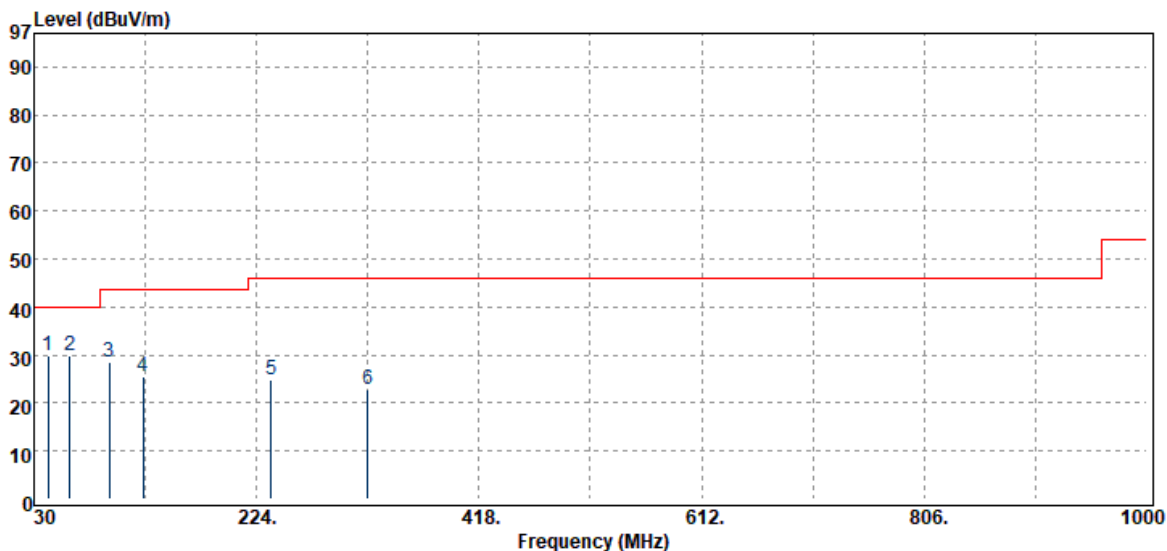

| Freq. MHz | Detector Mode PK/QP/AV | Spectrum Reading Level dBμV | Factor dB | Actual FS dBμV/m | Limit @3m dBμV/m | Margin dB |
|--------------|------------------------------|-----------------------------------|--------------|------------------------|------------------------|--------------|
| 42.61 | Peak | 38.75 | -8.72 | 30.03 | 40.00 | -9.97 |
| 61.04 | Peak | 39.09 | -9.19 | 29.90 | 40.00 | -10.10 |
| 95.96 | Peak | 42.54 | -13.99 | 28.55 | 43.50 | -14.95 |
| 125.06 | Peak | 35.07 | -9.47 | 25.60 | 43.50 | -17.90 |
| 236.61 | Peak | 34.23 | -9.23 | 25.00 | 46.00 | -21.00 |
| 321.00 | Peak | 28.95 | -6.04 | 22.91 | 46.00 | -23.09 |

Unless otherwise stated the results shown in this test report refer only to the sample(s) tested and such sample(s) are retained for 90 days only.

除非另有說明，此報告結果僅對測試之樣品負責，同時此樣品僅保留90天。本報告未經本公司書面許可，不可部份複製。

This document is issued by the Company subject to its General Conditions of Service printed overleaf, available on request or accessible at <http://www.sgs.com.tw/Terms-and-Conditions> and for electronic format documents, subject to Terms and Conditions for Electronic Documents at <http://www.sgs.com.tw/Terms-and-Conditions>. Attention is drawn to the limitation of liability, indemnification and jurisdiction issues defined therein. Any holder of this document is advised that information contained hereon reflects the Company's findings at the time of its intervention only and within the limits of Client's instructions, if any. The Company's sole responsibility is to its Client and this document does not exonerate parties to a transaction from exercising all their rights and obligations under the transaction documents. This document cannot be reproduced except in full, without prior written approval of the Company. Any unauthorized alteration, forgery or falsification of the content or appearance of this document is unlawful and offenders may be prosecuted to the fullest extent of the law.

Report Number :ER-2021-20085
 Operation Mode :802.11a
 Test Frequency :5785 MHz
 Test Mode :Tx CH Mid
 EUT Pol :H Plane

Test Site :SAC III Chamber
 Test Date :2021-03-05
 Temp./Humi. :21.8/63
 Antenna Pol. :HORIZONTAL
 Engineer :Ricky

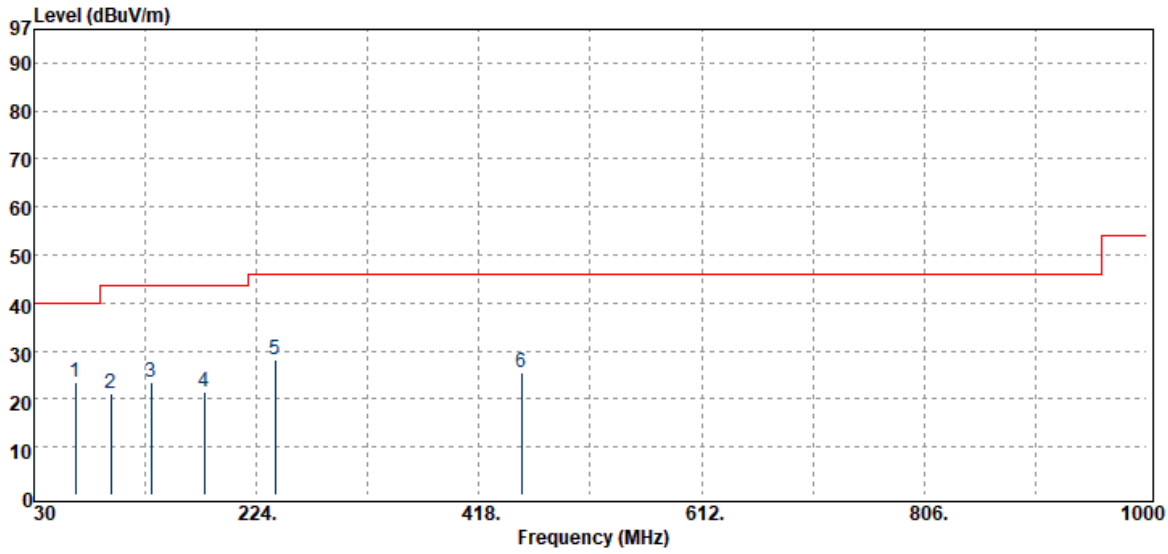

| Freq. MHz | Detector Mode PK/QP/AV | Spectrum Reading Level dBμV | Factor dB | Actual FS dBμV/m | Limit @3m dBμV/m | Margin dB |
|--------------|------------------------------|-----------------------------------|--------------|------------------------|------------------------|--------------|
| 65.89 | Peak | 33.40 | -9.96 | 23.44 | 40.00 | -16.56 |
| 96.93 | Peak | 34.85 | -13.61 | 21.24 | 43.50 | -22.26 |
| 131.85 | Peak | 32.20 | -8.81 | 23.39 | 43.50 | -20.11 |
| 178.41 | Peak | 30.65 | -9.06 | 21.59 | 43.50 | -21.91 |
| 240.49 | Peak | 37.32 | -9.04 | 28.28 | 46.00 | -17.72 |
| 454.86 | Peak | 28.51 | -3.14 | 25.37 | 46.00 | -20.63 |

Unless otherwise stated the results shown in this test report refer only to the sample(s) tested and such sample(s) are retained for 90 days only.

除非另有說明，此報告結果僅對測試之樣品負責，同時此樣品僅保留90天。本報告未經本公司書面許可，不可部份複製。

This document is issued by the Company subject to its General Conditions of Service printed overleaf, available on request or accessible at <http://www.sgs.com.tw/Terms-and-Conditions> and for electronic format documents, subject to Terms and Conditions for Electronic Documents at <http://www.sgs.com.tw/Terms-and-Conditions>. Attention is drawn to the limitation of liability, indemnification and jurisdiction issues defined therein. Any holder of this document is advised that information contained hereon reflects the Company's findings at the time of its intervention only and within the limits of Client's instructions, if any. The Company's sole responsibility is to its Client and this document does not exonerate parties to a transaction from exercising all their rights and obligations under the transaction documents. This document cannot be reproduced except in full, without prior written approval of the Company. Any unauthorized alteration, forgery or falsification of the content or appearance of this document is unlawful and offenders may be prosecuted to the fullest extent of the law.

Report Number :ER-2021-20085
 Operation Mode :802.11ax80
 Test Frequency :5210 MHz
 Test Mode :Tx CH Low
 EUT Pol :H Plane

Test Site :SAC III Chamber
 Test Date :2021-03-05
 Temp./Humi. :21.8/63
 Antenna Pol. :VERTICAL
 Engineer :Ricky

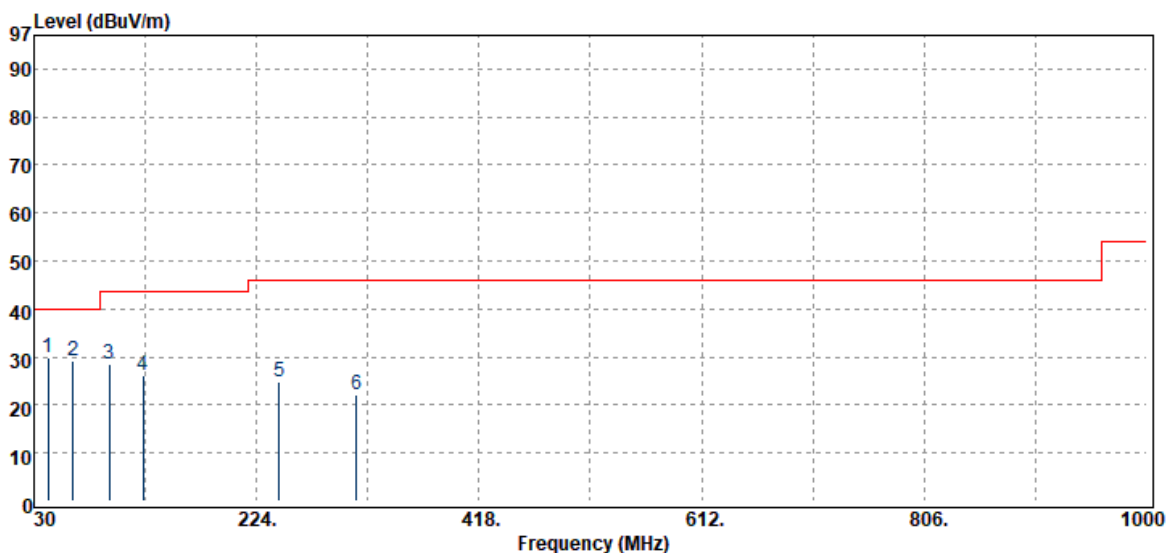

| Freq. MHz | Detector Mode PK/QP/AV | Spectrum Reading Level dBuV | Factor dB | Actual FS dBuV/m | Limit @3m dBuV/m | Margin dB |
|--------------|------------------------------|-----------------------------------|--------------|------------------------|------------------------|--------------|
| 42.61 | Peak | 38.71 | -8.72 | 29.99 | 40.00 | -10.01 |
| 63.95 | Peak | 38.65 | -9.42 | 29.23 | 40.00 | -10.77 |
| 95.96 | Peak | 42.48 | -13.99 | 28.49 | 43.50 | -15.01 |
| 125.06 | Peak | 35.64 | -9.47 | 26.17 | 43.50 | -17.33 |
| 243.40 | Peak | 33.75 | -9.00 | 24.75 | 46.00 | -21.25 |
| 311.30 | Peak | 28.70 | -6.41 | 22.29 | 46.00 | -23.71 |

Unless otherwise stated the results shown in this test report refer only to the sample(s) tested and such sample(s) are retained for 90 days only.

除非另有說明，此報告結果僅對測試之樣品負責，同時此樣品僅保留90天。本報告未經本公司書面許可，不可部份複製。

This document is issued by the Company subject to its General Conditions of Service printed overleaf, available on request or accessible at <http://www.sgs.com.tw/Terms-and-Conditions> and for electronic format documents, subject to Terms and Conditions for Electronic Documents at <http://www.sgs.com.tw/Terms-and-Conditions>. Attention is drawn to the limitation of liability, indemnification and jurisdiction issues defined therein. Any holder of this document is advised that information contained hereon reflects the Company's findings at the time of its intervention only and within the limits of Client's instructions, if any. The Company's sole responsibility is to its Client and this document does not exonerate parties to a transaction from exercising all their rights and obligations under the transaction documents. This document cannot be reproduced except in full, without prior written approval of the Company. Any unauthorized alteration, forgery or falsification of the content or appearance of this document is unlawful and offenders may be prosecuted to the fullest extent of the law.

Report Number :ER-2021-20085
 Operation Mode :802.11ax80
 Test Frequency :5210 MHz
 Test Mode :Tx CH Low
 EUT Pol :H Plane

Test Site :SAC III Chamber
 Test Date :2021-03-05
 Temp./Humi. :21.8/63
 Antenna Pol. :HORIZONTAL
 Engineer :Ricky

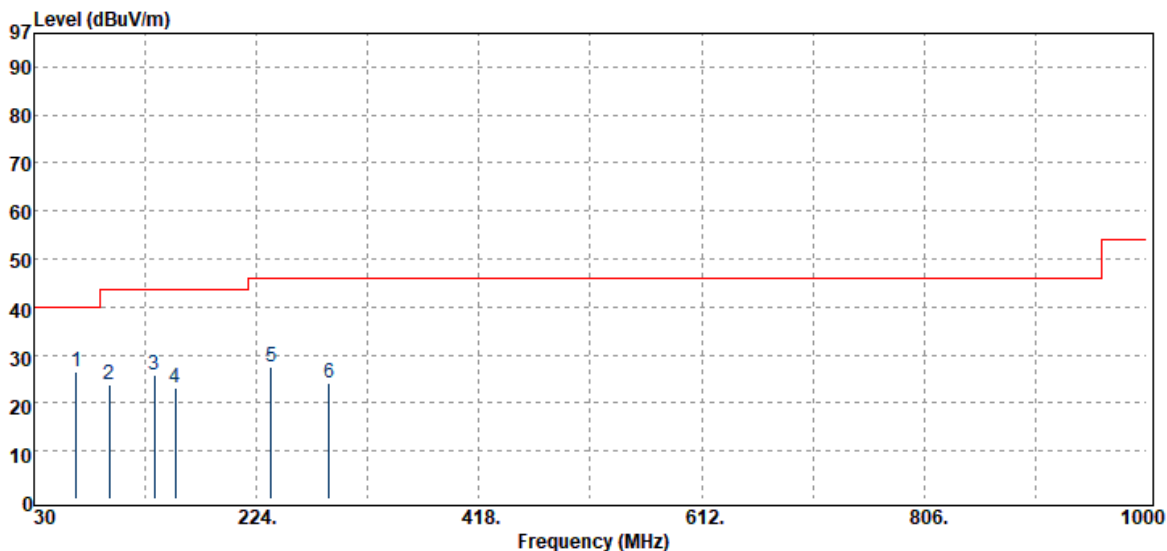

| Freq. MHz | Detector Mode PK/QP/AV | Spectrum Reading Level dBμV | Factor dB | Actual FS dBμV/m | Limit @3m dBμV/m | Margin dB |
|--------------|------------------------------|-----------------------------------|--------------|------------------------|------------------------|--------------|
| 66.86 | Peak | 36.56 | -9.98 | 26.58 | 40.00 | -13.42 |
| 95.96 | Peak | 37.67 | -13.99 | 23.68 | 43.50 | -19.82 |
| 134.76 | Peak | 34.58 | -8.62 | 25.96 | 43.50 | -17.54 |
| 153.19 | Peak | 31.24 | -7.93 | 23.31 | 43.50 | -20.19 |
| 236.61 | Peak | 36.62 | -9.23 | 27.39 | 46.00 | -18.61 |
| 287.05 | Peak | 31.03 | -6.97 | 24.06 | 46.00 | -21.94 |

Unless otherwise stated the results shown in this test report refer only to the sample(s) tested and such sample(s) are retained for 90 days only.

除非另有說明，此報告結果僅對測試之樣品負責，同時此樣品僅保留90天。本報告未經本公司書面許可，不可部份複製。

This document is issued by the Company subject to its General Conditions of Service printed overleaf, available on request or accessible at <http://www.sgs.com.tw/Terms-and-Conditions> and for electronic format documents, subject to Terms and Conditions for Electronic Documents at <http://www.sgs.com.tw/Terms-and-Conditions>. Attention is drawn to the limitation of liability, indemnification and jurisdiction issues defined therein. Any holder of this document is advised that information contained hereon reflects the Company's findings at the time of its intervention only and within the limits of Client's instructions, if any. The Company's sole responsibility is to its Client and this document does not exonerate parties to a transaction from exercising all their rights and obligations under the transaction documents. This document cannot be reproduced except in full, without prior written approval of the Company. Any unauthorized alteration, forgery or falsification of the content or appearance of this document is unlawful and offenders may be prosecuted to the fullest extent of the law.

Report Number :ER-2021-20085
 Operation Mode :802.11ax80
 Test Frequency :5290 MHz
 Test Mode :Tx CH Low
 EUT Pol :H Plane

Test Site :SAC III Chamber
 Test Date :2021-03-05
 Temp./Humi. :21.8/63
 Antenna Pol. :VERTICAL
 Engineer :Ricky

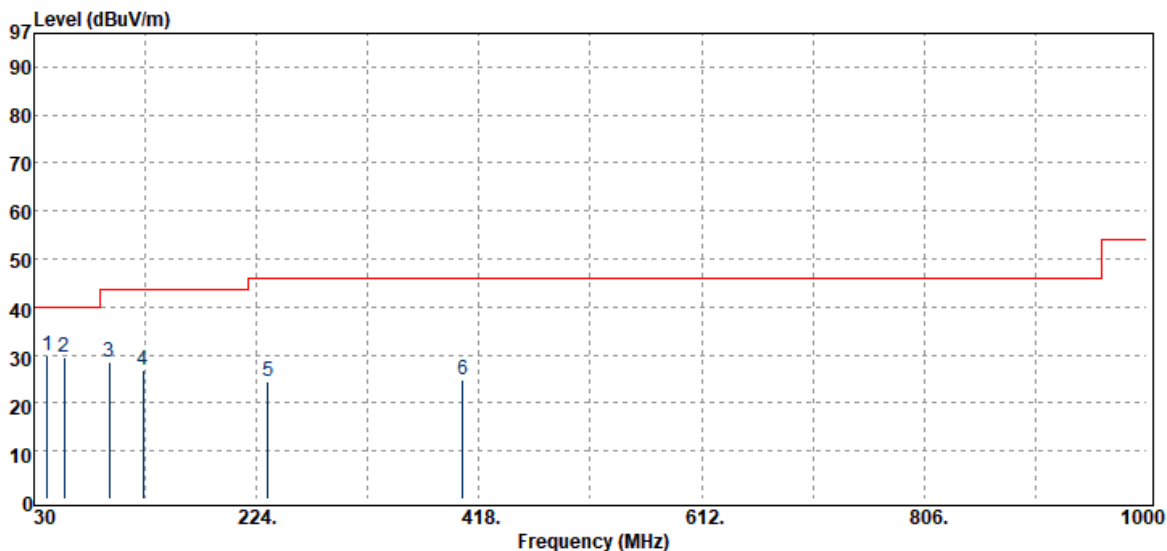

| Freq. MHz | Detector Mode PK/QP/AV | Spectrum Reading Level dB μ V | Factor dB | Actual FS dB μ V/m | Limit @3m dB μ V/m | Margin dB |
|--------------|------------------------------|---|--------------|------------------------------|------------------------------|--------------|
| 41.64 | Peak | 38.90 | -8.90 | 30.00 | 40.00 | -10.00 |
| 56.19 | Peak | 38.40 | -9.01 | 29.39 | 40.00 | -10.61 |
| 95.96 | Peak | 42.64 | -13.99 | 28.65 | 43.50 | -14.85 |
| 125.06 | Peak | 36.25 | -9.47 | 26.78 | 43.50 | -16.72 |
| 233.70 | Peak | 33.89 | -9.42 | 24.47 | 46.00 | -21.53 |
| 403.45 | Peak | 29.78 | -4.89 | 24.89 | 46.00 | -21.11 |

Unless otherwise stated the results shown in this test report refer only to the sample(s) tested and such sample(s) are retained for 90 days only.

除非另有說明，此報告結果僅對測試之樣品負責，同時此樣品僅保留90天。本報告未經本公司書面許可，不可部份複製。

This document is issued by the Company subject to its General Conditions of Service printed overleaf, available on request or accessible at <http://www.sgs.com.tw/Terms-and-Conditions> and for electronic format documents, subject to Terms and Conditions for Electronic Documents at <http://www.sgs.com.tw/Terms-and-Conditions>. Attention is drawn to the limitation of liability, indemnification and jurisdiction issues defined therein. Any holder of this document is advised that information contained hereon reflects the Company's findings at the time of its intervention only and within the limits of Client's instructions, if any. The Company's sole responsibility is to its Client and this document does not exonerate parties to a transaction from exercising all their rights and obligations under the transaction documents. This document cannot be reproduced except in full, without prior written approval of the Company. Any unauthorized alteration, forgery or falsification of the content or appearance of this document is unlawful and offenders may be prosecuted to the fullest extent of the law.

Report Number :ER-2021-20085
 Operation Mode :802.11ax80
 Test Frequency :5290 MHz
 Test Mode :Tx CH Low
 EUT Pol :H Plane

Test Site :SAC III Chamber
 Test Date :2021-03-05
 Temp./Humi. :21.8/63
 Antenna Pol. :HORIZONTAL
 Engineer :Ricky

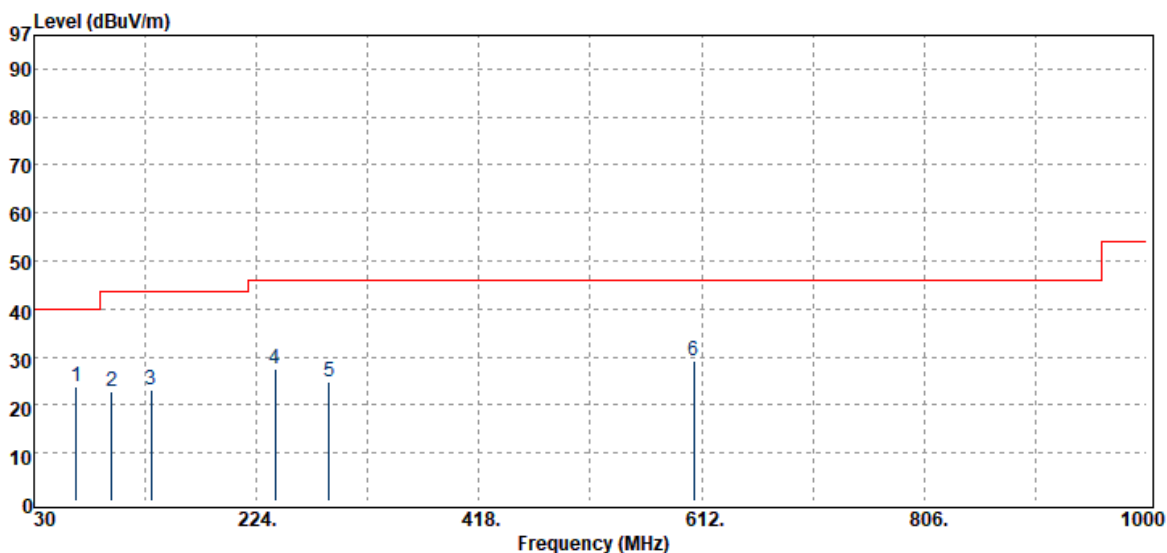

| Freq. MHz | Detector Mode PK/QP/AV | Spectrum Reading Level dB μ V | Factor dB | Actual FS dB μ V/m | Limit @3m dB μ V/m | Margin dB |
|--------------|------------------------------|---|--------------|------------------------------|------------------------------|--------------|
| 66.86 | Peak | 33.66 | -9.98 | 23.68 | 40.00 | -16.32 |
| 97.90 | Peak | 36.31 | -13.48 | 22.83 | 43.50 | -20.67 |
| 131.85 | Peak | 32.12 | -8.81 | 23.31 | 43.50 | -20.19 |
| 240.49 | Peak | 36.62 | -9.04 | 27.58 | 46.00 | -18.42 |
| 287.05 | Peak | 31.65 | -6.97 | 24.68 | 46.00 | -21.32 |
| 605.21 | Peak | 29.20 | -0.16 | 29.04 | 46.00 | -16.96 |

Unless otherwise stated the results shown in this test report refer only to the sample(s) tested and such sample(s) are retained for 90 days only.

除非另有說明，此報告結果僅對測試之樣品負責，同時此樣品僅保留90天。本報告未經本公司書面許可，不可部份複製。

This document is issued by the Company subject to its General Conditions of Service printed overleaf, available on request or accessible at <http://www.sgs.com.tw/Terms-and-Conditions> and for electronic format documents, subject to Terms and Conditions for Electronic Documents at <http://www.sgs.com.tw/Terms-and-Conditions>. Attention is drawn to the limitation of liability, indemnification and jurisdiction issues defined therein. Any holder of this document is advised that information contained hereon reflects the Company's findings at the time of its intervention only and within the limits of Client's instructions, if any. The Company's sole responsibility is to its Client and this document does not exonerate parties to a transaction from exercising all their rights and obligations under the transaction documents. This document cannot be reproduced except in full, without prior written approval of the Company. Any unauthorized alteration, forgery or falsification of the content or appearance of this document is unlawful and offenders may be prosecuted to the fullest extent of the law.

Report Number :ER-2021-20085
 Operation Mode :802.11ax80
 Test Frequency :5610 MHz
 Test Mode :Tx CH Mid
 EUT Pol :H Plane

Test Site :SAC III Chamber
 Test Date :2021-03-05
 Temp./Humi. :21.8/63
 Antenna Pol. :VERTICAL
 Engineer :Ricky

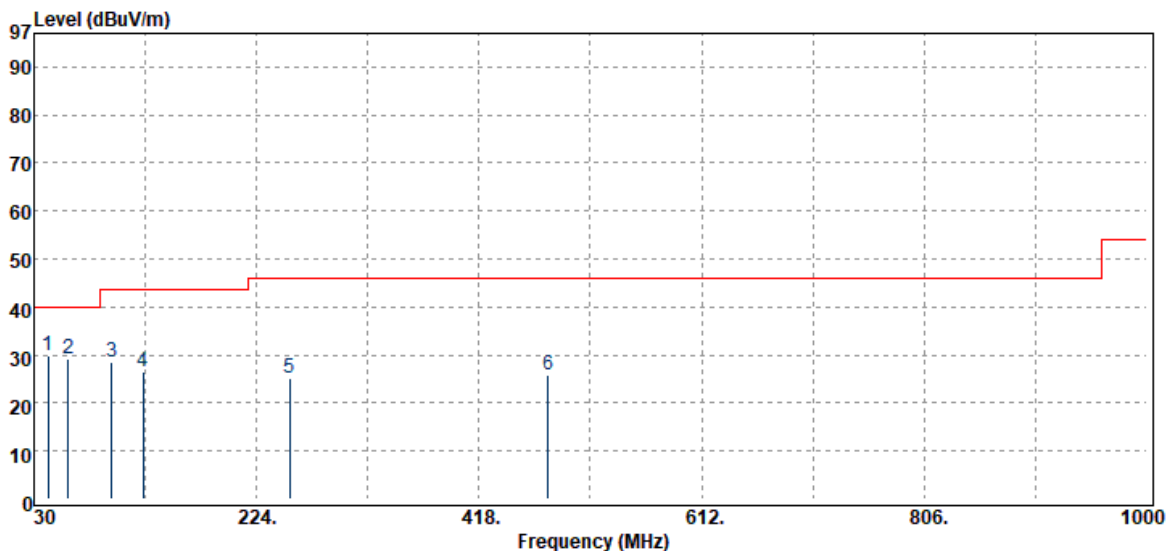

| Freq. MHz | Detector Mode PK/QP/AV | Spectrum Reading Level dB μ V | Factor dB | Actual FS dB μ V/m | Limit @3m dB μ V/m | Margin dB |
|--------------|------------------------------|---|--------------|------------------------------|------------------------------|--------------|
| 42.61 | Peak | 38.54 | -8.72 | 29.82 | 40.00 | -10.18 |
| 60.07 | Peak | 38.25 | -9.08 | 29.17 | 40.00 | -10.83 |
| 97.90 | Peak | 41.93 | -13.48 | 28.45 | 43.50 | -15.05 |
| 125.06 | Peak | 36.06 | -9.47 | 26.59 | 43.50 | -16.91 |
| 253.10 | Peak | 33.75 | -8.59 | 25.16 | 46.00 | -20.84 |
| 478.14 | Peak | 29.02 | -3.14 | 25.88 | 46.00 | -20.12 |

Unless otherwise stated the results shown in this test report refer only to the sample(s) tested and such sample(s) are retained for 90 days only.

除非另有說明，此報告結果僅對測試之樣品負責，同時此樣品僅保留90天。本報告未經本公司書面許可，不可部份複製。

This document is issued by the Company subject to its General Conditions of Service printed overleaf, available on request or accessible at <http://www.sgs.com.tw/Terms-and-Conditions> and for electronic format documents, subject to Terms and Conditions for Electronic Documents at <http://www.sgs.com.tw/Terms-and-Conditions>. Attention is drawn to the limitation of liability, indemnification and jurisdiction issues defined therein. Any holder of this document is advised that information contained hereon reflects the Company's findings at the time of its intervention only and within the limits of Client's instructions, if any. The Company's sole responsibility is to its Client and this document does not exonerate parties to a transaction from exercising all their rights and obligations under the transaction documents. This document cannot be reproduced except in full, without prior written approval of the Company. Any unauthorized alteration, forgery or falsification of the content or appearance of this document is unlawful and offenders may be prosecuted to the fullest extent of the law.

Report Number :ER-2021-20085
 Operation Mode :802.11ax80
 Test Frequency :5610 MHz
 Test Mode :Tx CH Mid
 EUT Pol :H Plane

Test Site :SAC III Chamber
 Test Date :2021-03-05
 Temp./Humi. :21.8/63
 Antenna Pol. :HORIZONTAL
 Engineer :Ricky

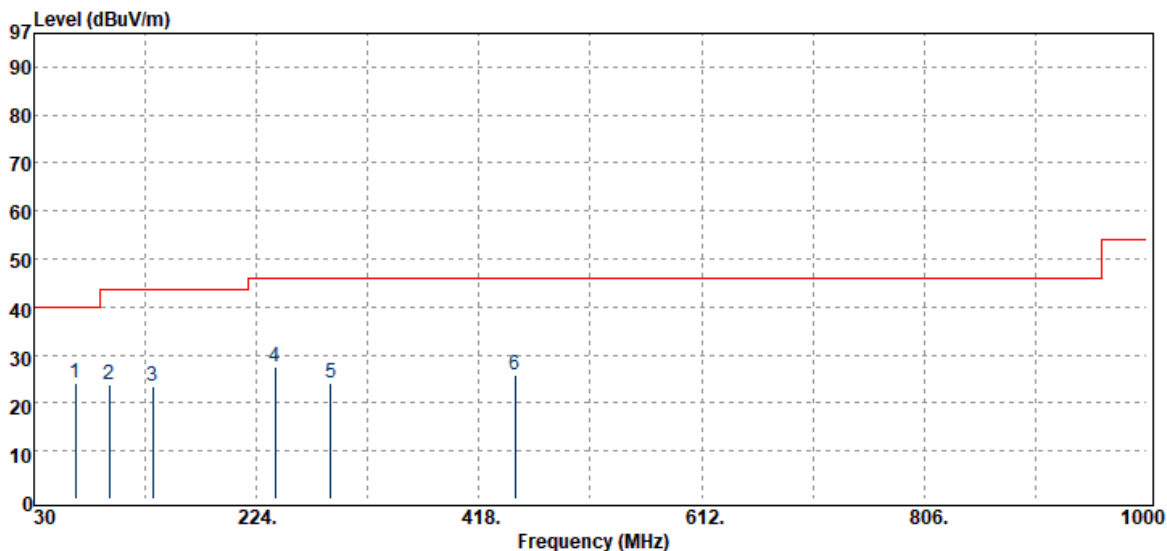

| Freq. MHz | Detector Mode PK/QP/AV | Spectrum Reading Level dB μ V | Factor dB | Actual FS dB μ V/m | Limit @3m dB μ V/m | Margin dB |
|--------------|------------------------------|---|--------------|------------------------------|------------------------------|--------------|
| 65.89 | Peak | 34.29 | -9.96 | 24.33 | 40.00 | -15.67 |
| 95.96 | Peak | 37.68 | -13.99 | 23.69 | 43.50 | -19.81 |
| 133.79 | Peak | 32.42 | -8.80 | 23.62 | 43.50 | -19.88 |
| 240.49 | Peak | 36.73 | -9.04 | 27.69 | 46.00 | -18.31 |
| 288.99 | Peak | 30.94 | -6.88 | 24.06 | 46.00 | -21.94 |
| 449.04 | Peak | 29.02 | -3.30 | 25.72 | 46.00 | -20.28 |

Unless otherwise stated the results shown in this test report refer only to the sample(s) tested and such sample(s) are retained for 90 days only.

除非另有說明，此報告結果僅對測試之樣品負責，同時此樣品僅保留90天。本報告未經本公司書面許可，不可部份複製。

This document is issued by the Company subject to its General Conditions of Service printed overleaf, available on request or accessible at <http://www.sgs.com.tw/Terms-and-Conditions> and for electronic format documents, subject to Terms and Conditions for Electronic Documents at <http://www.sgs.com.tw/Terms-and-Conditions>. Attention is drawn to the limitation of liability, indemnification and jurisdiction issues defined therein. Any holder of this document is advised that information contained hereon reflects the Company's findings at the time of its intervention only and within the limits of Client's instructions, if any. The Company's sole responsibility is to its Client and this document does not exonerate parties to a transaction from exercising all their rights and obligations under the transaction documents. This document cannot be reproduced except in full, without prior written approval of the Company. Any unauthorized alteration, forgery or falsification of the content or appearance of this document is unlawful and offenders may be prosecuted to the fullest extent of the law.

Report Number :ER-2021-20085
 Operation Mode :802.11ax80
 Test Frequency :5775 MHz
 Test Mode :Tx CH Low
 EUT Pol :H Plane

Test Site :SAC III Chamber
 Test Date :2021-03-05
 Temp./Humi. :21.8/63
 Antenna Pol. :VERTICAL
 Engineer :Ricky

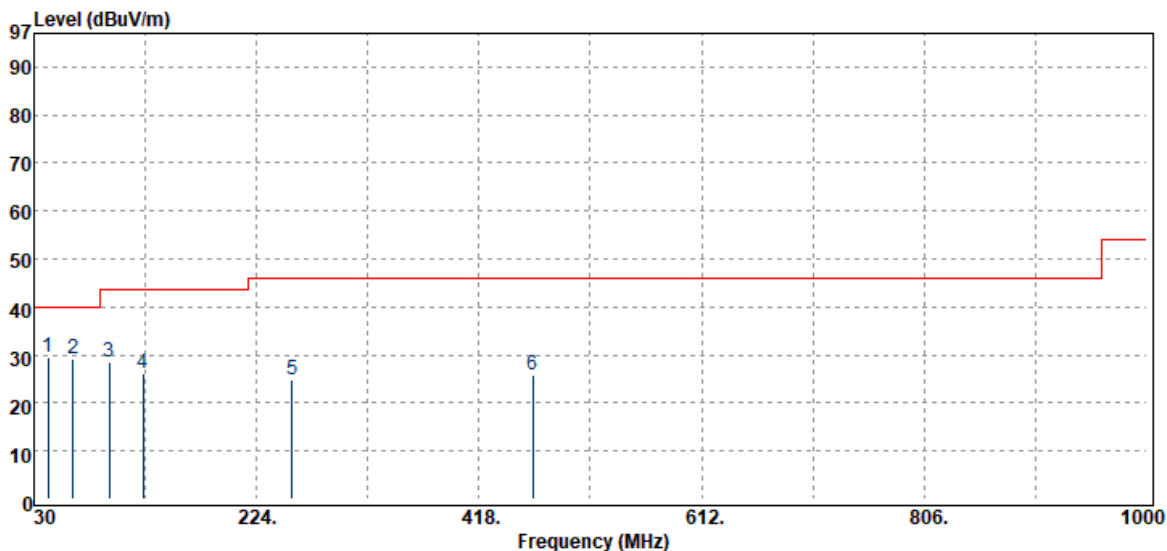

| Freq. MHz | Detector Mode PK/QP/AV | Spectrum Reading Level dB μ V | Factor dB | Actual FS dB μ V/m | Limit @3m dB μ V/m | Margin dB |
|--------------|------------------------------|---|--------------|------------------------------|------------------------------|--------------|
| 42.61 | Peak | 38.41 | -8.72 | 29.69 | 40.00 | -10.31 |
| 63.95 | Peak | 38.75 | -9.42 | 29.33 | 40.00 | -10.67 |
| 95.96 | Peak | 42.45 | -13.99 | 28.46 | 43.50 | -15.04 |
| 125.06 | Peak | 35.73 | -9.47 | 26.26 | 43.50 | -17.24 |
| 255.04 | Peak | 33.23 | -8.49 | 24.74 | 46.00 | -21.26 |
| 464.56 | Peak | 28.94 | -3.00 | 25.94 | 46.00 | -20.06 |

Unless otherwise stated the results shown in this test report refer only to the sample(s) tested and such sample(s) are retained for 90 days only.

除非另有說明，此報告結果僅對測試之樣品負責，同時此樣品僅保留90天。本報告未經本公司書面許可，不可部份複製。

This document is issued by the Company subject to its General Conditions of Service printed overleaf, available on request or accessible at <http://www.sgs.com.tw/Terms-and-Conditions> and for electronic format documents, subject to Terms and Conditions for Electronic Documents at <http://www.sgs.com.tw/Terms-and-Conditions>. Attention is drawn to the limitation of liability, indemnification and jurisdiction issues defined therein. Any holder of this document is advised that information contained hereon reflects the Company's findings at the time of its intervention only and within the limits of Client's instructions, if any. The Company's sole responsibility is to its Client and this document does not exonerate parties to a transaction from exercising all their rights and obligations under the transaction documents. This document cannot be reproduced except in full, without prior written approval of the Company. Any unauthorized alteration, forgery or falsification of the content or appearance of this document is unlawful and offenders may be prosecuted to the fullest extent of the law.

Report Number :ER-2021-20085
 Operation Mode :802.11ax80
 Test Frequency :5775 MHz
 Test Mode :Tx CH Low
 EUT Pol :H Plane

Test Site :SAC III Chamber
 Test Date :2021-03-05
 Temp./Humi. :21.8/63
 Antenna Pol. :HORIZONTAL
 Engineer :Ricky

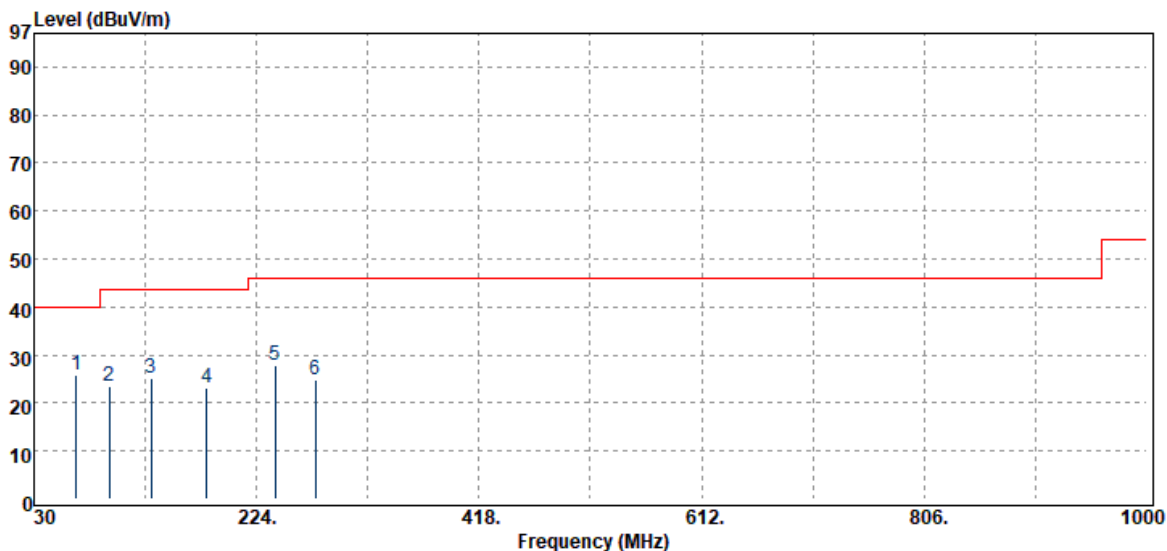

| Freq. MHz | Detector Mode PK/QP/AV | Spectrum Reading Level dB μ V | Factor dB | Actual FS dB μ V/m | Limit @3m dB μ V/m | Margin dB |
|--------------|------------------------------|---|--------------|------------------------------|------------------------------|--------------|
| 66.86 | Peak | 35.99 | -9.98 | 26.01 | 40.00 | -13.99 |
| 95.96 | Peak | 37.54 | -13.99 | 23.55 | 43.50 | -19.95 |
| 131.85 | Peak | 33.86 | -8.81 | 25.05 | 43.50 | -18.45 |
| 180.35 | Peak | 32.53 | -9.26 | 23.27 | 43.50 | -20.23 |
| 240.49 | Peak | 36.87 | -9.04 | 27.83 | 46.00 | -18.17 |
| 275.41 | Peak | 32.20 | -7.41 | 24.79 | 46.00 | -21.21 |

Unless otherwise stated the results shown in this test report refer only to the sample(s) tested and such sample(s) are retained for 90 days only.

除非另有說明，此報告結果僅對測試之樣品負責，同時此樣品僅保留90天。本報告未經本公司書面許可，不可部份複製。

This document is issued by the Company subject to its General Conditions of Service printed overleaf, available on request or accessible at <http://www.sgs.com.tw/Terms-and-Conditions> and for electronic format documents, subject to Terms and Conditions for Electronic Documents at <http://www.sgs.com.tw/Terms-and-Conditions>. Attention is drawn to the limitation of liability, indemnification and jurisdiction issues defined therein. Any holder of this document is advised that information contained hereon reflects the Company's findings at the time of its intervention only and within the limits of Client's instructions, if any. The Company's sole responsibility is to its Client and this document does not exonerate parties to a transaction from exercising all their rights and obligations under the transaction documents. This document cannot be reproduced except in full, without prior written approval of the Company. Any unauthorized alteration, forgery or falsification of the content or appearance of this document is unlawful and offenders may be prosecuted to the fullest extent of the law.

11.8.2 Above 1GHz Worst-Case Data:

| | | | |
|----------------|----------------|--------------|------------------|
| Report Number | :ER-2021-20085 | Test Site | :SAC III Chamber |
| Operation Mode | :802.11a | Test Date | :2021-03-04 |
| Test Frequency | :5180 MHz | Temp./Humi. | :21.3/62 |
| Test Mode | :Tx CH Low | Antenna Pol. | :VERTICAL |
| EUT Pol | :H Plane | Engineer | :Ricky |

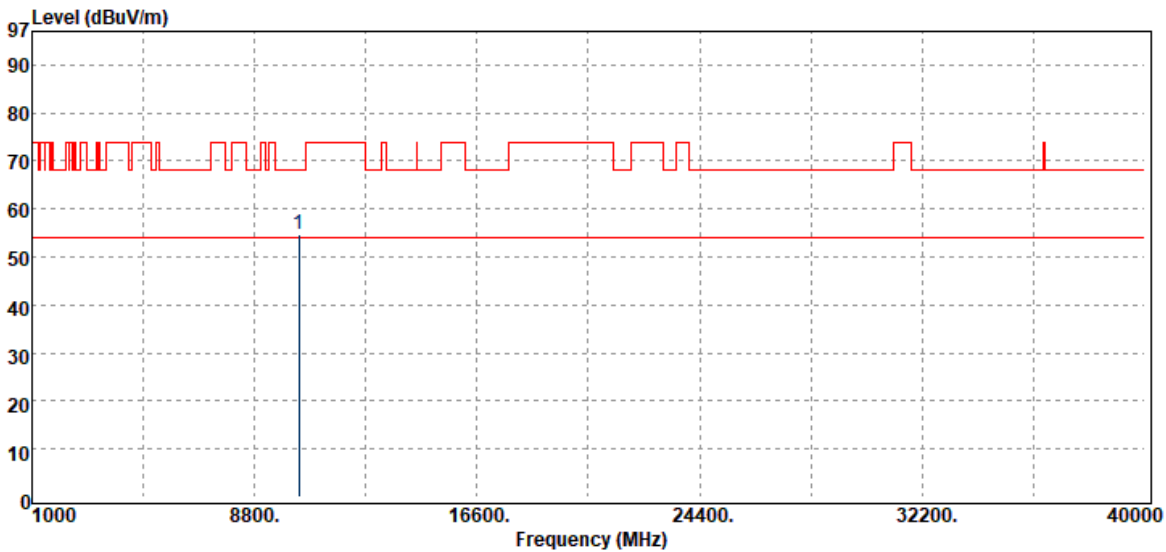

| Freq. MHz | Detector Mode PK/QP/AV | Spectrum Reading Level dB μ V | Factor dB | Actual FS dB μ V/m | Limit @3m dB μ V/m | Margin dB |
|--------------|------------------------------|---|--------------|------------------------------|------------------------------|--------------|
| 10360.00 | Peak | 34.75 | 19.87 | 54.62 | 68.20 | -13.58 |

Unless otherwise stated the results shown in this test report refer only to the sample(s) tested and such sample(s) are retained for 90 days only.

除非另有說明，此報告結果僅對測試之樣品負責，同時此樣品僅保留90天。本報告未經本公司書面許可，不可部份複製。
 This document is issued by the Company subject to its General Conditions of Service printed overleaf, available on request or accessible at <http://www.sgs.com.tw/Terms-and-Conditions> and for electronic format documents, subject to Terms and Conditions for Electronic Documents at <http://www.sgs.com.tw/Terms-and-Conditions>. Attention is drawn to the limitation of liability, indemnification and jurisdiction issues defined therein. Any holder of this document is advised that information contained hereon reflects the Company's findings at the time of its intervention only and within the limits of Client's instructions, if any. The Company's sole responsibility is to its Client and this document does not exonerate parties to a transaction from exercising all their rights and obligations under the transaction documents. This document cannot be reproduced except in full, without prior written approval of the Company. Any unauthorized alteration, forgery or falsification of the content or appearance of this document is unlawful and offenders may be prosecuted to the fullest extent of the law.

Report Number :ER-2021-20085
 Operation Mode :802.11a
 Test Frequency :5180 MHz
 Test Mode :Tx CH Low
 EUT Pol :H Plane

Test Site :SAC III Chamber
 Test Date :2021-03-04
 Temp./Humi. :21.3/62
 Antenna Pol. :HORIZONTAL
 Engineer :Ricky

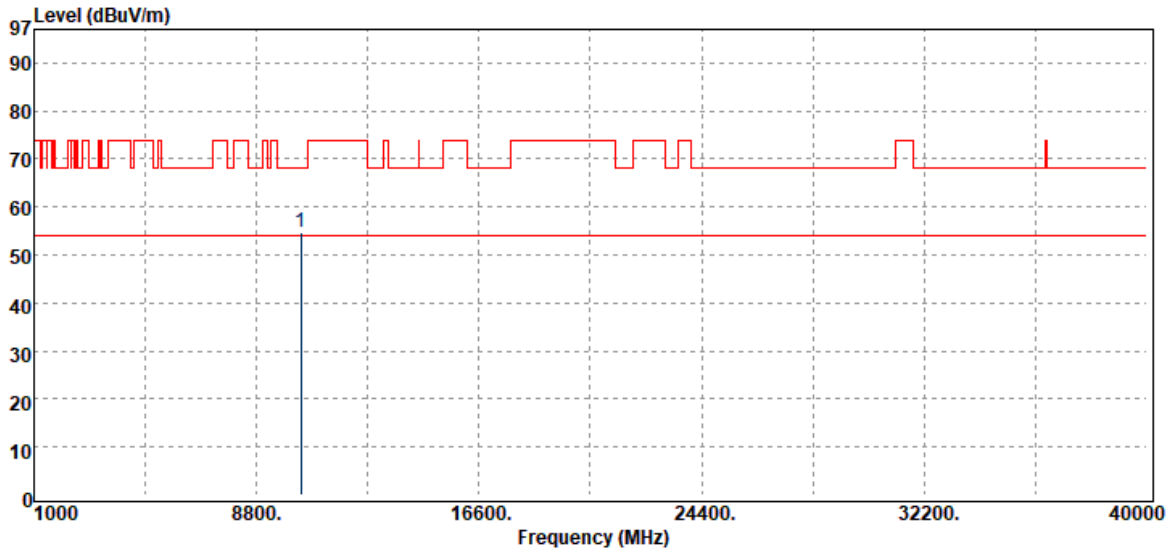

| Freq. MHz | Detector Mode PK/QP/AV | Spectrum Reading Level dB μ V | Factor dB | Actual FS dB μ V/m | Limit @3m dB μ V/m | Margin dB |
|--------------|------------------------------|---|--------------|------------------------------|------------------------------|--------------|
| 10360.00 | Peak | 35.00 | 19.87 | 54.87 | 68.20 | -13.33 |

Unless otherwise stated the results shown in this test report refer only to the sample(s) tested and such sample(s) are retained for 90 days only.

除非另有說明，此報告結果僅對測試之樣品負責，同時此樣品僅保留90天。本報告未經本公司書面許可，不可部份複製。

This document is issued by the Company subject to its General Conditions of Service printed overleaf, available on request or accessible at <http://www.sgs.com.tw/Terms-and-Conditions> and for electronic format documents, subject to Terms and Conditions for Electronic Documents at <http://www.sgs.com.tw/Terms-and-Conditions>. Attention is drawn to the limitation of liability, indemnification and jurisdiction issues defined therein. Any holder of this document is advised that information contained hereon reflects the Company's findings at the time of its intervention only and within the limits of Client's instructions, if any. The Company's sole responsibility is to its Client and this document does not exonerate parties to a transaction from exercising all their rights and obligations under the transaction documents. This document cannot be reproduced except in full, without prior written approval of the Company. Any unauthorized alteration, forgery or falsification of the content or appearance of this document is unlawful and offenders may be prosecuted to the fullest extent of the law.

Report Number :ER-2021-20085
 Operation Mode :802.11a
 Test Frequency :5220 MHz
 Test Mode :Tx CH Mid
 EUT Pol :H Plane

Test Site :SAC III Chamber
 Test Date :2021-03-04
 Temp./Humi. :21.3/62
 Antenna Pol. :VERTICAL
 Engineer :Ricky

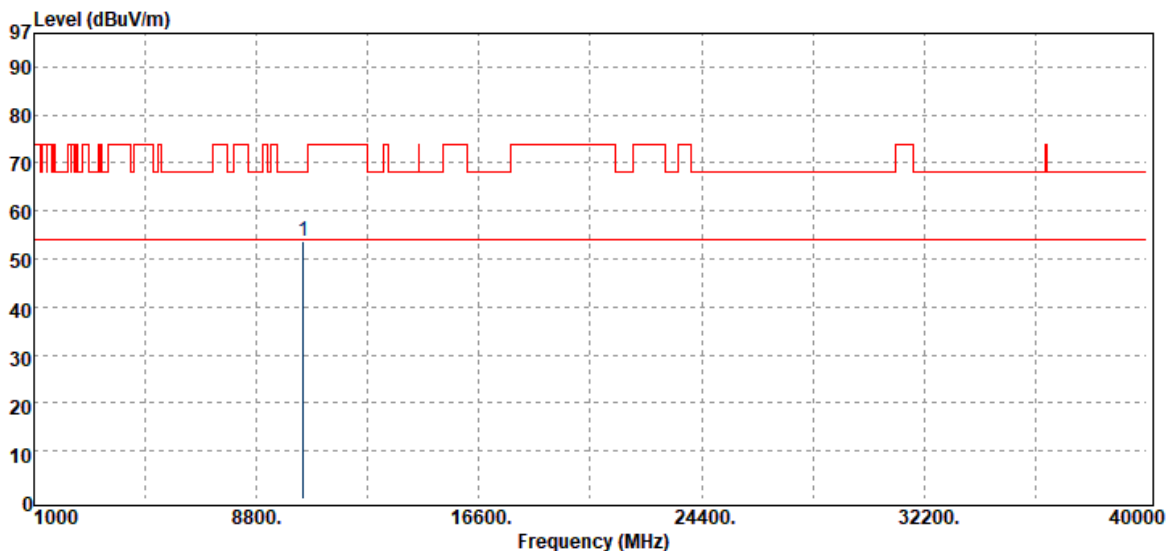

| Freq. MHz | Detector Mode PK/QP/AV | Spectrum Reading Level dB μ V | Factor dB | Actual FS dB μ V/m | Limit @3m dB μ V/m | Margin dB |
|--------------|------------------------------|---|--------------|------------------------------|------------------------------|--------------|
| 10440.00 | Peak | 34.41 | 19.15 | 53.56 | 68.20 | -14.64 |

Unless otherwise stated the results shown in this test report refer only to the sample(s) tested and such sample(s) are retained for 90 days only.

除非另有說明，此報告結果僅對測試之樣品負責，同時此樣品僅保留90天。本報告未經本公司書面許可，不可部份複製。

This document is issued by the Company subject to its General Conditions of Service printed overleaf, available on request or accessible at <http://www.sgs.com.tw/Terms-and-Conditions> and for electronic format documents, subject to Terms and Conditions for Electronic Documents at <http://www.sgs.com.tw/Terms-and-Conditions>. Attention is drawn to the limitation of liability, indemnification and jurisdiction issues defined therein. Any holder of this document is advised that information contained hereon reflects the Company's findings at the time of its intervention only and within the limits of Client's instructions, if any. The Company's sole responsibility is to its Client and this document does not exonerate parties to a transaction from exercising all their rights and obligations under the transaction documents. This document cannot be reproduced except in full, without prior written approval of the Company. Any unauthorized alteration, forgery or falsification of the content or appearance of this document is unlawful and offenders may be prosecuted to the fullest extent of the law.

Report Number :ER-2021-20085
 Operation Mode :802.11a
 Test Frequency :5220 MHz
 Test Mode :Tx CH Mid
 EUT Pol :H Plane

Test Site :SAC III Chamber
 Test Date :2021-03-04
 Temp./Humi. :21.3/62
 Antenna Pol. :HORIZONTAL
 Engineer :Ricky



| Freq. MHz | Detector Mode PK/QP/AV | Spectrum Reading Level dB μ V | Factor dB | Actual FS dB μ V/m | Limit @3m dB μ V/m | Margin dB |
|--------------|------------------------------|---|--------------|------------------------------|------------------------------|--------------|
| 10440.00 | Peak | 34.62 | 19.15 | 53.77 | 68.20 | -14.43 |

Unless otherwise stated the results shown in this test report refer only to the sample(s) tested and such sample(s) are retained for 90 days only.

除非另有說明，此報告結果僅對測試之樣品負責，同時此樣品僅保留90天。本報告未經本公司書面許可，不可部份複製。

This document is issued by the Company subject to its General Conditions of Service printed overleaf, available on request or accessible at <http://www.sgs.com.tw/Terms-and-Conditions> and for electronic format documents, subject to Terms and Conditions for Electronic Documents at <http://www.sgs.com.tw/Terms-and-Conditions>. Attention is drawn to the limitation of liability, indemnification and jurisdiction issues defined therein. Any holder of this document is advised that information contained hereon reflects the Company's findings at the time of its intervention only and within the limits of Client's instructions, if any. The Company's sole responsibility is to its Client and this document does not exonerate parties to a transaction from exercising all their rights and obligations under the transaction documents. This document cannot be reproduced except in full, without prior written approval of the Company. Any unauthorized alteration, forgery or falsification of the content or appearance of this document is unlawful and offenders may be prosecuted to the fullest extent of the law.

Report Number :ER-2021-20085
 Operation Mode :802.11a
 Test Frequency :5240 MHz
 Test Mode :Tx CH High
 EUT Pol :H Plane

Test Site :SAC III Chamber
 Test Date :2021-03-04
 Temp./Humi. :21.3/62
 Antenna Pol. :VERTICAL
 Engineer :Ricky

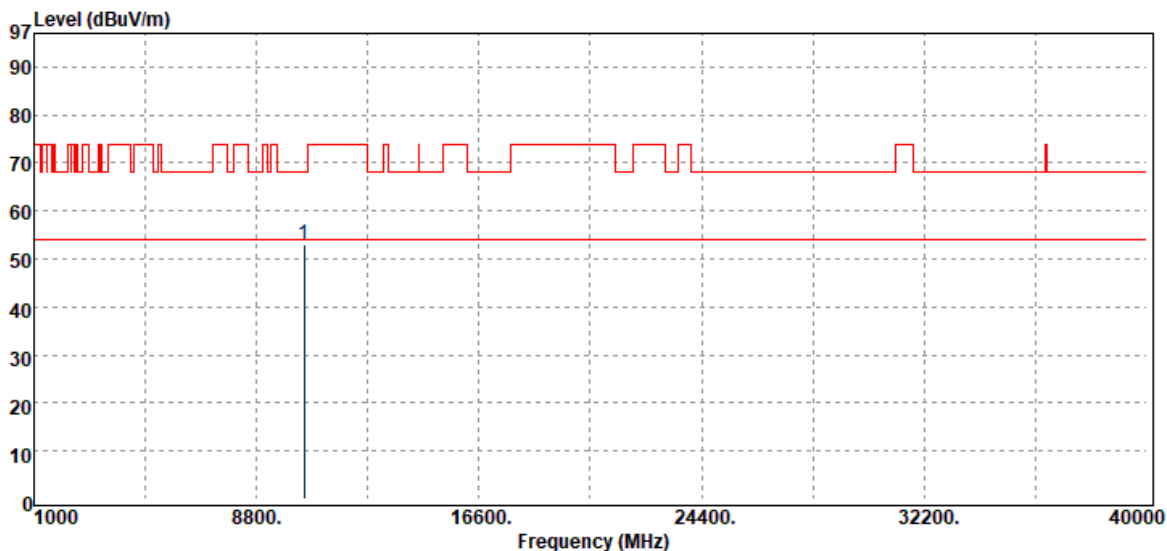

| Freq. MHz | Detector Mode PK/QP/AV | Spectrum Reading Level dB μ V | Factor dB | Actual FS dB μ V/m | Limit @3m dB μ V/m | Margin dB |
|--------------|------------------------------|---|--------------|------------------------------|------------------------------|--------------|
| 10480.00 | Peak | 33.43 | 19.56 | 52.99 | 68.20 | -15.21 |

Unless otherwise stated the results shown in this test report refer only to the sample(s) tested and such sample(s) are retained for 90 days only.

除非另有說明，此報告結果僅對測試之樣品負責，同時此樣品僅保留90天。本報告未經本公司書面許可，不可部份複製。

This document is issued by the Company subject to its General Conditions of Service printed overleaf, available on request or accessible at <http://www.sgs.com.tw/Terms-and-Conditions> and for electronic format documents, subject to Terms and Conditions for Electronic Documents at <http://www.sgs.com.tw/Terms-and-Conditions>. Attention is drawn to the limitation of liability, indemnification and jurisdiction issues defined therein. Any holder of this document is advised that information contained hereon reflects the Company's findings at the time of its intervention only and within the limits of Client's instructions, if any. The Company's sole responsibility is to its Client and this document does not exonerate parties to a transaction from exercising all their rights and obligations under the transaction documents. This document cannot be reproduced except in full, without prior written approval of the Company. Any unauthorized alteration, forgery or falsification of the content or appearance of this document is unlawful and offenders may be prosecuted to the fullest extent of the law.

| | | | |
|----------------|----------------|--------------|------------------|
| Report Number | :ER-2021-20085 | Test Site | :SAC III Chamber |
| Operation Mode | :802.11a | Test Date | :2021-03-04 |
| Test Frequency | :5240 MHz | Temp./Humi. | :21.3/62 |
| Test Mode | :Tx CH High | Antenna Pol. | :HORIZONTAL |
| EUT Pol | :H Plane | Engineer | :Ricky |

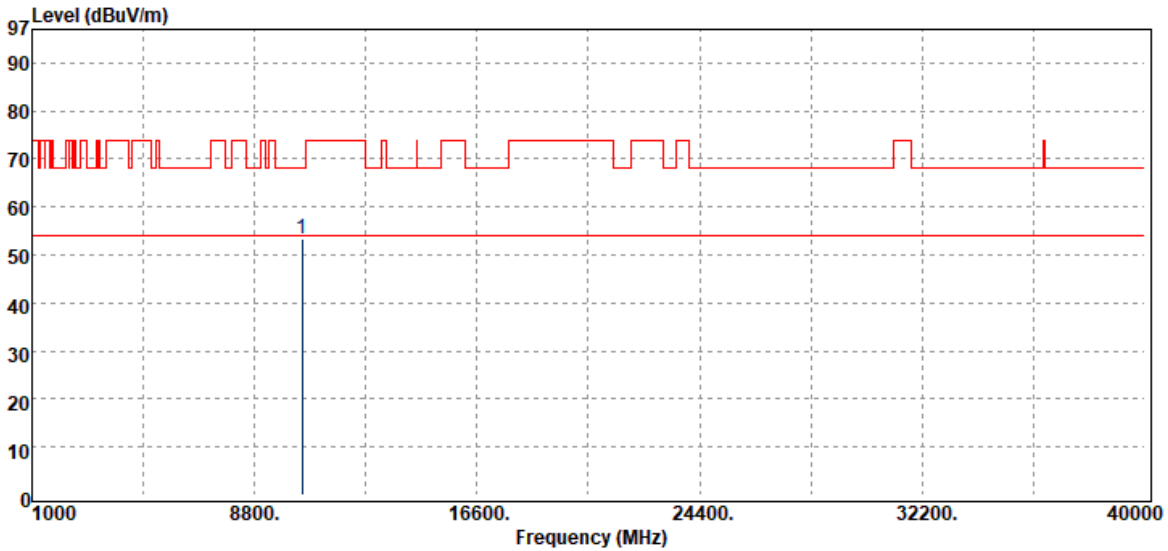

| Freq. MHz | Detector Mode PK/QP/AV | Spectrum Reading Level dB μ V | Factor dB | Actual FS dB μ V/m | Limit @3m dB μ V/m | Margin dB |
|--------------|------------------------------|---|--------------|------------------------------|------------------------------|--------------|
| 10480.00 | Peak | 33.97 | 19.56 | 53.53 | 68.20 | -14.67 |

Unless otherwise stated the results shown in this test report refer only to the sample(s) tested and such sample(s) are retained for 90 days only.

除非另有說明，此報告結果僅對測試之樣品負責，同時此樣品僅保留90天。本報告未經本公司書面許可，不可部份複製。

This document is issued by the Company subject to its General Conditions of Service printed overleaf, available on request or accessible at <http://www.sgs.com.tw/Terms-and-Conditions> and for electronic format documents, subject to Terms and Conditions for Electronic Documents at <http://www.sgs.com.tw/Terms-and-Conditions>. Attention is drawn to the limitation of liability, indemnification and jurisdiction issues defined therein. Any holder of this document is advised that information contained hereon reflects the Company's findings at the time of its intervention only and within the limits of Client's instructions, if any. The Company's sole responsibility is to its Client and this document does not exonerate parties to a transaction from exercising all their rights and obligations under the transaction documents. This document cannot be reproduced except in full, without prior written approval of the Company. Any unauthorized alteration, forgery or falsification of the content or appearance of this document is unlawful and offenders may be prosecuted to the fullest extent of the law.

Report Number :ER-2021-20085
 Operation Mode :802.11a
 Test Frequency :5260 MHz
 Test Mode :Tx CH Low
 EUT Pol :H Plane

Test Site :SAC III Chamber
 Test Date :2021-03-04
 Temp./Humi. :21.3/62
 Antenna Pol. :VERTICAL
 Engineer :Ricky

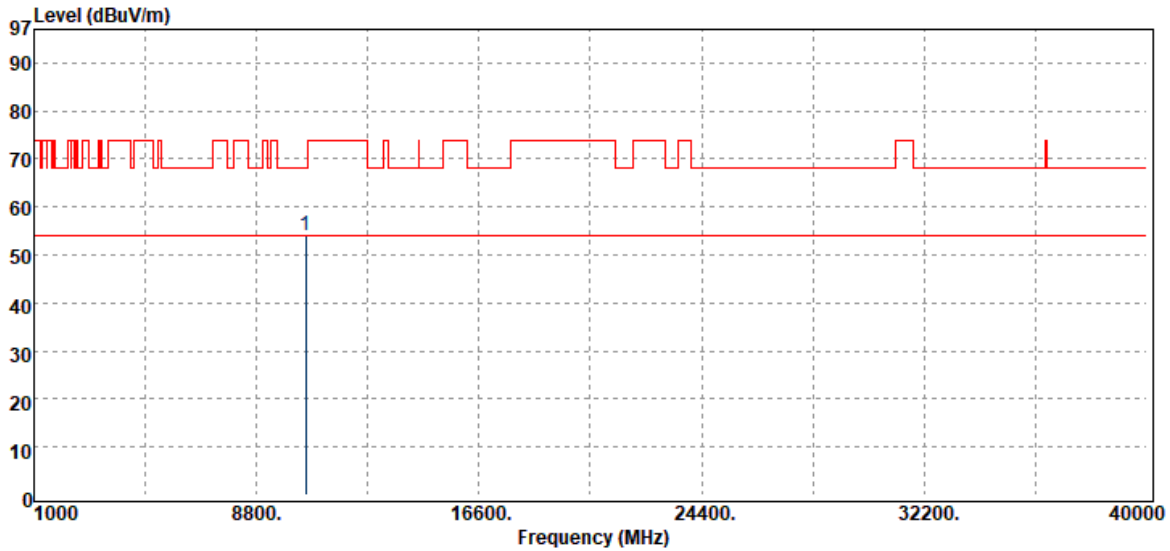

| Freq. MHz | Detector Mode PK/QP/AV | Spectrum Reading Level dB μ V | Factor dB | Actual FS dB μ V/m | Limit @3m dB μ V/m | Margin dB |
|--------------|------------------------------|---|--------------|------------------------------|------------------------------|--------------|
| 10520.00 | Peak | 34.32 | 19.84 | 54.16 | 68.20 | -14.04 |

Unless otherwise stated the results shown in this test report refer only to the sample(s) tested and such sample(s) are retained for 90 days only.

除非另有說明，此報告結果僅對測試之樣品負責，同時此樣品僅保留90天。本報告未經本公司書面許可，不可部份複製。

This document is issued by the Company subject to its General Conditions of Service printed overleaf, available on request or accessible at <http://www.sgs.com.tw/Terms-and-Conditions> and for electronic format documents, subject to Terms and Conditions for Electronic Documents at <http://www.sgs.com.tw/Terms-and-Conditions>. Attention is drawn to the limitation of liability, indemnification and jurisdiction issues defined therein. Any holder of this document is advised that information contained hereon reflects the Company's findings at the time of its intervention only and within the limits of Client's instructions, if any. The Company's sole responsibility is to its Client and this document does not exonerate parties to a transaction from exercising all their rights and obligations under the transaction documents. This document cannot be reproduced except in full, without prior written approval of the Company. Any unauthorized alteration, forgery or falsification of the content or appearance of this document is unlawful and offenders may be prosecuted to the fullest extent of the law.

Report Number :ER-2021-20085
 Operation Mode :802.11a
 Test Frequency :5260 MHz
 Test Mode :Tx CH Low
 EUT Pol :H Plane

Test Site :SAC III Chamber
 Test Date :2021-03-04
 Temp./Humi. :21.3/62
 Antenna Pol. :HORIZONTAL
 Engineer :Ricky



| Freq. MHz | Detector Mode PK/QP/AV | Spectrum Reading Level dB μ V | Factor dB | Actual FS dB μ V/m | Limit @3m dB μ V/m | Margin dB |
|--------------|------------------------------|---|--------------|------------------------------|------------------------------|--------------|
| 10520.00 | Peak | 33.50 | 19.84 | 53.34 | 68.20 | -14.86 |

Unless otherwise stated the results shown in this test report refer only to the sample(s) tested and such sample(s) are retained for 90 days only.

除非另有說明，此報告結果僅對測試之樣品負責，同時此樣品僅保留90天。本報告未經本公司書面許可，不可部份複製。

This document is issued by the Company subject to its General Conditions of Service printed overleaf, available on request or accessible at <http://www.sgs.com.tw/Terms-and-Conditions> and for electronic format documents, subject to Terms and Conditions for Electronic Documents at <http://www.sgs.com.tw/Terms-and-Conditions>. Attention is drawn to the limitation of liability, indemnification and jurisdiction issues defined therein. Any holder of this document is advised that information contained hereon reflects the Company's findings at the time of its intervention only and within the limits of Client's instructions, if any. The Company's sole responsibility is to its Client and this document does not exonerate parties to a transaction from exercising all their rights and obligations under the transaction documents. This document cannot be reproduced except in full, without prior written approval of the Company. Any unauthorized alteration, forgery or falsification of the content or appearance of this document is unlawful and offenders may be prosecuted to the fullest extent of the law.

Report Number :ER-2021-20085
 Operation Mode :802.11a
 Test Frequency :5300 MHz
 Test Mode :Tx CH Mid
 EUT Pol :H Plane

Test Site :SAC III Chamber
 Test Date :2021-03-04
 Temp./Humi. :21.3/62
 Antenna Pol. :VERTICAL
 Engineer :Ricky

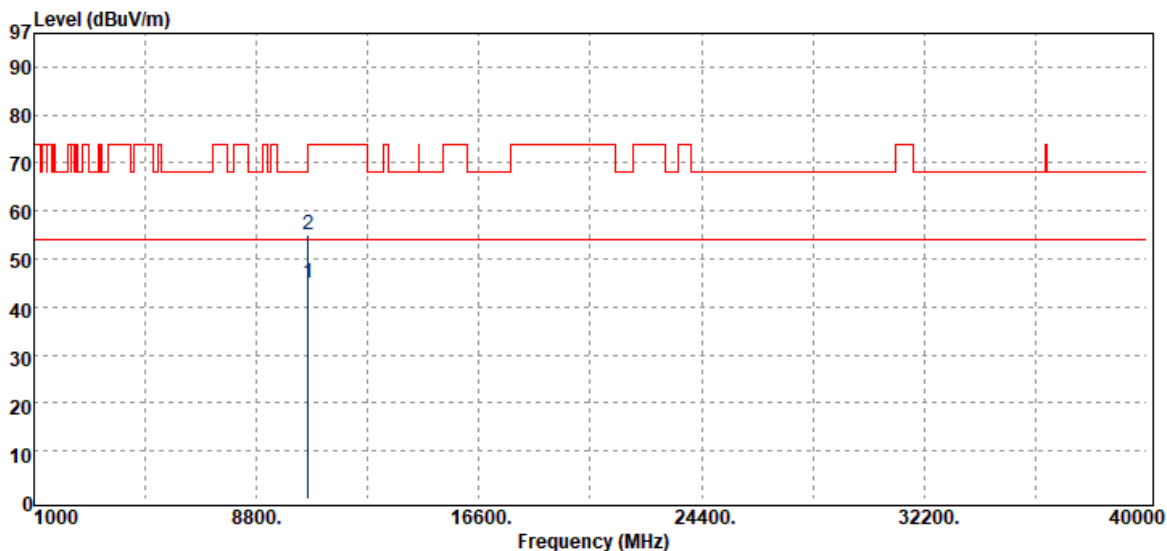

| Freq. MHz | Detector Mode PK/QP/AV | Spectrum Reading Level dB μ V | Factor dB | Actual FS dB μ V/m | Limit @3m dB μ V/m | Margin dB |
|--------------|------------------------------|---|--------------|------------------------------|------------------------------|--------------|
| 10600.00 | Average | 25.19 | 19.86 | 45.05 | 54.00 | -8.95 |
| 10600.00 | Peak | 35.09 | 19.86 | 54.95 | 74.00 | -19.05 |

Unless otherwise stated the results shown in this test report refer only to the sample(s) tested and such sample(s) are retained for 90 days only.

除非另有說明，此報告結果僅對測試之樣品負責，同時此樣品僅保留90天。本報告未經本公司書面許可，不可部份複製。

This document is issued by the Company subject to its General Conditions of Service printed overleaf, available on request or accessible at <http://www.sgs.com.tw/Terms-and-Conditions> and for electronic format documents, subject to Terms and Conditions for Electronic Documents at <http://www.sgs.com.tw/Terms-and-Conditions>. Attention is drawn to the limitation of liability, indemnification and jurisdiction issues defined therein. Any holder of this document is advised that information contained hereon reflects the Company's findings at the time of its intervention only and within the limits of Client's instructions, if any. The Company's sole responsibility is to its Client and this document does not exonerate parties to a transaction from exercising all their rights and obligations under the transaction documents. This document cannot be reproduced except in full, without prior written approval of the Company. Any unauthorized alteration, forgery or falsification of the content or appearance of this document is unlawful and offenders may be prosecuted to the fullest extent of the law.

Report Number :ER-2021-20085
 Operation Mode :802.11a
 Test Frequency :5300 MHz
 Test Mode :Tx CH Mid
 EUT Pol :H Plane

Test Site :SAC III Chamber
 Test Date :2021-03-04
 Temp./Humi. :21.3/62
 Antenna Pol. :HORIZONTAL
 Engineer :Ricky

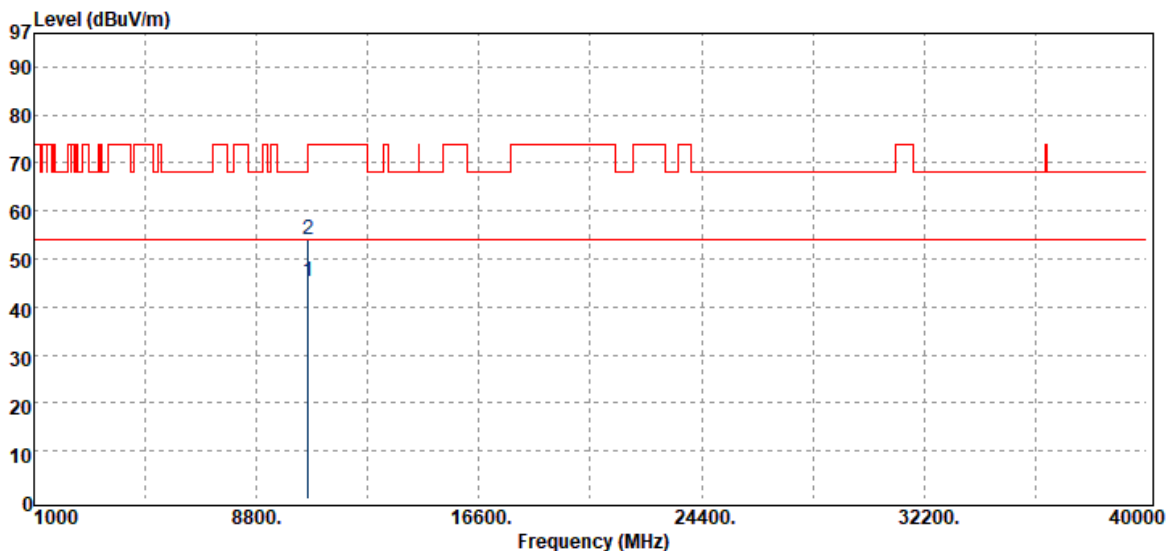

| Freq. MHz | Detector Mode PK/QP/AV | Spectrum Reading Level dB μ V | Factor dB | Actual FS dB μ V/m | Limit @3m dB μ V/m | Margin dB |
|--------------|------------------------------|---|--------------|------------------------------|------------------------------|--------------|
| 10600.00 | Average | 25.29 | 19.86 | 45.15 | 54.00 | -8.85 |
| 10600.00 | Peak | 34.23 | 19.86 | 54.09 | 74.00 | -19.91 |

Unless otherwise stated the results shown in this test report refer only to the sample(s) tested and such sample(s) are retained for 90 days only.

除非另有說明，此報告結果僅對測試之樣品負責，同時此樣品僅保留90天。本報告未經本公司書面許可，不可部份複製。

This document is issued by the Company subject to its General Conditions of Service printed overleaf, available on request or accessible at <http://www.sgs.com.tw/Terms-and-Conditions> and for electronic format documents, subject to Terms and Conditions for Electronic Documents at <http://www.sgs.com.tw/Terms-and-Conditions>. Attention is drawn to the limitation of liability, indemnification and jurisdiction issues defined therein. Any holder of this document is advised that information contained hereon reflects the Company's findings at the time of its intervention only and within the limits of Client's instructions, if any. The Company's sole responsibility is to its Client and this document does not exonerate parties to a transaction from exercising all their rights and obligations under the transaction documents. This document cannot be reproduced except in full, without prior written approval of the Company. Any unauthorized alteration, forgery or falsification of the content or appearance of this document is unlawful and offenders may be prosecuted to the fullest extent of the law.

Report Number :ER-2021-20085
 Operation Mode :802.11a
 Test Frequency :5320 MHz
 Test Mode :Tx CH High
 EUT Pol :H Plane

Test Site :SAC III Chamber
 Test Date :2021-03-04
 Temp./Humi. :21.3/62
 Antenna Pol. :VERTICAL
 Engineer :Ricky

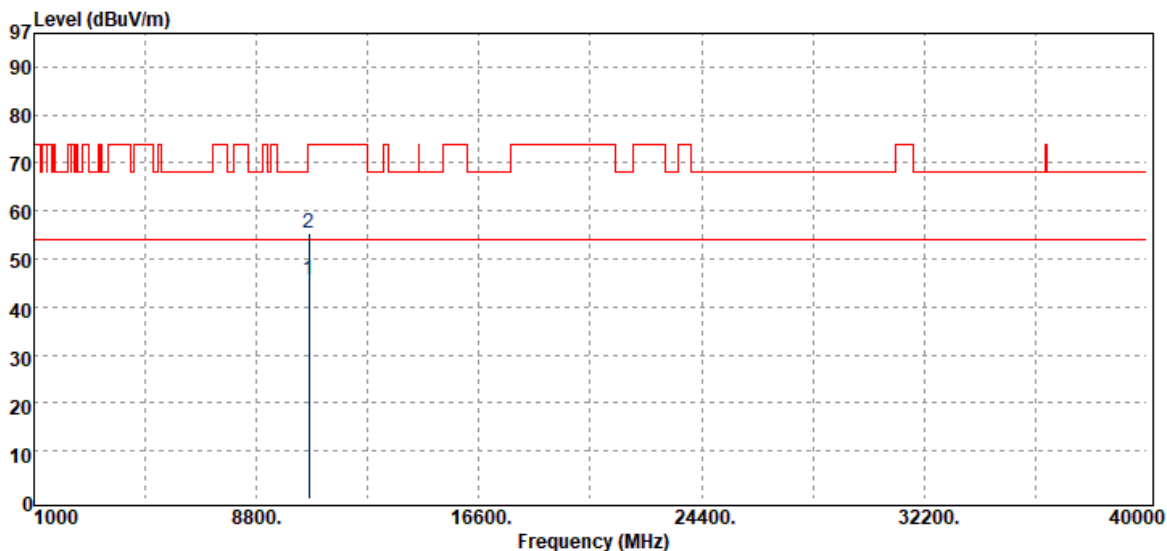

| Freq. MHz | Detector Mode PK/QP/AV | Spectrum Reading Level dB μ V | Factor dB | Actual FS dB μ V/m | Limit @3m dB μ V/m | Margin dB |
|--------------|------------------------------|---|--------------|------------------------------|------------------------------|--------------|
| 10640.00 | Average | 25.22 | 20.37 | 45.59 | 54.00 | -8.41 |
| 10640.00 | Peak | 35.12 | 20.37 | 55.49 | 74.00 | -18.51 |

Unless otherwise stated the results shown in this test report refer only to the sample(s) tested and such sample(s) are retained for 90 days only.

除非另有說明，此報告結果僅對測試之樣品負責，同時此樣品僅保留90天。本報告未經本公司書面許可，不可部份複製。

This document is issued by the Company subject to its General Conditions of Service printed overleaf, available on request or accessible at <http://www.sgs.com.tw/Terms-and-Conditions> and for electronic format documents, subject to Terms and Conditions for Electronic Documents at <http://www.sgs.com.tw/Terms-and-Conditions>. Attention is drawn to the limitation of liability, indemnification and jurisdiction issues defined therein. Any holder of this document is advised that information contained hereon reflects the Company's findings at the time of its intervention only and within the limits of Client's instructions, if any. The Company's sole responsibility is to its Client and this document does not exonerate parties to a transaction from exercising all their rights and obligations under the transaction documents. This document cannot be reproduced except in full, without prior written approval of the Company. Any unauthorized alteration, forgery or falsification of the content or appearance of this document is unlawful and offenders may be prosecuted to the fullest extent of the law.

Report Number :ER-2021-20085
 Operation Mode :802.11a
 Test Frequency :5320 MHz
 Test Mode :Tx CH High
 EUT Pol :H Plane

Test Site :SAC III Chamber
 Test Date :2021-03-04
 Temp./Humi. :21.3/62
 Antenna Pol. :HORIZONTAL
 Engineer :Ricky

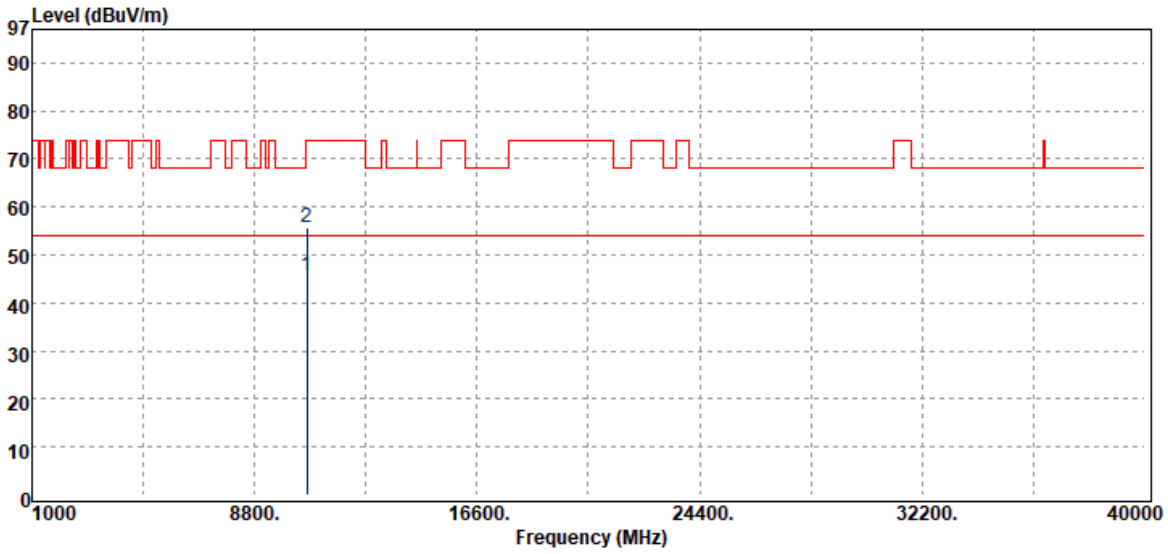

| Freq. MHz | Detector Mode PK/QP/AV | Spectrum Reading Level dB μ V | Factor dB | Actual FS dB μ V/m | Limit @3m dB μ V/m | Margin dB |
|--------------|------------------------------|---|--------------|------------------------------|------------------------------|--------------|
| 10640.00 | Average | 25.15 | 20.37 | 45.52 | 54.00 | -8.48 |
| 10640.00 | Peak | 35.30 | 20.37 | 55.67 | 74.00 | -18.33 |

Unless otherwise stated the results shown in this test report refer only to the sample(s) tested and such sample(s) are retained for 90 days only.

除非另有說明，此報告結果僅對測試之樣品負責，同時此樣品僅保留90天。本報告未經本公司書面許可，不可部份複製。

This document is issued by the Company subject to its General Conditions of Service printed overleaf, available on request or accessible at <http://www.sgs.com.tw/Terms-and-Conditions> and for electronic format documents, subject to Terms and Conditions for Electronic Documents at <http://www.sgs.com.tw/Terms-and-Conditions>. Attention is drawn to the limitation of liability, indemnification and jurisdiction issues defined therein. Any holder of this document is advised that information contained hereon reflects the Company's findings at the time of its intervention only and within the limits of Client's instructions, if any. The Company's sole responsibility is to its Client and this document does not exonerate parties to a transaction from exercising all their rights and obligations under the transaction documents. This document cannot be reproduced except in full, without prior written approval of the Company. Any unauthorized alteration, forgery or falsification of the content or appearance of this document is unlawful and offenders may be prosecuted to the fullest extent of the law.

Report Number :ER-2021-20085
 Operation Mode :802.11a
 Test Frequency :5500 MHz
 Test Mode :Tx CH Low
 EUT Pol :H Plane

Test Site :SAC III Chamber
 Test Date :2021-03-04
 Temp./Humi. :21.3/62
 Antenna Pol. :VERTICAL
 Engineer :Ricky

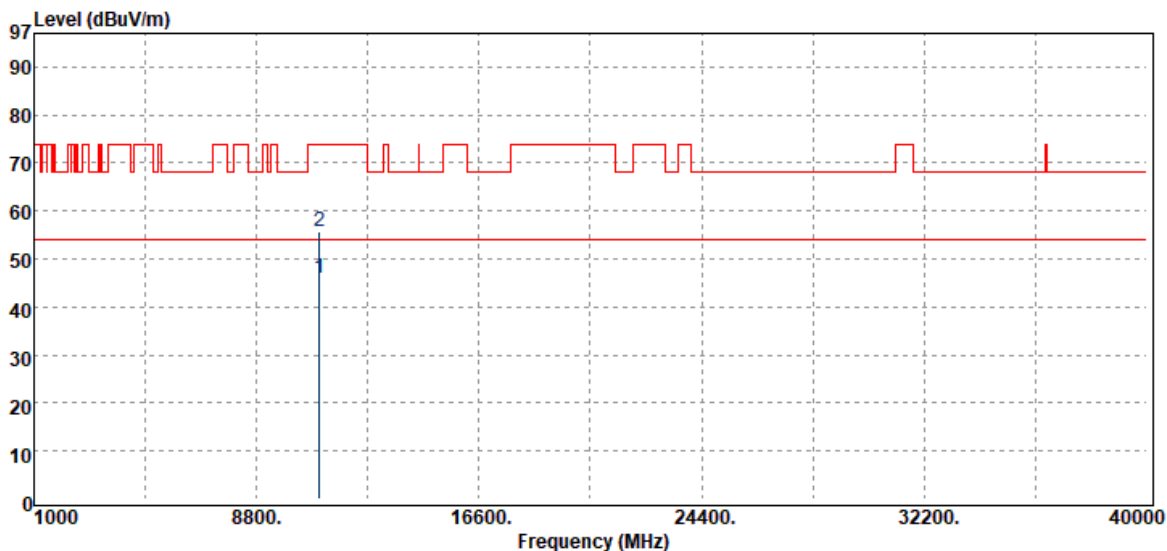

| Freq. MHz | Detector Mode PK/QP/AV | Spectrum Reading Level dBμV | Factor dB | Actual FS dBμV/m | Limit @3m dBμV/m | Margin dB |
|--------------|------------------------------|-----------------------------------|--------------|------------------------|------------------------|--------------|
| 11000.00 | Average | 25.09 | 20.90 | 45.99 | 54.00 | -8.01 |
| 11000.00 | Peak | 34.75 | 20.90 | 55.65 | 74.00 | -18.35 |

Unless otherwise stated the results shown in this test report refer only to the sample(s) tested and such sample(s) are retained for 90 days only.

除非另有說明，此報告結果僅對測試之樣品負責，同時此樣品僅保留90天。本報告未經本公司書面許可，不可部份複製。

This document is issued by the Company subject to its General Conditions of Service printed overleaf, available on request or accessible at <http://www.sgs.com.tw/Terms-and-Conditions> and for electronic format documents, subject to Terms and Conditions for Electronic Documents at <http://www.sgs.com.tw/Terms-and-Conditions>. Attention is drawn to the limitation of liability, indemnification and jurisdiction issues defined therein. Any holder of this document is advised that information contained hereon reflects the Company's findings at the time of its intervention only and within the limits of Client's instructions, if any. The Company's sole responsibility is to its Client and this document does not exonerate parties to a transaction from exercising all their rights and obligations under the transaction documents. This document cannot be reproduced except in full, without prior written approval of the Company. Any unauthorized alteration, forgery or falsification of the content or appearance of this document is unlawful and offenders may be prosecuted to the fullest extent of the law.

Report Number :ER-2021-20085
 Operation Mode :802.11a
 Test Frequency :5500 MHz
 Test Mode :Tx CH Low
 EUT Pol :H Plane

Test Site :SAC III Chamber
 Test Date :2021-03-04
 Temp./Humi. :21.3/62
 Antenna Pol. :HORIZONTAL
 Engineer :Ricky

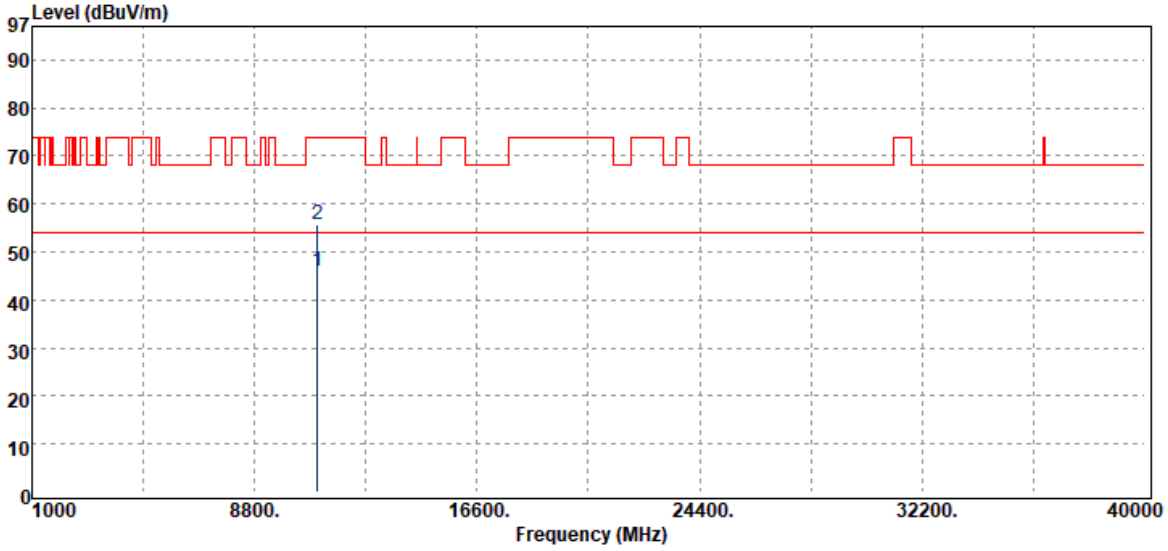

| Freq. MHz | Detector Mode PK/QP/AV | Spectrum Reading Level dB μ V | Factor dB | Actual FS dB μ V/m | Limit @3m dB μ V/m | Margin dB |
|--------------|------------------------------|---|--------------|------------------------------|------------------------------|--------------|
| 11000.00 | Average | 24.93 | 20.90 | 45.83 | 54.00 | -8.17 |
| 11000.00 | Peak | 34.80 | 20.90 | 55.70 | 74.00 | -18.30 |

Unless otherwise stated the results shown in this test report refer only to the sample(s) tested and such sample(s) are retained for 90 days only.

除非另有說明，此報告結果僅對測試之樣品負責，同時此樣品僅保留90天。本報告未經本公司書面許可，不可部份複製。

This document is issued by the Company subject to its General Conditions of Service printed overleaf, available on request or accessible at <http://www.sgs.com.tw/Terms-and-Conditions> and for electronic format documents, subject to Terms and Conditions for Electronic Documents at <http://www.sgs.com.tw/Terms-and-Conditions>. Attention is drawn to the limitation of liability, indemnification and jurisdiction issues defined therein. Any holder of this document is advised that information contained hereon reflects the Company's findings at the time of its intervention only and within the limits of Client's instructions, if any. The Company's sole responsibility is to its Client and this document does not exonerate parties to a transaction from exercising all their rights and obligations under the transaction documents. This document cannot be reproduced except in full, without prior written approval of the Company. Any unauthorized alteration, forgery or falsification of the content or appearance of this document is unlawful and offenders may be prosecuted to the fullest extent of the law.

Report Number :ER-2021-20085
 Operation Mode :802.11a
 Test Frequency :5580 MHz
 Test Mode :Tx CH Mid
 EUT Pol :H Plane

Test Site :SAC III Chamber
 Test Date :2021-03-04
 Temp./Humi. :21.3/62
 Antenna Pol. :VERTICAL
 Engineer :Ricky

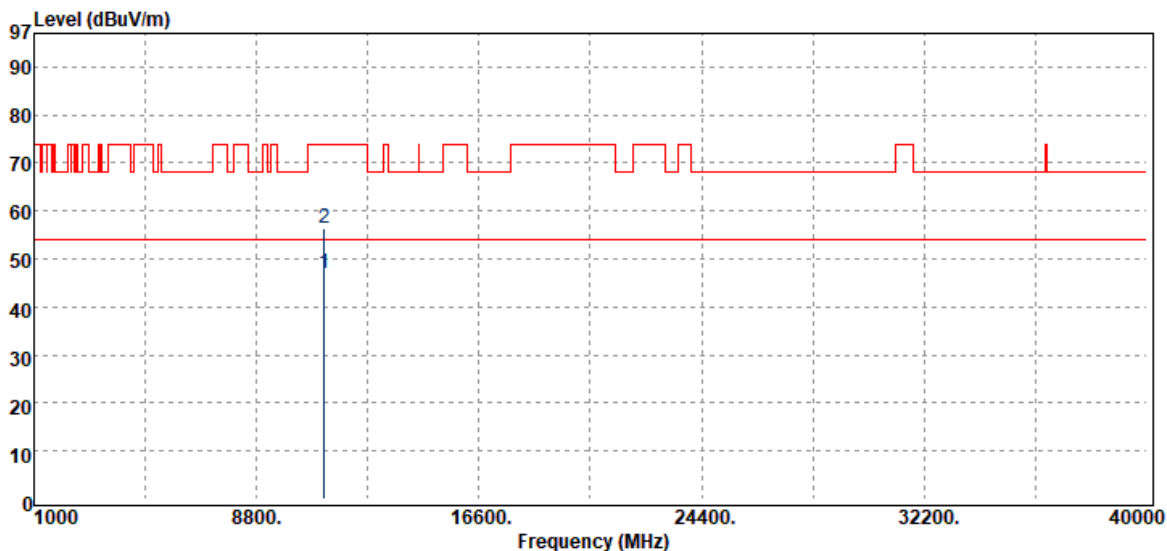

| Freq. MHz | Detector Mode PK/QP/AV | Spectrum Reading Level dB μ V | Factor dB | Actual FS dB μ V/m | Limit @3m dB μ V/m | Margin dB |
|--------------|------------------------------|---|--------------|------------------------------|------------------------------|--------------|
| 11160.00 | Average | 25.33 | 21.60 | 46.93 | 54.00 | -7.07 |
| 11160.00 | Peak | 34.88 | 21.60 | 56.48 | 74.00 | -17.52 |

Unless otherwise stated the results shown in this test report refer only to the sample(s) tested and such sample(s) are retained for 90 days only.

除非另有說明，此報告結果僅對測試之樣品負責，同時此樣品僅保留90天。本報告未經本公司書面許可，不可部份複製。

This document is issued by the Company subject to its General Conditions of Service printed overleaf, available on request or accessible at <http://www.sgs.com.tw/Terms-and-Conditions> and for electronic format documents, subject to Terms and Conditions for Electronic Documents at <http://www.sgs.com.tw/Terms-and-Conditions>. Attention is drawn to the limitation of liability, indemnification and jurisdiction issues defined therein. Any holder of this document is advised that information contained hereon reflects the Company's findings at the time of its intervention only and within the limits of Client's instructions, if any. The Company's sole responsibility is to its Client and this document does not exonerate parties to a transaction from exercising all their rights and obligations under the transaction documents. This document cannot be reproduced except in full, without prior written approval of the Company. Any unauthorized alteration, forgery or falsification of the content or appearance of this document is unlawful and offenders may be prosecuted to the fullest extent of the law.

Report Number :ER-2021-20085
 Operation Mode :802.11a
 Test Frequency :5580 MHz
 Test Mode :Tx CH Mid
 EUT Pol :H Plane

Test Site :SAC III Chamber
 Test Date :2021-03-04
 Temp./Humi. :21.3/62
 Antenna Pol. :HORIZONTAL
 Engineer :Ricky

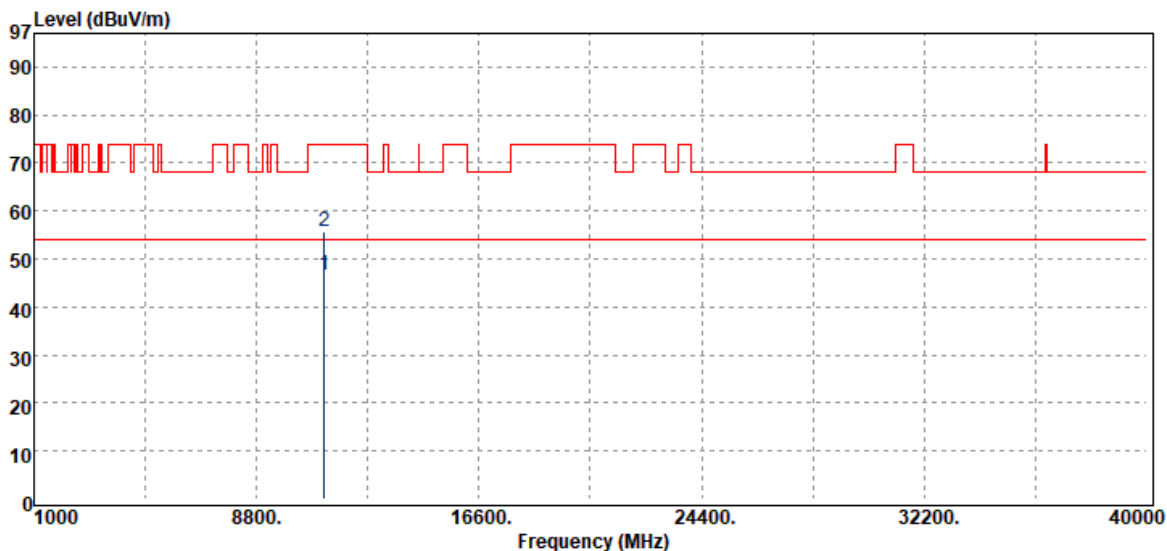

| Freq. MHz | Detector Mode PK/QP/AV | Spectrum Reading Level dB μ V | Factor dB | Actual FS dB μ V/m | Limit @3m dB μ V/m | Margin dB |
|--------------|------------------------------|---|--------------|------------------------------|------------------------------|--------------|
| 11160.00 | Average | 24.89 | 21.60 | 46.49 | 54.00 | -7.51 |
| 11160.00 | Peak | 33.99 | 21.60 | 55.59 | 74.00 | -18.41 |

Unless otherwise stated the results shown in this test report refer only to the sample(s) tested and such sample(s) are retained for 90 days only.

除非另有說明，此報告結果僅對測試之樣品負責，同時此樣品僅保留90天。本報告未經本公司書面許可，不可部份複製。

This document is issued by the Company subject to its General Conditions of Service printed overleaf, available on request or accessible at <http://www.sgs.com.tw/Terms-and-Conditions> and for electronic format documents, subject to Terms and Conditions for Electronic Documents at <http://www.sgs.com.tw/Terms-and-Conditions>. Attention is drawn to the limitation of liability, indemnification and jurisdiction issues defined therein. Any holder of this document is advised that information contained hereon reflects the Company's findings at the time of its intervention only and within the limits of Client's instructions, if any. The Company's sole responsibility is to its Client and this document does not exonerate parties to a transaction from exercising all their rights and obligations under the transaction documents. This document cannot be reproduced except in full, without prior written approval of the Company. Any unauthorized alteration, forgery or falsification of the content or appearance of this document is unlawful and offenders may be prosecuted to the fullest extent of the law.

Report Number :ER-2021-20085
 Operation Mode :802.11a
 Test Frequency :5700 MHz
 Test Mode :Tx CH High
 EUT Pol :H Plane

Test Site :SAC III Chamber
 Test Date :2021-03-04
 Temp./Humi. :21.3/62
 Antenna Pol. :VERTICAL
 Engineer :Ricky

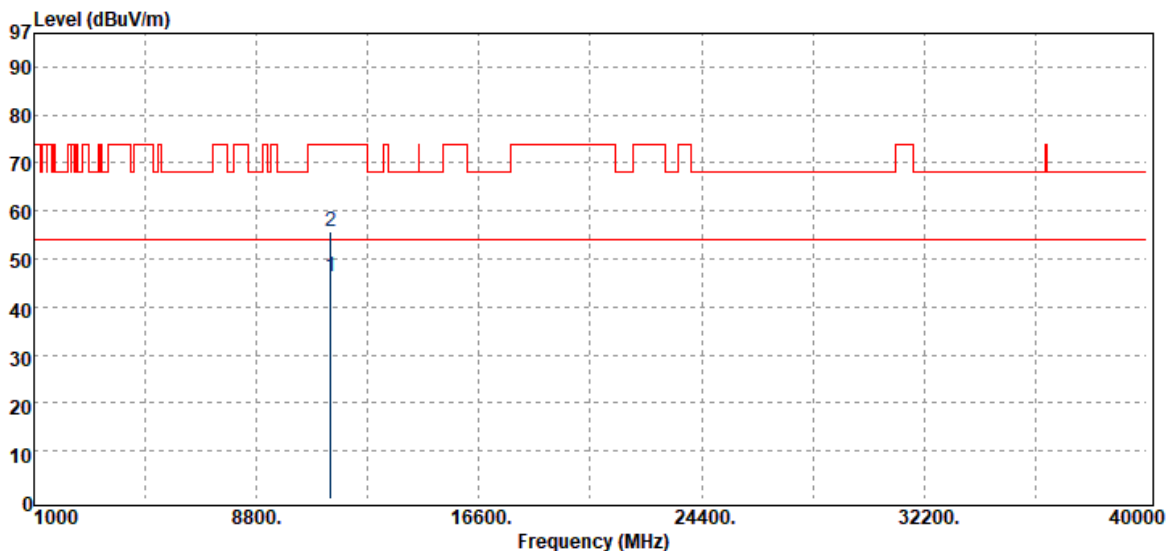

| Freq. MHz | Detector Mode PK/QP/AV | Spectrum Reading Level dB μ V | Factor dB | Actual FS dB μ V/m | Limit @3m dB μ V/m | Margin dB |
|--------------|------------------------------|---|--------------|------------------------------|------------------------------|--------------|
| 11400.00 | Average | 24.69 | 21.51 | 46.20 | 54.00 | -7.80 |
| 11400.00 | Peak | 34.34 | 21.51 | 55.85 | 74.00 | -18.15 |

Unless otherwise stated the results shown in this test report refer only to the sample(s) tested and such sample(s) are retained for 90 days only.

除非另有說明，此報告結果僅對測試之樣品負責，同時此樣品僅保留90天。本報告未經本公司書面許可，不可部份複製。

This document is issued by the Company subject to its General Conditions of Service printed overleaf, available on request or accessible at <http://www.sgs.com.tw/Terms-and-Conditions> and for electronic format documents, subject to Terms and Conditions for Electronic Documents at <http://www.sgs.com.tw/Terms-and-Conditions>. Attention is drawn to the limitation of liability, indemnification and jurisdiction issues defined therein. Any holder of this document is advised that information contained hereon reflects the Company's findings at the time of its intervention only and within the limits of Client's instructions, if any. The Company's sole responsibility is to its Client and this document does not exonerate parties to a transaction from exercising all their rights and obligations under the transaction documents. This document cannot be reproduced except in full, without prior written approval of the Company. Any unauthorized alteration, forgery or falsification of the content or appearance of this document is unlawful and offenders may be prosecuted to the fullest extent of the law.

Report Number :ER-2021-20085
 Operation Mode :802.11a
 Test Frequency :5700 MHz
 Test Mode :Tx CH High
 EUT Pol :H Plane

Test Site :SAC III Chamber
 Test Date :2021-03-04
 Temp./Humi. :21.3/62
 Antenna Pol. :HORIZONTAL
 Engineer :Ricky

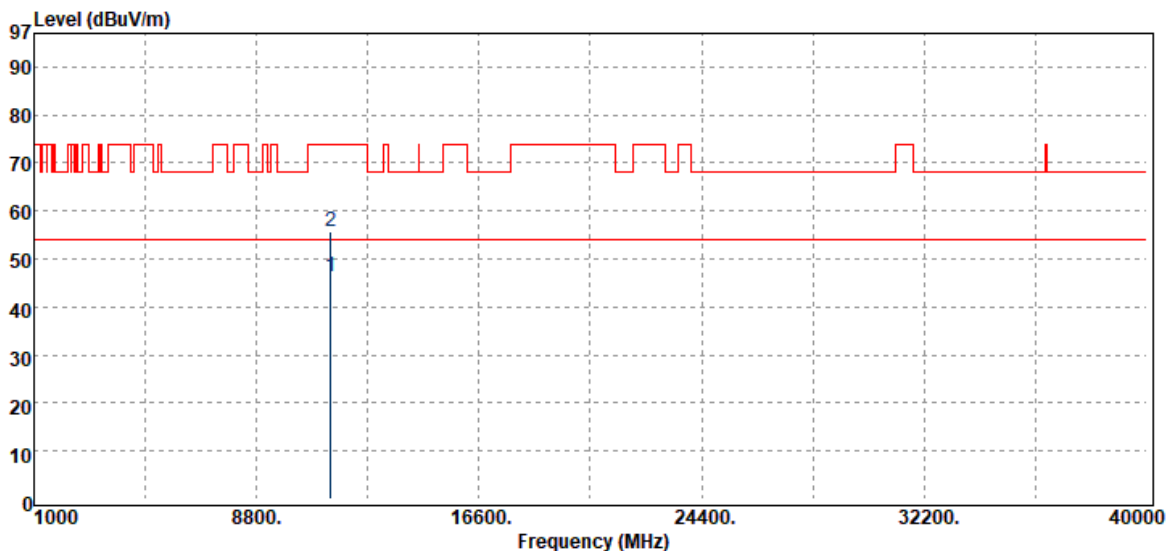

| Freq. MHz | Detector Mode PK/QP/AV | Spectrum Reading Level dB μ V | Factor dB | Actual FS dB μ V/m | Limit @3m dB μ V/m | Margin dB |
|--------------|------------------------------|---|--------------|------------------------------|------------------------------|--------------|
| 11400.00 | Average | 24.65 | 21.51 | 46.16 | 54.00 | -7.84 |
| 11400.00 | Peak | 34.36 | 21.51 | 55.87 | 74.00 | -18.13 |

Unless otherwise stated the results shown in this test report refer only to the sample(s) tested and such sample(s) are retained for 90 days only.

除非另有說明，此報告結果僅對測試之樣品負責，同時此樣品僅保留90天。本報告未經本公司書面許可，不可部份複製。

This document is issued by the Company subject to its General Conditions of Service printed overleaf, available on request or accessible at <http://www.sgs.com.tw/Terms-and-Conditions> and for electronic format documents, subject to Terms and Conditions for Electronic Documents at <http://www.sgs.com.tw/Terms-and-Conditions>. Attention is drawn to the limitation of liability, indemnification and jurisdiction issues defined therein. Any holder of this document is advised that information contained hereon reflects the Company's findings at the time of its intervention only and within the limits of Client's instructions, if any. The Company's sole responsibility is to its Client and this document does not exonerate parties to a transaction from exercising all their rights and obligations under the transaction documents. This document cannot be reproduced except in full, without prior written approval of the Company. Any unauthorized alteration, forgery or falsification of the content or appearance of this document is unlawful and offenders may be prosecuted to the fullest extent of the law.

Report Number :ER-2021-20085
 Operation Mode :802.11a
 Test Frequency :5720 MHz
 Test Mode :Tx CH High
 EUT Pol :H Plane

Test Site :SAC III Chamber
 Test Date :2021-03-04
 Temp./Humi. :21.3/62
 Antenna Pol. :VERTICAL
 Engineer :Ricky

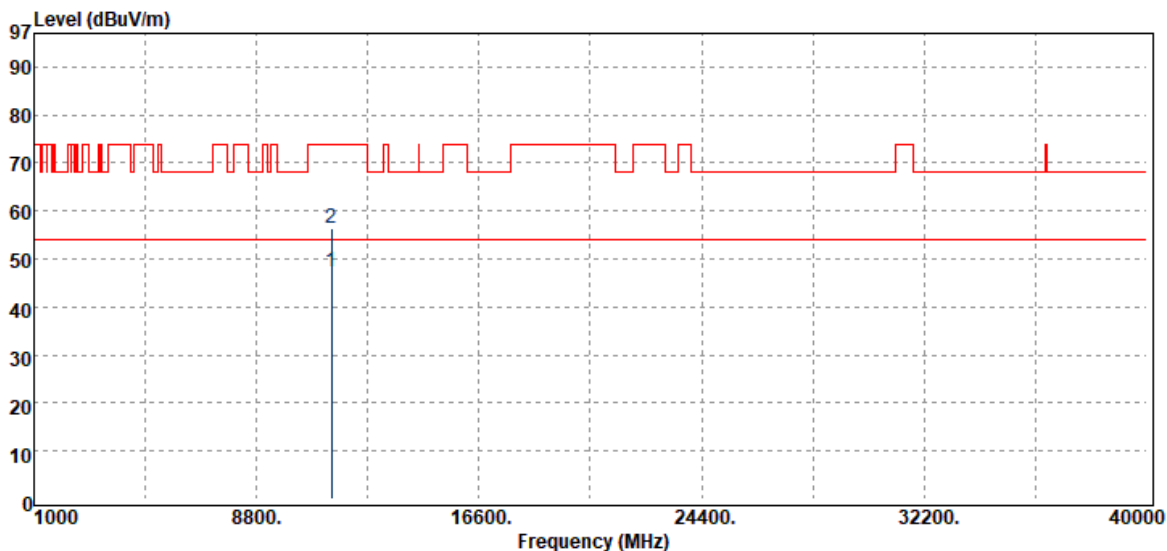

| Freq. MHz | Detector Mode PK/QP/AV | Spectrum Reading Level dB μ V | Factor dB | Actual FS dB μ V/m | Limit @3m dB μ V/m | Margin dB |
|--------------|------------------------------|---|--------------|------------------------------|------------------------------|--------------|
| 11440.00 | Average | 24.52 | 22.75 | 47.27 | 54.00 | -6.73 |
| 11440.00 | Peak | 33.47 | 22.75 | 56.22 | 74.00 | -17.78 |

Unless otherwise stated the results shown in this test report refer only to the sample(s) tested and such sample(s) are retained for 90 days only.

除非另有說明，此報告結果僅對測試之樣品負責，同時此樣品僅保留90天。本報告未經本公司書面許可，不可部份複製。

This document is issued by the Company subject to its General Conditions of Service printed overleaf, available on request or accessible at <http://www.sgs.com.tw/Terms-and-Conditions> and for electronic format documents, subject to Terms and Conditions for Electronic Documents at <http://www.sgs.com.tw/Terms-and-Conditions>. Attention is drawn to the limitation of liability, indemnification and jurisdiction issues defined therein. Any holder of this document is advised that information contained hereon reflects the Company's findings at the time of its intervention only and within the limits of Client's instructions, if any. The Company's sole responsibility is to its Client and this document does not exonerate parties to a transaction from exercising all their rights and obligations under the transaction documents. This document cannot be reproduced except in full, without prior written approval of the Company. Any unauthorized alteration, forgery or falsification of the content or appearance of this document is unlawful and offenders may be prosecuted to the fullest extent of the law.

Report Number :ER-2021-20085
 Operation Mode :802.11a
 Test Frequency :5720 MHz
 Test Mode :Tx CH High
 EUT Pol :H Plane

Test Site :SAC III Chamber
 Test Date :2021-03-04
 Temp./Humi. :21.3/62
 Antenna Pol. :HORIZONTAL
 Engineer :Ricky

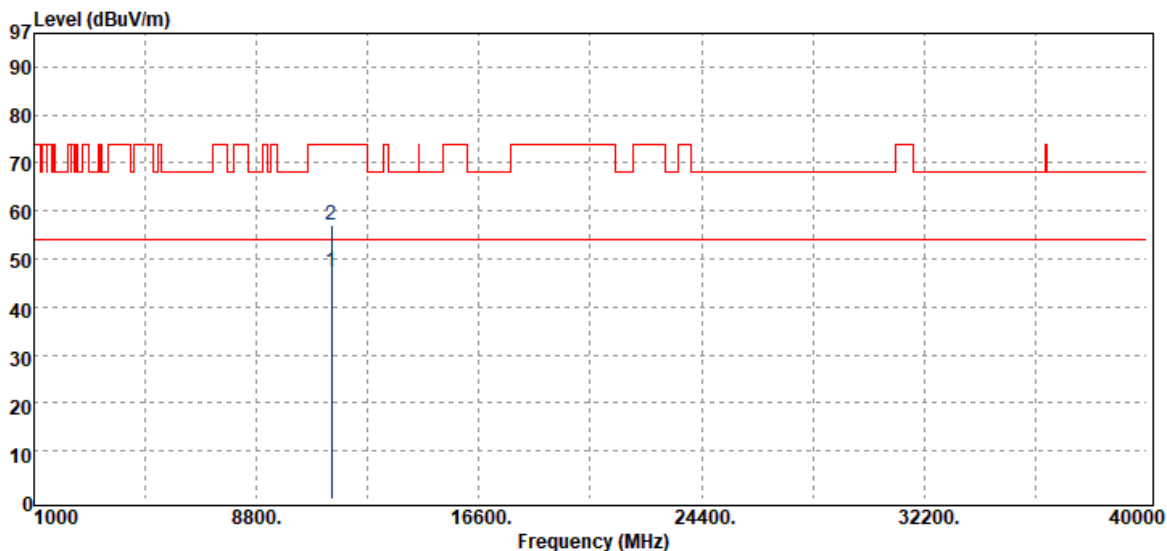

| Freq. MHz | Detector Mode PK/QP/AV | Spectrum Reading Level dB μ V | Factor dB | Actual FS dB μ V/m | Limit @3m dB μ V/m | Margin dB |
|--------------|------------------------------|---|--------------|------------------------------|------------------------------|--------------|
| 11440.00 | Average | 24.53 | 22.75 | 47.28 | 54.00 | -6.72 |
| 11440.00 | Peak | 34.43 | 22.75 | 57.18 | 74.00 | -16.82 |

Unless otherwise stated the results shown in this test report refer only to the sample(s) tested and such sample(s) are retained for 90 days only.

除非另有說明，此報告結果僅對測試之樣品負責，同時此樣品僅保留90天。本報告未經本公司書面許可，不可部份複製。

This document is issued by the Company subject to its General Conditions of Service printed overleaf, available on request or accessible at <http://www.sgs.com.tw/Terms-and-Conditions> and for electronic format documents, subject to Terms and Conditions for Electronic Documents at <http://www.sgs.com.tw/Terms-and-Conditions>. Attention is drawn to the limitation of liability, indemnification and jurisdiction issues defined therein. Any holder of this document is advised that information contained hereon reflects the Company's findings at the time of its intervention only and within the limits of Client's instructions, if any. The Company's sole responsibility is to its Client and this document does not exonerate parties to a transaction from exercising all their rights and obligations under the transaction documents. This document cannot be reproduced except in full, without prior written approval of the Company. Any unauthorized alteration, forgery or falsification of the content or appearance of this document is unlawful and offenders may be prosecuted to the fullest extent of the law.

Report Number :ER-2021-20085
 Operation Mode :802.11a
 Test Frequency :5745 MHz
 Test Mode :Tx CH Low
 EUT Pol :H Plane

Test Site :SAC III Chamber
 Test Date :2021-03-04
 Temp./Humi. :21.3/62
 Antenna Pol. :VERTICAL
 Engineer :Ricky

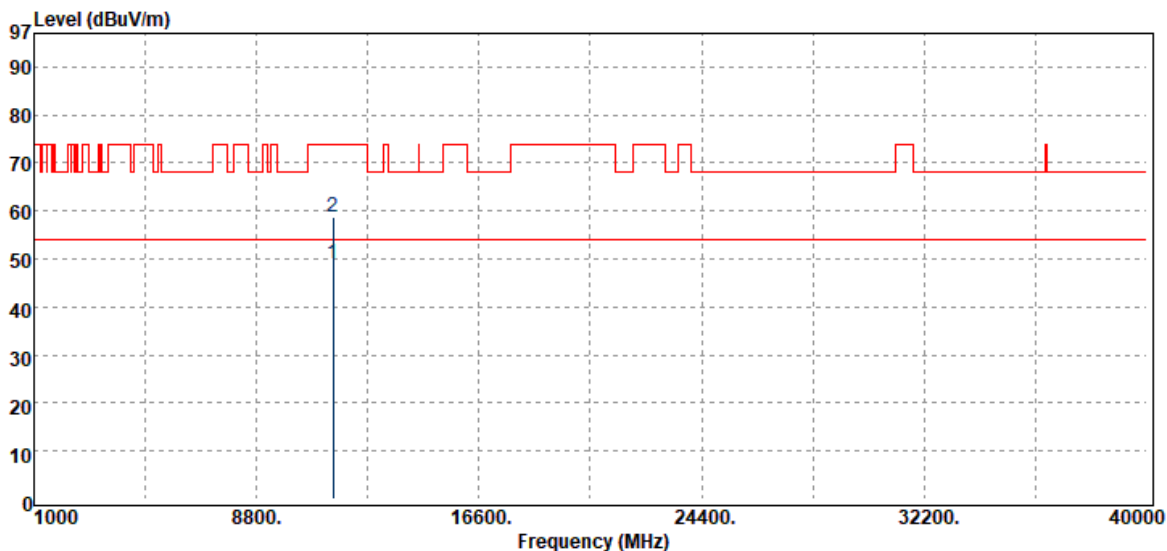

| Freq. MHz | Detector Mode PK/QP/AV | Spectrum Reading Level dBμV | Factor dB | Actual FS dBμV/m | Limit @3m dBμV/m | Margin dB |
|--------------|------------------------------|-----------------------------------|--------------|------------------------|------------------------|--------------|
| 11490.00 | Average | 24.49 | 24.41 | 48.90 | 54.00 | -5.10 |
| 11490.00 | Peak | 34.23 | 24.41 | 58.64 | 74.00 | -15.36 |

Unless otherwise stated the results shown in this test report refer only to the sample(s) tested and such sample(s) are retained for 90 days only.

除非另有說明，此報告結果僅對測試之樣品負責，同時此樣品僅保留90天。本報告未經本公司書面許可，不可部份複製。

This document is issued by the Company subject to its General Conditions of Service printed overleaf, available on request or accessible at <http://www.sgs.com.tw/Terms-and-Conditions> and for electronic format documents, subject to Terms and Conditions for Electronic Documents at <http://www.sgs.com.tw/Terms-and-Conditions>. Attention is drawn to the limitation of liability, indemnification and jurisdiction issues defined therein. Any holder of this document is advised that information contained hereon reflects the Company's findings at the time of its intervention only and within the limits of Client's instructions, if any. The Company's sole responsibility is to its Client and this document does not exonerate parties to a transaction from exercising all their rights and obligations under the transaction documents. This document cannot be reproduced except in full, without prior written approval of the Company. Any unauthorized alteration, forgery or falsification of the content or appearance of this document is unlawful and offenders may be prosecuted to the fullest extent of the law.

Report Number :ER-2021-20085
 Operation Mode :802.11a
 Test Frequency :5745 MHz
 Test Mode :Tx CH Low
 EUT Pol :H Plane

Test Site :SAC III Chamber
 Test Date :2021-03-04
 Temp./Humi. :21.3/62
 Antenna Pol. :HORIZONTAL
 Engineer :Ricky

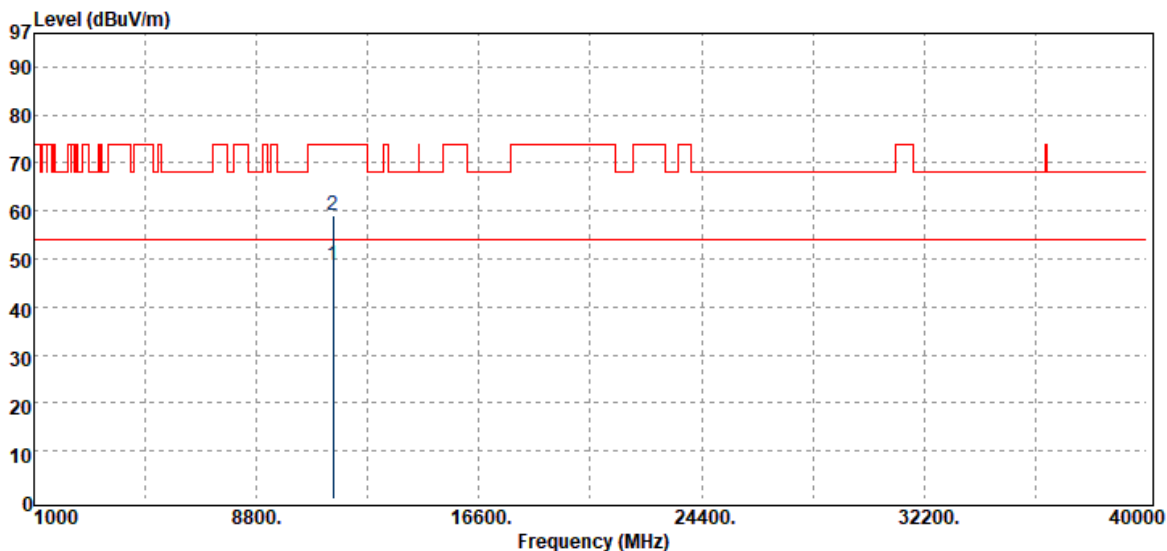

| Freq. MHz | Detector Mode PK/QP/AV | Spectrum Reading Level dB μ V | Factor dB | Actual FS dB μ V/m | Limit @3m dB μ V/m | Margin dB |
|--------------|------------------------------|---|--------------|------------------------------|------------------------------|--------------|
| 11490.00 | Average | 24.32 | 24.41 | 48.73 | 54.00 | -5.27 |
| 11490.00 | Peak | 34.54 | 24.41 | 58.95 | 74.00 | -15.05 |

Unless otherwise stated the results shown in this test report refer only to the sample(s) tested and such sample(s) are retained for 90 days only.

除非另有說明，此報告結果僅對測試之樣品負責，同時此樣品僅保留90天。本報告未經本公司書面許可，不可部份複製。

This document is issued by the Company subject to its General Conditions of Service printed overleaf, available on request or accessible at <http://www.sgs.com.tw/Terms-and-Conditions> and for electronic format documents, subject to Terms and Conditions for Electronic Documents at <http://www.sgs.com.tw/Terms-and-Conditions>. Attention is drawn to the limitation of liability, indemnification and jurisdiction issues defined therein. Any holder of this document is advised that information contained hereon reflects the Company's findings at the time of its intervention only and within the limits of Client's instructions, if any. The Company's sole responsibility is to its Client and this document does not exonerate parties to a transaction from exercising all their rights and obligations under the transaction documents. This document cannot be reproduced except in full, without prior written approval of the Company. Any unauthorized alteration, forgery or falsification of the content or appearance of this document is unlawful and offenders may be prosecuted to the fullest extent of the law.

Report Number :ER-2021-20085
 Operation Mode :802.11a
 Test Frequency :5785 MHz
 Test Mode :Tx CH Mid
 EUT Pol :H Plane

Test Site :SAC III Chamber
 Test Date :2021-03-04
 Temp./Humi. :21.3/62
 Antenna Pol. :VERTICAL
 Engineer :Ricky

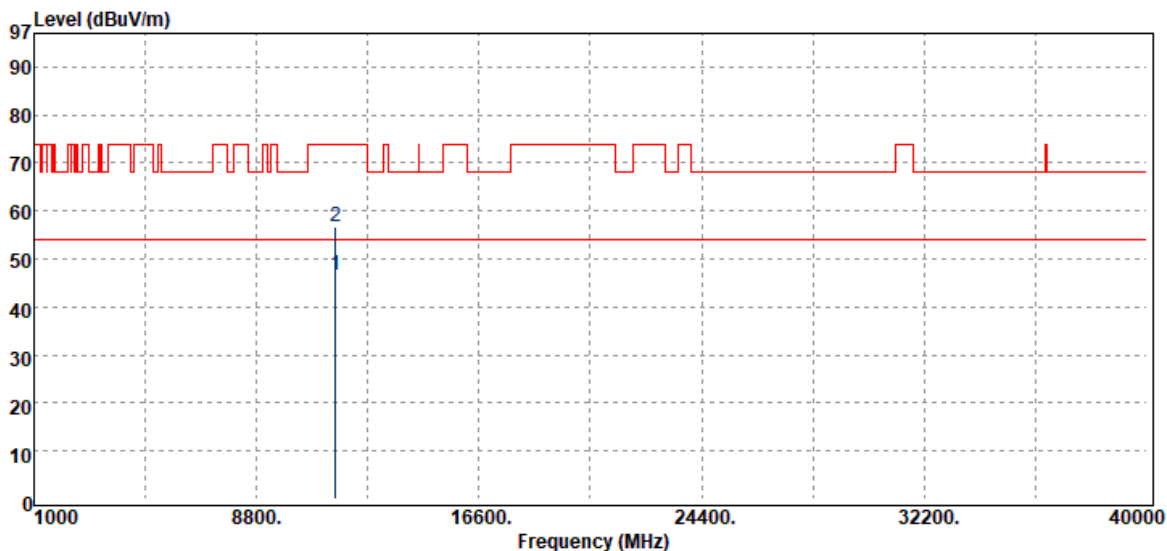

| Freq. MHz | Detector Mode PK/QP/AV | Spectrum Reading Level dB μ V | Factor dB | Actual FS dB μ V/m | Limit @3m dB μ V/m | Margin dB |
|--------------|------------------------------|---|--------------|------------------------------|------------------------------|--------------|
| 11570.00 | Average | 24.84 | 21.84 | 46.68 | 54.00 | -7.32 |
| 11570.00 | Peak | 34.85 | 21.84 | 56.69 | 74.00 | -17.31 |

Unless otherwise stated the results shown in this test report refer only to the sample(s) tested and such sample(s) are retained for 90 days only.

除非另有說明，此報告結果僅對測試之樣品負責，同時此樣品僅保留90天。本報告未經本公司書面許可，不可部份複製。

This document is issued by the Company subject to its General Conditions of Service printed overleaf, available on request or accessible at <http://www.sgs.com.tw/Terms-and-Conditions> and for electronic format documents, subject to Terms and Conditions for Electronic Documents at <http://www.sgs.com.tw/Terms-and-Conditions>. Attention is drawn to the limitation of liability, indemnification and jurisdiction issues defined therein. Any holder of this document is advised that information contained hereon reflects the Company's findings at the time of its intervention only and within the limits of Client's instructions, if any. The Company's sole responsibility is to its Client and this document does not exonerate parties to a transaction from exercising all their rights and obligations under the transaction documents. This document cannot be reproduced except in full, without prior written approval of the Company. Any unauthorized alteration, forgery or falsification of the content or appearance of this document is unlawful and offenders may be prosecuted to the fullest extent of the law.

Report Number :ER-2021-20085
 Operation Mode :802.11a
 Test Frequency :5785 MHz
 Test Mode :Tx CH Mid
 EUT Pol :H Plane

Test Site :SAC III Chamber
 Test Date :2021-03-04
 Temp./Humi. :21.3/62
 Antenna Pol. :HORIZONTAL
 Engineer :Ricky

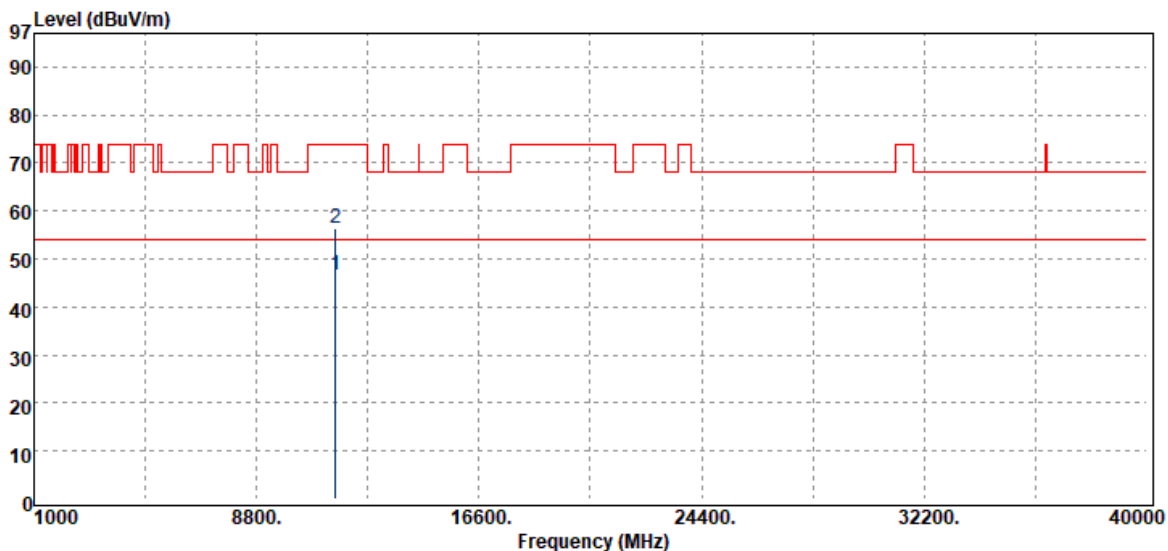

| Freq. MHz | Detector Mode PK/QP/AV | Spectrum Reading Level dB μ V | Factor dB | Actual FS dB μ V/m | Limit @3m dB μ V/m | Margin dB |
|--------------|------------------------------|---|--------------|------------------------------|------------------------------|--------------|
| 11570.00 | Average | 24.93 | 21.84 | 46.77 | 54.00 | -7.23 |
| 11570.00 | Peak | 34.50 | 21.84 | 56.34 | 74.00 | -17.66 |

Unless otherwise stated the results shown in this test report refer only to the sample(s) tested and such sample(s) are retained for 90 days only.

除非另有說明，此報告結果僅對測試之樣品負責，同時此樣品僅保留90天。本報告未經本公司書面許可，不可部份複製。

This document is issued by the Company subject to its General Conditions of Service printed overleaf, available on request or accessible at <http://www.sgs.com.tw/Terms-and-Conditions> and for electronic format documents, subject to Terms and Conditions for Electronic Documents at <http://www.sgs.com.tw/Terms-and-Conditions>. Attention is drawn to the limitation of liability, indemnification and jurisdiction issues defined therein. Any holder of this document is advised that information contained hereon reflects the Company's findings at the time of its intervention only and within the limits of Client's instructions, if any. The Company's sole responsibility is to its Client and this document does not exonerate parties to a transaction from exercising all their rights and obligations under the transaction documents. This document cannot be reproduced except in full, without prior written approval of the Company. Any unauthorized alteration, forgery or falsification of the content or appearance of this document is unlawful and offenders may be prosecuted to the fullest extent of the law.

Report Number :ER-2021-20085
 Operation Mode :802.11a
 Test Frequency :5825 MHz
 Test Mode :Tx CH High
 EUT Pol :H Plane

Test Site :SAC III Chamber
 Test Date :2021-03-04
 Temp./Humi. :21.3/62
 Antenna Pol. :VERTICAL
 Engineer :Ricky

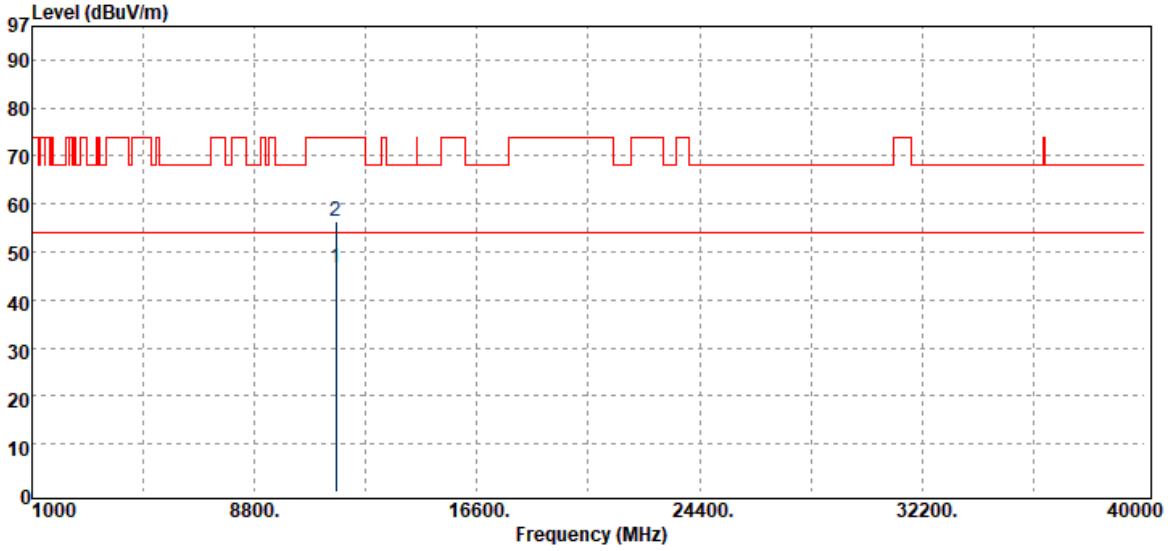

| Freq. MHz | Detector Mode PK/QP/AV | Spectrum Reading Level dB μ V | Factor dB | Actual FS dB μ V/m | Limit @3m dB μ V/m | Margin dB |
|--------------|------------------------------|---|--------------|------------------------------|------------------------------|--------------|
| 11650.00 | Average | 24.49 | 22.13 | 46.62 | 54.00 | -7.38 |
| 11650.00 | Peak | 34.34 | 22.13 | 56.47 | 74.00 | -17.53 |

Unless otherwise stated the results shown in this test report refer only to the sample(s) tested and such sample(s) are retained for 90 days only.

除非另有說明，此報告結果僅對測試之樣品負責，同時此樣品僅保留90天。本報告未經本公司書面許可，不可部份複製。

This document is issued by the Company subject to its General Conditions of Service printed overleaf, available on request or accessible at <http://www.sgs.com.tw/Terms-and-Conditions> and for electronic format documents, subject to Terms and Conditions for Electronic Documents at <http://www.sgs.com.tw/Terms-and-Conditions>. Attention is drawn to the limitation of liability, indemnification and jurisdiction issues defined therein. Any holder of this document is advised that information contained hereon reflects the Company's findings at the time of its intervention only and within the limits of Client's instructions, if any. The Company's sole responsibility is to its Client and this document does not exonerate parties to a transaction from exercising all their rights and obligations under the transaction documents. This document cannot be reproduced except in full, without prior written approval of the Company. Any unauthorized alteration, forgery or falsification of the content or appearance of this document is unlawful and offenders may be prosecuted to the fullest extent of the law.

Report Number :ER-2021-20085
 Operation Mode :802.11a
 Test Frequency :5825 MHz
 Test Mode :Tx CH High
 EUT Pol :H Plane

Test Site :SAC III Chamber
 Test Date :2021-03-04
 Temp./Humi. :21.3/62
 Antenna Pol. :HORIZONTAL
 Engineer :Ricky

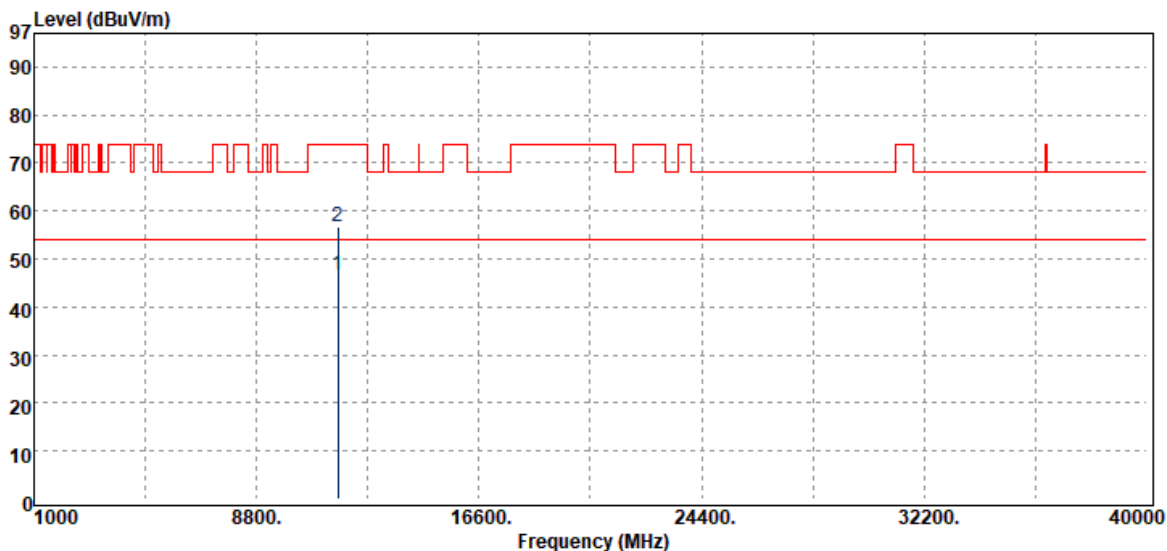

| Freq. MHz | Detector Mode PK/QP/AV | Spectrum Reading Level dB μ V | Factor dB | Actual FS dB μ V/m | Limit @3m dB μ V/m | Margin dB |
|--------------|------------------------------|---|--------------|------------------------------|------------------------------|--------------|
| 11650.00 | Average | 24.52 | 22.13 | 46.65 | 54.00 | -7.35 |
| 11650.00 | Peak | 34.50 | 22.13 | 56.63 | 74.00 | -17.37 |

Unless otherwise stated the results shown in this test report refer only to the sample(s) tested and such sample(s) are retained for 90 days only.

除非另有說明，此報告結果僅對測試之樣品負責，同時此樣品僅保留90天。本報告未經本公司書面許可，不可部份複製。

This document is issued by the Company subject to its General Conditions of Service printed overleaf, available on request or accessible at <http://www.sgs.com.tw/Terms-and-Conditions> and for electronic format documents, subject to Terms and Conditions for Electronic Documents at <http://www.sgs.com.tw/Terms-and-Conditions>. Attention is drawn to the limitation of liability, indemnification and jurisdiction issues defined therein. Any holder of this document is advised that information contained hereon reflects the Company's findings at the time of its intervention only and within the limits of Client's instructions, if any. The Company's sole responsibility is to its Client and this document does not exonerate parties to a transaction from exercising all their rights and obligations under the transaction documents. This document cannot be reproduced except in full, without prior written approval of the Company. Any unauthorized alteration, forgery or falsification of the content or appearance of this document is unlawful and offenders may be prosecuted to the fullest extent of the law.

Report Number :ER-2021-20085
 Operation Mode :802.11n20
 Test Frequency :5180 MHz
 Test Mode :Tx CH Low
 EUT Pol :H Plane

Test Site :SAC III Chamber
 Test Date :2021-03-04
 Temp./Humi. :21.3/62
 Antenna Pol. :VERTICAL
 Engineer :Ricky

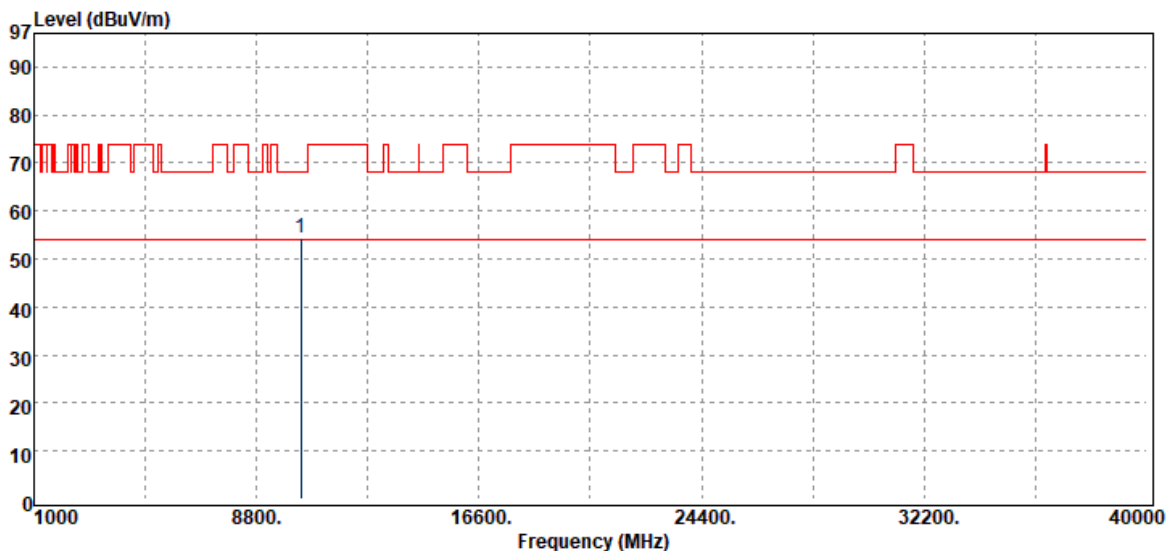

| Freq. MHz | Detector Mode PK/QP/AV | Spectrum Reading Level dB μ V | Factor dB | Actual FS dB μ V/m | Limit @3m dB μ V/m | Margin dB |
|--------------|------------------------------|---|--------------|------------------------------|------------------------------|--------------|
| 10360.00 | Peak | 34.53 | 19.87 | 54.40 | 68.20 | -13.80 |

Unless otherwise stated the results shown in this test report refer only to the sample(s) tested and such sample(s) are retained for 90 days only.

除非另有說明，此報告結果僅對測試之樣品負責，同時此樣品僅保留90天。本報告未經本公司書面許可，不可部份複製。

This document is issued by the Company subject to its General Conditions of Service printed overleaf, available on request or accessible at <http://www.sgs.com.tw/Terms-and-Conditions> and for electronic format documents, subject to Terms and Conditions for Electronic Documents at <http://www.sgs.com.tw/Terms-and-Conditions>. Attention is drawn to the limitation of liability, indemnification and jurisdiction issues defined therein. Any holder of this document is advised that information contained hereon reflects the Company's findings at the time of its intervention only and within the limits of Client's instructions, if any. The Company's sole responsibility is to its Client and this document does not exonerate parties to a transaction from exercising all their rights and obligations under the transaction documents. This document cannot be reproduced except in full, without prior written approval of the Company. Any unauthorized alteration, forgery or falsification of the content or appearance of this document is unlawful and offenders may be prosecuted to the fullest extent of the law.

| | | | |
|----------------|----------------|--------------|------------------|
| Report Number | :ER-2021-20085 | Test Site | :SAC III Chamber |
| Operation Mode | :802.11n20 | Test Date | :2021-03-04 |
| Test Frequency | :5180 MHz | Temp./Humi. | :21.3/62 |
| Test Mode | :Tx CH Low | Antenna Pol. | :HORIZONTAL |
| EUT Pol | :H Plane | Engineer | :Ricky |

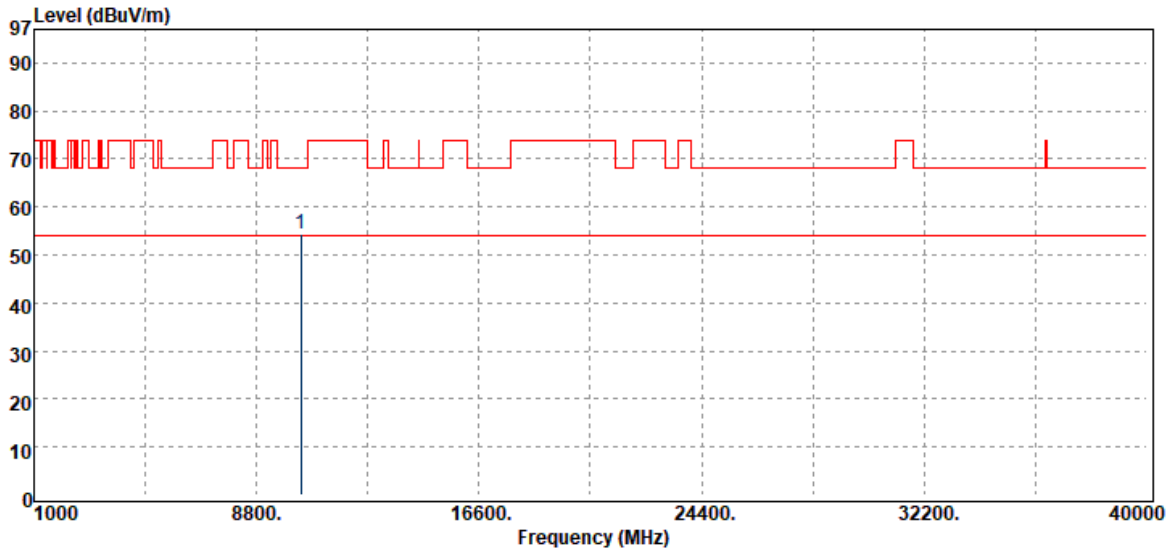

| Freq. MHz | Detector Mode PK/QP/AV | Spectrum Reading Level dB μ V | Factor dB | Actual FS dB μ V/m | Limit @3m dB μ V/m | Margin dB |
|--------------|------------------------------|---|--------------|------------------------------|------------------------------|--------------|
| 10360.00 | Peak | 34.62 | 19.87 | 54.49 | 68.20 | -13.71 |

Unless otherwise stated the results shown in this test report refer only to the sample(s) tested and such sample(s) are retained for 90 days only.

除非另有說明，此報告結果僅對測試之樣品負責，同時此樣品僅保留90天。本報告未經本公司書面許可，不可部份複製。

This document is issued by the Company subject to its General Conditions of Service printed overleaf, available on request or accessible at <http://www.sgs.com.tw/Terms-and-Conditions> and for electronic format documents, subject to Terms and Conditions for Electronic Documents at <http://www.sgs.com.tw/Terms-and-Conditions>. Attention is drawn to the limitation of liability, indemnification and jurisdiction issues defined therein. Any holder of this document is advised that information contained hereon reflects the Company's findings at the time of its intervention only and within the limits of Client's instructions, if any. The Company's sole responsibility is to its Client and this document does not exonerate parties to a transaction from exercising all their rights and obligations under the transaction documents. This document cannot be reproduced except in full, without prior written approval of the Company. Any unauthorized alteration, forgery or falsification of the content or appearance of this document is unlawful and offenders may be prosecuted to the fullest extent of the law.

Report Number :ER-2021-20085
 Operation Mode :802.11n20
 Test Frequency :5220 MHz
 Test Mode :Tx CH Mid
 EUT Pol :H Plane

Test Site :SAC III Chamber
 Test Date :2021-03-04
 Temp./Humi. :21.3/62
 Antenna Pol. :VERTICAL
 Engineer :Ricky

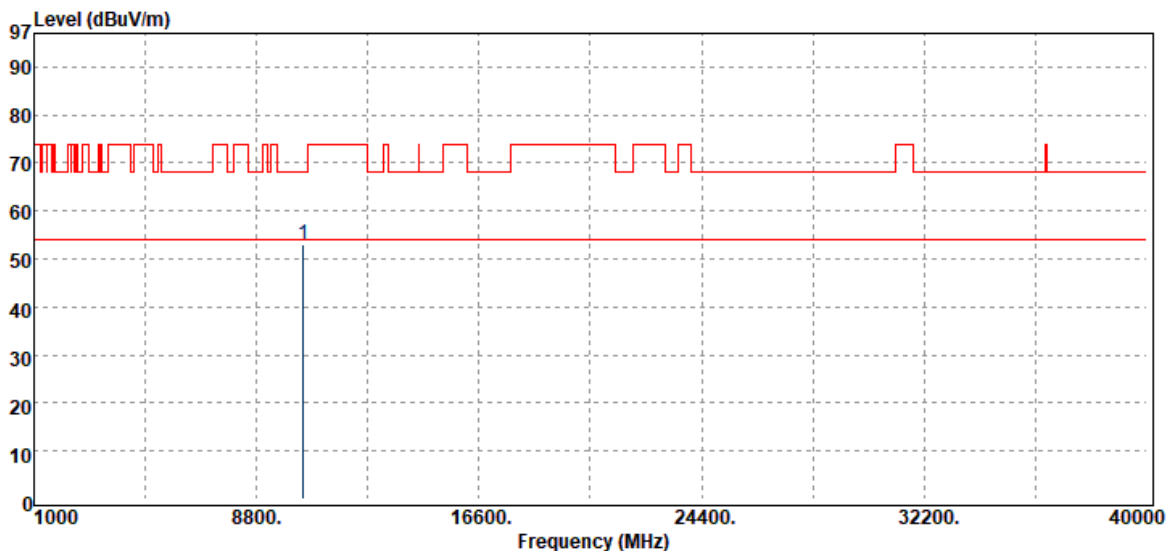

| Freq. MHz | Detector Mode PK/QP/AV | Spectrum Reading Level dB μ V | Factor dB | Actual FS dB μ V/m | Limit @3m dB μ V/m | Margin dB |
|--------------|------------------------------|---|--------------|------------------------------|------------------------------|--------------|
| 10440.00 | Peak | 33.98 | 19.15 | 53.13 | 68.20 | -15.07 |

Unless otherwise stated the results shown in this test report refer only to the sample(s) tested and such sample(s) are retained for 90 days only.

除非另有說明，此報告結果僅對測試之樣品負責，同時此樣品僅保留90天。本報告未經本公司書面許可，不可部份複製。

This document is issued by the Company subject to its General Conditions of Service printed overleaf, available on request or accessible at <http://www.sgs.com.tw/Terms-and-Conditions> and for electronic format documents, subject to Terms and Conditions for Electronic Documents at <http://www.sgs.com.tw/Terms-and-Conditions>. Attention is drawn to the limitation of liability, indemnification and jurisdiction issues defined therein. Any holder of this document is advised that information contained hereon reflects the Company's findings at the time of its intervention only and within the limits of Client's instructions, if any. The Company's sole responsibility is to its Client and this document does not exonerate parties to a transaction from exercising all their rights and obligations under the transaction documents. This document cannot be reproduced except in full, without prior written approval of the Company. Any unauthorized alteration, forgery or falsification of the content or appearance of this document is unlawful and offenders may be prosecuted to the fullest extent of the law.

Report Number :ER-2021-20085
 Operation Mode :802.11n20
 Test Frequency :5220 MHz
 Test Mode :Tx CH Mid
 EUT Pol :H Plane

Test Site :SAC III Chamber
 Test Date :2021-03-04
 Temp./Humi. :21.3/62
 Antenna Pol. :HORIZONTAL
 Engineer :Ricky

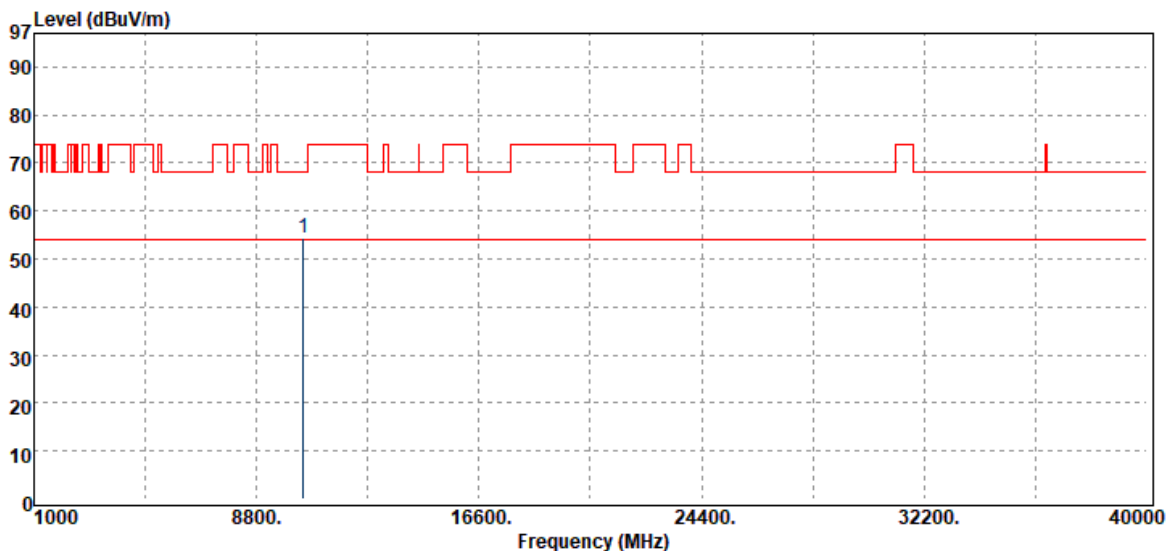

| Freq. MHz | Detector Mode PK/QP/AV | Spectrum Reading Level dB μ V | Factor dB | Actual FS dB μ V/m | Limit @3m dB μ V/m | Margin dB |
|--------------|------------------------------|---|--------------|------------------------------|------------------------------|--------------|
| 10440.00 | Peak | 35.16 | 19.15 | 54.31 | 68.20 | -13.89 |

Unless otherwise stated the results shown in this test report refer only to the sample(s) tested and such sample(s) are retained for 90 days only.

除非另有說明，此報告結果僅對測試之樣品負責，同時此樣品僅保留90天。本報告未經本公司書面許可，不可部份複製。

This document is issued by the Company subject to its General Conditions of Service printed overleaf, available on request or accessible at <http://www.sgs.com.tw/Terms-and-Conditions> and for electronic format documents, subject to Terms and Conditions for Electronic Documents at <http://www.sgs.com.tw/Terms-and-Conditions>. Attention is drawn to the limitation of liability, indemnification and jurisdiction issues defined therein. Any holder of this document is advised that information contained hereon reflects the Company's findings at the time of its intervention only and within the limits of Client's instructions, if any. The Company's sole responsibility is to its Client and this document does not exonerate parties to a transaction from exercising all their rights and obligations under the transaction documents. This document cannot be reproduced except in full, without prior written approval of the Company. Any unauthorized alteration, forgery or falsification of the content or appearance of this document is unlawful and offenders may be prosecuted to the fullest extent of the law.

Report Number :ER-2021-20085
 Operation Mode :802.11n20
 Test Frequency :5240 MHz
 Test Mode :Tx CH High
 EUT Pol :H Plane

Test Site :SAC III Chamber
 Test Date :2021-03-04
 Temp./Humi. :21.3/62
 Antenna Pol. :VERTICAL
 Engineer :Ricky

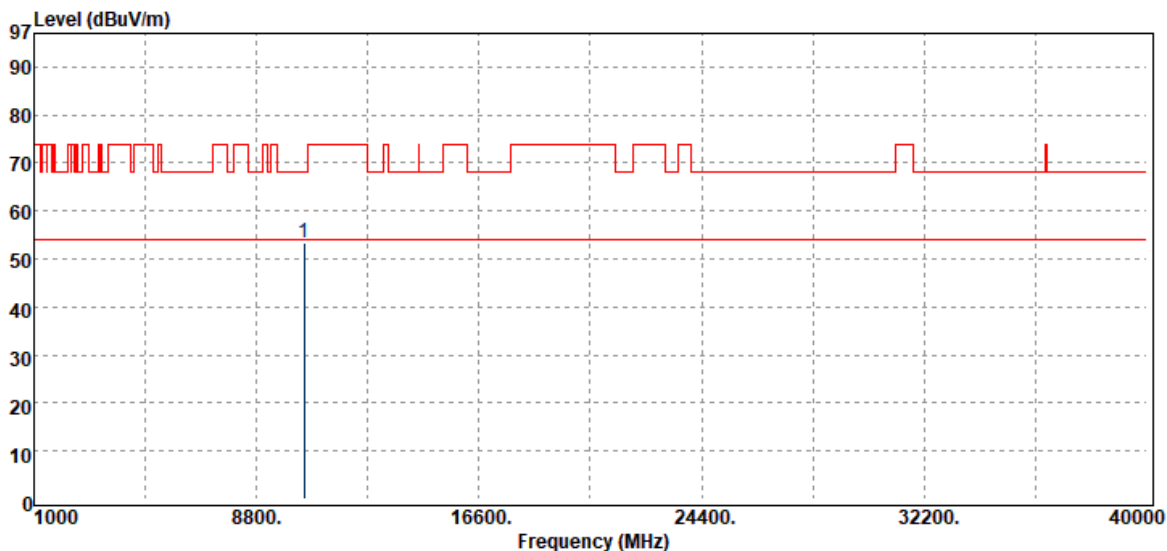

| Freq. MHz | Detector Mode PK/QP/AV | Spectrum Reading Level dB μ V | Factor dB | Actual FS dB μ V/m | Limit @3m dB μ V/m | Margin dB |
|--------------|------------------------------|---|--------------|------------------------------|------------------------------|--------------|
| 10480.00 | Peak | 33.77 | 19.56 | 53.33 | 68.20 | -14.87 |

Unless otherwise stated the results shown in this test report refer only to the sample(s) tested and such sample(s) are retained for 90 days only.

除非另有說明，此報告結果僅對測試之樣品負責，同時此樣品僅保留90天。本報告未經本公司書面許可，不可部份複製。

This document is issued by the Company subject to its General Conditions of Service printed overleaf, available on request or accessible at <http://www.sgs.com.tw/Terms-and-Conditions> and for electronic format documents, subject to Terms and Conditions for Electronic Documents at <http://www.sgs.com.tw/Terms-and-Conditions>. Attention is drawn to the limitation of liability, indemnification and jurisdiction issues defined therein. Any holder of this document is advised that information contained hereon reflects the Company's findings at the time of its intervention only and within the limits of Client's instructions, if any. The Company's sole responsibility is to its Client and this document does not exonerate parties to a transaction from exercising all their rights and obligations under the transaction documents. This document cannot be reproduced except in full, without prior written approval of the Company. Any unauthorized alteration, forgery or falsification of the content or appearance of this document is unlawful and offenders may be prosecuted to the fullest extent of the law.

| | | | |
|----------------|----------------|--------------|------------------|
| Report Number | :ER-2021-20085 | Test Site | :SAC III Chamber |
| Operation Mode | :802.11n20 | Test Date | :2021-03-04 |
| Test Frequency | :5240 MHz | Temp./Humi. | :21.3/62 |
| Test Mode | :Tx CH High | Antenna Pol. | :HORIZONTAL |
| EUT Pol | :H Plane | Engineer | :Ricky |

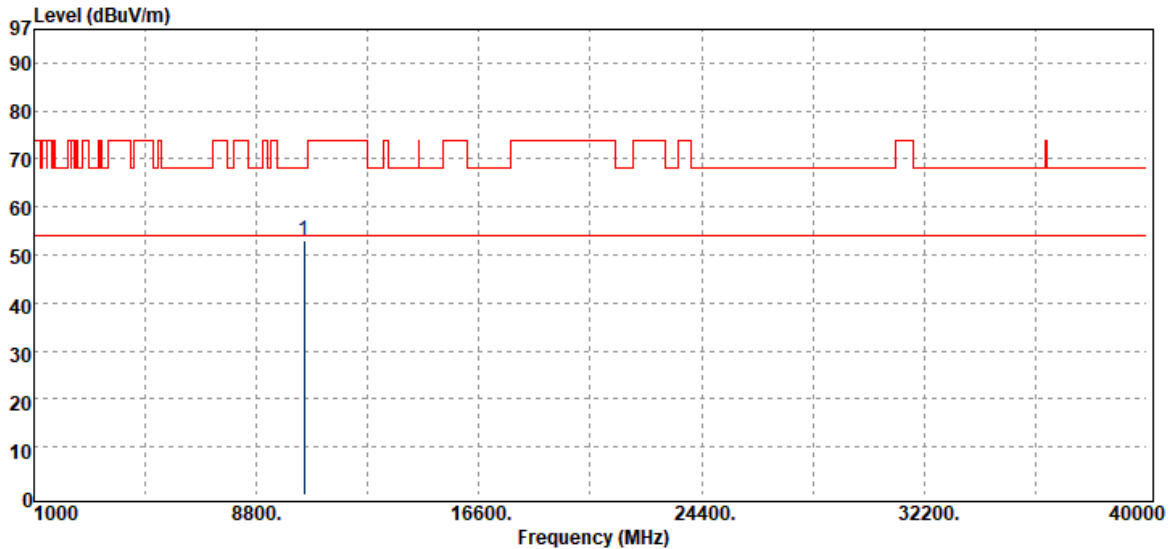

| Freq. MHz | Detector Mode PK/QP/AV | Spectrum Reading Level dB μ V | Factor dB | Actual FS dB μ V/m | Limit @3m dB μ V/m | Margin dB |
|--------------|------------------------------|---|--------------|------------------------------|------------------------------|--------------|
| 10480.00 | Peak | 33.54 | 19.56 | 53.10 | 68.20 | -15.10 |

Unless otherwise stated the results shown in this test report refer only to the sample(s) tested and such sample(s) are retained for 90 days only.

除非另有說明，此報告結果僅對測試之樣品負責，同時此樣品僅保留90天。本報告未經本公司書面許可，不可部份複製。

This document is issued by the Company subject to its General Conditions of Service printed overleaf, available on request or accessible at <http://www.sgs.com.tw/Terms-and-Conditions> and for electronic format documents, subject to Terms and Conditions for Electronic Documents at <http://www.sgs.com.tw/Terms-and-Conditions>. Attention is drawn to the limitation of liability, indemnification and jurisdiction issues defined therein. Any holder of this document is advised that information contained hereon reflects the Company's findings at the time of its intervention only and within the limits of Client's instructions, if any. The Company's sole responsibility is to its Client and this document does not exonerate parties to a transaction from exercising all their rights and obligations under the transaction documents. This document cannot be reproduced except in full, without prior written approval of the Company. Any unauthorized alteration, forgery or falsification of the content or appearance of this document is unlawful and offenders may be prosecuted to the fullest extent of the law.

Report Number :ER-2021-20085
 Operation Mode :802.11n20
 Test Frequency :5260 MHz
 Test Mode :Tx CH Low
 EUT Pol :H Plane

Test Site :SAC III Chamber
 Test Date :2021-03-04
 Temp./Humi. :21.3/62
 Antenna Pol. :VERTICAL
 Engineer :Ricky

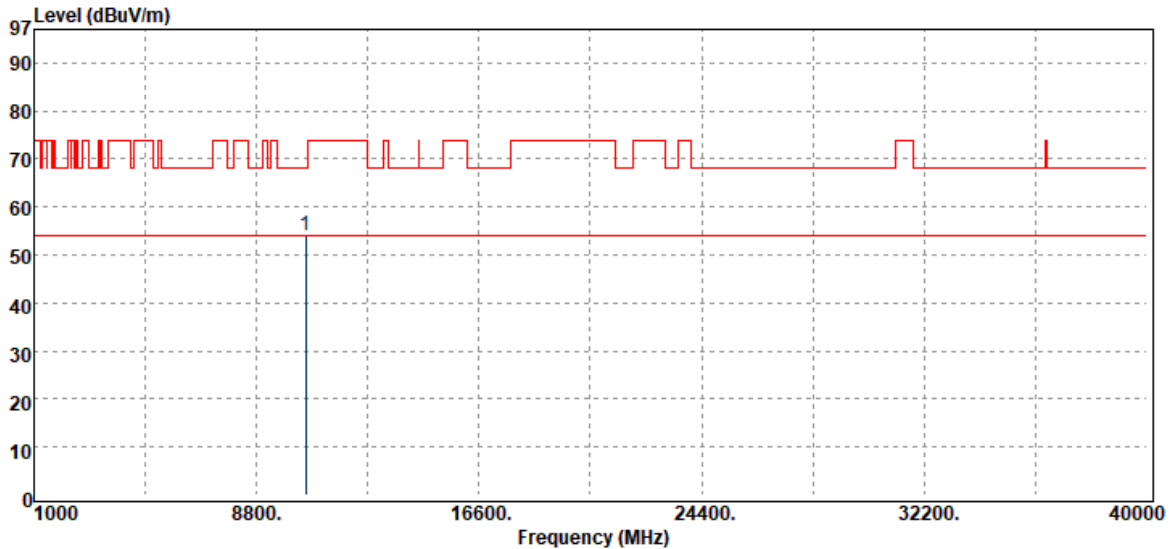

| Freq. MHz | Detector Mode PK/QP/AV | Spectrum Reading Level dB μ V | Factor dB | Actual FS dB μ V/m | Limit @3m dB μ V/m | Margin dB |
|--------------|------------------------------|---|--------------|------------------------------|------------------------------|--------------|
| 10520.00 | Peak | 34.27 | 19.84 | 54.11 | 68.20 | -14.09 |

Unless otherwise stated the results shown in this test report refer only to the sample(s) tested and such sample(s) are retained for 90 days only.

除非另有說明，此報告結果僅對測試之樣品負責，同時此樣品僅保留90天。本報告未經本公司書面許可，不可部份複製。

This document is issued by the Company subject to its General Conditions of Service printed overleaf, available on request or accessible at <http://www.sgs.com.tw/Terms-and-Conditions> and for electronic format documents, subject to Terms and Conditions for Electronic Documents at <http://www.sgs.com.tw/Terms-and-Conditions>. Attention is drawn to the limitation of liability, indemnification and jurisdiction issues defined therein. Any holder of this document is advised that information contained hereon reflects the Company's findings at the time of its intervention only and within the limits of Client's instructions, if any. The Company's sole responsibility is to its Client and this document does not exonerate parties to a transaction from exercising all their rights and obligations under the transaction documents. This document cannot be reproduced except in full, without prior written approval of the Company. Any unauthorized alteration, forgery or falsification of the content or appearance of this document is unlawful and offenders may be prosecuted to the fullest extent of the law.

Report Number :ER-2021-20085
 Operation Mode :802.11n20
 Test Frequency :5260 MHz
 Test Mode :Tx CH Low
 EUT Pol :H Plane

Test Site :SAC III Chamber
 Test Date :2021-03-04
 Temp./Humi. :21.3/62
 Antenna Pol. :HORIZONTAL
 Engineer :Ricky

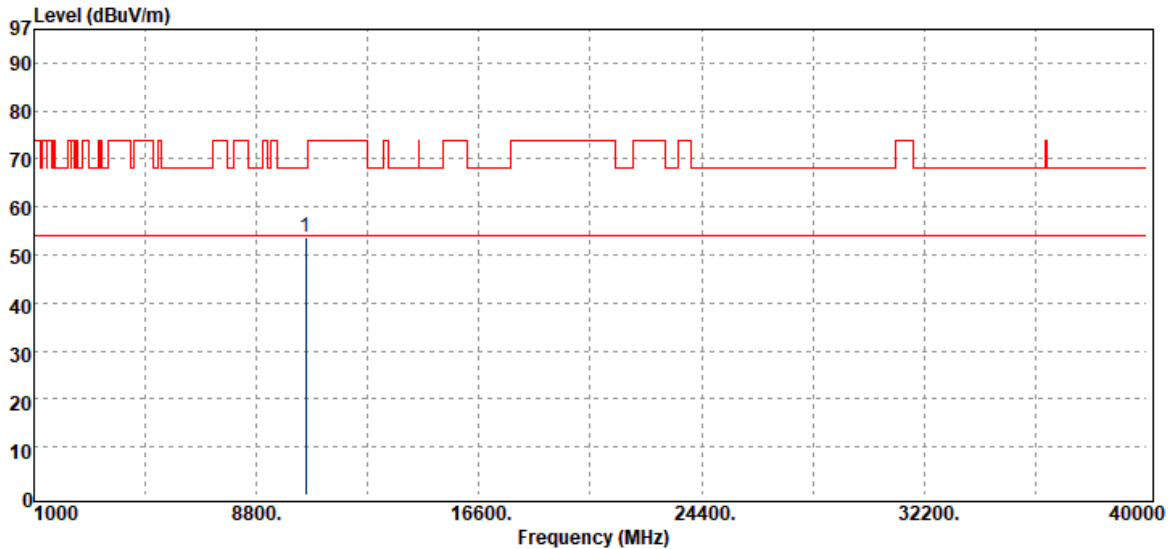

| Freq. MHz | Detector Mode PK/QP/AV | Spectrum Reading Level dB μ V | Factor dB | Actual FS dB μ V/m | Limit @3m dB μ V/m | Margin dB |
|--------------|------------------------------|---|--------------|------------------------------|------------------------------|--------------|
| 10520.00 | Peak | 33.98 | 19.84 | 53.82 | 68.20 | -14.38 |

Unless otherwise stated the results shown in this test report refer only to the sample(s) tested and such sample(s) are retained for 90 days only.

除非另有說明，此報告結果僅對測試之樣品負責，同時此樣品僅保留90天。本報告未經本公司書面許可，不可部份複製。

This document is issued by the Company subject to its General Conditions of Service printed overleaf, available on request or accessible at <http://www.sgs.com.tw/Terms-and-Conditions> and for electronic format documents, subject to Terms and Conditions for Electronic Documents at <http://www.sgs.com.tw/Terms-and-Conditions>. Attention is drawn to the limitation of liability, indemnification and jurisdiction issues defined therein. Any holder of this document is advised that information contained hereon reflects the Company's findings at the time of its intervention only and within the limits of Client's instructions, if any. The Company's sole responsibility is to its Client and this document does not exonerate parties to a transaction from exercising all their rights and obligations under the transaction documents. This document cannot be reproduced except in full, without prior written approval of the Company. Any unauthorized alteration, forgery or falsification of the content or appearance of this document is unlawful and offenders may be prosecuted to the fullest extent of the law.

Report Number :ER-2021-20085
 Operation Mode :802.11n20
 Test Frequency :5300 MHz
 Test Mode :Tx CH Mid
 EUT Pol :H Plane

Test Site :SAC III Chamber
 Test Date :2021-03-04
 Temp./Humi. :21.3/62
 Antenna Pol. :VERTICAL
 Engineer :Ricky

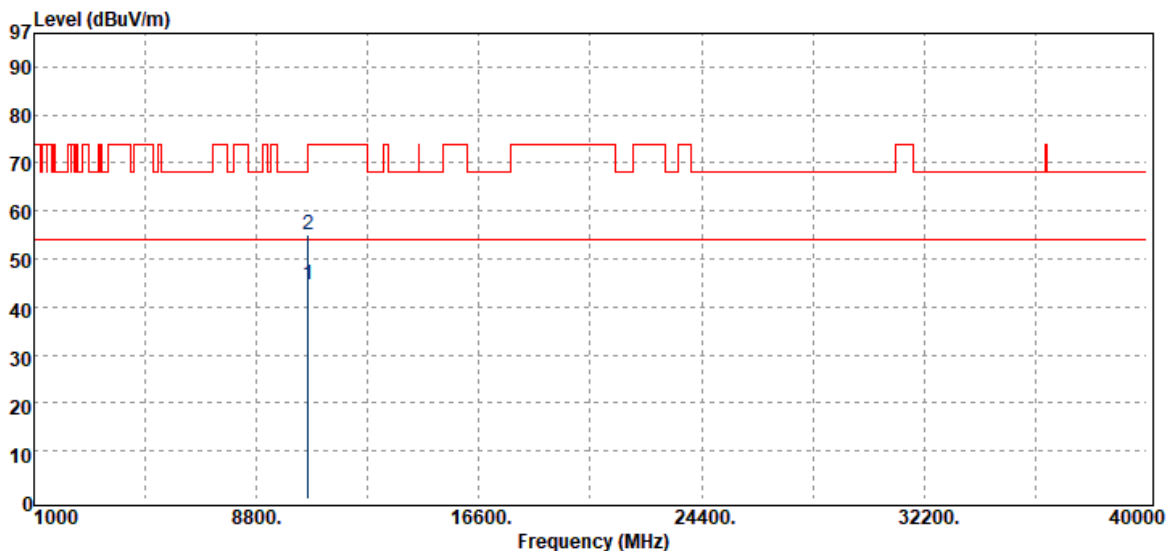

| Freq. MHz | Detector Mode PK/QP/AV | Spectrum Reading Level dB μ V | Factor dB | Actual FS dB μ V/m | Limit @3m dB μ V/m | Margin dB |
|--------------|------------------------------|---|--------------|------------------------------|------------------------------|--------------|
| 10600.00 | Average | 24.83 | 19.86 | 44.69 | 54.00 | -9.31 |
| 10600.00 | Peak | 35.16 | 19.86 | 55.02 | 74.00 | -18.98 |

Unless otherwise stated the results shown in this test report refer only to the sample(s) tested and such sample(s) are retained for 90 days only.

除非另有說明，此報告結果僅對測試之樣品負責，同時此樣品僅保留90天。本報告未經本公司書面許可，不可部份複製。

This document is issued by the Company subject to its General Conditions of Service printed overleaf, available on request or accessible at <http://www.sgs.com.tw/Terms-and-Conditions> and for electronic format documents, subject to Terms and Conditions for Electronic Documents at <http://www.sgs.com.tw/Terms-and-Conditions>. Attention is drawn to the limitation of liability, indemnification and jurisdiction issues defined therein. Any holder of this document is advised that information contained hereon reflects the Company's findings at the time of its intervention only and within the limits of Client's instructions, if any. The Company's sole responsibility is to its Client and this document does not exonerate parties to a transaction from exercising all their rights and obligations under the transaction documents. This document cannot be reproduced except in full, without prior written approval of the Company. Any unauthorized alteration, forgery or falsification of the content or appearance of this document is unlawful and offenders may be prosecuted to the fullest extent of the law.

Report Number :ER-2021-20085
 Operation Mode :802.11n20
 Test Frequency :5300 MHz
 Test Mode :Tx CH Mid
 EUT Pol :H Plane

Test Site :SAC III Chamber
 Test Date :2021-03-04
 Temp./Humi. :21.3/62
 Antenna Pol. :HORIZONTAL
 Engineer :Ricky

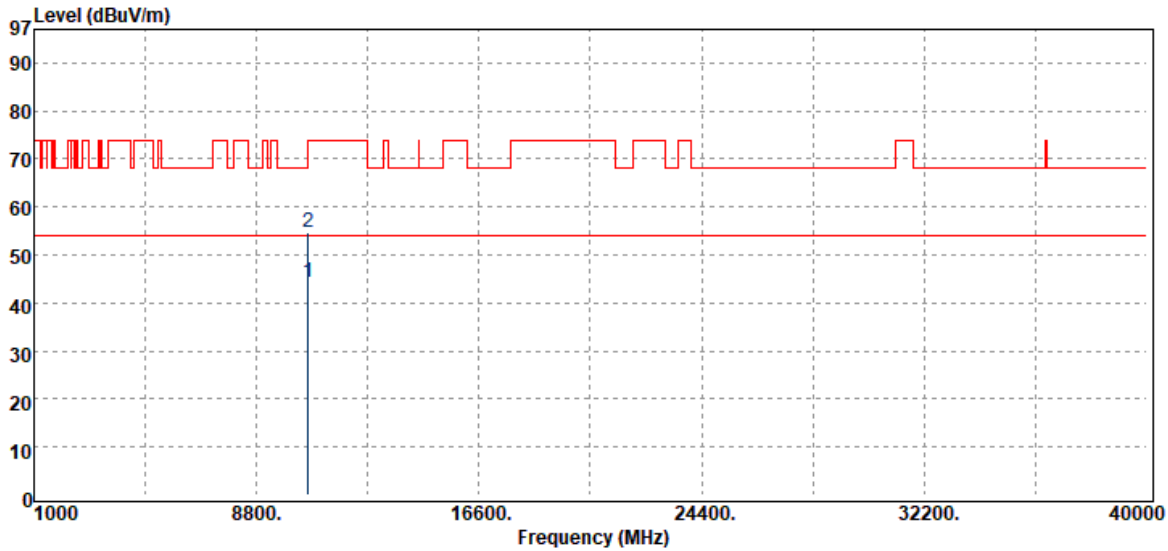

| Freq. MHz | Detector Mode PK/QP/AV | Spectrum Reading Level dB μ V | Factor dB | Actual FS dB μ V/m | Limit @3m dB μ V/m | Margin dB |
|--------------|------------------------------|---|--------------|------------------------------|------------------------------|--------------|
| 10600.00 | Average | 24.47 | 19.86 | 44.33 | 54.00 | -9.67 |
| 10600.00 | Peak | 34.78 | 19.86 | 54.64 | 74.00 | -19.36 |

Unless otherwise stated the results shown in this test report refer only to the sample(s) tested and such sample(s) are retained for 90 days only.

除非另有說明，此報告結果僅對測試之樣品負責，同時此樣品僅保留90天。本報告未經本公司書面許可，不可部份複製。

This document is issued by the Company subject to its General Conditions of Service printed overleaf, available on request or accessible at <http://www.sgs.com.tw/Terms-and-Conditions> and for electronic format documents, subject to Terms and Conditions for Electronic Documents at <http://www.sgs.com.tw/Terms-and-Conditions>. Attention is drawn to the limitation of liability, indemnification and jurisdiction issues defined therein. Any holder of this document is advised that information contained hereon reflects the Company's findings at the time of its intervention only and within the limits of Client's instructions, if any. The Company's sole responsibility is to its Client and this document does not exonerate parties to a transaction from exercising all their rights and obligations under the transaction documents. This document cannot be reproduced except in full, without prior written approval of the Company. Any unauthorized alteration, forgery or falsification of the content or appearance of this document is unlawful and offenders may be prosecuted to the fullest extent of the law.

Report Number :ER-2021-20085
 Operation Mode :802.11n20
 Test Frequency :5320 MHz
 Test Mode :Tx CH High
 EUT Pol :H Plane

Test Site :SAC III Chamber
 Test Date :2021-03-04
 Temp./Humi. :21.3/62
 Antenna Pol. :VERTICAL
 Engineer :Ricky

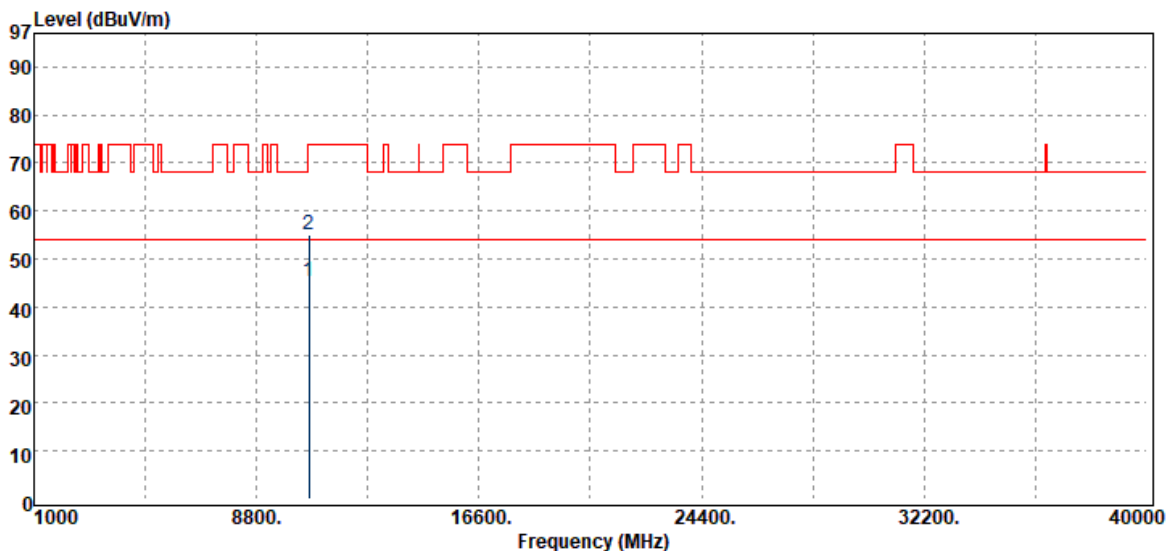

| Freq. MHz | Detector Mode PK/QP/AV | Spectrum Reading Level dB μ V | Factor dB | Actual FS dB μ V/m | Limit @3m dB μ V/m | Margin dB |
|--------------|------------------------------|---|--------------|------------------------------|------------------------------|--------------|
| 10640.00 | Average | 24.86 | 20.37 | 45.23 | 54.00 | -8.77 |
| 10640.00 | Peak | 34.63 | 20.37 | 55.00 | 74.00 | -19.00 |

Unless otherwise stated the results shown in this test report refer only to the sample(s) tested and such sample(s) are retained for 90 days only.

除非另有說明，此報告結果僅對測試之樣品負責，同時此樣品僅保留90天。本報告未經本公司書面許可，不可部份複製。

This document is issued by the Company subject to its General Conditions of Service printed overleaf, available on request or accessible at <http://www.sgs.com.tw/Terms-and-Conditions> and for electronic format documents, subject to Terms and Conditions for Electronic Documents at <http://www.sgs.com.tw/Terms-and-Conditions>. Attention is drawn to the limitation of liability, indemnification and jurisdiction issues defined therein. Any holder of this document is advised that information contained hereon reflects the Company's findings at the time of its intervention only and within the limits of Client's instructions, if any. The Company's sole responsibility is to its Client and this document does not exonerate parties to a transaction from exercising all their rights and obligations under the transaction documents. This document cannot be reproduced except in full, without prior written approval of the Company. Any unauthorized alteration, forgery or falsification of the content or appearance of this document is unlawful and offenders may be prosecuted to the fullest extent of the law.

Report Number :ER-2021-20085
 Operation Mode :802.11n20
 Test Frequency :5320 MHz
 Test Mode :Tx CH High
 EUT Pol :H Plane

Test Site :SAC III Chamber
 Test Date :2021-03-04
 Temp./Humi. :21.3/62
 Antenna Pol. :HORIZONTAL
 Engineer :Ricky

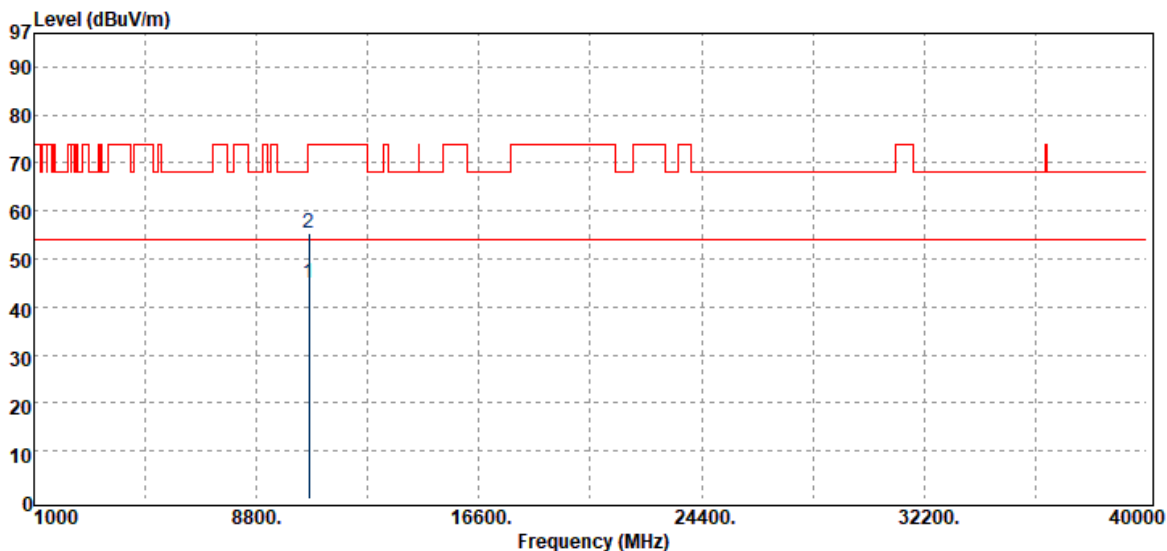

| Freq. MHz | Detector Mode PK/QP/AV | Spectrum Reading Level dB μ V | Factor dB | Actual FS dB μ V/m | Limit @3m dB μ V/m | Margin dB |
|--------------|------------------------------|---|--------------|------------------------------|------------------------------|--------------|
| 10640.00 | Average | 24.73 | 20.37 | 45.10 | 54.00 | -8.90 |
| 10640.00 | Peak | 34.86 | 20.37 | 55.23 | 74.00 | -18.77 |

Unless otherwise stated the results shown in this test report refer only to the sample(s) tested and such sample(s) are retained for 90 days only.

除非另有說明，此報告結果僅對測試之樣品負責，同時此樣品僅保留90天。本報告未經本公司書面許可，不可部份複製。

This document is issued by the Company subject to its General Conditions of Service printed overleaf, available on request or accessible at <http://www.sgs.com.tw/Terms-and-Conditions> and for electronic format documents, subject to Terms and Conditions for Electronic Documents at <http://www.sgs.com.tw/Terms-and-Conditions>. Attention is drawn to the limitation of liability, indemnification and jurisdiction issues defined therein. Any holder of this document is advised that information contained hereon reflects the Company's findings at the time of its intervention only and within the limits of Client's instructions, if any. The Company's sole responsibility is to its Client and this document does not exonerate parties to a transaction from exercising all their rights and obligations under the transaction documents. This document cannot be reproduced except in full, without prior written approval of the Company. Any unauthorized alteration, forgery or falsification of the content or appearance of this document is unlawful and offenders may be prosecuted to the fullest extent of the law.

Report Number :ER-2021-20085
 Operation Mode :802.11n20
 Test Frequency :5500 MHz
 Test Mode :Tx CH Low
 EUT Pol :H Plane

Test Site :SAC III Chamber
 Test Date :2021-03-04
 Temp./Humi. :21.3/62
 Antenna Pol. :VERTICAL
 Engineer :Ricky

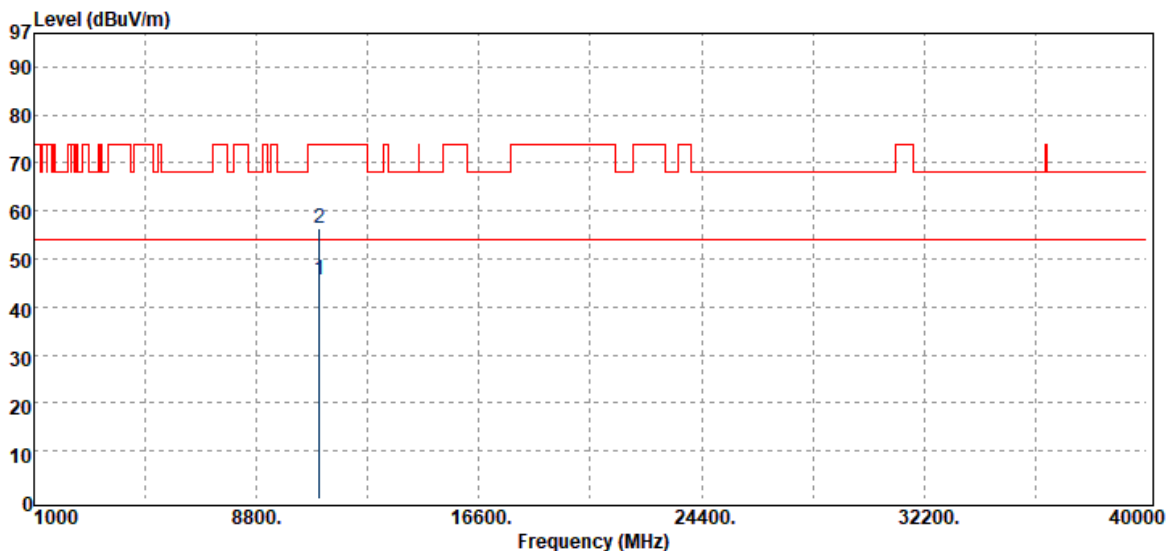

| Freq. MHz | Detector Mode PK/QP/AV | Spectrum Reading Level dB μ V | Factor dB | Actual FS dB μ V/m | Limit @3m dB μ V/m | Margin dB |
|--------------|------------------------------|---|--------------|------------------------------|------------------------------|--------------|
| 11000.00 | Average | 24.72 | 20.90 | 45.62 | 54.00 | -8.38 |
| 11000.00 | Peak | 35.50 | 20.90 | 56.40 | 74.00 | -17.60 |

Unless otherwise stated the results shown in this test report refer only to the sample(s) tested and such sample(s) are retained for 90 days only.

除非另有說明，此報告結果僅對測試之樣品負責，同時此樣品僅保留90天。本報告未經本公司書面許可，不可部份複製。

This document is issued by the Company subject to its General Conditions of Service printed overleaf, available on request or accessible at <http://www.sgs.com.tw/Terms-and-Conditions> and for electronic format documents, subject to Terms and Conditions for Electronic Documents at <http://www.sgs.com.tw/Terms-and-Conditions>. Attention is drawn to the limitation of liability, indemnification and jurisdiction issues defined therein. Any holder of this document is advised that information contained hereon reflects the Company's findings at the time of its intervention only and within the limits of Client's instructions, if any. The Company's sole responsibility is to its Client and this document does not exonerate parties to a transaction from exercising all their rights and obligations under the transaction documents. This document cannot be reproduced except in full, without prior written approval of the Company. Any unauthorized alteration, forgery or falsification of the content or appearance of this document is unlawful and offenders may be prosecuted to the fullest extent of the law.

Report Number :ER-2021-20085
 Operation Mode :802.11n20
 Test Frequency :5500 MHz
 Test Mode :Tx CH Low
 EUT Pol :H Plane

Test Site :SAC III Chamber
 Test Date :2021-03-04
 Temp./Humi. :21.3/62
 Antenna Pol. :HORIZONTAL
 Engineer :Ricky

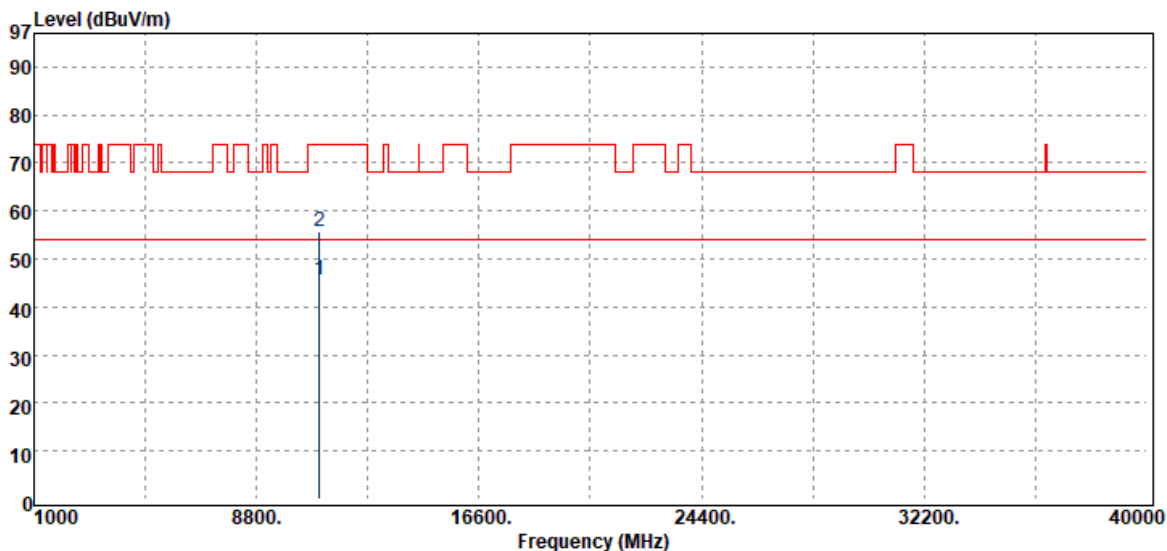

| Freq. MHz | Detector Mode PK/QP/AV | Spectrum Reading Level dB μ V | Factor dB | Actual FS dB μ V/m | Limit @3m dB μ V/m | Margin dB |
|--------------|------------------------------|---|--------------|------------------------------|------------------------------|--------------|
| 11000.00 | Average | 24.61 | 20.90 | 45.51 | 54.00 | -8.49 |
| 11000.00 | Peak | 34.97 | 20.90 | 55.87 | 74.00 | -18.13 |

Unless otherwise stated the results shown in this test report refer only to the sample(s) tested and such sample(s) are retained for 90 days only.

除非另有說明，此報告結果僅對測試之樣品負責，同時此樣品僅保留90天。本報告未經本公司書面許可，不可部份複製。

This document is issued by the Company subject to its General Conditions of Service printed overleaf, available on request or accessible at <http://www.sgs.com.tw/Terms-and-Conditions> and for electronic format documents, subject to Terms and Conditions for Electronic Documents at <http://www.sgs.com.tw/Terms-and-Conditions>. Attention is drawn to the limitation of liability, indemnification and jurisdiction issues defined therein. Any holder of this document is advised that information contained hereon reflects the Company's findings at the time of its intervention only and within the limits of Client's instructions, if any. The Company's sole responsibility is to its Client and this document does not exonerate parties to a transaction from exercising all their rights and obligations under the transaction documents. This document cannot be reproduced except in full, without prior written approval of the Company. Any unauthorized alteration, forgery or falsification of the content or appearance of this document is unlawful and offenders may be prosecuted to the fullest extent of the law.

Report Number :ER-2021-20085
 Operation Mode :802.11n20
 Test Frequency :5580 MHz
 Test Mode :Tx CH Mid
 EUT Pol :H Plane

Test Site :SAC III Chamber
 Test Date :2021-03-04
 Temp./Humi. :21.3/62
 Antenna Pol. :VERTICAL
 Engineer :Ricky

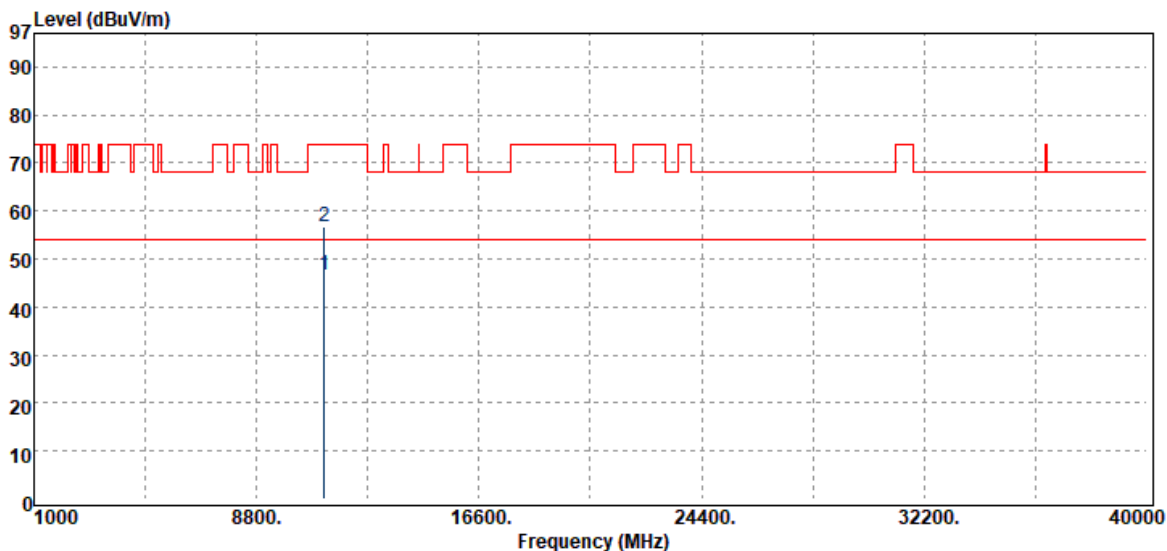

| Freq. MHz | Detector Mode PK/QP/AV | Spectrum Reading Level dB μ V | Factor dB | Actual FS dB μ V/m | Limit @3m dB μ V/m | Margin dB |
|--------------|------------------------------|---|--------------|------------------------------|------------------------------|--------------|
| 11160.00 | Average | 24.91 | 21.60 | 46.51 | 54.00 | -7.49 |
| 11160.00 | Peak | 35.05 | 21.60 | 56.65 | 74.00 | -17.35 |

Unless otherwise stated the results shown in this test report refer only to the sample(s) tested and such sample(s) are retained for 90 days only.

除非另有說明，此報告結果僅對測試之樣品負責，同時此樣品僅保留90天。本報告未經本公司書面許可，不可部份複製。

This document is issued by the Company subject to its General Conditions of Service printed overleaf, available on request or accessible at <http://www.sgs.com.tw/Terms-and-Conditions> and for electronic format documents, subject to Terms and Conditions for Electronic Documents at <http://www.sgs.com.tw/Terms-and-Conditions>. Attention is drawn to the limitation of liability, indemnification and jurisdiction issues defined therein. Any holder of this document is advised that information contained hereon reflects the Company's findings at the time of its intervention only and within the limits of Client's instructions, if any. The Company's sole responsibility is to its Client and this document does not exonerate parties to a transaction from exercising all their rights and obligations under the transaction documents. This document cannot be reproduced except in full, without prior written approval of the Company. Any unauthorized alteration, forgery or falsification of the content or appearance of this document is unlawful and offenders may be prosecuted to the fullest extent of the law.

Report Number :ER-2021-20085
 Operation Mode :802.11n20
 Test Frequency :5580 MHz
 Test Mode :Tx CH Mid
 EUT Pol :H Plane

Test Site :SAC III Chamber
 Test Date :2021-03-04
 Temp./Humi. :21.3/62
 Antenna Pol. :HORIZONTAL
 Engineer :Ricky

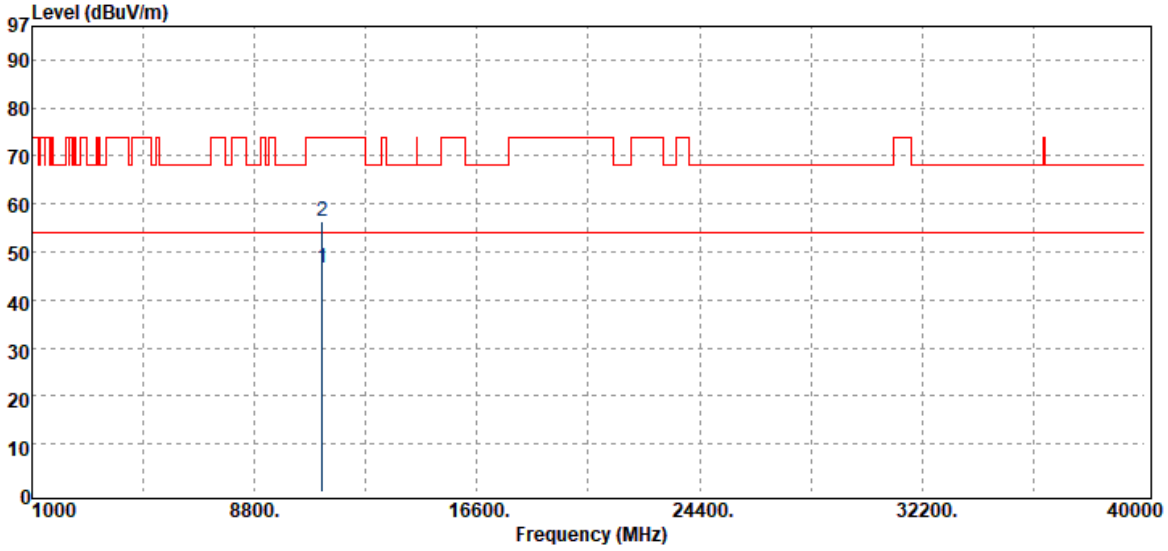

| Freq. MHz | Detector Mode PK/QP/AV | Spectrum Reading Level dB μ V | Factor dB | Actual FS dB μ V/m | Limit @3m dB μ V/m | Margin dB |
|--------------|------------------------------|---|--------------|------------------------------|------------------------------|--------------|
| 11160.00 | Average | 24.91 | 21.60 | 46.51 | 54.00 | -7.49 |
| 11160.00 | Peak | 34.78 | 21.60 | 56.38 | 74.00 | -17.62 |

Unless otherwise stated the results shown in this test report refer only to the sample(s) tested and such sample(s) are retained for 90 days only.

除非另有說明，此報告結果僅對測試之樣品負責，同時此樣品僅保留90天。本報告未經本公司書面許可，不可部份複製。

This document is issued by the Company subject to its General Conditions of Service printed overleaf, available on request or accessible at <http://www.sgs.com.tw/Terms-and-Conditions> and for electronic format documents, subject to Terms and Conditions for Electronic Documents at <http://www.sgs.com.tw/Terms-and-Conditions>. Attention is drawn to the limitation of liability, indemnification and jurisdiction issues defined therein. Any holder of this document is advised that information contained hereon reflects the Company's findings at the time of its intervention only and within the limits of Client's instructions, if any. The Company's sole responsibility is to its Client and this document does not exonerate parties to a transaction from exercising all their rights and obligations under the transaction documents. This document cannot be reproduced except in full, without prior written approval of the Company. Any unauthorized alteration, forgery or falsification of the content or appearance of this document is unlawful and offenders may be prosecuted to the fullest extent of the law.

Report Number :ER-2021-20085
 Operation Mode :802.11n20
 Test Frequency :5700 MHz
 Test Mode :Tx CH High
 EUT Pol :H Plane

Test Site :SAC III Chamber
 Test Date :2021-03-04
 Temp./Humi. :21.3/62
 Antenna Pol. :VERTICAL
 Engineer :Ricky

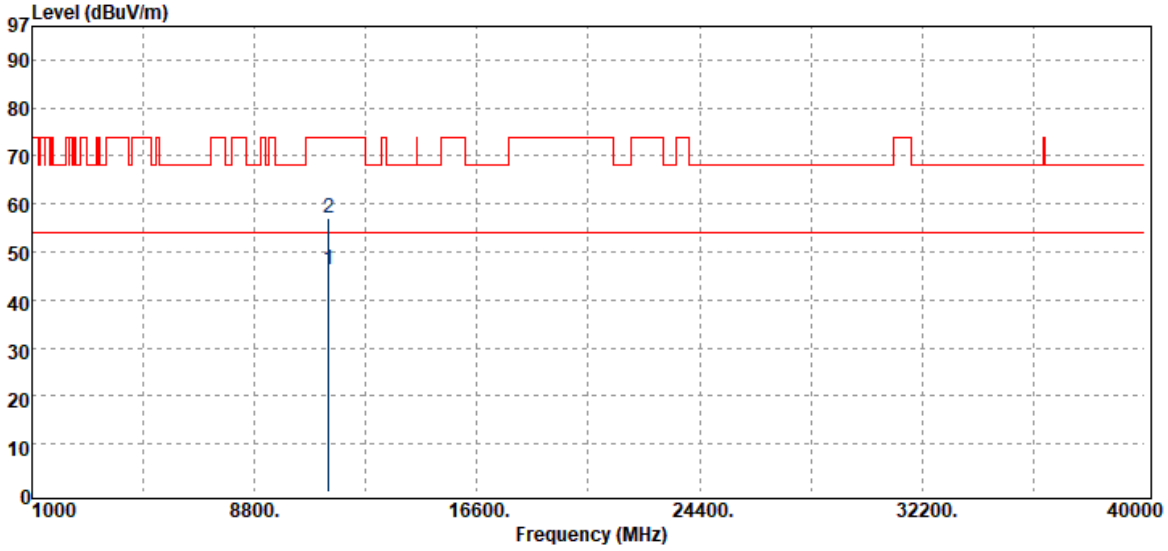

| Freq. MHz | Detector Mode PK/QP/AV | Spectrum Reading Level dB μ V | Factor dB | Actual FS dB μ V/m | Limit @3m dB μ V/m | Margin dB |
|--------------|------------------------------|---|--------------|------------------------------|------------------------------|--------------|
| 11400.00 | Average | 24.71 | 21.51 | 46.22 | 54.00 | -7.78 |
| 11400.00 | Peak | 35.47 | 21.51 | 56.98 | 74.00 | -17.02 |

Unless otherwise stated the results shown in this test report refer only to the sample(s) tested and such sample(s) are retained for 90 days only.

除非另有說明，此報告結果僅對測試之樣品負責，同時此樣品僅保留90天。本報告未經本公司書面許可，不可部份複製。

This document is issued by the Company subject to its General Conditions of Service printed overleaf, available on request or accessible at <http://www.sgs.com.tw/Terms-and-Conditions> and for electronic format documents, subject to Terms and Conditions for Electronic Documents at <http://www.sgs.com.tw/Terms-and-Conditions>. Attention is drawn to the limitation of liability, indemnification and jurisdiction issues defined therein. Any holder of this document is advised that information contained hereon reflects the Company's findings at the time of its intervention only and within the limits of Client's instructions, if any. The Company's sole responsibility is to its Client and this document does not exonerate parties to a transaction from exercising all their rights and obligations under the transaction documents. This document cannot be reproduced except in full, without prior written approval of the Company. Any unauthorized alteration, forgery or falsification of the content or appearance of this document is unlawful and offenders may be prosecuted to the fullest extent of the law.

Report Number :ER-2021-20085
 Operation Mode :802.11n20
 Test Frequency :5700 MHz
 Test Mode :Tx CH High
 EUT Pol :H Plane

Test Site :SAC III Chamber
 Test Date :2021-03-04
 Temp./Humi. :21.3/62
 Antenna Pol. :HORIZONTAL
 Engineer :Ricky

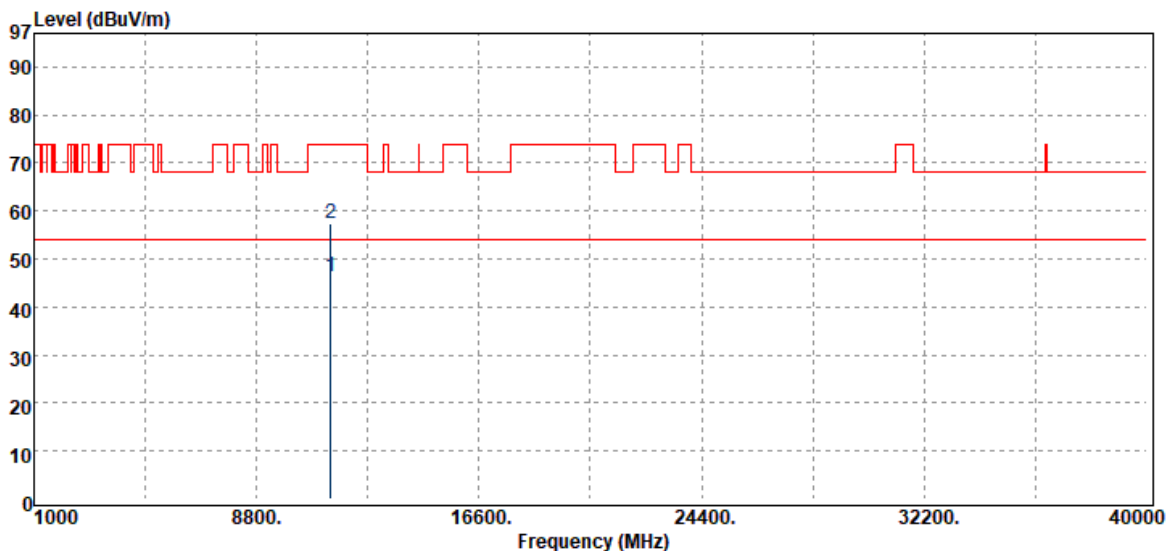

| Freq. MHz | Detector Mode PK/QP/AV | Spectrum Reading Level dB μ V | Factor dB | Actual FS dB μ V/m | Limit @3m dB μ V/m | Margin dB |
|--------------|------------------------------|---|--------------|------------------------------|------------------------------|--------------|
| 11400.00 | Average | 24.65 | 21.51 | 46.16 | 54.00 | -7.84 |
| 11400.00 | Peak | 35.96 | 21.51 | 57.47 | 74.00 | -16.53 |

Unless otherwise stated the results shown in this test report refer only to the sample(s) tested and such sample(s) are retained for 90 days only.

除非另有說明，此報告結果僅對測試之樣品負責，同時此樣品僅保留90天。本報告未經本公司書面許可，不可部份複製。

This document is issued by the Company subject to its General Conditions of Service printed overleaf, available on request or accessible at <http://www.sgs.com.tw/Terms-and-Conditions> and for electronic format documents, subject to Terms and Conditions for Electronic Documents at <http://www.sgs.com.tw/Terms-and-Conditions>. Attention is drawn to the limitation of liability, indemnification and jurisdiction issues defined therein. Any holder of this document is advised that information contained hereon reflects the Company's findings at the time of its intervention only and within the limits of Client's instructions, if any. The Company's sole responsibility is to its Client and this document does not exonerate parties to a transaction from exercising all their rights and obligations under the transaction documents. This document cannot be reproduced except in full, without prior written approval of the Company. Any unauthorized alteration, forgery or falsification of the content or appearance of this document is unlawful and offenders may be prosecuted to the fullest extent of the law.

Report Number :ER-2021-20085
 Operation Mode :802.11n20
 Test Frequency :5720 MHz
 Test Mode :Tx CH High
 EUT Pol :H Plane

Test Site :SAC III Chamber
 Test Date :2021-03-04
 Temp./Humi. :21.3/62
 Antenna Pol. :VERTICAL
 Engineer :Ricky

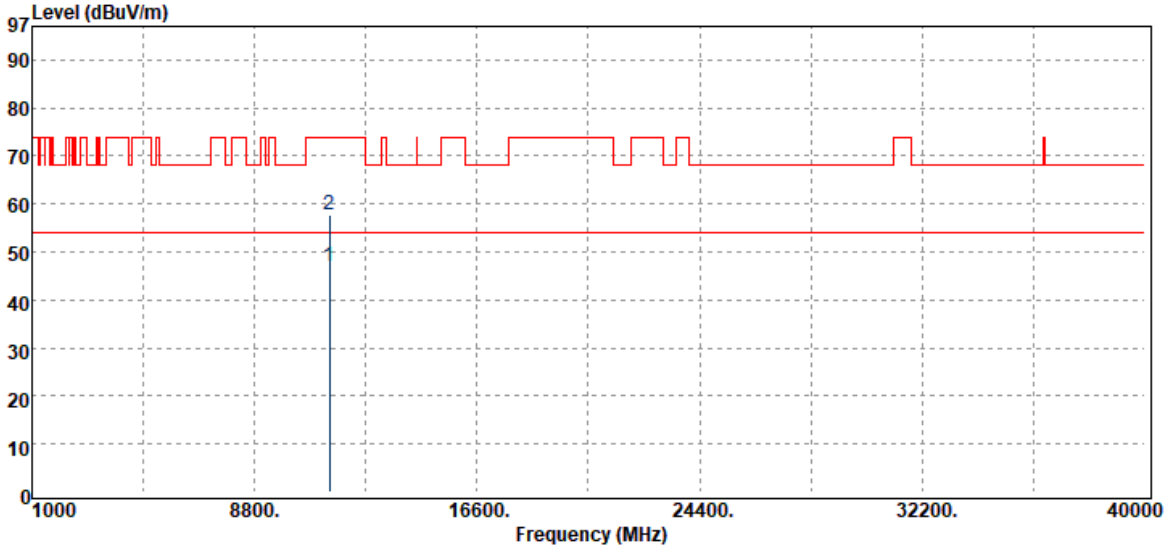

| Freq. MHz | Detector Mode PK/QP/AV | Spectrum Reading Level dB μ V | Factor dB | Actual FS dB μ V/m | Limit @3m dB μ V/m | Margin dB |
|--------------|------------------------------|---|--------------|------------------------------|------------------------------|--------------|
| 11440.00 | Average | 24.35 | 22.75 | 47.10 | 54.00 | -6.90 |
| 11440.00 | Peak | 34.99 | 22.75 | 57.74 | 74.00 | -16.26 |

Unless otherwise stated the results shown in this test report refer only to the sample(s) tested and such sample(s) are retained for 90 days only.

除非另有說明，此報告結果僅對測試之樣品負責，同時此樣品僅保留90天。本報告未經本公司書面許可，不可部份複製。

This document is issued by the Company subject to its General Conditions of Service printed overleaf, available on request or accessible at <http://www.sgs.com.tw/Terms-and-Conditions> and for electronic format documents, subject to Terms and Conditions for Electronic Documents at <http://www.sgs.com.tw/Terms-and-Conditions>. Attention is drawn to the limitation of liability, indemnification and jurisdiction issues defined therein. Any holder of this document is advised that information contained hereon reflects the Company's findings at the time of its intervention only and within the limits of Client's instructions, if any. The Company's sole responsibility is to its Client and this document does not exonerate parties to a transaction from exercising all their rights and obligations under the transaction documents. This document cannot be reproduced except in full, without prior written approval of the Company. Any unauthorized alteration, forgery or falsification of the content or appearance of this document is unlawful and offenders may be prosecuted to the fullest extent of the law.

Report Number :ER-2021-20085
 Operation Mode :802.11n20
 Test Frequency :5720 MHz
 Test Mode :Tx CH High
 EUT Pol :H Plane

Test Site :SAC III Chamber
 Test Date :2021-03-04
 Temp./Humi. :21.3/62
 Antenna Pol. :HORIZONTAL
 Engineer :Ricky

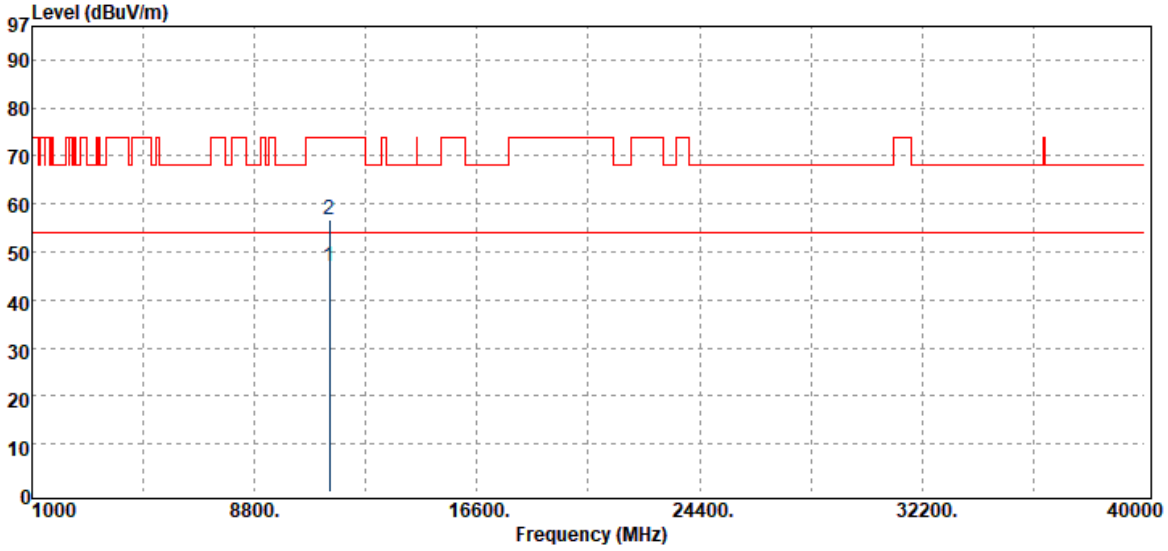

| Freq. MHz | Detector Mode PK/QP/AV | Spectrum Reading Level dB μ V | Factor dB | Actual FS dB μ V/m | Limit @3m dB μ V/m | Margin dB |
|--------------|------------------------------|---|--------------|------------------------------|------------------------------|--------------|
| 11440.00 | Average | 24.32 | 22.75 | 47.07 | 54.00 | -6.93 |
| 11440.00 | Peak | 33.89 | 22.75 | 56.64 | 74.00 | -17.36 |

Unless otherwise stated the results shown in this test report refer only to the sample(s) tested and such sample(s) are retained for 90 days only.

除非另有說明，此報告結果僅對測試之樣品負責，同時此樣品僅保留90天。本報告未經本公司書面許可，不可部份複製。

This document is issued by the Company subject to its General Conditions of Service printed overleaf, available on request or accessible at <http://www.sgs.com.tw/Terms-and-Conditions> and for electronic format documents, subject to Terms and Conditions for Electronic Documents at <http://www.sgs.com.tw/Terms-and-Conditions>. Attention is drawn to the limitation of liability, indemnification and jurisdiction issues defined therein. Any holder of this document is advised that information contained hereon reflects the Company's findings at the time of its intervention only and within the limits of Client's instructions, if any. The Company's sole responsibility is to its Client and this document does not exonerate parties to a transaction from exercising all their rights and obligations under the transaction documents. This document cannot be reproduced except in full, without prior written approval of the Company. Any unauthorized alteration, forgery or falsification of the content or appearance of this document is unlawful and offenders may be prosecuted to the fullest extent of the law.

Report Number :ER-2021-20085
 Operation Mode :802.11n20
 Test Frequency :5745 MHz
 Test Mode :Tx CH Low
 EUT Pol :H Plane

Test Site :SAC III Chamber
 Test Date :2021-03-04
 Temp./Humi. :21.3/62
 Antenna Pol. :VERTICAL
 Engineer :Ricky

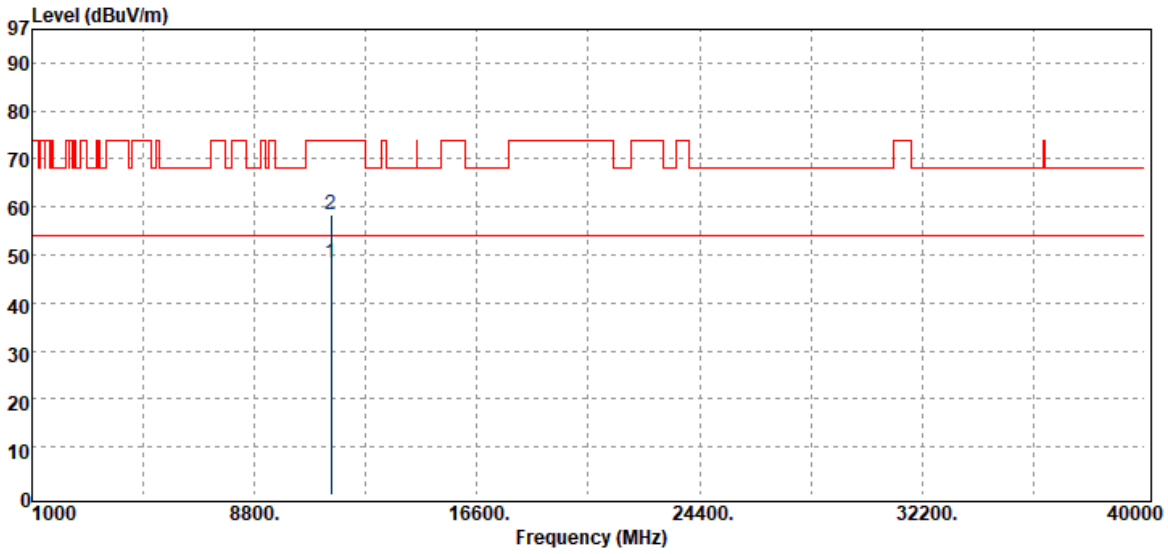

| Freq. MHz | Detector Mode PK/QP/AV | Spectrum Reading Level dB μ V | Factor dB | Actual FS dB μ V/m | Limit @3m dB μ V/m | Margin dB |
|--------------|------------------------------|---|--------------|------------------------------|------------------------------|--------------|
| 11490.00 | Average | 23.97 | 24.41 | 48.38 | 54.00 | -5.62 |
| 11490.00 | Peak | 33.85 | 24.41 | 58.26 | 74.00 | -15.74 |

Unless otherwise stated the results shown in this test report refer only to the sample(s) tested and such sample(s) are retained for 90 days only.

除非另有說明，此報告結果僅對測試之樣品負責，同時此樣品僅保留90天。本報告未經本公司書面許可，不可部份複製。

This document is issued by the Company subject to its General Conditions of Service printed overleaf, available on request or accessible at <http://www.sgs.com.tw/Terms-and-Conditions> and for electronic format documents, subject to Terms and Conditions for Electronic Documents at <http://www.sgs.com.tw/Terms-and-Conditions>. Attention is drawn to the limitation of liability, indemnification and jurisdiction issues defined therein. Any holder of this document is advised that information contained hereon reflects the Company's findings at the time of its intervention only and within the limits of Client's instructions, if any. The Company's sole responsibility is to its Client and this document does not exonerate parties to a transaction from exercising all their rights and obligations under the transaction documents. This document cannot be reproduced except in full, without prior written approval of the Company. Any unauthorized alteration, forgery or falsification of the content or appearance of this document is unlawful and offenders may be prosecuted to the fullest extent of the law.

Report Number :ER-2021-20085
 Operation Mode :802.11n20
 Test Frequency :5745 MHz
 Test Mode :Tx CH Low
 EUT Pol :H Plane

Test Site :SAC III Chamber
 Test Date :2021-03-04
 Temp./Humi. :21.3/62
 Antenna Pol. :HORIZONTAL
 Engineer :Ricky

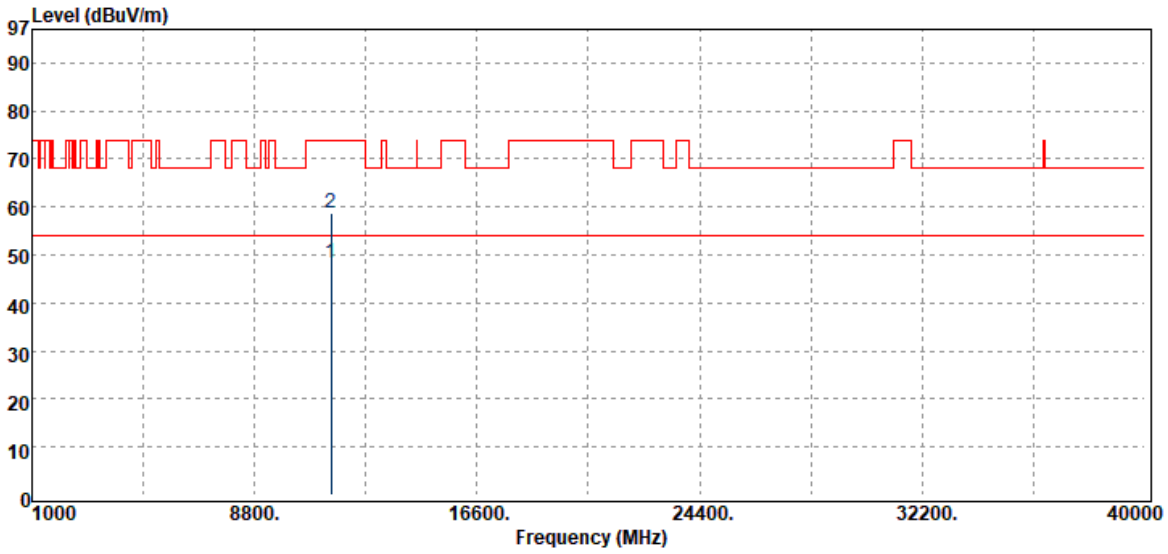

| Freq. MHz | Detector Mode PK/QP/AV | Spectrum Reading Level dB μ V | Factor dB | Actual FS dB μ V/m | Limit @3m dB μ V/m | Margin dB |
|--------------|------------------------------|---|--------------|------------------------------|------------------------------|--------------|
| 11490.00 | Average | 23.85 | 24.41 | 48.26 | 54.00 | -5.74 |
| 11490.00 | Peak | 34.35 | 24.41 | 58.76 | 74.00 | -15.24 |

Unless otherwise stated the results shown in this test report refer only to the sample(s) tested and such sample(s) are retained for 90 days only.

除非另有說明，此報告結果僅對測試之樣品負責，同時此樣品僅保留90天。本報告未經本公司書面許可，不可部份複製。

This document is issued by the Company subject to its General Conditions of Service printed overleaf, available on request or accessible at <http://www.sgs.com.tw/Terms-and-Conditions> and for electronic format documents, subject to Terms and Conditions for Electronic Documents at <http://www.sgs.com.tw/Terms-and-Conditions>. Attention is drawn to the limitation of liability, indemnification and jurisdiction issues defined therein. Any holder of this document is advised that information contained hereon reflects the Company's findings at the time of its intervention only and within the limits of Client's instructions, if any. The Company's sole responsibility is to its Client and this document does not exonerate parties to a transaction from exercising all their rights and obligations under the transaction documents. This document cannot be reproduced except in full, without prior written approval of the Company. Any unauthorized alteration, forgery or falsification of the content or appearance of this document is unlawful and offenders may be prosecuted to the fullest extent of the law.

Report Number :ER-2021-20085
 Operation Mode :802.11n20
 Test Frequency :5785 MHz
 Test Mode :Tx CH Mid
 EUT Pol :H Plane

Test Site :SAC III Chamber
 Test Date :2021-03-04
 Temp./Humi. :21.3/62
 Antenna Pol. :VERTICAL
 Engineer :Ricky

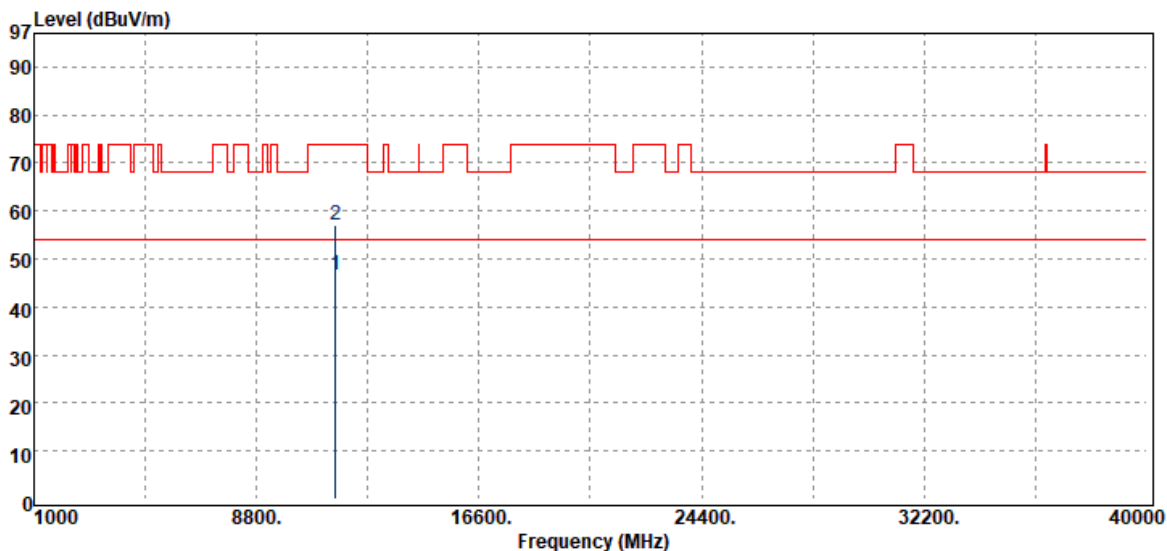

| Freq. MHz | Detector Mode PK/QP/AV | Spectrum Reading Level dB μ V | Factor dB | Actual FS dB μ V/m | Limit @3m dB μ V/m | Margin dB |
|--------------|------------------------------|---|--------------|------------------------------|------------------------------|--------------|
| 11570.00 | Average | 24.70 | 21.84 | 46.54 | 54.00 | -7.46 |
| 11570.00 | Peak | 35.39 | 21.84 | 57.23 | 74.00 | -16.77 |

Unless otherwise stated the results shown in this test report refer only to the sample(s) tested and such sample(s) are retained for 90 days only.

除非另有說明，此報告結果僅對測試之樣品負責，同時此樣品僅保留90天。本報告未經本公司書面許可，不可部份複製。

This document is issued by the Company subject to its General Conditions of Service printed overleaf, available on request or accessible at <http://www.sgs.com.tw/Terms-and-Conditions> and for electronic format documents, subject to Terms and Conditions for Electronic Documents at <http://www.sgs.com.tw/Terms-and-Conditions>. Attention is drawn to the limitation of liability, indemnification and jurisdiction issues defined therein. Any holder of this document is advised that information contained hereon reflects the Company's findings at the time of its intervention only and within the limits of Client's instructions, if any. The Company's sole responsibility is to its Client and this document does not exonerate parties to a transaction from exercising all their rights and obligations under the transaction documents. This document cannot be reproduced except in full, without prior written approval of the Company. Any unauthorized alteration, forgery or falsification of the content or appearance of this document is unlawful and offenders may be prosecuted to the fullest extent of the law.

Report Number :ER-2021-20085
 Operation Mode :802.11n20
 Test Frequency :5785 MHz
 Test Mode :Tx CH Mid
 EUT Pol :H Plane

Test Site :SAC III Chamber
 Test Date :2021-03-04
 Temp./Humi. :21.3/62
 Antenna Pol. :HORIZONTAL
 Engineer :Ricky

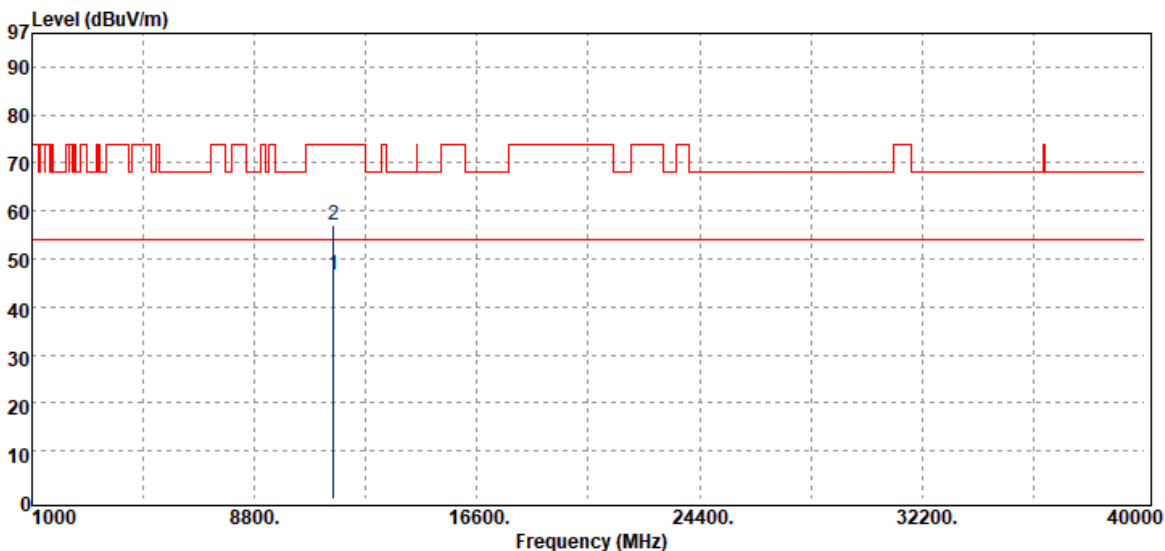

| Freq. MHz | Detector Mode PK/QP/AV | Spectrum Reading Level dB μ V | Factor dB | Actual FS dB μ V/m | Limit @3m dB μ V/m | Margin dB |
|--------------|------------------------------|---|--------------|------------------------------|------------------------------|--------------|
| 11570.00 | Average | 24.72 | 21.84 | 46.56 | 54.00 | -7.44 |
| 11570.00 | Peak | 35.36 | 21.84 | 57.20 | 74.00 | -16.80 |

Unless otherwise stated the results shown in this test report refer only to the sample(s) tested and such sample(s) are retained for 90 days only.

除非另有說明，此報告結果僅對測試之樣品負責，同時此樣品僅保留90天。本報告未經本公司書面許可，不可部份複製。

This document is issued by the Company subject to its General Conditions of Service printed overleaf, available on request or accessible at <http://www.sgs.com.tw/Terms-and-Conditions> and for electronic format documents, subject to Terms and Conditions for Electronic Documents at <http://www.sgs.com.tw/Terms-and-Conditions>. Attention is drawn to the limitation of liability, indemnification and jurisdiction issues defined therein. Any holder of this document is advised that information contained hereon reflects the Company's findings at the time of its intervention only and within the limits of Client's instructions, if any. The Company's sole responsibility is to its Client and this document does not exonerate parties to a transaction from exercising all their rights and obligations under the transaction documents. This document cannot be reproduced except in full, without prior written approval of the Company. Any unauthorized alteration, forgery or falsification of the content or appearance of this document is unlawful and offenders may be prosecuted to the fullest extent of the law.

Report Number :ER-2021-20085
 Operation Mode :802.11n20
 Test Frequency :5825 MHz
 Test Mode :Tx CH High
 EUT Pol :H Plane

Test Site :SAC III Chamber
 Test Date :2021-03-04
 Temp./Humi. :21.3/62
 Antenna Pol. :VERTICAL
 Engineer :Ricky

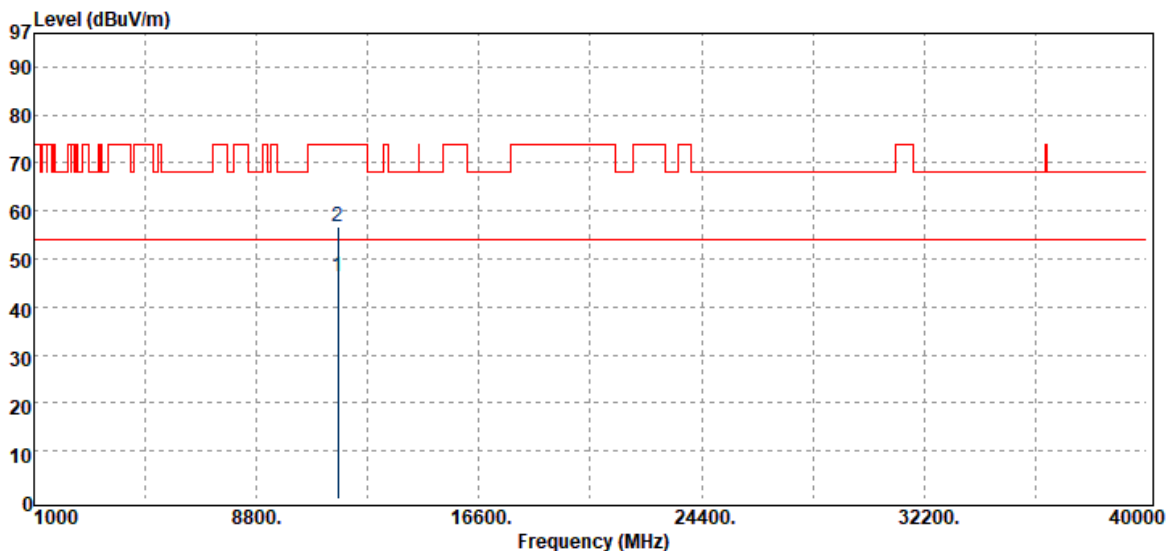

| Freq. MHz | Detector Mode PK/QP/AV | Spectrum Reading Level dB μ V | Factor dB | Actual FS dB μ V/m | Limit @3m dB μ V/m | Margin dB |
|--------------|------------------------------|---|--------------|------------------------------|------------------------------|--------------|
| 11650.00 | Average | 24.09 | 22.13 | 46.22 | 54.00 | -7.78 |
| 11650.00 | Peak | 34.63 | 22.13 | 56.76 | 74.00 | -17.24 |

Unless otherwise stated the results shown in this test report refer only to the sample(s) tested and such sample(s) are retained for 90 days only.

除非另有說明，此報告結果僅對測試之樣品負責，同時此樣品僅保留90天。本報告未經本公司書面許可，不可部份複製。

This document is issued by the Company subject to its General Conditions of Service printed overleaf, available on request or accessible at <http://www.sgs.com.tw/Terms-and-Conditions> and for electronic format documents, subject to Terms and Conditions for Electronic Documents at <http://www.sgs.com.tw/Terms-and-Conditions>. Attention is drawn to the limitation of liability, indemnification and jurisdiction issues defined therein. Any holder of this document is advised that information contained hereon reflects the Company's findings at the time of its intervention only and within the limits of Client's instructions, if any. The Company's sole responsibility is to its Client and this document does not exonerate parties to a transaction from exercising all their rights and obligations under the transaction documents. This document cannot be reproduced except in full, without prior written approval of the Company. Any unauthorized alteration, forgery or falsification of the content or appearance of this document is unlawful and offenders may be prosecuted to the fullest extent of the law.

Report Number :ER-2021-20085
 Operation Mode :802.11n20
 Test Frequency :5825 MHz
 Test Mode :Tx CH High
 EUT Pol :H Plane

Test Site :SAC III Chamber
 Test Date :2021-03-04
 Temp./Humi. :21.3/62
 Antenna Pol. :HORIZONTAL
 Engineer :Ricky

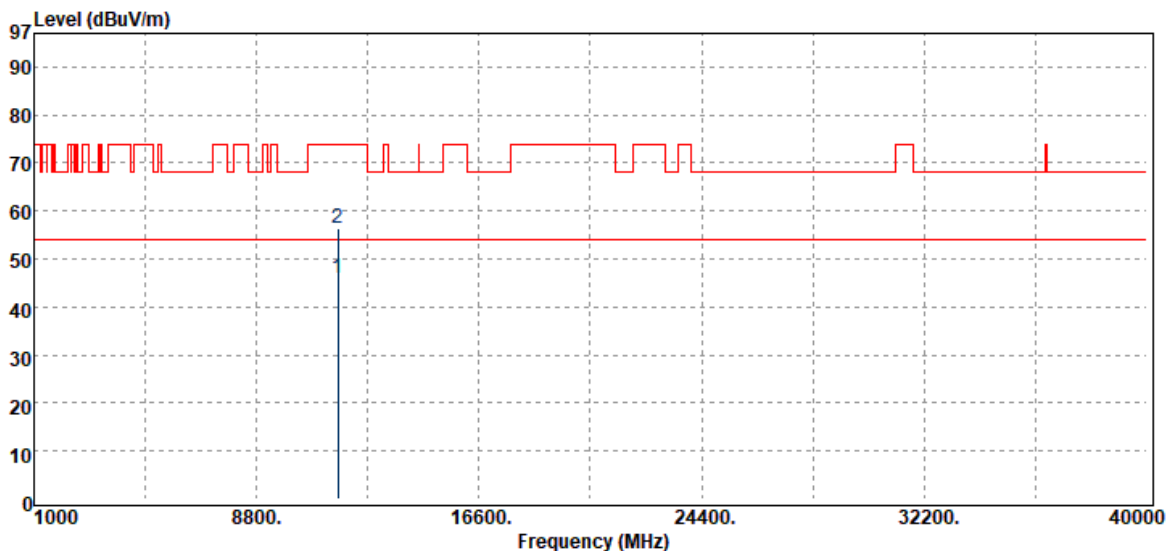

| Freq. MHz | Detector Mode PK/QP/AV | Spectrum Reading Level dB μ V | Factor dB | Actual FS dB μ V/m | Limit @3m dB μ V/m | Margin dB |
|--------------|------------------------------|---|--------------|------------------------------|------------------------------|--------------|
| 11650.00 | Average | 24.02 | 22.13 | 46.15 | 54.00 | -7.85 |
| 11650.00 | Peak | 34.25 | 22.13 | 56.38 | 74.00 | -17.62 |

Unless otherwise stated the results shown in this test report refer only to the sample(s) tested and such sample(s) are retained for 90 days only.

除非另有說明，此報告結果僅對測試之樣品負責，同時此樣品僅保留90天。本報告未經本公司書面許可，不可部份複製。

This document is issued by the Company subject to its General Conditions of Service printed overleaf, available on request or accessible at <http://www.sgs.com.tw/Terms-and-Conditions> and for electronic format documents, subject to Terms and Conditions for Electronic Documents at <http://www.sgs.com.tw/Terms-and-Conditions>. Attention is drawn to the limitation of liability, indemnification and jurisdiction issues defined therein. Any holder of this document is advised that information contained hereon reflects the Company's findings at the time of its intervention only and within the limits of Client's instructions, if any. The Company's sole responsibility is to its Client and this document does not exonerate parties to a transaction from exercising all their rights and obligations under the transaction documents. This document cannot be reproduced except in full, without prior written approval of the Company. Any unauthorized alteration, forgery or falsification of the content or appearance of this document is unlawful and offenders may be prosecuted to the fullest extent of the law.

Report Number :ER-2021-20085
 Operation Mode :802.11n40
 Test Frequency :5190 MHz
 Test Mode :Tx CH Low
 EUT Pol :H Plane

Test Site :SAC III Chamber
 Test Date :2021-03-04
 Temp./Humi. :21.3/62
 Antenna Pol. :VERTICAL
 Engineer :Ricky



| Freq. MHz | Detector Mode PK/QP/AV | Spectrum Reading Level dB μ V | Factor dB | Actual FS dB μ V/m | Limit @3m dB μ V/m | Margin dB |
|--------------|------------------------------|---|--------------|------------------------------|------------------------------|--------------|
| 10380.00 | Peak | 34.79 | 19.70 | 54.49 | 68.20 | -13.71 |

Unless otherwise stated the results shown in this test report refer only to the sample(s) tested and such sample(s) are retained for 90 days only.

除非另有說明，此報告結果僅對測試之樣品負責，同時此樣品僅保留90天。本報告未經本公司書面許可，不可部份複製。
 This document is issued by the Company subject to its General Conditions of Service printed overleaf, available on request or accessible at <http://www.sgs.com.tw/Terms-and-Conditions> and for electronic format documents, subject to Terms and Conditions for Electronic Documents at <http://www.sgs.com.tw/Terms-and-Conditions>. Attention is drawn to the limitation of liability, indemnification and jurisdiction issues defined therein. Any holder of this document is advised that information contained hereon reflects the Company's findings at the time of its intervention only and within the limits of Client's instructions, if any. The Company's sole responsibility is to its Client and this document does not exonerate parties to a transaction from exercising all their rights and obligations under the transaction documents. This document cannot be reproduced except in full, without prior written approval of the Company. Any unauthorized alteration, forgery or falsification of the content or appearance of this document is unlawful and offenders may be prosecuted to the fullest extent of the law.

Report Number :ER-2021-20085
 Operation Mode :802.11n40
 Test Frequency :5190 MHz
 Test Mode :Tx CH Low
 EUT Pol :H Plane

Test Site :SAC III Chamber
 Test Date :2021-03-04
 Temp./Humi. :21.3/62
 Antenna Pol. :HORIZONTAL
 Engineer :Ricky

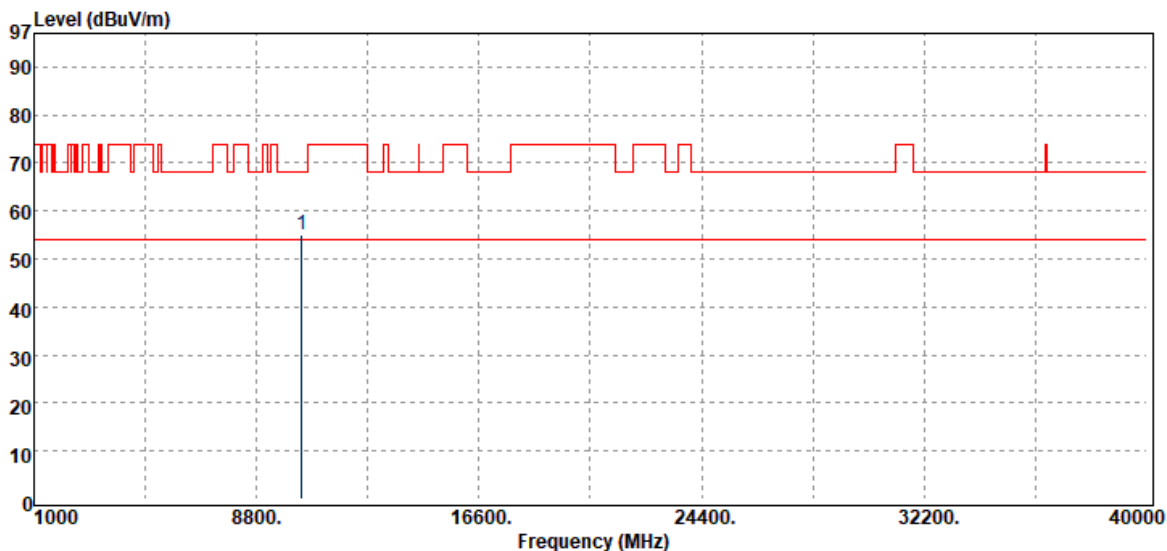

| Freq. MHz | Detector Mode PK/QP/AV | Spectrum Reading Level dB μ V | Factor dB | Actual FS dB μ V/m | Limit @3m dB μ V/m | Margin dB |
|--------------|------------------------------|---|--------------|------------------------------|------------------------------|--------------|
| 10380.00 | Peak | 35.33 | 19.70 | 55.03 | 68.20 | -13.17 |

Unless otherwise stated the results shown in this test report refer only to the sample(s) tested and such sample(s) are retained for 90 days only.

除非另有說明，此報告結果僅對測試之樣品負責，同時此樣品僅保留90天。本報告未經本公司書面許可，不可部份複製。

This document is issued by the Company subject to its General Conditions of Service printed overleaf, available on request or accessible at <http://www.sgs.com.tw/Terms-and-Conditions> and for electronic format documents, subject to Terms and Conditions for Electronic Documents at <http://www.sgs.com.tw/Terms-and-Conditions>. Attention is drawn to the limitation of liability, indemnification and jurisdiction issues defined therein. Any holder of this document is advised that information contained hereon reflects the Company's findings at the time of its intervention only and within the limits of Client's instructions, if any. The Company's sole responsibility is to its Client and this document does not exonerate parties to a transaction from exercising all their rights and obligations under the transaction documents. This document cannot be reproduced except in full, without prior written approval of the Company. Any unauthorized alteration, forgery or falsification of the content or appearance of this document is unlawful and offenders may be prosecuted to the fullest extent of the law.

Report Number :ER-2021-20085
 Operation Mode :802.11n40
 Test Frequency :5230 MHz
 Test Mode :Tx CH High
 EUT Pol :H Plane

Test Site :SAC III Chamber
 Test Date :2021-03-04
 Temp./Humi. :21.3/62
 Antenna Pol. :VERTICAL
 Engineer :Ricky

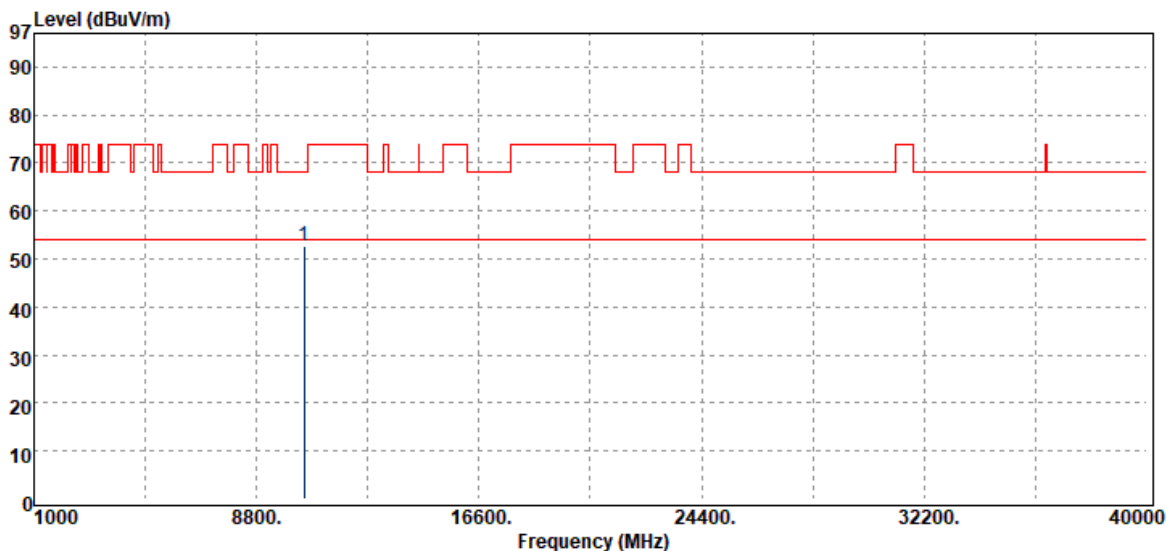

| Freq. MHz | Detector Mode PK/QP/AV | Spectrum Reading Level dB μ V | Factor dB | Actual FS dB μ V/m | Limit @3m dB μ V/m | Margin dB |
|--------------|------------------------------|---|--------------|------------------------------|------------------------------|--------------|
| 10460.00 | Peak | 33.41 | 19.22 | 52.63 | 68.20 | -15.57 |

Unless otherwise stated the results shown in this test report refer only to the sample(s) tested and such sample(s) are retained for 90 days only.

除非另有說明，此報告結果僅對測試之樣品負責，同時此樣品僅保留90天。本報告未經本公司書面許可，不可部份複製。

This document is issued by the Company subject to its General Conditions of Service printed overleaf, available on request or accessible at <http://www.sgs.com.tw/Terms-and-Conditions> and for electronic format documents, subject to Terms and Conditions for Electronic Documents at <http://www.sgs.com.tw/Terms-and-Conditions>. Attention is drawn to the limitation of liability, indemnification and jurisdiction issues defined therein. Any holder of this document is advised that information contained hereon reflects the Company's findings at the time of its intervention only and within the limits of Client's instructions, if any. The Company's sole responsibility is to its Client and this document does not exonerate parties to a transaction from exercising all their rights and obligations under the transaction documents. This document cannot be reproduced except in full, without prior written approval of the Company. Any unauthorized alteration, forgery or falsification of the content or appearance of this document is unlawful and offenders may be prosecuted to the fullest extent of the law.

Report Number :ER-2021-20085
 Operation Mode :802.11n40
 Test Frequency :5230 MHz
 Test Mode :Tx CH High
 EUT Pol :H Plane

Test Site :SAC III Chamber
 Test Date :2021-03-04
 Temp./Humi. :21.3/62
 Antenna Pol. :HORIZONTAL
 Engineer :Ricky

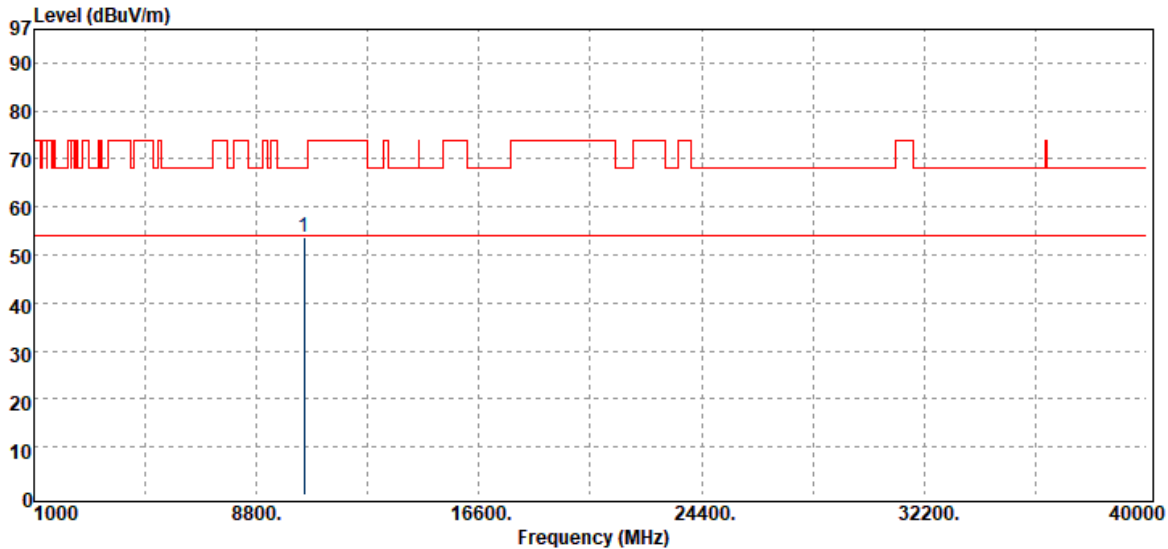

| Freq. MHz | Detector Mode PK/QP/AV | Spectrum Reading Level dB μ V | Factor dB | Actual FS dB μ V/m | Limit @3m dB μ V/m | Margin dB |
|--------------|------------------------------|---|--------------|------------------------------|------------------------------|--------------|
| 10460.00 | Peak | 34.38 | 19.22 | 53.60 | 68.20 | -14.60 |

Unless otherwise stated the results shown in this test report refer only to the sample(s) tested and such sample(s) are retained for 90 days only.

除非另有說明，此報告結果僅對測試之樣品負責，同時此樣品僅保留90天。本報告未經本公司書面許可，不可部份複製。

This document is issued by the Company subject to its General Conditions of Service printed overleaf, available on request or accessible at <http://www.sgs.com.tw/Terms-and-Conditions> and for electronic format documents, subject to Terms and Conditions for Electronic Documents at <http://www.sgs.com.tw/Terms-and-Conditions>. Attention is drawn to the limitation of liability, indemnification and jurisdiction issues defined therein. Any holder of this document is advised that information contained hereon reflects the Company's findings at the time of its intervention only and within the limits of Client's instructions, if any. The Company's sole responsibility is to its Client and this document does not exonerate parties to a transaction from exercising all their rights and obligations under the transaction documents. This document cannot be reproduced except in full, without prior written approval of the Company. Any unauthorized alteration, forgery or falsification of the content or appearance of this document is unlawful and offenders may be prosecuted to the fullest extent of the law.

Report Number :ER-2021-20085
 Operation Mode :802.11n40
 Test Frequency :5270 MHz
 Test Mode :Tx CH Low
 EUT Pol :H Plane

Test Site :SAC III Chamber
 Test Date :2021-03-04
 Temp./Humi. :21.3/62
 Antenna Pol. :VERTICAL
 Engineer :Ricky

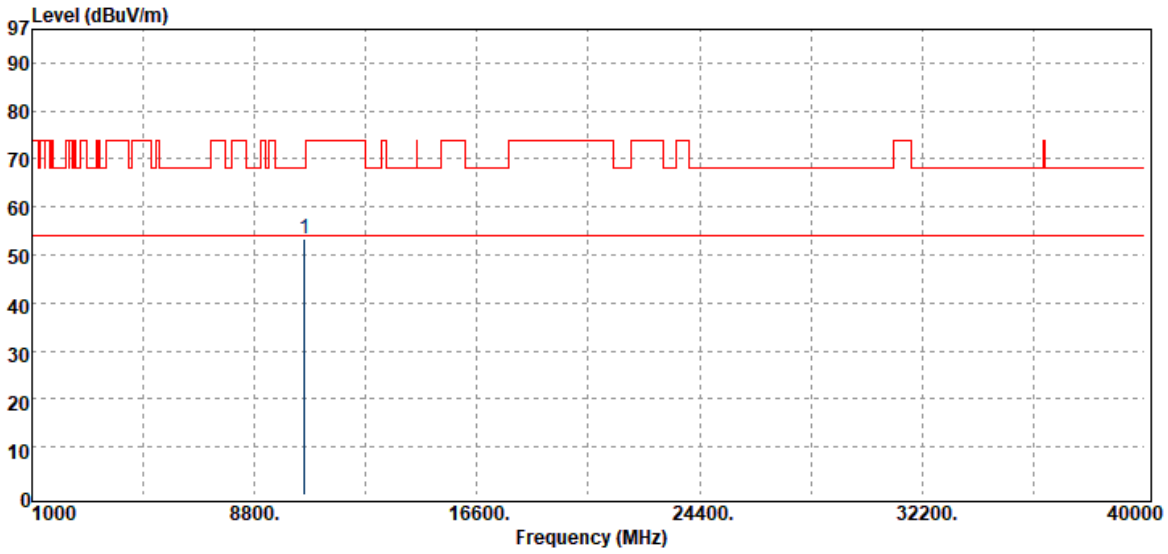

| Freq. MHz | Detector Mode PK/QP/AV | Spectrum Reading Level dB μ V | Factor dB | Actual FS dB μ V/m | Limit @3m dB μ V/m | Margin dB |
|--------------|------------------------------|---|--------------|------------------------------|------------------------------|--------------|
| 10540.00 | Peak | 33.67 | 19.78 | 53.45 | 68.20 | -14.75 |

Unless otherwise stated the results shown in this test report refer only to the sample(s) tested and such sample(s) are retained for 90 days only.

除非另有說明，此報告結果僅對測試之樣品負責，同時此樣品僅保留90天。本報告未經本公司書面許可，不可部份複製。

This document is issued by the Company subject to its General Conditions of Service printed overleaf, available on request or accessible at <http://www.sgs.com.tw/Terms-and-Conditions> and for electronic format documents, subject to Terms and Conditions for Electronic Documents at <http://www.sgs.com.tw/Terms-and-Conditions>. Attention is drawn to the limitation of liability, indemnification and jurisdiction issues defined therein. Any holder of this document is advised that information contained hereon reflects the Company's findings at the time of its intervention only and within the limits of Client's instructions, if any. The Company's sole responsibility is to its Client and this document does not exonerate parties to a transaction from exercising all their rights and obligations under the transaction documents. This document cannot be reproduced except in full, without prior written approval of the Company. Any unauthorized alteration, forgery or falsification of the content or appearance of this document is unlawful and offenders may be prosecuted to the fullest extent of the law.

Report Number :ER-2021-20085
 Operation Mode :802.11n40
 Test Frequency :5270 MHz
 Test Mode :Tx CH Low
 EUT Pol :H Plane

Test Site :SAC III Chamber
 Test Date :2021-03-04
 Temp./Humi. :21.3/62
 Antenna Pol. :HORIZONTAL
 Engineer :Ricky

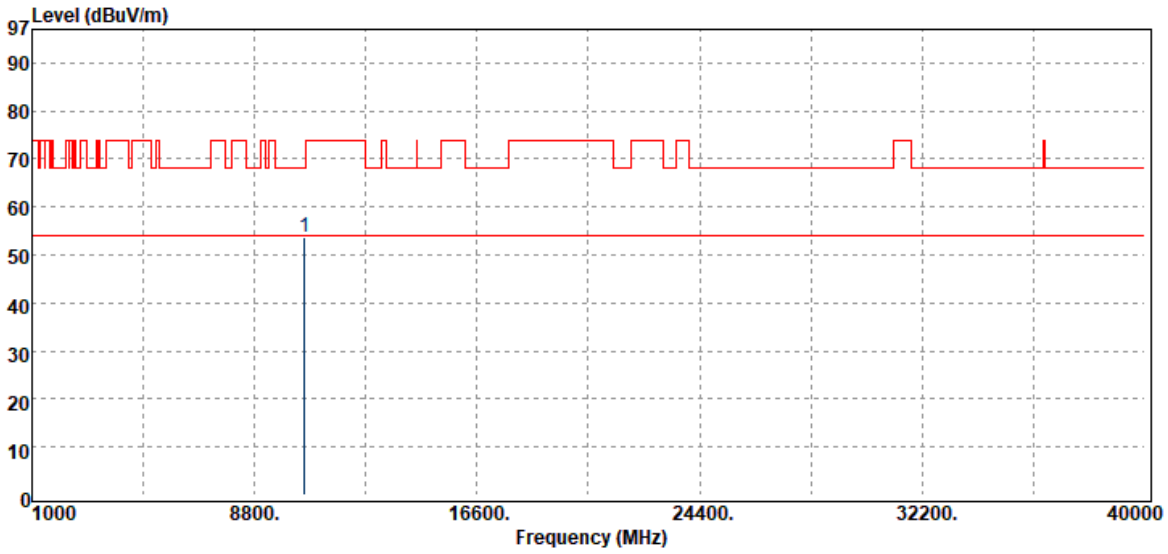

| Freq. MHz | Detector Mode PK/QP/AV | Spectrum Reading Level dB μ V | Factor dB | Actual FS dB μ V/m | Limit @3m dB μ V/m | Margin dB |
|--------------|------------------------------|---|--------------|------------------------------|------------------------------|--------------|
| 10540.00 | Peak | 33.87 | 19.78 | 53.65 | 68.20 | -14.55 |

Unless otherwise stated the results shown in this test report refer only to the sample(s) tested and such sample(s) are retained for 90 days only.

除非另有說明，此報告結果僅對測試之樣品負責，同時此樣品僅保留90天。本報告未經本公司書面許可，不可部份複製。

This document is issued by the Company subject to its General Conditions of Service printed overleaf, available on request or accessible at <http://www.sgs.com.tw/Terms-and-Conditions> and for electronic format documents, subject to Terms and Conditions for Electronic Documents at <http://www.sgs.com.tw/Terms-and-Conditions>. Attention is drawn to the limitation of liability, indemnification and jurisdiction issues defined therein. Any holder of this document is advised that information contained hereon reflects the Company's findings at the time of its intervention only and within the limits of Client's instructions, if any. The Company's sole responsibility is to its Client and this document does not exonerate parties to a transaction from exercising all their rights and obligations under the transaction documents. This document cannot be reproduced except in full, without prior written approval of the Company. Any unauthorized alteration, forgery or falsification of the content or appearance of this document is unlawful and offenders may be prosecuted to the fullest extent of the law.

Report Number :ER-2021-20085
 Operation Mode :802.11n40
 Test Frequency :5310 MHz
 Test Mode :Tx CH High
 EUT Pol :H Plane

Test Site :SAC III Chamber
 Test Date :2021-03-04
 Temp./Humi. :21.3/62
 Antenna Pol. :VERTICAL
 Engineer :Ricky

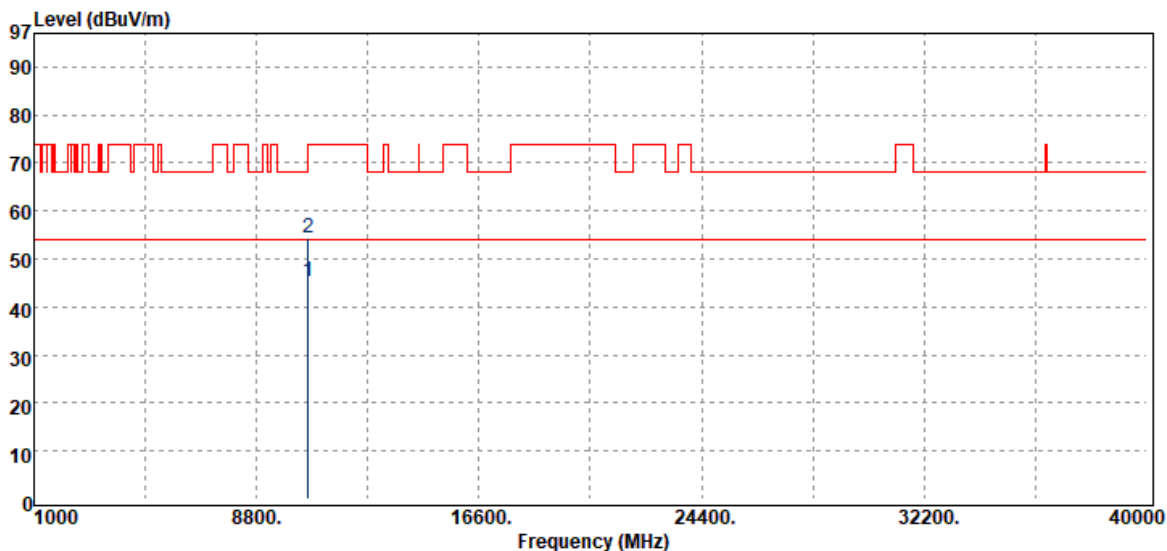

| Freq. MHz | Detector Mode PK/QP/AV | Spectrum Reading Level dBμV | Factor dB | Actual FS dBμV/m | Limit @3m dBμV/m | Margin dB |
|--------------|------------------------------|-----------------------------------|--------------|------------------------|------------------------|--------------|
| 10620.00 | Average | 25.12 | 20.12 | 45.24 | 54.00 | -8.76 |
| 10620.00 | Peak | 34.22 | 20.12 | 54.34 | 74.00 | -19.66 |

Unless otherwise stated the results shown in this test report refer only to the sample(s) tested and such sample(s) are retained for 90 days only.

除非另有說明，此報告結果僅對測試之樣品負責，同時此樣品僅保留90天。本報告未經本公司書面許可，不可部份複製。

This document is issued by the Company subject to its General Conditions of Service printed overleaf, available on request or accessible at <http://www.sgs.com.tw/Terms-and-Conditions> and for electronic format documents, subject to Terms and Conditions for Electronic Documents at <http://www.sgs.com.tw/Terms-and-Conditions>. Attention is drawn to the limitation of liability, indemnification and jurisdiction issues defined therein. Any holder of this document is advised that information contained hereon reflects the Company's findings at the time of its intervention only and within the limits of Client's instructions, if any. The Company's sole responsibility is to its Client and this document does not exonerate parties to a transaction from exercising all their rights and obligations under the transaction documents. This document cannot be reproduced except in full, without prior written approval of the Company. Any unauthorized alteration, forgery or falsification of the content or appearance of this document is unlawful and offenders may be prosecuted to the fullest extent of the law.

Report Number :ER-2021-20085
 Operation Mode :802.11n40
 Test Frequency :5310 MHz
 Test Mode :Tx CH High
 EUT Pol :H Plane

Test Site :SAC III Chamber
 Test Date :2021-03-04
 Temp./Humi. :21.3/62
 Antenna Pol. :HORIZONTAL
 Engineer :Ricky

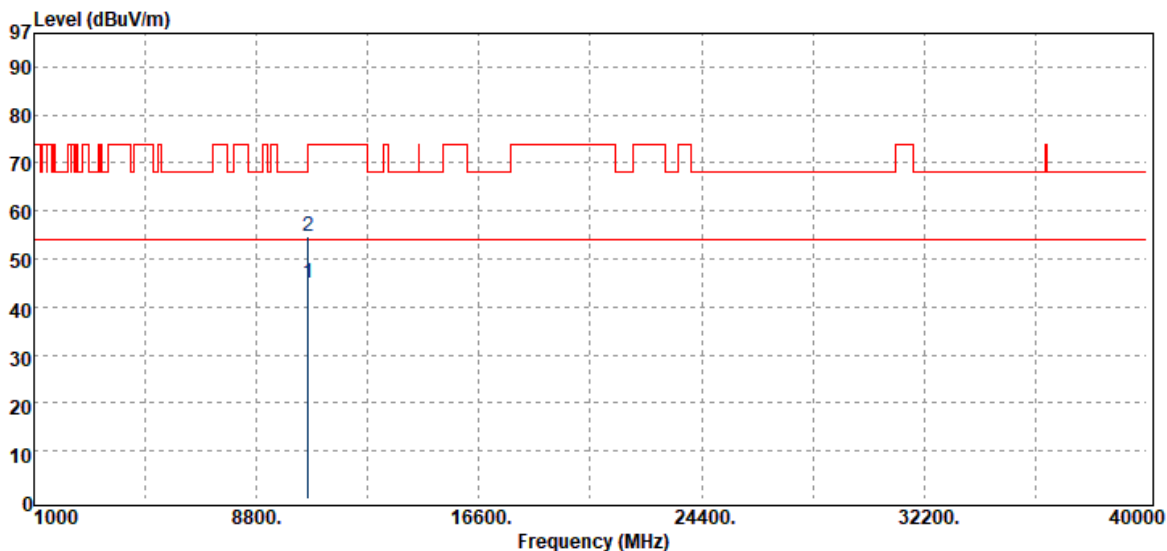

| Freq. MHz | Detector Mode PK/QP/AV | Spectrum Reading Level dB μ V | Factor dB | Actual FS dB μ V/m | Limit @3m dB μ V/m | Margin dB |
|--------------|------------------------------|---|--------------|------------------------------|------------------------------|--------------|
| 10620.00 | Average | 24.95 | 20.12 | 45.07 | 54.00 | -8.93 |
| 10620.00 | Peak | 34.75 | 20.12 | 54.87 | 74.00 | -19.13 |

Unless otherwise stated the results shown in this test report refer only to the sample(s) tested and such sample(s) are retained for 90 days only.

除非另有說明，此報告結果僅對測試之樣品負責，同時此樣品僅保留90天。本報告未經本公司書面許可，不可部份複製。

This document is issued by the Company subject to its General Conditions of Service printed overleaf, available on request or accessible at <http://www.sgs.com.tw/Terms-and-Conditions> and for electronic format documents, subject to Terms and Conditions for Electronic Documents at <http://www.sgs.com.tw/Terms-and-Conditions>. Attention is drawn to the limitation of liability, indemnification and jurisdiction issues defined therein. Any holder of this document is advised that information contained hereon reflects the Company's findings at the time of its intervention only and within the limits of Client's instructions, if any. The Company's sole responsibility is to its Client and this document does not exonerate parties to a transaction from exercising all their rights and obligations under the transaction documents. This document cannot be reproduced except in full, without prior written approval of the Company. Any unauthorized alteration, forgery or falsification of the content or appearance of this document is unlawful and offenders may be prosecuted to the fullest extent of the law.

Report Number :ER-2021-20085
 Operation Mode :802.11n40
 Test Frequency :5510 MHz
 Test Mode :Tx CH Low
 EUT Pol :H Plane

Test Site :SAC III Chamber
 Test Date :2021-03-04
 Temp./Humi. :21.3/62
 Antenna Pol. :VERTICAL
 Engineer :Ricky

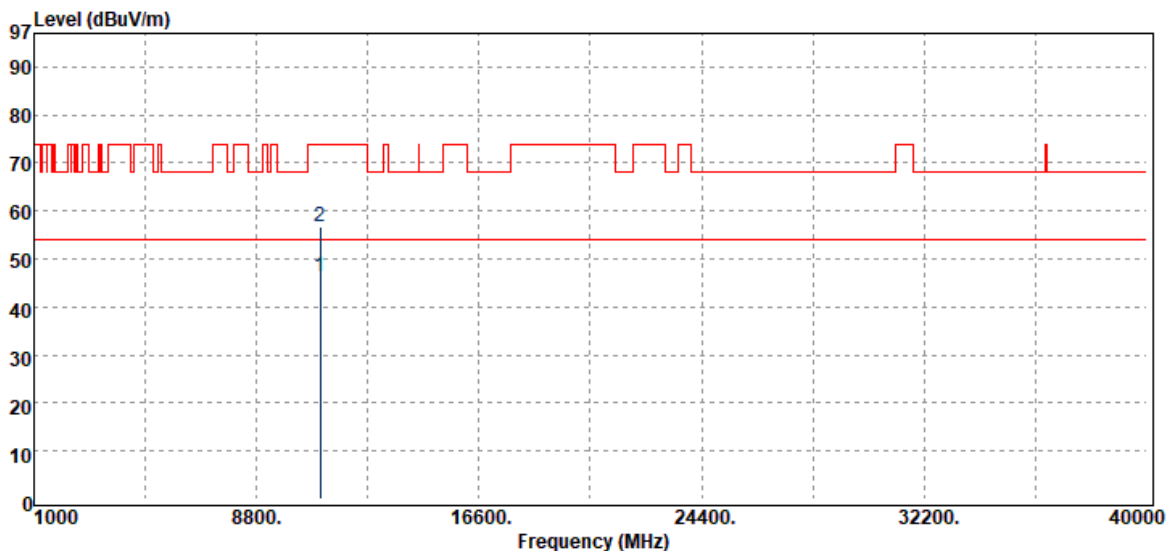

| Freq. MHz | Detector Mode PK/QP/AV | Spectrum Reading Level dB μ V | Factor dB | Actual FS dB μ V/m | Limit @3m dB μ V/m | Margin dB |
|--------------|------------------------------|---|--------------|------------------------------|------------------------------|--------------|
| 11020.00 | Average | 24.63 | 21.61 | 46.24 | 54.00 | -7.76 |
| 11020.00 | Peak | 34.95 | 21.61 | 56.56 | 74.00 | -17.44 |

Unless otherwise stated the results shown in this test report refer only to the sample(s) tested and such sample(s) are retained for 90 days only.

除非另有說明，此報告結果僅對測試之樣品負責，同時此樣品僅保留90天。本報告未經本公司書面許可，不可部份複製。

This document is issued by the Company subject to its General Conditions of Service printed overleaf, available on request or accessible at <http://www.sgs.com.tw/Terms-and-Conditions> and for electronic format documents, subject to Terms and Conditions for Electronic Documents at <http://www.sgs.com.tw/Terms-and-Conditions>. Attention is drawn to the limitation of liability, indemnification and jurisdiction issues defined therein. Any holder of this document is advised that information contained hereon reflects the Company's findings at the time of its intervention only and within the limits of Client's instructions, if any. The Company's sole responsibility is to its Client and this document does not exonerate parties to a transaction from exercising all their rights and obligations under the transaction documents. This document cannot be reproduced except in full, without prior written approval of the Company. Any unauthorized alteration, forgery or falsification of the content or appearance of this document is unlawful and offenders may be prosecuted to the fullest extent of the law.

Report Number :ER-2021-20085
 Operation Mode :802.11n40
 Test Frequency :5510 MHz
 Test Mode :Tx CH Low
 EUT Pol :H Plane

Test Site :SAC III Chamber
 Test Date :2021-03-04
 Temp./Humi. :21.3/62
 Antenna Pol. :HORIZONTAL
 Engineer :Ricky

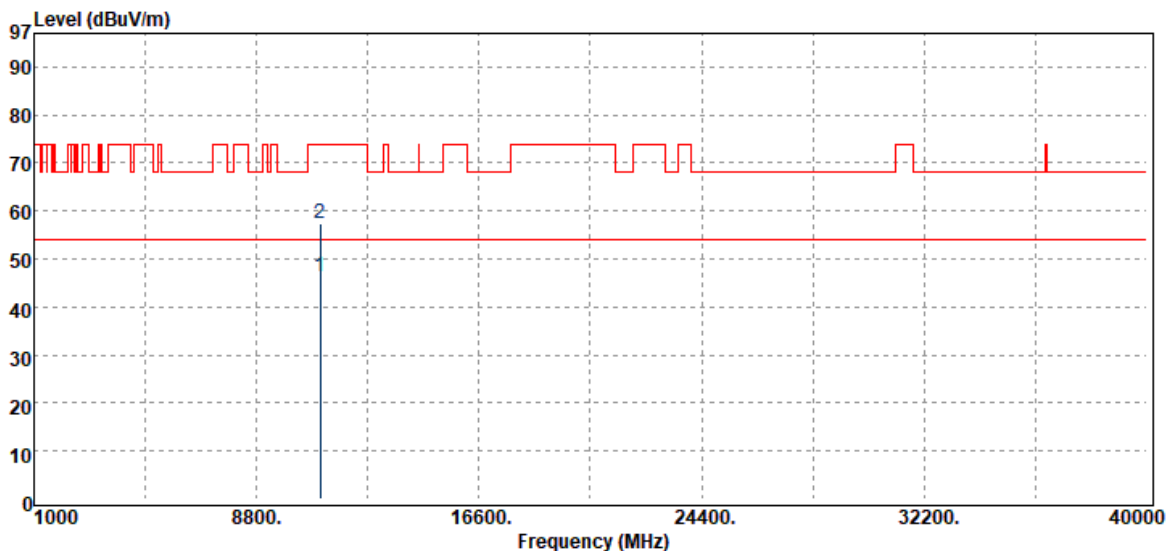

| Freq. MHz | Detector Mode PK/QP/AV | Spectrum Reading Level dB μ V | Factor dB | Actual FS dB μ V/m | Limit @3m dB μ V/m | Margin dB |
|--------------|------------------------------|---|--------------|------------------------------|------------------------------|--------------|
| 11020.00 | Average | 24.61 | 21.61 | 46.22 | 54.00 | -7.78 |
| 11020.00 | Peak | 35.65 | 21.61 | 57.26 | 74.00 | -16.74 |

Unless otherwise stated the results shown in this test report refer only to the sample(s) tested and such sample(s) are retained for 90 days only.

除非另有說明，此報告結果僅對測試之樣品負責，同時此樣品僅保留90天。本報告未經本公司書面許可，不可部份複製。

This document is issued by the Company subject to its General Conditions of Service printed overleaf, available on request or accessible at <http://www.sgs.com.tw/Terms-and-Conditions> and for electronic format documents, subject to Terms and Conditions for Electronic Documents at <http://www.sgs.com.tw/Terms-and-Conditions>. Attention is drawn to the limitation of liability, indemnification and jurisdiction issues defined therein. Any holder of this document is advised that information contained hereon reflects the Company's findings at the time of its intervention only and within the limits of Client's instructions, if any. The Company's sole responsibility is to its Client and this document does not exonerate parties to a transaction from exercising all their rights and obligations under the transaction documents. This document cannot be reproduced except in full, without prior written approval of the Company. Any unauthorized alteration, forgery or falsification of the content or appearance of this document is unlawful and offenders may be prosecuted to the fullest extent of the law.

Report Number :ER-2021-20085
 Operation Mode :802.11n40
 Test Frequency :5550 MHz
 Test Mode :Tx CH Mid
 EUT Pol :H Plane

Test Site :SAC III Chamber
 Test Date :2021-03-04
 Temp./Humi. :21.3/62
 Antenna Pol. :VERTICAL
 Engineer :Ricky

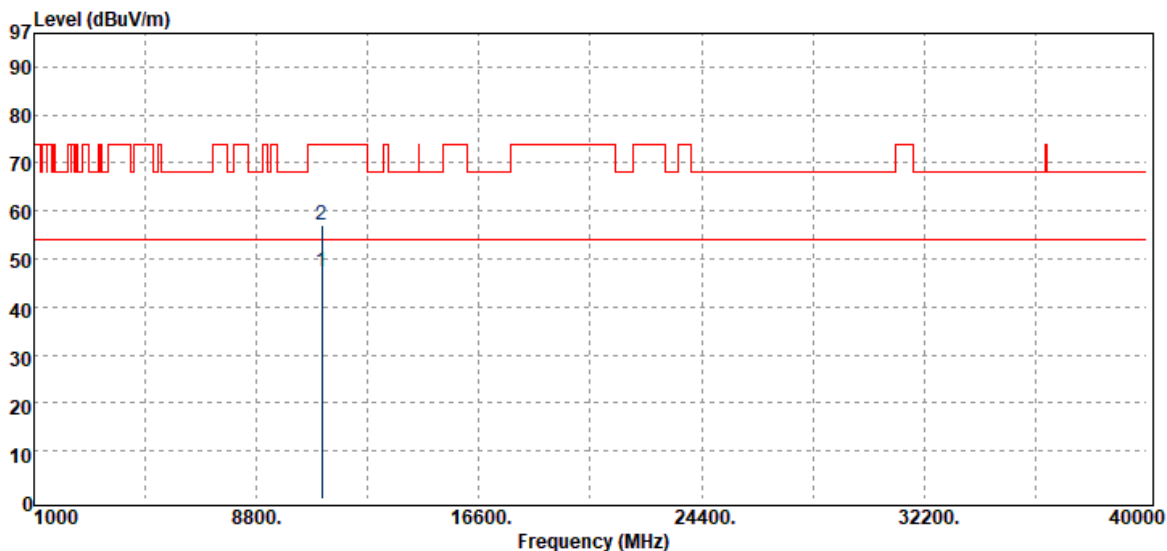

| Freq. MHz | Detector Mode PK/QP/AV | Spectrum Reading Level dBμV | Factor dB | Actual FS dBμV/m | Limit @3m dBμV/m | Margin dB |
|--------------|------------------------------|-----------------------------------|--------------|------------------------|------------------------|--------------|
| 11100.00 | Average | 24.66 | 22.83 | 47.49 | 54.00 | -6.51 |
| 11100.00 | Peak | 34.10 | 22.83 | 56.93 | 74.00 | -17.07 |

Unless otherwise stated the results shown in this test report refer only to the sample(s) tested and such sample(s) are retained for 90 days only.

除非另有說明，此報告結果僅對測試之樣品負責，同時此樣品僅保留90天。本報告未經本公司書面許可，不可部份複製。

This document is issued by the Company subject to its General Conditions of Service printed overleaf, available on request or accessible at <http://www.sgs.com.tw/Terms-and-Conditions> and for electronic format documents, subject to Terms and Conditions for Electronic Documents at <http://www.sgs.com.tw/Terms-and-Conditions>. Attention is drawn to the limitation of liability, indemnification and jurisdiction issues defined therein. Any holder of this document is advised that information contained hereon reflects the Company's findings at the time of its intervention only and within the limits of Client's instructions, if any. The Company's sole responsibility is to its Client and this document does not exonerate parties to a transaction from exercising all their rights and obligations under the transaction documents. This document cannot be reproduced except in full, without prior written approval of the Company. Any unauthorized alteration, forgery or falsification of the content or appearance of this document is unlawful and offenders may be prosecuted to the fullest extent of the law.

Report Number :ER-2021-20085
 Operation Mode :802.11n40
 Test Frequency :5550 MHz
 Test Mode :Tx CH Mid
 EUT Pol :H Plane

Test Site :SAC III Chamber
 Test Date :2021-03-04
 Temp./Humi. :21.3/62
 Antenna Pol. :HORIZONTAL
 Engineer :Ricky

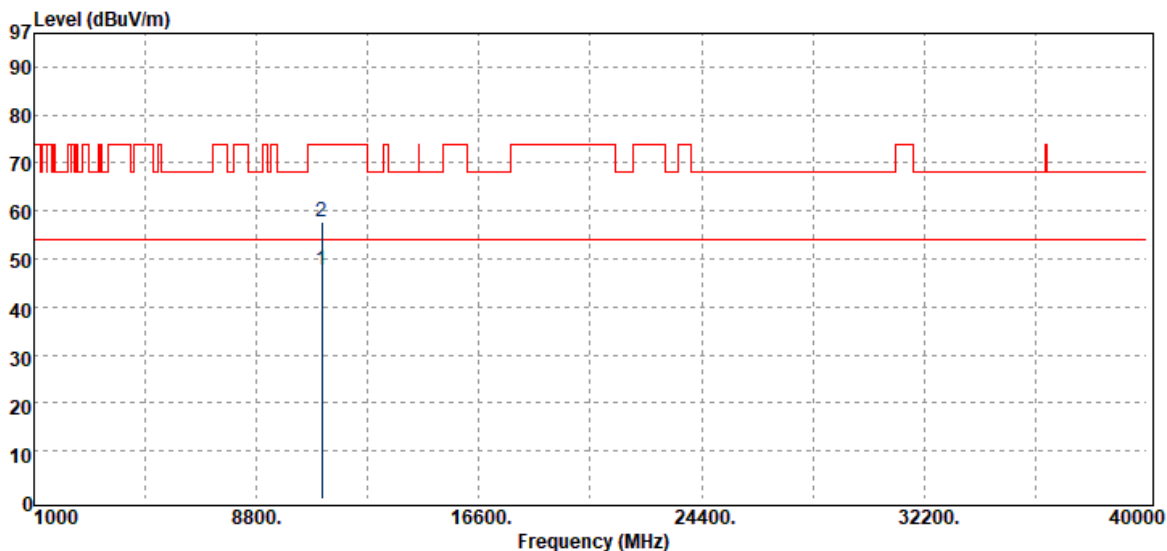

| Freq. MHz | Detector Mode PK/QP/AV | Spectrum Reading Level dB μ V | Factor dB | Actual FS dB μ V/m | Limit @3m dB μ V/m | Margin dB |
|--------------|------------------------------|---|--------------|------------------------------|------------------------------|--------------|
| 11100.00 | Average | 24.68 | 22.83 | 47.51 | 54.00 | -6.49 |
| 11100.00 | Peak | 34.83 | 22.83 | 57.66 | 74.00 | -16.34 |

Unless otherwise stated the results shown in this test report refer only to the sample(s) tested and such sample(s) are retained for 90 days only.

除非另有說明，此報告結果僅對測試之樣品負責，同時此樣品僅保留90天。本報告未經本公司書面許可，不可部份複製。

This document is issued by the Company subject to its General Conditions of Service printed overleaf, available on request or accessible at <http://www.sgs.com.tw/Terms-and-Conditions> and for electronic format documents, subject to Terms and Conditions for Electronic Documents at <http://www.sgs.com.tw/Terms-and-Conditions>. Attention is drawn to the limitation of liability, indemnification and jurisdiction issues defined therein. Any holder of this document is advised that information contained hereon reflects the Company's findings at the time of its intervention only and within the limits of Client's instructions, if any. The Company's sole responsibility is to its Client and this document does not exonerate parties to a transaction from exercising all their rights and obligations under the transaction documents. This document cannot be reproduced except in full, without prior written approval of the Company. Any unauthorized alteration, forgery or falsification of the content or appearance of this document is unlawful and offenders may be prosecuted to the fullest extent of the law.

Report Number :ER-2021-20085
 Operation Mode :802.11n40
 Test Frequency :5670 MHz
 Test Mode :Tx CH High
 EUT Pol :H Plane

Test Site :SAC III Chamber
 Test Date :2021-03-04
 Temp./Humi. :21.3/62
 Antenna Pol. :VERTICAL
 Engineer :Ricky

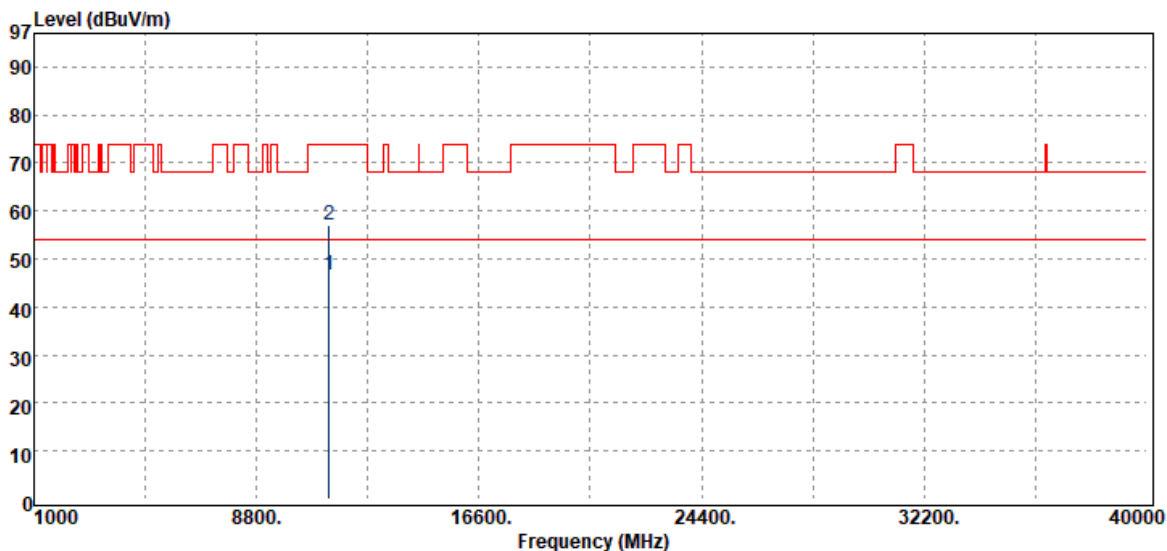

| Freq. MHz | Detector Mode PK/QP/AV | Spectrum Reading Level dB μ V | Factor dB | Actual FS dB μ V/m | Limit @3m dB μ V/m | Margin dB |
|--------------|------------------------------|---|--------------|------------------------------|------------------------------|--------------|
| 11340.00 | Average | 24.63 | 22.19 | 46.82 | 54.00 | -7.18 |
| 11340.00 | Peak | 34.73 | 22.19 | 56.92 | 74.00 | -17.08 |

Unless otherwise stated the results shown in this test report refer only to the sample(s) tested and such sample(s) are retained for 90 days only.

除非另有說明，此報告結果僅對測試之樣品負責，同時此樣品僅保留90天。本報告未經本公司書面許可，不可部份複製。

This document is issued by the Company subject to its General Conditions of Service printed overleaf, available on request or accessible at <http://www.sgs.com.tw/Terms-and-Conditions> and for electronic format documents, subject to Terms and Conditions for Electronic Documents at <http://www.sgs.com.tw/Terms-and-Conditions>. Attention is drawn to the limitation of liability, indemnification and jurisdiction issues defined therein. Any holder of this document is advised that information contained hereon reflects the Company's findings at the time of its intervention only and within the limits of Client's instructions, if any. The Company's sole responsibility is to its Client and this document does not exonerate parties to a transaction from exercising all their rights and obligations under the transaction documents. This document cannot be reproduced except in full, without prior written approval of the Company. Any unauthorized alteration, forgery or falsification of the content or appearance of this document is unlawful and offenders may be prosecuted to the fullest extent of the law.

Report Number :ER-2021-20085
 Operation Mode :802.11n40
 Test Frequency :5670 MHz
 Test Mode :Tx CH High
 EUT Pol :H Plane

Test Site :SAC III Chamber
 Test Date :2021-03-04
 Temp./Humi. :21.3/62
 Antenna Pol. :HORIZONTAL
 Engineer :Ricky

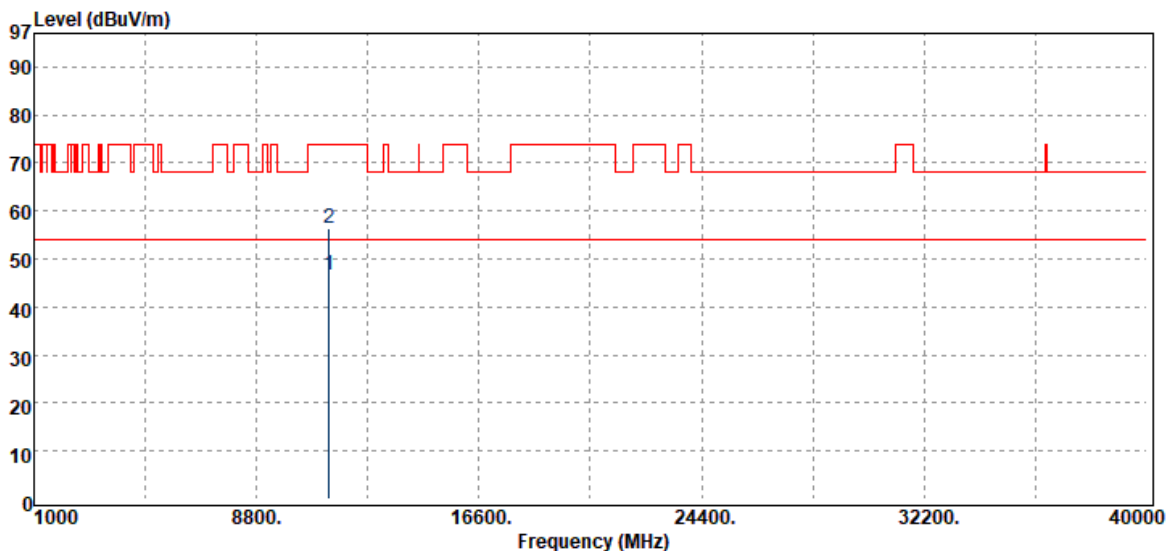

| Freq. MHz | Detector Mode PK/QP/AV | Spectrum Reading Level dB μ V | Factor dB | Actual FS dB μ V/m | Limit @3m dB μ V/m | Margin dB |
|--------------|------------------------------|---|--------------|------------------------------|------------------------------|--------------|
| 11340.00 | Average | 24.56 | 22.19 | 46.75 | 54.00 | -7.25 |
| 11340.00 | Peak | 34.25 | 22.19 | 56.44 | 74.00 | -17.56 |

Unless otherwise stated the results shown in this test report refer only to the sample(s) tested and such sample(s) are retained for 90 days only.

除非另有說明，此報告結果僅對測試之樣品負責，同時此樣品僅保留90天。本報告未經本公司書面許可，不可部份複製。

This document is issued by the Company subject to its General Conditions of Service printed overleaf, available on request or accessible at <http://www.sgs.com.tw/Terms-and-Conditions> and for electronic format documents, subject to Terms and Conditions for Electronic Documents at <http://www.sgs.com.tw/Terms-and-Conditions>. Attention is drawn to the limitation of liability, indemnification and jurisdiction issues defined therein. Any holder of this document is advised that information contained hereon reflects the Company's findings at the time of its intervention only and within the limits of Client's instructions, if any. The Company's sole responsibility is to its Client and this document does not exonerate parties to a transaction from exercising all their rights and obligations under the transaction documents. This document cannot be reproduced except in full, without prior written approval of the Company. Any unauthorized alteration, forgery or falsification of the content or appearance of this document is unlawful and offenders may be prosecuted to the fullest extent of the law.

Report Number :ER-2021-20085
 Operation Mode :802.11n40
 Test Frequency :5710 MHz
 Test Mode :Tx CH High
 EUT Pol :H Plane

Test Site :SAC III Chamber
 Test Date :2021-03-04
 Temp./Humi. :21.3/62
 Antenna Pol. :VERTICAL
 Engineer :Ricky

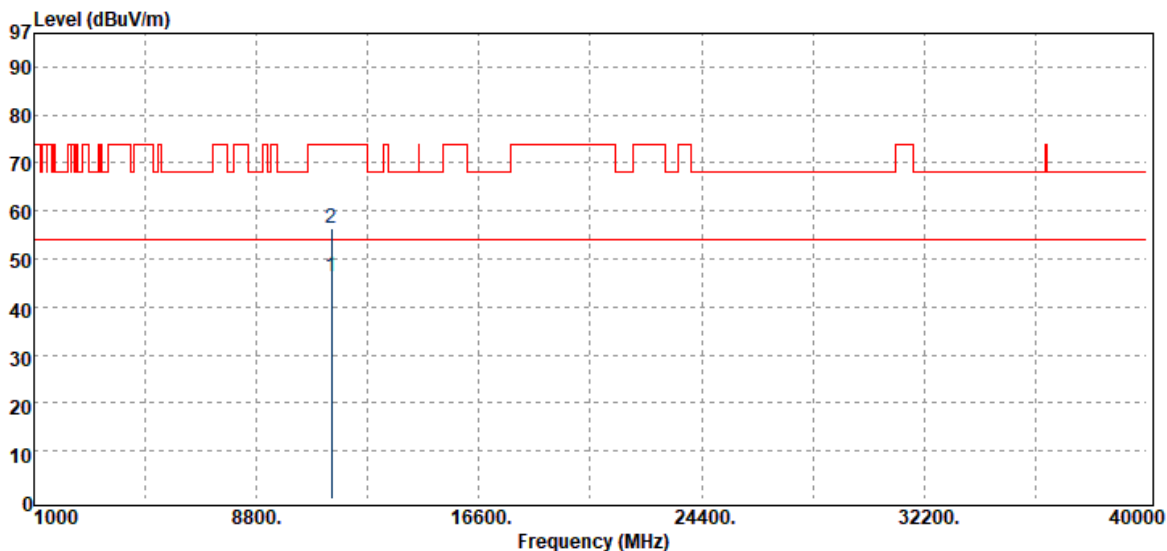

| Freq. MHz | Detector Mode PK/QP/AV | Spectrum Reading Level dB μ V | Factor dB | Actual FS dB μ V/m | Limit @3m dB μ V/m | Margin dB |
|--------------|------------------------------|---|--------------|------------------------------|------------------------------|--------------|
| 11420.00 | Average | 24.33 | 22.13 | 46.46 | 54.00 | -7.54 |
| 11420.00 | Peak | 34.23 | 22.13 | 56.36 | 74.00 | -17.64 |

Unless otherwise stated the results shown in this test report refer only to the sample(s) tested and such sample(s) are retained for 90 days only.

除非另有說明，此報告結果僅對測試之樣品負責，同時此樣品僅保留90天。本報告未經本公司書面許可，不可部份複製。

This document is issued by the Company subject to its General Conditions of Service printed overleaf, available on request or accessible at <http://www.sgs.com.tw/Terms-and-Conditions> and for electronic format documents, subject to Terms and Conditions for Electronic Documents at <http://www.sgs.com.tw/Terms-and-Conditions>. Attention is drawn to the limitation of liability, indemnification and jurisdiction issues defined therein. Any holder of this document is advised that information contained hereon reflects the Company's findings at the time of its intervention only and within the limits of Client's instructions, if any. The Company's sole responsibility is to its Client and this document does not exonerate parties to a transaction from exercising all their rights and obligations under the transaction documents. This document cannot be reproduced except in full, without prior written approval of the Company. Any unauthorized alteration, forgery or falsification of the content or appearance of this document is unlawful and offenders may be prosecuted to the fullest extent of the law.

Report Number :ER-2021-20085
 Operation Mode :802.11n40
 Test Frequency :5710 MHz
 Test Mode :Tx CH High
 EUT Pol :H Plane

Test Site :SAC III Chamber
 Test Date :2021-03-04
 Temp./Humi. :21.3/62
 Antenna Pol. :HORIZONTAL
 Engineer :Ricky

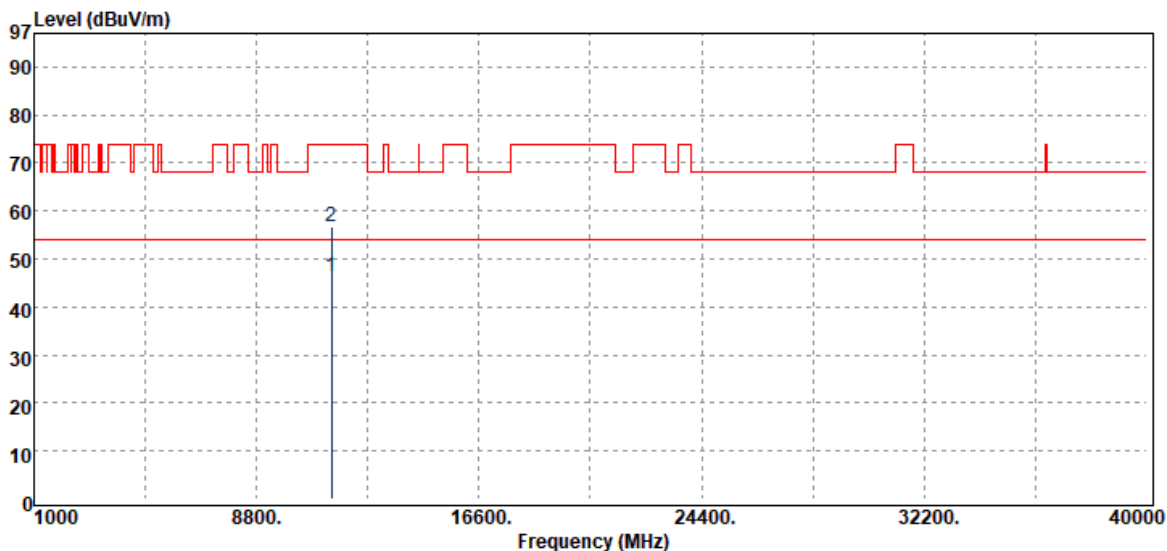

| Freq. MHz | Detector Mode PK/QP/AV | Spectrum Reading Level dB μ V | Factor dB | Actual FS dB μ V/m | Limit @3m dB μ V/m | Margin dB |
|--------------|------------------------------|---|--------------|------------------------------|------------------------------|--------------|
| 11420.00 | Average | 24.29 | 22.13 | 46.42 | 54.00 | -7.58 |
| 11420.00 | Peak | 34.65 | 22.13 | 56.78 | 74.00 | -17.22 |

Unless otherwise stated the results shown in this test report refer only to the sample(s) tested and such sample(s) are retained for 90 days only.

除非另有說明，此報告結果僅對測試之樣品負責，同時此樣品僅保留90天。本報告未經本公司書面許可，不可部份複製。

This document is issued by the Company subject to its General Conditions of Service printed overleaf, available on request or accessible at <http://www.sgs.com.tw/Terms-and-Conditions> and for electronic format documents, subject to Terms and Conditions for Electronic Documents at <http://www.sgs.com.tw/Terms-and-Conditions>. Attention is drawn to the limitation of liability, indemnification and jurisdiction issues defined therein. Any holder of this document is advised that information contained hereon reflects the Company's findings at the time of its intervention only and within the limits of Client's instructions, if any. The Company's sole responsibility is to its Client and this document does not exonerate parties to a transaction from exercising all their rights and obligations under the transaction documents. This document cannot be reproduced except in full, without prior written approval of the Company. Any unauthorized alteration, forgery or falsification of the content or appearance of this document is unlawful and offenders may be prosecuted to the fullest extent of the law.

Report Number :ER-2021-20085
 Operation Mode :802.11n40
 Test Frequency :5755 MHz
 Test Mode :Tx CH Low
 EUT Pol :H Plane

Test Site :SAC III Chamber
 Test Date :2021-03-04
 Temp./Humi. :21.3/62
 Antenna Pol. :VERTICAL
 Engineer :Ricky

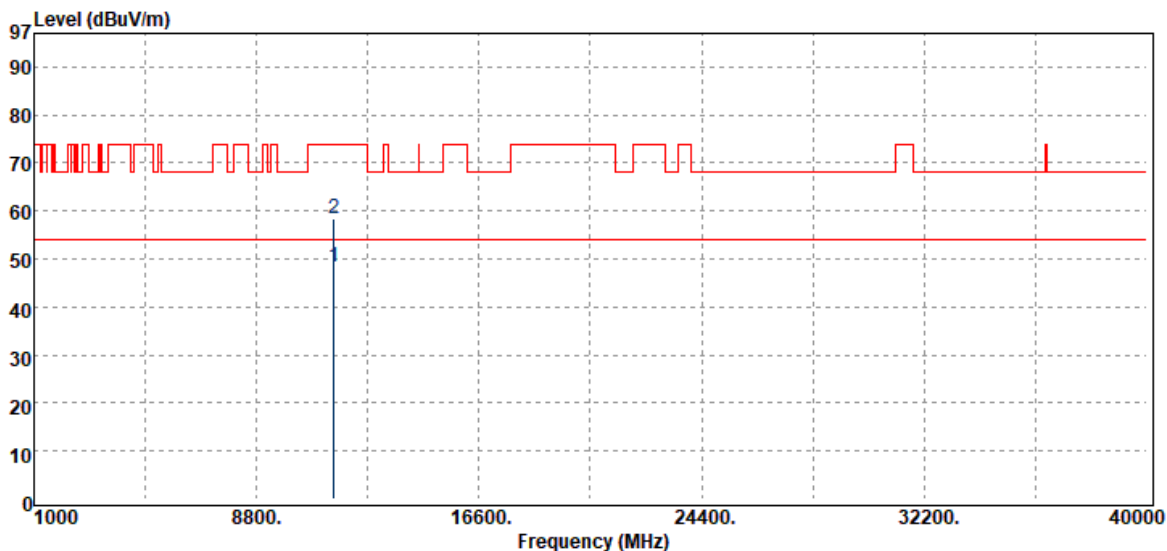

| Freq. MHz | Detector Mode PK/QP/AV | Spectrum Reading Level dBμV | Factor dB | Actual FS dBμV/m | Limit @3m dBμV/m | Margin dB |
|--------------|------------------------------|-----------------------------------|--------------|------------------------|------------------------|--------------|
| 11510.00 | Average | 24.05 | 24.31 | 48.36 | 54.00 | -5.64 |
| 11510.00 | Peak | 34.02 | 24.31 | 58.33 | 74.00 | -15.67 |

Unless otherwise stated the results shown in this test report refer only to the sample(s) tested and such sample(s) are retained for 90 days only.

除非另有說明，此報告結果僅對測試之樣品負責，同時此樣品僅保留90天。本報告未經本公司書面許可，不可部份複製。

This document is issued by the Company subject to its General Conditions of Service printed overleaf, available on request or accessible at <http://www.sgs.com.tw/Terms-and-Conditions> and for electronic format documents, subject to Terms and Conditions for Electronic Documents at <http://www.sgs.com.tw/Terms-and-Conditions>. Attention is drawn to the limitation of liability, indemnification and jurisdiction issues defined therein. Any holder of this document is advised that information contained hereon reflects the Company's findings at the time of its intervention only and within the limits of Client's instructions, if any. The Company's sole responsibility is to its Client and this document does not exonerate parties to a transaction from exercising all their rights and obligations under the transaction documents. This document cannot be reproduced except in full, without prior written approval of the Company. Any unauthorized alteration, forgery or falsification of the content or appearance of this document is unlawful and offenders may be prosecuted to the fullest extent of the law.

Report Number :ER-2021-20085
 Operation Mode :802.11n40
 Test Frequency :5755 MHz
 Test Mode :Tx CH Low
 EUT Pol :H Plane

Test Site :SAC III Chamber
 Test Date :2021-03-04
 Temp./Humi. :21.3/62
 Antenna Pol. :HORIZONTAL
 Engineer :Ricky

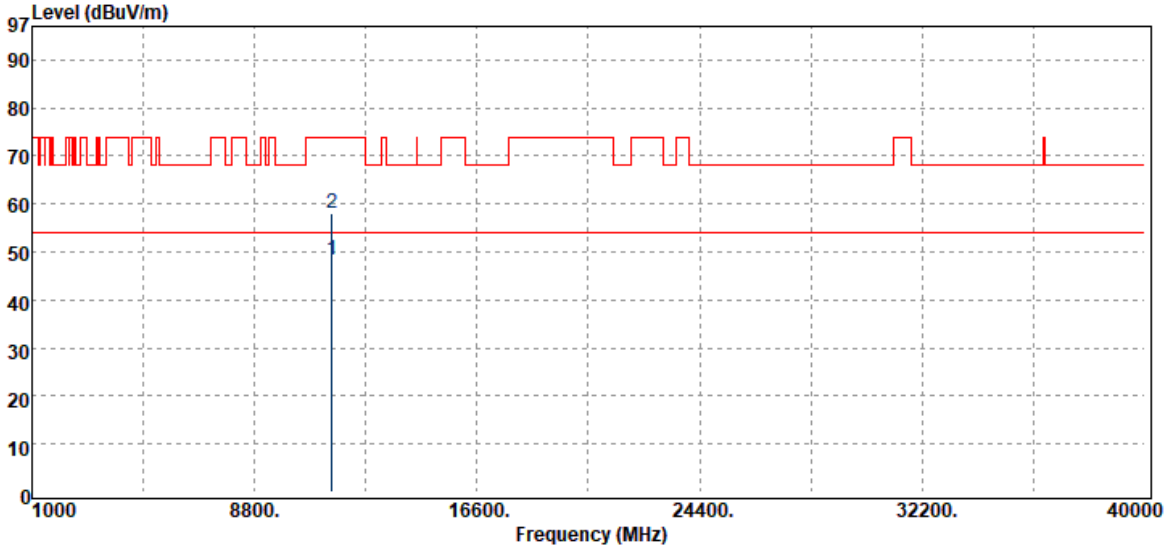

| Freq. MHz | Detector Mode PK/QP/AV | Spectrum Reading Level dB μ V | Factor dB | Actual FS dB μ V/m | Limit @3m dB μ V/m | Margin dB |
|--------------|------------------------------|---|--------------|------------------------------|------------------------------|--------------|
| 11510.00 | Average | 24.01 | 24.31 | 48.32 | 54.00 | -5.68 |
| 11510.00 | Peak | 33.75 | 24.31 | 58.06 | 74.00 | -15.94 |

Unless otherwise stated the results shown in this test report refer only to the sample(s) tested and such sample(s) are retained for 90 days only.

除非另有說明，此報告結果僅對測試之樣品負責，同時此樣品僅保留90天。本報告未經本公司書面許可，不可部份複製。

This document is issued by the Company subject to its General Conditions of Service printed overleaf, available on request or accessible at <http://www.sgs.com.tw/Terms-and-Conditions> and for electronic format documents, subject to Terms and Conditions for Electronic Documents at <http://www.sgs.com.tw/Terms-and-Conditions>. Attention is drawn to the limitation of liability, indemnification and jurisdiction issues defined therein. Any holder of this document is advised that information contained hereon reflects the Company's findings at the time of its intervention only and within the limits of Client's instructions, if any. The Company's sole responsibility is to its Client and this document does not exonerate parties to a transaction from exercising all their rights and obligations under the transaction documents. This document cannot be reproduced except in full, without prior written approval of the Company. Any unauthorized alteration, forgery or falsification of the content or appearance of this document is unlawful and offenders may be prosecuted to the fullest extent of the law.

Report Number :ER-2021-20085
 Operation Mode :802.11n40
 Test Frequency :5795 MHz
 Test Mode :Tx CH High
 EUT Pol :H Plane

Test Site :SAC III Chamber
 Test Date :2021-03-04
 Temp./Humi. :21.3/62
 Antenna Pol. :VERTICAL
 Engineer :Ricky

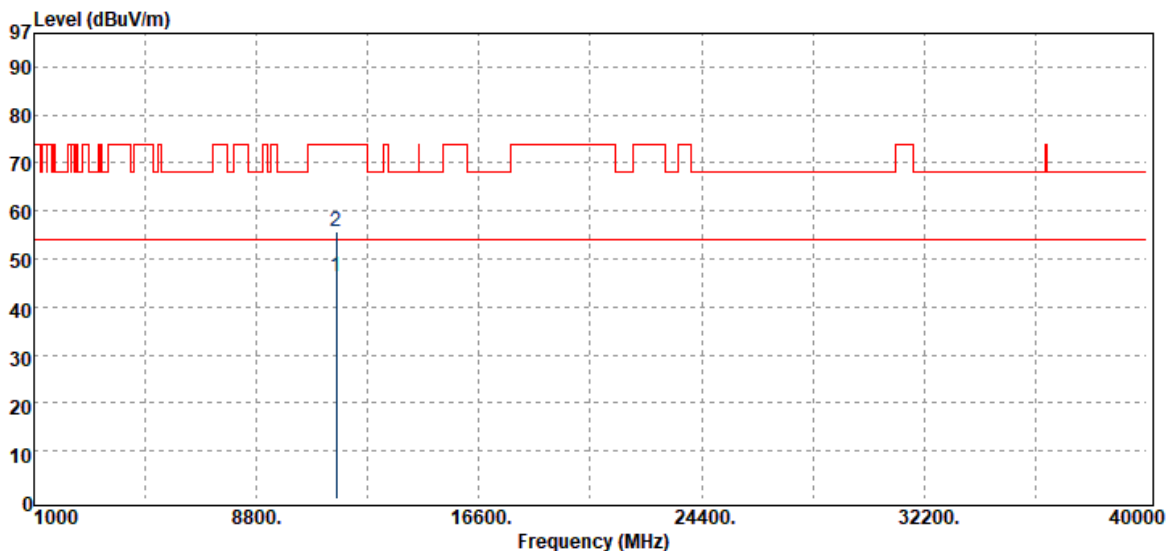

| Freq. MHz | Detector Mode PK/QP/AV | Spectrum Reading Level dB μ V | Factor dB | Actual FS dB μ V/m | Limit @3m dB μ V/m | Margin dB |
|--------------|------------------------------|---|--------------|------------------------------|------------------------------|--------------|
| 11590.00 | Average | 25.04 | 21.17 | 46.21 | 54.00 | -7.79 |
| 11590.00 | Peak | 34.64 | 21.17 | 55.81 | 74.00 | -18.19 |

Unless otherwise stated the results shown in this test report refer only to the sample(s) tested and such sample(s) are retained for 90 days only.

除非另有說明，此報告結果僅對測試之樣品負責，同時此樣品僅保留90天。本報告未經本公司書面許可，不可部份複製。

This document is issued by the Company subject to its General Conditions of Service printed overleaf, available on request or accessible at <http://www.sgs.com.tw/Terms-and-Conditions> and for electronic format documents, subject to Terms and Conditions for Electronic Documents at <http://www.sgs.com.tw/Terms-and-Conditions>. Attention is drawn to the limitation of liability, indemnification and jurisdiction issues defined therein. Any holder of this document is advised that information contained hereon reflects the Company's findings at the time of its intervention only and within the limits of Client's instructions, if any. The Company's sole responsibility is to its Client and this document does not exonerate parties to a transaction from exercising all their rights and obligations under the transaction documents. This document cannot be reproduced except in full, without prior written approval of the Company. Any unauthorized alteration, forgery or falsification of the content or appearance of this document is unlawful and offenders may be prosecuted to the fullest extent of the law.

Report Number :ER-2021-20085
 Operation Mode :802.11n40
 Test Frequency :5795 MHz
 Test Mode :Tx CH High
 EUT Pol :H Plane

Test Site :SAC III Chamber
 Test Date :2021-03-04
 Temp./Humi. :21.3/62
 Antenna Pol. :HORIZONTAL
 Engineer :Ricky

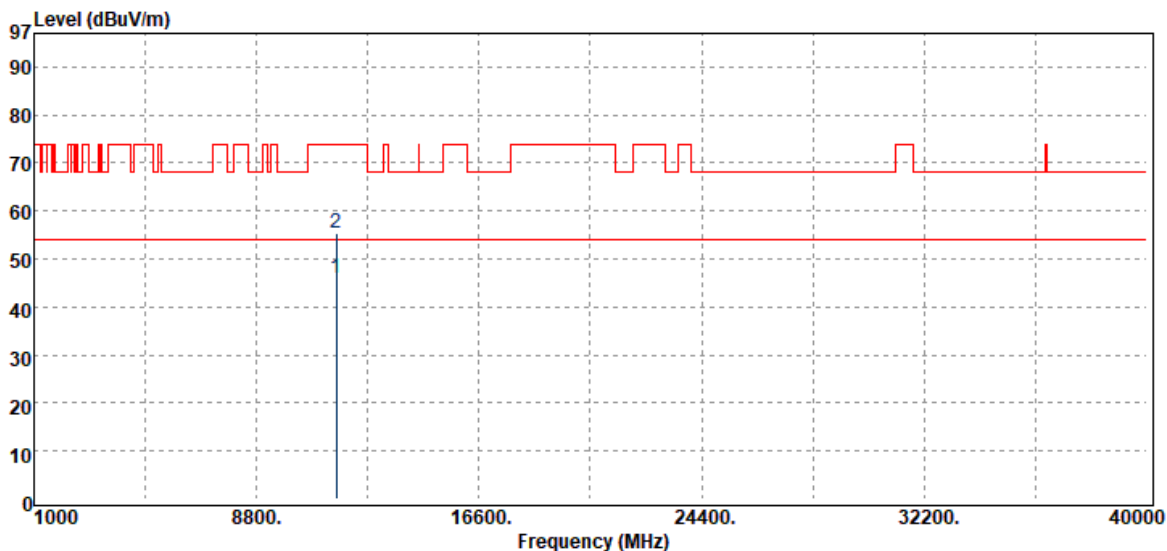

| Freq. MHz | Detector Mode PK/QP/AV | Spectrum Reading Level dB μ V | Factor dB | Actual FS dB μ V/m | Limit @3m dB μ V/m | Margin dB |
|--------------|------------------------------|---|--------------|------------------------------|------------------------------|--------------|
| 11590.00 | Average | 24.96 | 21.17 | 46.13 | 54.00 | -7.87 |
| 11590.00 | Peak | 34.37 | 21.17 | 55.54 | 74.00 | -18.46 |

Unless otherwise stated the results shown in this test report refer only to the sample(s) tested and such sample(s) are retained for 90 days only.

除非另有說明，此報告結果僅對測試之樣品負責，同時此樣品僅保留90天。本報告未經本公司書面許可，不可部份複製。

This document is issued by the Company subject to its General Conditions of Service printed overleaf, available on request or accessible at <http://www.sgs.com.tw/Terms-and-Conditions> and for electronic format documents, subject to Terms and Conditions for Electronic Documents at <http://www.sgs.com.tw/Terms-and-Conditions>. Attention is drawn to the limitation of liability, indemnification and jurisdiction issues defined therein. Any holder of this document is advised that information contained hereon reflects the Company's findings at the time of its intervention only and within the limits of Client's instructions, if any. The Company's sole responsibility is to its Client and this document does not exonerate parties to a transaction from exercising all their rights and obligations under the transaction documents. This document cannot be reproduced except in full, without prior written approval of the Company. Any unauthorized alteration, forgery or falsification of the content or appearance of this document is unlawful and offenders may be prosecuted to the fullest extent of the law.

Report Number :ER-2021-20085
 Operation Mode :802.11ac80
 Test Frequency :5210 MHz
 Test Mode :Tx CH Low
 EUT Pol :H Plane

Test Site :SAC III Chamber
 Test Date :2021-03-04
 Temp./Humi. :21.3/62
 Antenna Pol. :VERTICAL
 Engineer :Ricky

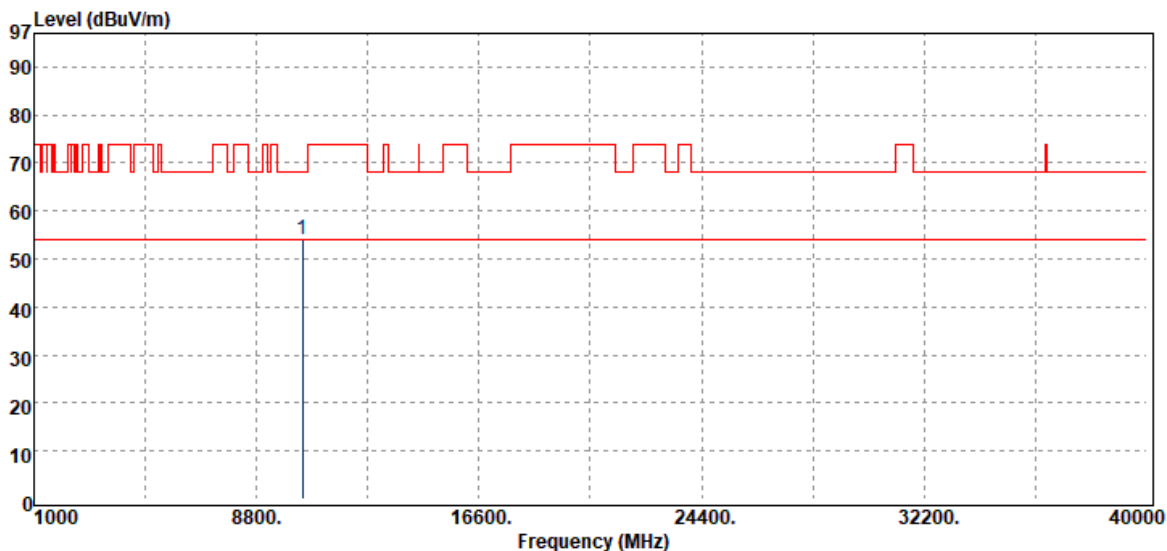

| Freq. MHz | Detector Mode PK/QP/AV | Spectrum Reading Level dB μ V | Factor dB | Actual FS dB μ V/m | Limit @3m dB μ V/m | Margin dB |
|--------------|------------------------------|---|--------------|------------------------------|------------------------------|--------------|
| 10420.00 | Peak | 34.83 | 19.35 | 54.18 | 68.20 | -14.02 |

Unless otherwise stated the results shown in this test report refer only to the sample(s) tested and such sample(s) are retained for 90 days only.

除非另有說明，此報告結果僅對測試之樣品負責，同時此樣品僅保留90天。本報告未經本公司書面許可，不可部份複製。

This document is issued by the Company subject to its General Conditions of Service printed overleaf, available on request or accessible at <http://www.sgs.com.tw/Terms-and-Conditions> and for electronic format documents, subject to Terms and Conditions for Electronic Documents at <http://www.sgs.com.tw/Terms-and-Conditions>. Attention is drawn to the limitation of liability, indemnification and jurisdiction issues defined therein. Any holder of this document is advised that information contained hereon reflects the Company's findings at the time of its intervention only and within the limits of Client's instructions, if any. The Company's sole responsibility is to its Client and this document does not exonerate parties to a transaction from exercising all their rights and obligations under the transaction documents. This document cannot be reproduced except in full, without prior written approval of the Company. Any unauthorized alteration, forgery or falsification of the content or appearance of this document is unlawful and offenders may be prosecuted to the fullest extent of the law.

Report Number :ER-2021-20085
 Operation Mode :802.11ac80
 Test Frequency :5210 MHz
 Test Mode :Tx CH Low
 EUT Pol :H Plane

Test Site :SAC III Chamber
 Test Date :2021-03-04
 Temp./Humi. :21.3/62
 Antenna Pol. :HORIZONTAL
 Engineer :Ricky

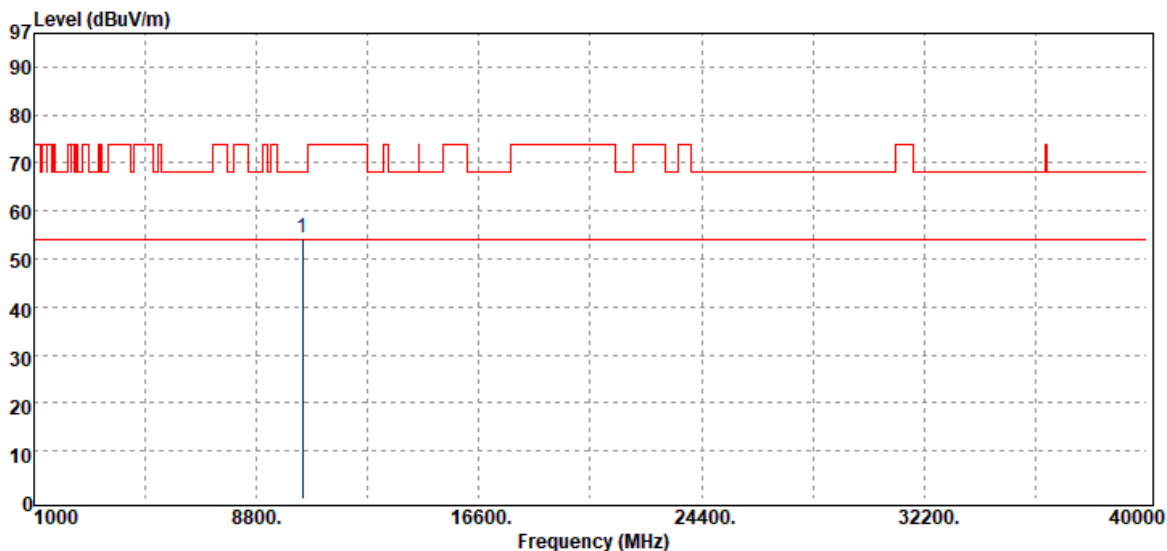

| Freq. MHz | Detector Mode PK/QP/AV | Spectrum Reading Level dB μ V | Factor dB | Actual FS dB μ V/m | Limit @3m dB μ V/m | Margin dB |
|--------------|------------------------------|---|--------------|------------------------------|------------------------------|--------------|
| 10420.00 | Peak | 35.01 | 19.35 | 54.36 | 68.20 | -13.84 |

Unless otherwise stated the results shown in this test report refer only to the sample(s) tested and such sample(s) are retained for 90 days only.

除非另有說明，此報告結果僅對測試之樣品負責，同時此樣品僅保留90天。本報告未經本公司書面許可，不可部份複製。

This document is issued by the Company subject to its General Conditions of Service printed overleaf, available on request or accessible at <http://www.sgs.com.tw/Terms-and-Conditions> and for electronic format documents, subject to Terms and Conditions for Electronic Documents at <http://www.sgs.com.tw/Terms-and-Conditions>. Attention is drawn to the limitation of liability, indemnification and jurisdiction issues defined therein. Any holder of this document is advised that information contained hereon reflects the Company's findings at the time of its intervention only and within the limits of Client's instructions, if any. The Company's sole responsibility is to its Client and this document does not exonerate parties to a transaction from exercising all their rights and obligations under the transaction documents. This document cannot be reproduced except in full, without prior written approval of the Company. Any unauthorized alteration, forgery or falsification of the content or appearance of this document is unlawful and offenders may be prosecuted to the fullest extent of the law.

Report Number :ER-2021-20085
 Operation Mode :802.11ac80
 Test Frequency :5290 MHz
 Test Mode :Tx CH Low
 EUT Pol :H Plane

Test Site :SAC III Chamber
 Test Date :2021-03-04
 Temp./Humi. :21.3/62
 Antenna Pol. :VERTICAL
 Engineer :Ricky

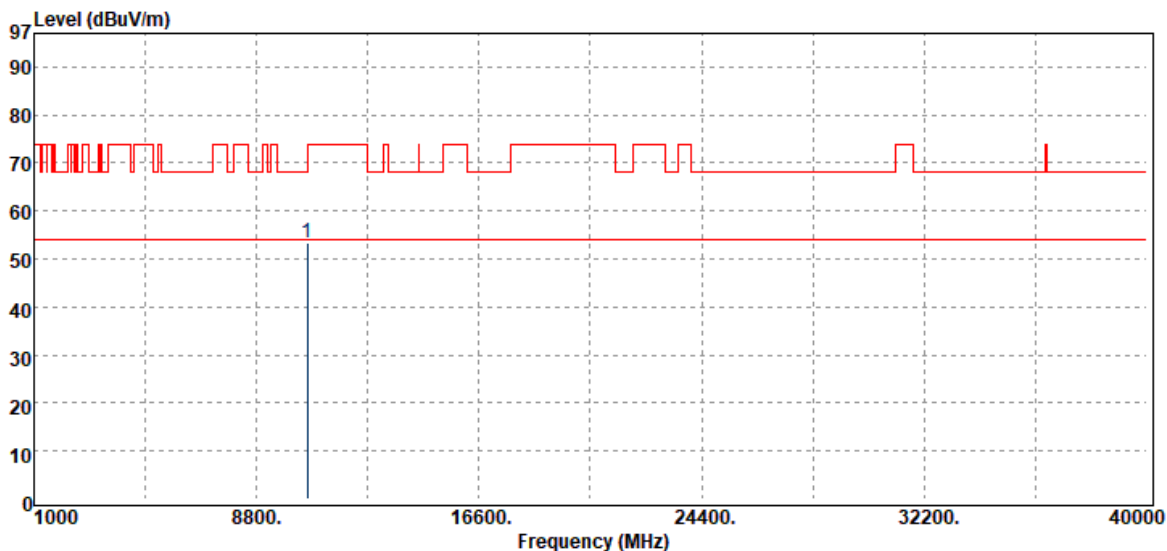

| Freq. MHz | Detector Mode PK/QP/AV | Spectrum Reading Level dB μ V | Factor dB | Actual FS dB μ V/m | Limit @3m dB μ V/m | Margin dB |
|--------------|------------------------------|---|--------------|------------------------------|------------------------------|--------------|
| 10580.00 | Peak | 33.44 | 19.82 | 53.26 | 68.20 | -14.94 |

Unless otherwise stated the results shown in this test report refer only to the sample(s) tested and such sample(s) are retained for 90 days only.

除非另有說明，此報告結果僅對測試之樣品負責，同時此樣品僅保留90天。本報告未經本公司書面許可，不可部份複製。

This document is issued by the Company subject to its General Conditions of Service printed overleaf, available on request or accessible at <http://www.sgs.com.tw/Terms-and-Conditions> and for electronic format documents, subject to Terms and Conditions for Electronic Documents at <http://www.sgs.com.tw/Terms-and-Conditions>. Attention is drawn to the limitation of liability, indemnification and jurisdiction issues defined therein. Any holder of this document is advised that information contained hereon reflects the Company's findings at the time of its intervention only and within the limits of Client's instructions, if any. The Company's sole responsibility is to its Client and this document does not exonerate parties to a transaction from exercising all their rights and obligations under the transaction documents. This document cannot be reproduced except in full, without prior written approval of the Company. Any unauthorized alteration, forgery or falsification of the content or appearance of this document is unlawful and offenders may be prosecuted to the fullest extent of the law.

Report Number :ER-2021-20085
 Operation Mode :802.11ac80
 Test Frequency :5290 MHz
 Test Mode :Tx CH Low
 EUT Pol :H Plane

Test Site :SAC III Chamber
 Test Date :2021-03-04
 Temp./Humi. :21.3/62
 Antenna Pol. :HORIZONTAL
 Engineer :Ricky

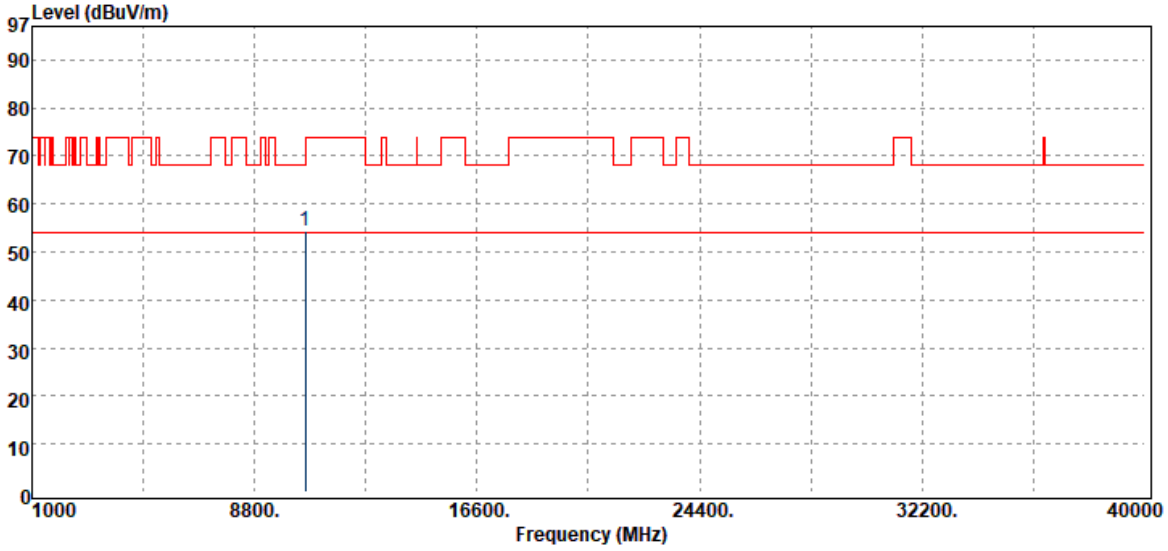

| Freq. MHz | Detector Mode PK/QP/AV | Spectrum Reading Level dB μ V | Factor dB | Actual FS dB μ V/m | Limit @3m dB μ V/m | Margin dB |
|--------------|------------------------------|---|--------------|------------------------------|------------------------------|--------------|
| 10580.00 | Peak | 34.54 | 19.82 | 54.36 | 68.20 | -13.84 |

Unless otherwise stated the results shown in this test report refer only to the sample(s) tested and such sample(s) are retained for 90 days only.

除非另有說明，此報告結果僅對測試之樣品負責，同時此樣品僅保留90天。本報告未經本公司書面許可，不可部份複製。

This document is issued by the Company subject to its General Conditions of Service printed overleaf, available on request or accessible at <http://www.sgs.com.tw/Terms-and-Conditions> and for electronic format documents, subject to Terms and Conditions for Electronic Documents at <http://www.sgs.com.tw/Terms-and-Conditions>. Attention is drawn to the limitation of liability, indemnification and jurisdiction issues defined therein. Any holder of this document is advised that information contained hereon reflects the Company's findings at the time of its intervention only and within the limits of Client's instructions, if any. The Company's sole responsibility is to its Client and this document does not exonerate parties to a transaction from exercising all their rights and obligations under the transaction documents. This document cannot be reproduced except in full, without prior written approval of the Company. Any unauthorized alteration, forgery or falsification of the content or appearance of this document is unlawful and offenders may be prosecuted to the fullest extent of the law.

Report Number :ER-2021-20085
 Operation Mode :802.11ac80
 Test Frequency :5530 MHz
 Test Mode :Tx CH Low
 EUT Pol :H Plane

Test Site :SAC III Chamber
 Test Date :2021-03-05
 Temp./Humi. :21.8/63
 Antenna Pol. :VERTICAL
 Engineer :Ricky

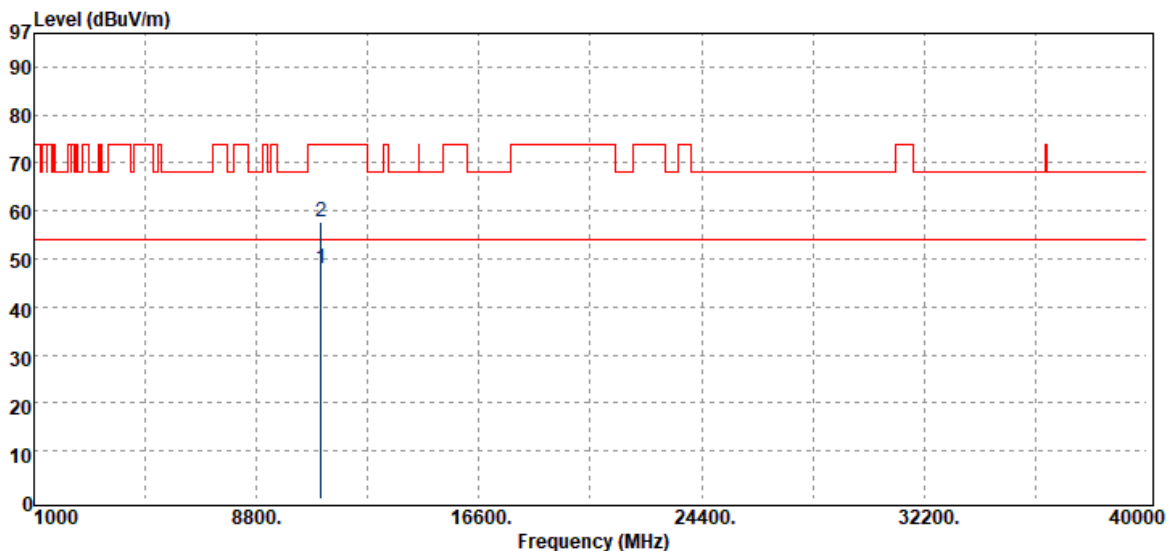

| Freq. MHz | Detector Mode PK/QP/AV | Spectrum Reading Level dB μ V | Factor dB | Actual FS dB μ V/m | Limit @3m dB μ V/m | Margin dB |
|--------------|------------------------------|---|--------------|------------------------------|------------------------------|--------------|
| 11060.00 | Average | 25.29 | 22.71 | 48.00 | 54.00 | -6.00 |
| 11060.00 | Peak | 35.05 | 22.71 | 57.76 | 74.00 | -16.24 |

Unless otherwise stated the results shown in this test report refer only to the sample(s) tested and such sample(s) are retained for 90 days only.

除非另有說明，此報告結果僅對測試之樣品負責，同時此樣品僅保留90天。本報告未經本公司書面許可，不可部份複製。

This document is issued by the Company subject to its General Conditions of Service printed overleaf, available on request or accessible at <http://www.sgs.com.tw/Terms-and-Conditions> and for electronic format documents, subject to Terms and Conditions for Electronic Documents at <http://www.sgs.com.tw/Terms-and-Conditions>. Attention is drawn to the limitation of liability, indemnification and jurisdiction issues defined therein. Any holder of this document is advised that information contained hereon reflects the Company's findings at the time of its intervention only and within the limits of Client's instructions, if any. The Company's sole responsibility is to its Client and this document does not exonerate parties to a transaction from exercising all their rights and obligations under the transaction documents. This document cannot be reproduced except in full, without prior written approval of the Company. Any unauthorized alteration, forgery or falsification of the content or appearance of this document is unlawful and offenders may be prosecuted to the fullest extent of the law.

Report Number :ER-2021-20085
 Operation Mode :802.11ac80
 Test Frequency :5530 MHz
 Test Mode :Tx CH Low
 EUT Pol :H Plane

Test Site :SAC III Chamber
 Test Date :2021-03-05
 Temp./Humi. :21.8/63
 Antenna Pol. :HORIZONTAL
 Engineer :Ricky

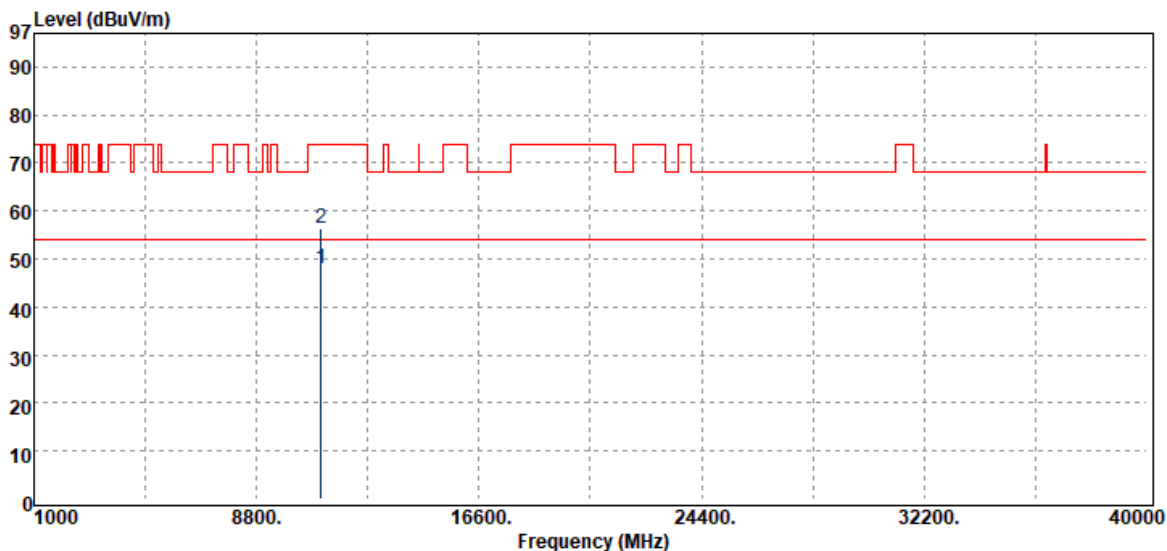

| Freq. MHz | Detector Mode PK/QP/AV | Spectrum Reading Level dB μ V | Factor dB | Actual FS dB μ V/m | Limit @3m dB μ V/m | Margin dB |
|--------------|------------------------------|---|--------------|------------------------------|------------------------------|--------------|
| 11060.00 | Average | 25.14 | 22.71 | 47.85 | 54.00 | -6.15 |
| 11060.00 | Peak | 33.84 | 22.71 | 56.55 | 74.00 | -17.45 |

Unless otherwise stated the results shown in this test report refer only to the sample(s) tested and such sample(s) are retained for 90 days only.

除非另有說明，此報告結果僅對測試之樣品負責，同時此樣品僅保留90天。本報告未經本公司書面許可，不可部份複製。

This document is issued by the Company subject to its General Conditions of Service printed overleaf, available on request or accessible at <http://www.sgs.com.tw/Terms-and-Conditions> and for electronic format documents, subject to Terms and Conditions for Electronic Documents at <http://www.sgs.com.tw/Terms-and-Conditions>. Attention is drawn to the limitation of liability, indemnification and jurisdiction issues defined therein. Any holder of this document is advised that information contained hereon reflects the Company's findings at the time of its intervention only and within the limits of Client's instructions, if any. The Company's sole responsibility is to its Client and this document does not exonerate parties to a transaction from exercising all their rights and obligations under the transaction documents. This document cannot be reproduced except in full, without prior written approval of the Company. Any unauthorized alteration, forgery or falsification of the content or appearance of this document is unlawful and offenders may be prosecuted to the fullest extent of the law.

Report Number :ER-2021-20085
 Operation Mode :802.11ac80
 Test Frequency :5610 MHz
 Test Mode :Tx CH Mid
 EUT Pol :H Plane

Test Site :SAC III Chamber
 Test Date :2021-03-05
 Temp./Humi. :21.8/63
 Antenna Pol. :VERTICAL
 Engineer :Ricky

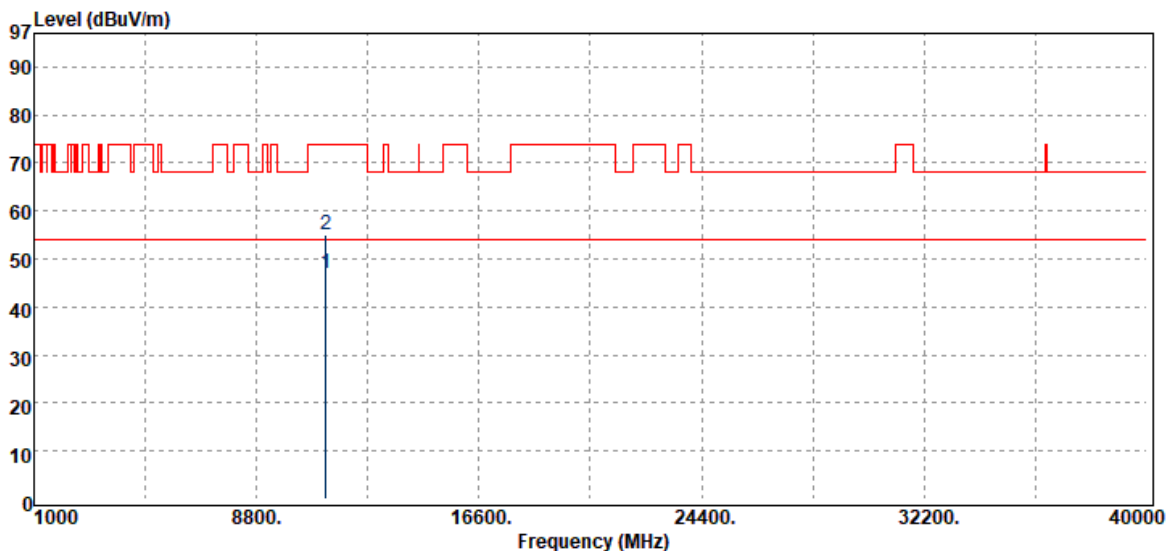

| Freq. MHz | Detector Mode PK/QP/AV | Spectrum Reading Level dB μ V | Factor dB | Actual FS dB μ V/m | Limit @3m dB μ V/m | Margin dB |
|--------------|------------------------------|---|--------------|------------------------------|------------------------------|--------------|
| 11220.00 | Average | 25.50 | 21.37 | 46.87 | 54.00 | -7.13 |
| 11220.00 | Peak | 33.60 | 21.37 | 54.97 | 74.00 | -19.03 |

Unless otherwise stated the results shown in this test report refer only to the sample(s) tested and such sample(s) are retained for 90 days only.

除非另有說明，此報告結果僅對測試之樣品負責，同時此樣品僅保留90天。本報告未經本公司書面許可，不可部份複製。

This document is issued by the Company subject to its General Conditions of Service printed overleaf, available on request or accessible at <http://www.sgs.com.tw/Terms-and-Conditions> and for electronic format documents, subject to Terms and Conditions for Electronic Documents at <http://www.sgs.com.tw/Terms-and-Conditions>. Attention is drawn to the limitation of liability, indemnification and jurisdiction issues defined therein. Any holder of this document is advised that information contained hereon reflects the Company's findings at the time of its intervention only and within the limits of Client's instructions, if any. The Company's sole responsibility is to its Client and this document does not exonerate parties to a transaction from exercising all their rights and obligations under the transaction documents. This document cannot be reproduced except in full, without prior written approval of the Company. Any unauthorized alteration, forgery or falsification of the content or appearance of this document is unlawful and offenders may be prosecuted to the fullest extent of the law.

Report Number :ER-2021-20085
 Operation Mode :802.11ac80
 Test Frequency :5610 MHz
 Test Mode :Tx CH Mid
 EUT Pol :H Plane

Test Site :SAC III Chamber
 Test Date :2021-03-05
 Temp./Humi. :21.8/63
 Antenna Pol. :HORIZONTAL
 Engineer :Ricky

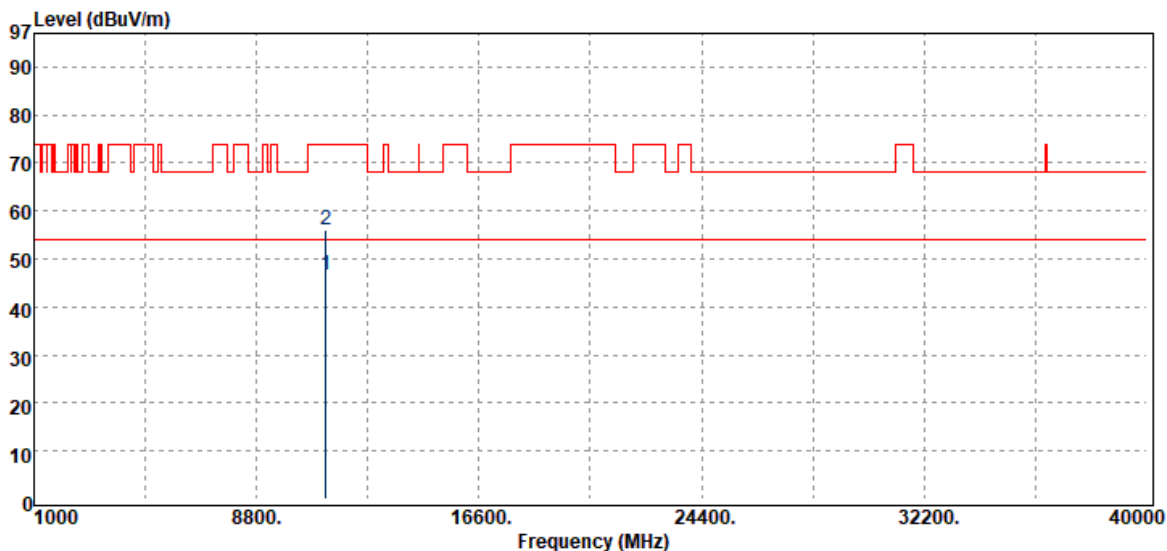

| Freq. MHz | Detector Mode PK/QP/AV | Spectrum Reading Level dB μ V | Factor dB | Actual FS dB μ V/m | Limit @3m dB μ V/m | Margin dB |
|--------------|------------------------------|---|--------------|------------------------------|------------------------------|--------------|
| 11220.00 | Average | 25.21 | 21.37 | 46.58 | 54.00 | -7.42 |
| 11220.00 | Peak | 34.60 | 21.37 | 55.97 | 74.00 | -18.03 |

Unless otherwise stated the results shown in this test report refer only to the sample(s) tested and such sample(s) are retained for 90 days only.

除非另有說明，此報告結果僅對測試之樣品負責，同時此樣品僅保留90天。本報告未經本公司書面許可，不可部份複製。

This document is issued by the Company subject to its General Conditions of Service printed overleaf, available on request or accessible at <http://www.sgs.com.tw/Terms-and-Conditions> and for electronic format documents, subject to Terms and Conditions for Electronic Documents at <http://www.sgs.com.tw/Terms-and-Conditions>. Attention is drawn to the limitation of liability, indemnification and jurisdiction issues defined therein. Any holder of this document is advised that information contained hereon reflects the Company's findings at the time of its intervention only and within the limits of Client's instructions, if any. The Company's sole responsibility is to its Client and this document does not exonerate parties to a transaction from exercising all their rights and obligations under the transaction documents. This document cannot be reproduced except in full, without prior written approval of the Company. Any unauthorized alteration, forgery or falsification of the content or appearance of this document is unlawful and offenders may be prosecuted to the fullest extent of the law.

Report Number :ER-2021-20085
 Operation Mode :802.11ac80
 Test Frequency :5690 MHz
 Test Mode :Tx CH High
 EUT Pol :H Plane

Test Site :SAC III Chamber
 Test Date :2021-03-05
 Temp./Humi. :21.8/63
 Antenna Pol. :VERTICAL
 Engineer :Ricky

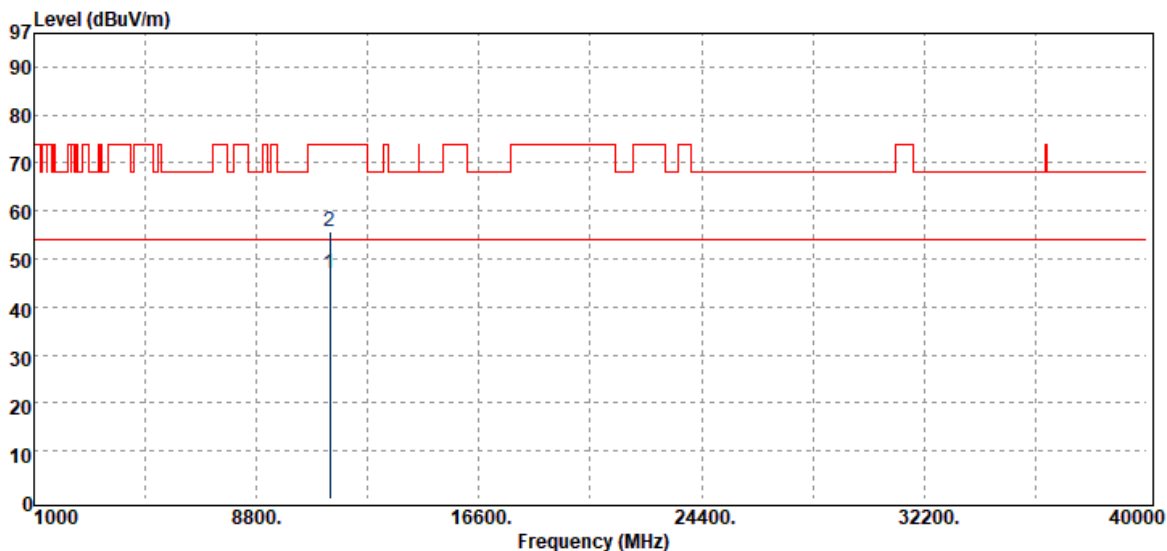

| Freq. MHz | Detector Mode PK/QP/AV | Spectrum Reading Level dBμV | Factor dB | Actual FS dBμV/m | Limit @3m dBμV/m | Margin dB |
|--------------|------------------------------|-----------------------------------|--------------|------------------------|------------------------|--------------|
| 11380.00 | Average | 25.23 | 21.81 | 47.04 | 54.00 | -6.96 |
| 11380.00 | Peak | 33.97 | 21.81 | 55.78 | 74.00 | -18.22 |

Unless otherwise stated the results shown in this test report refer only to the sample(s) tested and such sample(s) are retained for 90 days only.

除非另有說明，此報告結果僅對測試之樣品負責，同時此樣品僅保留90天。本報告未經本公司書面許可，不可部份複製。

This document is issued by the Company subject to its General Conditions of Service printed overleaf, available on request or accessible at <http://www.sgs.com.tw/Terms-and-Conditions> and for electronic format documents, subject to Terms and Conditions for Electronic Documents at <http://www.sgs.com.tw/Terms-and-Conditions>. Attention is drawn to the limitation of liability, indemnification and jurisdiction issues defined therein. Any holder of this document is advised that information contained hereon reflects the Company's findings at the time of its intervention only and within the limits of Client's instructions, if any. The Company's sole responsibility is to its Client and this document does not exonerate parties to a transaction from exercising all their rights and obligations under the transaction documents. This document cannot be reproduced except in full, without prior written approval of the Company. Any unauthorized alteration, forgery or falsification of the content or appearance of this document is unlawful and offenders may be prosecuted to the fullest extent of the law.

Report Number :ER-2021-20085
 Operation Mode :802.11ac80
 Test Frequency :5690 MHz
 Test Mode :Tx CH High
 EUT Pol :H Plane

Test Site :SAC III Chamber
 Test Date :2021-03-05
 Temp./Humi. :21.8/63
 Antenna Pol. :HORIZONTAL
 Engineer :Ricky

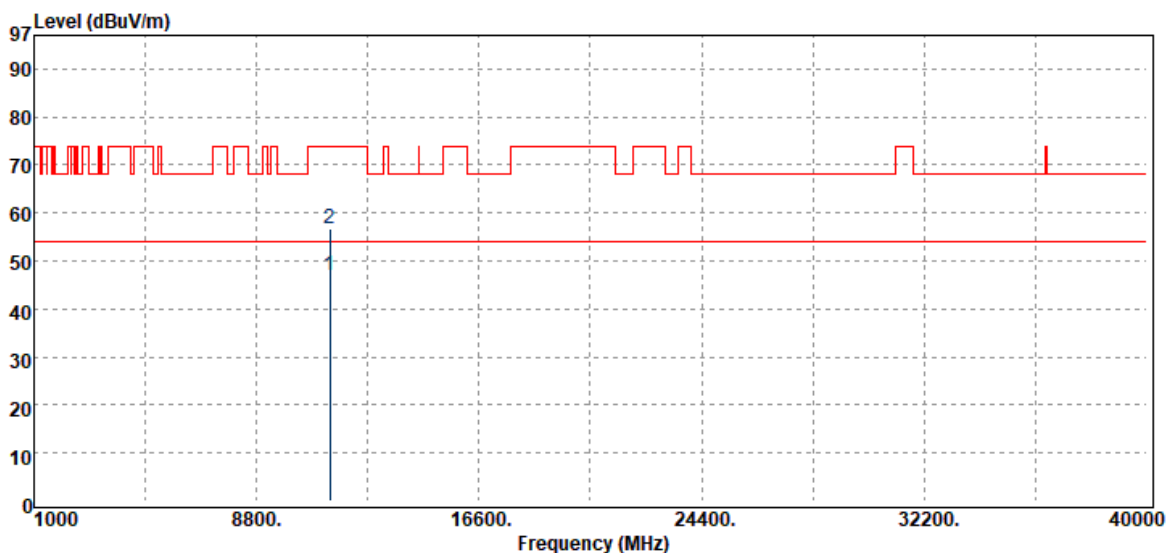

| Freq. MHz | Detector Mode PK/QP/AV | Spectrum Reading Level dB μ V | Factor dB | Actual FS dB μ V/m | Limit @3m dB μ V/m | Margin dB |
|--------------|------------------------------|---|--------------|------------------------------|------------------------------|--------------|
| 11380.00 | Average | 25.20 | 21.81 | 47.01 | 54.00 | -6.99 |
| 11380.00 | Peak | 34.89 | 21.81 | 56.70 | 74.00 | -17.30 |

Unless otherwise stated the results shown in this test report refer only to the sample(s) tested and such sample(s) are retained for 90 days only.

除非另有說明，此報告結果僅對測試之樣品負責，同時此樣品僅保留90天。本報告未經本公司書面許可，不可部份複製。

This document is issued by the Company subject to its General Conditions of Service printed overleaf, available on request or accessible at <http://www.sgs.com.tw/Terms-and-Conditions> and for electronic format documents, subject to Terms and Conditions for Electronic Documents at <http://www.sgs.com.tw/Terms-and-Conditions>. Attention is drawn to the limitation of liability, indemnification and jurisdiction issues defined therein. Any holder of this document is advised that information contained hereon reflects the Company's findings at the time of its intervention only and within the limits of Client's instructions, if any. The Company's sole responsibility is to its Client and this document does not exonerate parties to a transaction from exercising all their rights and obligations under the transaction documents. This document cannot be reproduced except in full, without prior written approval of the Company. Any unauthorized alteration, forgery or falsification of the content or appearance of this document is unlawful and offenders may be prosecuted to the fullest extent of the law.

Report Number :ER-2021-20085
 Operation Mode :802.11ac80
 Test Frequency :5775 MHz
 Test Mode :Tx CH Low
 EUT Pol :H Plane

Test Site :SAC III Chamber
 Test Date :2021-03-05
 Temp./Humi. :21.8/63
 Antenna Pol. :VERTICAL
 Engineer :Ricky

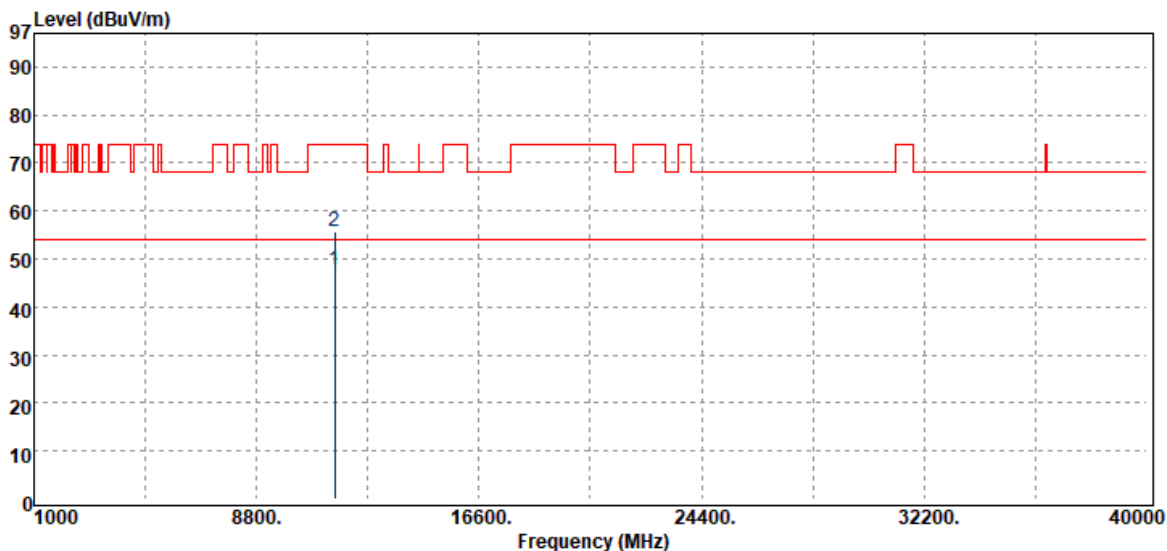

| Freq. MHz | Detector Mode PK/QP/AV | Spectrum Reading Level dB μ V | Factor dB | Actual FS dB μ V/m | Limit @3m dB μ V/m | Margin dB |
|--------------|------------------------------|---|--------------|------------------------------|------------------------------|--------------|
| 11550.00 | Average | 25.08 | 22.52 | 47.60 | 54.00 | -6.40 |
| 11550.00 | Peak | 33.21 | 22.52 | 55.73 | 74.00 | -18.27 |

Unless otherwise stated the results shown in this test report refer only to the sample(s) tested and such sample(s) are retained for 90 days only.

除非另有說明，此報告結果僅對測試之樣品負責，同時此樣品僅保留90天。本報告未經本公司書面許可，不可部份複製。

This document is issued by the Company subject to its General Conditions of Service printed overleaf, available on request or accessible at <http://www.sgs.com.tw/Terms-and-Conditions> and for electronic format documents, subject to Terms and Conditions for Electronic Documents at <http://www.sgs.com.tw/Terms-and-Conditions>. Attention is drawn to the limitation of liability, indemnification and jurisdiction issues defined therein. Any holder of this document is advised that information contained hereon reflects the Company's findings at the time of its intervention only and within the limits of Client's instructions, if any. The Company's sole responsibility is to its Client and this document does not exonerate parties to a transaction from exercising all their rights and obligations under the transaction documents. This document cannot be reproduced except in full, without prior written approval of the Company. Any unauthorized alteration, forgery or falsification of the content or appearance of this document is unlawful and offenders may be prosecuted to the fullest extent of the law.

Report Number :ER-2021-20085
 Operation Mode :802.11ac80
 Test Frequency :5775 MHz
 Test Mode :Tx CH Low
 EUT Pol :H Plane

Test Site :SAC III Chamber
 Test Date :2021-03-05
 Temp./Humi. :21.8/63
 Antenna Pol. :HORIZONTAL
 Engineer :Ricky

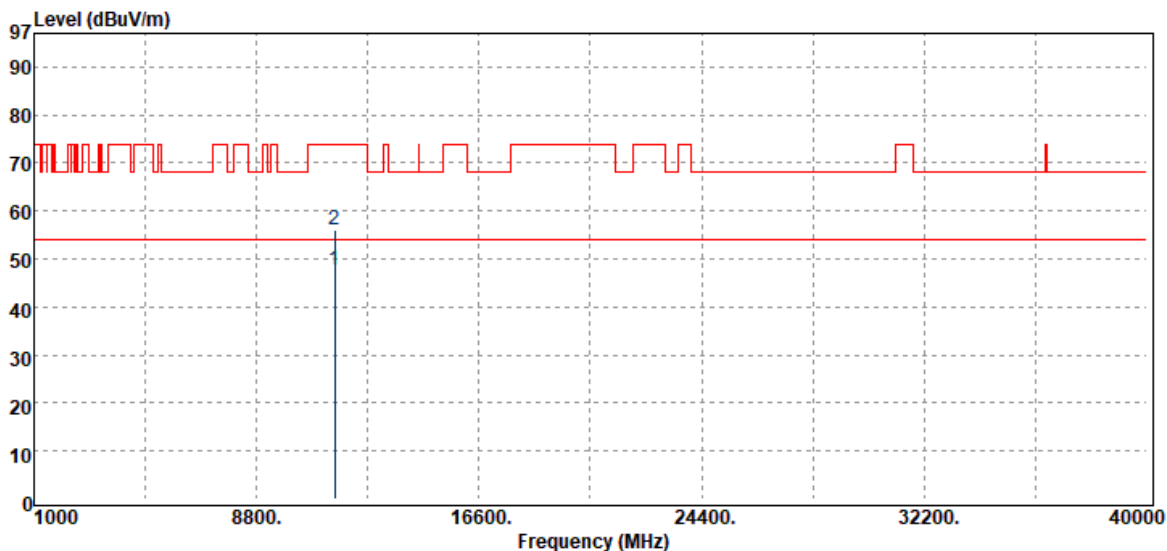

| Freq. MHz | Detector Mode PK/QP/AV | Spectrum Reading Level dB μ V | Factor dB | Actual FS dB μ V/m | Limit @3m dB μ V/m | Margin dB |
|--------------|------------------------------|---|--------------|------------------------------|------------------------------|--------------|
| 11550.00 | Average | 25.05 | 22.52 | 47.57 | 54.00 | -6.43 |
| 11550.00 | Peak | 33.39 | 22.52 | 55.91 | 74.00 | -18.09 |

Unless otherwise stated the results shown in this test report refer only to the sample(s) tested and such sample(s) are retained for 90 days only.

除非另有說明，此報告結果僅對測試之樣品負責，同時此樣品僅保留90天。本報告未經本公司書面許可，不可部份複製。

This document is issued by the Company subject to its General Conditions of Service printed overleaf, available on request or accessible at <http://www.sgs.com.tw/Terms-and-Conditions> and for electronic format documents, subject to Terms and Conditions for Electronic Documents at <http://www.sgs.com.tw/Terms-and-Conditions>. Attention is drawn to the limitation of liability, indemnification and jurisdiction issues defined therein. Any holder of this document is advised that information contained hereon reflects the Company's findings at the time of its intervention only and within the limits of Client's instructions, if any. The Company's sole responsibility is to its Client and this document does not exonerate parties to a transaction from exercising all their rights and obligations under the transaction documents. This document cannot be reproduced except in full, without prior written approval of the Company. Any unauthorized alteration, forgery or falsification of the content or appearance of this document is unlawful and offenders may be prosecuted to the fullest extent of the law.

Report Number :ER-2021-20085
 Operation Mode :802.11ax20
 Test Frequency :5180 MHz
 Test Mode :Tx CH Low
 EUT Pol :H Plane

Test Site :SAC III Chamber
 Test Date :2021-03-05
 Temp./Humi. :21.8/63
 Antenna Pol. :VERTICAL
 Engineer :Ricky

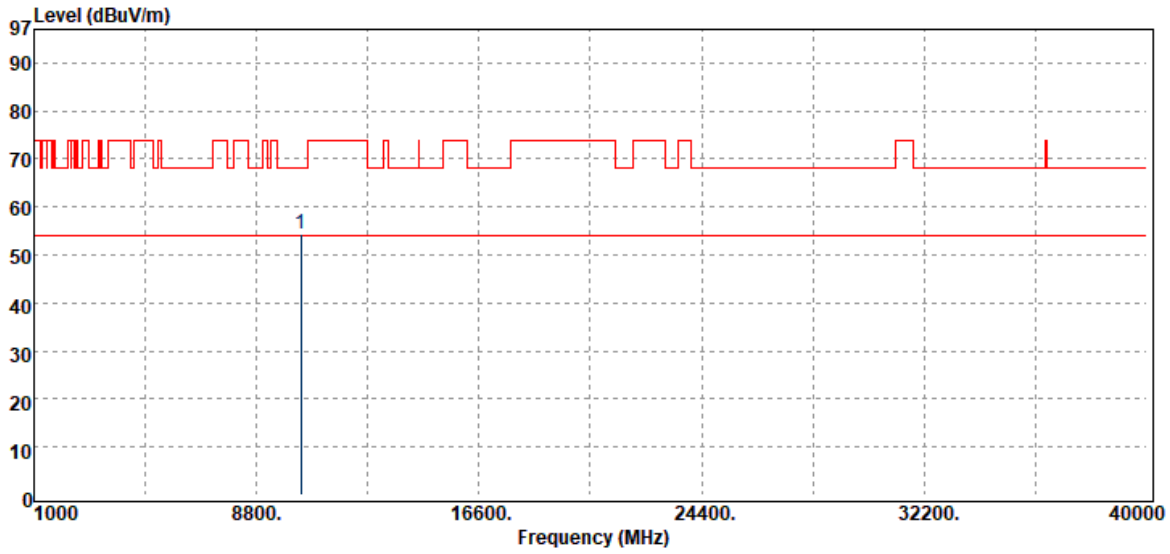

| Freq. MHz | Detector Mode PK/QP/AV | Spectrum Reading Level dB μ V | Factor dB | Actual FS dB μ V/m | Limit @3m dB μ V/m | Margin dB |
|--------------|------------------------------|---|--------------|------------------------------|------------------------------|--------------|
| 10360.00 | Peak | 34.36 | 19.87 | 54.23 | 68.20 | -13.97 |

Unless otherwise stated the results shown in this test report refer only to the sample(s) tested and such sample(s) are retained for 90 days only.

除非另有說明，此報告結果僅對測試之樣品負責，同時此樣品僅保留90天。本報告未經本公司書面許可，不可部份複製。
 This document is issued by the Company subject to its General Conditions of Service printed overleaf, available on request or accessible at <http://www.sgs.com.tw/Terms-and-Conditions> and for electronic format documents, subject to Terms and Conditions for Electronic Documents at <http://www.sgs.com.tw/Terms-and-Conditions>. Attention is drawn to the limitation of liability, indemnification and jurisdiction issues defined therein. Any holder of this document is advised that information contained hereon reflects the Company's findings at the time of its intervention only and within the limits of Client's instructions, if any. The Company's sole responsibility is to its Client and this document does not exonerate parties to a transaction from exercising all their rights and obligations under the transaction documents. This document cannot be reproduced except in full, without prior written approval of the Company. Any unauthorized alteration, forgery or falsification of the content or appearance of this document is unlawful and offenders may be prosecuted to the fullest extent of the law.

Report Number :ER-2021-20085
 Operation Mode :802.11ax20
 Test Frequency :5180 MHz
 Test Mode :Tx CH Low
 EUT Pol :H Plane

Test Site :SAC III Chamber
 Test Date :2021-03-05
 Temp./Humi. :21.8/63
 Antenna Pol. :HORIZONTAL
 Engineer :Ricky

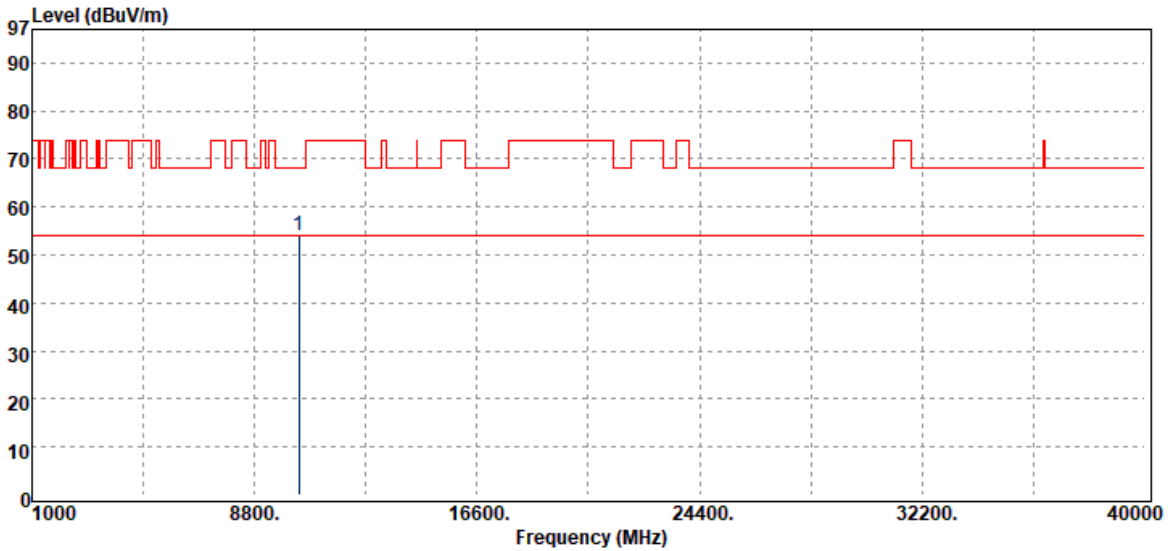

| Freq. MHz | Detector Mode PK/QP/AV | Spectrum Reading Level dB μ V | Factor dB | Actual FS dB μ V/m | Limit @3m dB μ V/m | Margin dB |
|--------------|------------------------------|---|--------------|------------------------------|------------------------------|--------------|
| 10360.00 | Peak | 34.21 | 19.87 | 54.08 | 68.20 | -14.12 |

Unless otherwise stated the results shown in this test report refer only to the sample(s) tested and such sample(s) are retained for 90 days only.

除非另有說明，此報告結果僅對測試之樣品負責，同時此樣品僅保留90天。本報告未經本公司書面許可，不可部份複製。

This document is issued by the Company subject to its General Conditions of Service printed overleaf, available on request or accessible at <http://www.sgs.com.tw/Terms-and-Conditions> and for electronic format documents, subject to Terms and Conditions for Electronic Documents at <http://www.sgs.com.tw/Terms-and-Conditions>. Attention is drawn to the limitation of liability, indemnification and jurisdiction issues defined therein. Any holder of this document is advised that information contained hereon reflects the Company's findings at the time of its intervention only and within the limits of Client's instructions, if any. The Company's sole responsibility is to its Client and this document does not exonerate parties to a transaction from exercising all their rights and obligations under the transaction documents. This document cannot be reproduced except in full, without prior written approval of the Company. Any unauthorized alteration, forgery or falsification of the content or appearance of this document is unlawful and offenders may be prosecuted to the fullest extent of the law.

Report Number :ER-2021-20085
 Operation Mode :802.11ax20
 Test Frequency :5220 MHz
 Test Mode :Tx CH Mid
 EUT Pol :H Plane

Test Site :SAC III Chamber
 Test Date :2021-03-05
 Temp./Humi. :21.8/63
 Antenna Pol. :VERTICAL
 Engineer :Ricky

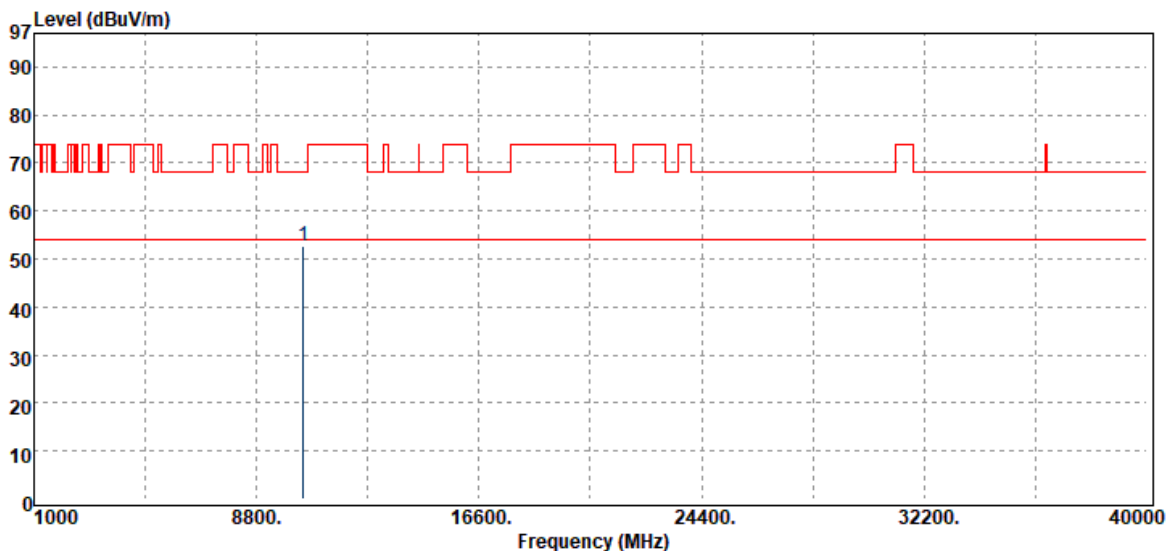

| Freq. MHz | Detector Mode PK/QP/AV | Spectrum Reading Level dB μ V | Factor dB | Actual FS dB μ V/m | Limit @3m dB μ V/m | Margin dB |
|--------------|------------------------------|---|--------------|------------------------------|------------------------------|--------------|
| 10440.00 | Peak | 33.62 | 19.15 | 52.77 | 68.20 | -15.43 |

Unless otherwise stated the results shown in this test report refer only to the sample(s) tested and such sample(s) are retained for 90 days only.

除非另有說明，此報告結果僅對測試之樣品負責，同時此樣品僅保留90天。本報告未經本公司書面許可，不可部份複製。

This document is issued by the Company subject to its General Conditions of Service printed overleaf, available on request or accessible at <http://www.sgs.com.tw/Terms-and-Conditions> and for electronic format documents, subject to Terms and Conditions for Electronic Documents at <http://www.sgs.com.tw/Terms-and-Conditions>. Attention is drawn to the limitation of liability, indemnification and jurisdiction issues defined therein. Any holder of this document is advised that information contained hereon reflects the Company's findings at the time of its intervention only and within the limits of Client's instructions, if any. The Company's sole responsibility is to its Client and this document does not exonerate parties to a transaction from exercising all their rights and obligations under the transaction documents. This document cannot be reproduced except in full, without prior written approval of the Company. Any unauthorized alteration, forgery or falsification of the content or appearance of this document is unlawful and offenders may be prosecuted to the fullest extent of the law.

| | | | |
|----------------|----------------|--------------|------------------|
| Report Number | :ER-2021-20085 | Test Site | :SAC III Chamber |
| Operation Mode | :802.11ax20 | Test Date | :2021-03-05 |
| Test Frequency | :5220 MHz | Temp./Humi. | :21.8/63 |
| Test Mode | :Tx CH Mid | Antenna Pol. | :HORIZONTAL |
| EUT Pol | :H Plane | Engineer | :Ricky |

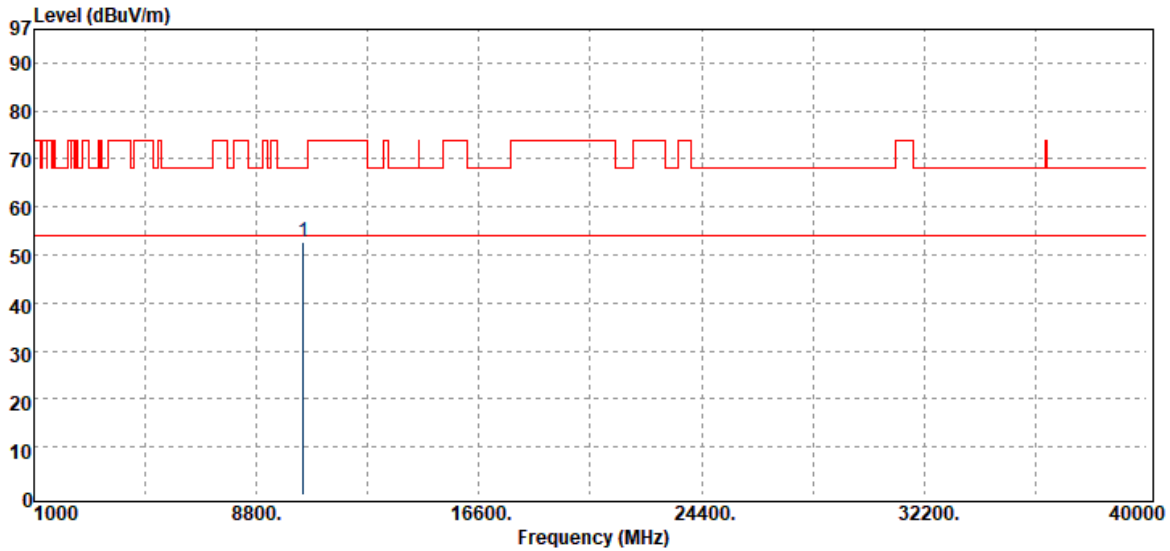

| Freq. MHz | Detector Mode PK/QP/AV | Spectrum Reading Level dB μ V | Factor dB | Actual FS dB μ V/m | Limit @3m dB μ V/m | Margin dB |
|--------------|------------------------------|---|--------------|------------------------------|------------------------------|--------------|
| 10440.00 | Peak | 33.39 | 19.15 | 52.54 | 68.20 | -15.66 |

Unless otherwise stated the results shown in this test report refer only to the sample(s) tested and such sample(s) are retained for 90 days only.

除非另有說明，此報告結果僅對測試之樣品負責，同時此樣品僅保留90天。本報告未經本公司書面許可，不可部份複製。

This document is issued by the Company subject to its General Conditions of Service printed overleaf, available on request or accessible at <http://www.sgs.com.tw/Terms-and-Conditions> and for electronic format documents, subject to Terms and Conditions for Electronic Documents at <http://www.sgs.com.tw/Terms-and-Conditions>. Attention is drawn to the limitation of liability, indemnification and jurisdiction issues defined therein. Any holder of this document is advised that information contained hereon reflects the Company's findings at the time of its intervention only and within the limits of Client's instructions, if any. The Company's sole responsibility is to its Client and this document does not exonerate parties to a transaction from exercising all their rights and obligations under the transaction documents. This document cannot be reproduced except in full, without prior written approval of the Company. Any unauthorized alteration, forgery or falsification of the content or appearance of this document is unlawful and offenders may be prosecuted to the fullest extent of the law.

Report Number :ER-2021-20085
 Operation Mode :802.11ax20
 Test Frequency :5240 MHz
 Test Mode :Tx CH High
 EUT Pol :H Plane

Test Site :SAC III Chamber
 Test Date :2021-03-05
 Temp./Humi. :21.8/63
 Antenna Pol. :VERTICAL
 Engineer :Ricky

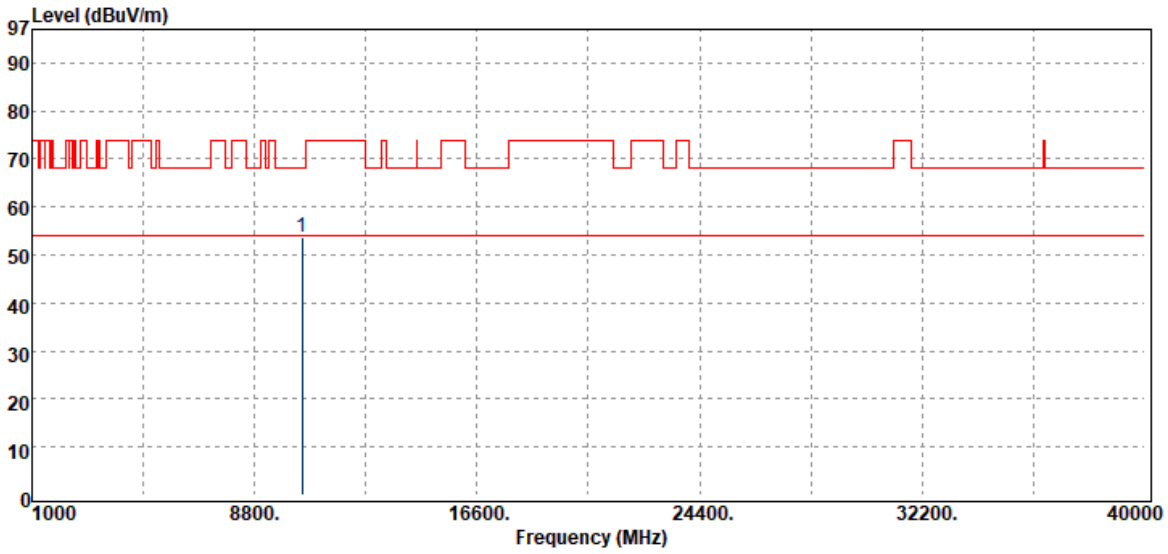

| Freq. MHz | Detector Mode PK/QP/AV | Spectrum Reading Level dB μ V | Factor dB | Actual FS dB μ V/m | Limit @3m dB μ V/m | Margin dB |
|--------------|------------------------------|---|--------------|------------------------------|------------------------------|--------------|
| 10480.00 | Peak | 34.01 | 19.56 | 53.57 | 68.20 | -14.63 |

Unless otherwise stated the results shown in this test report refer only to the sample(s) tested and such sample(s) are retained for 90 days only.

除非另有說明，此報告結果僅對測試之樣品負責，同時此樣品僅保留90天。本報告未經本公司書面許可，不可部份複製。
 This document is issued by the Company subject to its General Conditions of Service printed overleaf, available on request or accessible at <http://www.sgs.com.tw/Terms-and-Conditions> and for electronic format documents, subject to Terms and Conditions for Electronic Documents at <http://www.sgs.com.tw/Terms-and-Conditions>. Attention is drawn to the limitation of liability, indemnification and jurisdiction issues defined therein. Any holder of this document is advised that information contained hereon reflects the Company's findings at the time of its intervention only and within the limits of Client's instructions, if any. The Company's sole responsibility is to its Client and this document does not exonerate parties to a transaction from exercising all their rights and obligations under the transaction documents. This document cannot be reproduced except in full, without prior written approval of the Company. Any unauthorized alteration, forgery or falsification of the content or appearance of this document is unlawful and offenders may be prosecuted to the fullest extent of the law.

Report Number :ER-2021-20085
 Operation Mode :802.11ax20
 Test Frequency :5240 MHz
 Test Mode :Tx CH High
 EUT Pol :H Plane

Test Site :SAC III Chamber
 Test Date :2021-03-05
 Temp./Humi. :21.8/63
 Antenna Pol. :HORIZONTAL
 Engineer :Ricky

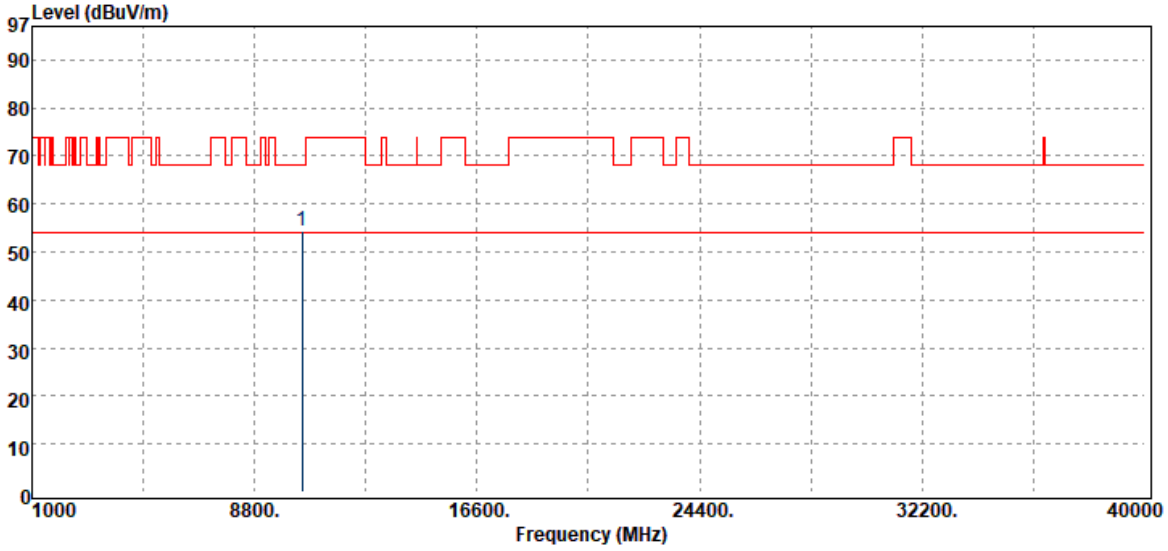

| Freq. MHz | Detector Mode PK/QP/AV | Spectrum Reading Level dB μ V | Factor dB | Actual FS dB μ V/m | Limit @3m dB μ V/m | Margin dB |
|--------------|------------------------------|---|--------------|------------------------------|------------------------------|--------------|
| 10480.00 | Peak | 34.73 | 19.56 | 54.29 | 68.20 | -13.91 |

Unless otherwise stated the results shown in this test report refer only to the sample(s) tested and such sample(s) are retained for 90 days only.

除非另有說明，此報告結果僅對測試之樣品負責，同時此樣品僅保留90天。本報告未經本公司書面許可，不可部份複製。

This document is issued by the Company subject to its General Conditions of Service printed overleaf, available on request or accessible at <http://www.sgs.com.tw/Terms-and-Conditions> and for electronic format documents, subject to Terms and Conditions for Electronic Documents at <http://www.sgs.com.tw/Terms-and-Conditions>. Attention is drawn to the limitation of liability, indemnification and jurisdiction issues defined therein. Any holder of this document is advised that information contained hereon reflects the Company's findings at the time of its intervention only and within the limits of Client's instructions, if any. The Company's sole responsibility is to its Client and this document does not exonerate parties to a transaction from exercising all their rights and obligations under the transaction documents. This document cannot be reproduced except in full, without prior written approval of the Company. Any unauthorized alteration, forgery or falsification of the content or appearance of this document is unlawful and offenders may be prosecuted to the fullest extent of the law.

Report Number :ER-2021-20085
 Operation Mode :802.11ax20
 Test Frequency :5260 MHz
 Test Mode :Tx CH Low
 EUT Pol :H Plane

Test Site :SAC III Chamber
 Test Date :2021-03-05
 Temp./Humi. :21.8/63
 Antenna Pol. :VERTICAL
 Engineer :Ricky

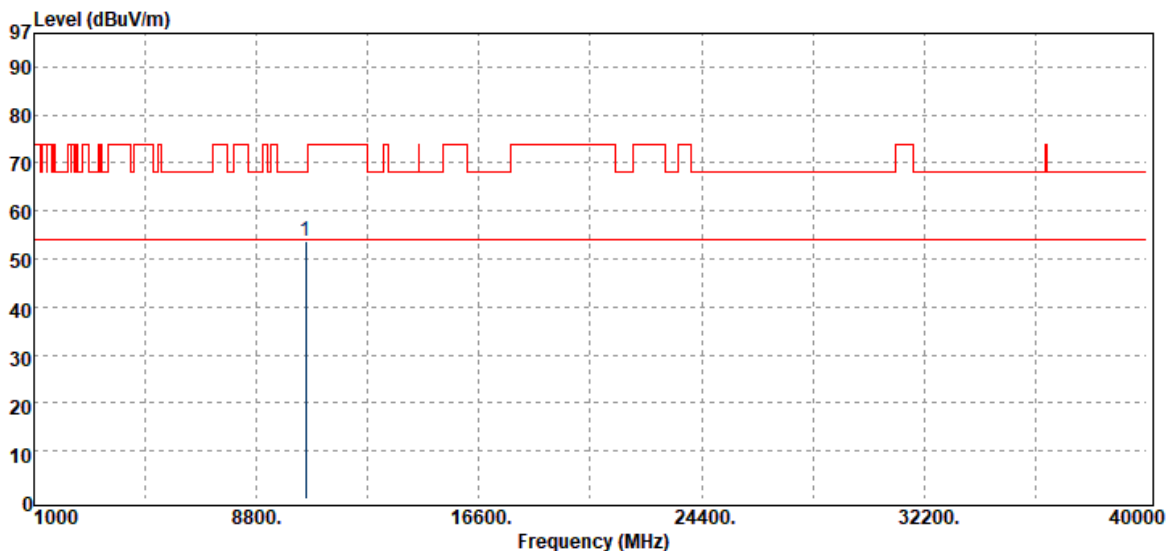

| Freq. MHz | Detector Mode PK/QP/AV | Spectrum Reading Level dB μ V | Factor dB | Actual FS dB μ V/m | Limit @3m dB μ V/m | Margin dB |
|--------------|------------------------------|---|--------------|------------------------------|------------------------------|--------------|
| 10520.00 | Peak | 33.96 | 19.84 | 53.80 | 68.20 | -14.40 |

Unless otherwise stated the results shown in this test report refer only to the sample(s) tested and such sample(s) are retained for 90 days only.

除非另有說明，此報告結果僅對測試之樣品負責，同時此樣品僅保留90天。本報告未經本公司書面許可，不可部份複製。

This document is issued by the Company subject to its General Conditions of Service printed overleaf, available on request or accessible at <http://www.sgs.com.tw/Terms-and-Conditions> and for electronic format documents, subject to Terms and Conditions for Electronic Documents at <http://www.sgs.com.tw/Terms-and-Conditions>. Attention is drawn to the limitation of liability, indemnification and jurisdiction issues defined therein. Any holder of this document is advised that information contained hereon reflects the Company's findings at the time of its intervention only and within the limits of Client's instructions, if any. The Company's sole responsibility is to its Client and this document does not exonerate parties to a transaction from exercising all their rights and obligations under the transaction documents. This document cannot be reproduced except in full, without prior written approval of the Company. Any unauthorized alteration, forgery or falsification of the content or appearance of this document is unlawful and offenders may be prosecuted to the fullest extent of the law.

Report Number :ER-2021-20085
 Operation Mode :802.11ax20
 Test Frequency :5260 MHz
 Test Mode :Tx CH Low
 EUT Pol :H Plane

Test Site :SAC III Chamber
 Test Date :2021-03-05
 Temp./Humi. :21.8/63
 Antenna Pol. :HORIZONTAL
 Engineer :Ricky

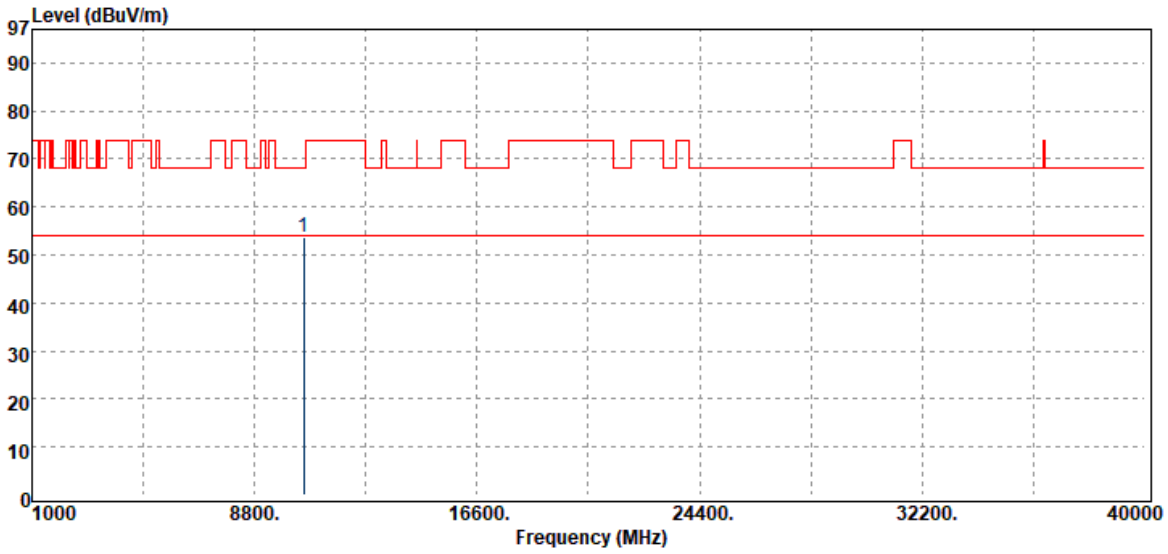

| Freq. MHz | Detector Mode PK/QP/AV | Spectrum Reading Level dB μ V | Factor dB | Actual FS dB μ V/m | Limit @3m dB μ V/m | Margin dB |
|--------------|------------------------------|---|--------------|------------------------------|------------------------------|--------------|
| 10520.00 | Peak | 34.01 | 19.84 | 53.85 | 68.20 | -14.35 |

Unless otherwise stated the results shown in this test report refer only to the sample(s) tested and such sample(s) are retained for 90 days only.

除非另有說明，此報告結果僅對測試之樣品負責，同時此樣品僅保留90天。本報告未經本公司書面許可，不可部份複製。

This document is issued by the Company subject to its General Conditions of Service printed overleaf, available on request or accessible at <http://www.sgs.com.tw/Terms-and-Conditions> and for electronic format documents, subject to Terms and Conditions for Electronic Documents at <http://www.sgs.com.tw/Terms-and-Conditions>. Attention is drawn to the limitation of liability, indemnification and jurisdiction issues defined therein. Any holder of this document is advised that information contained hereon reflects the Company's findings at the time of its intervention only and within the limits of Client's instructions, if any. The Company's sole responsibility is to its Client and this document does not exonerate parties to a transaction from exercising all their rights and obligations under the transaction documents. This document cannot be reproduced except in full, without prior written approval of the Company. Any unauthorized alteration, forgery or falsification of the content or appearance of this document is unlawful and offenders may be prosecuted to the fullest extent of the law.

Report Number :ER-2021-20085
 Operation Mode :802.11ax20
 Test Frequency :5300 MHz
 Test Mode :Tx CH Mid
 EUT Pol :H Plane

Test Site :SAC III Chamber
 Test Date :2021-03-05
 Temp./Humi. :21.8/63
 Antenna Pol. :VERTICAL
 Engineer :Ricky

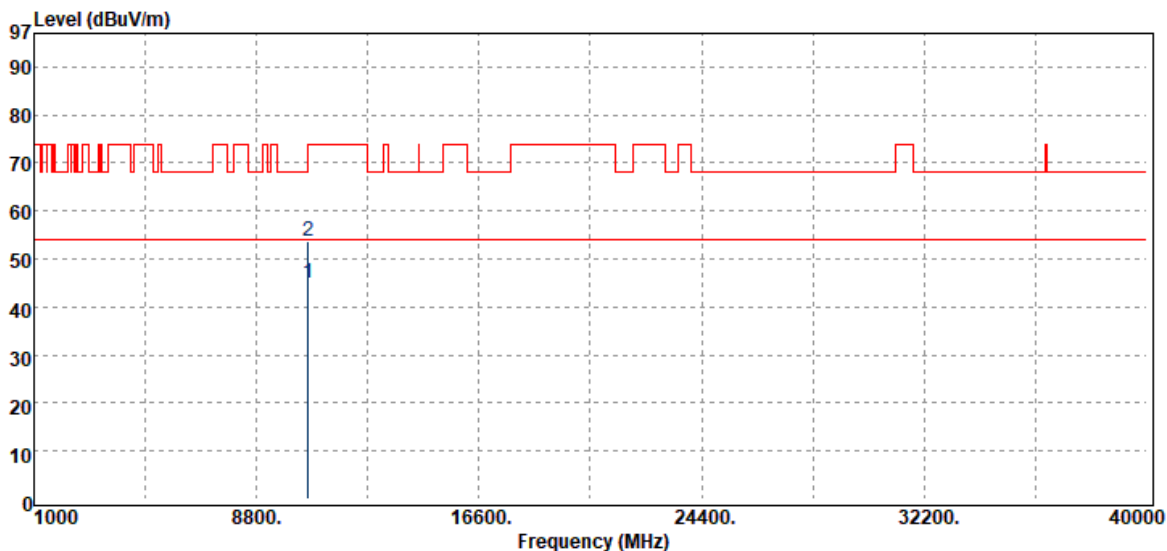

| Freq. MHz | Detector Mode PK/QP/AV | Spectrum Reading Level dB μ V | Factor dB | Actual FS dB μ V/m | Limit @3m dB μ V/m | Margin dB |
|--------------|------------------------------|---|--------------|------------------------------|------------------------------|--------------|
| 10600.00 | Average | 25.04 | 19.86 | 44.90 | 54.00 | -9.10 |
| 10600.00 | Peak | 33.82 | 19.86 | 53.68 | 74.00 | -20.32 |

Unless otherwise stated the results shown in this test report refer only to the sample(s) tested and such sample(s) are retained for 90 days only.

除非另有說明，此報告結果僅對測試之樣品負責，同時此樣品僅保留90天。本報告未經本公司書面許可，不可部份複製。

This document is issued by the Company subject to its General Conditions of Service printed overleaf, available on request or accessible at <http://www.sgs.com.tw/Terms-and-Conditions> and for electronic format documents, subject to Terms and Conditions for Electronic Documents at <http://www.sgs.com.tw/Terms-and-Conditions>. Attention is drawn to the limitation of liability, indemnification and jurisdiction issues defined therein. Any holder of this document is advised that information contained hereon reflects the Company's findings at the time of its intervention only and within the limits of Client's instructions, if any. The Company's sole responsibility is to its Client and this document does not exonerate parties to a transaction from exercising all their rights and obligations under the transaction documents. This document cannot be reproduced except in full, without prior written approval of the Company. Any unauthorized alteration, forgery or falsification of the content or appearance of this document is unlawful and offenders may be prosecuted to the fullest extent of the law.

Report Number :ER-2021-20085
 Operation Mode :802.11ax20
 Test Frequency :5300 MHz
 Test Mode :Tx CH Mid
 EUT Pol :H Plane

Test Site :SAC III Chamber
 Test Date :2021-03-05
 Temp./Humi. :21.8/63
 Antenna Pol. :HORIZONTAL
 Engineer :Ricky

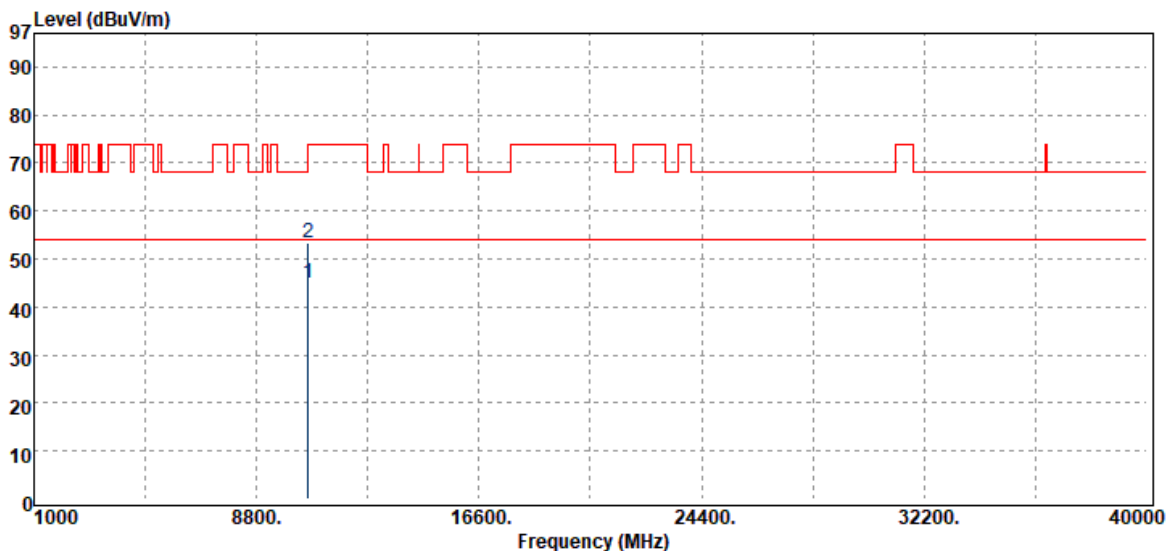

| Freq. MHz | Detector Mode PK/QP/AV | Spectrum Reading Level dB μ V | Factor dB | Actual FS dB μ V/m | Limit @3m dB μ V/m | Margin dB |
|--------------|------------------------------|---|--------------|------------------------------|------------------------------|--------------|
| 10600.00 | Average | 25.02 | 19.86 | 44.88 | 54.00 | -9.12 |
| 10600.00 | Peak | 33.48 | 19.86 | 53.34 | 74.00 | -20.66 |

Unless otherwise stated the results shown in this test report refer only to the sample(s) tested and such sample(s) are retained for 90 days only.

除非另有說明，此報告結果僅對測試之樣品負責，同時此樣品僅保留90天。本報告未經本公司書面許可，不可部份複製。

This document is issued by the Company subject to its General Conditions of Service printed overleaf, available on request or accessible at <http://www.sgs.com.tw/Terms-and-Conditions> and for electronic format documents, subject to Terms and Conditions for Electronic Documents at <http://www.sgs.com.tw/Terms-and-Conditions>. Attention is drawn to the limitation of liability, indemnification and jurisdiction issues defined therein. Any holder of this document is advised that information contained hereon reflects the Company's findings at the time of its intervention only and within the limits of Client's instructions, if any. The Company's sole responsibility is to its Client and this document does not exonerate parties to a transaction from exercising all their rights and obligations under the transaction documents. This document cannot be reproduced except in full, without prior written approval of the Company. Any unauthorized alteration, forgery or falsification of the content or appearance of this document is unlawful and offenders may be prosecuted to the fullest extent of the law.

Report Number :ER-2021-20085
 Operation Mode :802.11ax20
 Test Frequency :5320 MHz
 Test Mode :Tx CH High
 EUT Pol :H Plane

Test Site :SAC III Chamber
 Test Date :2021-03-05
 Temp./Humi. :21.8/63
 Antenna Pol. :VERTICAL
 Engineer :Ricky

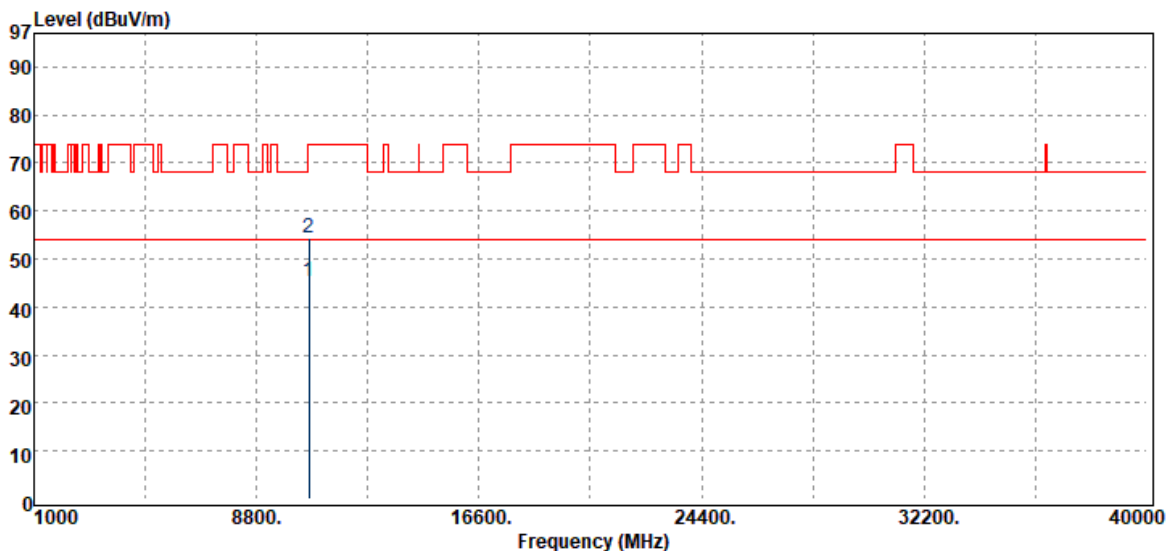

| Freq. MHz | Detector Mode PK/QP/AV | Spectrum Reading Level dB μ V | Factor dB | Actual FS dB μ V/m | Limit @3m dB μ V/m | Margin dB |
|--------------|------------------------------|---|--------------|------------------------------|------------------------------|--------------|
| 10640.00 | Average | 24.91 | 20.37 | 45.28 | 54.00 | -8.72 |
| 10640.00 | Peak | 33.96 | 20.37 | 54.33 | 74.00 | -19.67 |

Unless otherwise stated the results shown in this test report refer only to the sample(s) tested and such sample(s) are retained for 90 days only.

除非另有說明，此報告結果僅對測試之樣品負責，同時此樣品僅保留90天。本報告未經本公司書面許可，不可部份複製。

This document is issued by the Company subject to its General Conditions of Service printed overleaf, available on request or accessible at <http://www.sgs.com.tw/Terms-and-Conditions> and for electronic format documents, subject to Terms and Conditions for Electronic Documents at <http://www.sgs.com.tw/Terms-and-Conditions>. Attention is drawn to the limitation of liability, indemnification and jurisdiction issues defined therein. Any holder of this document is advised that information contained hereon reflects the Company's findings at the time of its intervention only and within the limits of Client's instructions, if any. The Company's sole responsibility is to its Client and this document does not exonerate parties to a transaction from exercising all their rights and obligations under the transaction documents. This document cannot be reproduced except in full, without prior written approval of the Company. Any unauthorized alteration, forgery or falsification of the content or appearance of this document is unlawful and offenders may be prosecuted to the fullest extent of the law.

Report Number :ER-2021-20085
 Operation Mode :802.11ax20
 Test Frequency :5320 MHz
 Test Mode :Tx CH High
 EUT Pol :H Plane

Test Site :SAC III Chamber
 Test Date :2021-03-05
 Temp./Humi. :21.8/63
 Antenna Pol. :HORIZONTAL
 Engineer :Ricky

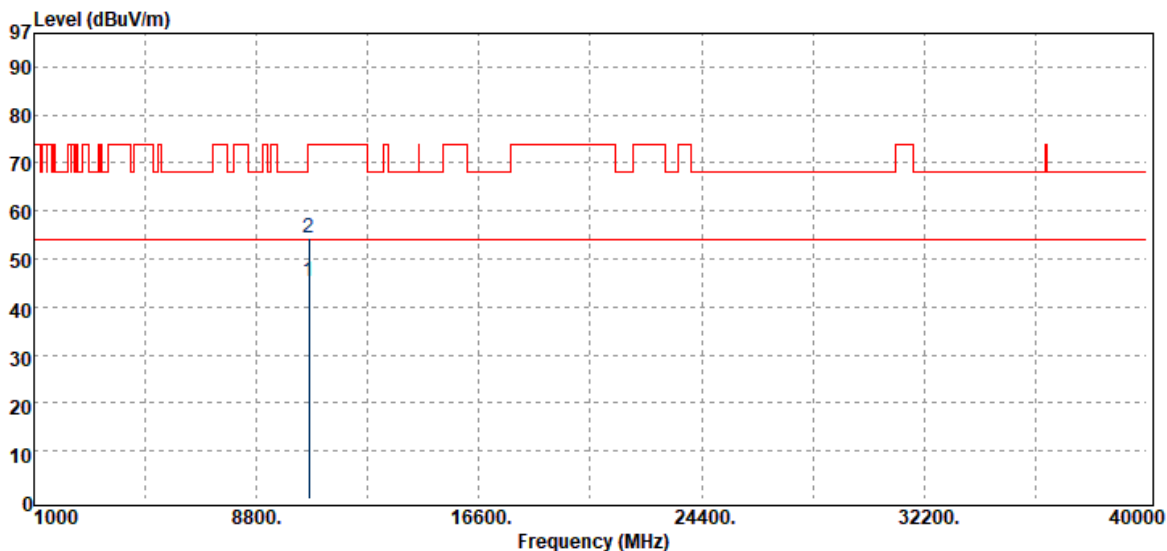

| Freq. MHz | Detector Mode PK/QP/AV | Spectrum Reading Level dB μ V | Factor dB | Actual FS dB μ V/m | Limit @3m dB μ V/m | Margin dB |
|--------------|------------------------------|---|--------------|------------------------------|------------------------------|--------------|
| 10640.00 | Average | 24.92 | 20.37 | 45.29 | 54.00 | -8.71 |
| 10640.00 | Peak | 34.01 | 20.37 | 54.38 | 74.00 | -19.62 |

Unless otherwise stated the results shown in this test report refer only to the sample(s) tested and such sample(s) are retained for 90 days only.

除非另有說明，此報告結果僅對測試之樣品負責，同時此樣品僅保留90天。本報告未經本公司書面許可，不可部份複製。

This document is issued by the Company subject to its General Conditions of Service printed overleaf, available on request or accessible at <http://www.sgs.com.tw/Terms-and-Conditions> and for electronic format documents, subject to Terms and Conditions for Electronic Documents at <http://www.sgs.com.tw/Terms-and-Conditions>. Attention is drawn to the limitation of liability, indemnification and jurisdiction issues defined therein. Any holder of this document is advised that information contained hereon reflects the Company's findings at the time of its intervention only and within the limits of Client's instructions, if any. The Company's sole responsibility is to its Client and this document does not exonerate parties to a transaction from exercising all their rights and obligations under the transaction documents. This document cannot be reproduced except in full, without prior written approval of the Company. Any unauthorized alteration, forgery or falsification of the content or appearance of this document is unlawful and offenders may be prosecuted to the fullest extent of the law.

Report Number :ER-2021-20085
 Operation Mode :802.11ax20
 Test Frequency :5500 MHz
 Test Mode :Tx CH Low
 EUT Pol :H Plane

Test Site :SAC III Chamber
 Test Date :2021-03-05
 Temp./Humi. :21.8/63
 Antenna Pol. :VERTICAL
 Engineer :Ricky

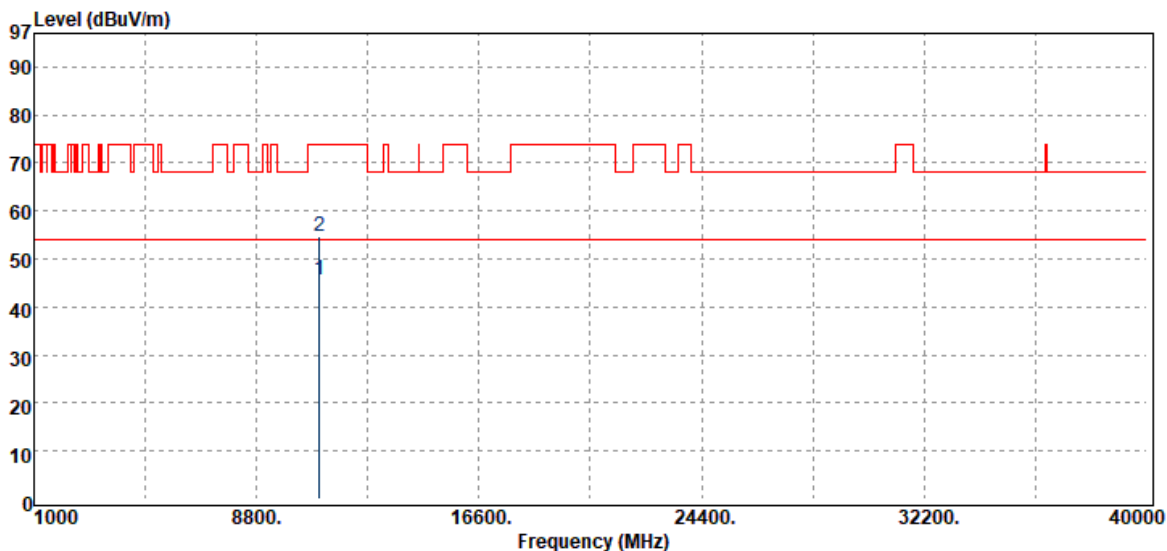

| Freq. MHz | Detector Mode PK/QP/AV | Spectrum Reading Level dB μ V | Factor dB | Actual FS dB μ V/m | Limit @3m dB μ V/m | Margin dB |
|--------------|------------------------------|---|--------------|------------------------------|------------------------------|--------------|
| 11000.00 | Average | 24.90 | 20.90 | 45.80 | 54.00 | -8.20 |
| 11000.00 | Peak | 33.87 | 20.90 | 54.77 | 74.00 | -19.23 |

Unless otherwise stated the results shown in this test report refer only to the sample(s) tested and such sample(s) are retained for 90 days only.

除非另有說明，此報告結果僅對測試之樣品負責，同時此樣品僅保留90天。本報告未經本公司書面許可，不可部份複製。

This document is issued by the Company subject to its General Conditions of Service printed overleaf, available on request or accessible at <http://www.sgs.com.tw/Terms-and-Conditions> and for electronic format documents, subject to Terms and Conditions for Electronic Documents at <http://www.sgs.com.tw/Terms-and-Conditions>. Attention is drawn to the limitation of liability, indemnification and jurisdiction issues defined therein. Any holder of this document is advised that information contained hereon reflects the Company's findings at the time of its intervention only and within the limits of Client's instructions, if any. The Company's sole responsibility is to its Client and this document does not exonerate parties to a transaction from exercising all their rights and obligations under the transaction documents. This document cannot be reproduced except in full, without prior written approval of the Company. Any unauthorized alteration, forgery or falsification of the content or appearance of this document is unlawful and offenders may be prosecuted to the fullest extent of the law.

Report Number :ER-2021-20085
 Operation Mode :802.11ax20
 Test Frequency :5500 MHz
 Test Mode :Tx CH Low
 EUT Pol :H Plane

Test Site :SAC III Chamber
 Test Date :2021-03-05
 Temp./Humi. :21.8/63
 Antenna Pol. :HORIZONTAL
 Engineer :Ricky

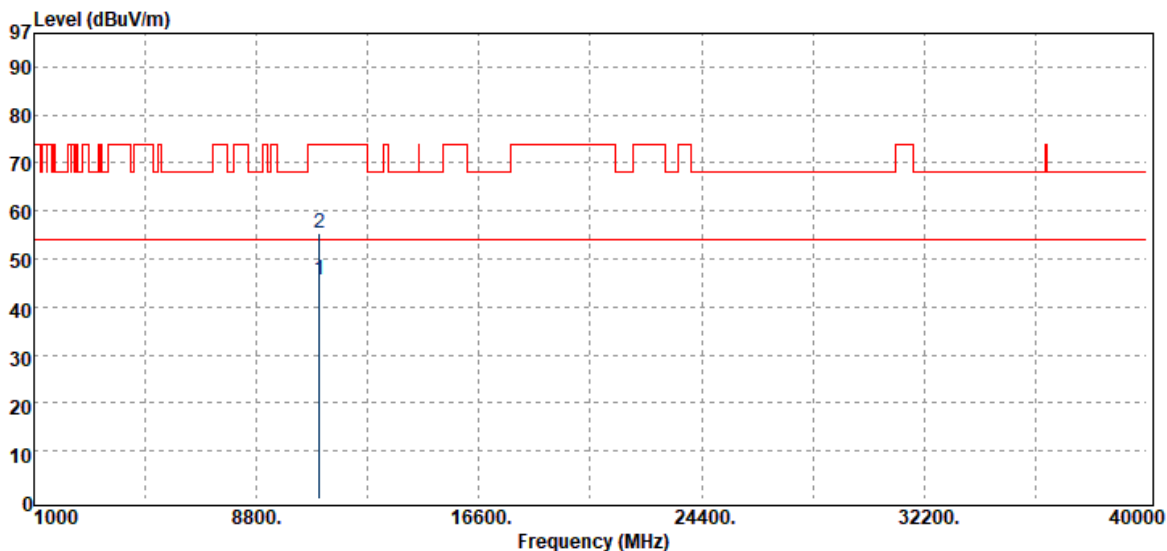

| Freq. MHz | Detector Mode PK/QP/AV | Spectrum Reading Level dB μ V | Factor dB | Actual FS dB μ V/m | Limit @3m dB μ V/m | Margin dB |
|--------------|------------------------------|---|--------------|------------------------------|------------------------------|--------------|
| 11000.00 | Average | 24.81 | 20.90 | 45.71 | 54.00 | -8.29 |
| 11000.00 | Peak | 34.55 | 20.90 | 55.45 | 74.00 | -18.55 |

Unless otherwise stated the results shown in this test report refer only to the sample(s) tested and such sample(s) are retained for 90 days only.

除非另有說明，此報告結果僅對測試之樣品負責，同時此樣品僅保留90天。本報告未經本公司書面許可，不可部份複製。

This document is issued by the Company subject to its General Conditions of Service printed overleaf, available on request or accessible at <http://www.sgs.com.tw/Terms-and-Conditions> and for electronic format documents, subject to Terms and Conditions for Electronic Documents at <http://www.sgs.com.tw/Terms-and-Conditions>. Attention is drawn to the limitation of liability, indemnification and jurisdiction issues defined therein. Any holder of this document is advised that information contained hereon reflects the Company's findings at the time of its intervention only and within the limits of Client's instructions, if any. The Company's sole responsibility is to its Client and this document does not exonerate parties to a transaction from exercising all their rights and obligations under the transaction documents. This document cannot be reproduced except in full, without prior written approval of the Company. Any unauthorized alteration, forgery or falsification of the content or appearance of this document is unlawful and offenders may be prosecuted to the fullest extent of the law.

Report Number :ER-2021-20085
 Operation Mode :802.11ax20
 Test Frequency :5580 MHz
 Test Mode :Tx CH Mid
 EUT Pol :H Plane

Test Site :SAC III Chamber
 Test Date :2021-03-05
 Temp./Humi. :21.8/63
 Antenna Pol. :VERTICAL
 Engineer :Ricky

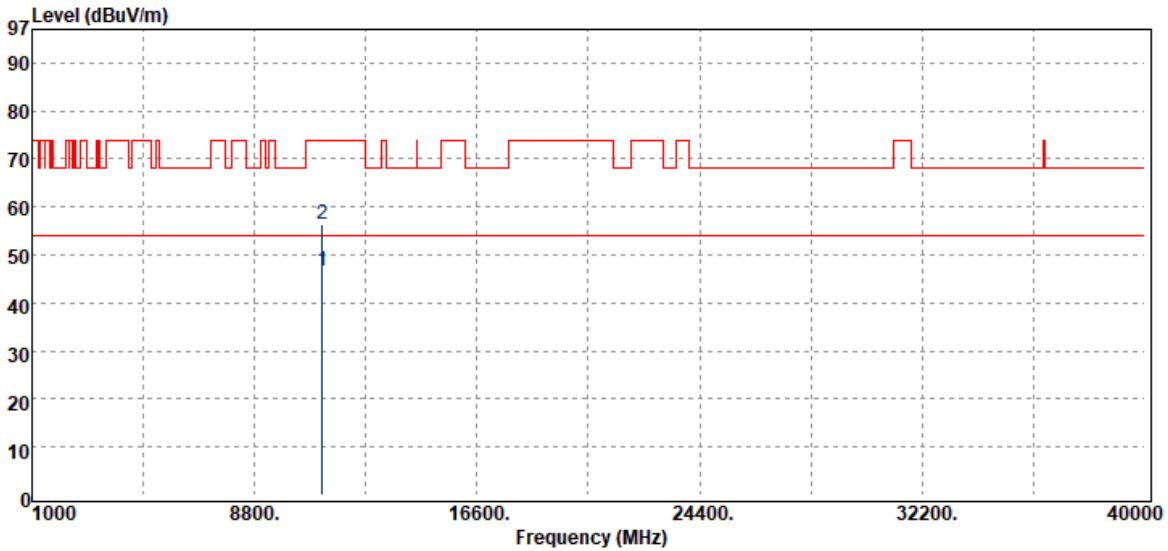

| Freq. MHz | Detector Mode PK/QP/AV | Spectrum Reading Level dBμV | Factor dB | Actual FS dBμV/m | Limit @3m dBμV/m | Margin dB |
|--------------|------------------------------|-----------------------------------|--------------|------------------------|------------------------|--------------|
| 11160.00 | Average | 25.22 | 21.60 | 46.82 | 54.00 | -7.18 |
| 11160.00 | Peak | 34.65 | 21.60 | 56.25 | 74.00 | -17.75 |

Unless otherwise stated the results shown in this test report refer only to the sample(s) tested and such sample(s) are retained for 90 days only.

除非另有說明，此報告結果僅對測試之樣品負責，同時此樣品僅保留90天。本報告未經本公司書面許可，不可部份複製。

This document is issued by the Company subject to its General Conditions of Service printed overleaf, available on request or accessible at <http://www.sgs.com.tw/Terms-and-Conditions> and for electronic format documents, subject to Terms and Conditions for Electronic Documents at <http://www.sgs.com.tw/Terms-and-Conditions>. Attention is drawn to the limitation of liability, indemnification and jurisdiction issues defined therein. Any holder of this document is advised that information contained hereon reflects the Company's findings at the time of its intervention only and within the limits of Client's instructions, if any. The Company's sole responsibility is to its Client and this document does not exonerate parties to a transaction from exercising all their rights and obligations under the transaction documents. This document cannot be reproduced except in full, without prior written approval of the Company. Any unauthorized alteration, forgery or falsification of the content or appearance of this document is unlawful and offenders may be prosecuted to the fullest extent of the law.

Report Number :ER-2021-20085
 Operation Mode :802.11ax20
 Test Frequency :5580 MHz
 Test Mode :Tx CH Mid
 EUT Pol :H Plane

Test Site :SAC III Chamber
 Test Date :2021-03-05
 Temp./Humi. :21.8/63
 Antenna Pol. :HORIZONTAL
 Engineer :Ricky

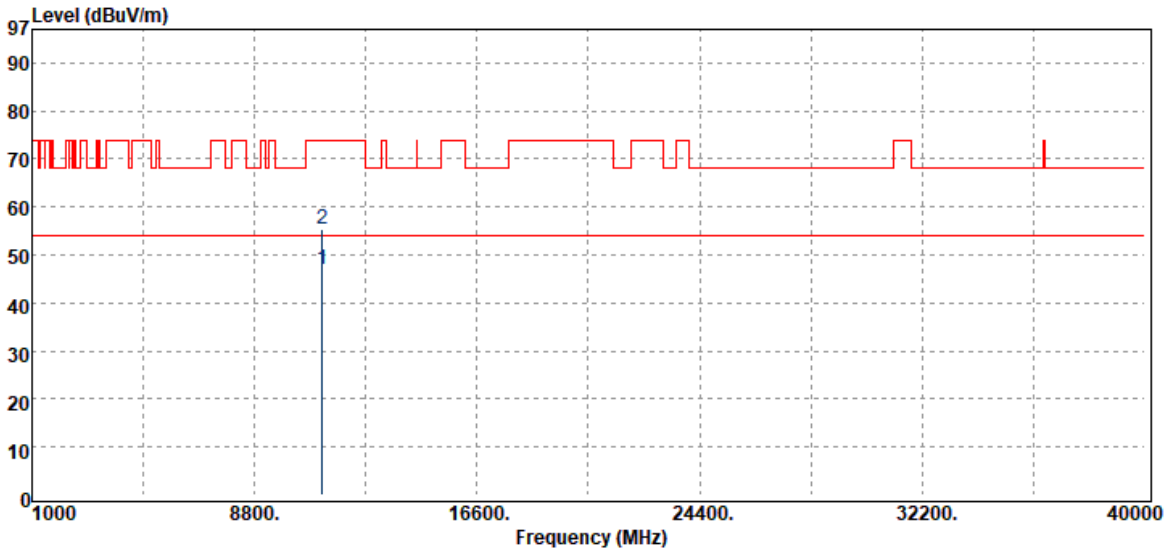

| Freq. MHz | Detector Mode PK/QP/AV | Spectrum Reading Level dB μ V | Factor dB | Actual FS dB μ V/m | Limit @3m dB μ V/m | Margin dB |
|--------------|------------------------------|---|--------------|------------------------------|------------------------------|--------------|
| 11160.00 | Average | 25.30 | 21.60 | 46.90 | 54.00 | -7.10 |
| 11160.00 | Peak | 33.67 | 21.60 | 55.27 | 74.00 | -18.73 |

Unless otherwise stated the results shown in this test report refer only to the sample(s) tested and such sample(s) are retained for 90 days only.

除非另有說明，此報告結果僅對測試之樣品負責，同時此樣品僅保留90天。本報告未經本公司書面許可，不可部份複製。

This document is issued by the Company subject to its General Conditions of Service printed overleaf, available on request or accessible at <http://www.sgs.com.tw/Terms-and-Conditions> and for electronic format documents, subject to Terms and Conditions for Electronic Documents at <http://www.sgs.com.tw/Terms-and-Conditions>. Attention is drawn to the limitation of liability, indemnification and jurisdiction issues defined therein. Any holder of this document is advised that information contained hereon reflects the Company's findings at the time of its intervention only and within the limits of Client's instructions, if any. The Company's sole responsibility is to its Client and this document does not exonerate parties to a transaction from exercising all their rights and obligations under the transaction documents. This document cannot be reproduced except in full, without prior written approval of the Company. Any unauthorized alteration, forgery or falsification of the content or appearance of this document is unlawful and offenders may be prosecuted to the fullest extent of the law.

Report Number :ER-2021-20085
 Operation Mode :802.11ax20
 Test Frequency :5700 MHz
 Test Mode :Tx CH High
 EUT Pol :H Plane

Test Site :SAC III Chamber
 Test Date :2021-03-05
 Temp./Humi. :21.8/63
 Antenna Pol. :VERTICAL
 Engineer :Ricky

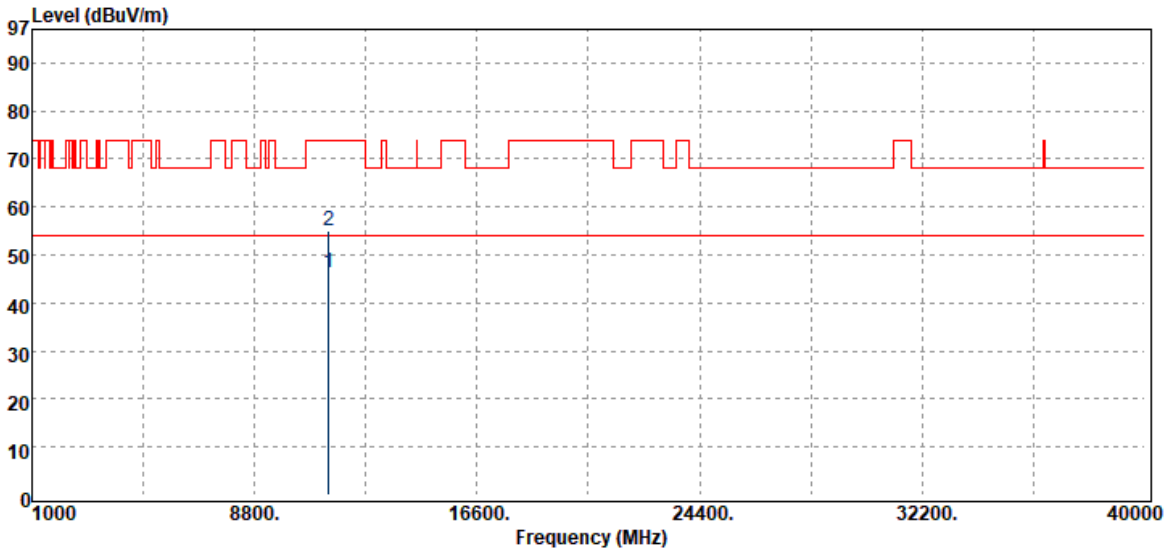

| Freq. MHz | Detector Mode PK/QP/AV | Spectrum Reading Level dB μ V | Factor dB | Actual FS dB μ V/m | Limit @3m dB μ V/m | Margin dB |
|--------------|------------------------------|---|--------------|------------------------------|------------------------------|--------------|
| 11400.00 | Average | 24.74 | 21.51 | 46.25 | 54.00 | -7.75 |
| 11400.00 | Peak | 33.70 | 21.51 | 55.21 | 74.00 | -18.79 |

Unless otherwise stated the results shown in this test report refer only to the sample(s) tested and such sample(s) are retained for 90 days only.

除非另有說明，此報告結果僅對測試之樣品負責，同時此樣品僅保留90天。本報告未經本公司書面許可，不可部份複製。

This document is issued by the Company subject to its General Conditions of Service printed overleaf, available on request or accessible at <http://www.sgs.com.tw/Terms-and-Conditions> and for electronic format documents, subject to Terms and Conditions for Electronic Documents at <http://www.sgs.com.tw/Terms-and-Conditions>. Attention is drawn to the limitation of liability, indemnification and jurisdiction issues defined therein. Any holder of this document is advised that information contained hereon reflects the Company's findings at the time of its intervention only and within the limits of Client's instructions, if any. The Company's sole responsibility is to its Client and this document does not exonerate parties to a transaction from exercising all their rights and obligations under the transaction documents. This document cannot be reproduced except in full, without prior written approval of the Company. Any unauthorized alteration, forgery or falsification of the content or appearance of this document is unlawful and offenders may be prosecuted to the fullest extent of the law.

Report Number :ER-2021-20085
 Operation Mode :802.11ax20
 Test Frequency :5700 MHz
 Test Mode :Tx CH High
 EUT Pol :H Plane

Test Site :SAC III Chamber
 Test Date :2021-03-05
 Temp./Humi. :21.8/63
 Antenna Pol. :HORIZONTAL
 Engineer :Ricky

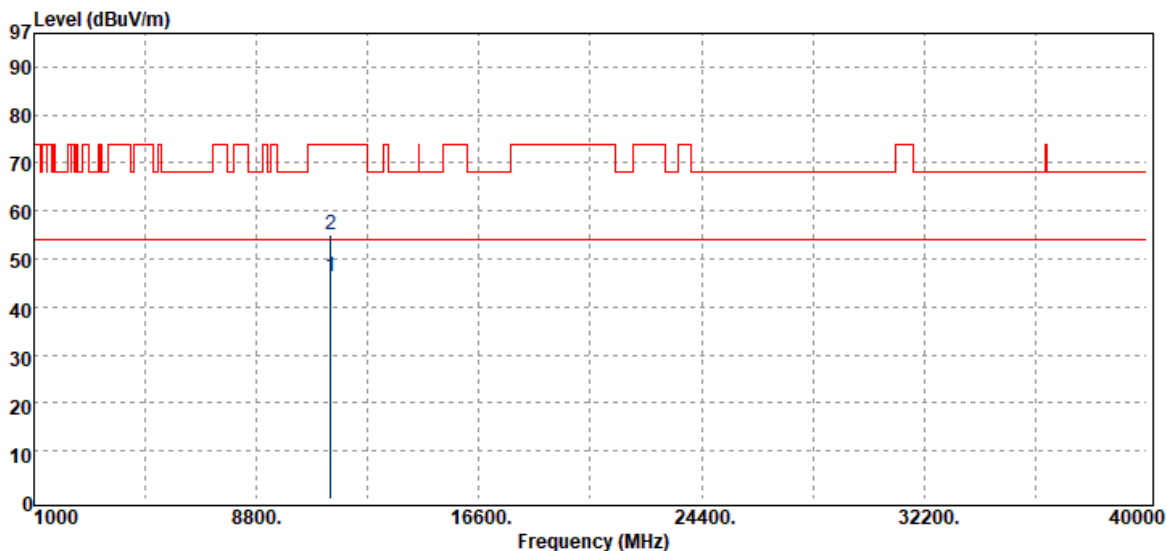

| Freq. MHz | Detector Mode PK/QP/AV | Spectrum Reading Level dB μ V | Factor dB | Actual FS dB μ V/m | Limit @3m dB μ V/m | Margin dB |
|--------------|------------------------------|---|--------------|------------------------------|------------------------------|--------------|
| 11400.00 | Average | 24.73 | 21.51 | 46.24 | 54.00 | -7.76 |
| 11400.00 | Peak | 33.63 | 21.51 | 55.14 | 74.00 | -18.86 |

Unless otherwise stated the results shown in this test report refer only to the sample(s) tested and such sample(s) are retained for 90 days only.

除非另有說明，此報告結果僅對測試之樣品負責，同時此樣品僅保留90天。本報告未經本公司書面許可，不可部份複製。

This document is issued by the Company subject to its General Conditions of Service printed overleaf, available on request or accessible at <http://www.sgs.com.tw/Terms-and-Conditions> and for electronic format documents, subject to Terms and Conditions for Electronic Documents at <http://www.sgs.com.tw/Terms-and-Conditions>. Attention is drawn to the limitation of liability, indemnification and jurisdiction issues defined therein. Any holder of this document is advised that information contained hereon reflects the Company's findings at the time of its intervention only and within the limits of Client's instructions, if any. The Company's sole responsibility is to its Client and this document does not exonerate parties to a transaction from exercising all their rights and obligations under the transaction documents. This document cannot be reproduced except in full, without prior written approval of the Company. Any unauthorized alteration, forgery or falsification of the content or appearance of this document is unlawful and offenders may be prosecuted to the fullest extent of the law.

Report Number :ER-2021-20085
 Operation Mode :802.11ax20
 Test Frequency :5720 MHz
 Test Mode :Tx CH High
 EUT Pol :H Plane

Test Site :SAC III Chamber
 Test Date :2021-03-05
 Temp./Humi. :21.8/63
 Antenna Pol. :VERTICAL
 Engineer :Ricky

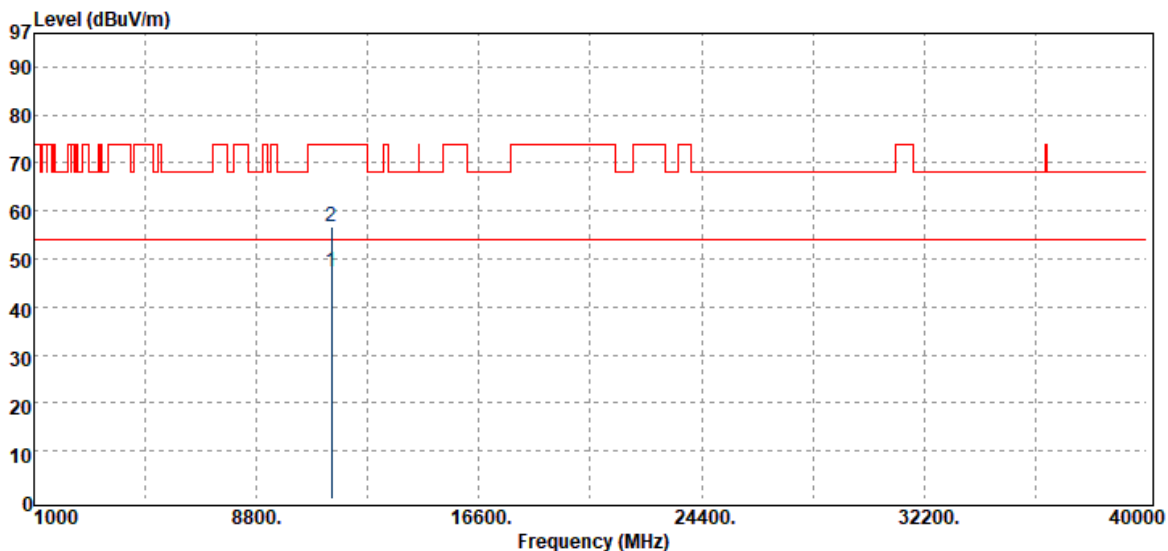

| Freq. MHz | Detector Mode PK/QP/AV | Spectrum Reading Level dB μ V | Factor dB | Actual FS dB μ V/m | Limit @3m dB μ V/m | Margin dB |
|--------------|------------------------------|---|--------------|------------------------------|------------------------------|--------------|
| 11440.00 | Average | 24.50 | 22.75 | 47.25 | 54.00 | -6.75 |
| 11440.00 | Peak | 33.93 | 22.75 | 56.68 | 74.00 | -17.32 |

Unless otherwise stated the results shown in this test report refer only to the sample(s) tested and such sample(s) are retained for 90 days only.

除非另有說明，此報告結果僅對測試之樣品負責，同時此樣品僅保留90天。本報告未經本公司書面許可，不可部份複製。

This document is issued by the Company subject to its General Conditions of Service printed overleaf, available on request or accessible at <http://www.sgs.com.tw/Terms-and-Conditions> and for electronic format documents, subject to Terms and Conditions for Electronic Documents at <http://www.sgs.com.tw/Terms-and-Conditions>. Attention is drawn to the limitation of liability, indemnification and jurisdiction issues defined therein. Any holder of this document is advised that information contained hereon reflects the Company's findings at the time of its intervention only and within the limits of Client's instructions, if any. The Company's sole responsibility is to its Client and this document does not exonerate parties to a transaction from exercising all their rights and obligations under the transaction documents. This document cannot be reproduced except in full, without prior written approval of the Company. Any unauthorized alteration, forgery or falsification of the content or appearance of this document is unlawful and offenders may be prosecuted to the fullest extent of the law.

Report Number :ER-2021-20085
 Operation Mode :802.11ax20
 Test Frequency :5720 MHz
 Test Mode :Tx CH High
 EUT Pol :H Plane

Test Site :SAC III Chamber
 Test Date :2021-03-05
 Temp./Humi. :21.8/63
 Antenna Pol. :HORIZONTAL
 Engineer :Ricky

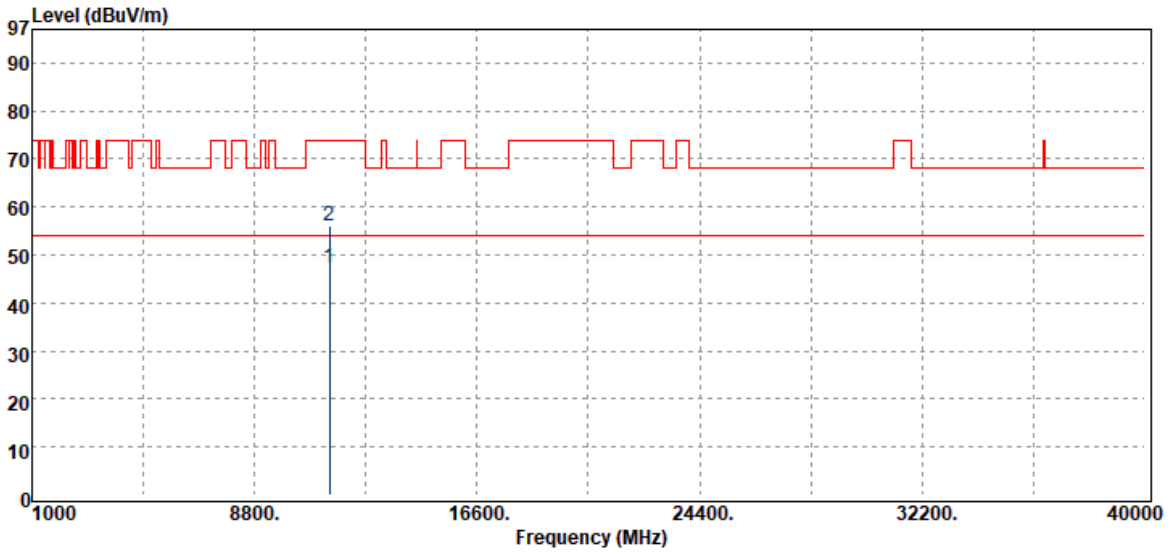

| Freq. MHz | Detector Mode PK/QP/AV | Spectrum Reading Level dB μ V | Factor dB | Actual FS dB μ V/m | Limit @3m dB μ V/m | Margin dB |
|--------------|------------------------------|---|--------------|------------------------------|------------------------------|--------------|
| 11440.00 | Average | 24.49 | 22.75 | 47.24 | 54.00 | -6.76 |
| 11440.00 | Peak | 33.44 | 22.75 | 56.19 | 74.00 | -17.81 |

Unless otherwise stated the results shown in this test report refer only to the sample(s) tested and such sample(s) are retained for 90 days only.

除非另有說明，此報告結果僅對測試之樣品負責，同時此樣品僅保留90天。本報告未經本公司書面許可，不可部份複製。

This document is issued by the Company subject to its General Conditions of Service printed overleaf, available on request or accessible at <http://www.sgs.com.tw/Terms-and-Conditions> and for electronic format documents, subject to Terms and Conditions for Electronic Documents at <http://www.sgs.com.tw/Terms-and-Conditions>. Attention is drawn to the limitation of liability, indemnification and jurisdiction issues defined therein. Any holder of this document is advised that information contained hereon reflects the Company's findings at the time of its intervention only and within the limits of Client's instructions, if any. The Company's sole responsibility is to its Client and this document does not exonerate parties to a transaction from exercising all their rights and obligations under the transaction documents. This document cannot be reproduced except in full, without prior written approval of the Company. Any unauthorized alteration, forgery or falsification of the content or appearance of this document is unlawful and offenders may be prosecuted to the fullest extent of the law.

Report Number :ER-2021-20085
 Operation Mode :802.11ax20
 Test Frequency :5745 MHz
 Test Mode :Tx CH Low
 EUT Pol :H Plane

Test Site :SAC III Chamber
 Test Date :2021-03-05
 Temp./Humi. :21.8/63
 Antenna Pol. :VERTICAL
 Engineer :Ricky

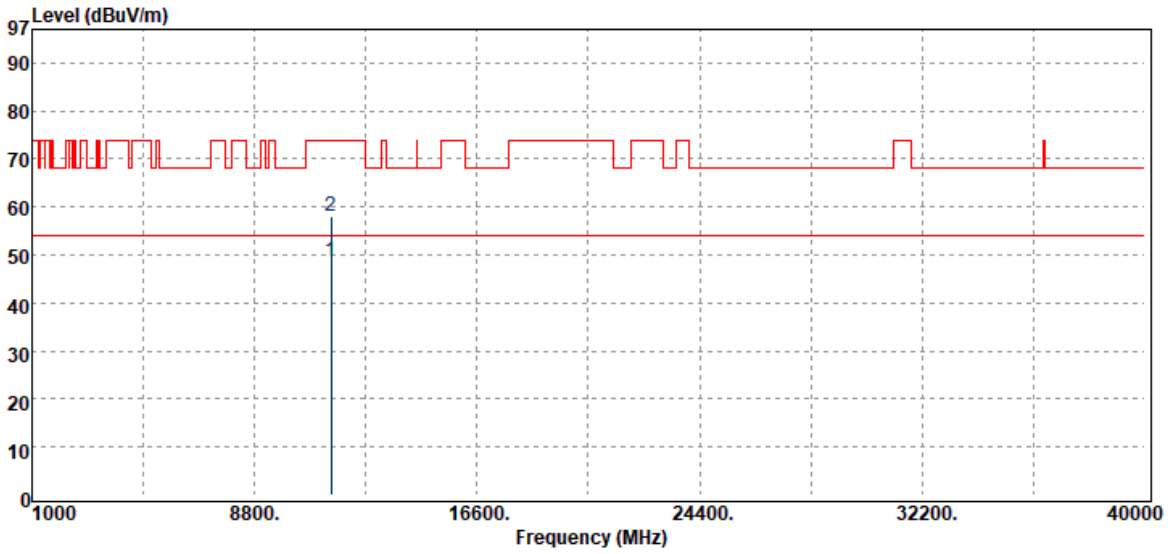

| Freq. MHz | Detector Mode PK/QP/AV | Spectrum Reading Level dB μ V | Factor dB | Actual FS dB μ V/m | Limit @3m dB μ V/m | Margin dB |
|--------------|------------------------------|---|--------------|------------------------------|------------------------------|--------------|
| 11490.00 | Average | 24.29 | 24.41 | 48.70 | 54.00 | -5.30 |
| 11490.00 | Peak | 33.71 | 24.41 | 58.12 | 74.00 | -15.88 |

Unless otherwise stated the results shown in this test report refer only to the sample(s) tested and such sample(s) are retained for 90 days only.

除非另有說明，此報告結果僅對測試之樣品負責，同時此樣品僅保留90天。本報告未經本公司書面許可，不可部份複製。

This document is issued by the Company subject to its General Conditions of Service printed overleaf, available on request or accessible at <http://www.sgs.com.tw/Terms-and-Conditions> and for electronic format documents, subject to Terms and Conditions for Electronic Documents at <http://www.sgs.com.tw/Terms-and-Conditions>. Attention is drawn to the limitation of liability, indemnification and jurisdiction issues defined therein. Any holder of this document is advised that information contained hereon reflects the Company's findings at the time of its intervention only and within the limits of Client's instructions, if any. The Company's sole responsibility is to its Client and this document does not exonerate parties to a transaction from exercising all their rights and obligations under the transaction documents. This document cannot be reproduced except in full, without prior written approval of the Company. Any unauthorized alteration, forgery or falsification of the content or appearance of this document is unlawful and offenders may be prosecuted to the fullest extent of the law.

Report Number :ER-2021-20085
 Operation Mode :802.11ax20
 Test Frequency :5745 MHz
 Test Mode :Tx CH Low
 EUT Pol :H Plane

Test Site :SAC III Chamber
 Test Date :2021-03-05
 Temp./Humi. :21.8/63
 Antenna Pol. :HORIZONTAL
 Engineer :Ricky

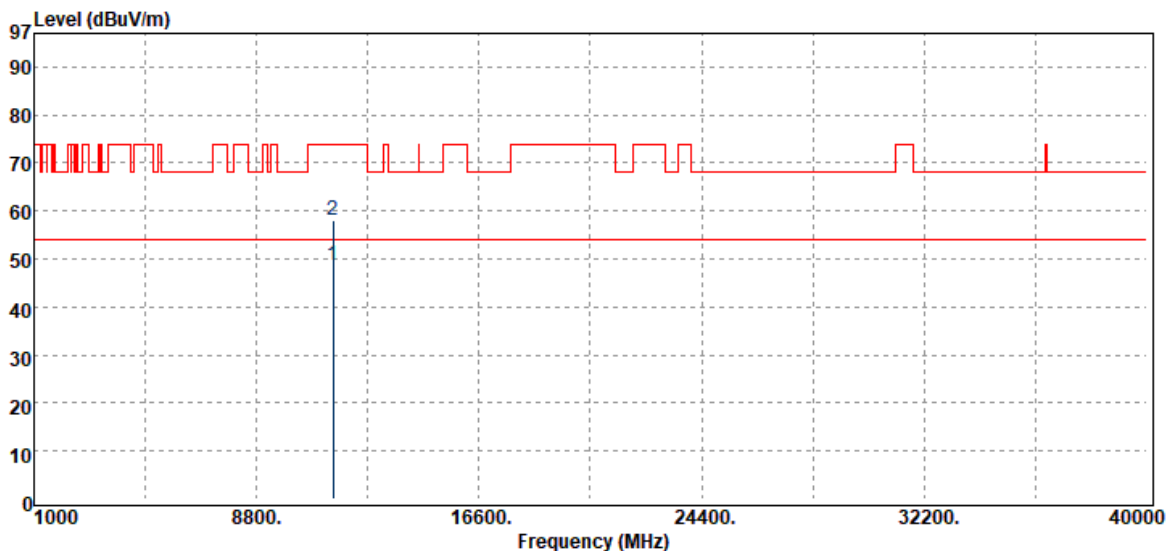

| Freq. MHz | Detector Mode PK/QP/AV | Spectrum Reading Level dB μ V | Factor dB | Actual FS dB μ V/m | Limit @3m dB μ V/m | Margin dB |
|--------------|------------------------------|---|--------------|------------------------------|------------------------------|--------------|
| 11490.00 | Average | 24.25 | 24.41 | 48.66 | 54.00 | -5.34 |
| 11490.00 | Peak | 33.71 | 24.41 | 58.12 | 74.00 | -15.88 |

Unless otherwise stated the results shown in this test report refer only to the sample(s) tested and such sample(s) are retained for 90 days only.

除非另有說明，此報告結果僅對測試之樣品負責，同時此樣品僅保留90天。本報告未經本公司書面許可，不可部份複製。

This document is issued by the Company subject to its General Conditions of Service printed overleaf, available on request or accessible at <http://www.sgs.com.tw/Terms-and-Conditions> and for electronic format documents, subject to Terms and Conditions for Electronic Documents at <http://www.sgs.com.tw/Terms-and-Conditions>. Attention is drawn to the limitation of liability, indemnification and jurisdiction issues defined therein. Any holder of this document is advised that information contained hereon reflects the Company's findings at the time of its intervention only and within the limits of Client's instructions, if any. The Company's sole responsibility is to its Client and this document does not exonerate parties to a transaction from exercising all their rights and obligations under the transaction documents. This document cannot be reproduced except in full, without prior written approval of the Company. Any unauthorized alteration, forgery or falsification of the content or appearance of this document is unlawful and offenders may be prosecuted to the fullest extent of the law.

Report Number :ER-2021-20085
 Operation Mode :802.11ax20
 Test Frequency :5785 MHz
 Test Mode :Tx CH Mid
 EUT Pol :H Plane

Test Site :SAC III Chamber
 Test Date :2021-03-05
 Temp./Humi. :21.8/63
 Antenna Pol. :VERTICAL
 Engineer :Ricky

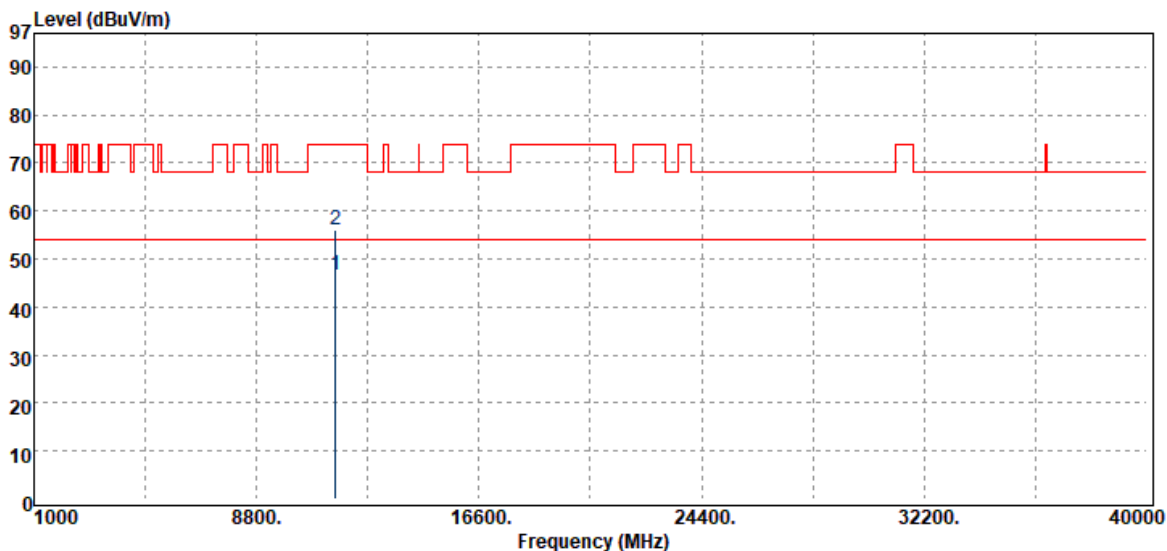

| Freq. MHz | Detector Mode PK/QP/AV | Spectrum Reading Level dB μ V | Factor dB | Actual FS dB μ V/m | Limit @3m dB μ V/m | Margin dB |
|--------------|------------------------------|---|--------------|------------------------------|------------------------------|--------------|
| 11570.00 | Average | 24.81 | 21.84 | 46.65 | 54.00 | -7.35 |
| 11570.00 | Peak | 34.12 | 21.84 | 55.96 | 74.00 | -18.04 |

Unless otherwise stated the results shown in this test report refer only to the sample(s) tested and such sample(s) are retained for 90 days only.

除非另有說明，此報告結果僅對測試之樣品負責，同時此樣品僅保留90天。本報告未經本公司書面許可，不可部份複製。

This document is issued by the Company subject to its General Conditions of Service printed overleaf, available on request or accessible at <http://www.sgs.com.tw/Terms-and-Conditions> and for electronic format documents, subject to Terms and Conditions for Electronic Documents at <http://www.sgs.com.tw/Terms-and-Conditions>. Attention is drawn to the limitation of liability, indemnification and jurisdiction issues defined therein. Any holder of this document is advised that information contained hereon reflects the Company's findings at the time of its intervention only and within the limits of Client's instructions, if any. The Company's sole responsibility is to its Client and this document does not exonerate parties to a transaction from exercising all their rights and obligations under the transaction documents. This document cannot be reproduced except in full, without prior written approval of the Company. Any unauthorized alteration, forgery or falsification of the content or appearance of this document is unlawful and offenders may be prosecuted to the fullest extent of the law.

Report Number :ER-2021-20085
 Operation Mode :802.11ax20
 Test Frequency :5785 MHz
 Test Mode :Tx CH Mid
 EUT Pol :H Plane

Test Site :SAC III Chamber
 Test Date :2021-03-05
 Temp./Humi. :21.8/63
 Antenna Pol. :HORIZONTAL
 Engineer :Ricky

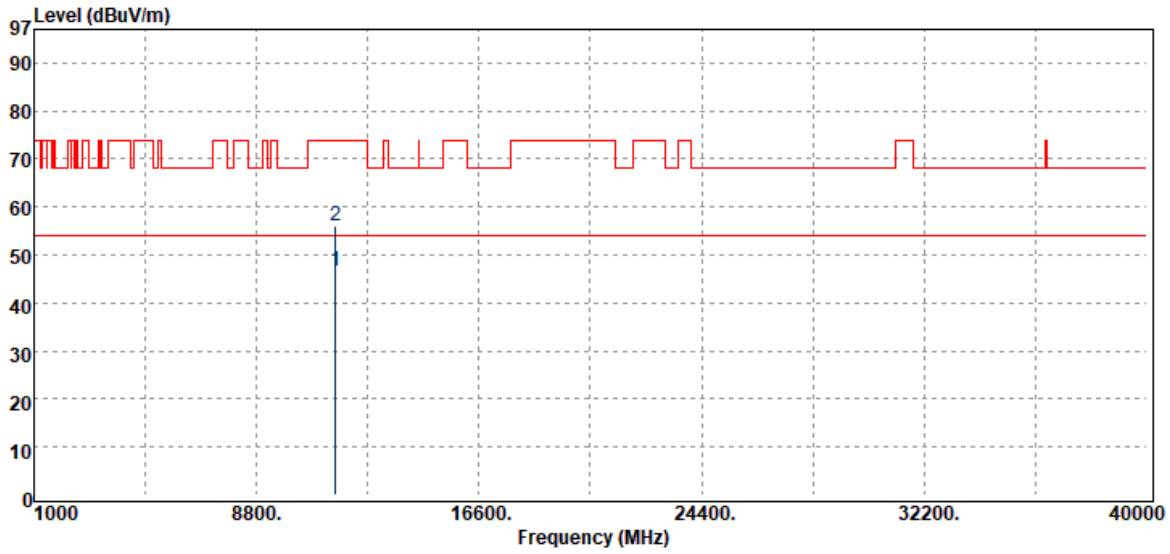

| Freq. MHz | Detector Mode PK/QP/AV | Spectrum Reading Level dB μ V | Factor dB | Actual FS dB μ V/m | Limit @3m dB μ V/m | Margin dB |
|--------------|------------------------------|---|--------------|------------------------------|------------------------------|--------------|
| 11570.00 | Average | 24.79 | 21.84 | 46.63 | 54.00 | -7.37 |
| 11570.00 | Peak | 34.19 | 21.84 | 56.03 | 74.00 | -17.97 |

Unless otherwise stated the results shown in this test report refer only to the sample(s) tested and such sample(s) are retained for 90 days only.

除非另有說明，此報告結果僅對測試之樣品負責，同時此樣品僅保留90天。本報告未經本公司書面許可，不可部份複製。

This document is issued by the Company subject to its General Conditions of Service printed overleaf, available on request or accessible at <http://www.sgs.com.tw/Terms-and-Conditions> and for electronic format documents, subject to Terms and Conditions for Electronic Documents at <http://www.sgs.com.tw/Terms-and-Conditions>. Attention is drawn to the limitation of liability, indemnification and jurisdiction issues defined therein. Any holder of this document is advised that information contained hereon reflects the Company's findings at the time of its intervention only and within the limits of Client's instructions, if any. The Company's sole responsibility is to its Client and this document does not exonerate parties to a transaction from exercising all their rights and obligations under the transaction documents. This document cannot be reproduced except in full, without prior written approval of the Company. Any unauthorized alteration, forgery or falsification of the content or appearance of this document is unlawful and offenders may be prosecuted to the fullest extent of the law.

Report Number :ER-2021-20085
 Operation Mode :802.11ax20
 Test Frequency :5825 MHz
 Test Mode :Tx CH High
 EUT Pol :H Plane

Test Site :SAC III Chamber
 Test Date :2021-03-05
 Temp./Humi. :21.8/63
 Antenna Pol. :VERTICAL
 Engineer :Ricky

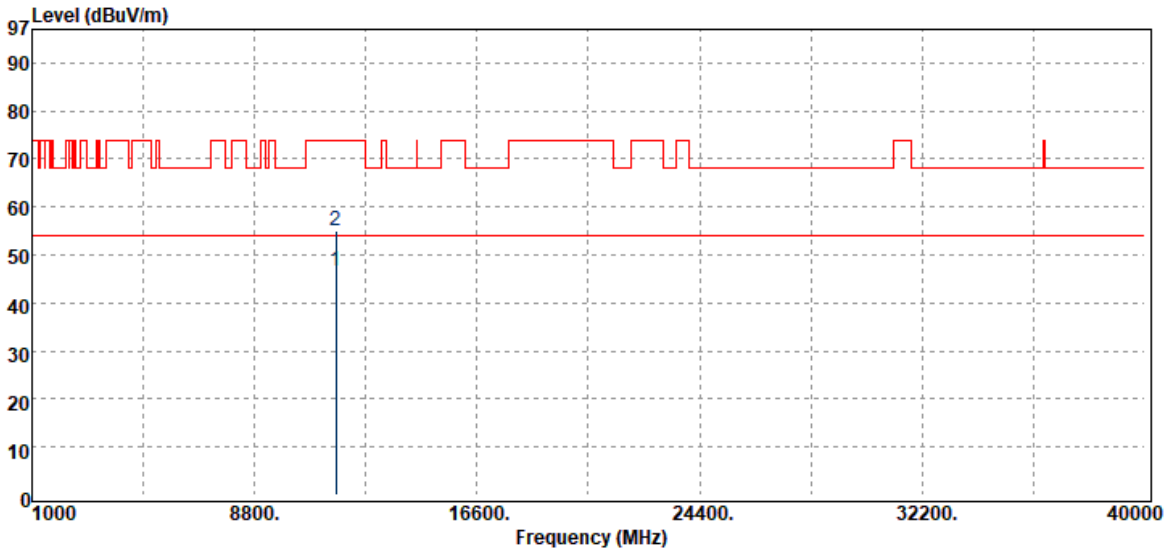

| Freq. MHz | Detector Mode PK/QP/AV | Spectrum Reading Level dB μ V | Factor dB | Actual FS dB μ V/m | Limit @3m dB μ V/m | Margin dB |
|--------------|------------------------------|---|--------------|------------------------------|------------------------------|--------------|
| 11650.00 | Average | 24.37 | 22.13 | 46.50 | 54.00 | -7.50 |
| 11650.00 | Peak | 32.83 | 22.13 | 54.96 | 74.00 | -19.04 |

Unless otherwise stated the results shown in this test report refer only to the sample(s) tested and such sample(s) are retained for 90 days only.

除非另有說明，此報告結果僅對測試之樣品負責，同時此樣品僅保留90天。本報告未經本公司書面許可，不可部份複製。

This document is issued by the Company subject to its General Conditions of Service printed overleaf, available on request or accessible at <http://www.sgs.com.tw/Terms-and-Conditions> and for electronic format documents, subject to Terms and Conditions for Electronic Documents at <http://www.sgs.com.tw/Terms-and-Conditions>. Attention is drawn to the limitation of liability, indemnification and jurisdiction issues defined therein. Any holder of this document is advised that information contained hereon reflects the Company's findings at the time of its intervention only and within the limits of Client's instructions, if any. The Company's sole responsibility is to its Client and this document does not exonerate parties to a transaction from exercising all their rights and obligations under the transaction documents. This document cannot be reproduced except in full, without prior written approval of the Company. Any unauthorized alteration, forgery or falsification of the content or appearance of this document is unlawful and offenders may be prosecuted to the fullest extent of the law.

Report Number :ER-2021-20085
 Operation Mode :802.11ax20
 Test Frequency :5825 MHz
 Test Mode :Tx CH High
 EUT Pol :H Plane

Test Site :SAC III Chamber
 Test Date :2021-03-05
 Temp./Humi. :21.8/63
 Antenna Pol. :HORIZONTAL
 Engineer :Ricky

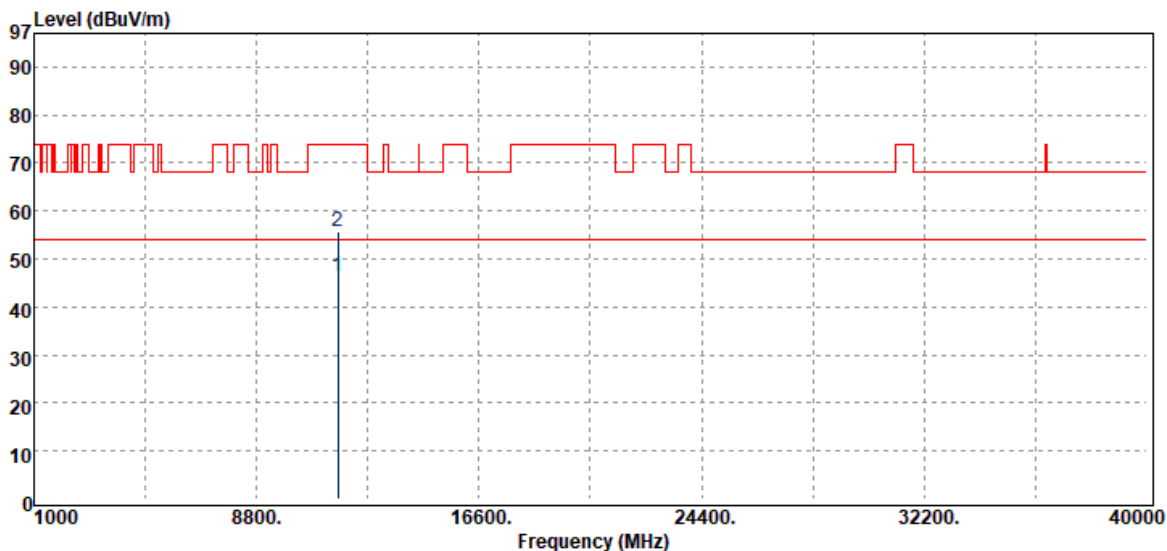

| Freq. MHz | Detector Mode PK/QP/AV | Spectrum Reading Level dB μ V | Factor dB | Actual FS dB μ V/m | Limit @3m dB μ V/m | Margin dB |
|--------------|------------------------------|---|--------------|------------------------------|------------------------------|--------------|
| 11650.00 | Average | 24.33 | 22.13 | 46.46 | 54.00 | -7.54 |
| 11650.00 | Peak | 33.56 | 22.13 | 55.69 | 74.00 | -18.31 |

Unless otherwise stated the results shown in this test report refer only to the sample(s) tested and such sample(s) are retained for 90 days only.

除非另有說明，此報告結果僅對測試之樣品負責，同時此樣品僅保留90天。本報告未經本公司書面許可，不可部份複製。

This document is issued by the Company subject to its General Conditions of Service printed overleaf, available on request or accessible at <http://www.sgs.com.tw/Terms-and-Conditions> and for electronic format documents, subject to Terms and Conditions for Electronic Documents at <http://www.sgs.com.tw/Terms-and-Conditions>. Attention is drawn to the limitation of liability, indemnification and jurisdiction issues defined therein. Any holder of this document is advised that information contained hereon reflects the Company's findings at the time of its intervention only and within the limits of Client's instructions, if any. The Company's sole responsibility is to its Client and this document does not exonerate parties to a transaction from exercising all their rights and obligations under the transaction documents. This document cannot be reproduced except in full, without prior written approval of the Company. Any unauthorized alteration, forgery or falsification of the content or appearance of this document is unlawful and offenders may be prosecuted to the fullest extent of the law.

Report Number :ER-2021-20085
 Operation Mode :802.11ax40
 Test Frequency :5190 MHz
 Test Mode :Tx CH Low
 EUT Pol :H Plane

Test Site :SAC III Chamber
 Test Date :2021-03-05
 Temp./Humi. :21.8/63
 Antenna Pol. :VERTICAL
 Engineer :Ricky

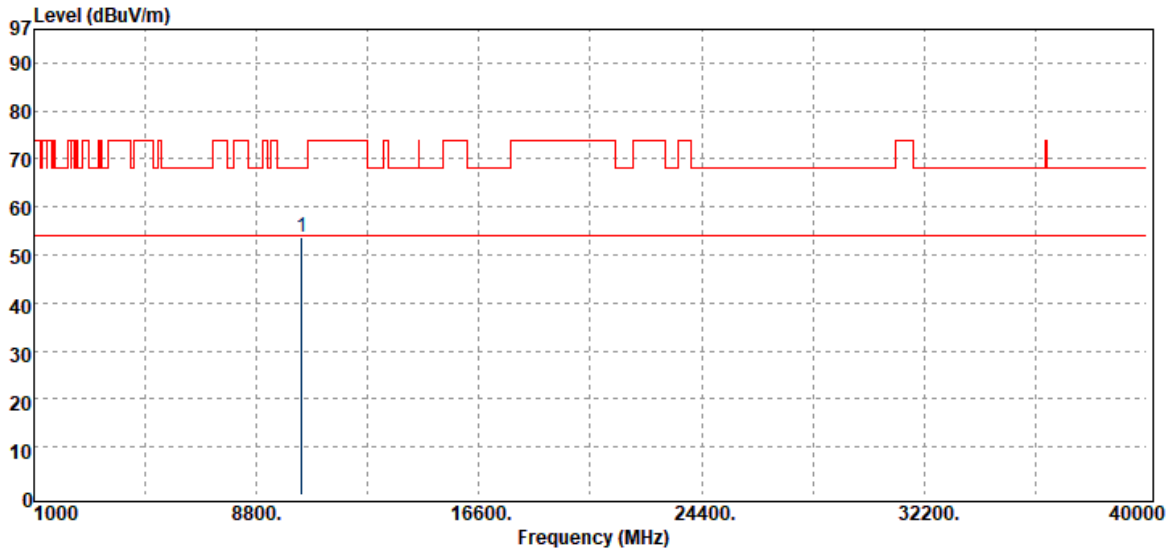

| Freq. MHz | Detector Mode PK/QP/AV | Spectrum Reading Level dB μ V | Factor dB | Actual FS dB μ V/m | Limit @3m dB μ V/m | Margin dB |
|--------------|------------------------------|---|--------------|------------------------------|------------------------------|--------------|
| 10380.00 | Peak | 34.07 | 19.70 | 53.77 | 68.20 | -14.43 |

Unless otherwise stated the results shown in this test report refer only to the sample(s) tested and such sample(s) are retained for 90 days only.

除非另有說明，此報告結果僅對測試之樣品負責，同時此樣品僅保留90天。本報告未經本公司書面許可，不可部份複製。
 This document is issued by the Company subject to its General Conditions of Service printed overleaf, available on request or accessible at <http://www.sgs.com.tw/Terms-and-Conditions> and for electronic format documents, subject to Terms and Conditions for Electronic Documents at <http://www.sgs.com.tw/Terms-and-Conditions>. Attention is drawn to the limitation of liability, indemnification and jurisdiction issues defined therein. Any holder of this document is advised that information contained hereon reflects the Company's findings at the time of its intervention only and within the limits of Client's instructions, if any. The Company's sole responsibility is to its Client and this document does not exonerate parties to a transaction from exercising all their rights and obligations under the transaction documents. This document cannot be reproduced except in full, without prior written approval of the Company. Any unauthorized alteration, forgery or falsification of the content or appearance of this document is unlawful and offenders may be prosecuted to the fullest extent of the law.

Report Number :ER-2021-20085
 Operation Mode :802.11ax40
 Test Frequency :5190 MHz
 Test Mode :Tx CH Low
 EUT Pol :H Plane

Test Site :SAC III Chamber
 Test Date :2021-03-05
 Temp./Humi. :21.8/63
 Antenna Pol. :HORIZONTAL
 Engineer :Ricky

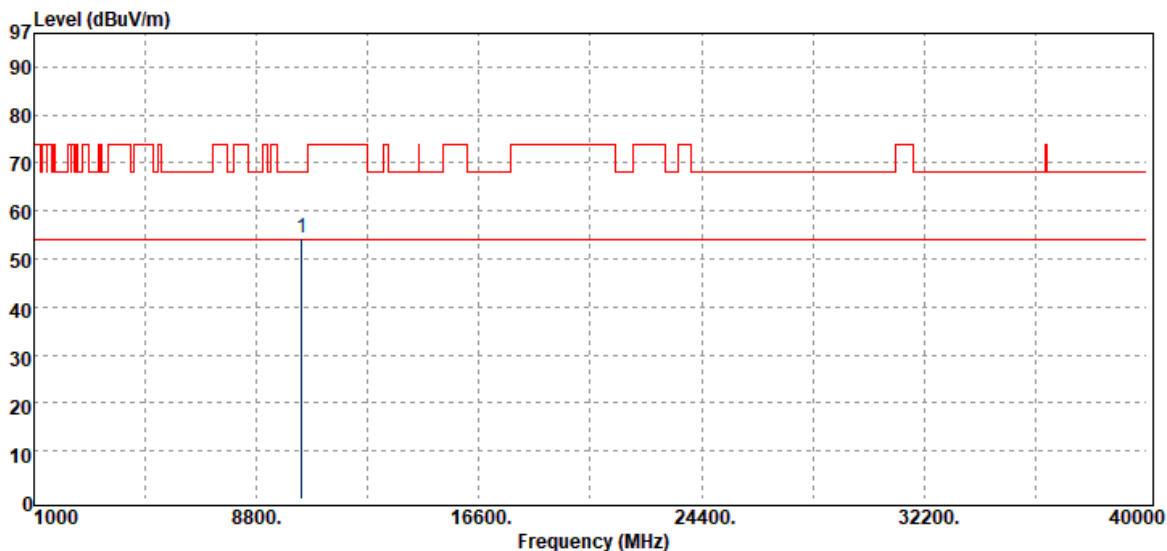

| Freq. MHz | Detector Mode PK/QP/AV | Spectrum Reading Level dB μ V | Factor dB | Actual FS dB μ V/m | Limit @3m dB μ V/m | Margin dB |
|--------------|------------------------------|---|--------------|------------------------------|------------------------------|--------------|
| 10380.00 | Peak | 34.71 | 19.70 | 54.41 | 68.20 | -13.79 |

Unless otherwise stated the results shown in this test report refer only to the sample(s) tested and such sample(s) are retained for 90 days only.

除非另有說明，此報告結果僅對測試之樣品負責，同時此樣品僅保留90天。本報告未經本公司書面許可，不可部份複製。

This document is issued by the Company subject to its General Conditions of Service printed overleaf, available on request or accessible at <http://www.sgs.com.tw/Terms-and-Conditions> and for electronic format documents, subject to Terms and Conditions for Electronic Documents at <http://www.sgs.com.tw/Terms-and-Conditions>. Attention is drawn to the limitation of liability, indemnification and jurisdiction issues defined therein. Any holder of this document is advised that information contained hereon reflects the Company's findings at the time of its intervention only and within the limits of Client's instructions, if any. The Company's sole responsibility is to its Client and this document does not exonerate parties to a transaction from exercising all their rights and obligations under the transaction documents. This document cannot be reproduced except in full, without prior written approval of the Company. Any unauthorized alteration, forgery or falsification of the content or appearance of this document is unlawful and offenders may be prosecuted to the fullest extent of the law.

Report Number :ER-2021-20085
 Operation Mode :802.11ax40
 Test Frequency :5230 MHz
 Test Mode :Tx CH High
 EUT Pol :H Plane

Test Site :SAC III Chamber
 Test Date :2021-03-05
 Temp./Humi. :21.8/63
 Antenna Pol. :VERTICAL
 Engineer :Ricky

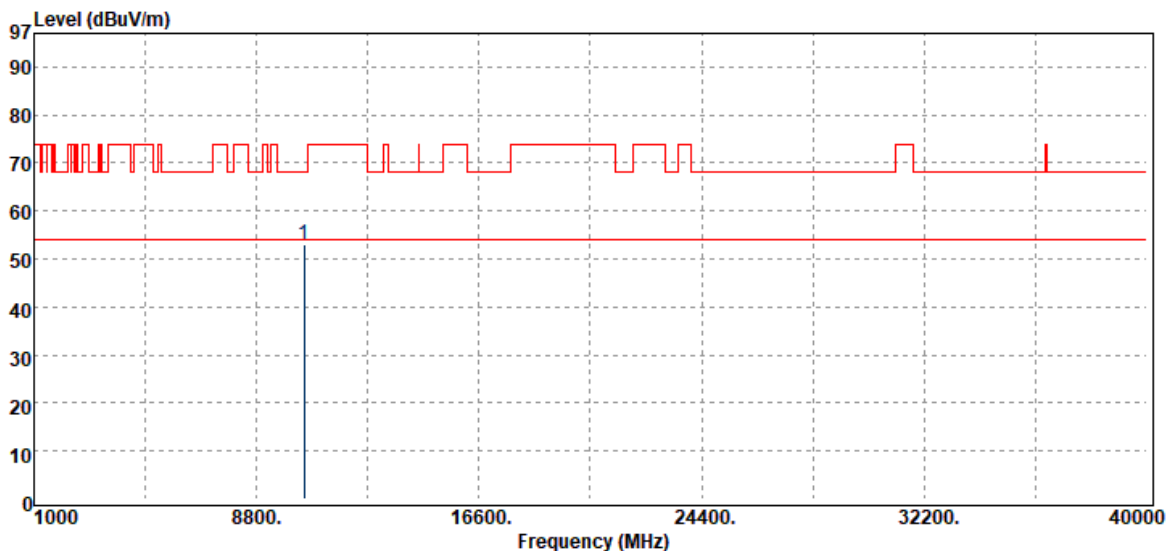

| Freq. MHz | Detector Mode PK/QP/AV | Spectrum Reading Level dB μ V | Factor dB | Actual FS dB μ V/m | Limit @3m dB μ V/m | Margin dB |
|--------------|------------------------------|---|--------------|------------------------------|------------------------------|--------------|
| 10460.00 | Peak | 33.90 | 19.22 | 53.12 | 68.20 | -15.08 |

Unless otherwise stated the results shown in this test report refer only to the sample(s) tested and such sample(s) are retained for 90 days only.

除非另有說明，此報告結果僅對測試之樣品負責，同時此樣品僅保留90天。本報告未經本公司書面許可，不可部份複製。

This document is issued by the Company subject to its General Conditions of Service printed overleaf, available on request or accessible at <http://www.sgs.com.tw/Terms-and-Conditions> and for electronic format documents, subject to Terms and Conditions for Electronic Documents at <http://www.sgs.com.tw/Terms-and-Conditions>. Attention is drawn to the limitation of liability, indemnification and jurisdiction issues defined therein. Any holder of this document is advised that information contained hereon reflects the Company's findings at the time of its intervention only and within the limits of Client's instructions, if any. The Company's sole responsibility is to its Client and this document does not exonerate parties to a transaction from exercising all their rights and obligations under the transaction documents. This document cannot be reproduced except in full, without prior written approval of the Company. Any unauthorized alteration, forgery or falsification of the content or appearance of this document is unlawful and offenders may be prosecuted to the fullest extent of the law.

Report Number :ER-2021-20085
 Operation Mode :802.11ax40
 Test Frequency :5230 MHz
 Test Mode :Tx CH High
 EUT Pol :H Plane

Test Site :SAC III Chamber
 Test Date :2021-03-05
 Temp./Humi. :21.8/63
 Antenna Pol. :HORIZONTAL
 Engineer :Ricky

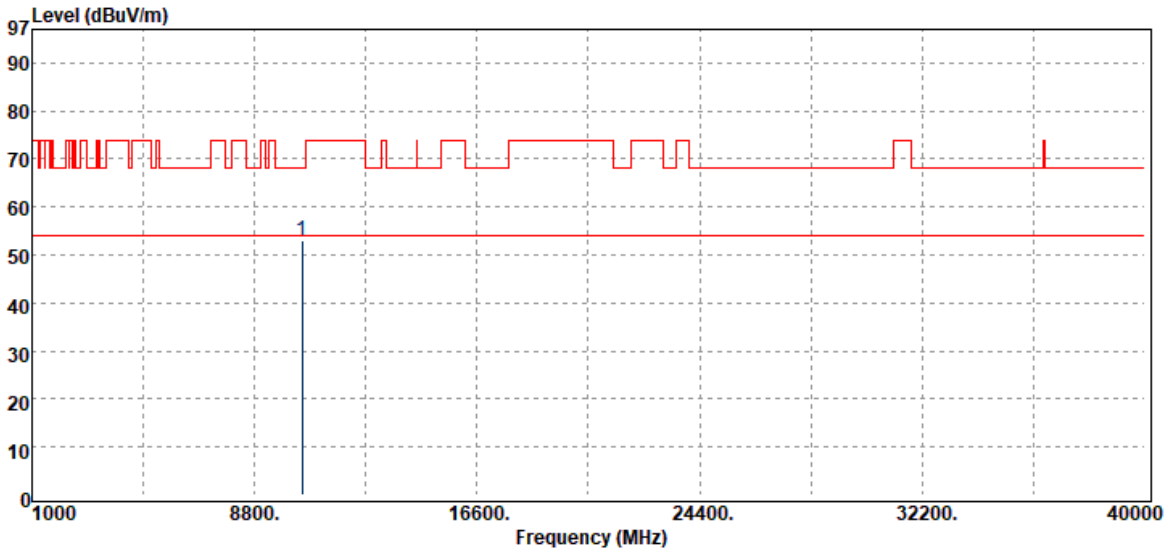

| Freq. MHz | Detector Mode PK/QP/AV | Spectrum Reading Level dB μ V | Factor dB | Actual FS dB μ V/m | Limit @3m dB μ V/m | Margin dB |
|--------------|------------------------------|---|--------------|------------------------------|------------------------------|--------------|
| 10460.00 | Peak | 33.68 | 19.22 | 52.90 | 68.20 | -15.30 |

Unless otherwise stated the results shown in this test report refer only to the sample(s) tested and such sample(s) are retained for 90 days only.

除非另有說明，此報告結果僅對測試之樣品負責，同時此樣品僅保留90天。本報告未經本公司書面許可，不可部份複製。

This document is issued by the Company subject to its General Conditions of Service printed overleaf, available on request or accessible at <http://www.sgs.com.tw/Terms-and-Conditions> and for electronic format documents, subject to Terms and Conditions for Electronic Documents at <http://www.sgs.com.tw/Terms-and-Conditions>. Attention is drawn to the limitation of liability, indemnification and jurisdiction issues defined therein. Any holder of this document is advised that information contained hereon reflects the Company's findings at the time of its intervention only and within the limits of Client's instructions, if any. The Company's sole responsibility is to its Client and this document does not exonerate parties to a transaction from exercising all their rights and obligations under the transaction documents. This document cannot be reproduced except in full, without prior written approval of the Company. Any unauthorized alteration, forgery or falsification of the content or appearance of this document is unlawful and offenders may be prosecuted to the fullest extent of the law.

Report Number :ER-2021-20085
 Operation Mode :802.11ax40
 Test Frequency :5270 MHz
 Test Mode :Tx CH Low
 EUT Pol :H Plane

Test Site :SAC III Chamber
 Test Date :2021-03-05
 Temp./Humi. :21.8/63
 Antenna Pol. :VERTICAL
 Engineer :Ricky

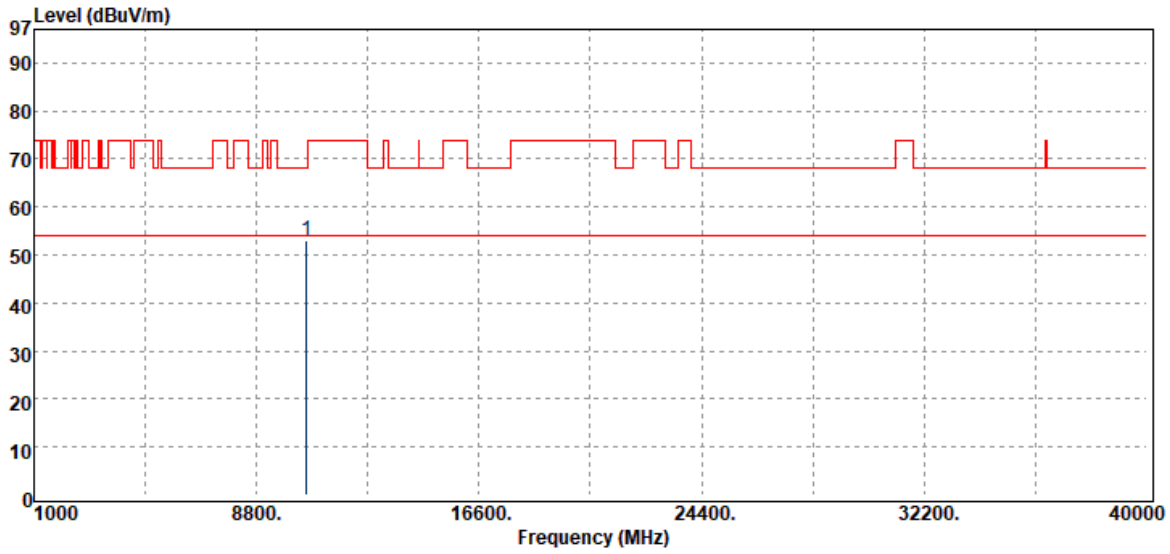

| Freq. MHz | Detector Mode PK/QP/AV | Spectrum Reading Level dB μ V | Factor dB | Actual FS dB μ V/m | Limit @3m dB μ V/m | Margin dB |
|--------------|------------------------------|---|--------------|------------------------------|------------------------------|--------------|
| 10540.00 | Peak | 33.38 | 19.78 | 53.16 | 68.20 | -15.04 |

Unless otherwise stated the results shown in this test report refer only to the sample(s) tested and such sample(s) are retained for 90 days only.

除非另有說明，此報告結果僅對測試之樣品負責，同時此樣品僅保留90天。本報告未經本公司書面許可，不可部份複製。

This document is issued by the Company subject to its General Conditions of Service printed overleaf, available on request or accessible at <http://www.sgs.com.tw/Terms-and-Conditions> and for electronic format documents, subject to Terms and Conditions for Electronic Documents at <http://www.sgs.com.tw/Terms-and-Conditions>. Attention is drawn to the limitation of liability, indemnification and jurisdiction issues defined therein. Any holder of this document is advised that information contained hereon reflects the Company's findings at the time of its intervention only and within the limits of Client's instructions, if any. The Company's sole responsibility is to its Client and this document does not exonerate parties to a transaction from exercising all their rights and obligations under the transaction documents. This document cannot be reproduced except in full, without prior written approval of the Company. Any unauthorized alteration, forgery or falsification of the content or appearance of this document is unlawful and offenders may be prosecuted to the fullest extent of the law.

| | | | |
|----------------|----------------|--------------|------------------|
| Report Number | :ER-2021-20085 | Test Site | :SAC III Chamber |
| Operation Mode | :802.11ax40 | Test Date | :2021-03-05 |
| Test Frequency | :5270 MHz | Temp./Humi. | :21.8/63 |
| Test Mode | :Tx CH Low | Antenna Pol. | :HORIZONTAL |
| EUT Pol | :H Plane | Engineer | :Ricky |

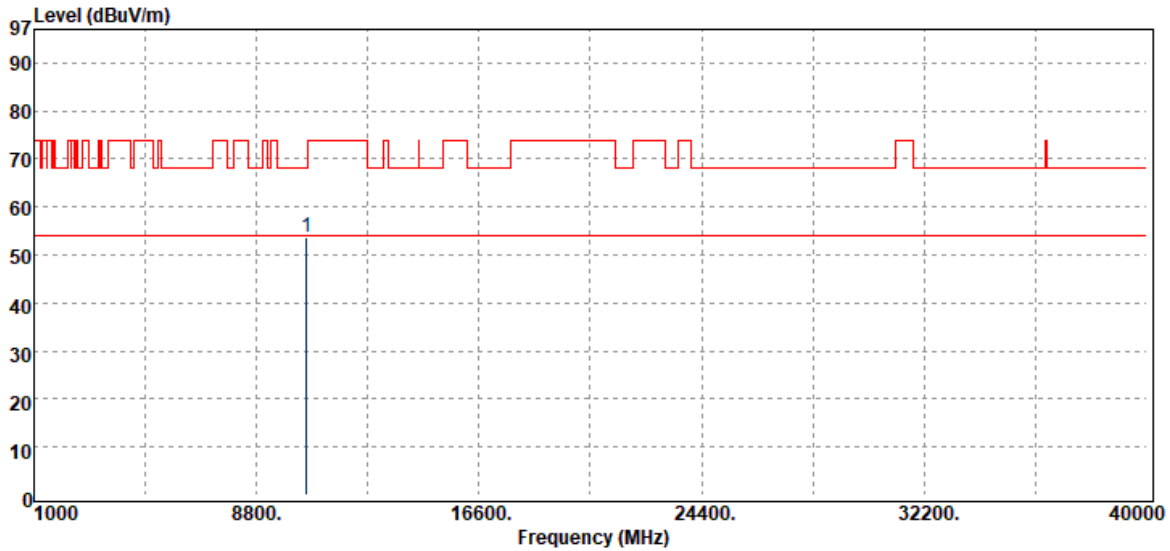

| Freq. MHz | Detector Mode PK/QP/AV | Spectrum Reading Level dB μ V | Factor dB | Actual FS dB μ V/m | Limit @3m dB μ V/m | Margin dB |
|--------------|------------------------------|---|--------------|------------------------------|------------------------------|--------------|
| 10540.00 | Peak | 33.89 | 19.78 | 53.67 | 68.20 | -14.53 |

Unless otherwise stated the results shown in this test report refer only to the sample(s) tested and such sample(s) are retained for 90 days only.

除非另有說明，此報告結果僅對測試之樣品負責，同時此樣品僅保留90天。本報告未經本公司書面許可，不可部份複製。

This document is issued by the Company subject to its General Conditions of Service printed overleaf, available on request or accessible at <http://www.sgs.com.tw/Terms-and-Conditions> and for electronic format documents, subject to Terms and Conditions for Electronic Documents at <http://www.sgs.com.tw/Terms-and-Conditions>. Attention is drawn to the limitation of liability, indemnification and jurisdiction issues defined therein. Any holder of this document is advised that information contained hereon reflects the Company's findings at the time of its intervention only and within the limits of Client's instructions, if any. The Company's sole responsibility is to its Client and this document does not exonerate parties to a transaction from exercising all their rights and obligations under the transaction documents. This document cannot be reproduced except in full, without prior written approval of the Company. Any unauthorized alteration, forgery or falsification of the content or appearance of this document is unlawful and offenders may be prosecuted to the fullest extent of the law.

Report Number :ER-2021-20085
 Operation Mode :802.11ax40
 Test Frequency :5310 MHz
 Test Mode :Tx CH High
 EUT Pol :H Plane

Test Site :SAC III Chamber
 Test Date :2021-03-05
 Temp./Humi. :21.8/63
 Antenna Pol. :VERTICAL
 Engineer :Ricky

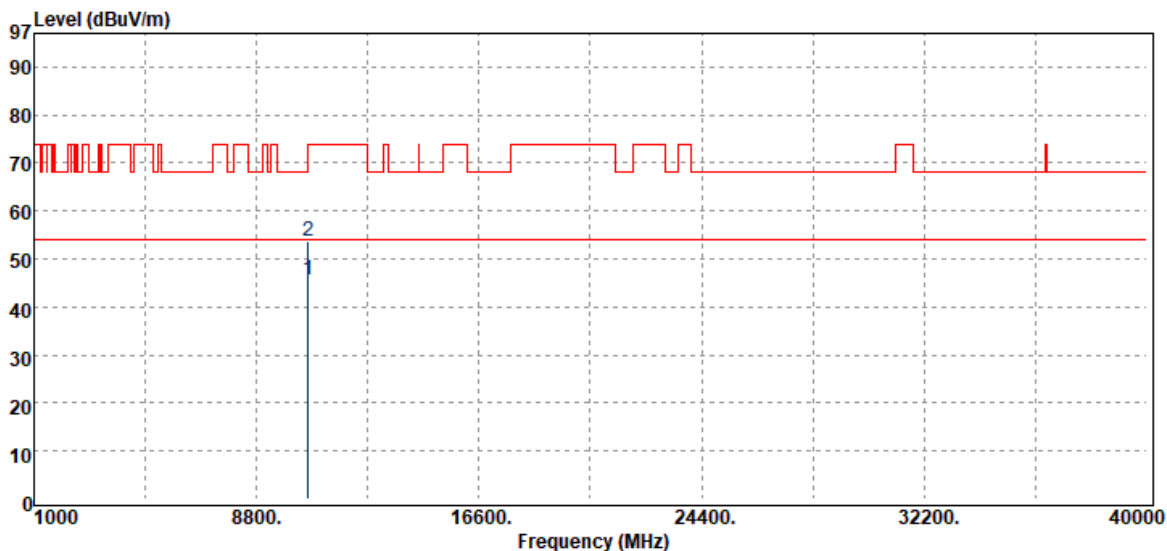

| Freq. MHz | Detector Mode PK/QP/AV | Spectrum Reading Level dB μ V | Factor dB | Actual FS dB μ V/m | Limit @3m dB μ V/m | Margin dB |
|--------------|------------------------------|---|--------------|------------------------------|------------------------------|--------------|
| 10620.00 | Average | 25.61 | 20.12 | 45.73 | 54.00 | -8.27 |
| 10620.00 | Peak | 33.43 | 20.12 | 53.55 | 74.00 | -20.45 |

Unless otherwise stated the results shown in this test report refer only to the sample(s) tested and such sample(s) are retained for 90 days only.

除非另有說明，此報告結果僅對測試之樣品負責，同時此樣品僅保留90天。本報告未經本公司書面許可，不可部份複製。

This document is issued by the Company subject to its General Conditions of Service printed overleaf, available on request or accessible at <http://www.sgs.com.tw/Terms-and-Conditions> and for electronic format documents, subject to Terms and Conditions for Electronic Documents at <http://www.sgs.com.tw/Terms-and-Conditions>. Attention is drawn to the limitation of liability, indemnification and jurisdiction issues defined therein. Any holder of this document is advised that information contained hereon reflects the Company's findings at the time of its intervention only and within the limits of Client's instructions, if any. The Company's sole responsibility is to its Client and this document does not exonerate parties to a transaction from exercising all their rights and obligations under the transaction documents. This document cannot be reproduced except in full, without prior written approval of the Company. Any unauthorized alteration, forgery or falsification of the content or appearance of this document is unlawful and offenders may be prosecuted to the fullest extent of the law.

Report Number :ER-2021-20085
 Operation Mode :802.11ax40
 Test Frequency :5310 MHz
 Test Mode :Tx CH High
 EUT Pol :H Plane

Test Site :SAC III Chamber
 Test Date :2021-03-05
 Temp./Humi. :21.8/63
 Antenna Pol. :HORIZONTAL
 Engineer :Ricky

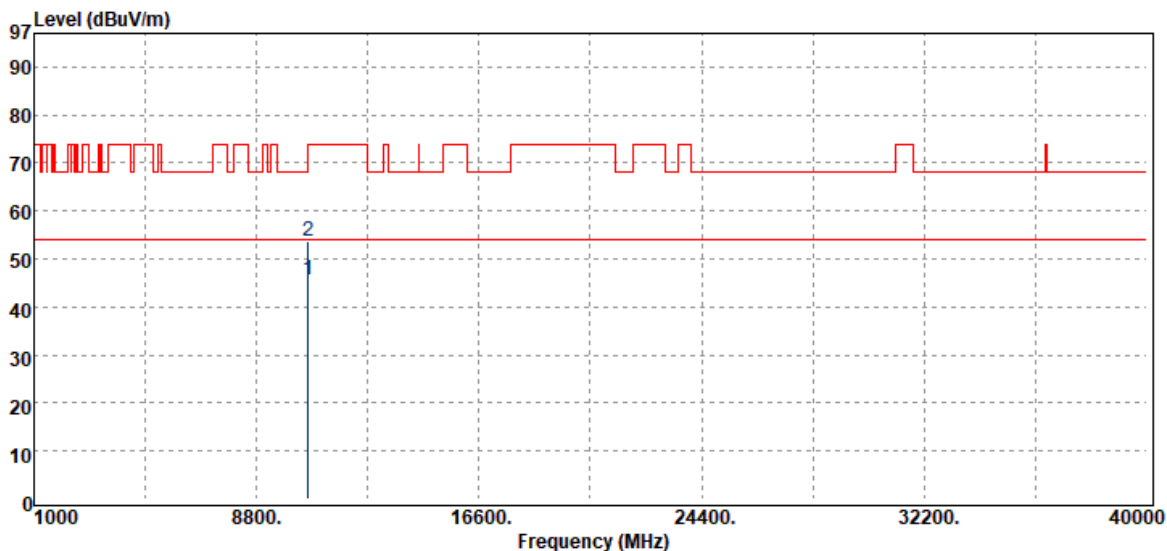

| Freq. MHz | Detector Mode PK/QP/AV | Spectrum Reading Level dB μ V | Factor dB | Actual FS dB μ V/m | Limit @3m dB μ V/m | Margin dB |
|--------------|------------------------------|---|--------------|------------------------------|------------------------------|--------------|
| 10620.00 | Average | 25.45 | 20.12 | 45.57 | 54.00 | -8.43 |
| 10620.00 | Peak | 33.47 | 20.12 | 53.59 | 74.00 | -20.41 |

Unless otherwise stated the results shown in this test report refer only to the sample(s) tested and such sample(s) are retained for 90 days only.

除非另有說明，此報告結果僅對測試之樣品負責，同時此樣品僅保留90天。本報告未經本公司書面許可，不可部份複製。

This document is issued by the Company subject to its General Conditions of Service printed overleaf, available on request or accessible at <http://www.sgs.com.tw/Terms-and-Conditions> and for electronic format documents, subject to Terms and Conditions for Electronic Documents at <http://www.sgs.com.tw/Terms-and-Conditions>. Attention is drawn to the limitation of liability, indemnification and jurisdiction issues defined therein. Any holder of this document is advised that information contained hereon reflects the Company's findings at the time of its intervention only and within the limits of Client's instructions, if any. The Company's sole responsibility is to its Client and this document does not exonerate parties to a transaction from exercising all their rights and obligations under the transaction documents. This document cannot be reproduced except in full, without prior written approval of the Company. Any unauthorized alteration, forgery or falsification of the content or appearance of this document is unlawful and offenders may be prosecuted to the fullest extent of the law.

Report Number :ER-2021-20085
 Operation Mode :802.11ax40
 Test Frequency :5510 MHz
 Test Mode :Tx CH Low
 EUT Pol :H Plane

Test Site :SAC III Chamber
 Test Date :2021-03-05
 Temp./Humi. :21.8/63
 Antenna Pol. :VERTICAL
 Engineer :Ricky

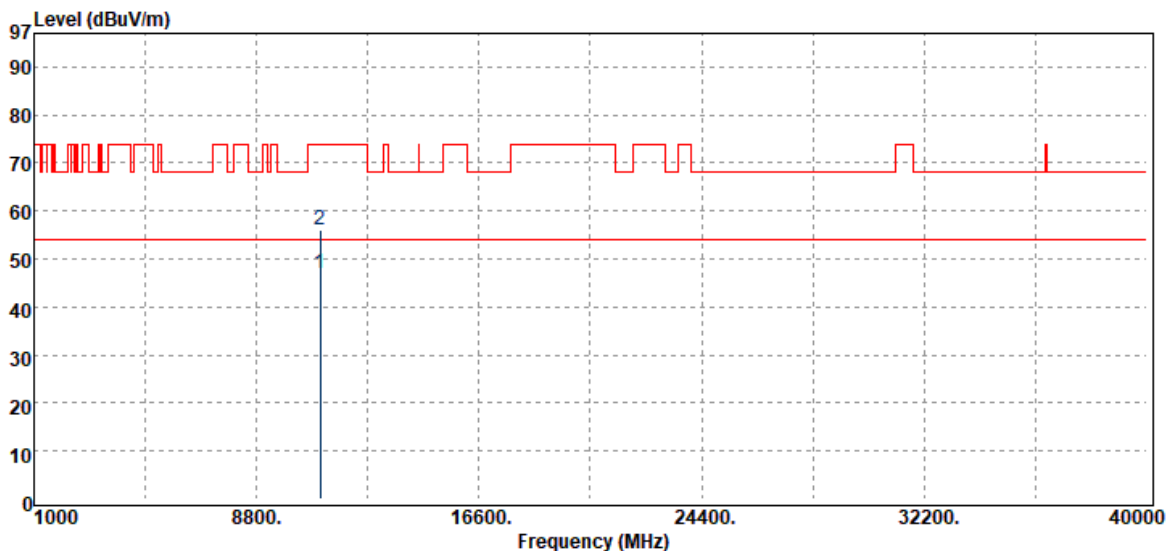

| Freq. MHz | Detector Mode PK/QP/AV | Spectrum Reading Level dB μ V | Factor dB | Actual FS dB μ V/m | Limit @3m dB μ V/m | Margin dB |
|--------------|------------------------------|---|--------------|------------------------------|------------------------------|--------------|
| 11020.00 | Average | 25.42 | 21.61 | 47.03 | 54.00 | -6.97 |
| 11020.00 | Peak | 34.41 | 21.61 | 56.02 | 74.00 | -17.98 |

Unless otherwise stated the results shown in this test report refer only to the sample(s) tested and such sample(s) are retained for 90 days only.

除非另有說明，此報告結果僅對測試之樣品負責，同時此樣品僅保留90天。本報告未經本公司書面許可，不可部份複製。

This document is issued by the Company subject to its General Conditions of Service printed overleaf, available on request or accessible at <http://www.sgs.com.tw/Terms-and-Conditions> and for electronic format documents, subject to Terms and Conditions for Electronic Documents at <http://www.sgs.com.tw/Terms-and-Conditions>. Attention is drawn to the limitation of liability, indemnification and jurisdiction issues defined therein. Any holder of this document is advised that information contained hereon reflects the Company's findings at the time of its intervention only and within the limits of Client's instructions, if any. The Company's sole responsibility is to its Client and this document does not exonerate parties to a transaction from exercising all their rights and obligations under the transaction documents. This document cannot be reproduced except in full, without prior written approval of the Company. Any unauthorized alteration, forgery or falsification of the content or appearance of this document is unlawful and offenders may be prosecuted to the fullest extent of the law.

Report Number :ER-2021-20085
 Operation Mode :802.11ax40
 Test Frequency :5510 MHz
 Test Mode :Tx CH Low
 EUT Pol :H Plane

Test Site :SAC III Chamber
 Test Date :2021-03-05
 Temp./Humi. :21.8/63
 Antenna Pol. :HORIZONTAL
 Engineer :Ricky

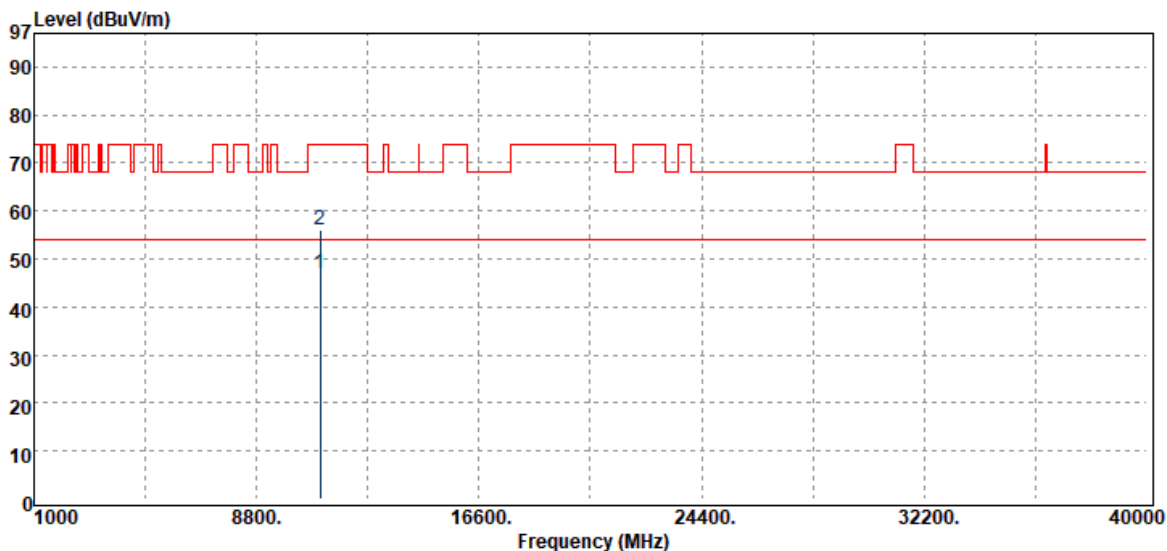

| Freq. MHz | Detector Mode PK/QP/AV | Spectrum Reading Level dB μ V | Factor dB | Actual FS dB μ V/m | Limit @3m dB μ V/m | Margin dB |
|--------------|------------------------------|---|--------------|------------------------------|------------------------------|--------------|
| 11020.00 | Average | 25.39 | 21.61 | 47.00 | 54.00 | -7.00 |
| 11020.00 | Peak | 34.56 | 21.61 | 56.17 | 74.00 | -17.83 |

Unless otherwise stated the results shown in this test report refer only to the sample(s) tested and such sample(s) are retained for 90 days only.

除非另有說明，此報告結果僅對測試之樣品負責，同時此樣品僅保留90天。本報告未經本公司書面許可，不可部份複製。

This document is issued by the Company subject to its General Conditions of Service printed overleaf, available on request or accessible at <http://www.sgs.com.tw/Terms-and-Conditions> and for electronic format documents, subject to Terms and Conditions for Electronic Documents at <http://www.sgs.com.tw/Terms-and-Conditions>. Attention is drawn to the limitation of liability, indemnification and jurisdiction issues defined therein. Any holder of this document is advised that information contained hereon reflects the Company's findings at the time of its intervention only and within the limits of Client's instructions, if any. The Company's sole responsibility is to its Client and this document does not exonerate parties to a transaction from exercising all their rights and obligations under the transaction documents. This document cannot be reproduced except in full, without prior written approval of the Company. Any unauthorized alteration, forgery or falsification of the content or appearance of this document is unlawful and offenders may be prosecuted to the fullest extent of the law.