



FCC 47 CFR PART 15 SUBPART C

TEST REPORT

For

Rugged Handheld Device

Model: IMX-3000

Trade Name: 

Issued to

**ADLINK TECHNOLOGY INC.
9F, No.166, Jian Yi Rd., Zhonghe Dist.,
New Taipei City, 235 Taiwan**

Issued by

**Compliance Certification Services Inc.
No.11, Wugong 6th Rd., Wugu Dist.,
New Taipei City 24891, Taiwan. (R.O.C.)
<http://www.ccsrf.com>
service@ccsrf.com
Issued Date: August 18, 2014**



Note: This report shall not be reproduced except in full, without the written approval of Compliance Certification Services Inc. This document may be altered or revised by Compliance Certification Services Inc. personnel only, and shall be noted in the revision section of the document.



Revision History

Rev.	Issue Date	Revisions	Effect Page	Revised By
00	August 18, 2014	Initial Issue	ALL	Doris Chu



TABLE OF CONTENTS

1. TEST RESULT CERTIFICATION.....	4
2. EUT DESCRIPTION	5
3. TEST METHODOLOGY	6
3.1 EUT CONFIGURATION	6
3.2 EUT EXERCISE	6
3.3 GENERAL TEST PROCEDURES	6
3.4 FCC PART 15.205 RESTRICTED BANDS OF OPERATIONS	7
3.5 DESCRIPTION OF TEST MODES	7
4. INSTRUMENT CALIBRATION.....	8
4.1 MEASURING INSTRUMENT CALIBRATION	8
4.2 MEASUREMENT EQUIPMENT USED	8
4.3 MEASUREMENT UNCERTAINTY	9
5. FACILITIES AND ACCREDITATIONS	10
5.1 FACILITIES	10
5.2 EQUIPMENT	10
5.3 TABLE OF ACCREDITATIONS AND LISTINGS	11
6. SETUP OF EQUIPMENT UNDER TEST	12
6.1 SETUP CONFIGURATION OF EUT	12
6.2 SUPPORT EQUIPMENT.....	12
7. FCC PART 15.225 REQUIREMENTS.....	13
7.1 20 DB BANDWIDTH	13
7.2 RADIATED EMISSIONS	15
7.3 FREQUENCY STABILITY	21
7.4 POWERLINE CONDUCTED EMISSIONS	23
APPENDIX I PHOTOGRAPHS OF TEST SETUP	26
APPENDIX 1 - PHOTOGRAPHS OF EUT	



1. TEST RESULT CERTIFICATION

Applicant: ADLINK TECHNOLOGY INC.
9F, No.166, Jian Yi Rd., Zhonghe Dist.,
New Taipei City, 235 Taiwan

Equipment Under Test: Rugged Handheld Device

Trade Name: 

Model: IMX-3000

Date of Test: June 10 ~ July 8, 2014

APPLICABLE STANDARDS	
STANDARD	TEST RESULT
FCC 47 CFR Part 15 Subpart C	No non-compliance noted

We hereby certify that:

The above equipment was tested by Compliance Certification Services Inc. The test data, data evaluation, test procedures, and equipment configurations shown in this report were made in accordance with the procedures given in ANSI C63.4: 2009 and the energy emitted by the sample tested as described in this report is in compliance with the requirements of FCC Rules Part 15.225.

The test results of this report relate only to the tested sample identified in this report.

Approved by:

Reviewed by:



Miller Lee
Section Manager
Compliance Certification Services Inc.

Angel Cheng
Section Manager
Compliance Certification Services Inc.



2. EUT DESCRIPTION

Product	Rugged Handheld Device
Trade Name	
Model Number	IMX-3000
Model Difference	N/A
Received Date	May 24, 2014
Power Supply	Power from Power Adapter Model: STD-05035V I/P : 100-240V 47-63Hz 0.48A MAX O/P: 5V 3.5A
Frequency Range	13.56MHz
Modulation Technique	ASK
Number of Channels	1 Channel
Antenna Designation	Loop Antenna / Gain: 0.9292dBi

Remark:

1. The sample selected for test was engineering sample that approximated to production product and was provided by manufacturer.
2. This submittal(s) (test report) is intended for FCC ID: X4D-IMX-3000 filing to comply with Section 15.225 of the FCC Part 15, Subpart C Rules.



3. TEST METHODOLOGY

The tests documented in this report were performed in accordance with ANSI C63.4: 2009 and FCC CFR 47 Part 15.207, 15.209 and 15.225.

3.1 EUT CONFIGURATION

The EUT configuration for testing is installed on RF field strength measurement to meet the Commissions requirement and operating in a manner that intends to maximize its emission characteristics in a continuous normal application.

3.2 EUT EXERCISE

The EUT was operated in the engineering mode to fix the TX frequency that was for the purpose of the measurements.

3.3 GENERAL TEST PROCEDURES

Conducted Emissions

The EUT is placed on the turntable, which is 0.8 m above ground plane. According to the requirements in Section 13.1.4.1 of ANSI C63.4: 2009. Conducted emissions from the EUT measured in the frequency range between 0.15 MHz and 30MHz using CISPR Quasi-peak and average detector modes.

Radiated Emissions

The EUT is placed on a turn table, which is 0.8 m above ground plane. The turntable shall rotate 360 degrees to determine the position of maximum emission level. EUT is set 3m away from the receiving antenna, which varied from 1m to 4m to find out the highest emission. And also, each emission was to be maximized by changing the polarization of receiving antenna both horizontal and vertical. In order to find out the maximum emissions, exploratory radiated emission measurements were made according to the requirements in Section 13.1.4.1 of ANSI C63.4: 2009.



3.4 FCC PART 15.205 RESTRICTED BANDS OF OPERATIONS

(a) Except as shown in paragraph (d) of this section, only spurious emissions are permitted in any of the frequency bands listed below:

MHz	MHz	MHz	GHz
0.090 - 0.110	16.42 - 16.423	399.9 - 410	4.5 - 5.15
¹ 0.495 - 0.505	16.69475 - 16.69525	608 - 614	5.35 - 5.46
2.1735 - 2.1905	16.80425 - 16.80475	960 - 1240	7.25 - 7.75
4.125 - 4.128	25.5 - 25.67	1300 - 1427	8.025 - 8.5
4.17725 - 4.17775	37.5 - 38.25	1435 - 1626.5	9.0 - 9.2
4.20725 - 4.20775	73 - 74.6	1645.5 - 1646.5	9.3 - 9.5
6.215 - 6.218	74.8 - 75.2	1660 - 1710	10.6 - 12.7
6.26775 - 6.26825	108 - 121.94	1718.8 - 1722.2	13.25 - 13.4
6.31175 - 6.31225	123 - 138	2200 - 2300	14.47 - 14.5
8.291 - 8.294	149.9 - 150.05	2310 - 2390	15.35 - 16.2
8.362 - 8.366	156.52475 -	2483.5 - 2500	17.7 - 21.4
8.37625 - 8.38675	156.52525	2655 - 2900	22.01 - 23.12
8.41425 - 8.41475	156.7 - 156.9	3260 - 3267	23.6 - 24.0
12.29 - 12.293	162.0125 - 167.17	3332 - 3339	31.2 - 31.8
12.51975 - 12.52025	167.72 - 173.2	3345.8 - 3358	36.43 - 36.5
12.57675 - 12.57725	240 - 285	3600 - 4400	(²)
13.36 - 13.41	322 - 335.4		

¹ Until February 1, 1999, this restricted band shall be 0.490-0.510 MHz.

² Above 38.6

(b) Except as provided in paragraphs (d) and (e), the field strength of emissions appearing within these frequency bands shall not exceed the limits shown in Section 15.209. At frequencies equal to or less than 1000 MHz, compliance with the limits in Section 15.209 shall be demonstrated using measurement instrumentation employing a CISPR quasi-peak detector. Above 1000 MHz, compliance with the emission limits in Section 15.209 shall be demonstrated based on the average value of the measured emissions. The provisions in Section 15.35 apply to these measurements.

3.5 DESCRIPTION OF TEST MODES

The EUT (model: IMX-3000) had been tested under engineering test mode condition and the EUT staying in continuous transmitting mode.



4. INSTRUMENT CALIBRATION

4.1 MEASURING INSTRUMENT CALIBRATION

The measuring equipment, which was utilized in performing the tests documented herein, has been calibrated in accordance with the manufacturer's recommendations for utilizing calibration equipment, which is traceable to recognized national standards.

4.2 MEASUREMENT EQUIPMENT USED

Equipment Used for Emissions Measurement

Remark: Each piece of equipment is scheduled for calibration once a year and Loop Antenna is scheduled for calibration once three years.

Conducted Emissions Test Site				
Name of Equipment	Manufacturer	Model	Serial Number	Calibration Due
Spectrum Analyzer	Agilent	E4446A	MY43360131	11/05/2014
Power Meter	Anritsu	ML2495A	1012009	06/03/2015
Power Sensor	Anritsu	MA2411B	0917072	06/03/2015

Wugu 966 Chamber A				
Name of Equipment	Manufacturer	Model	Serial Number	Calibration Due
Spectrum Analyzer	Agilent	E4446A	US42510268	11/05/2014
EMI Test Receiver	R&S	ESCI	100064	02/27/2015
Pre-Amplifier	Mini-Circuits	ZFL-1000LN	SF350700823	01/11/2015
Pre-Amplifier	MITEQ	AFS44-00102650-42-10P-44	1415367	11/18/2014
Bilog Antenna	Sunol Sciences	JB3	A030105	10/01/2014
Horn Antenna	EMCO	3117	00055165	02/12/2015
Horn Antenna	EMCO	3116	2487	10/09/2014
Turn Table	CCS	CC-T-1F	N/A	N.C.R
Antenna Tower	CCS	CC-A-1F	N/A	N.C.R
Controller	CCS	CC-C-1F	N/A	N.C.R
Site NSA	CCS	N/A	N/A	12/21/2014
Test S/W	EZ-EMC (CCS-3A1RE)			

Conducted Emission room # A				
Name of Equipment	Manufacturer	Model	Serial Number	Calibration Due
EMI Test Receiver	R&S	ESCI	101203	09/12/2014
LISN	R&S	ESH3-Z5	848773/014	12/09/2014
ISN	FCC	FCC-TLISN-T8-02-09	101131	09/04/2014
Coaxial Cable	Commate	CFD300-NL	NA	12/05/2014
Test S/W	CCS-3A1-CE			



4.3 MEASUREMENT UNCERTAINTY

PARAMETER	UNCERTAINTY
Powerline Conducted Emission	+/- 1.2575
3M Semi Anechoic Chamber / 30M~200M	+/- 4.0138
3M Semi Anechoic Chamber / 200M~1000M	+/- 3.9483
3M Semi Anechoic Chamber / 1G~8G	+/- 2.5975
3M Semi Anechoic Chamber / 8G~18G	+/- 2.6112
3M Semi Anechoic Chamber / 18G~26G	+/- 2.7389
3M Semi Anechoic Chamber / 26G~40G	+/- 2.9683

Remark: This uncertainty represents an expanded uncertainty expressed at approximately the 95% confidence level using a coverage factor of $k=2$.



5. FACILITIES AND ACCREDITATIONS

5.1 FACILITIES

All measurement facilities used to collect the measurement data are located at

No.199, Chunghsen Road, Hsintien City, Taipei Hsien, Taiwan, R.O.C.
Tel: 886-2-2217-0894 / Fax: 886-2-2217-1029

No.11, Wugong 6th Rd., Wugu Dist., New Taipei City 24891, Taiwan. (R.O.C.)
Tel: 886-2-2299-9720 / Fax: 886-2-2298-4045

No.81-1, Lane 210, Bade 2nd Rd., Lujhu Township, Taoyuan County 33841,
TAIWAN, R.O.C.
Tel: 886-3-324-0332 / Fax: 886-3-324-5235

The sites are constructed in conformance with the requirements of ANSI C63.7, ANSI C63.4 and CISPR Publication 22.

5.2 EQUIPMENT

Radiated emissions are measured with one or more of the following types of linearly polarized antennas: tuned dipole, biconical, log periodic, bi-log, and/or ridged waveguide, horn. Spectrum analyzers with pre-selectors and quasi-peak detectors are used to perform radiated measurements.



Conducted emissions are measured with Line Impedance Stabilization Networks and EMI Test Receivers.

Calibrated wideband preamplifiers, coaxial cables, and coaxial attenuators are also used for making measurements.

All receiving equipment conforms to CISPR Publication 16-1, "Radio Interference Measuring Apparatus and Measurement Methods."



5.3 TABLE OF ACCREDITATIONS AND LISTINGS

Country	Agency	Scope of Accreditation	Logo
USA	FCC	3M Semi Anechoic Chamber (FCC MRA: TW1039) to perform FCC Part 15 measurements	 FCC MRA: TW1039
Taiwan	TAF	LP0002, RTTE01, FCC Method-47 CFR Part 15 Subpart C, D, E, RSS-210, RSS-310 IDA TS SRD, AS/NZS 4268, AS/NZS 4771, TS 12.1 & 12.2, ETSI EN 300 440-1, ETSI EN 300 440-2, ETSI EN 300 328, ETSI EN 300 220-1, ETSI EN 300 220-2, ETSI EN 301 893, ETSI EN 301 489-1/3/7/17 FCC OET Bulletin 65 + Supplement C, EN 50360, EN 50361, EN 50371, RSS 102, EN 50383, EN 50385, EN 50392, IEC 62209, CNS 14958-1, CNS 14959 FCC Method -47 CFR Part 15 Subpart B IEC / EN 61000-3-2, IEC / EN 61000-3-3, IEC / EN 61000-4-2/3/4/5/6/8/11	
Canada	Industry Canada	3M Semi Anechoic Chamber (IC 2324G-1 / IC 2324G-2) to perform	 IC 2324G-1 IC 2324G-2

* No part of this report may be used to claim or imply product endorsement by A2LA or any agency of the US Government.



6. SETUP OF EQUIPMENT UNDER TEST

6.1 SETUP CONFIGURATION OF EUT

See test photographs attached in Appendix I for the actual connections between EUT and support equipment.

6.2 SUPPORT EQUIPMENT

No.	Device Type	Brand	Model	Series No.	FCC ID	Data Cable	Power Cord
	N/A						

Remark:

- 1. All the equipment/cables were placed in the worst-case configuration to maximize the emission during the test.*
- 2. Grounding was established in accordance with the manufacturer's requirements and conditions for the intended use.*



7. FCC PART 15.225 REQUIREMENTS

7.1 20 DB BANDWIDTH

LIMIT

None; for reporting purposes only.

Test Configuration

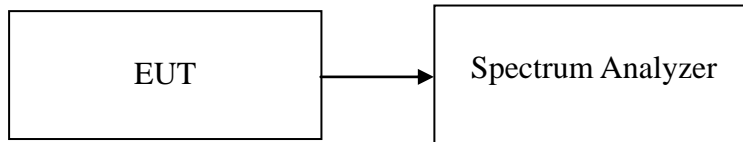

TEST PROCEDURE

1. Place the EUT on the table and set it in the transmitting mode.
2. Remove the antenna from the EUT and then connect a low loss RF cable from the antenna port to the spectrum analyzer.
3. Set the spectrum analyzer as RBW= 5.1kHz, VBW = 10kHz, Span = 500kHz, Sweep = auto.
4. Mark the peak frequency and 20dB (upper and lower) frequency.
5. Repeat until all the rest channels are investigated.

TEST RESULTS

No non-compliance noted.



Test Plot

Agilent

R T

▲ Mkr3 16.8 kHz
0.14 dB

Ref -10 dBm

#Atten 0 dB

#Peak
Log
10
dB/

DI
-50.2
dBm
LgAv

V1 S2

Center 13.560 0 MHz

Span 500 kHz

#Res BW 3 kHz

#VBW 10 kHz

Sweep 52.72 ms (601 pts)

Marker	Trace	Type	X Axis	Amplitude
1	(1)	Freq	13.560 8 MHz	-30.17 dBm
3R	(1)	Freq	13.552 5 MHz	-50.21 dBm
3Δ	(1)	Freq	16.8 kHz	0.14 dB



7.2 RADIATED EMISSIONS

LIMIT

According to §15.225,

- (a) The field strength of any emissions within the band 13.553 – 13.567 MHz shall not exceed 15,848 microvolts / meter at 30 meters.
- (b) Within the bands 13.410 – 13.553 MHz and 13.567 -13.710 MHz, the field strength of any emissions shall not exceed 334 microvolts / meter at 30 meters.
- (c) Within the bands 13.110 – 13.410 MHz and 13.710 – 14.010 MHz the field strength of any emissions shall not exceed 106 microvolts / meter at 30 meters.
- (d) The field strength of any emissions appearing outside of the 13.110 – 14.010 MHz and shall not exceed the general radiated emission limits in §15.209.

According to §15.225, except as provided elsewhere in this Subpart, the emissions from an intentional radiator shall not exceed the field strength levels specified in the following table:

Frequency (MHz)	Field Strength ($\mu\text{V/m}$ at meter)	Measurement Distance (meter)
0.009 – 0.490	2400 / F (kHz)	300
0.490 – 1.705	24000 / F (kHz)	30
1.705 – 30.0	30	30
30 - 88	100**	3
88-216	150**	3
216-960	200**	3
Above 960	500	3

** Except as provided in paragraph (g), fundamental emissions from intentional radiators operating under this Section shall not be located in the frequency bands 54-72 MHz, 76-88 MHz, 174-216 MHz or 470-806 MHz. However, operation within these frequency bands is permitted under other sections of this Part, e.g., Sections 15.231 and 15.241.



Test Configuration

9kHz ~ 30MHz

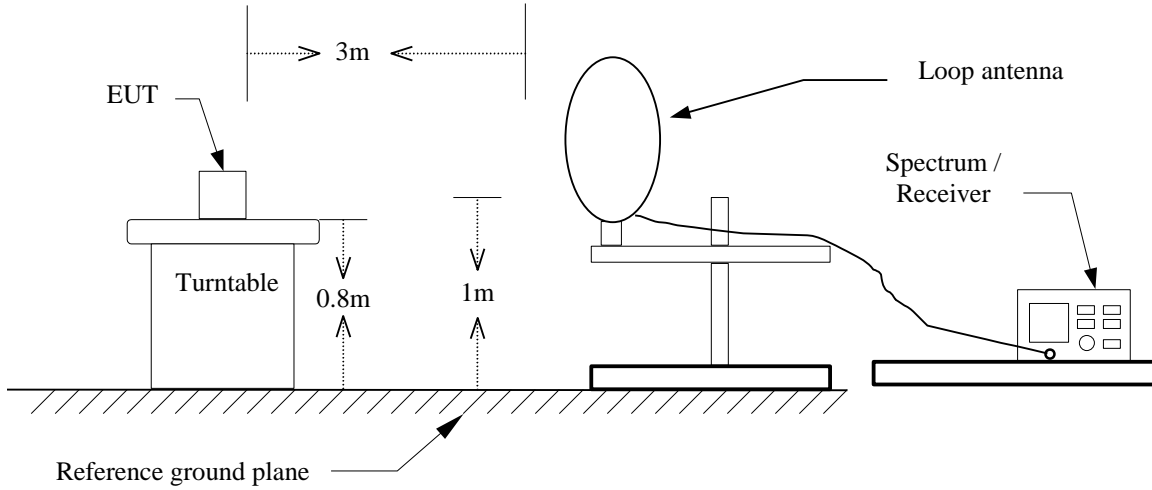

30MHz ~ 1GHz

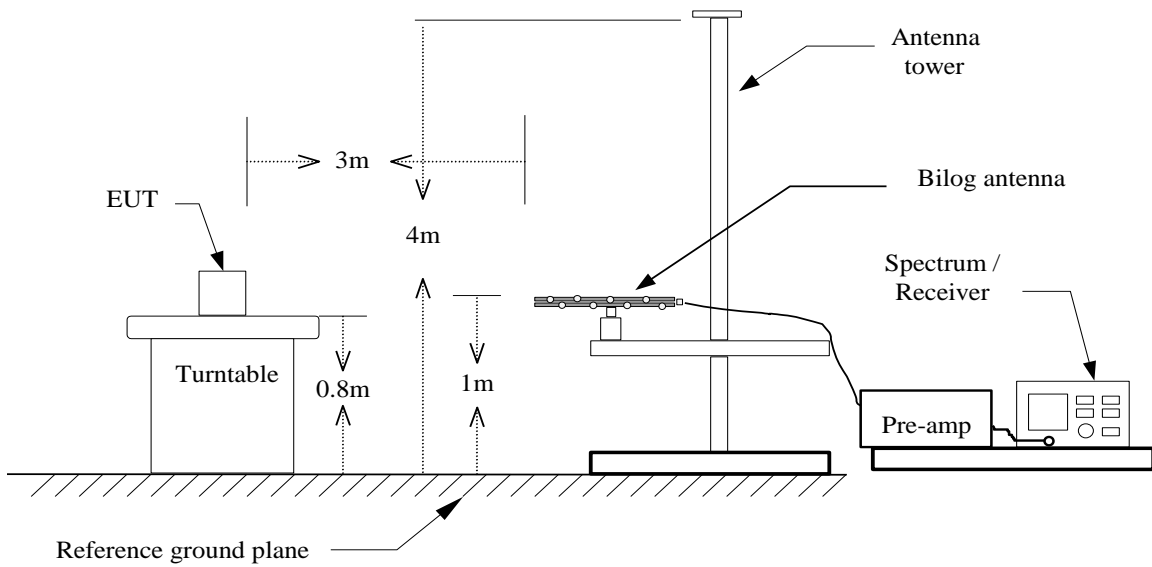



TEST PROCEDURE

For 9kHz ~ 30MHz

1. The EUT is placed on a turntable, which is 0.8m above ground plane.
2. The turntable shall be rotated for 360 degrees to determine the position of maximum emission level.
3. EUT is set 3m away from the receiving antenna, The center of the loop shall be 1 m above the ground then to find out the highest emissions.
4. Maximum procedure was performed on the six highest emissions to ensure EUT compliance.
5. Set the spectrum analyzer in the following setting as:
RBW=10kHz / VBW=30kHz / Sweep=AUTO
6. Repeat above procedures until the measurements for all frequencies are complete.

For 30MHz ~ 1GHz

1. The EUT is placed on a turntable, which is 0.8m above ground plane.
2. The turntable shall be rotated for 360 degrees to determine the position of maximum emission level.
3. EUT is set 3m away from the receiving antenna, which is varied from 1m to find out the highest emissions.
4. Maximum procedure was performed on the six highest emissions to ensure EUT compliance.
5. And also, each emission was to be maximized by changing the polarization of receiving antenna both horizontal and vertical.
6. Set the spectrum analyzer in the following setting as:
RBW=100kHz / VBW=300kHz / Sweep=AUTO
7. Repeat above procedures until the measurements for all frequencies are complete.



Operation Mode: TX mode **Test Date:** June 10, 2014
Temperature: 27°C **Tested by:** Andy Shi
Humidity: 53 % RH **Polarity:** Ver. / Hor.

Frequency (MHz)	Reading (dBuV)	Correction Factor (dB/m)	Result (dBuV/m)	Limit 3m (dBuV/m)	Margin (dB)	Detector Mode (PK/QP/AVG)
13.5608	37.49	14.66	52.15	124.00	-71.85	PK

Remark:

1. *Measuring frequencies from 9kHz to the 1GHz.*
2. *Radiated emissions measured were made with an instrument using peak/quasi-peak/average detector mode.*
3. *Measurements above show only up to 6 maximum emissions noted, or would be lesser, with " N/A " remark, if no specific emissions from the EUT are recorded (ie: margin>20dB from the applicable limit) and considered that's already beyond the background noise floor.*
4. *Margin (dB) = Result (dBuV/m) – Limit (dBuV/m).*



9kHz ~ 30MHz

Operation Mode: TX mode **Test Date:** June 10, 201
Temperature: 27°C **Tested by:** Andy Shi
Humidity: 53 % RH

Frequency (MHz)	Reading (dBuV)	Correction Factor (dB/m)	Result (dBuV/m)	Limit (dBuV/m)	Margin (dB)	Detector Mode (PK/QP/AVG)
0.1427	49.79	-17.20	32.59	118.86	-86.27	Peak
0.2139	45.81	-17.26	28.55	113.72	-85.17	Peak
0.2683	44.58	-17.30	27.28	109.80	-82.52	Peak
0.3154	41.71	-17.31	24.40	106.40	-82.00	Peak
0.3544	40.61	-17.32	23.29	103.59	-80.30	Peak
0.3818	41.18	-17.33	23.85	101.61	-77.76	Peak
9.0774	15.25	-11.36	3.89	69.50	-65.61	Peak
12.1169	12.18	-9.35	2.83	69.50	-66.67	Peak
16.8976	13.06	-6.32	6.74	69.50	-62.76	Peak
18.9337	11.06	-5.03	6.03	69.50	-63.47	Peak
22.9176	11.40	-2.67	8.73	69.50	-60.77	Peak
25.1013	12.11	-1.44	10.67	69.50	-58.83	Peak

Remark:

1. *Measuring frequencies from 9kHz to the 1GHz.*
2. *Radiated emissions measured were made with an instrument using peak/quasi-peak/average detector mode.*
3. *Measurements above show only up to 6 maximum emissions noted, or would be lesser, with “ N/A ” remark, if no specific emissions from the EUT are recorded (ie: margin>20dB from the applicable limit) and considered that's already beyond the background noise floor.*
4. *Margin (dB) = Result (dBuV/m) – Limit (dBuV/m).*

**30MHz ~ 1GHz****Operation Mode:** TX mode**Test Date:** June 10, 201**Temperature:** 27°C**Tested by:** Andy Shi**Humidity:** 53 % RH

Frequency (MHz)	Reading (dBuV)	Correction Factor (dB/m)	Result (dBuV/m)	Limit 3m (dBuV/m)	Margin (dB)	Ant.Pol. (H/V)	Detector Mode (PK/QP/AVG)
43.5800	50.29	-19.24	31.05	40.00	-8.95	V	Peak
90.1400	49.07	-23.32	25.75	43.50	-17.75	V	Peak
294.8100	39.38	-16.50	22.88	46.00	-23.12	V	Peak
448.0700	39.93	-12.71	27.22	46.00	-18.78	V	Peak
602.3000	39.51	-10.45	29.06	46.00	-16.94	V	Peak
746.8300	39.26	-7.94	31.32	46.00	-14.68	V	Peak
30.0000	41.85	-9.87	31.98	40.00	-8.02	H	Peak
57.1600	54.80	-23.64	31.16	40.00	-8.84	H	Peak
134.7600	38.96	-17.61	21.35	43.50	-22.15	H	Peak
368.5300	40.46	-14.76	25.70	46.00	-20.30	H	Peak
595.5100	40.43	-10.55	29.88	46.00	-16.12	H	Peak
868.0800	40.15	-6.56	33.59	46.00	-12.41	H	Peak

Remark:

1. *Measuring frequencies from 9kHz to the 1GHz.*
2. *Radiated emissions measured were made with an instrument using peak/quasi-peak/average detector mode.*
3. *Measurements above show only up to 6 maximum emissions noted, or would be lesser, with " N/A " remark, if no specific emissions from the EUT are recorded (ie: margin>20dB from the applicable limit) and considered that's already beyond the background noise floor.*
4. *Margin (dB) = Result (dBuV/m) – Limit (dBuV/m).*



7.3 FREQUENCY STABILITY

LIMIT

According to §15.225(e), the frequency tolerance of the carrier signal shall be maintained within +/- 0.01% of the operating frequency over a temperature variation of -20 degrees to +50 degrees C at normal supply voltage, and for a variation in the primary supply voltage from 85% to 115% of the rated supply voltage at a temperature of 20 degrees C. For battery operated equipment, the equipment tests shall be performed using a new battery.

Test Configuration

Temperature and Voltage Measurement (under normal and extreme test conditions)

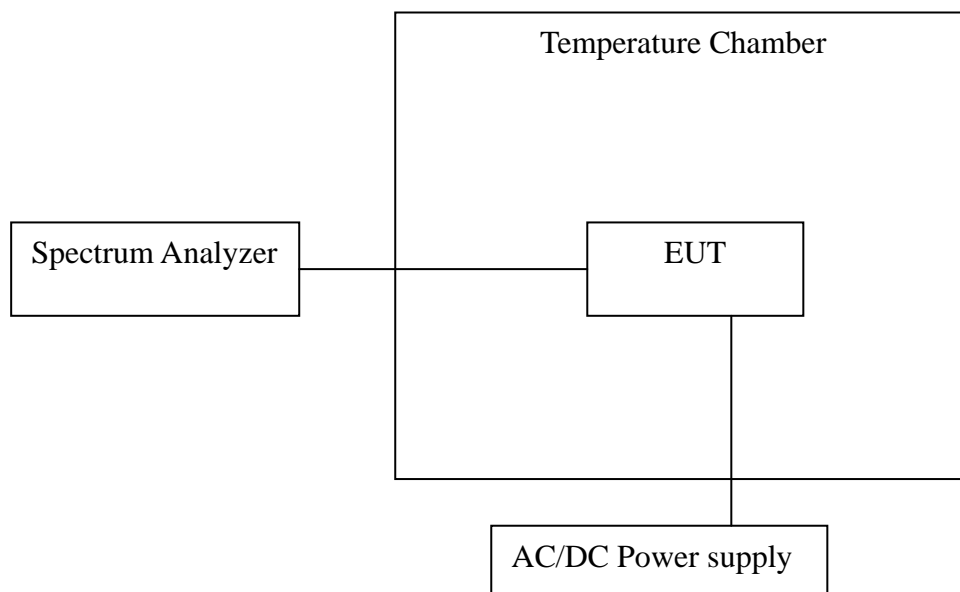

TEST PROCEDURE

1. Place the EUT on the table and set it in the transmitting mode.
2. Remove the antenna from the EUT and then connect a low loss RF cable from the antenna port to the spectrum analyzer.
3. Set the environment into appropriate environment.
4. Set the spectrum analyzer as RBW=1kHz, VBW = RBW, Span = 200kHz, Sweep = auto.
5. Mark the peak frequency and measure the frequency tolerance using frequency counter function.
6. Repeat until all the results are investigated.



TEST RESULTS

No non-compliance noted.

Temperature Variations

Temp. (°C)	Voltage (V)	Measured Frequency (MHz)	Delta Frequency (Hz)	Tolerance (%)	Limit (±%)	Margin (%)	Result (Pass/Fail)
-20	120	13.56111	1110	0.00819	0.01	-0.00181	Pass
-10		13.56018	180	0.00133	0.01	-0.00867	Pass
0		13.56003	30	0.00022	0.01	-0.00978	Pass
10		13.56012	120	0.00088	0.01	-0.00912	Pass
20		13.56020	200	0.00147	0.01	-0.00853	Pass
30		13.56007	70	0.00052	0.01	-0.00948	Pass
40		13.56004	40	0.00029	0.01	-0.00971	Pass
50		13.56009	90	0.00066	0.01	-0.00934	Pass

Voltage Variations

Temp. (°C)	Voltage (V)	Measured Frequency (MHz)	Delta Frequency (Hz)	Tolerance (%)	Limit (±%)	Margin (%)	Result (Pass/Fail)
20	102	13.56012	120	0.00088	0.01	-0.00912	Pass
	120	13.56013	130	0.00096	0.01	-0.00904	Pass
	138	13.56000	0	0.00000	0.01	-0.01000	Pass



7.4 POWERLINE CONDUCTED EMISSIONS

LIMIT

According to §15.207(a), except as shown in paragraphs (b) and (c) of this section, for an intentional radiator that is designed to be connected to the public utility (AC) power line, the radio frequency voltage that is conducted back onto the AC power line on any frequency or frequencies within the band 150 kHz to 30 MHz shall not exceed the limits in the following table, as measured using a 50 μ H/50 ohms line impedance stabilization network (LISN). Compliance with the provisions of this paragraph shall be based on the measurement of the radio frequency voltage between each power line and ground at the power terminal. The lower limit applies at the boundary between the frequency ranges.

Frequency Range (MHz)	Limits (dB μ V)	
	Quasi-peak	Average
0.15 to 0.50	66 to 56*	56 to 46*
0.50 to 5	56	46
5 to 30	60	50

* Decreases with the logarithm of the frequency.

TEST PROCEDURE

1. The EUT was placed on a table, which is 0.8m above ground plane.
2. Maximum procedure was performed on the six highest emissions to ensure EUT compliance.
3. Repeat above procedures until all frequency measured were complete.



Test Plots

Conducted emissions (Line 1)

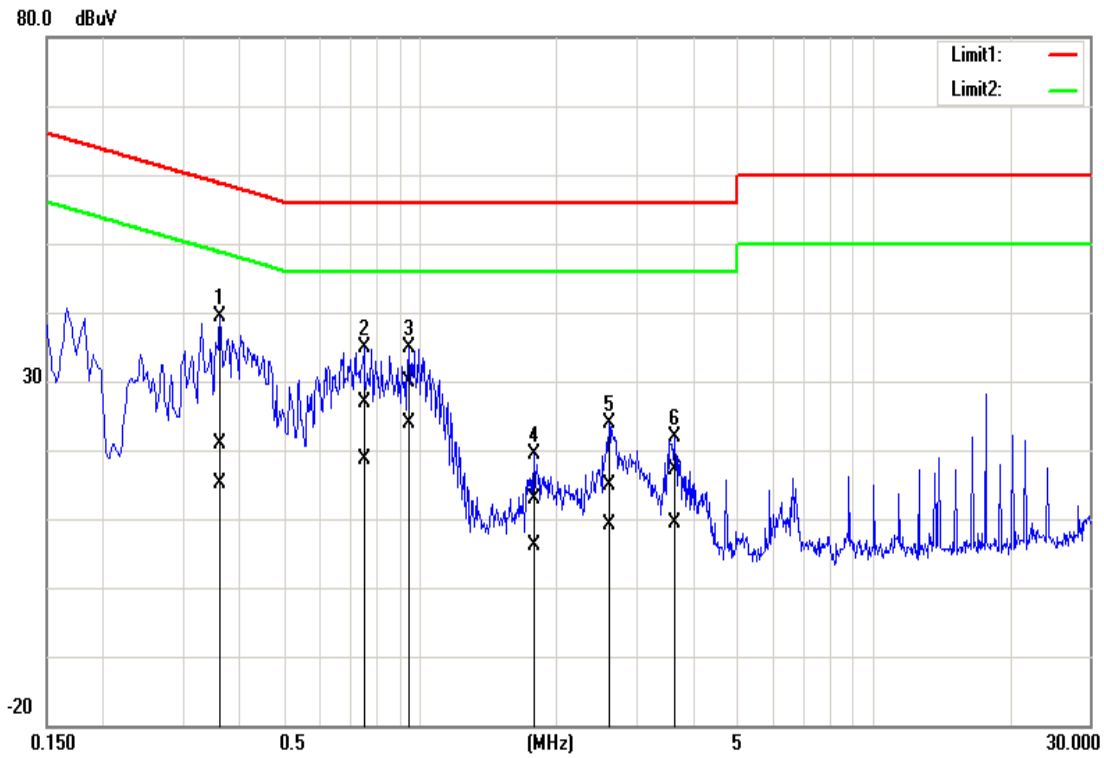

Conducted emissions (Line 2)

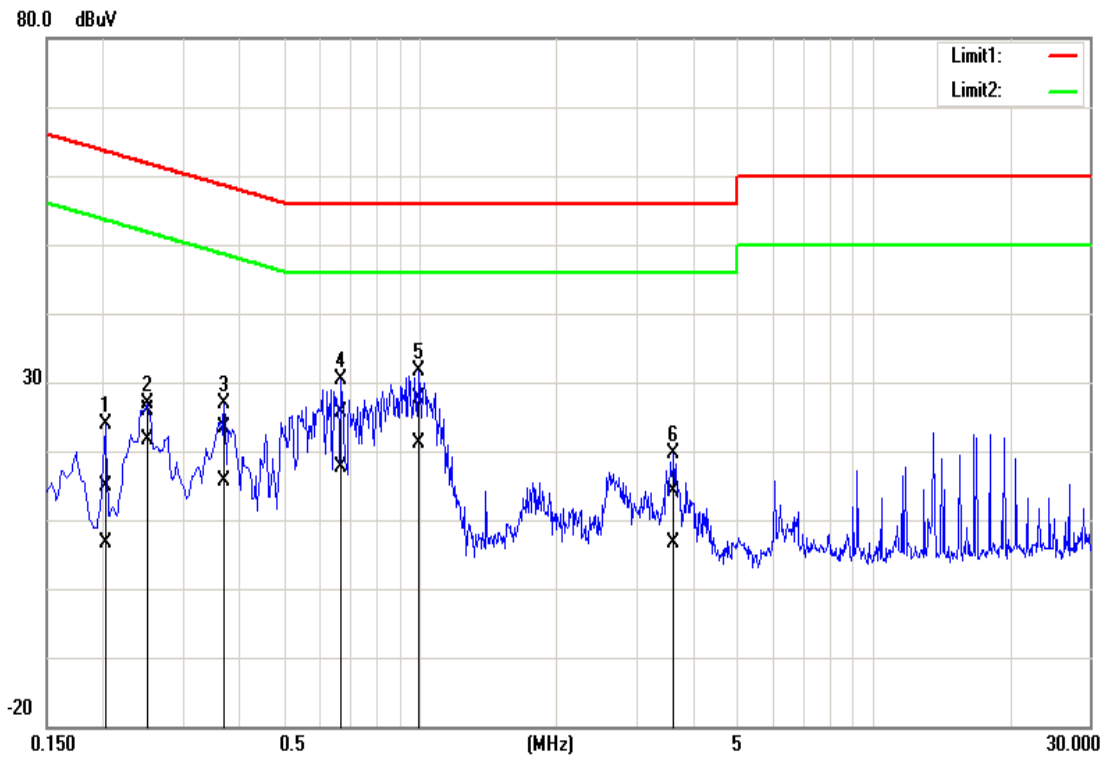



APPENDIX I PHOTOGRAPHS OF TEST SETUP

Conducted Emission Set Up Photo

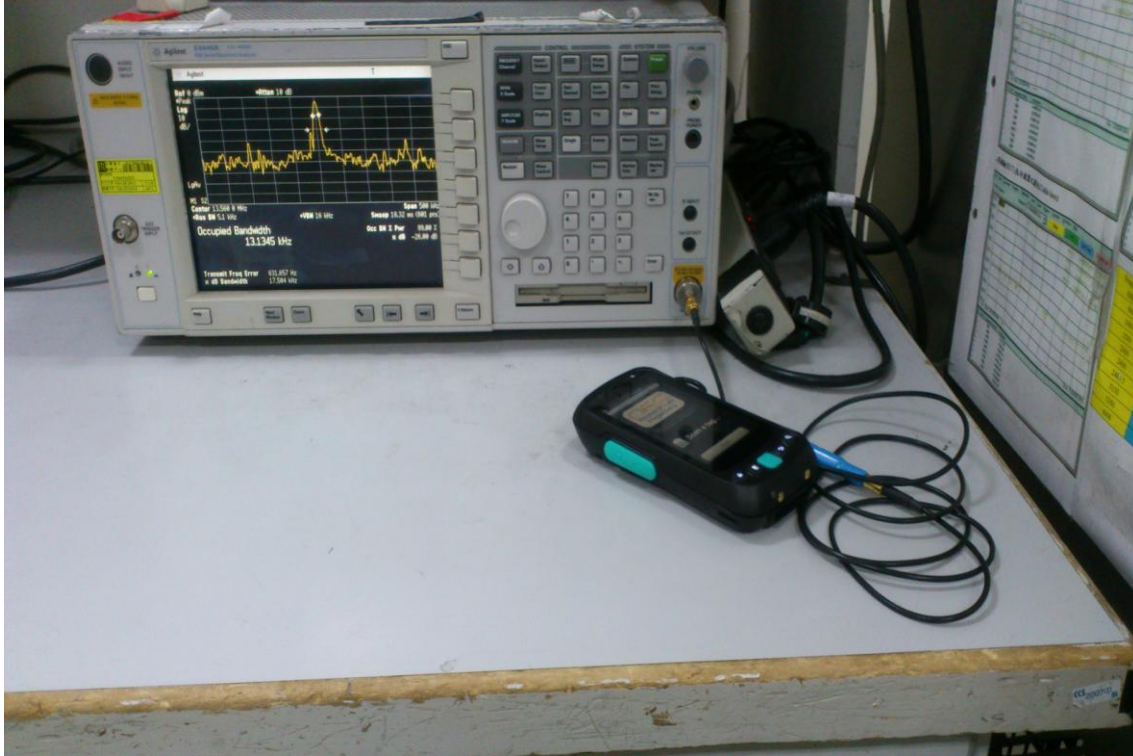



Radiated Emission Set up Photos

9kHz ~ 30MHz

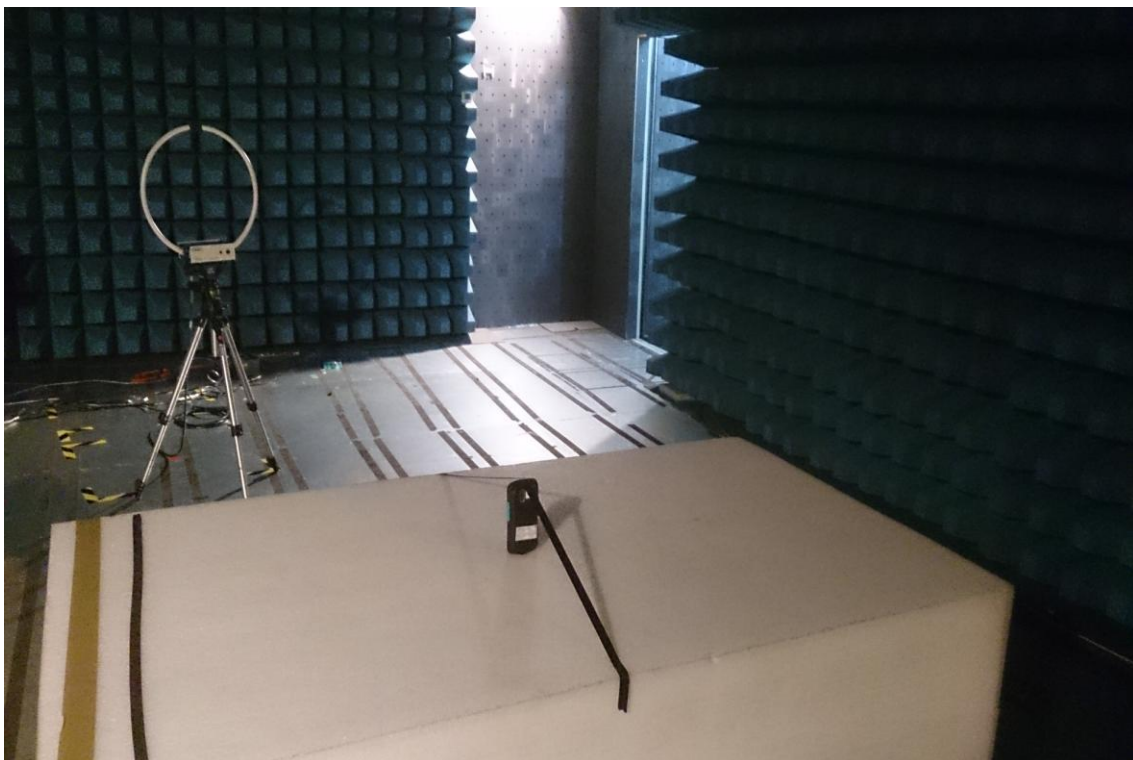
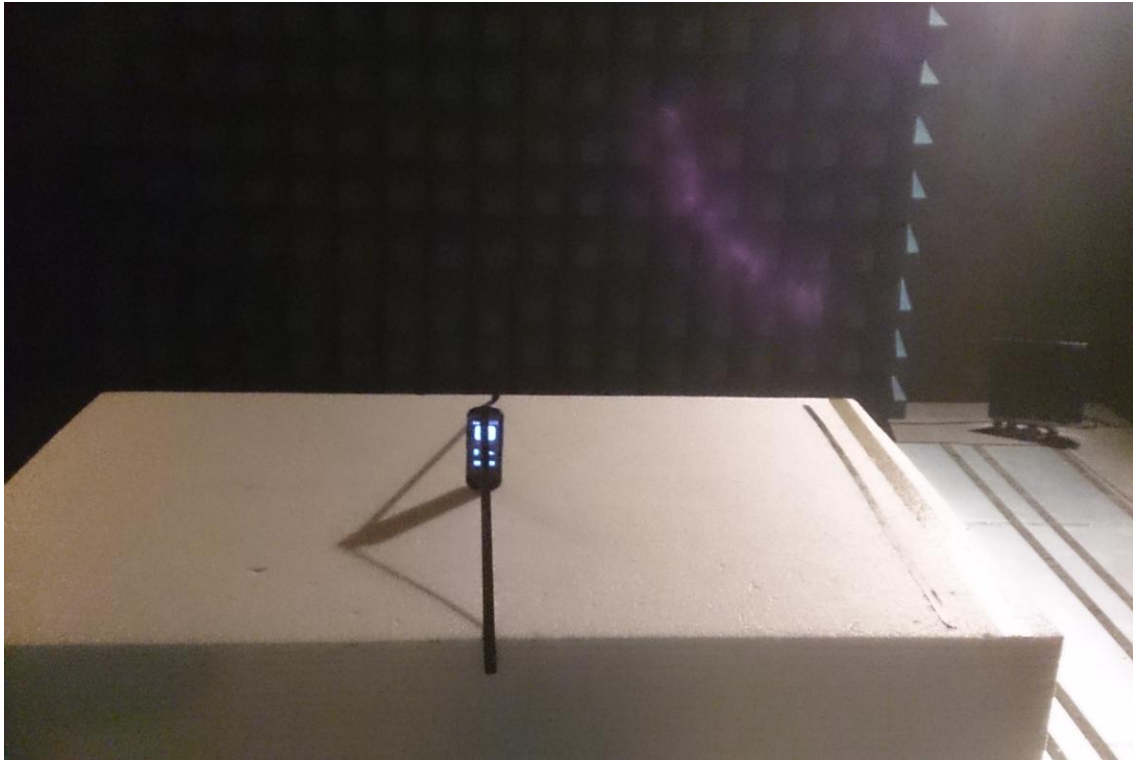



30MHz ~ 1GHz

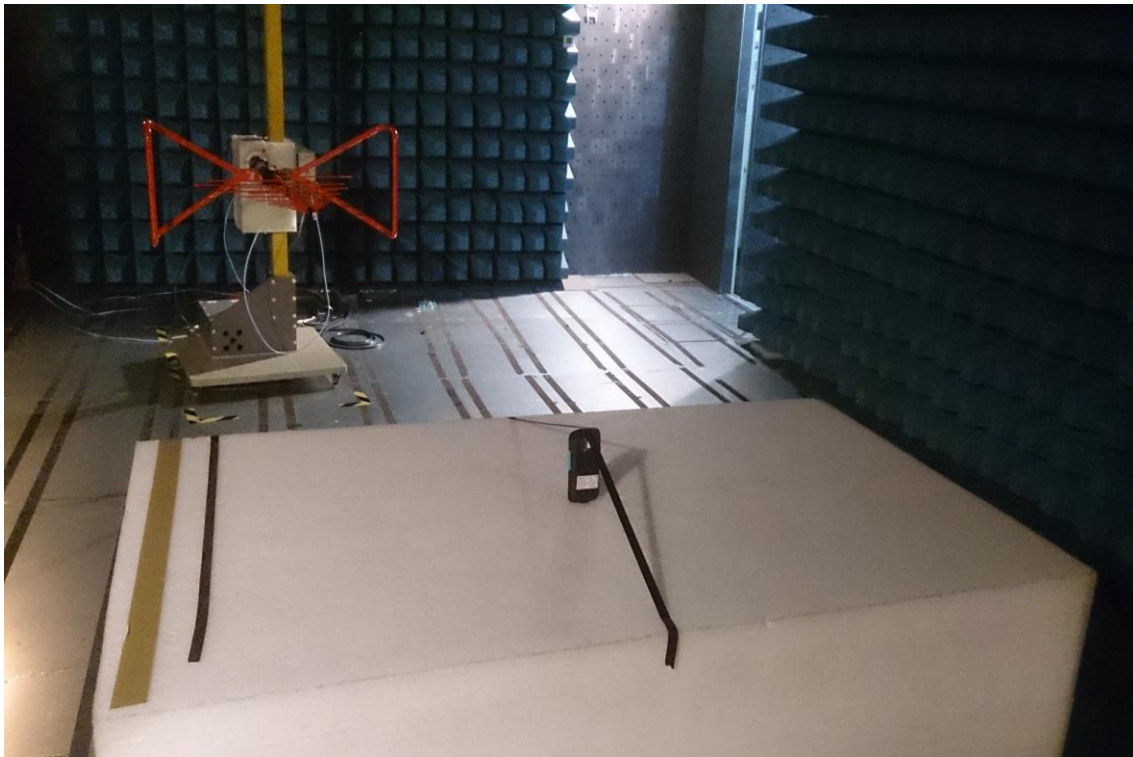
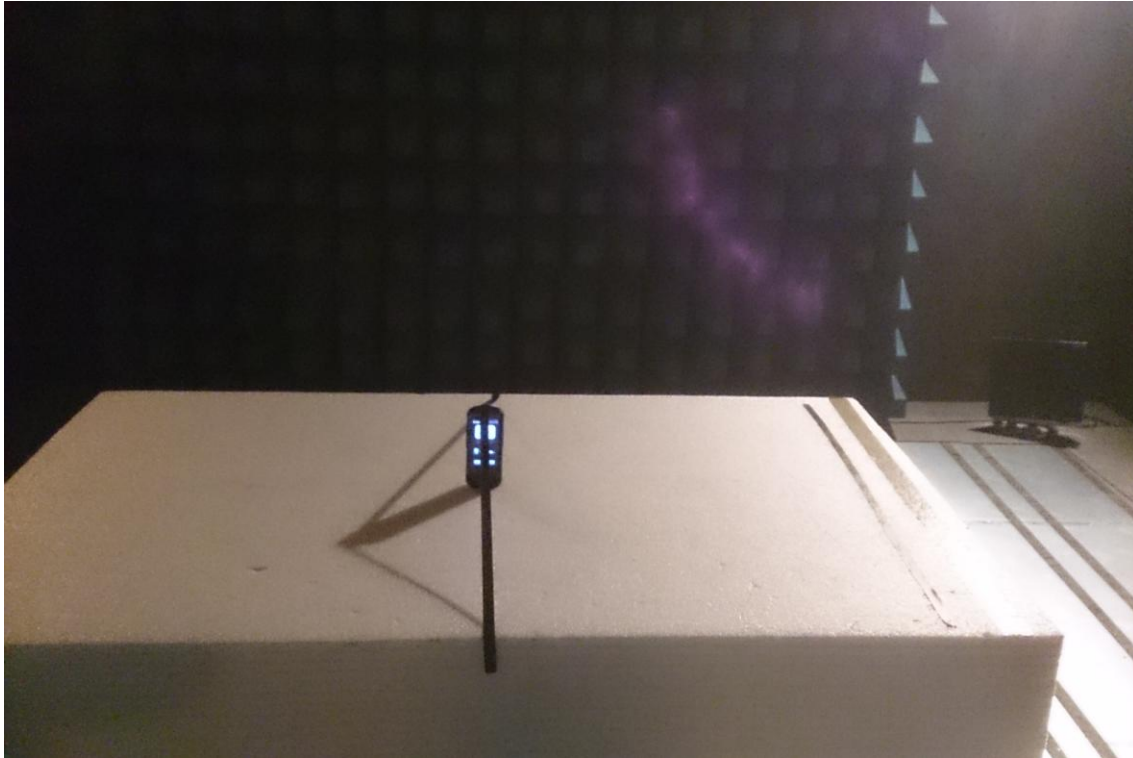



Powerline Conducted Emissions Setup Photos

