

FCC 47 CFR PART 22H and 24E

Product Type : 2G/3.5G Module
Applicant : Telit Communications S.p.A.
Address : Via Stazione di Prosecco, 5/B, Sgonico, TS 34010, Italy
Trade Name : Telit
Model Number : HE910-NAG
Test Specification : FCC 47 CFR PART 22H: Oct, 2011
FCC 47 CFR PART 24E: Oct, 2011
CANADA RSS-132 ISSUE 2: Sep., 2005
CANADA RSS-133 ISSUE 5: Feb., 2009
Canada RSS-Gen ISSUE 3: Dec., 2010
ANSI/TIA-603-C-2004
Application : Original
Purpose:
Receive Date : Apr. 11, 2012
Issue Date : Apr. 13, 2012

Issue by

A Test Lab Techno Corp.
No. 140-1, Changan Street, Bade City,
Taoyuan County 334, Taiwan R.O.C.
Tel : +886-3-2710188 / Fax : +886-3-2710190



Taiwan Accreditation Foundation accreditation number: 1330

Note: This report shall not be reproduced except in full, without the written approval of A Test Lab Techno Corp. This document may be altered or revised by A Test Lab Techno Corp. personnel only, and shall be noted in the revision section of the document. The client should not use it to claim product endorsement by TAF, or any government agencies. The test results in the report only apply to the tested sample.

Revision History

Rev.	Issue Date	Revisions	Revised By
00	Apr. 13, 2012	Initial Issue	

Verification of Compliance

Issued Date: 04/13/2012

Product Type : 2G/3.5G Module
Applicant : Telit Communications S.p.A.
Address : Via Stazione di Prosecco, 5/B, Sgonico, TS 34010, Italy
Trade Name : Telit
Model Number : HE910-NAG
FCC ID : RI7HE910NA
IC ID : 5131A-HE910NA
EUT Rated Voltage : DC 3.8V
Test Voltage : DC 3.8V
Applicable : FCC 47 CFR PART 22H: Oct, 2011
Standard : FCC 47 CFR PART 24E: Oct, 2011
CANADA RSS-132 ISSUE 2: Sep., 2005
CANADA RSS-133 ISSUE 5: Feb., 2009
Canada RSS-Gen ISSUE 3: Dec., 2010
ANSI/TIA-603-C-2004

Application : Original

Purpose

Test Result : Complied

Performing Lab. : A Test Lab Techno Corp.

No. 140-1, Changan Street, Bade City

Taoyuan County 334, Taiwan R.O.C.

Tel : +886-3-2710188 / Fax : +886-3-2710190

Taiwan Accreditation Foundation accreditation number: 1330

<http://www.atl-lab.com.tw/e-index.htm>



The above equipment was tested by A Test Lab Techno Corp. The test data, data evaluation, test procedures, and equipment configurations shown in this report were made in accordance with the procedures given in ANSI C63.4: 2009 and the energy emitted by the sample tested as described in this report is in compliance with the requirements of FCC Rules Part 22H, Part 24E.

The test results of this report relate only to the tested sample identified in this report.

Approved By :



(Manager)

(Murphy Wang)

Reviewed By :

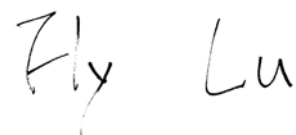

(Testing Engineer)

(Fly Lu)

TABLE OF CONTENTS

1	General Information	6
1.1.	EUT Description	6
1.2.	Mode of Operation.....	7
1.3.	EUT Exercise Software	7
1.4.	Configuration of Test System Details.....	8
1.5.	Test Site Environment.....	8
1.6.	Summary of Test Result	9
2	RF Output Power Test.....	10
2.1.	Limit.....	10
2.2.	Test Instruments	10
2.3.	Test Setup	10
2.4.	Test Procedure	10
2.5.	Uncertainty	11
2.6.	Test Result.....	11
3	Effective Radiated Power / Equivalent Isotropic Radiated Power Test	15
3.1.	Limit.....	15
3.2.	Test Instruments	15
3.3.	Setup	16
3.4.	Test Procedure	17
3.5.	Uncertainty	17
3.6.	Test Result.....	18
4	Occupied Bandwidth Test	21
4.1.	Limit.....	21
4.2.	Test Instruments	21
4.3.	Setup	21
4.4.	Test Procedure	22
4.5.	Uncertainty	22
4.6.	Test Result.....	23
4.7.	Test Graphs	25
5	Conducted Spurious Emission Test.....	35
5.1.	Limit.....	35
5.2.	Test Instruments	35
5.3.	Setup	35
5.4.	Test Procedure	36
5.5.	Uncertainty	36
5.6.	Test Result.....	36

6	Field Strength of Spurious Radiation Test	91
6.1.	Limit	91
6.2.	Test Instruments	91
6.3.	Setup	92
6.4.	Test Procedure	92
6.5.	Uncertainty	93
6.6.	Test Result	94
7	Frequency Stability (Temperature Variation) Test	118
7.1.	Limit	118
7.2.	Test Instruments	118
7.3.	Setup	118
7.4.	Test Procedure	120
7.5.	Uncertainty	120
7.6.	Test Result	121
8	Frequency Stability (Voltage Variation) Test	123
8.1.	Limit	123
8.2.	Test Instruments	123
8.3.	Setup	123
8.4.	Test Procedure	123
8.5.	Uncertainty	124
8.6.	Test Result	124

1 General Information

1.1. EUT Description

Applicant	Telit Communications S.p.A.				
Applicant Address	Via Stazione di Prosecco, 5/B, Sgonico, TS 34010, Italy				
Manufacturer	Telit Communications S.p.A.				
Manufacturer Address	Via Stazione di Prosecco, 5/B, Sgonico, TS 34010, Italy				
Product Type	2G/3.5G Module				
Trade Name	Telit				
Model Number	HE910-NAG				
FCC ID	RI7HE910NA				
IC ID	5131A-HE910NA				
Mode	GSM/GPRS/ EGPRS	Band	UL Frequency (MHz)	DL Frequency (MHz)	Modulation
		850	824.2 ~ 848.8	869.2 ~ 893.8	GMSK/8PSK
		1900	1850.2 ~ 1909.8	1930.2 ~ 1989.8	GMSK/8PSK
	WCDMA/ HSDPA/ HSUPA	Band	UL Frequency (MHz)	DL Frequency (MHz)	Modulation
		II	1852.4 ~ 1907.6	1932.4 ~ 1987.6	QPSK
		V	826.4 ~ 846.6	871.4 ~ 891.6	QPSK
Channel Control	Auto				
Test Used Antenna	Trade Name:Tel Cab, Model Number:T-AT314, Type:Dipole Antenna				
Antenna Gain (dBi)	GSM/GPRS/EGPRS 850 : 5.22 dBi GSM/GPRS/EGPRS 1900 : 3.31 dBi WCDMA/ HSDPA/ HSUPA Band II : 3.31 dBi WCDMA/ HSDPA/ HSUPA Band V : 5.22 dBi				
Max. RF Output power	GSM/GPRS 850 : 32.38 dBm / 1.730 W EGPRS 850 : 29.49 dBm / 0.889 W GSM/GPRS 1900 : 29.21 dBm / 0.834 W EGPRS 1900 : 28.27 dBm / 0.671 W WCDMA/ HSDPA/ HSUPA Band II : 26.44 dBm / 0.441 W WCDMA/ HSDPA/ HSUPA Band V : 26.43 dBm / 0.440 W				
Max. ERP/EIRP	GSM/GPRS 850 : 30.20 dBm / 1.047 W EGPRS 850 : 29.07 dBm / 0.807 W GSM/GPRS 1900 : 26.81 dBm / 0.480 W EGPRS 1900 : 26.20 dBm / 0.417 W WCDMA/ HSDPA/ HSUPA Band II : 24.81 dBm / 0.303 W WCDMA/ HSDPA/ HSUPA Band V : 22.22 dBm / 0.167 W				
Emission Designator	GSM/GPRS 850 : 244KGXW EGPRS 850 : 249KG7W GSM/GPRS 1900 : 247KGXW EGPRS 1900 : 249KG7W WCDMA/ HSDPA/ HSUPA Band II : 4M07F9W WCDMA/ HSDPA/ HSUPA Band V : 4M09F9W				

1.2. Mode of Operation

ATL has verified the construction and function in typical operation. All the test modes were carried out with the EUT in normal operation, which was shown in this test report and defined as:

Test Mode
Mode 1: GSM 850 Link Mode
Mode 2: GSM 1900 Link Mode
Mode 3: GPRS 850 Link Mode
Mode 4: GPRS 1900 Link Mode
Mode 5: EGPRS 850 Link Mode
Mode 6: EGPRS 1900 Link Mode
Mode 7: WCDMA Band II Link Mode
Mode 8: WCDMA Band V Link Mode
Mode 9: Receive Mode

Note: Regards to the frequency band operation: the lowest, middle and highest frequency of channel were selected to perform the test, then shown on this report.

Tested System Details

The types for all equipments, plus descriptions of all cables used in the tested system (including inserted cards) are:

	Product	Manufacturer	Model Number	Serial Number	Power Cord
1.	Universal Radio Communication Tester	R&S	CMU200	109369	N/A

1.3. EUT Exercise Software

1.	Setup the EUT and Base Station (CMU200) as shown on 1.4.
2.	Turn on the power of all equipment.

1.4. Configuration of Test System Details

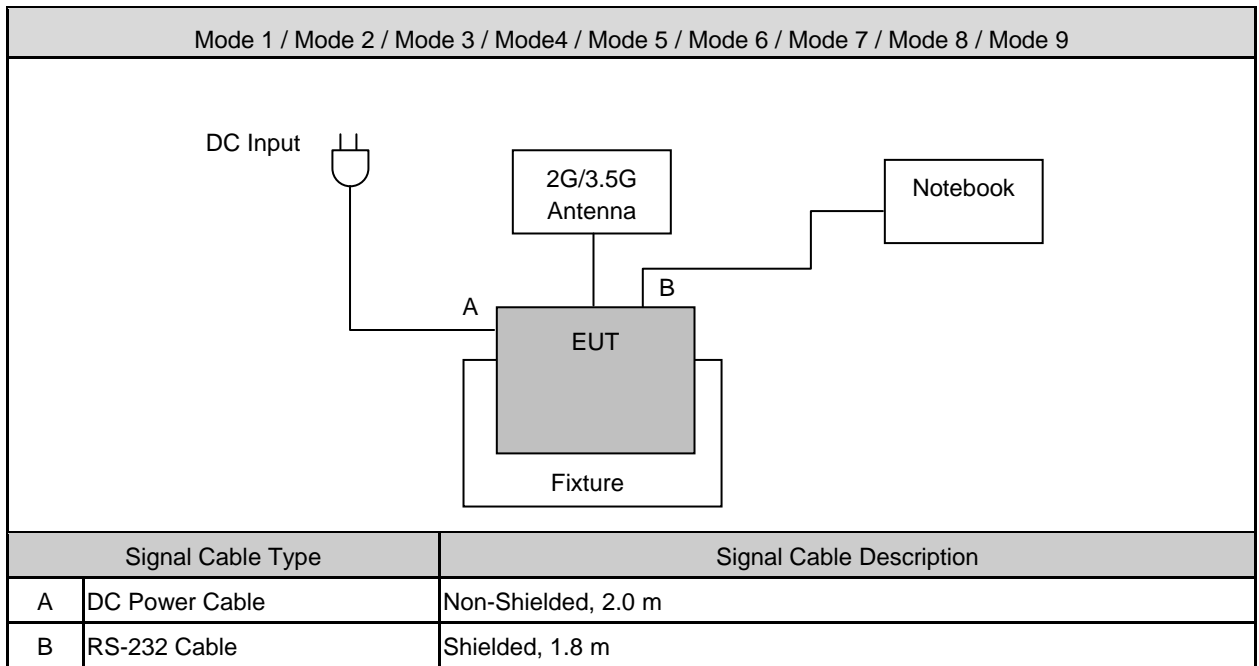

1.5. Test Site Environment

Items	Required (IEC 68-1)	Actual
Temperature (°C)	15-35	23.0
Humidity (%RH)	25-75	55.2
Barometric pressure (mbar)	860-1060	950

1.6. Summary of Test Result

Description	FCC Rule	IC Rule	Limit	Result
Conducted Output Power	§2.1046	N/A	N/A	Pass
Effective Radiated Power	§22.913(a)(2)	RSS-132(4.4) SRSP-503(5.1.3)	< 7 Watts for FCC (<6.3 Watts for IC)	Pass
Equivalent Isotropic Radiated Power	§24.232(c)	RSS-133 (6.4) SRSP-510(5.1.2)	< 2 Watts	Pass
Occupied Bandwidth	§2.1049 §22.917(a) §24.238(a)	RSS-Gen (4.6.1)	N/A	Pass
Band Edge Measurement	§2.1051 §22.917(a) §24.238(a)	RSS-132 (4.5.1)RSS-133 (6.5.1)	< 43+10log ₁₀ (P[Watts])	Pass
Conducted Spurious Emission	§2.1051 §22.917(a) §24.238(a)	RSS-132 (4.5.1) RSS-133 (6.5.1)	< 43+10log ₁₀ (P[Watts])	Pass
Field Strength of Spurious Radiation	§2.1053 §22.917(a) §24.238(a)	RSS-132 (4.5.1) RSS-133 (6.5.1) RSS-Gen (4.10)	< 43+10log ₁₀ (P[Watts])	Pass
Frequency Stability for Temperature & Voltage	§2.1055 §22.355 §24.235	RSS-132(4.3) RSS-133(6.3)	< 2.5 ppm	Pass

2 RF Output Power Test

2.1. Limit

N/A

2.2. Test Instruments

Equipment	Manufacturer	Model Number	Serial Number	Cal. Date	Remark
Universal Radio Communication Tester	ROHDE & SCHWARZ	CMU200	109369	08/10/2010	(2)
Single Channel PK Power Sensor	Agilent	N1911A	MY45101619	07/19/2010	(2)
Wideband Power Meter	Agilent	N1921A	MY45241957	07/19/2010	(2)
Test Site	ATL	TE05	TE05	N.C.R.	-----

Remark: ⁽¹⁾ Calibration period 1 year. ⁽²⁾ Calibration period 2 years.

Note: N.C.R. = No Calibration Request.

2.3. Test Setup

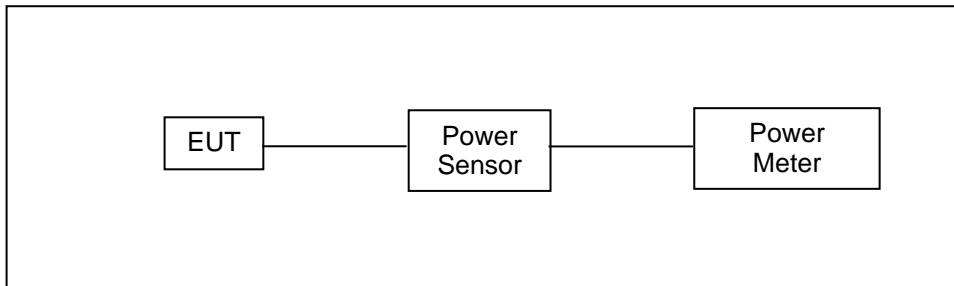

2.4. Test Procedure

The measurement is made according to ANSI/TIA-603-C-2004 as follows:

1. The transmitter output was connected to power meter and base station through power divider.
2. Set base station for EUT at GSM 850: PCL=5 and PCS 1900: PCL=0.
3. Set base station for EUT at WCDMA Band V and WCDMA Band II, power level was set to maximum.
4. Select lowest, middle, and highest channels for each band.

2.5. Uncertainty

The measurement uncertainty is defined as for RF output power measurement is 1.2 dB.

2.6. Test Result

Model Number	HE910-NAG					
Test Item	RF Output Power					
Date of Test	04/11/2012			Test Site	TE05	
Bands	Data Rate	Frequency (MHz)	Burst Average Power		Peak Power	
			(dBm)	(W)	(dBm)	(W)
GSM 850	-----	824.2	32.08	1.614	32.26	1.683
		836.4	32.13	1.633	32.25	1.679
		848.8	32.07	1.611	32.24	1.675
GRRS 850	4Down1Up	824.2	32.17	1.648	32.38	1.730
		836.4	32.15	1.641	32.27	1.687
		848.8	32.10	1.622	32.22	1.667
	3Down2Up	824.2	32.13	1.633	32.25	1.679
		836.4	32.14	1.637	32.25	1.679
		848.8	32.11	1.626	32.24	1.675
	2Down3Up	824.2	31.31	1.352	31.41	1.384
		836.4	31.22	1.324	31.32	1.355
		848.8	31.21	1.321	31.31	1.352
	1Down4Up	824.2	30.13	1.030	30.33	1.079
		836.4	30.11	1.026	30.21	1.050
		848.8	30.09	1.021	30.12	1.028
EGPRS 850	4Down1Up	824.2	26.69	0.467	29.49	0.889
		836.4	26.66	0.463	29.46	0.883
		848.8	26.61	0.458	29.42	0.875
	3Down2Up	824.2	26.58	0.455	29.31	0.853
		836.4	26.56	0.453	29.29	0.849
		848.8	26.47	0.444	29.26	0.843
	2Down3Up	824.2	25.32	0.340	28.82	0.762
		836.4	25.31	0.340	28.81	0.760
		848.8	25.30	0.339	28.80	0.759
	1Down4Up	824.2	24.72	0.296	27.95	0.624
		836.4	24.70	0.295	27.92	0.619
		848.8	24.69	0.294	27.90	0.617

Note: The peak power testing result was used peak detector.

Model Number	HE910-NAG					
Test Item	RF Output Power					
Date of Test	04/11/2012			Test Site	TE05	
Bands	Data Rate	Frequency (MHz)	Burst Average Power		Peak Power	
			(dBm)	(W)	(dBm)	(W)
GSM 1900	-----	1850.20	28.95	0.785	29.12	0.817
		1880.00	28.94	0.783	29.09	0.811
		1909.80	28.93	0.782	29.08	0.809
GRRS 1900	4Down1Up	1850.20	28.99	0.793	29.21	0.834
		1880.00	28.98	0.791	29.20	0.832
		1909.80	28.96	0.787	29.18	0.828
	3Down2Up	1850.20	28.96	0.787	29.16	0.824
		1880.00	28.95	0.785	29.15	0.822
		1909.80	28.94	0.783	29.14	0.820
	2Down3Up	1850.20	28.16	0.655	28.31	0.678
		1880.00	28.15	0.653	28.27	0.671
		1909.80	28.13	0.650	27.25	0.531
	1Down4Up	1850.20	27.06	0.508	27.15	0.519
		1880.00	26.95	0.495	27.13	0.516
		1909.80	26.94	0.494	27.12	0.515
EGPRS 1900	4Down1Up	1850.20	25.32	0.340	28.27	0.671
		1880.00	25.27	0.337	28.23	0.665
		1909.80	25.26	0.336	28.21	0.662
	3Down2Up	1850.20	25.28	0.337	28.22	0.664
		1880.00	25.26	0.336	28.18	0.658
		1909.80	25.23	0.333	28.17	0.656
	2Down3Up	1850.20	24.61	0.289	27.63	0.579
		1880.00	24.57	0.286	27.57	0.571
		1909.80	24.56	0.286	27.53	0.566
	1Down4Up	1850.20	23.45	0.221	26.45	0.442
		1880.00	23.37	0.217	26.41	0.438
		1909.80	23.36	0.217	26.37	0.434

Note: The peak power testing result was used peak detector.

Model Number	HE910-NAG					
Test Item	RF Output Power					
Date of Test	04/11/2012			Test Site	TE05	
Bands	Sub-Test	Frequency (MHz)	Burst Average Power		Peak Power	
			(dBm)	(W)	(dBm)	(W)
WCDMA Band II	-----	1852.4	23.70	0.234	26.44	0.441
		1880.0	23.31	0.214	26.07	0.405
		1907.6	23.37	0.217	26.13	0.410
HSDPA Band II	1	1852.4	23.18	0.208	25.94	0.393
		1880.0	22.79	0.190	25.57	0.361
		1907.6	22.83	0.192	25.63	0.366
	2	1852.4	23.17	0.207	25.93	0.392
		1880.0	22.78	0.190	25.56	0.360
		1907.6	22.82	0.191	25.62	0.365
	3	1852.4	23.18	0.208	25.94	0.393
		1880.0	22.79	0.190	25.57	0.361
		1907.6	22.81	0.191	25.61	0.364
	4	1852.4	23.17	0.207	25.93	0.392
		1880.0	22.78	0.190	25.56	0.360
		1907.6	22.82	0.191	25.62	0.365
HSUPA Band II	1	1852.4	23.16	0.207	25.91	0.390
		1880.0	22.77	0.189	25.54	0.358
		1907.6	22.81	0.191	25.61	0.364
	2	1852.4	21.15	0.130	23.90	0.245
		1880.0	20.76	0.119	23.53	0.225
		1907.6	20.80	0.120	23.60	0.229
	3	1852.4	22.17	0.165	24.92	0.310
		1880.0	21.76	0.150	24.53	0.284
		1907.6	21.82	0.152	24.62	0.290
	4	1852.4	21.15	0.130	23.90	0.245
		1880.0	20.76	0.119	23.53	0.225
		1907.6	20.82	0.121	23.62	0.230
	5	1852.4	23.15	0.207	25.90	0.389
		1880.0	22.76	0.189	25.53	0.357
		1907.6	22.79	0.190	25.59	0.362

Note: The peak power testing result was used peak detector.

Model Number	HE910-NAG					
Test Item	RF Output Power					
Date of Test	04/11/2012			Test Site	TE05	
Bands	Sub-Test	Frequency (MHz)	Burst Average Power		Peak Power	
			(dBm)	(W)	(dBm)	(W)
WCDMA Band V	-----	826.4	23.76	0.238	26.43	0.440
		836.4	23.58	0.228	26.28	0.425
		846.4	23.54	0.226	26.23	0.420
HSDPA Band V	1	826.4	23.05	0.202	26.39	0.436
		836.4	22.94	0.197	26.24	0.421
		846.4	22.81	0.191	26.21	0.418
	2	826.4	23.04	0.201	26.38	0.435
		836.4	22.93	0.196	26.23	0.420
		846.4	22.81	0.191	26.21	0.418
	3	826.4	23.03	0.201	26.37	0.434
		836.4	22.93	0.196	26.23	0.420
		846.4	22.79	0.190	26.19	0.416
	4	826.4	23.02	0.200	26.36	0.433
		836.4	22.91	0.195	26.21	0.418
		846.4	22.78	0.190	26.18	0.415
HSUPA Band V	1	826.4	22.98	0.199	26.32	0.429
		836.4	22.87	0.194	26.22	0.419
		846.4	22.77	0.189	26.17	0.414
	2	826.4	20.97	0.125	24.31	0.270
		836.4	20.86	0.122	24.21	0.264
		846.4	20.76	0.119	24.16	0.261
	3	826.4	21.97	0.157	25.31	0.340
		836.4	21.86	0.153	25.21	0.332
		846.4	21.77	0.150	25.17	0.329
	4	826.4	20.97	0.125	24.31	0.270
		836.4	20.88	0.122	24.23	0.265
		846.4	20.79	0.120	24.19	0.262
	5	826.4	22.97	0.198	26.31	0.428
		836.4	22.87	0.194	26.22	0.419
		846.4	22.76	0.189	26.16	0.413

Note: The peak power testing result was used peak detector.

3 Effective Radiated Power / Equivalent Isotropic Radiated Power Test

3.1. Limit

For FCC Part 22.913(a)(2): The ERP of mobile transmitters and auxiliary test transmitters must not exceed 7 Watts.

For FCC Part 24.232(b): The EIRP of mobile transmitters and auxiliary test transmitters must not exceed 2 Watts.

3.2. Test Instruments

3 Meter Chamber					
Equipment	Manufacturer	Model Number	Serial Number	Cal. Date	Remark
RF Pre-selector	Agilent	N9039A	MY46520256	01/16/2012	(2)
Spectrum Analyzer	Agilent	E4446A	MY46180578	01/16/2012	(1)
Pre Amplifier	Agilent	8449B	3008A02237	02/22/2012	(1)
Pre Amplifier	Agilent	8447D	2944A10961	02/22/2012	(1)
Broadband Antenna (30MHz~1GHz)	SCHWARZBECK MESS-ELEKTRONIK	VULB9163	9163-270	07/29/2011	(1)
Horn Antenna (1~18GHz)	SCHWARZBECK MESS-ELEKTRONIK	BBHA9120D	9120D-550	06/29/2011	(1)
Horn Antenna (18~40GHz)	SCHWARZBECK MESS-ELEKTRONIK	BBHA9170	9170-320	06/28/2011	(1)
Test Site	ATL	TE01	888001	12/20/2011	(1)

Remark: ⁽¹⁾ Calibration period 1 year. ⁽²⁾ Calibration period 2 years.

Note: N.C.R. = No Calibration Request.

3.3. Setup

Below 1 GHz

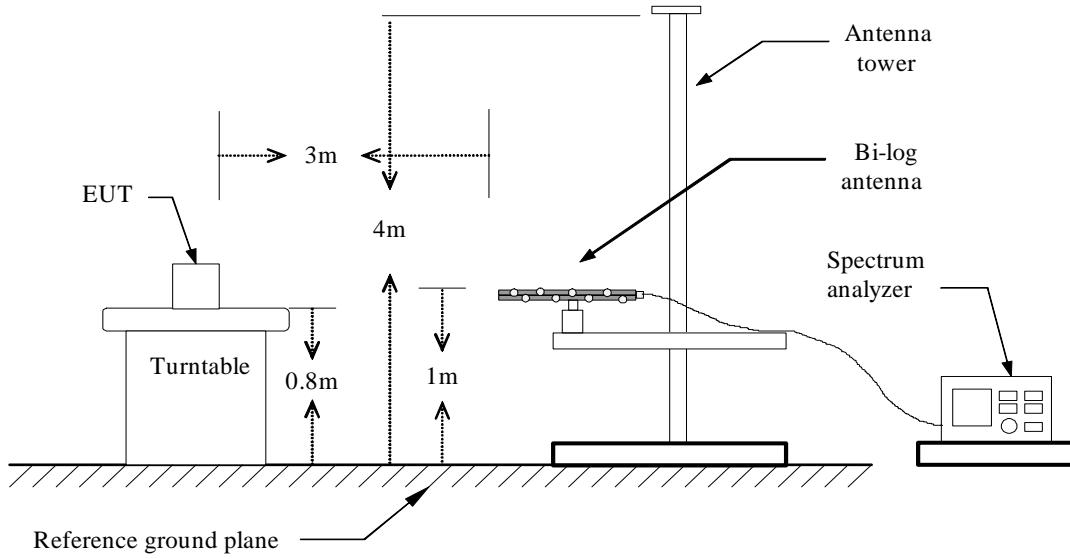

Above 1 GHz

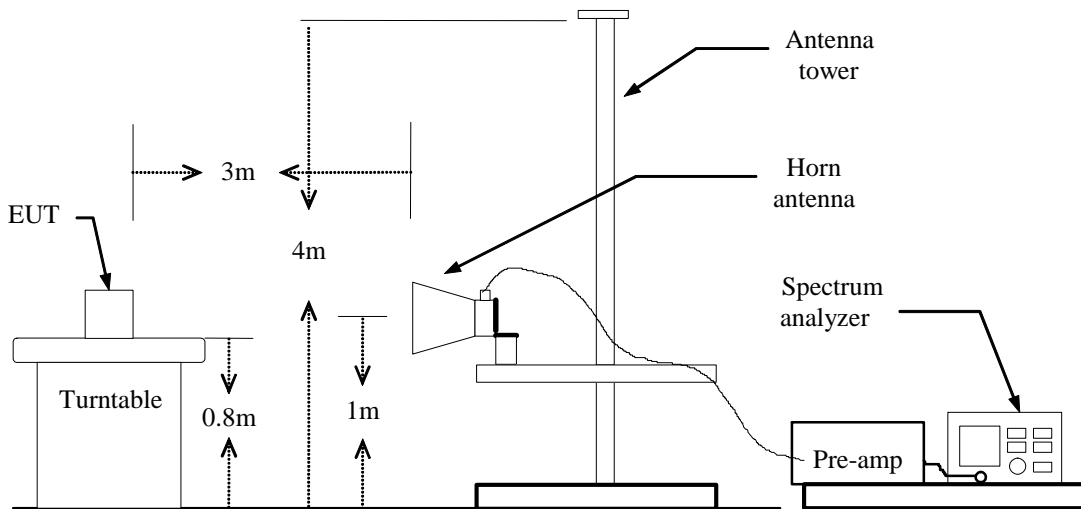

For Substituted Method Test Set-UP

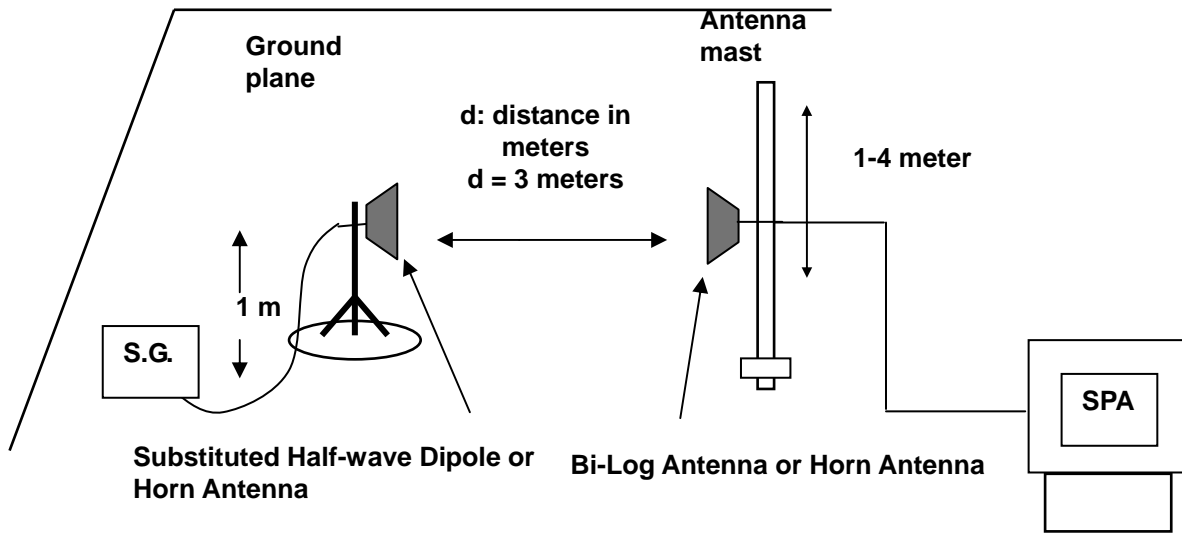

3.4. Test Procedure

The measurement is made according to ANSI/TIA-603-C-2004 as follows:

The EUT was placed on a non-conductive turntable using a non-conductive support. The radiated emission at the fundamental frequency was measured at 3 m with a test antenna and EMI spectrum analyzer.

During the measurement of the EUT, the resolution bandwidth was set to 3MHz and the average bandwidth was set to 3MHz. The highest emission was recorded with the rotation of the turntable and the lowering of the test antenna. The reading was recorded and the field strength (E in dBuV/m) was calculated.

ERP in frequency band 824-849MHz, and EIRP in frequency band 1851.25 –1910MHz were measured using a substitution method. The EUT was replaced by half-wave dipole (824-849MHz) or horn antenna (1851.25-1910MHz) connected to a signal generator. The spectrum analyzer reading was recorded and ERP/EIRP was calculated as follows:

$$\text{ERP} = \text{S.G. output (dBm)} + \text{Antenna Gain (dBd)} - \text{Cable (dB)}$$

$$\text{EIRP} = \text{S.G. output (dBm)} + \text{Antenna Gain (dBi)} - \text{Cable (dB)}$$

3.5. Uncertainty

The measurement uncertainty is defined as for Field Strength of Spurious Radiation measurement is ± 3.072 dB.

3.6. Test Result

Model Number	HE910-NAG						
Test Item	ERP/EIRP						
Date of Test	04/11/2012				Test Site	TE01	
Test Mode	Frequency (MHz)	Ant. Polar.	Read Level (dBm)	Correction factor (dBm)	ERP		Limit
					(dBm)	(W)	
Mode 1	824.2	H	17.62	11.95	29.57	0.906	< 7W
		V	11.34	11.29	22.63	0.183	< 7W
	836.4	H	17.29	12.07	29.36	0.863	< 7W
		V	12.05	11.34	23.39	0.218	< 7W
	848.8	H	15.48	12.50	27.98	0.628	< 7W
		V	11.67	11.47	23.14	0.206	< 7W
Mode 3	824.2	H	18.25	11.95	30.20	1.047	< 7W
		V	11.04	11.29	22.33	0.171	< 7W
	836.4	H	17.31	12.07	29.38	0.867	< 7W
		V	12.08	11.34	23.42	0.220	< 7W
	848.8	H	15.44	12.51	27.95	0.624	< 7W
		V	11.76	11.47	23.23	0.210	< 7W
Mode 5	824.2	H	17.78	11.29	29.07	0.807	< 7W
		V	11.44	11.29	22.73	0.187	< 7W
	836.4	H	16.48	12.07	28.55	0.716	< 7W
		V	10.48	11.34	21.82	0.152	< 7W
	848.8	H	13.72	12.51	26.23	0.420	< 7W
		V	12.64	11.47	24.11	0.258	< 7W

Note: 1. ERP/EIRP = Read Level + Correction factor.

2. For WCDMA signals, a peak detector is used with RBW = VBW = 5MHz.

3. For AMPS, GSM, and NADC TDMA signals, a peak detector is used, with RBW = VBW= 1 MHz.

Model Number	HE910-NAG						
Test Item	ERP/EIRP						
Date of Test	04/11/2012				Test Site	TE01	
Test Mode	Frequency (MHz)	Ant. Polar.	Read Level (dBm)	Correction factor (dBm)	EIRP		Limit
					(dBm)	(W)	
Mode 2	1850.20	H	15.67	10.49	26.16	0.413	< 2W
		V	17.75	8.33	26.08	0.406	< 2W
	1880.00	H	15.82	10.51	26.33	0.430	< 2W
		V	17.60	8.57	26.17	0.414	< 2W
	1909.80	H	16.27	10.52	26.79	0.478	< 2W
		V	17.37	8.80	26.17	0.414	< 2W
Mode 4	1850.20	H	15.81	10.49	26.30	0.427	< 2W
		V	17.69	8.33	26.02	0.400	< 2W
	1880.00	H	15.72	10.51	26.23	0.420	< 2W
		V	17.61	8.57	26.18	0.415	< 2W
	1909.80	H	16.30	10.51	26.81	0.480	< 2W
		V	17.36	8.80	26.16	0.413	< 2W
Mode 6	1850.20	H	15.09	10.49	25.58	0.361	< 2W
		V	17.48	8.33	25.81	0.381	< 2W
	1880.00	H	15.69	10.51	26.20	0.417	< 2W
		V	17.28	8.57	25.85	0.385	< 2W
	1909.80	H	15.43	10.52	25.95	0.394	< 2W
		V	16.99	8.81	25.80	0.380	< 2W

Note: 1. ERP/EIRP = Read Level + Correction factor.

2. For WCDMA signals, a peak detector is used with RBW = VBW = 5MHz.

3. For AMPS, GSM, and NADC TDMA signals, a peak detector is used, with RBW = VBW= 1 MHz.

Model Number	HE910-NAG						
Test Item	ERP/EIRP						
Date of Test	04/11/2012				Test Site	TE01	
Test Mode	Frequency (MHz)	Ant. Polar.	Read Level (dBm)	Correction factor (dBm)	EIRP		Limit
					(dBm)	(W)	
Mode 7	1852.4	H	12.45	10.50	22.95	0.197	< 2W
		V	16.45	8.36	24.81	0.303	< 2W
	1880.0	H	12.27	10.52	22.79	0.190	< 2W
		V	15.65	8.57	24.22	0.264	< 2W
	1907.6	H	12.57	10.52	23.09	0.204	< 2W
		V	15.04	8.78	23.82	0.241	< 2W

Model Number	HE910-NAG						
Test Item	ERP/EIRP						
Date of Test	04/11/2012				Test Site	TE01	
Test Mode	Frequency (MHz)	Ant. Polar.	Read Level (dBm)	Correction factor (dBm)	ERP		Limit
					(dBm)	(W)	
Mode 8	826.4	H	10.23	11.99	22.22	0.167	< 7W
		V	7.02	11.31	18.33	0.068	< 7W
	836.4	H	9.76	12.07	21.83	0.152	< 7W
		V	6.36	11.34	17.70	0.059	< 7W
	846.4	H	8.59	12.39	20.98	0.125	< 7W
		V	6.02	11.42	17.44	0.055	< 7W

Note: 1. ERP/EIRP = Read Level + Correction factor.

2. For WCDMA signals, a peak detector is used with RBW = VBW = 5MHz.

3. For AMPS, GSM, and NADC TDMA signals, a peak detector is used, with RBW = VBW= 1 MHz.

4 Occupied Bandwidth Test

4.1. Limit

The Occupied Bandwidth Limit:

N/A.

The Band Edge Limit:

The power of any emission outside of the authorized operating frequency ranges must be attenuated below the transmitting power (P) by a factor of at least $43 + 10\log(P)$ dB.

4.2. Test Instruments

Equipment	Manufacturer	Model Number	Serial Number	Cal. Date	Remark
Spectrum Analyzer	Agilent	E4445A	MY46181986	05/16/2011	(2)
Universal Radio Communication Tester	ROHDE & SCHWARZ	CMU200	109369	08/10/2010	(2)
Attenuator	RADIALL	R41572000	0603033073	N.C.R.	-----
Power divider	Agilent	87302C	3239A00760	N.C.R.	-----
Test Site	ATL	TE05	TE05	N.C.R.	-----

Remark: ⁽¹⁾ Calibration period 1 year. ⁽²⁾ Calibration period 2 years.

Note: N.C.R. = No Calibration Request.

4.3. Setup

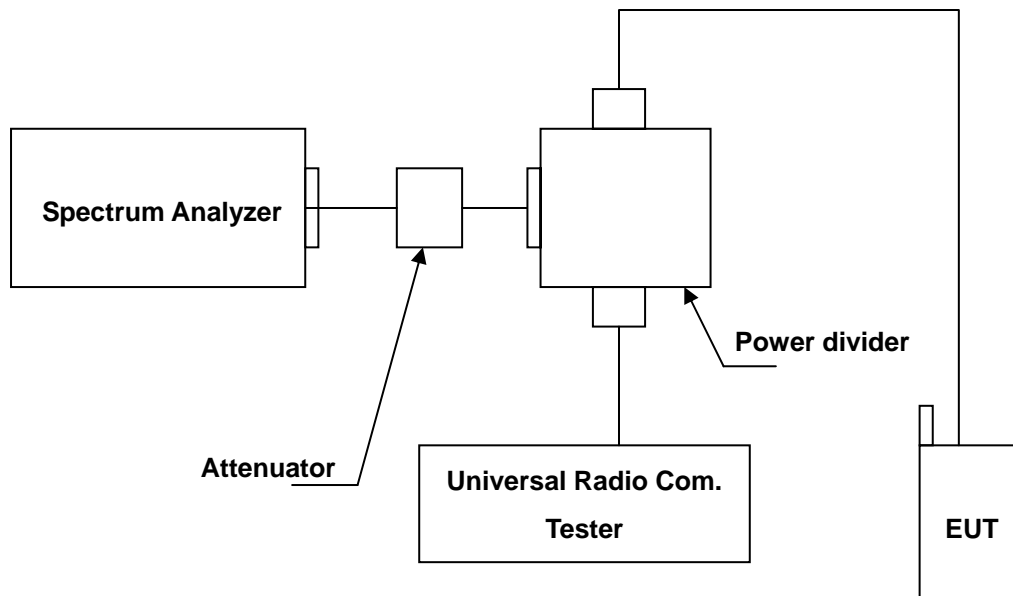

4.4. Test Procedure

The measurement is made according to FCC rules part 22 and 24:

1. The EUT was connected to Spectrum Analyzer and Base Station via power divider.
2. The occupied bandwidth of middle channel for the highest and lowest RF powers was measured.
3. The band edge of low and high channels for the highest RF powers within the transmitting frequency band were measured. Setting RBW as roughly BW/100.
4. The band edge setting:
 - a. RB=10 kHz; VB=30 kHz for GSM 850 and PCS 1900.
 - b. RB=100 kHz; VB=300 kHz for WCDMA Band V and WCDMA Band II.

4.5. Uncertainty

The measurement uncertainty is defined as $\pm 10\text{Hz}$

4.6. Test Result

Model Number	HE910-NAG				
Test Item	Occupied Bandwidth				
Date of Test	04/11/2012			Test Site	TE05
Test Mode	Channel	Frequency (MHz)	99% Bandwidth (kHz)	Note	
Mode 1	128	824.2	241.1707	RBW:10KHz , VBW:30KHz	
	190	836.4	243.4871	RBW:10KHz , VBW:30KHz	
	251	848.8	243.6843	RBW:10KHz , VBW:30KHz	
Mode 2	512	1850.20	242.9443	RBW:10KHz , VBW:30KHz	
	661	1880.00	246.8426	RBW:10KHz , VBW:30KHz	
	810	1909.80	240.7695	RBW:10KHz , VBW:30KHz	
Mode 5	128	824.2	248.7750	RBW:10KHz , VBW:30KHz	
	190	836.4	248.7293	RBW:10KHz , VBW:30KHz	
	251	848.8	252.8001	RBW:10KHz , VBW:30KHz	
Mode 6	512	1850.20	248.4062	RBW:10KHz , VBW:30KHz	
	661	1880.00	247.2272	RBW:10KHz , VBW:30KHz	
	810	1909.80	249.3242	RBW:10KHz , VBW:30KHz	

Model Number	HE910-NAG				
Test Item	Occupied Bandwidth				
Date of Test	04/11/2012			Test Site	TE05
Test Mode	Channel	Frequency (MHz)	99% Bandwidth (MHz)	Note	
Mode 7	9262	1852.4	4.0734	RBW:100KHz , VBW:300KHz	
	9400	1880.0	4.0698	RBW:100KHz , VBW:300KHz	
	9538	1907.6	4.0662	RBW:100KHz , VBW:300KHz	
Mode 8	4132	826.4	4.0850	RBW:100KHz , VBW:300KHz	
	4183	836.4	4.0816	RBW:100KHz , VBW:300KHz	
	4233	846.4	4.0774	RBW:100KHz , VBW:300KHz	

Model Number	HE910-NAG					
Test Item	Band Edge					
Date of Test	04/11/2012			Test Site	TE05	
Test Mode	Band	Channel	Frequency (MHz)	Bandwidth (dBm)	Limit (dBm)	Result
Mode 1	Lower	128	824.0000	-18.21	-13	Pass
	Higher	251	849.0000	-19.25	-13	Pass
Mode 2	Lower	512	1850.000	-27.76	-13	Pass
	Higher	810	1910.000	-30.35	-13	Pass
Mode 7	Lower	9262	1850.000	-28.16	-13	Pass
	Higher	9538	1910.000	-28.07	-13	Pass
Mode 8	Lower	4132	824.0000	-16.88	-13	Pass
	Higher	4233	849.0000	-17.70	-13	Pass

4.7. Test Graphs

Occupied Bandwidth _ Mode 1	
CH 128	
CH 190	
CH 251	

Occupied Bandwidth _ Mode 2	
CH 512	<p>Agilent R T Freq/Channel</p> <p>Ch Freq 1.8502 GHz Trig Free</p> <p>Center Freq 1.85020000 GHz</p> <p>Start Freq 1.84970000 GHz</p> <p>Stop Freq 1.85070000 GHz</p> <p>CF Step 100.000000 kHz Auto Man</p> <p>Freq Offset 0.00000000 Hz</p> <p>Signal Track On Off</p> <p>Ref 40 dBm Atten 40 dB</p> <p>#Samp 10</p> <p>Log dB/Offst 12 dB</p> <p>Center 1.850 200 GHz Span 1 MHz</p> <p>#Res BW 10 kHz #VBW 30 kHz Sweep 30.24 ms (601 pts)</p> <p>Occupied Bandwidth 242.9443 kHz</p> <p>Occ BW % Pwr 99.00 % x dB -26.00 dB</p> <p>Transmit Freq Error 1.468 kHz</p> <p>x dB Bandwidth 321.768 kHz*</p> <p>Copyright 2000-2005 Agilent Technologies</p>
CH 661	<p>Agilent R L Freq/Channel</p> <p>Ch Freq 1.88 GHz Trig Free</p> <p>Center Freq 1.88000000 GHz</p> <p>Start Freq 1.87950000 GHz</p> <p>Stop Freq 1.88050000 GHz</p> <p>CF Step 100.000000 kHz Auto Man</p> <p>Freq Offset 0.00000000 Hz</p> <p>Signal Track On Off</p> <p>Ref 40 dBm Atten 40 dB</p> <p>#Samp 10</p> <p>Log dB/Offst 12 dB</p> <p>Center 1.880 000 GHz Span 1 MHz</p> <p>#Res BW 10 kHz #VBW 30 kHz Sweep 30.24 ms (601 pts)</p> <p>Occupied Bandwidth 246.8426 kHz</p> <p>Occ BW % Pwr 99.00 % x dB -26.00 dB</p> <p>Transmit Freq Error -833.404 Hz</p> <p>x dB Bandwidth 314.734 kHz*</p> <p>Copyright 2000-2005 Agilent Technologies</p>
CH 810	<p>Agilent R T Freq/Channel</p> <p>Ch Freq 1.9098 GHz Trig Free</p> <p>Center Freq 1.90980000 GHz</p> <p>Start Freq 1.90930000 GHz</p> <p>Stop Freq 1.91030000 GHz</p> <p>CF Step 100.000000 kHz Auto Man</p> <p>Freq Offset 0.00000000 Hz</p> <p>Signal Track On Off</p> <p>Ref 40 dBm Atten 40 dB</p> <p>#Samp 10</p> <p>Log dB/Offst 12 dB</p> <p>Center 1.909 800 GHz Span 1 MHz</p> <p>#Res BW 10 kHz #VBW 30 kHz Sweep 30.24 ms (601 pts)</p> <p>Occupied Bandwidth 240.7695 kHz</p> <p>Occ BW % Pwr 99.00 % x dB -26.00 dB</p> <p>Transmit Freq Error 897.761 Hz</p> <p>x dB Bandwidth 309.729 kHz*</p> <p>Copyright 2000-2005 Agilent Technologies</p>

Occupied Bandwidth _ Mode 5	
CH 128	<p>Agilent R T Freq/Channel</p> <p>Ch Freq 824.2 MHz Trig Free</p> <p>Center Freq 824.200000 MHz</p> <p>Start Freq 823.700000 MHz</p> <p>Stop Freq 824.700000 MHz</p> <p>CF Step 100.000000 kHz Auto Man</p> <p>Freq Offset 0.00000000 Hz</p> <p>Signal Track On Off</p> <p>Ref 40 dBm Atten 40 dB</p> <p>#Samp 10</p> <p>Log dB/Offst 12 dB</p> <p>Center 824.200 MHz Span 1 MHz</p> <p>#Res BW 10 kHz #VBW 30 kHz Sweep 30.24 ms (601 pts)</p> <p>Occupied Bandwidth 248.7750 kHz</p> <p>Occ BW % Pwr 99.00 % x dB -26.00 dB</p> <p>Transmit Freq Error 1.884 kHz</p> <p>x dB Bandwidth 323.264 kHz*</p> <p>Copyright 2000-2005 Agilent Technologies</p>
CH 190	<p>Agilent R T Freq/Channel</p> <p>Ch Freq 836.6 MHz Trig Free</p> <p>Center Freq 836.600000 MHz</p> <p>Start Freq 836.100000 MHz</p> <p>Stop Freq 837.100000 MHz</p> <p>CF Step 100.000000 kHz Auto Man</p> <p>Freq Offset 0.00000000 Hz</p> <p>Signal Track On Off</p> <p>Ref 40 dBm Atten 40 dB</p> <p>#Samp 10</p> <p>Log dB/Offst 12 dB</p> <p>Center 836.600 MHz Span 1 MHz</p> <p>#Res BW 10 kHz #VBW 30 kHz Sweep 30.24 ms (601 pts)</p> <p>Occupied Bandwidth 248.7293 kHz</p> <p>Occ BW % Pwr 99.00 % x dB -26.00 dB</p> <p>Transmit Freq Error 1.295 kHz</p> <p>x dB Bandwidth 315.624 kHz*</p> <p>Copyright 2000-2005 Agilent Technologies</p>
CH 251	<p>Agilent R T Freq/Channel</p> <p>Ch Freq 848.8 MHz Trig Free</p> <p>Center Freq 848.800000 MHz</p> <p>Start Freq 848.300000 MHz</p> <p>Stop Freq 849.300000 MHz</p> <p>CF Step 100.000000 kHz Auto Man</p> <p>Freq Offset 0.00000000 Hz</p> <p>Signal Track On Off</p> <p>Ref 40 dBm Atten 40 dB</p> <p>#Samp 10</p> <p>Log dB/Offst 12 dB</p> <p>Center 848.800 MHz Span 1 MHz</p> <p>#Res BW 10 kHz #VBW 30 kHz Sweep 30.24 ms (601 pts)</p> <p>Occupied Bandwidth 252.8001 kHz</p> <p>Occ BW % Pwr 99.00 % x dB -26.00 dB</p> <p>Transmit Freq Error -812.201 Hz</p> <p>x dB Bandwidth 322.870 kHz*</p> <p>Copyright 2000-2005 Agilent Technologies</p>

Occupied Bandwidth _ Mode 6	
CH 512	<p>Agilent R T Freq/Channel</p> <p>Ch Freq 1.8502 GHz Trig Free</p> <p>Center Freq 1.85020000 GHz</p> <p>Start Freq 1.84970000 GHz</p> <p>Stop Freq 1.85070000 GHz</p> <p>CF Step 100.000000 kHz Auto Man</p> <p>Freq Offset 0.00000000 Hz</p> <p>Signal Track On Off</p> <p>Ref 40 dBm Atten 40 dB</p> <p>#Samp 10</p> <p>Log dB/Offst 12 dB</p> <p>Center 1.850 200 GHz Span 1 MHz</p> <p>#Res BW 10 kHz #VBW 30 kHz Sweep 30.24 ms (601 pts)</p> <p>Occupied Bandwidth 248.4062 kHz</p> <p>Occ BW % Pwr 99.00 % x dB -26.00 dB</p> <p>Transmit Freq Error 1.229 kHz</p> <p>x dB Bandwidth 314.871 kHz*</p> <p>Copyright 2000-2005 Agilent Technologies</p>
CH 661	<p>Agilent R T Freq/Channel</p> <p>Ch Freq 1.88 GHz Trig Free</p> <p>Center Freq 1.88000000 GHz</p> <p>Start Freq 1.87950000 GHz</p> <p>Stop Freq 1.88050000 GHz</p> <p>CF Step 100.000000 kHz Auto Man</p> <p>Freq Offset 0.00000000 Hz</p> <p>Signal Track On Off</p> <p>Ref 40 dBm Atten 40 dB</p> <p>#Samp 10</p> <p>Log dB/Offst 12 dB</p> <p>Center 1.880 000 GHz Span 1 MHz</p> <p>#Res BW 10 kHz #VBW 30 kHz Sweep 30.24 ms (601 pts)</p> <p>Occupied Bandwidth 247.2272 kHz</p> <p>Occ BW % Pwr 99.00 % x dB -26.00 dB</p> <p>Transmit Freq Error -324.959 Hz</p> <p>x dB Bandwidth 308.407 kHz*</p> <p>Copyright 2000-2005 Agilent Technologies</p>
CH 810	<p>Agilent R T Freq/Channel</p> <p>Ch Freq 1.9098 GHz Trig Free</p> <p>Center Freq 1.90980000 GHz</p> <p>Start Freq 1.90930000 GHz</p> <p>Stop Freq 1.91030000 GHz</p> <p>CF Step 100.000000 kHz Auto Man</p> <p>Freq Offset 0.00000000 Hz</p> <p>Signal Track On Off</p> <p>Ref 40 dBm Atten 40 dB</p> <p>#Samp 10</p> <p>Log dB/Offst 12 dB</p> <p>Center 1.909 800 GHz Span 1 MHz</p> <p>#Res BW 10 kHz #VBW 30 kHz Sweep 30.24 ms (601 pts)</p> <p>Occupied Bandwidth 249.3242 kHz</p> <p>Occ BW % Pwr 99.00 % x dB -26.00 dB</p> <p>Transmit Freq Error 412.533 Hz</p> <p>x dB Bandwidth 318.558 kHz*</p> <p>Copyright 2000-2005 Agilent Technologies</p>

Occupied Bandwidth _ Mode 7	
CH 9262	<p>Agilent R T Freq/Channel</p> <p>Ch Freq 1.8524 GHz Trig Free</p> <p>Center Freq 1.85240000 GHz</p> <p>Start Freq 1.84740000 GHz</p> <p>Stop Freq 1.85740000 GHz</p> <p>CF Step 1.00000000 MHz Auto Man</p> <p>Freq Offset 0.00000000 Hz</p> <p>Signal Track On Off</p> <p>Ref 40 dBm Atten 40 dB</p> <p>#Samp 10</p> <p>Log dB/Offst 12 dB</p> <p>Center 1.852 40 GHz Span 10 MHz</p> <p>#Res BW 100 kHz *VBW 300 kHz Sweep 3.04 ms (601 pts)</p> <p>Occupied Bandwidth 4.0734 MHz</p> <p>Occ BW % Pwr 99.00 % x dB -26.00 dB</p> <p>Transmit Freq Error -1.072 kHz</p> <p>x dB Bandwidth 4.639 MHz*</p> <p>Copyright 2000-2005 Agilent Technologies</p>
CH 9400	<p>Agilent R T Freq/Channel</p> <p>Ch Freq 1.88 GHz Trig Free</p> <p>Center Freq 1.88000000 GHz</p> <p>Start Freq 1.87500000 GHz</p> <p>Stop Freq 1.88500000 GHz</p> <p>CF Step 1.00000000 MHz Auto Man</p> <p>Freq Offset 0.00000000 Hz</p> <p>Signal Track On Off</p> <p>Ref 40 dBm Atten 40 dB</p> <p>#Samp 10</p> <p>Log dB/Offst 12 dB</p> <p>Center 1.880 00 GHz Span 10 MHz</p> <p>#Res BW 100 kHz *VBW 300 kHz Sweep 3.04 ms (601 pts)</p> <p>Occupied Bandwidth 4.0698 MHz</p> <p>Occ BW % Pwr 99.00 % x dB -26.00 dB</p> <p>Transmit Freq Error 67.192 Hz</p> <p>x dB Bandwidth 4.631 MHz*</p> <p>Copyright 2000-2005 Agilent Technologies</p>
CH 9538	<p>Agilent R T Freq/Channel</p> <p>Ch Freq 1.9076 GHz Trig Free</p> <p>Center Freq 1.90760000 GHz</p> <p>Start Freq 1.90260000 GHz</p> <p>Stop Freq 1.91260000 GHz</p> <p>CF Step 1.00000000 MHz Auto Man</p> <p>Freq Offset 0.00000000 Hz</p> <p>Signal Track On Off</p> <p>Ref 40 dBm Atten 40 dB</p> <p>#Samp 10</p> <p>Log dB/Offst 12 dB</p> <p>Center 1.907 60 GHz Span 10 MHz</p> <p>#Res BW 100 kHz *VBW 300 kHz Sweep 3.04 ms (601 pts)</p> <p>Occupied Bandwidth 4.0662 MHz</p> <p>Occ BW % Pwr 99.00 % x dB -26.00 dB</p> <p>Transmit Freq Error -12.791 kHz</p> <p>x dB Bandwidth 4.632 MHz*</p> <p>Copyright 2000-2005 Agilent Technologies</p>

Occupied Bandwidth _ Mode 8

<p>CH 4132</p>	
<p>CH 4183</p>	
<p>CH 4233</p>	

Band Edge _ Mode 1

Lower Band

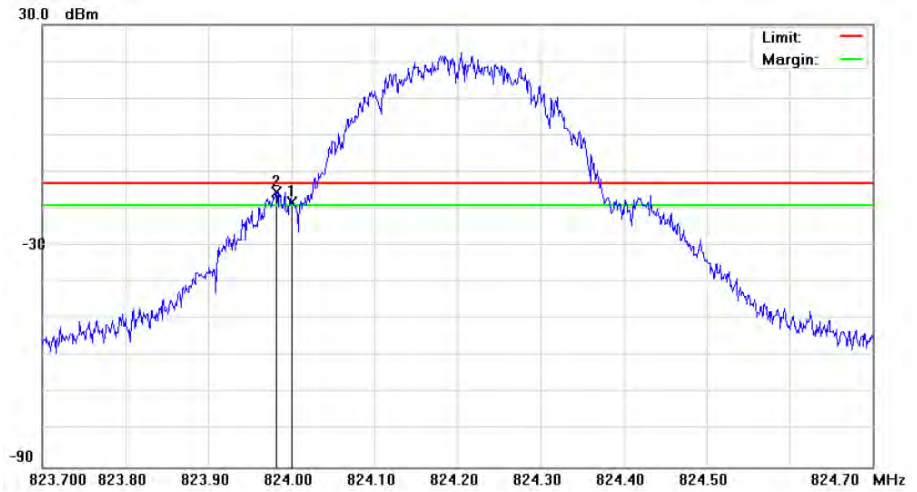

Higher Band

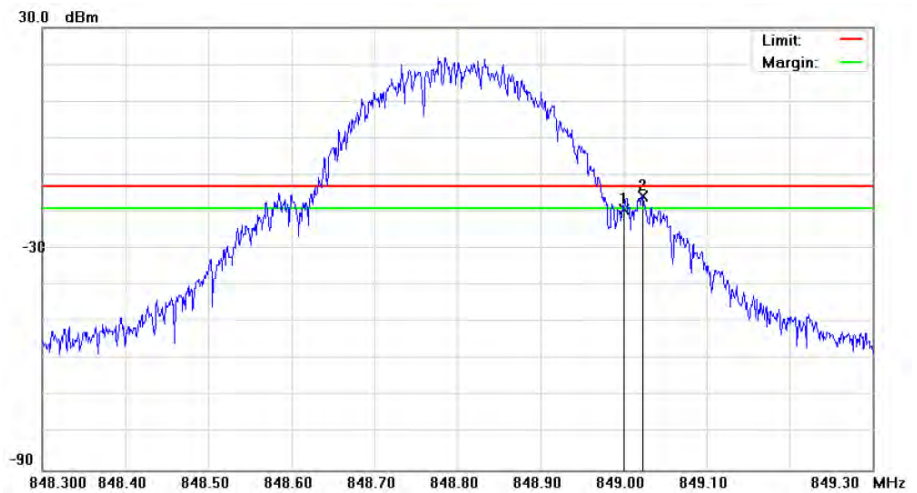

Band Edge _ Mode 2

Lower Band

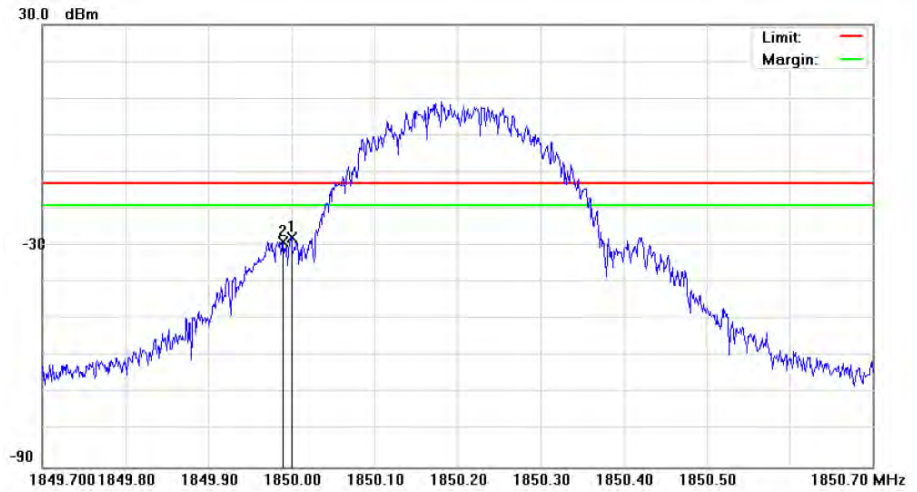

Higher Band

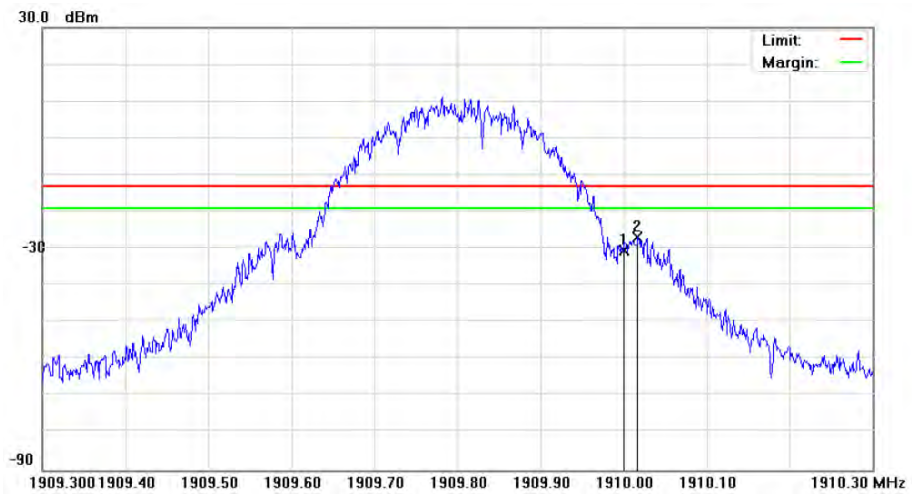

Band Edge _ Mode 7

Lower Band

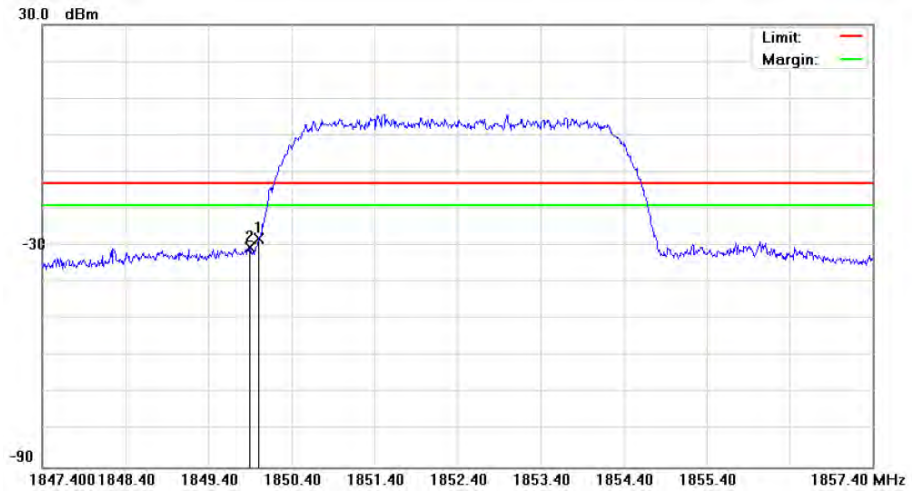

Higher Band

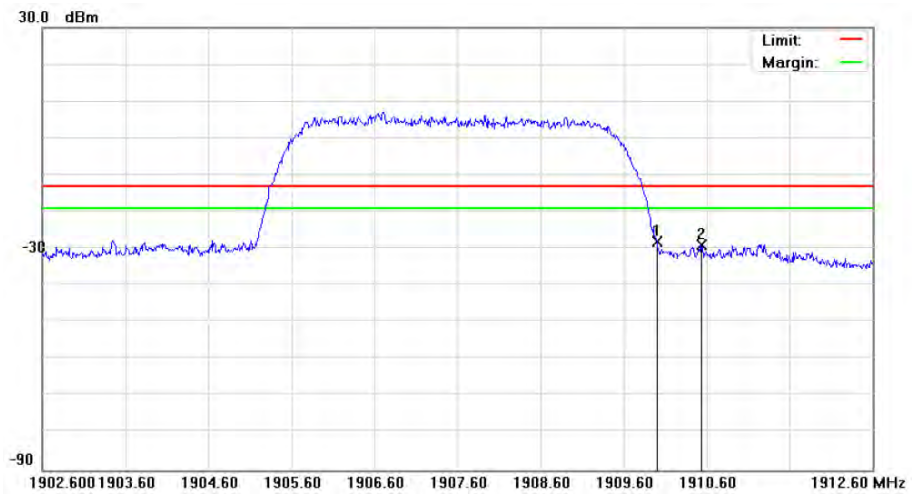

Band Edge _ Mode 8

Lower Band

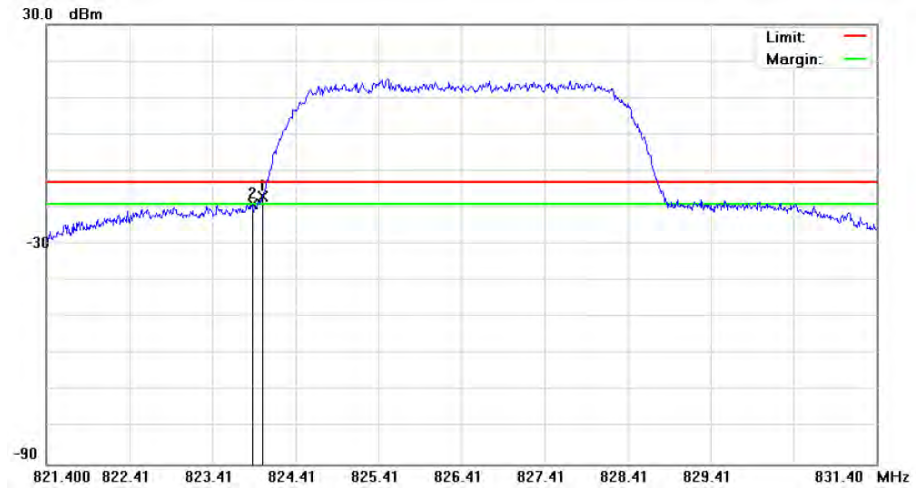

Higher Band

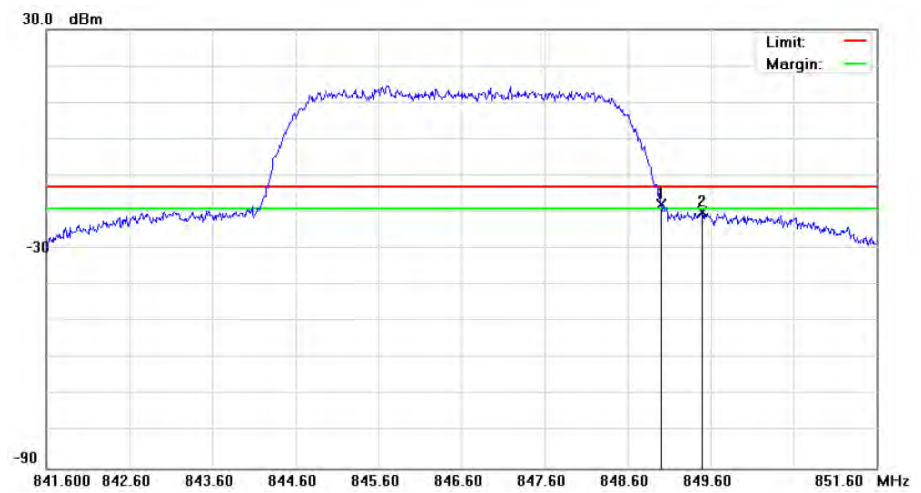

5 Conducted Spurious Emission Test

5.1. Limit

The power of any emission outside of the authorized operating frequency ranges must be attenuated below the transmitting power (P) by a factor of at least $43 + 10\log(P)$ dB.

5.2. Test Instruments

Equipment	Manufacturer	Model Number	Serial Number	Cal. Date	Remark
Spectrum Analyzer	Agilent	E4445A	MY46181986	05/16/2011	(2)
Universal Radio Communication Tester	ROHDE & SCHWARZ	CMU200	109369	08/10/2010	(2)
Attenuator	RADIALL	R41572000	0603033073	N.C.R.	-----
Power divider	Agilent	87302C	3239A00760	N.C.R.	-----
Test Site	ATL	TE05	TE05	N.C.R.	-----

Remark: ⁽¹⁾ Calibration period 1 year. ⁽²⁾ Calibration period 2 years.

Note: N.C.R. = No Calibration Request.

5.3. Setup

Below 2.8GHz

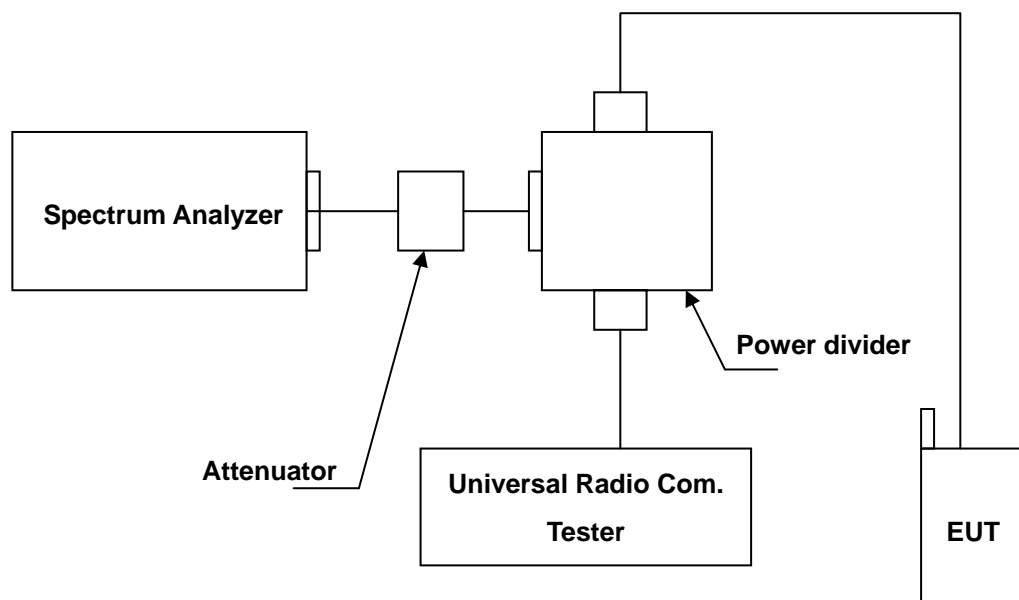

Above 2.8GHz

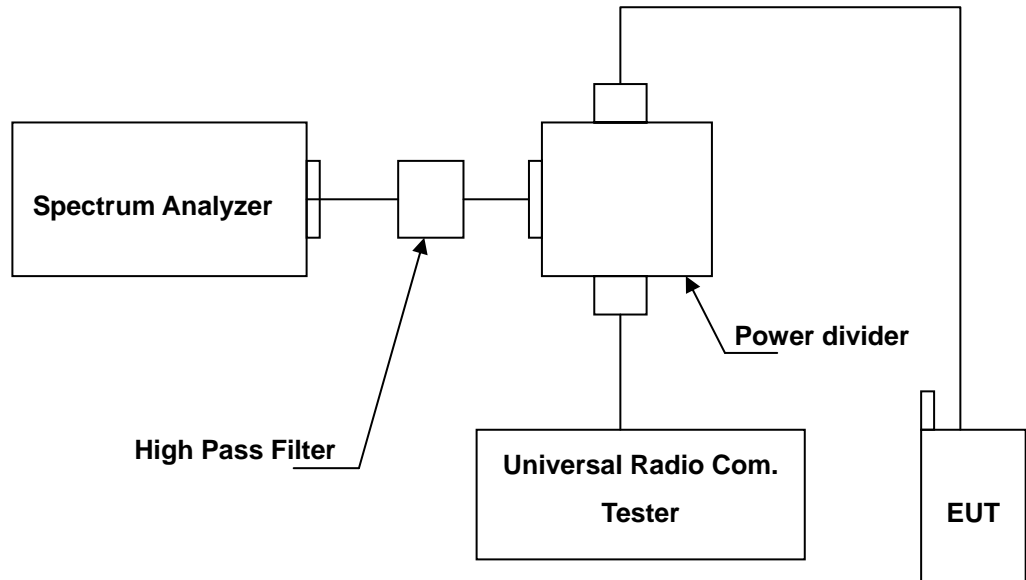

5.4. Test Procedure

1. The EUT was connected to Spectrum Analyzer and Base Station via power divider.
2. The middle channel for the highest RF power within the transmitting frequency was measured.
3. The conducted spurious emission for the whole frequency range was taken.
4. Test setting at GSM 850 RB>100 kHz, VB>100 kHz; PCS 1900 RB>1MHz, VB>1MHz.

5.5. Uncertainty

The measurement uncertainty is evaluated as ± 2.24 dB.

5.6. Test Result

Model Number	HE910-NAG		
Test Item	Conducted Spurious Emission		
Test Mode	Mode 1 / Mode 2 / Mode 7 / Mode 8		
Date of Test	04/11/2012	Test Site	TE05

File: HE910-NAG(CH128)

Data :#1

Date: 2012/4/11

Time: 下午 04:22:46

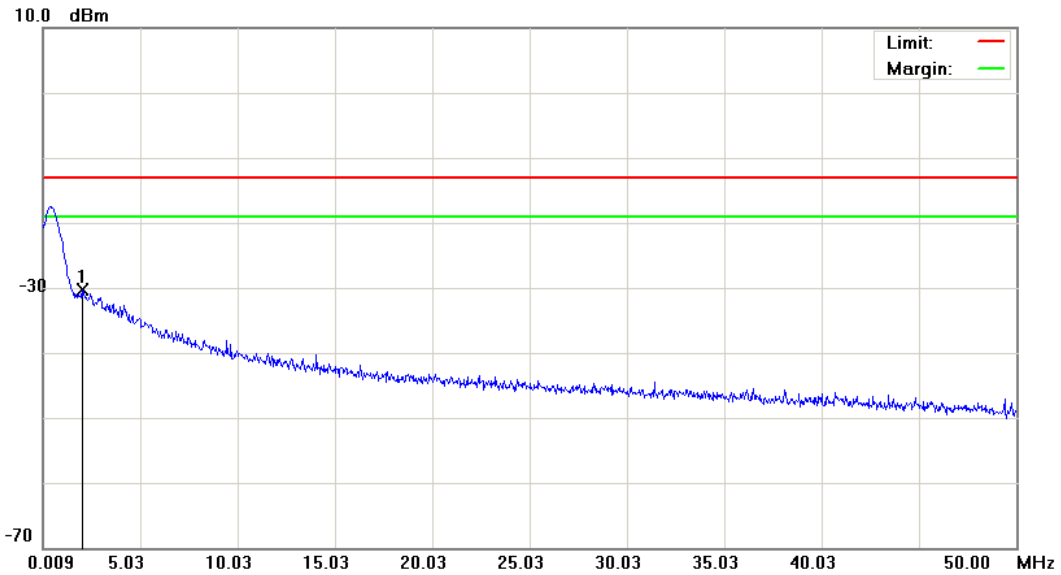

Site: : RF Conducted	Polarization: <i>Conducted po</i>	Temperature: 23 °C
Limit: FCC Part 22 conducted(9k-12.75G)	Power: DC 3.8V	Humidity: 55.2 %
EUT: 2G/3.5G Module	Distance:	RBW: 1000 KHz VBW: 1000 KHz
M/N: HE910-NAG		
Mode: 1		
Note: CH 128		

No.	Mk.	Freq. MHz	Reading Level dBm	Correct Factor dB	Measure- ment dBm	Limit dBm	Over dB	Antenna Height cm	Table Degree	Comment
1	*	2.0085	-61.69	31.37	-30.32	-13.00	-17.32	peak		

*:Maximum data x:Over limit !:over margin

File: HE910-NAG(CH128)

Data :#2

Date: 2012/4/11

Time: 下午 04:23:10

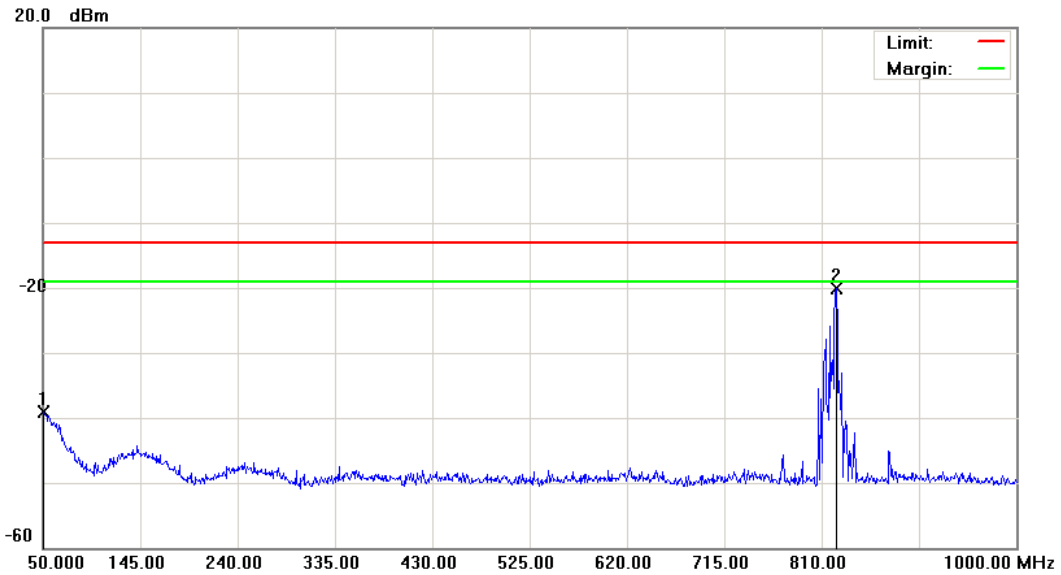

Site: : RF Conducted

 Polarization: *Conducted po*

Temperature: 23 °C

Limit: FCC Part 22 conducted(9k-12.75G)

Power: DC 3.8V

Humidity: 55.2 %

EUT: 2G/3.5G Module

Distance:

RBW: 1000 KHz VBW: 1000 KHz

M/N: HE910-NAG

Mode: 1

Note: CH 128

No.	Mk.	Freq. MHz	Reading Level dBm	Correct Factor dB	Measure- ment dBm	Limit dBm	Over dB	Antenna Height cm	Table Degree	Comment
1		50.9500	-53.67	14.52	-39.15	-13.00	-26.15	peak		
2	*	824.2500	-23.96	3.84	-20.12	-13.00	-7.12	peak		Tx

*:Maximum data x:Over limit !:over margin

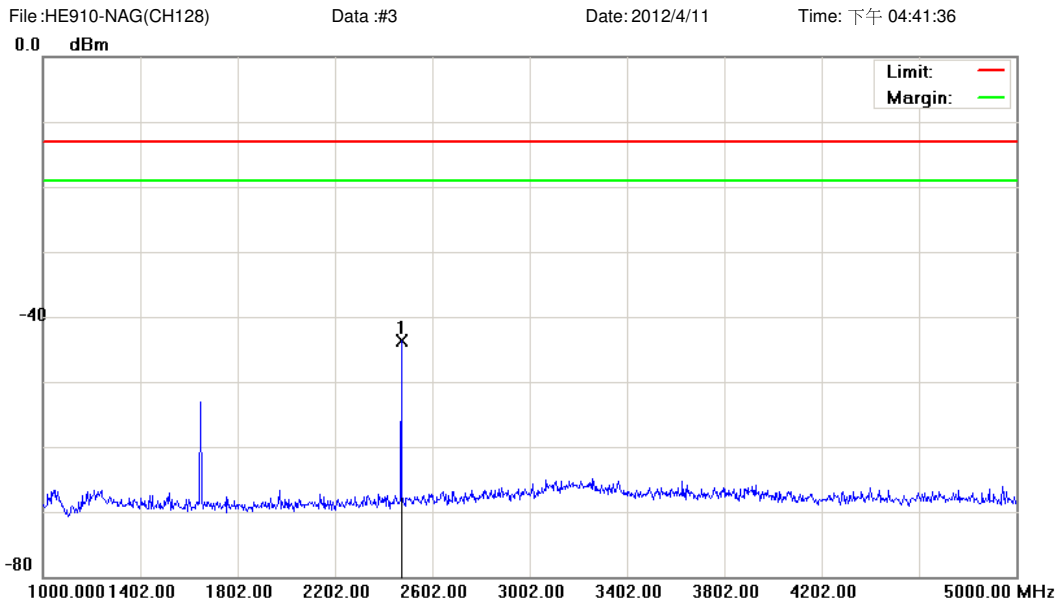

Site: : RF Conducted	Polarization: <i>Conducted po</i>	Temperature: 23 °C
Limit: FCC Part 22 conducted(9k-12.75G)	Power: DC 3.8V	Humidity: 55.2 %
EUT: 2G/3.5G Module	Distance:	RBW: 1000 KHz VBW: 1000 KHz
M/N: HE910-NAG		
Mode: 1		
Note: CH 128		

No.	Mk.	Freq. MHz	Reading Level dBm	Correct Factor dB	Measure- ment dBm	Limit dBm	Over dB	Antenna Height cm	Table Degree	Comment
1	*	2472.000	-48.12	4.45	-43.67	-13.00	-30.67	peak		

*:Maximum data x:Over limit !:over margin

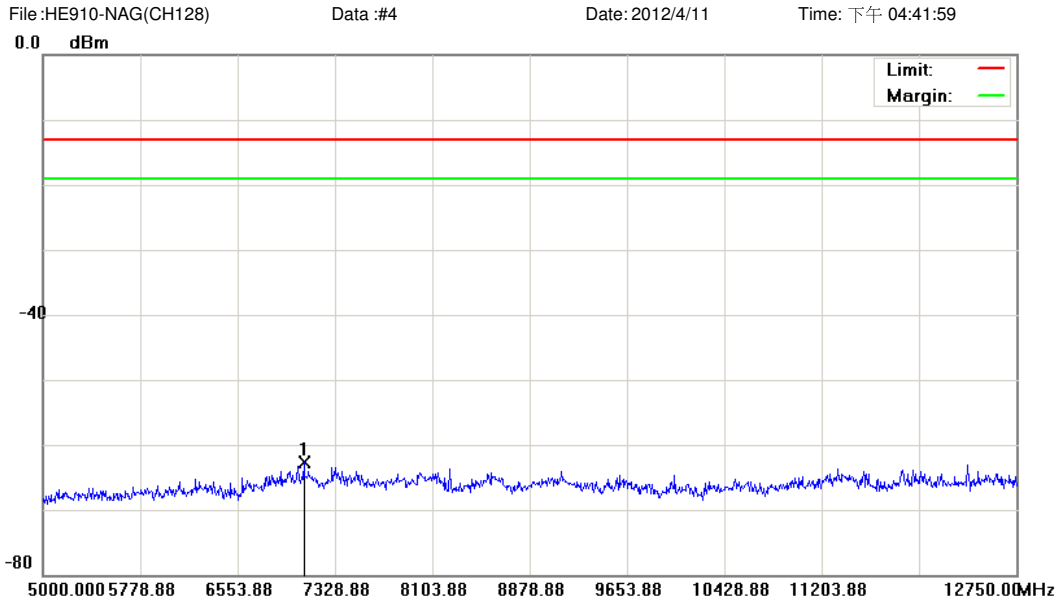

Site: : RF Conducted	Polarization: <i>Conducted po</i>	Temperature: 23 °C
Limit: FCC Part 22 conducted(9k-12.75G)	Power: DC 3.8V	Humidity: 55.2 %
EUT: 2G/3.5G Module	Distance:	RBW: 1000 KHz VBW: 1000 KHz
M/N: HE910-NAG		
Mode: 1		
Note: CH 128		

No.	Mk.	Freq. MHz	Reading Level dBm	Correct Factor dB	Measure- ment dBm	Limit dBm	Over dB	Antenna Height cm	Table Degree	Comment
1	*	7077.000	-67.64	4.96	-62.68	-13.00	-49.68	peak		

*:Maximum data x:Over limit !:over margin

File: HE910-NAG(CH190)

Data :#1

Date: 2012/4/11

Time: 下午 04:24:48

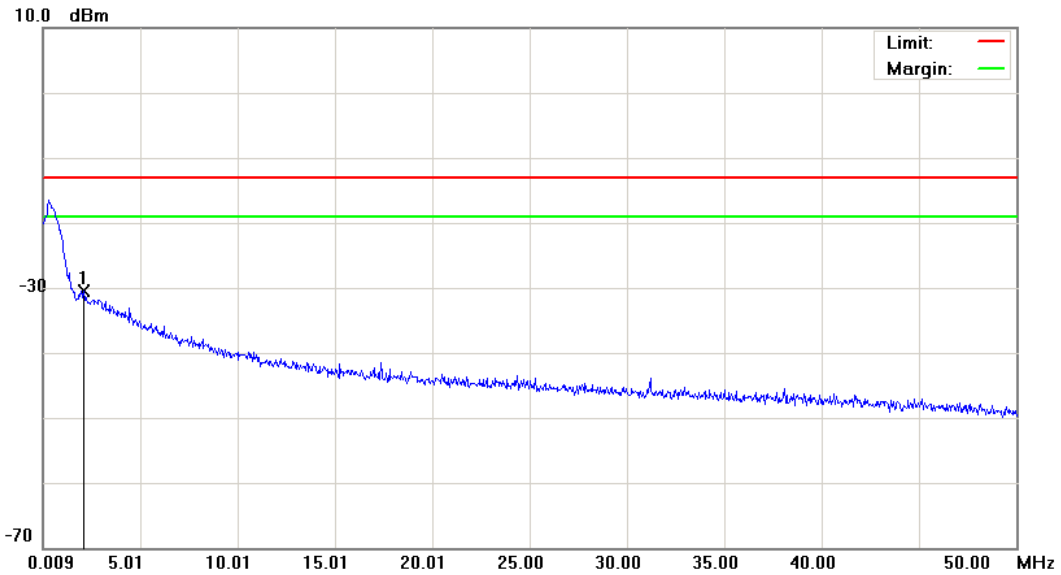

Site: : RF Conducted	Polarization: <i>Conducted po</i>	Temperature: 23 °C
Limit: FCC Part 22 conducted(9k-12.75G)	Power: DC 3.8V	Humidity: 55.2 %
EUT: 2G/3.5G Module	Distance:	RBW: 1000 KHz VBW: 1000 KHz
M/N: HE910-NAG		
Mode: 1		
Note: CH 190		

No.	Mk.	Freq. MHz	Reading Level dBm	Correct Factor dB	Measure- ment dBm	Limit dBm	Over dB	Antenna Height cm	Table Degree	Comment
1	*	2.1086	-62.09	31.54	-30.55	-13.00	-17.55	peak		

*:Maximum data x:Over limit !:over margin

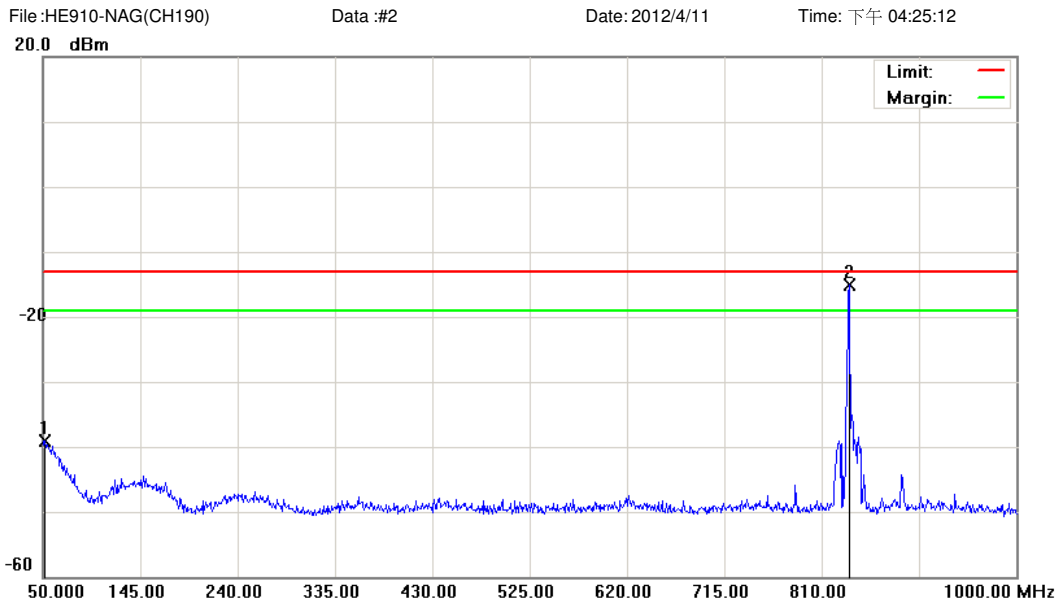

Site: : RF Conducted	Polarization: <i>Conducted po</i>	Temperature: 23 °C
Limit: FCC Part 22 conducted(9k-12.75G)	Power: DC 3.8V	Humidity: 55.2 %
EUT: 2G/3.5G Module	Distance:	RBW: 1000 kHz VBW: 1000 kHz
M/N: HE910-NAG		
Mode: 1		
Note: CH 190		

No.	Mk.	Freq. MHz	Reading Level dBm	Correct Factor dB	Measure- ment dBm	Limit dBm	Over dB	Antenna Height cm	Table Degree	Comment
1		51.9000	-53.48	14.36	-39.12	-13.00	-26.12	peak		
2	*	836.6000	-19.06	3.96	-15.10	-13.00	-2.10	peak		Tx

*:Maximum data x:Over limit !:over margin

File: HE910-NAG(CH190)

Data :#3

Date: 2012/4/11

Time: 下午 04:42:33

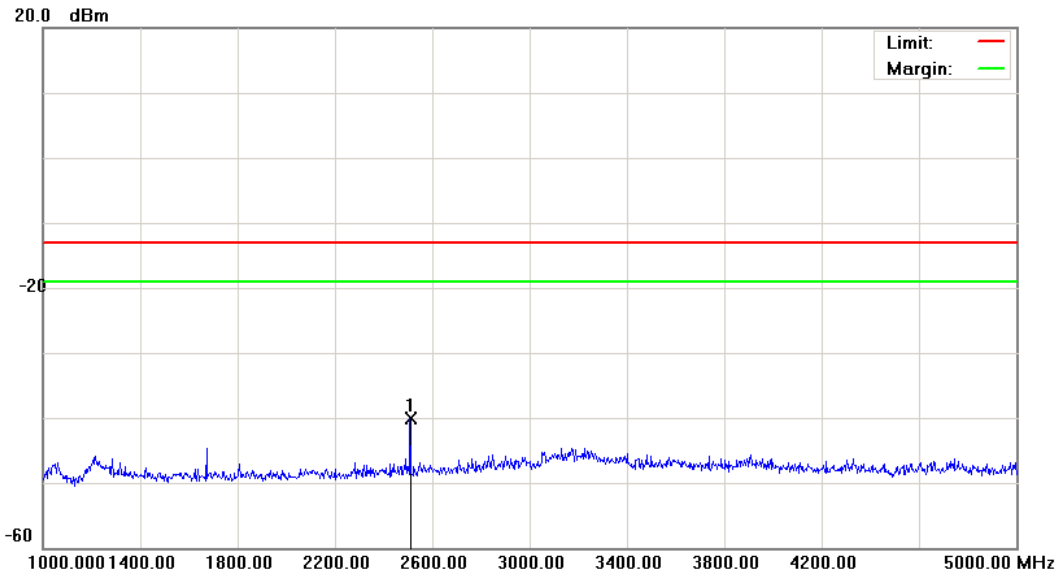

Site: : RF Conducted

 Polarization: *Conducted po*

Temperature: 23 °C

Limit: FCC Part 22 conducted(9k-12.75G)

Power: DC 3.8V

Humidity: 55.2 %

EUT: 2G/3.5G Module

Distance:

RBW: 1000 KHz VBW: 1000 KHz

M/N: HE910-NAG

Mode: 1

Note: CH 190

No.	Mk.	Freq. MHz	Reading Level dBm	Correct Factor dB	Measure- ment dBm	Limit dBm	Over dB	Antenna Height cm	Table Degree	Comment
1	*	2510.000	-44.40	4.36	-40.04	-13.00	-27.04	peak		

*:Maximum data x:Over limit !:over margin

File: HE910-NAG(CH190)

Data :#4

Date: 2012/4/11

Time: 下午 04:42:56

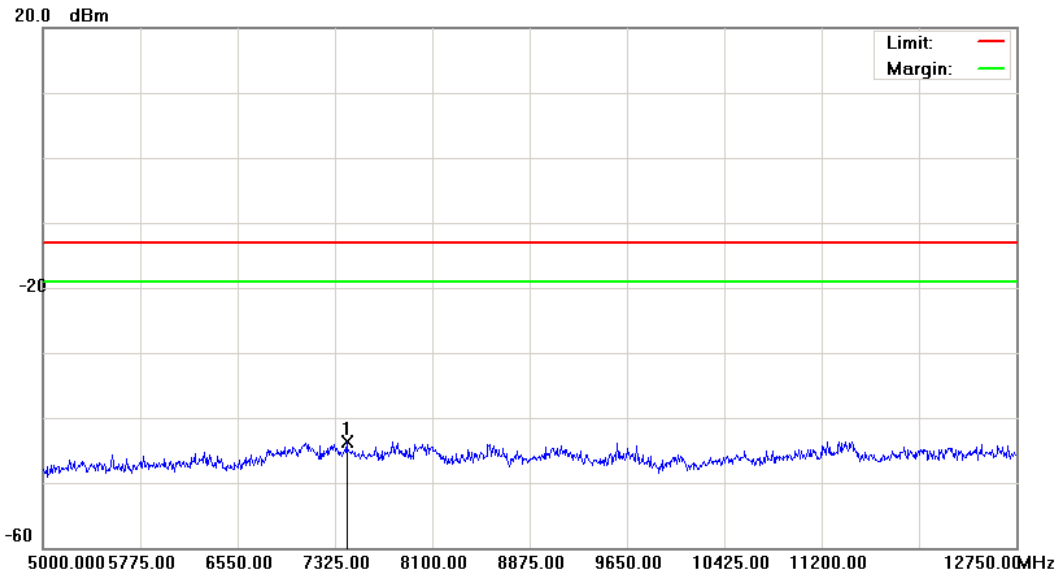

Site: : RF Conducted

 Polarization: *Conducted po*

Temperature: 23 °C

Limit: FCC Part 22 conducted(9k-12.75G)

Power: DC 3.8V

Humidity: 55.2 %

EUT: 2G/3.5G Module

Distance:

RBW: 1000 KHz VBW: 1000 KHz

M/N: HE910-NAG

Mode: 1

Note: CH 190

No.	Mk.	Freq. MHz	Reading Level dBm	Correct Factor dB	Measure- ment dBm	Limit dBm	Over dB	Detector	Antenna Height cm	Table Degree	Comment
1	*	7421.875	-48.84	5.21	-43.63	-13.00	-30.63	peak			

*:Maximum data x:Over limit !:over margin

File: HE910-NAG(CH251)

Data :#1

Date: 2012/4/11

Time: 下午 04:26:44

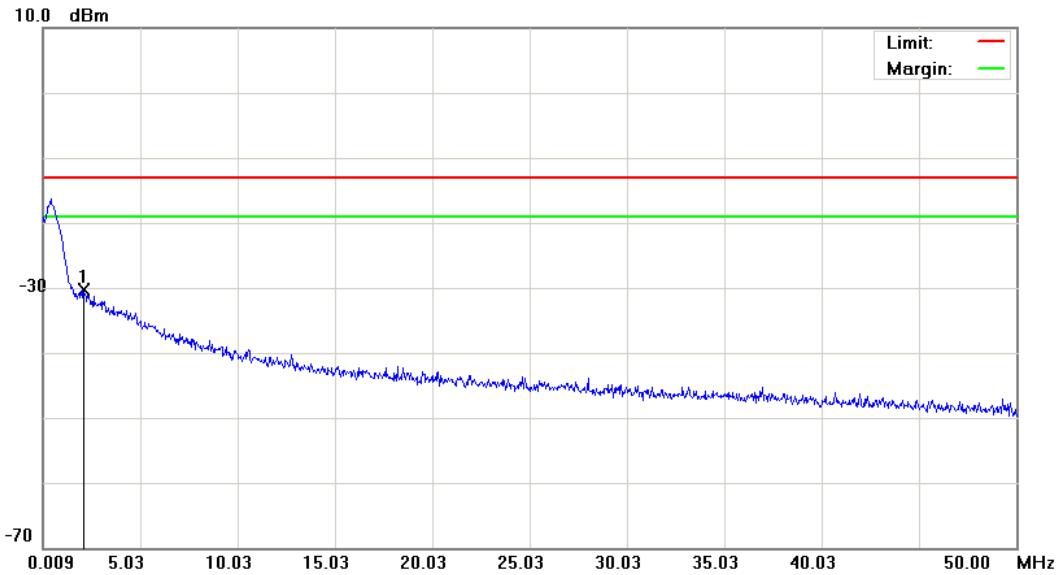

Site: : RF Conducted	Polarization: <i>Conducted po</i>	Temperature: 23 °C
Limit: FCC Part 22 conducted(9k-12.75G)	Power: DC 3.8V	Humidity: 55.2 %
EUT: 2G/3.5G Module	Distance:	RBW: 1000 KHz VBW: 1000 KHz
M/N: HE910-NAG		
Mode: 1		
Note: CH 251		

No.	Mk.	Freq. MHz	Reading Level dBm	Correct Factor dB	Measure- ment dBm	Limit dBm	Over dB	Antenna Height cm	Table Degree	Comment
1	*	2.0836	-61.81	31.50	-30.31	-13.00	-17.31	peak		

*:Maximum data x:Over limit !:over margin

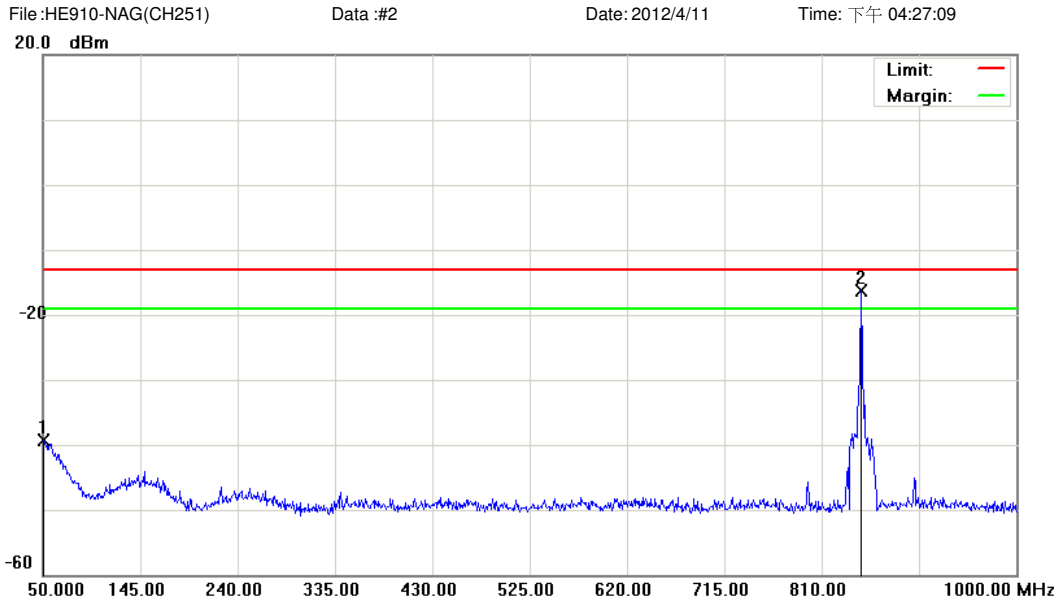

Site: : RF Conducted	Polarization: <i>Conducted po</i>	Temperature: 23 °C
Limit: FCC Part 22 conducted(9k-12.75G)	Power: DC 3.8V	Humidity: 55.2 %
EUT: 2G/3.5G Module	Distance:	RBW: 1000 KHz VBW: 1000 KHz
M/N: HE910-NAG		
Mode: 1		
Note: CH 251		

No.	Mk.	Freq. MHz	Reading Level dBm	Correct Factor dB	Measure- ment dBm	Limit dBm	Over dB	Antenna Height cm	Table Degree	Comment
1		50.9500	-53.86	14.52	-39.34	-13.00	-26.34	peak		
2	*	848.9500	-20.26	3.98	-16.28	-13.00	-3.28	peak		Tx

*:Maximum data x:Over limit !:over margin

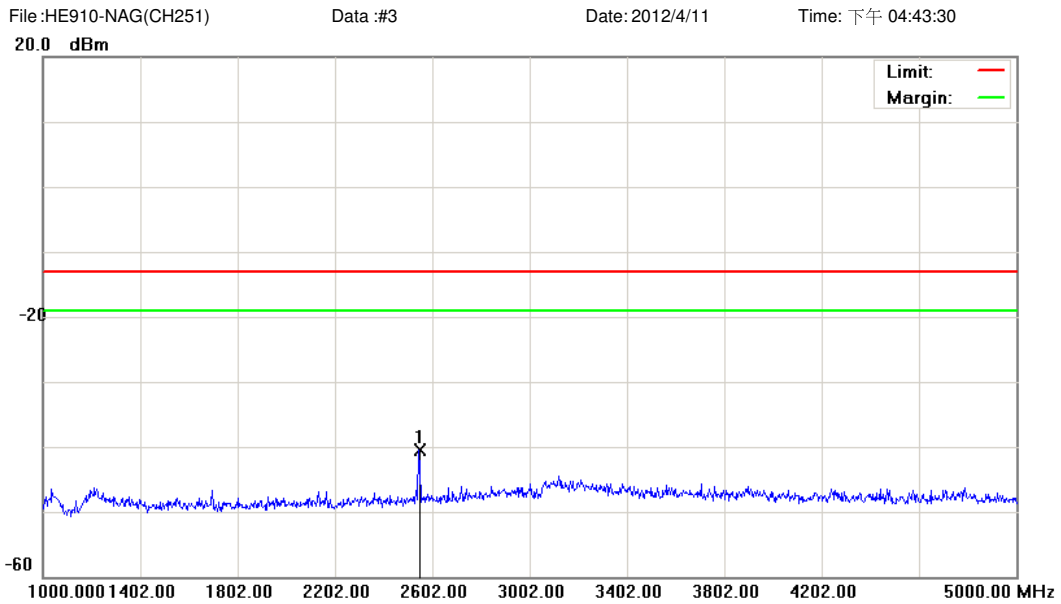

Site: : RF Conducted	Polarization: <i>Conducted po</i>	Temperature: 23 °C
Limit: FCC Part 22 conducted(9k-12.75G)	Power: DC 3.8V	Humidity: 55.2 %
EUT: 2G/3.5G Module	Distance:	RBW: 1000 KHz VBW: 1000 KHz
M/N: HE910-NAG		
Mode: 1		
Note: CH 251		

No.	Mk.	Freq. MHz	Reading Level dBm	Correct Factor dB	Measure- ment dBm	Limit dBm	Over dB	Antenna Height cm	Table Degree	Comment
1	*	2546.000	-44.95	4.45	-40.50	-13.00	-27.50	peak		

*:Maximum data x:Over limit !:over margin

File: HE910-NAG(CH251)

Data :#4

Date: 2012/4/11

Time: 下午 04:43:53

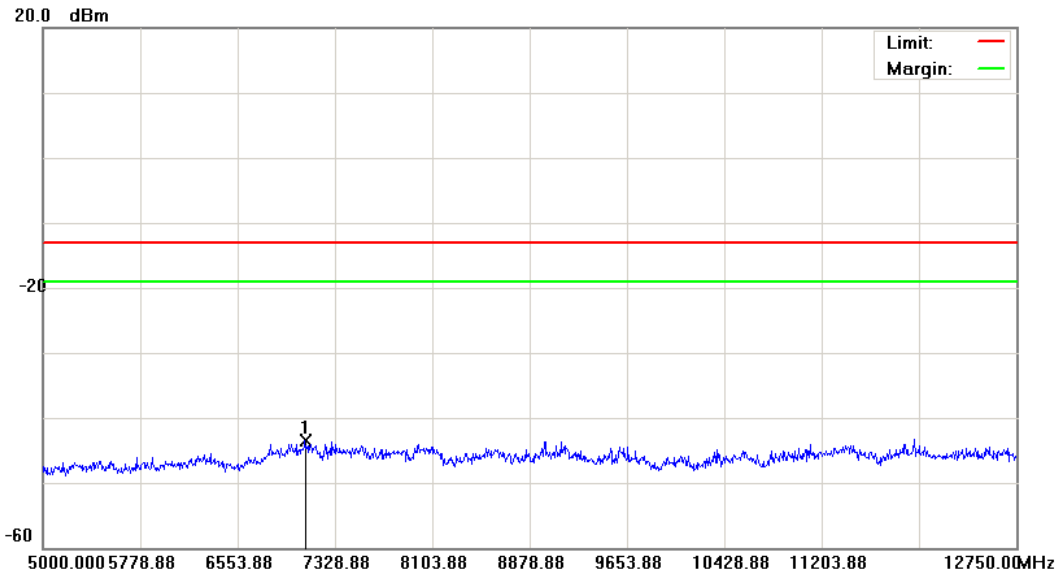

Site: : RF Conducted

 Polarization: *Conducted po*

Temperature: 23 °C

Limit: FCC Part 22 conducted(9k-12.75G)

Power: DC 3.8V

Humidity: 55.2 %

EUT: 2G/3.5G Module

Distance:

RBW: 1000 KHz VBW: 1000 KHz

M/N: HE910-NAG

Mode: 1

Note: CH 251

No.	Mk.	Freq. MHz	Reading Level dBm	Correct Factor dB	Measure- ment dBm	Limit dBm	Over dB	Antenna Height cm	Table Degree	Comment
1	*	7088.625	-48.52	5.03	-43.49	-13.00	-30.49	peak		

*:Maximum data x:Over limit !:over margin

File: HE910-NAG(CH512)

Data :#1

Date: 2012/4/11

Time: 下午 04:04:31

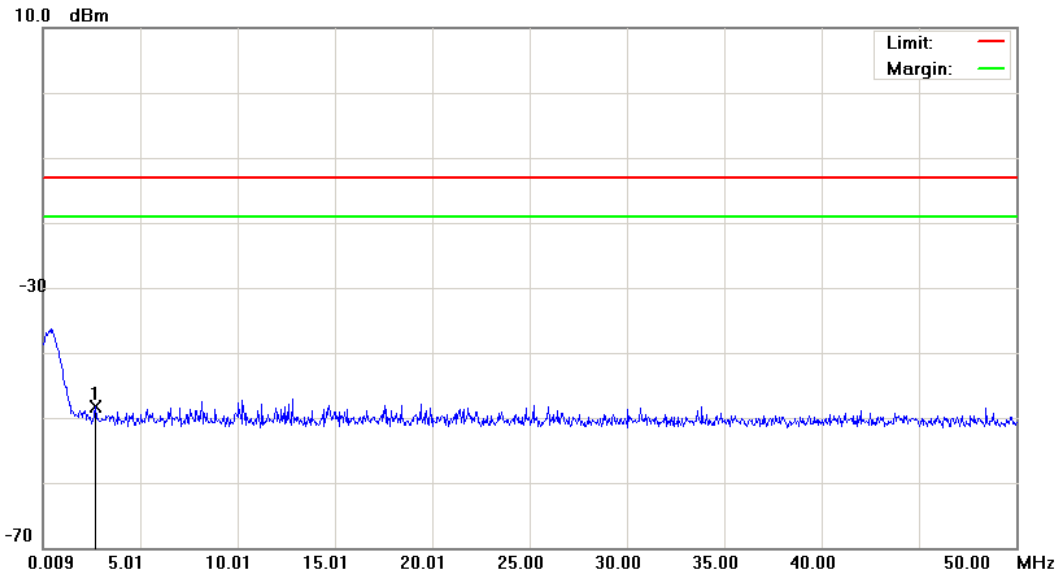

Site: : RF Conducted	Polarization: <i>Conducted po</i>	Temperature: 23 °C
Limit: FCC Part 24 conducted(9k-12.75G)	Power: DC 3.8V	Humidity: 55.2 %
EUT: 2G/3.5G Module	Distance:	RBW: 1000 kHz VBW: 1000 kHz
M/N: HE910-NAG		
Mode: 2		
Note: CH 512		

No.	Mk.	Freq. MHz	Reading Level dBm	Correct Factor dB	Measure- ment dBm	Limit dBm	Over dB	Antenna Height cm	Table Degree	Comment
1	*	2.7084	-61.17	12.83	-48.34	-13.00	-35.34	peak		

*:Maximum data x:Over limit !:over margin

File: HE910-NAG(CH512)

Data :#2

Date: 2012/4/11

Time: 下午 04:04:55

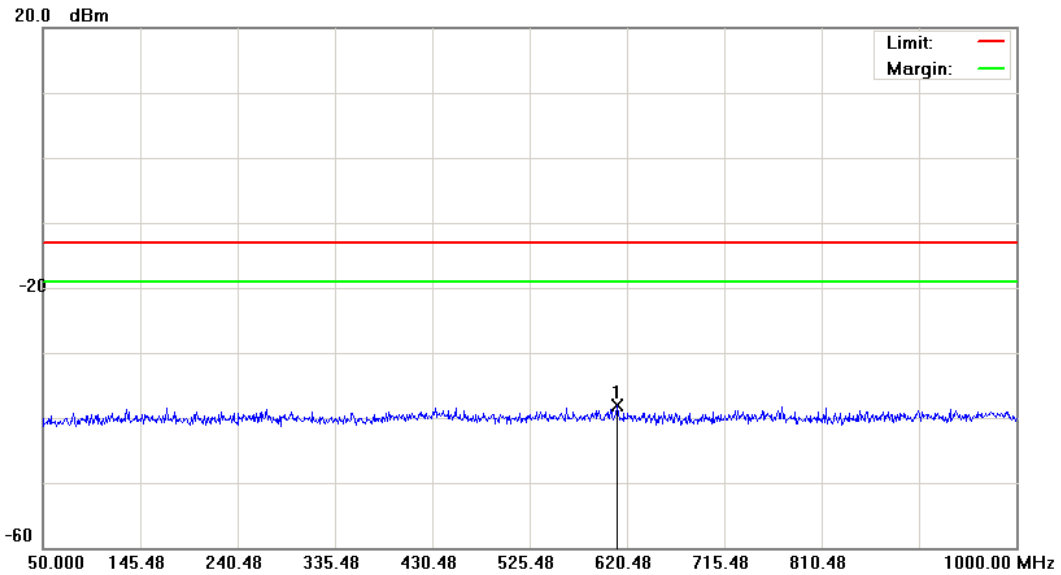

Site: : RF Conducted	Polarization: <i>Conducted po</i>	Temperature: 23 °C
Limit: FCC Part 24 conducted(9k-12.75G)	Power: DC 3.8V	Humidity: 55.2 %
EUT: 2G/3.5G Module	Distance:	RBW: 1000 KHz VBW: 1000 KHz
M/N: HE910-NAG		
Mode: 2		
Note: CH 512		

No.	Mk.	Freq. MHz	Reading Level dBm	Correct Factor dB	Measure- ment dBm	Limit dBm	Over dB	Antenna Height cm	Table Degree	Comment
1	*	610.5000	-51.26	13.16	-38.10	-13.00	-25.10	peak		

*:Maximum data x:Over limit !:over margin

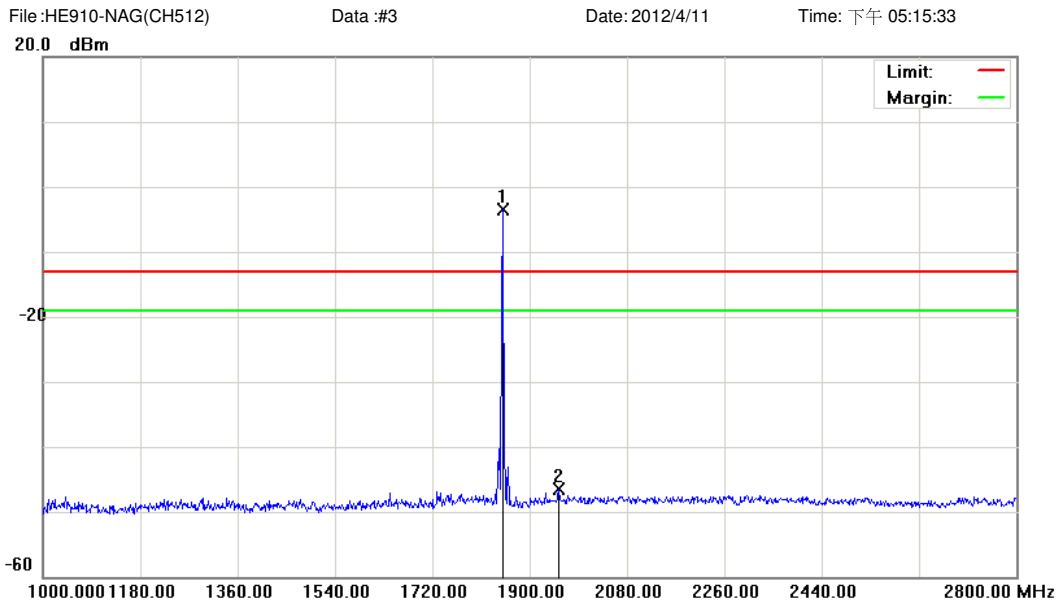

Site: : RF Conducted Polarization: *Conducted po* Temperature: 23 °C
 Limit: FCC Part 24 conducted(9k-12.75G) Power: DC 3.8V Humidity: 55.2 %
 EUT: 2G/3.5G Module Distance: RBW: 1000 KHz VBW: 1000 KHz
 M/N: HE910-NAG
 Mode: 2
 Note: CH 512

No.	Mk.	Freq. MHz	Reading Level dBm	Correct Factor dB	Measure- ment dBm	Limit dBm	Over dB	Antenna Height cm	Table Degree	Comment
1	*	1850.500	-7.67	4.26	-3.41	-13.00	9.59	peak		Tx
2		1954.000	-51.10	4.69	-46.41	-13.00	-33.41	peak		

*:Maximum data x:Over limit !:over margin

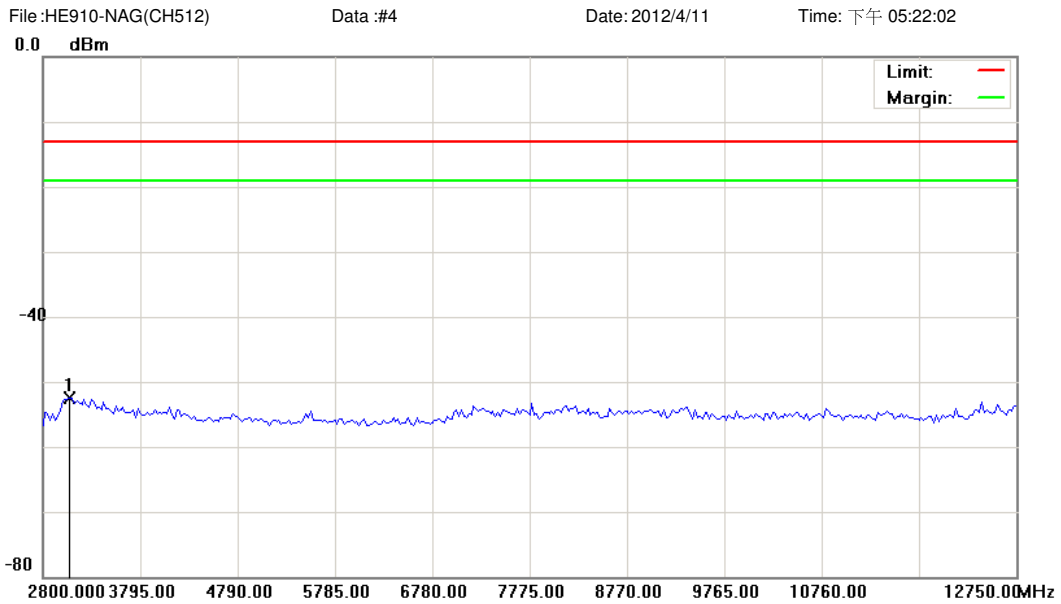

Site: : RF Conducted	Polarization: Conducted po	Temperature: 23 °C
Limit: FCC Part 24 conducted(9k-12.75G)	Power: DC 3.8V	Humidity: 55.2 %
EUT: 2G/3.5G Module	Distance:	RBW: 1000 KHz VBW: 1000 KHz
M/N: HE910-NAG		
Mode: 2		
Note: CH 512		

No.	Mk.	Freq. MHz	Reading Level dBm	Correct Factor dB	Measure- ment dBm	Limit dBm	Over dB	Antenna Height cm	Table Degree	Comment
1	*	3073.625	-57.84	5.40	-52.44	-13.00	-39.44	peak		

*:Maximum data x:Over limit !:over margin

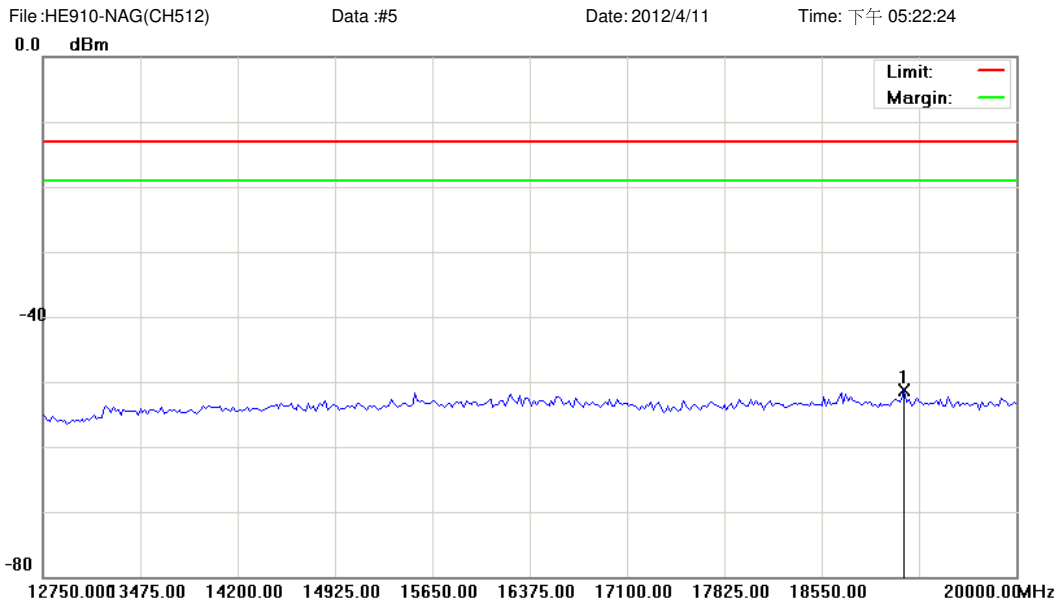

Site: : RF Conducted	Polarization: <i>Conducted po</i>	Temperature: 23 °C
Limit: FCC Part 24 conducted(9k-12.75G)	Power: DC 3.8V	Humidity: 55.2 %
EUT: 2G/3.5G Module	Distance:	RBW: 1000 KHz VBW: 1000 KHz
M/N: HE910-NAG		
Mode: 2		
Note: CH 512		

No.	Mk.	Freq. MHz	Reading Level dBm	Correct Factor dB	Measure- ment dBm	Limit dBm	Over dB	Antenna Height cm	Table Degree	Comment
1	*	19166.250	-58.43	7.20	-51.23	-13.00	-38.23	peak		

*:Maximum data x:Over limit !:over margin

File: HE910-NAG(CH661)

Data :#1

Date: 2012/4/11

Time: 下午 04:18:23

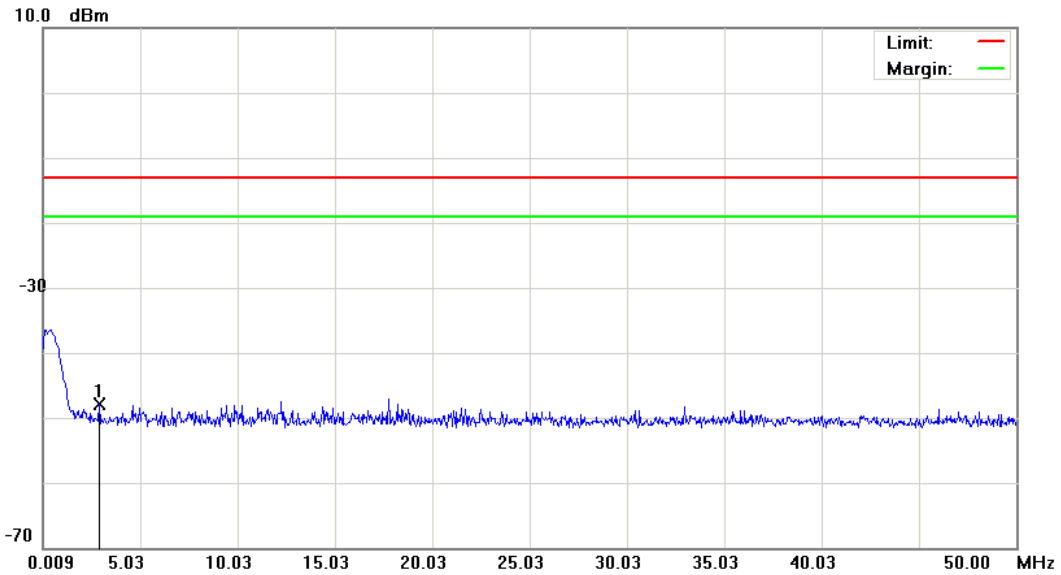

Site: : RF Conducted	Polarization: <i>Conducted po</i>	Temperature: 23 °C
Limit: FCC Part 24 conducted(9k-12.75G)	Power: DC 3.8V	Humidity: 55.2 %
EUT: 2G/3.5G Module	Distance:	RBW: 1000 KHz VBW: 1000 KHz
M/N: HE910-NAG		
Mode: 2		
Note: CH 661		

No.	Mk.	Freq.	Reading Level	Correct Factor	Measurement	Limit	Over	Antenna Height	Table Degree	Comment
		MHz	dBm	dB	dBm	dBm	dB	cm	degree	
1	*	2.9085	-60.91	12.94	-47.97	-13.00	-34.97	peak		

*:Maximum data x:Over limit !:over margin

File: HE910-NAG(CH661)

Data :#2

Date: 2012/4/11

Time: 下午 04:18:47

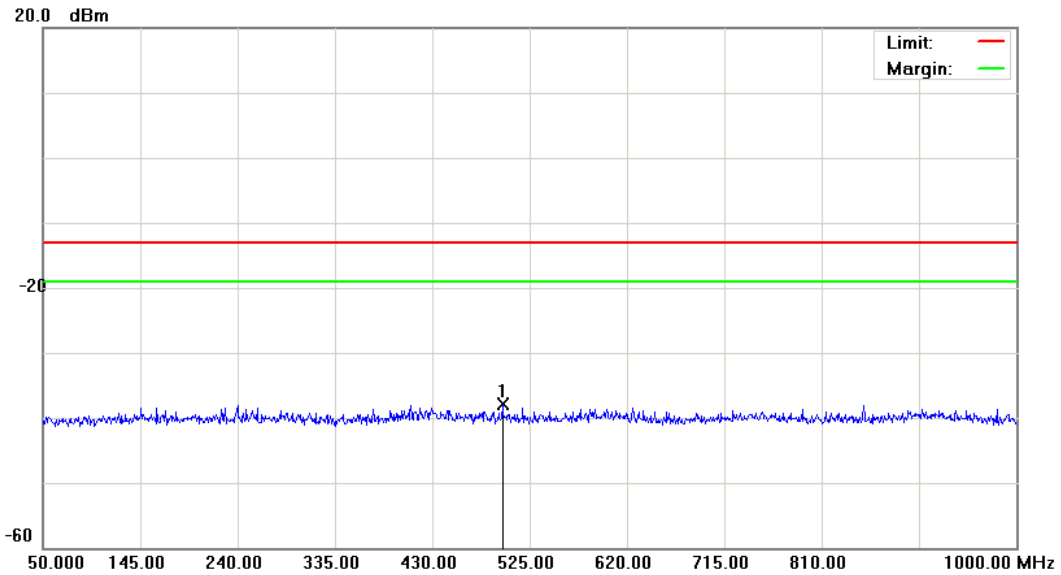

Site: : RF Conducted

 Polarization: *Conducted po*

Temperature: 23 °C

Limit: FCC Part 24 conducted(9k-12.75G)

Power: DC 3.8V

Humidity: 55.2 %

EUT: 2G/3.5G Module

Distance:

RBW: 1000 KHz VBW: 1000 KHz

M/N: HE910-NAG

Mode: 2

Note: CH 661

No.	Mk.	Freq. MHz	Reading Level dBm	Correct Factor dB	Measure- ment dBm	Limit dBm	Over dB	Detector	Antenna Height cm	Table Degree	Comment
1	*	498.4000	-51.01	13.14	-37.87	-13.00	-24.87	peak			

*:Maximum data x:Over limit !:over margin

File: HE910-NAG(CH661)

Data :#3

Date: 2012/4/11

Time: 下午 05:16:41

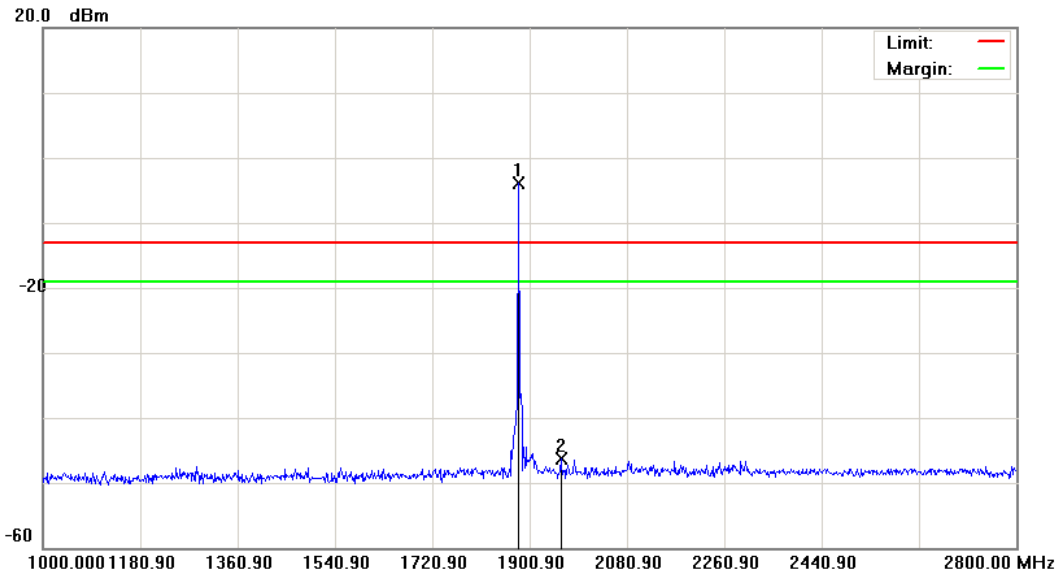

Site: : RF Conducted	Polarization: <i>Conducted po</i>	Temperature: 23 °C
Limit: FCC Part 24 conducted(9k-12.75G)	Power: DC 3.8V	Humidity: 55.2 %
EUT: 2G/3.5G Module	Distance:	RBW: 1000 kHz VBW: 1000 kHz
M/N: HE910-NAG		
Mode: 2		
Note: CH 661		

No.	Mk.	Freq. MHz	Reading Level dBm	Correct Factor dB	Measure- ment dBm	Limit dBm	Over dB	Detector	Antenna Height cm	Table Degree	Comment
1	*	1880.200	-8.60	4.65	-3.95	-13.00	9.05	peak			Tx
2		1957.600	-51.01	4.71	-46.30	-13.00	-33.30	peak			

*:Maximum data x:Over limit !:over margin

File: HE910-NAG(CH661)

Data :#4

Date: 2012/4/11

Time: 下午 05:23:03

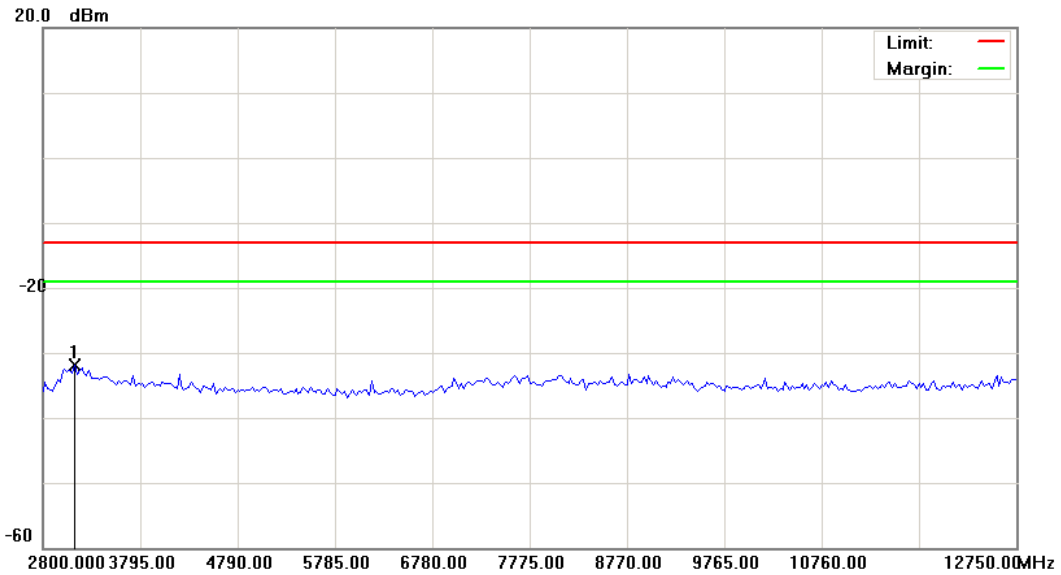

Site: : RF Conducted	Polarization: <i>Conducted po</i>	Temperature: 23 °C
Limit: FCC Part 24 conducted(9k-12.75G)	Power: DC 3.8V	Humidity: 55.2 %
EUT: 2G/3.5G Module	Distance:	RBW: 1000 KHz VBW: 1000 KHz
M/N: HE910-NAG		
Mode: 2		
Note: CH 661		

No.	Mk.	Freq. MHz	Reading Level dBm	Correct Factor dB	Measure- ment dBm	Limit dBm	Over dB	Antenna Height cm	Table Degree	Comment
1	*	3123.375	-37.19	5.30	-31.89	-13.00	-18.89	peak		

*:Maximum data x:Over limit !:over margin

File: HE910-NAG(CH661)

Data :#5

Date: 2012/4/11

Time: 下午 05:23:24

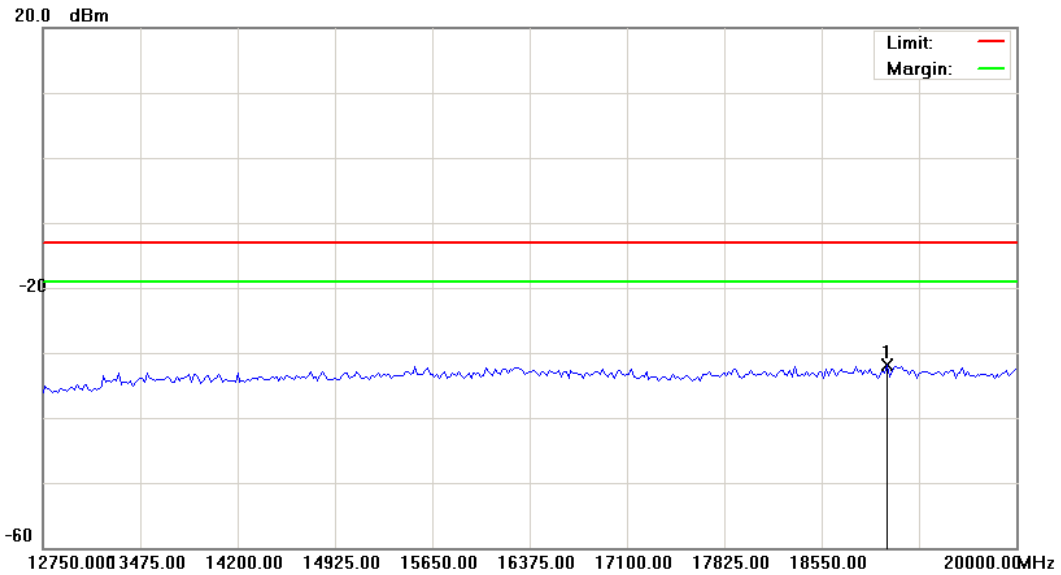

Site: : RF Conducted

 Polarization: *Conducted po*

Temperature: 23 °C

Limit: FCC Part 24 conducted(9k-12.75G)

Power: DC 3.8V

Humidity: 55.2 %

EUT: 2G/3.5G Module

Distance:

RBW: 1000 KHz VBW: 1000 KHz

M/N: HE910-NAG

Mode: 2

Note: CH 661

No.	Mk.	Freq. MHz	Reading Level dBm	Correct Factor dB	Measure- ment dBm	Limit dBm	Over dB	Antenna Height cm	Table Degree	Comment
1	*	19039.375	-39.11	7.17	-31.94	-13.00	-18.94	peak		

*:Maximum data x:Over limit !:over margin

File: HE910-NAG(CH810)

Data :#1

Date: 2012/4/11

Time: 下午 04:19:42

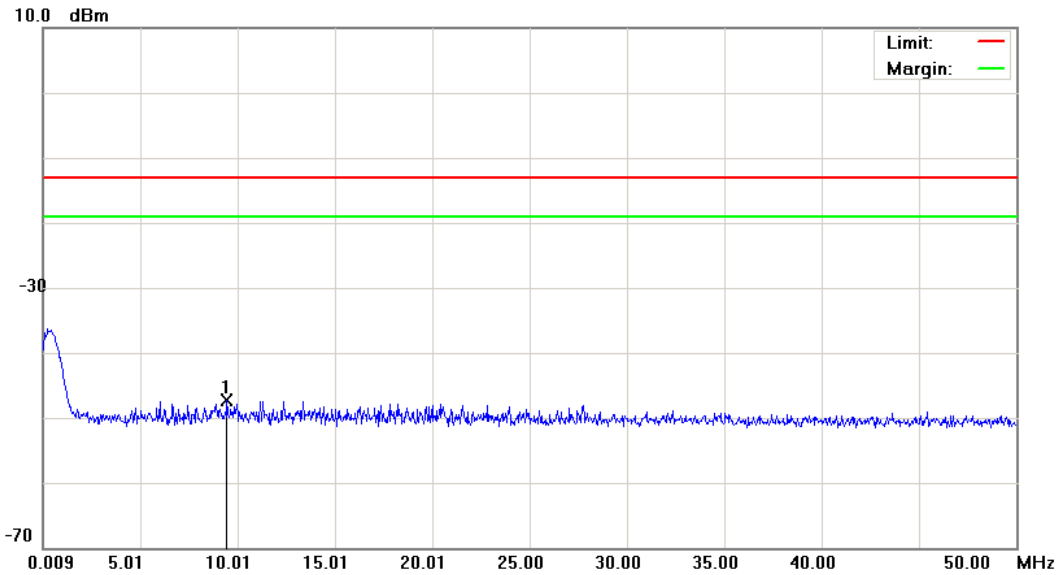

Site: : RF Conducted	Polarization: <i>Conducted po</i>	Temperature: 23 °C
Limit: FCC Part 24 conducted(9k-12.75G)	Power: DC 3.8V	Humidity: 55.2 %
EUT: 2G/3.5G Module	Distance:	RBW: 1000 KHz VBW: 1000 KHz
M/N: HE910-NAG		
Mode: 2		
Note: CH 810		

No.	Mk.	Freq. MHz	Reading Level dBm	Correct Factor dB	Measure- ment dBm	Limit dBm	Over dB	Antenna Height cm	Table Degree	Comment
1	*	9.4573	-60.69	13.30	-47.39	-13.00	-34.39	peak		

*:Maximum data x:Over limit !:over margin

File: HE910-NAG(CH810)

Data :#2

Date: 2012/4/11

Time: 下午 04:20:06

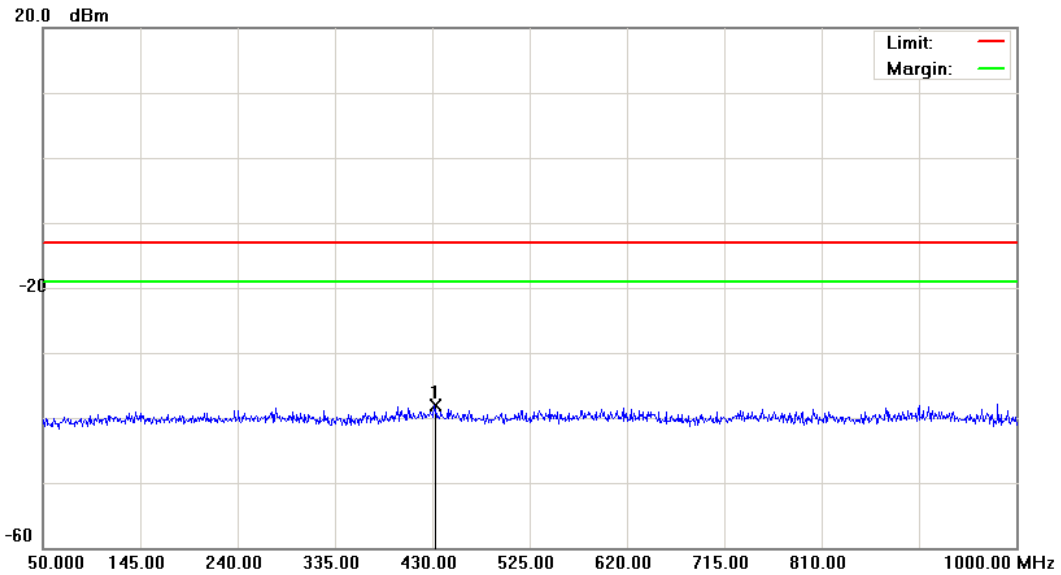

Site: : RF Conducted	Polarization: <i>Conducted po</i>	Temperature: 23 °C
Limit: FCC Part 24 conducted(9k-12.75G)	Power: DC 3.8V	Humidity: 55.2 %
EUT: 2G/3.5G Module	Distance:	RBW: 1000 KHz VBW: 1000 KHz
M/N: HE910-NAG		
Mode: 2		
Note: CH 810		

No.	Mk.	Freq. MHz	Reading Level dBm	Correct Factor dB	Measure- ment dBm	Limit dBm	Over dB	Antenna Height cm	Table Degree	Comment
1	*	432.3750	-51.43	13.25	-38.18	-13.00	-25.18	peak		

*:Maximum data x:Over limit !:over margin

File: HE910-NAG(CH810)

Data :#3

Date: 2012/4/11

Time: 下午 05:18:00

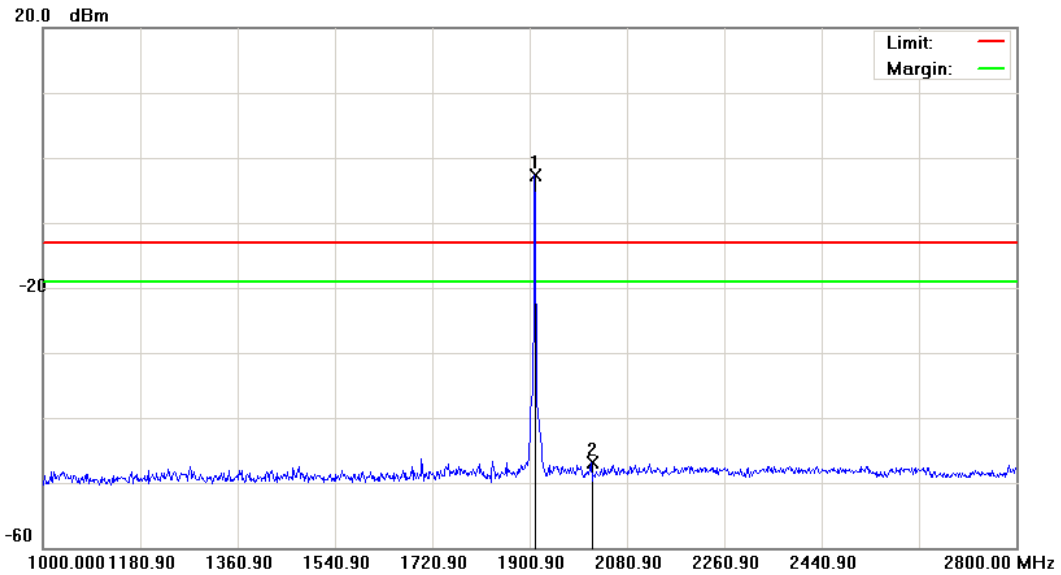

Site: : RF Conducted	Polarization: <i>Conducted po</i>	Temperature: 23 °C
Limit: FCC Part 24 conducted(9k-12.75G)	Power: DC 3.8V	Humidity: 55.2 %
EUT: 2G/3.5G Module	Distance:	RBW: 1000 KHz VBW: 1000 KHz
M/N: HE910-NAG		
Mode: 2		
Note: CH 810		

No.	Mk.	Freq. MHz	Reading Level dBm	Correct Factor dB	Measure- ment dBm	Limit dBm	Over dB	Antenna Height cm	Table Degree	Detector	Comment
1	*	1909.900	-8.49	5.71	-2.78	-13.00	10.22			peak	Tx
2		2014.300	-51.31	4.42	-46.89	-13.00	-33.89			peak	

*:Maximum data x:Over limit !:over margin

File: HE910-NAG(CH810)

Data :#4

Date: 2012/4/11

Time: 下午 05:24:01

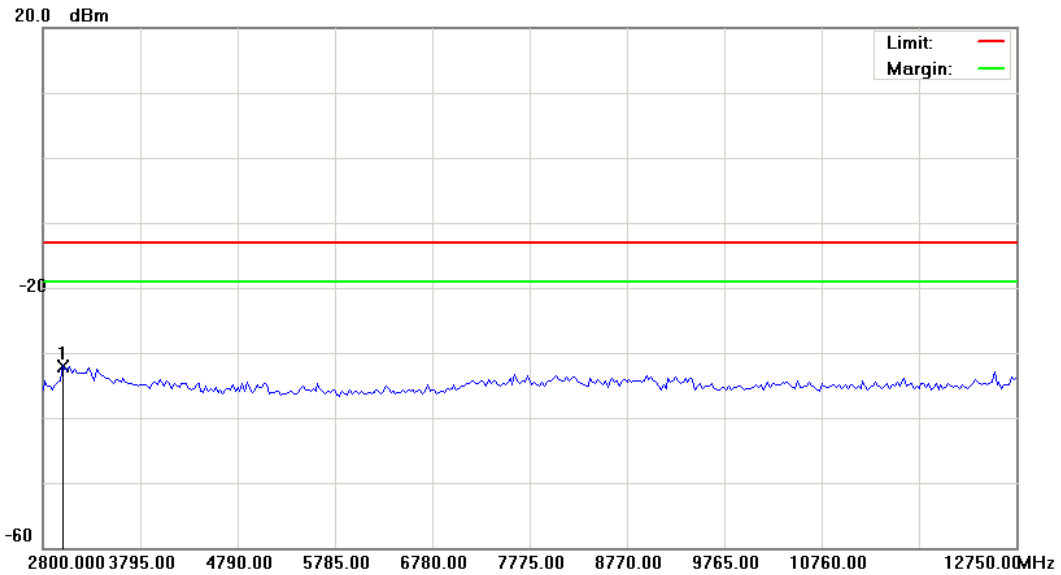

Site: : RF Conducted

 Polarization: *Conducted po*

Temperature: 23 °C

Limit: FCC Part 24 conducted(9k-12.75G)

Power: DC 3.8V

Humidity: 55.2 %

EUT: 2G/3.5G Module

Distance:

RBW: 1000 KHz VBW: 1000 KHz

M/N: HE910-NAG

Mode: 2

Note: CH 810

No.	Mk.	Freq. MHz	Reading Level dBm	Correct Factor dB	Measure- ment dBm	Limit dBm	Over dB	Antenna Height cm	Table Degree	Comment
1	*	2999.000	-37.48	5.48	-32.00	-13.00	-19.00	peak		

*:Maximum data x:Over limit !:over margin

File: HE910-NAG(CH810)

Data :#5

Date: 2012/4/11

Time: 下午 05:24:23

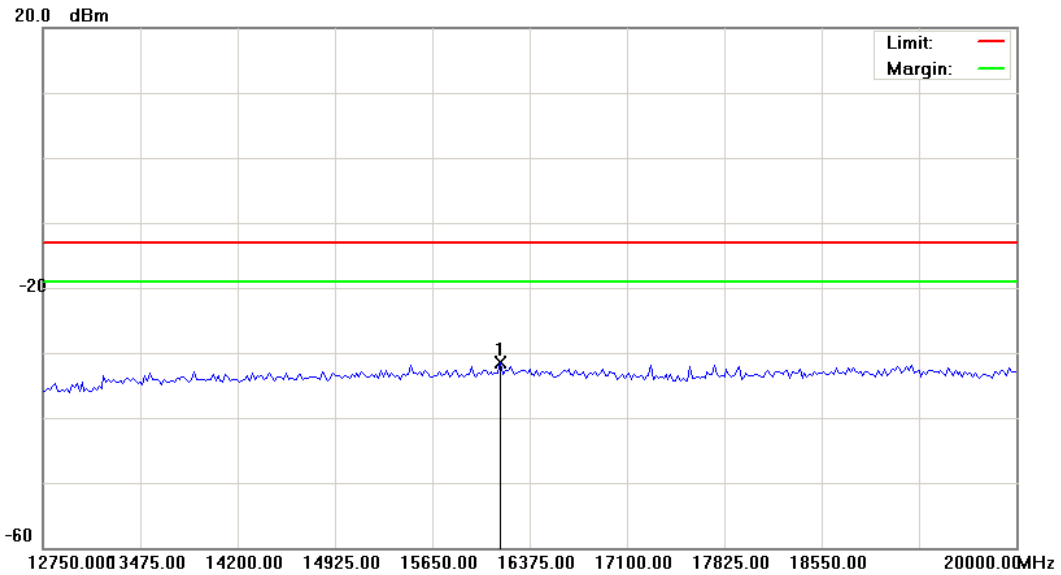

Site: : RF Conducted

 Polarization: *Conducted po*

Temperature: 23 °C

Limit: FCC Part 24 conducted(9k-12.75G)

Power: DC 3.8V

Humidity: 55.2 %

EUT: 2G/3.5G Module

Distance:

RBW: 1000 KHz VBW: 1000 KHz

M/N: HE910-NAG

Mode: 2

Note: CH 810

No.	Mk.	Freq. MHz	Reading Level dBm	Correct Factor dB	Measure- ment dBm	Limit dBm	Over dB	Antenna Height cm	Table Degree	Comment
1	*	16157.500	-37.87	6.34	-31.53	-13.00	-18.53	peak		

*:Maximum data x:Over limit !:over margin

File: HE910-NAG(CH9262)

Data :#1

Date: 2012/4/11

Time: 下午 04:46:19

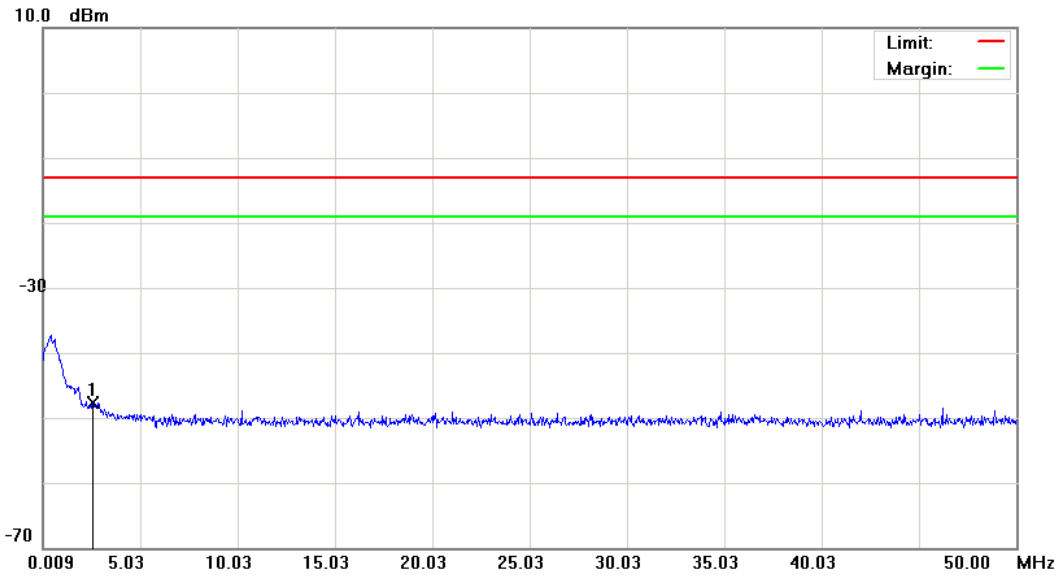

Site: : RF Conducted	Polarization: <i>Conducted po</i>	Temperature: 23 °C
Limit: FCC Part 24 conducted(9k-12.75G)	Power: DC 3.8V	Humidity: 55.2 %
EUT: 2G/3.5G Module	Distance:	RBW: 1000 KHz VBW: 1000 KHz
M/N: HE910-NAG		
Mode: 7		
Note: CH 9262		

No.	Mk.	Freq. MHz	Reading Level dBm	Correct Factor dB	Measure- ment dBm	Limit dBm	Over dB	Antenna Height cm	Table Degree	Comment
1	*	2.5583	-60.50	12.83	-47.67	-13.00	-34.67	peak		

*:Maximum data x:Over limit !:over margin

File: HE910-NAG(CH9262)

Data :#2

Date: 2012/4/11

Time: 下午 04:46:43

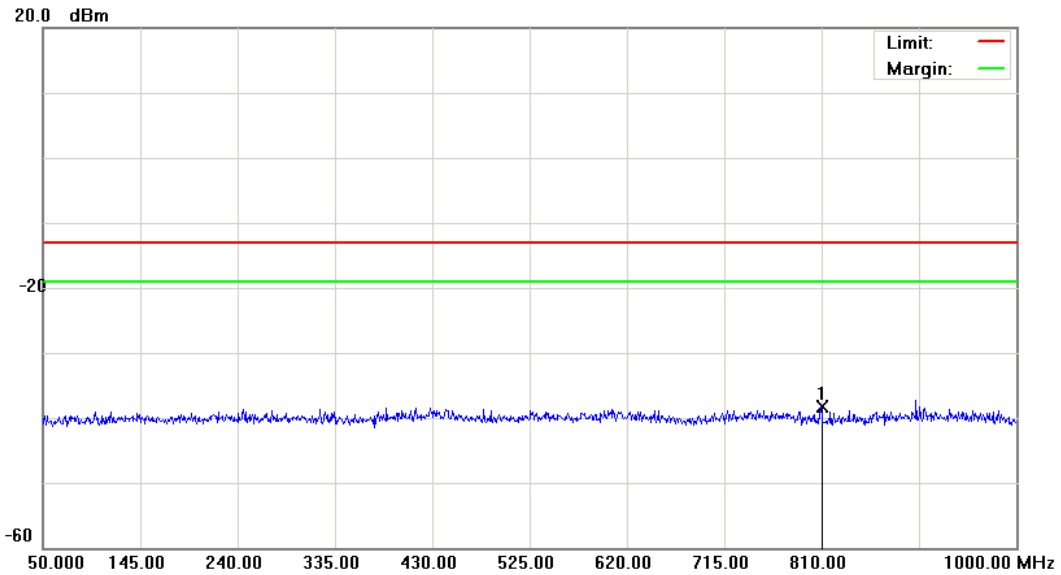

Site: : RF Conducted

 Polarization: *Conducted po*

Temperature: 23 °C

Limit: FCC Part 24 conducted(9k-12.75G)

Power: DC 3.8V

Humidity: 55.2 %

EUT: 2G/3.5G Module

Distance:

RBW: 1000 KHz VBW: 1000 KHz

M/N: HE910-NAG

Mode: 7

Note: CH 9262

No.	Mk.	Freq. MHz	Reading Level dBm	Correct Factor dB	Measure- ment dBm	Limit dBm	Over dB	Antenna Height cm	Table Degree	Comment
1	*	809.5250	-51.37	13.17	-38.20	-13.00	-25.20	peak		

*:Maximum data x:Over limit !:over margin

File: HE910-NAG(CH9262)

Data :#3

Date: 2012/4/11

Time: 下午 05:09:24

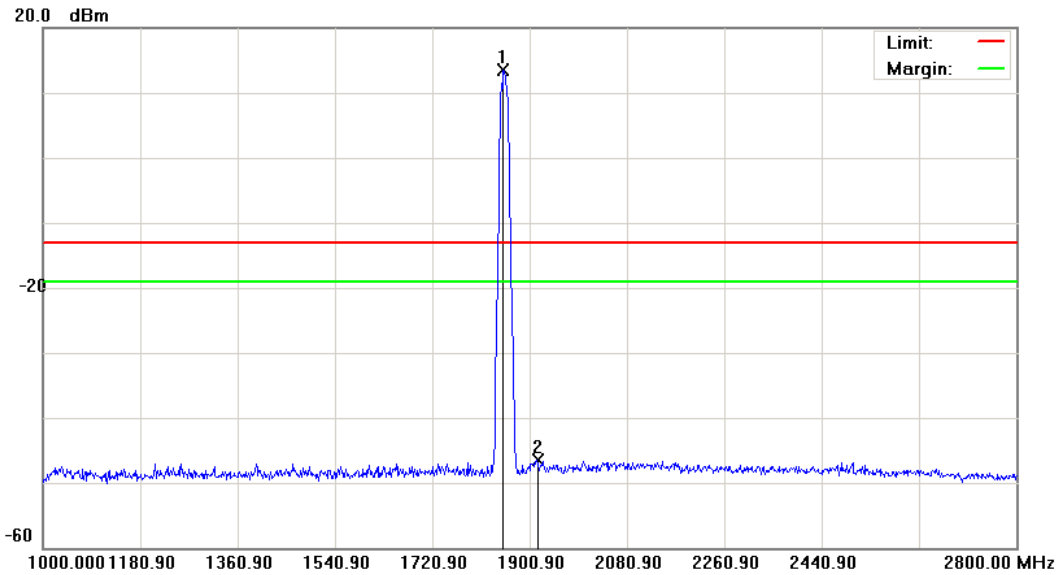

Site: : RF Conducted	Polarization: <i>Conducted po</i>	Temperature: 23 °C
Limit: FCC Part 24 conducted(9k-12.75G)	Power: DC 3.8V	Humidity: 55.2 %
EUT: 2G/3.5G Module	Distance:	RBW: 1000 KHz VBW: 1000 KHz
M/N: HE910-NAG		
Mode: 7		
Note: CH 9262		

No.	Mk.	Freq. MHz	Reading Level dBm	Correct Factor dB	Measure- ment dBm	Limit dBm	Over dB	Antenna Height cm	Table Degree	Comment
1	*	1851.400	9.23	4.26	13.49	-13.00	26.49	peak		Tx
2		1913.500	-51.95	5.38	-46.57	-13.00	-33.57	peak		

*:Maximum data x:Over limit !:over margin

File: HE910-NAG(CH9262)

Data :#4

Date: 2012/4/11

Time: 下午 05:25:58

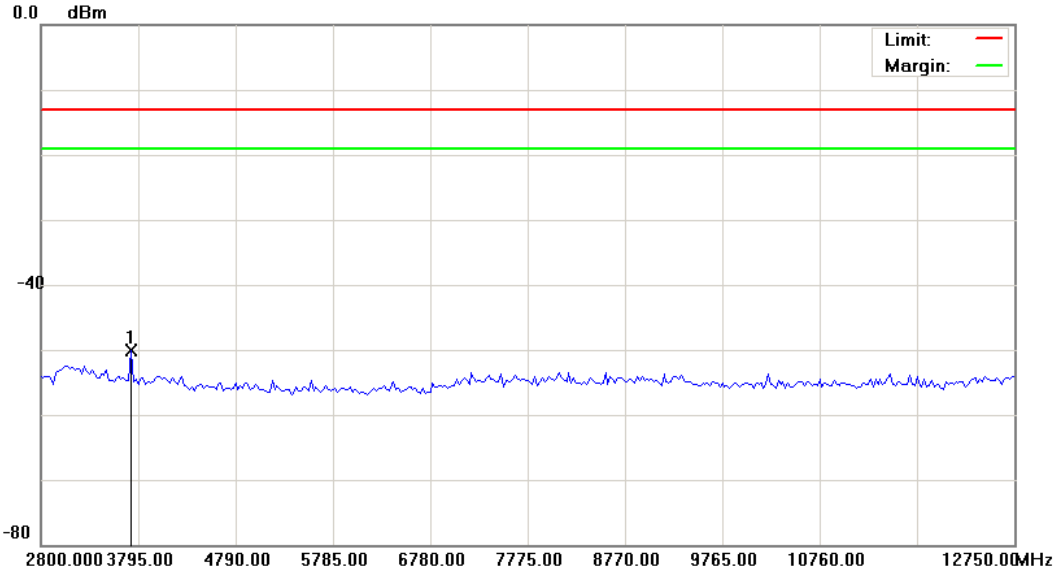

Site: : RF Conducted	Polarization: <i>Conducted po</i>	Temperature: 23 °C
Limit: FCC Part 24 conducted(9k-12.75G)	Power: DC 3.8V	Humidity: 55.2 %
EUT: 2G/3.5G Module	Distance:	RBW: 1000 KHz VBW: 1000 KHz
M/N: HE910-NAG		
Mode: 7		
Note: CH 9262		

No.	Mk.	Freq. MHz	Reading Level dBm	Correct Factor dB	Measure- ment dBm	Limit dBm	Over dB	Antenna Height cm	Table Degree	Comment
1	*	3720.375	-55.04	4.88	-50.16	-13.00	-37.16	peak		

*:Maximum data x:Over limit !:over margin

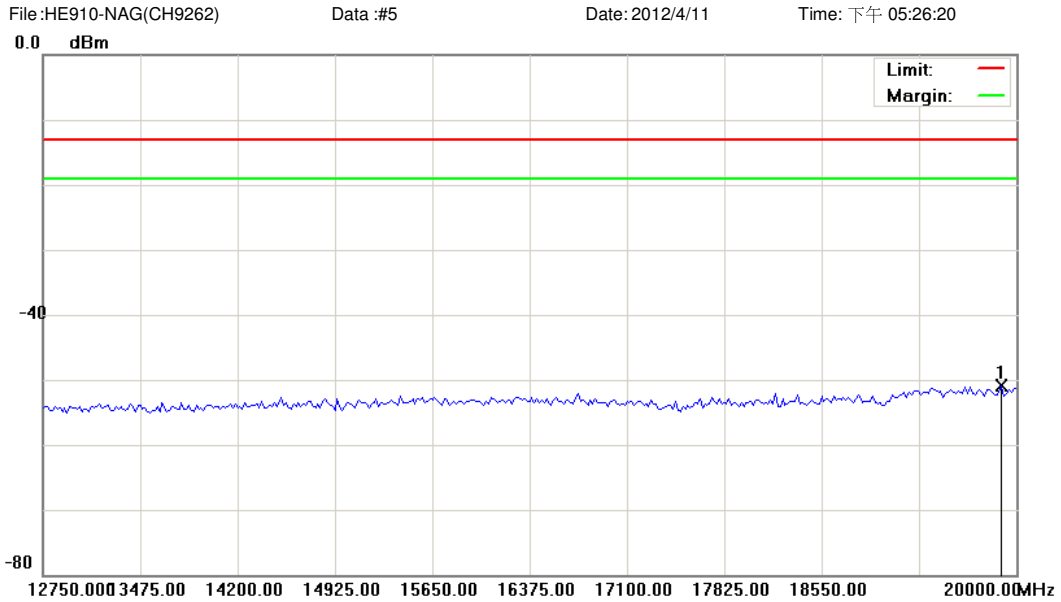

Site: : RF Conducted	Polarization: <i>Conducted po</i>	Temperature: 23 °C
Limit: FCC Part 24 conducted(9k-12.75G)	Power: DC 3.8V	Humidity: 55.2 %
EUT: 2G/3.5G Module	Distance:	RBW: 1000 KHz VBW: 1000 KHz
M/N: HE910-NAG		
Mode: 7		
Note: CH 9262		

No.	Mk.	Freq. MHz	Reading Level dBm	Correct Factor dB	Measure- ment dBm	Limit dBm	Over dB	Antenna Height cm	Table Degree	Comment
1	*	19891.250	-58.27	7.41	-50.86	-13.00	-37.86	peak		

*:Maximum data x:Over limit !:over margin

File: HE910-NAG(CH9400)

Data :#1

Date: 2012/4/11

Time: 下午 04:48:18

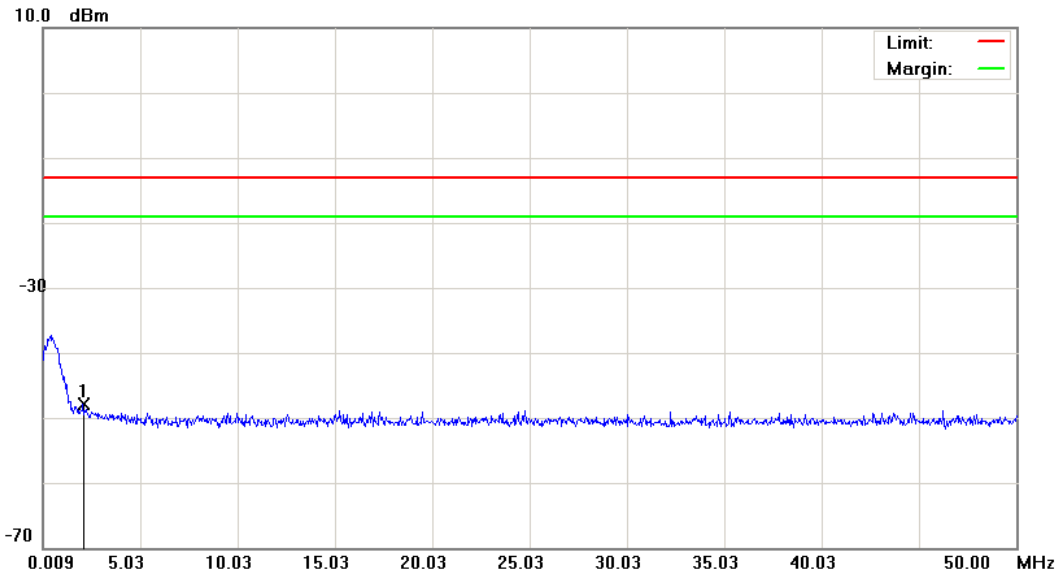

Site: : RF Conducted	Polarization: <i>Conducted po</i>	Temperature: 23 °C
Limit: FCC Part 24 conducted(9k-12.75G)	Power: DC 3.8V	Humidity: 55.2 %
EUT: 2G/3.5G Module	Distance:	RBW: 1000 kHz VBW: 1000 kHz
M/N: HE910-NAG		
Mode: 7		
Note: CH 9400		

No.	Mk.	Freq. MHz	Reading Level dBm	Correct Factor dB	Measure- ment dBm	Limit dBm	Over dB	Antenna Height cm	Table Degree	Comment
1	*	2.0836	-61.01	13.17	-47.84	-13.00	-34.84	peak		

*:Maximum data x:Over limit !:over margin

File: HE910-NAG(CH9400)

Data :#2

Date: 2012/4/11

Time: 下午 04:48:42

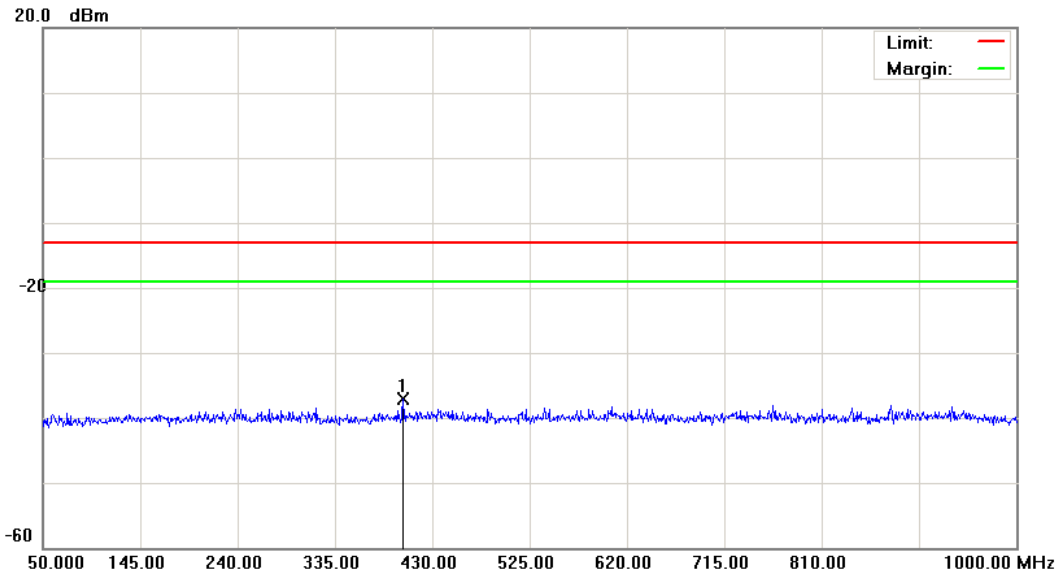

Site: : RF Conducted

 Polarization: *Conducted po*

Temperature: 23 °C

Limit: FCC Part 24 conducted(9k-12.75G)

Power: DC 3.8V

Humidity: 55.2 %

EUT: 2G/3.5G Module

Distance:

RBW: 1000 KHz VBW: 1000 KHz

M/N: HE910-NAG

Mode: 7

Note: CH 9400

No.	Mk.	Freq. MHz	Reading Level dBm	Correct Factor dB	Measure- ment dBm	Limit dBm	Over dB	Antenna Height cm	Table Degree	Comment
1	*	401.5000	-50.29	13.24	-37.05	-13.00	-24.05	peak		

*:Maximum data x:Over limit !:over margin

File: HE910-NAG(CH9400)

Data :#3

Date: 2012/4/11

Time: 下午 05:10:49

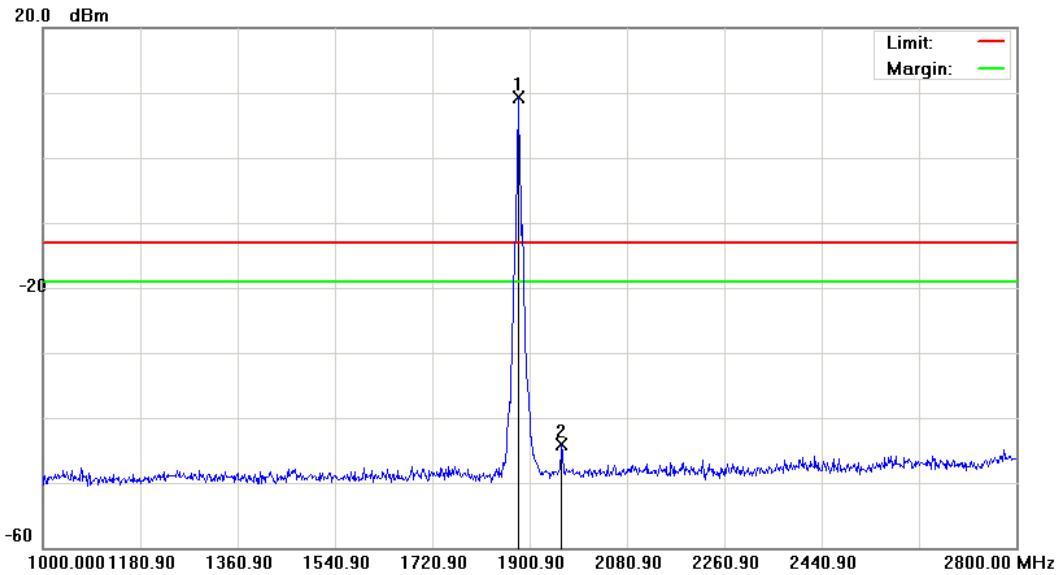

Site: : RF Conducted	Polarization: <i>Conducted po</i>	Temperature: 23 °C
Limit: FCC Part 24 conducted(9k-12.75G)	Power: DC 3.8V	Humidity: 55.2 %
EUT: 2G/3.5G Module	Distance:	RBW: 1000 KHz VBW: 1000 KHz
M/N: HE910-NAG		
Mode: 7		
Note: CH 9400		

No.	Mk.	Freq. MHz	Reading Level dBm	Correct Factor dB	Measure- ment dBm	Limit dBm	Over dB	Detector	Antenna Height cm	Table Degree	Comment
1	*	1878.400	4.64	4.61	9.25	-13.00	22.25	peak			Tx
2		1959.400	-48.75	4.73	-44.02	-13.00	-31.02	peak			

*:Maximum data x:Over limit !:over margin

File: HE910-NAG(CH9400)

Data :#4

Date: 2012/4/11

Time: 下午 05:26:54

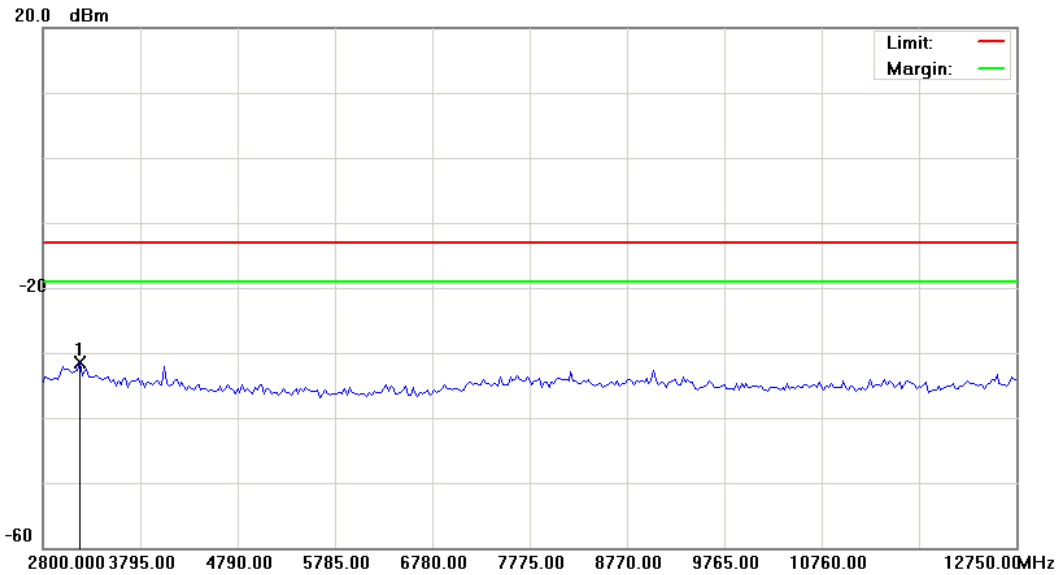

Site: : RF Conducted

 Polarization: *Conducted po*

Temperature: 23 °C

Limit: FCC Part 24 conducted(9k-12.75G)

Power: DC 3.8V

Humidity: 55.2 %

EUT: 2G/3.5G Module

Distance:

RBW: 1000 KHz VBW: 1000 KHz

M/N: HE910-NAG

Mode: 7

Note: CH 9400

No.	Mk.	Freq. MHz	Reading Level dBm	Correct Factor dB	Measure- ment dBm	Limit dBm	Over dB	Antenna Height cm	Table Degree	Comment
1	*	3173.125	-36.79	5.25	-31.54	-13.00	-18.54	peak		

*:Maximum data x:Over limit !:over margin

File: HE910-NAG(CH9400)

Data :#5

Date: 2012/4/11

Time: 下午 05:27:15

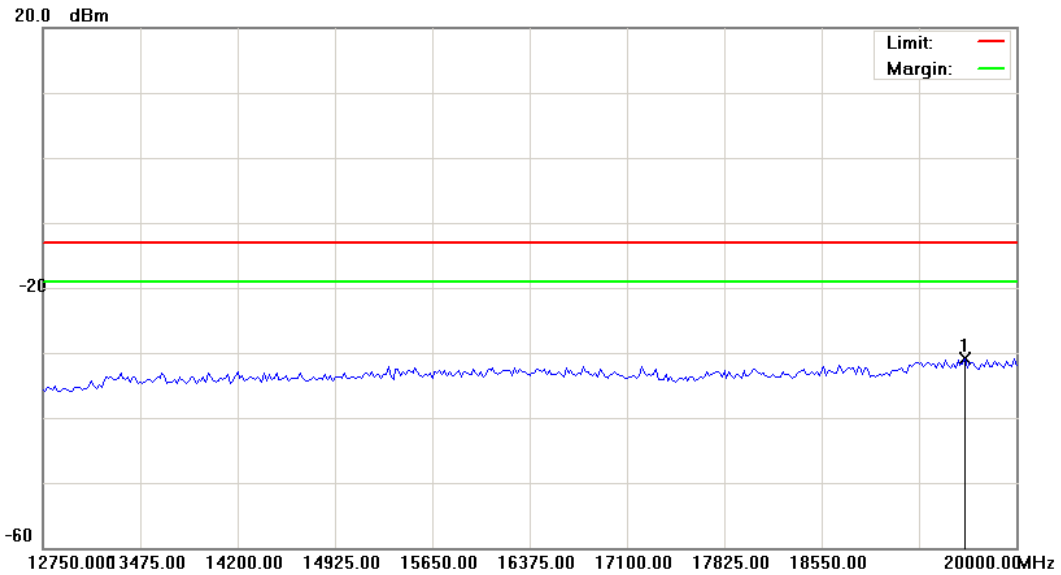

Site: : RF Conducted	Polarization: <i>Conducted po</i>	Temperature: 23 °C
Limit: FCC Part 24 conducted(9k-12.75G)	Power: DC 3.8V	Humidity: 55.2 %
EUT: 2G/3.5G Module	Distance:	RBW: 1000 KHz VBW: 1000 KHz
M/N: HE910-NAG		
Mode: 7		
Note: CH 9400		

No.	Mk.	Freq. MHz	Reading Level dBm	Correct Factor dB	Measure- ment dBm	Limit dBm	Over dB	Antenna Height cm	Table Degree	Comment
1	*	19619.375	-38.27	7.33	-30.94	-13.00	-17.94	peak		

*:Maximum data x:Over limit !:over margin

File: HE910-NAG(CH9538)

Data :#1

Date: 2012/4/11

Time: 下午 04:49:36

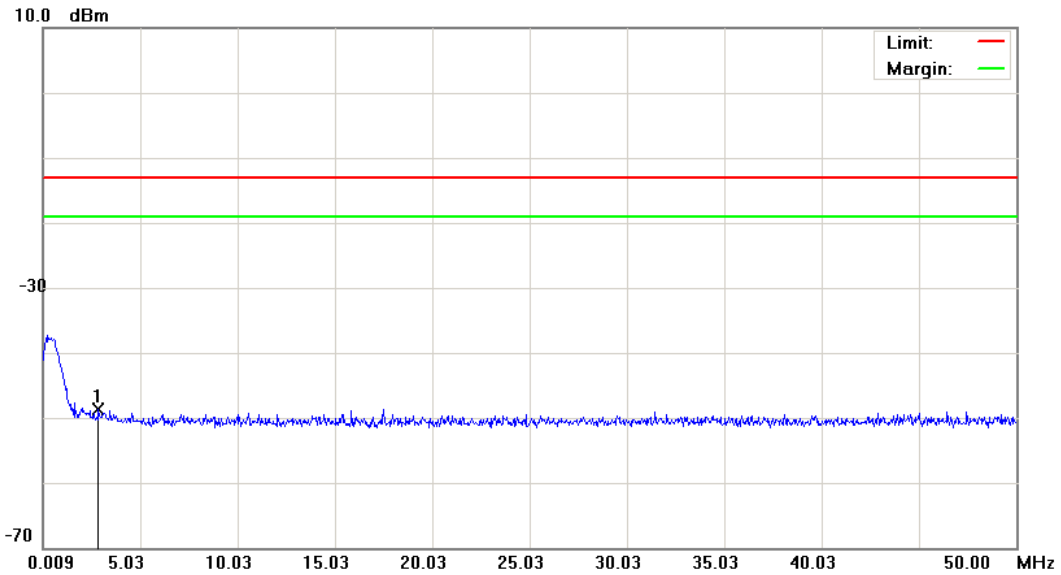

Site: : RF Conducted

 Polarization: *Conducted po*

Temperature: 23 °C

Limit: FCC Part 24 conducted(9k-12.75G)

Power: DC 3.8V

Humidity: 55.2 %

EUT: 2G/3.5G Module

Distance:

RBW: 1000 KHz VBW: 1000 KHz

M/N: HE910-NAG

Mode: 7

Note: CH 9538

No.	Mk.	Freq. MHz	Reading Level dBm	Correct Factor dB	Measure- ment dBm	Limit dBm	Over dB	Antenna Height cm	Table Degree	Comment
1	*	2.8584	-61.52	12.92	-48.60	-13.00	-35.60	peak		

*:Maximum data x:Over limit !:over margin

File: HE910-NAG(CH9538)

Data :#2

Date: 2012/4/11

Time: 下午 04:50:01

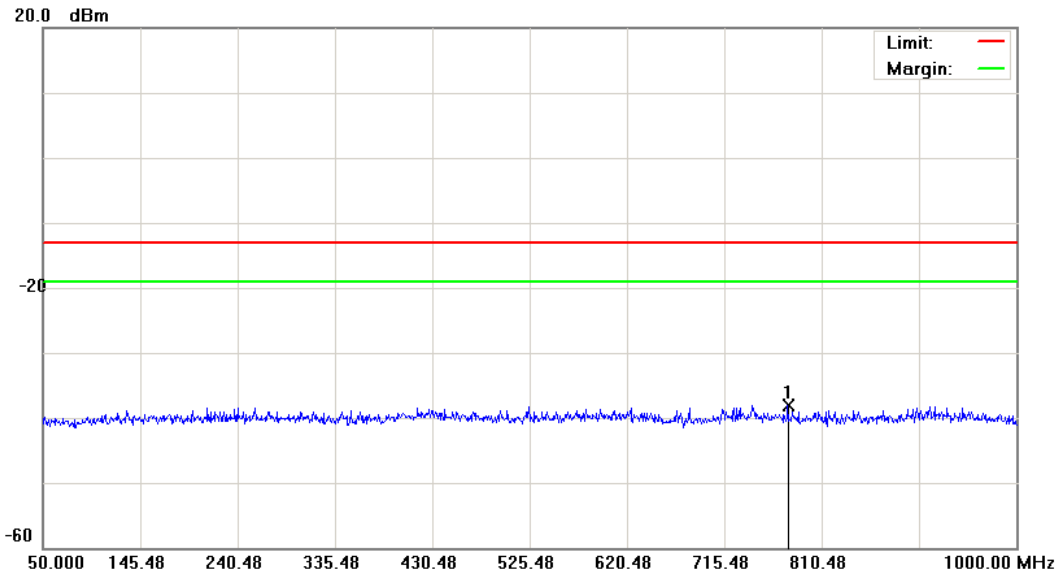

Site: : RF Conducted	Polarization: <i>Conducted po</i>	Temperature: 23 °C
Limit: FCC Part 24 conducted(9k-12.75G)	Power: DC 3.8V	Humidity: 55.2 %
EUT: 2G/3.5G Module	Distance:	RBW: 1000 KHz VBW: 1000 KHz
M/N: HE910-NAG		
Mode: 7		
Note: CH 9538		

No.	Mk.	Freq. MHz	Reading Level dBm	Correct Factor dB	Measure- ment dBm	Limit dBm	Over dB	Antenna Height cm	Table Degree	Comment
1	*	777.2250	-51.26	13.15	-38.11	-13.00	-25.11	peak		

*:Maximum data x:Over limit !:over margin

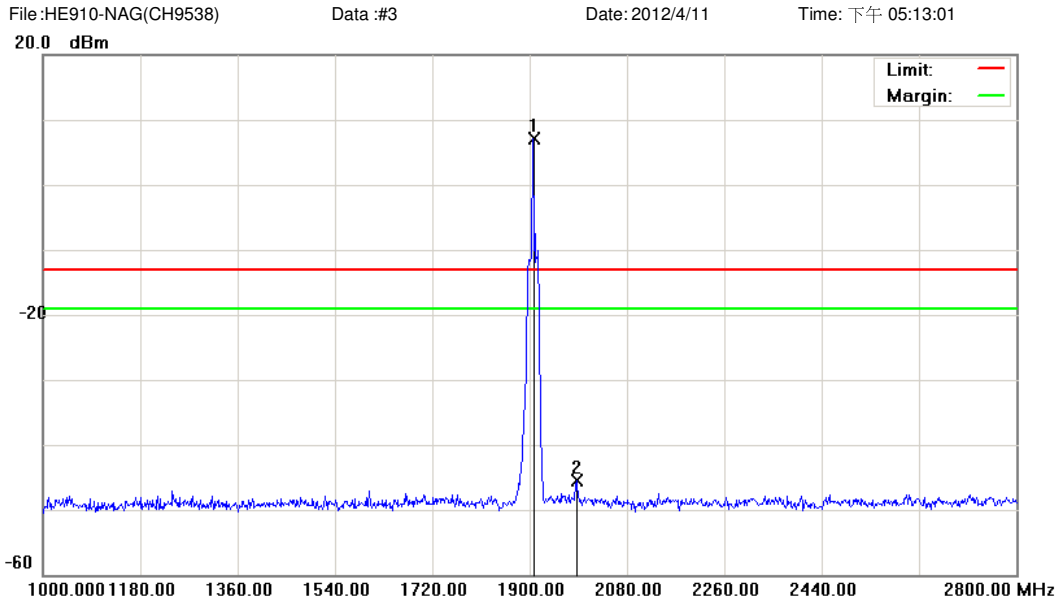

Site: : RF Conducted Polarization: *Conducted po* Temperature: 23 °C
 Limit: FCC Part 24 conducted(9k-12.75G) Power: DC 3.8V Humidity: 55.2 %
 EUT: 2G/3.5G Module Distance: RBW: 1000 KHz VBW: 1000 KHz
 M/N: HE910-NAG
 Mode: 7
 Note: CH 9538

No.	Mk.	Freq. MHz	Reading Level dBm	Correct Factor dB	Measure- ment dBm	Limit dBm	Over dB	Antenna Height cm	Table Degree	Detector	Comment
1	*	1906.300	1.03	6.05	7.08	-13.00	20.08			peak	Tx
2		1986.400	-50.16	4.69	-45.47	-13.00	-32.47			peak	

*:Maximum data x:Over limit !:over margin

File: HE910-NAG(CH9538)

Data :#4

Date: 2012/4/11

Time: 下午 05:27:49

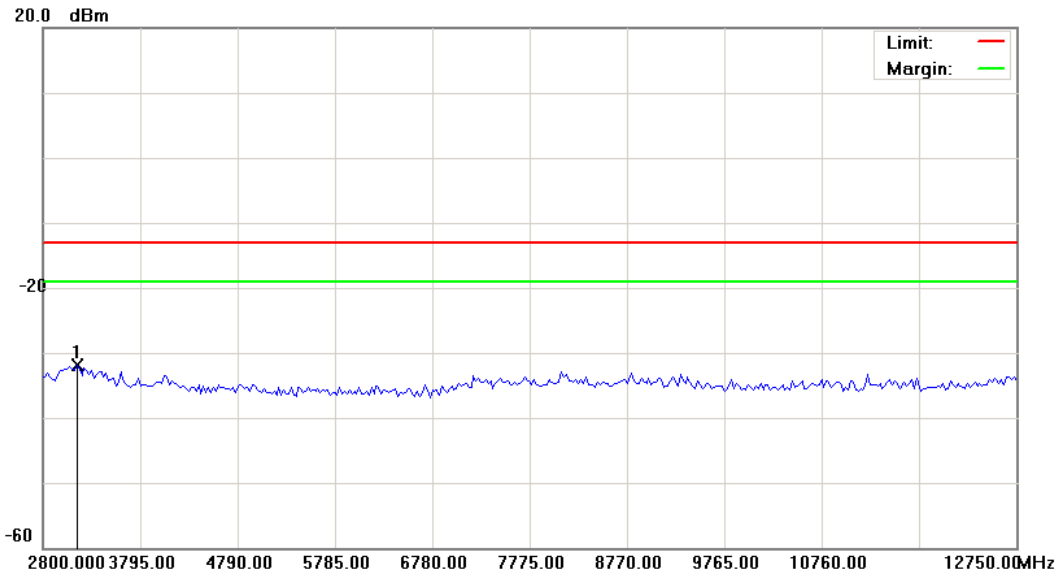

Site: : RF Conducted	Polarization: <i>Conducted po</i>	Temperature: 23 °C
Limit: FCC Part 24 conducted(9k-12.75G)	Power: DC 3.8V	Humidity: 55.2 %
EUT: 2G/3.5G Module	Distance:	RBW: 1000 KHz VBW: 1000 KHz
M/N: HE910-NAG		
Mode: 7		
Note: CH 9538		

No.	Mk.	Freq. MHz	Reading Level dBm	Correct Factor dB	Measure- ment dBm	Limit dBm	Over dB	Antenna Height cm	Table Degree	Comment
1	*	3148.250	-37.16	5.27	-31.89	-13.00	-18.89	peak		

*:Maximum data x:Over limit !:over margin

File: HE910-NAG(CH9538)

Data :#5

Date: 2012/4/11

Time: 下午 05:28:11

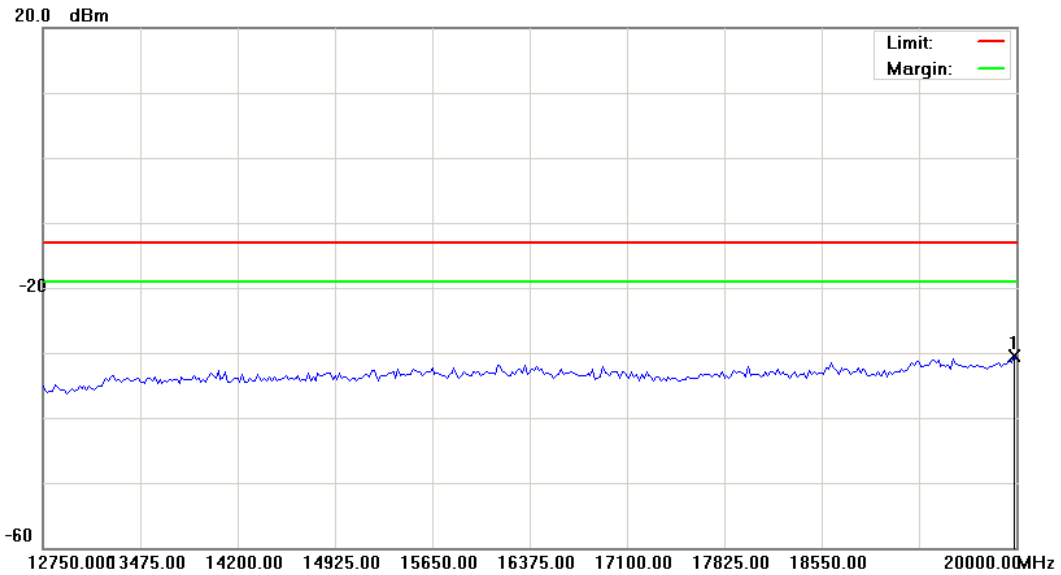

Site: : RF Conducted	Polarization: <i>Conducted po</i>	Temperature: 23 °C
Limit: FCC Part 24 conducted(9k-12.75G)	Power: DC 3.8V	Humidity: 55.2 %
EUT: 2G/3.5G Module	Distance:	RBW: 1000 KHz VBW: 1000 KHz
M/N: HE910-NAG		
Mode: 7		
Note: CH 9538		

No.	Mk.	Freq. MHz	Reading Level dBm	Correct Factor dB	Measure- ment dBm	Limit dBm	Over dB	Antenna Height cm	Table Degree	Comment
1	*	19981.875	-38.02	7.43	-30.59	-13.00	-17.59	peak		

*:Maximum data x:Over limit !:over margin

File: HE910-NAG(CH4132)

Data :#1

Date: 2012/4/11

Time: 下午 04:30:01

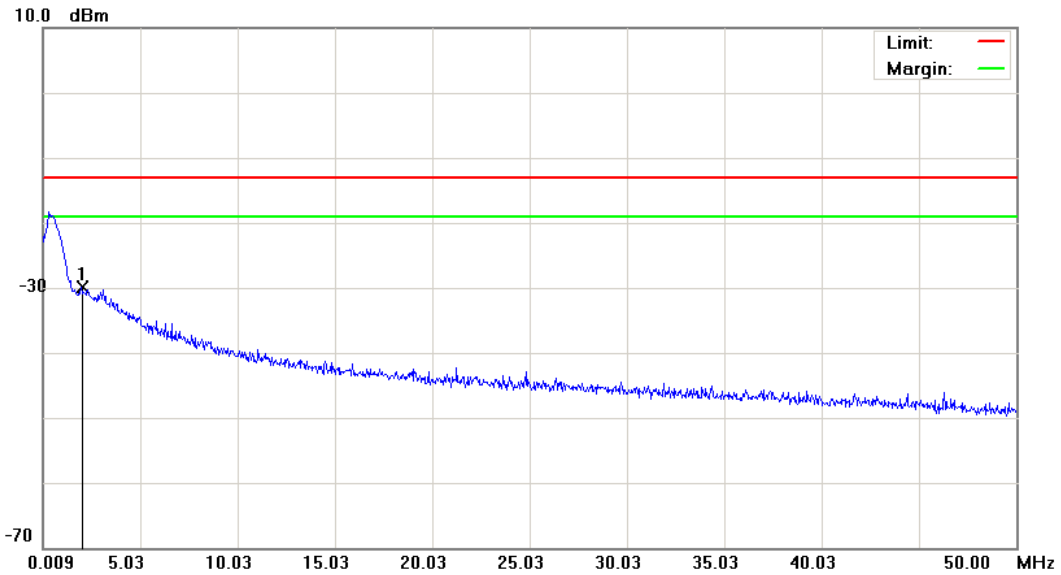

Site: : RF Conducted	Polarization: <i>Conducted po</i>	Temperature: 23 °C
Limit: FCC Part 22 conducted(9k-12.75G)	Power: DC 3.8V	Humidity: 55.2 %
EUT: 2G/3.5G Module	Distance:	RBW: 1000 KHz VBW: 1000 KHz
M/N: HE910-NAG		
Mode: 8		
Note: CH 4132		

No.	Mk.	Freq. MHz	Reading Level dBm	Correct Factor dB	Measure- ment dBm	Limit dBm	Over dB	Antenna Height cm	Table Degree	Comment
1	*	1.9836	-61.25	31.33	-29.92	-13.00	-16.92	peak		

*:Maximum data x:Over limit !:over margin

File: HE910-NAG(CH4132)

Data :#2

Date: 2012/4/11

Time: 下午 04:30:25

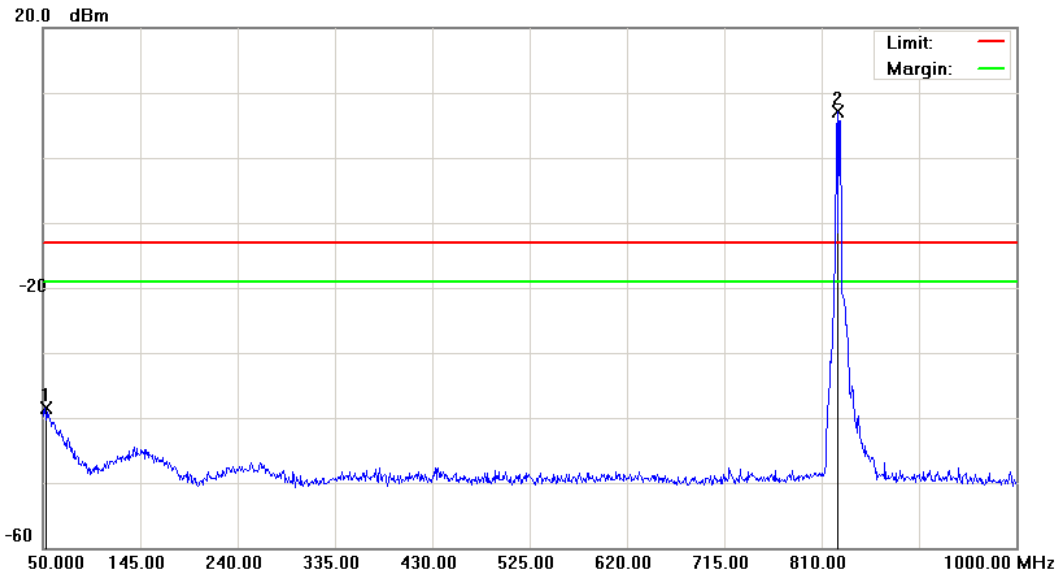

Site: : RF Conducted	Polarization: <i>Conducted po</i>	Temperature: 23 °C
Limit: FCC Part 22 conducted(9k-12.75G)	Power: DC 3.8V	Humidity: 55.2 %
EUT: 2G/3.5G Module	Distance:	RBW: 1000 kHz VBW: 1000 kHz
M/N: HE910-NAG		
Mode: 8		
Note: CH 4132		

No.	Mk.	Freq. MHz	Reading Level dBm	Correct Factor dB	Measure- ment dBm	Limit dBm	Over dB	Antenna Height cm	Table Degree degree	Comment
1		52.3750	-52.86	14.27	-38.59	-13.00	-25.59	peak		
2	*	825.2000	3.31	3.84	7.15	-13.00	20.15	peak		Tx

*:Maximum data x:Over limit !:over margin

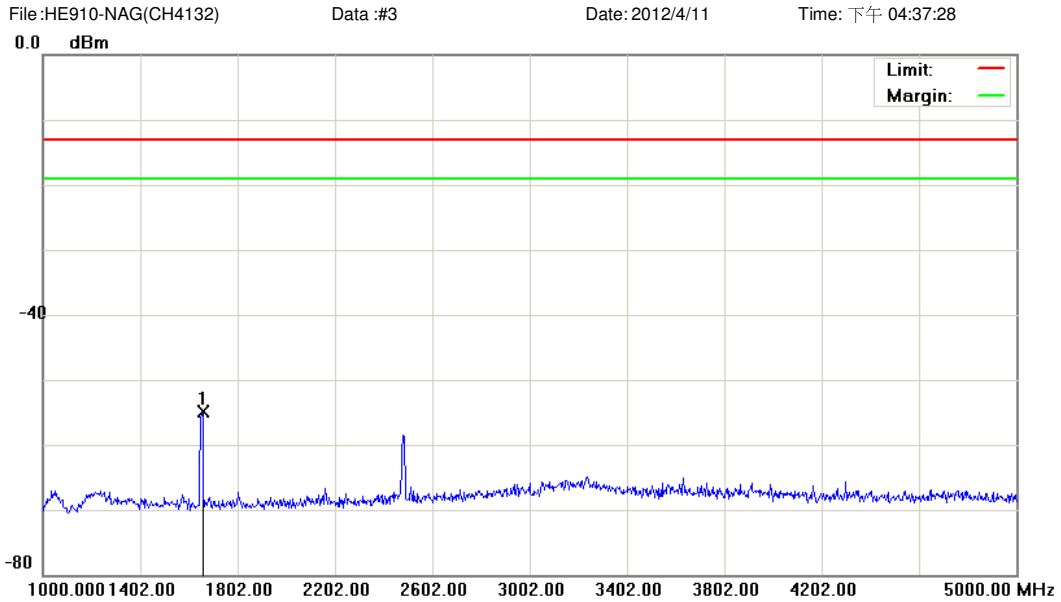

Site: : RF Conducted	Polarization: <i>Conducted po</i>	Temperature: 23 °C
Limit: FCC Part 22 conducted(9k-12.75G)	Power: DC 3.8V	Humidity: 55.2 %
EUT: 2G/3.5G Module	Distance:	RBW: 1000 KHz VBW: 1000 KHz
M/N: HE910-NAG		
Mode: 8		
Note: CH 4132		

No.	Mk.	Freq. MHz	Reading Level dBm	Correct Factor dB	Measure- ment dBm	Limit dBm	Over dB	Antenna Height cm	Table Degree	Comment
1	*	1654.000	-59.42	4.45	-54.97	-13.00	-41.97	peak		

*:Maximum data x:Over limit !:over margin

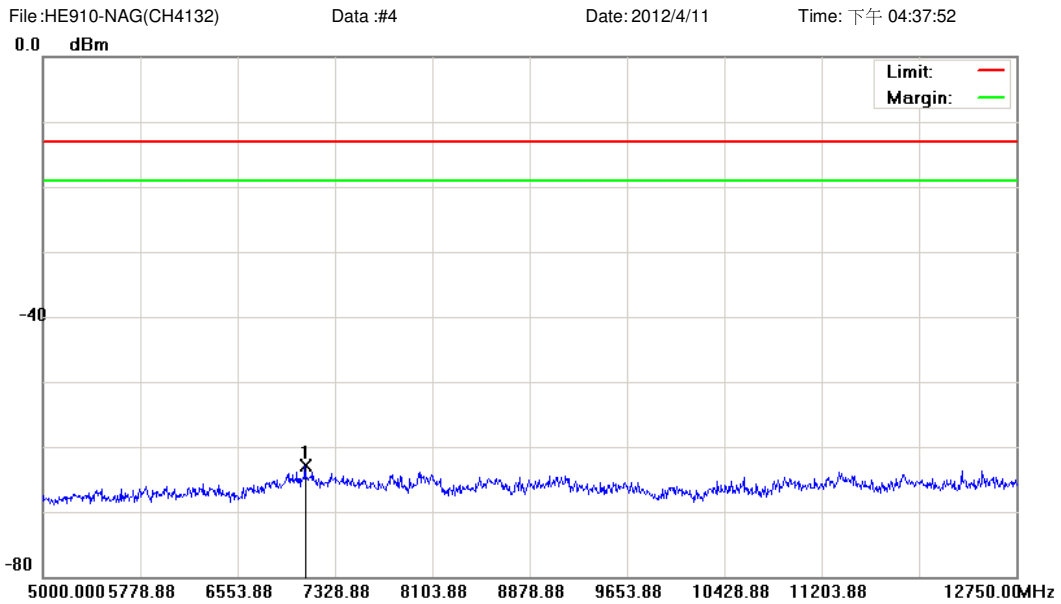

Site: : RF Conducted	Polarization: <i>Conducted po</i>	Temperature: 23 °C
Limit: FCC Part 22 conducted(9k-12.75G)	Power: DC 3.8V	Humidity: 55.2 %
EUT: 2G/3.5G Module	Distance:	RBW: 1000 KHz VBW: 1000 KHz
M/N: HE910-NAG		
Mode: 8		
Note: CH 4132		

No.	Mk.	Freq. MHz	Reading Level dBm	Correct Factor dB	Measure- ment dBm	Limit dBm	Over dB	Antenna Height cm	Table Degree	Comment
1	*	7088.625	-67.93	5.03	-62.90	-13.00	-49.90	peak		

*:Maximum data x:Over limit !:over margin

File: HE910-NAG(CH4183)

Data :#1

Date: 2012/4/11

Time: 下午 04:32:27

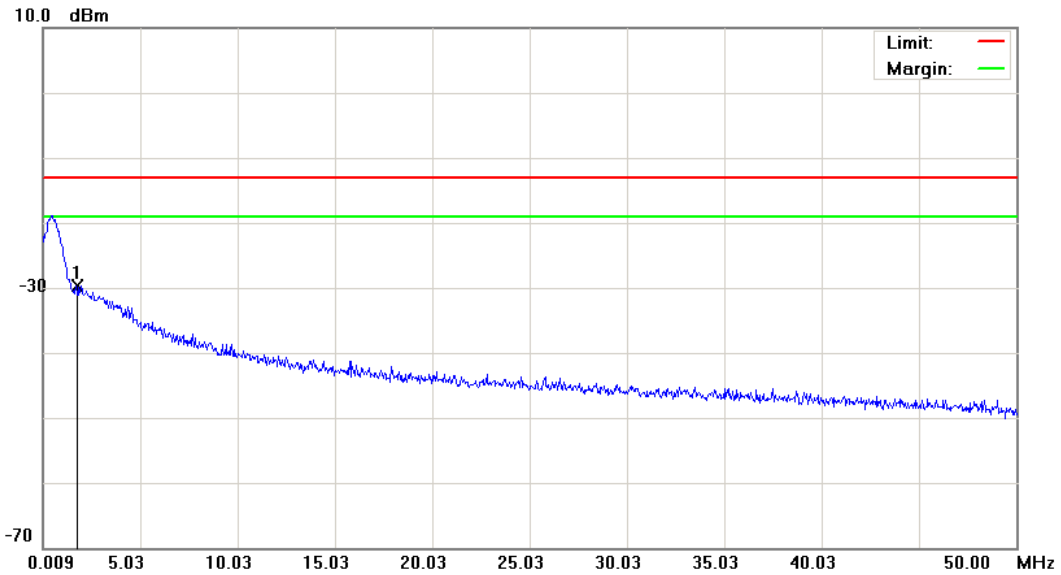

Site: : RF Conducted	Polarization: <i>Conducted po</i>	Temperature: 23 °C
Limit: FCC Part 22 conducted(9k-12.75G)	Power: DC 3.8V	Humidity: 55.2 %
EUT: 2G/3.5G Module	Distance:	RBW: 1000 KHz VBW: 1000 KHz
M/N: HE910-NAG		
Mode: 8		
Note: CH 4183		

No.	Mk.	Freq. MHz	Reading Level dBm	Correct Factor dB	Measure- ment dBm	Limit dBm	Over dB	Antenna Height cm	Table Degree	Comment
1	*	1.7337	-60.68	31.02	-29.66	-13.00	-16.66	peak		

*:Maximum data x:Over limit !:over margin

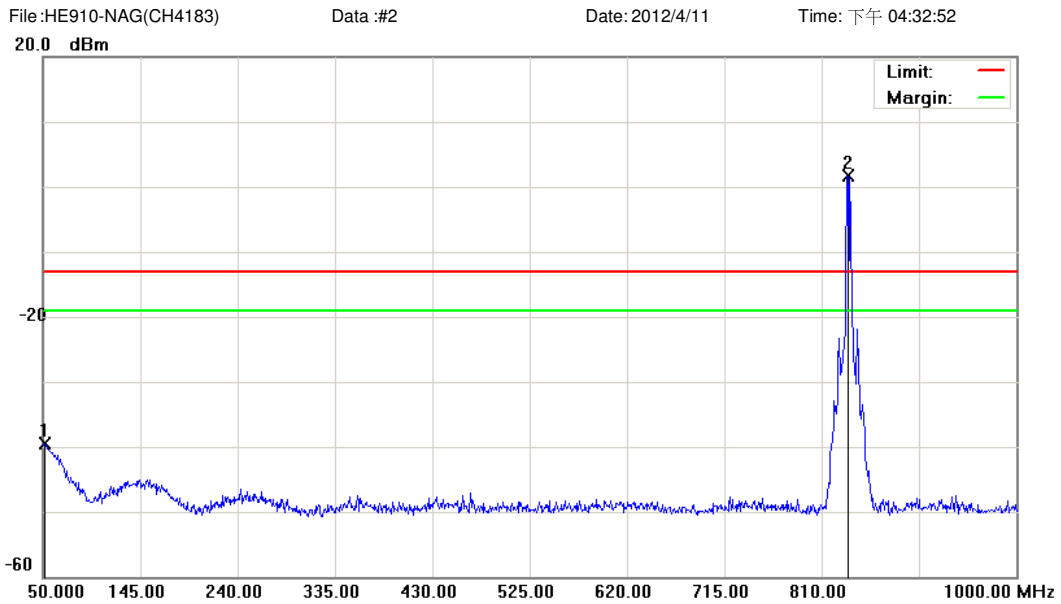

Site: : RF Conducted Polarization: *Conducted po* Temperature: 23 °C
 Limit: FCC Part 22 conducted(9k-12.75G) Power: DC 3.8V Humidity: 55.2 %
 EUT: 2G/3.5G Module Distance: RBW: 1000 kHz VBW: 1000 kHz
 M/N: HE910-NAG
 Mode: 8
 Note: CH 4183

No.	Mk.	Freq. MHz	Reading Level dBm	Correct Factor dB	Measure- ment dBm	Limit dBm	Over dB	Antenna Height cm	Table Degree	Comment
1		51.4250	-53.89	14.44	-39.45	-13.00	-26.45	peak		
2	*	835.1750	-2.19	3.95	1.76	-13.00	14.76	peak		Tx

*:Maximum data x:Over limit !:over margin

File: HE910-NAG(CH4183)

Data :#3

Date: 2012/4/11

Time: 下午 04:38:28

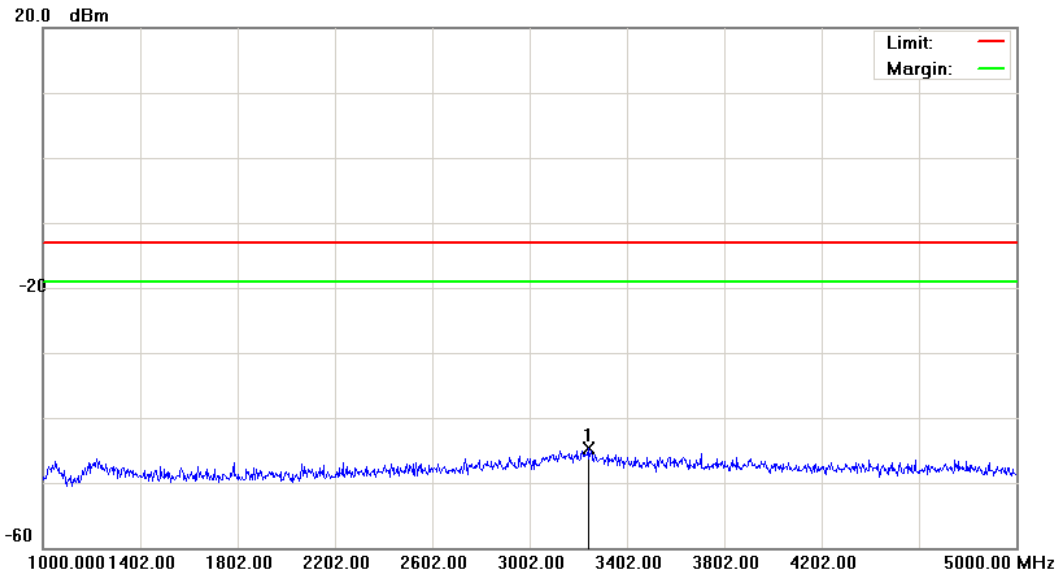

Site: : RF Conducted

 Polarization: *Conducted po*

Temperature: 23 °C

Limit: FCC Part 22 conducted(9k-12.75G)

Power: DC 3.8V

Humidity: 55.2 %

EUT: 2G/3.5G Module

Distance:

RBW: 1000 KHz VBW: 1000 KHz

M/N: HE910-NAG

Mode: 8

Note: CH 4183

No.	Mk.	Freq. MHz	Reading Level dBm	Correct Factor dB	Measure- ment dBm	Limit dBm	Over dB	Antenna Height cm	Table Degree	Comment
1	*	3242.000	-49.45	4.69	-44.76	-13.00	-31.76	peak		

*:Maximum data x:Over limit !:over margin

File: HE910-NAG(CH4183)

Data :#4

Date: 2012/4/11

Time: 下午 04:38:52

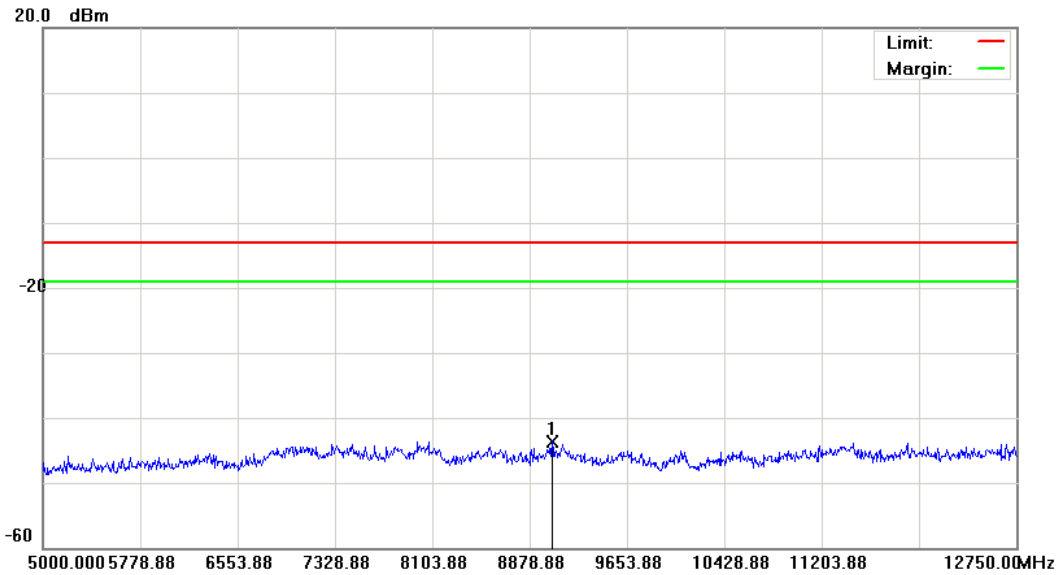

Site: : RF Conducted

 Polarization: *Conducted po*

Temperature: 23 °C

Limit: FCC Part 22 conducted(9k-12.75G)

Power: DC 3.8V

Humidity: 55.2 %

EUT: 2G/3.5G Module

Distance:

RBW: 1000 KHz VBW: 1000 KHz

M/N: HE910-NAG

Mode: 8

Note: CH 4183

No.	Mk.	Freq. MHz	Reading Level dBm	Correct Factor dB	Measure- ment dBm	Limit dBm	Over dB	Detector	Antenna Height cm	Table Degree	Comment
1	*	9053.250	-49.01	5.41	-43.60	-13.00	-30.60	peak			

*:Maximum data x:Over limit !:over margin

File: HE910-NAG(CH4233)

Data :#1

Date: 2012/4/11

Time: 下午 04:33:59

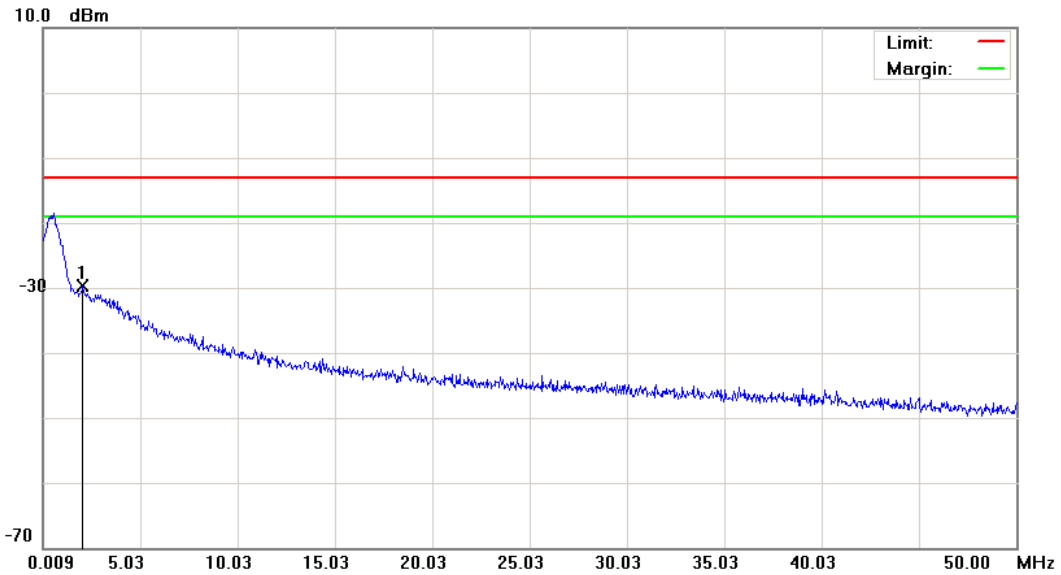

Site: : RF Conducted	Polarization: <i>Conducted po</i>	Temperature: 23 °C
Limit: FCC Part 22 conducted(9k-12.75G)	Power: DC 3.8V	Humidity: 55.2 %
EUT: 2G/3.5G Module	Distance:	RBW: 1000 kHz VBW: 1000 kHz
M/N: HE910-NAG		
Mode: 8		
Note: CH 4233		

No.	Mk.	Freq. MHz	Reading Level dBm	Correct Factor dB	Measure- ment dBm	Limit dBm	Over dB	Antenna Height cm	Table Degree	Comment
1	*	2.0586	-61.20	31.45	-29.75	-13.00	-16.75	peak		

*:Maximum data x:Over limit !:over margin

File: HE910-NAG(CH4233)

Data :#2

Date: 2012/4/11

Time: 下午 04:34:24

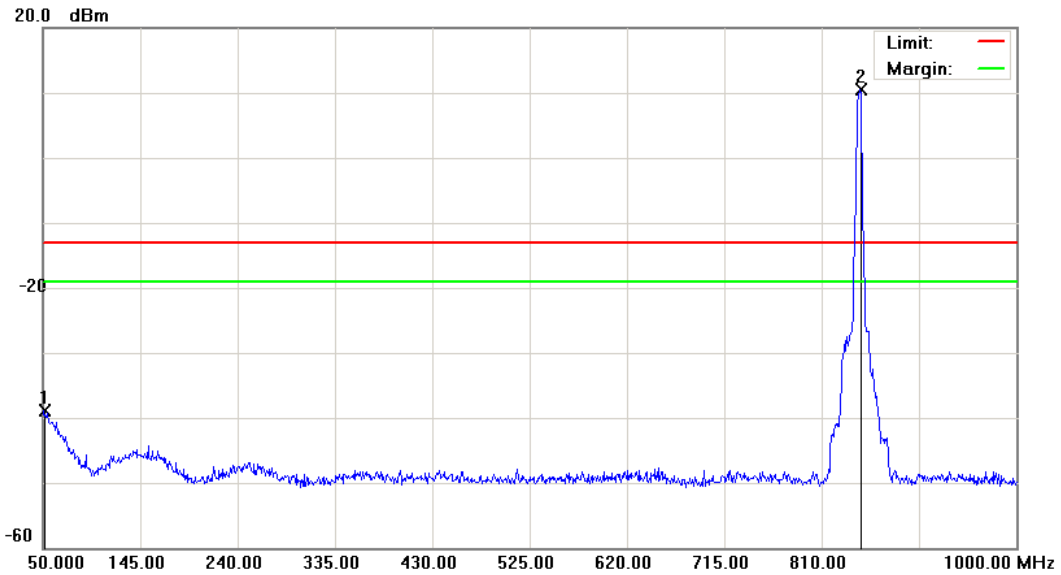

Site: : RF Conducted	Polarization: <i>Conducted po</i>	Temperature: 23 °C
Limit: FCC Part 22 conducted(9k-12.75G)	Power: DC 3.8V	Humidity: 55.2 %
EUT: 2G/3.5G Module	Distance:	RBW: 1000 KHz VBW: 1000 KHz
M/N: HE910-NAG		
Mode: 8		
Note: CH 4233		

No.	Mk.	Freq. MHz	Reading Level dBm	Correct Factor dB	Measure- ment dBm	Limit dBm	Over dB	Antenna Height cm	Table Degree	Comment
1		51.4250	-53.32	14.44	-38.88	-13.00	-25.88	peak		
2	*	847.5250	6.43	3.98	10.41	-13.00	23.41	peak		Tx

*:Maximum data x:Over limit !:over margin

File: HE910-NAG(CH4233)

Data :#3

Date: 2012/4/11

Time: 下午 04:39:52

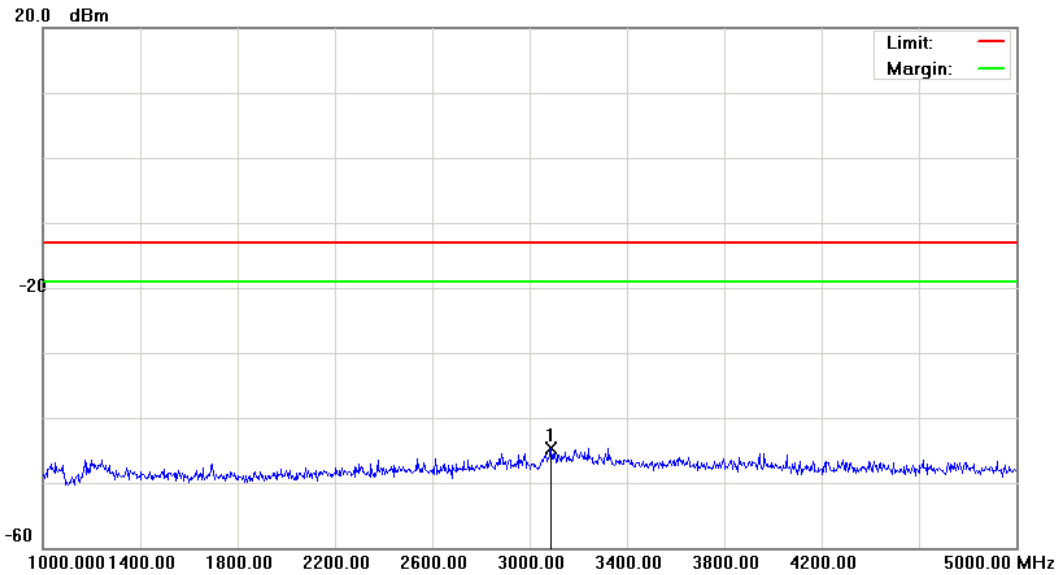

Site: : RF Conducted	Polarization: <i>Conducted po</i>	Temperature: 23 °C
Limit: FCC Part 22 conducted(9k-12.75G)	Power: DC 3.8V	Humidity: 55.2 %
EUT: 2G/3.5G Module	Distance:	RBW: 1000 KHz VBW: 1000 KHz
M/N: HE910-NAG		
Mode: 8		
Note: CH 4233		

No.	Mk.	Freq. MHz	Reading Level dBm	Correct Factor dB	Measure- ment dBm	Limit dBm	Over dB	Antenna Height cm	Table Degree	Comment
1	*	3088.000	-49.19	4.50	-44.69	-13.00	-31.69	peak		

*:Maximum data x:Over limit !:over margin

File: HE910-NAG(CH4233)

Data :#4

Date: 2012/4/11

Time: 下午 04:40:15

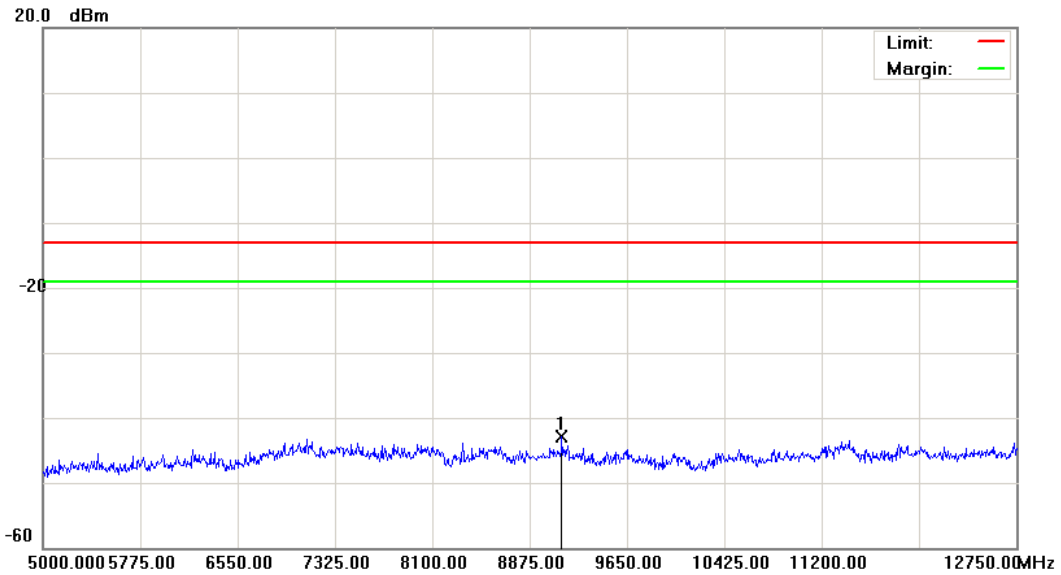

Site: : RF Conducted

 Polarization: *Conducted po*

Temperature: 23 °C

Limit: FCC Part 22 conducted(9k-12.75G)

Power: DC 3.8V

Humidity: 55.2 %

EUT: 2G/3.5G Module

Distance:

RBW: 1000 KHz VBW: 1000 KHz

M/N: HE910-NAG

Mode: 8

Note: CH 4233

No.	Mk.	Freq. MHz	Reading Level dBm	Correct Factor dB	Measure- ment dBm	Limit dBm	Over dB	Detector	Antenna Height cm	Table Degree	Comment
1	*	9130.750	-48.78	5.85	-42.93	-13.00	-29.93	peak			

*:Maximum data x:Over limit !:over margin

6 Field Strength of Spurious Radiation Test

6.1. Limit

The power of any emission outside of the authorized operating frequency ranges must be attenuated below the transmitting power (P) by a factor of at least $43 + 10\log(P)$ dB.

It is measured by means of a calibrated spectrum analyzer and scanned from 30 MHz up to a frequency including its 10th harmonic.

6.2. Test Instruments

3 Meter Chamber					
Equipment	Manufacturer	Model Number	Serial Number	Cal. Date	Remark
RF Pre-selector	Agilent	N9039A	MY46520256	01/16/2012	(2)
Spectrum Analyzer	Agilent	E4446A	MY46180578	01/16/2012	(1)
Pre Amplifier	Agilent	8449B	3008A02237	02/22/2012	(1)
Pre Amplifier	Agilent	8447D	2944A10961	02/22/2012	(1)
Broadband Antenna (30MHz~1GHz)	SCHWARZBECK MESS-ELEKTRONIK	VULB9163	9163-270	07/29/2011	(1)
Horn Antenna (1~18GHz)	SCHWARZBECK MESS-ELEKTRONIK	BBHA9120D	9120D-550	06/29/2011	(1)
Horn Antenna (18~40GHz)	SCHWARZBECK MESS-ELEKTRONIK	BBHA9170	9170-320	06/28/2011	(1)
Test Site	ATL	TE01	888001	12/20/2011	(1)

Remark: ⁽¹⁾ Calibration period 1 year. ⁽²⁾ Calibration period 2 years.

Note: N.C.R. = No Calibration Request.

6.3. Setup

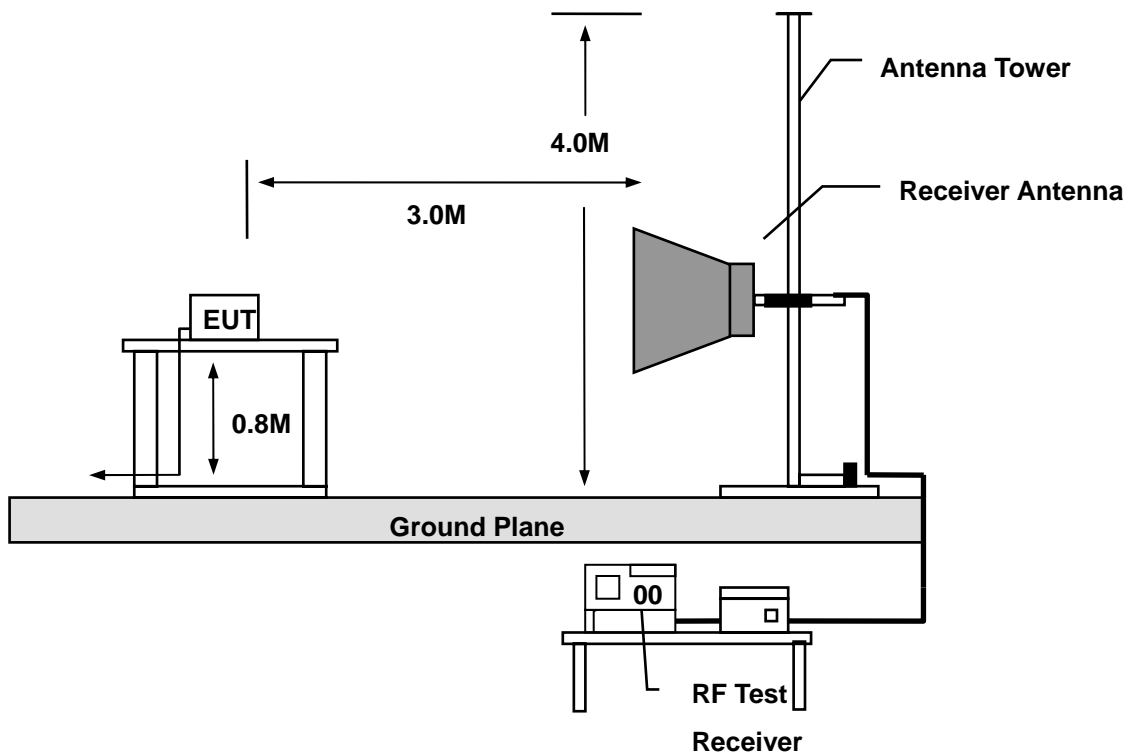

6.4. Test Procedure

Final radiation measurements were made on a three-meter, Semi Anechoic Chamber. The EUT system was placed on a nonconductive turntable which is 0.8 meters height, top surface 1.0 x 1.5 meter. The spectrum was examined from 250 MHz to 2.5 GHz in order to cover the whole spectrum below 10th harmonic which could generate from the EUT. During the test, EUT was set to transmit continuously & Measurements spectrum range from 30 MHz to 26.5 GHz is investigated.

For measurements below 1 GHz the resolution bandwidth is set to 100 kHz for peak detection measurements or 120 kHz for quasi-peak detection measurements. Peak detection is used unless otherwise noted as quasi-peak.

For measurements above 1 GHz the resolution bandwidth is set to 1 MHz, and then the video bandwidth is set to 1 MHz for peak measurements and 10 Hz for average measurements.

A nonconductive material surrounded the EUT to supporting the EUT for standing on three orthogonal planes. At each condition, the EUT was rotated 360 degrees, and the antenna was raised and lowered from one to four meters to find the maximum emission levels. Measurements were taken using both horizontal and vertical antenna polarization.

SCHWARZBECK MESS-ELEKTRONIK Biconilog Antenna (mode VULB9163) at 3 Meter and the SCHWARZBECK Double Ridged Guide Antenna (model BBHA9120D&9170) was used in frequencies 1 – 26.5 GHz at a distance of 1 meter. All test results were extrapolated to equivalent signal at 3 meters utilizing an inverse linear distance extrapolation Factor (20dB/decade).

For testing above 1GHz, the emission level of the EUT in peak mode was 20dB lower than average limit (that means the emission level in peak mode also complies with the limit in average mode), then testing will be stopped and peak values of EUT will be reported, otherwise, the emissions will be measured in average mode again and reported.

Appropriate preamplifiers were used for improving sensitivity and precautions were taken to avoid overloading or desensitizing the spectrum analyzer. No post – detector video filters were used in the test. The spectrum analyzer's 6 dB bandwidth was set to 1 MHz, and the analyzer was operated in the peak detection mode, for frequencies both below and up 1 GHz. The average levels were obtained by subtracting the duty cycle correction factor from the peak readings.

The following procedures were used to convert the emission levels measured in decibels referenced to 1 microvolt (dBuV) into field intensity in micro volts per meter (uV/m).

The actual field intensity in decibels referenced to 1 microvolt in to field intensity in micro volts per meter (dBuV/m).

The actual field intensity in decibels referenced to 1 microvolt per meter (dBuV/m) is determined by algebraically adding the measured reading in dBuV, the antenna factor (dB), and cable loss (dB) and subtracting the gain of preamplifier (dB) is auto calculate in spectrum analyzer.

$$(1) \text{ Amplitude (dBuV/m) = FI (dBuV) +AF (dBuV) +CL (dBuV)-Gain (dB)}$$

FI= Reading of the field intensity.

AF= Antenna factor.

CL= Cable loss.

P.S Amplitude is auto calculate in spectrum analyzer.

$$(2) \text{ Actual Amplitude (dBuV/m) = Amplitude (dBuV)-Dis(dB)}$$

The FCC specified emission limits were calculated according the EUT operating frequency and by following linear interpolation equations:

(a) For fundamental frequency : Transmitter Output < +30dBm

(b) For spurious frequency : Spurious emission limits = fundamental emission limit /10

6.5. Uncertainty

The measurement uncertainty is defined as for Field Strength of Spurious Radiation measurement is ± 3.072 dB.

6.6. Test Result

Standard:	FCC Part 22	Test Distance:	3m
Test item:	Radiated Emission	Power:	DC 3.8V
Model Number:	HE910-NAG	Temp.(°C)/Hum.(%RH):	23.0(°C)/55.2%RH
Mode:	1	Date:	04/12/2012
Frequency:	824.2 MHz	Test By:	Fly Lu

Frequency (MHz)	Reading (dBm)	Correct Factor (dB)	Result (dBm)	Limit (dBm)	Margin (dB)	Remark	Ant.Polar. H / V
96.5000	-62.50	-1.16	-63.66	-13.00	-50.66	peak	H
300.0000	-60.65	-2.36	-63.01	-13.00	-50.01	peak	H
398.5000	-62.48	2.41	-60.07	-13.00	-47.07	peak	H
587.0000	-71.54	7.72	-63.82	-13.00	-50.82	peak	H
772.0000	-76.40	9.74	-66.66	-13.00	-53.66	peak	H
940.0000	-75.84	14.86	-60.98	-13.00	-47.98	peak	H
3088.000	-68.04	14.22	-53.82	-13.00	-40.82	peak	H
5752.000	-70.96	22.37	-48.59	-13.00	-35.59	peak	H
7960.000	-71.17	29.58	-41.59	-13.00	-28.59	peak	H
131.5000	-68.34	13.57	-54.77	-13.00	-41.77	peak	V
215.0000	-63.15	7.11	-56.04	-13.00	-43.04	peak	V
399.0000	-55.92	1.35	-54.57	-13.00	-41.57	peak	V
587.0000	-68.01	6.46	-61.55	-13.00	-48.55	peak	V
720.0000	-76.52	10.86	-65.66	-13.00	-52.66	peak	V
972.0000	-77.31	12.46	-64.85	-13.00	-51.85	peak	V
3808.000	-69.39	20.18	-49.21	-13.00	-36.21	peak	V
5908.000	-72.06	22.88	-49.18	-13.00	-36.18	peak	V
7864.000	-71.74	26.39	-45.35	-13.00	-32.35	peak	V

Standard:	FCC Part 22	Test Distance:	3m
Test item:	Radiated Emission	Power:	DC 3.8V
Model Number:	HE910-NAG	Temp.(°C)/Hum.(%RH):	23.0(°C)/55.2%RH
Mode:	1	Date:	04/12/2012
Frequency:	836.4 MHz	Test By:	Fly Lu

Frequency (MHz)	Reading (dBm)	Correct Factor (dB)	Result (dBm)	Limit (dBm)	Margin (dB)	Remark	Ant.Polar. H / V
96.5000	-62.72	-1.16	-63.88	-13.00	-50.88	peak	H
215.0000	-55.54	0.06	-55.48	-13.00	-42.48	peak	H
398.5000	-62.11	2.41	-59.70	-13.00	-46.70	peak	H
558.5000	-70.60	7.83	-62.77	-13.00	-49.77	peak	H
705.5000	-77.91	7.10	-70.81	-13.00	-57.81	peak	H
970.0000	-79.10	14.58	-64.52	-13.00	-51.52	peak	H
3544.000	-69.39	15.57	-53.82	-13.00	-40.82	peak	H
5824.000	-71.18	22.57	-48.61	-13.00	-35.61	peak	H
7888.000	-71.62	29.51	-42.11	-13.00	-29.11	peak	H
131.5000	-70.19	13.57	-56.62	-13.00	-43.62	peak	V
215.0000	-61.99	7.11	-54.88	-13.00	-41.88	peak	V
399.0000	-56.16	1.35	-54.81	-13.00	-41.81	peak	V
530.0000	-65.53	3.68	-61.85	-13.00	-48.85	peak	V
673.0000	-75.10	9.50	-65.60	-13.00	-52.60	peak	V
933.5000	-77.85	12.45	-65.40	-13.00	-52.40	peak	V
3808.000	-69.16	20.18	-48.98	-13.00	-35.98	peak	V
5956.000	-71.14	22.82	-48.32	-13.00	-35.32	peak	V
7900.000	-71.54	26.38	-45.16	-13.00	-32.16	peak	V

Standard:	FCC Part 22	Test Distance:	3m
Test item:	Radiated Emission	Power:	DC 3.8V
Model Number:	HE910-NAG	Temp.(°C)/Hum.(%RH):	23.0(°C)/55.2%RH
Mode:	1	Date:	04/12/2012
Frequency:	848.8 MHz	Test By:	Fly Lu

Frequency (MHz)	Reading (dBm)	Correct Factor (dB)	Result (dBm)	Limit (dBm)	Margin (dB)	Remark	Ant.Polar. H / V
120.0000	-61.05	-5.42	-66.47	-13.00	-53.47	peak	H
220.0000	-62.74	-0.52	-63.26	-13.00	-50.26	peak	H
398.5000	-61.96	2.41	-59.55	-13.00	-46.55	peak	H
563.0000	-75.74	7.77	-67.97	-13.00	-54.97	peak	H
799.5000	-72.28	11.22	-61.06	-13.00	-48.06	peak	H
953.0000	-76.72	14.84	-61.88	-13.00	-48.88	peak	H
2884.000	-68.74	13.53	-55.21	-13.00	-42.21	peak	H
5452.000	-72.17	21.54	-50.63	-13.00	-37.63	peak	H
7648.000	-71.44	29.32	-42.12	-13.00	-29.12	peak	H
130.5000	-71.04	14.10	-56.94	-13.00	-43.94	peak	V
215.0000	-62.71	7.11	-55.60	-13.00	-42.60	peak	V
398.0000	-55.54	1.36	-54.18	-13.00	-41.18	peak	V
530.0000	-65.16	3.68	-61.48	-13.00	-48.48	peak	V
701.5000	-74.08	10.24	-63.84	-13.00	-50.84	peak	V
940.0000	-76.48	12.74	-63.74	-13.00	-50.74	peak	V
3580.000	-69.11	19.68	-49.43	-13.00	-36.43	peak	V
5920.000	-71.28	22.87	-48.41	-13.00	-35.41	peak	V
7876.000	-71.47	26.39	-45.08	-13.00	-32.08	peak	V

Standard:	FCC Part 22	Test Distance:	3m
Test item:	Radiated Emission	Power:	DC 3.8V
Model Number:	HE910-NAG	Temp.(°C)/Hum.(%RH):	23.0(°C)/55.2%RH
Mode:	2	Date:	04/12/2012
Frequency:	1850.2 MHz	Test By:	Fly Lu

Frequency (MHz)	Reading (dBm)	Correct Factor (dB)	Result (dBm)	Limit (dBm)	Margin (dB)	Remark	Ant.Polar. H / V
96.5000	-63.59	-1.16	-64.75	-13.00	-51.75	peak	H
215.0000	-59.42	0.06	-59.36	-13.00	-46.36	peak	H
358.0000	-71.26	-0.02	-71.28	-13.00	-58.28	peak	H
530.0000	-69.65	7.95	-61.70	-13.00	-48.70	peak	H
687.0000	-77.67	6.99	-70.68	-13.00	-57.68	peak	H
816.0000	-79.03	11.78	-67.25	-13.00	-54.25	peak	H
3832.000	-68.62	16.12	-52.50	-13.00	-39.50	peak	H
6160.000	-71.75	24.04	-47.71	-13.00	-34.71	peak	H
7708.000	-70.77	29.36	-41.41	-13.00	-28.41	peak	H
127.5000	-71.64	11.90	-59.74	-13.00	-46.74	peak	V
215.0000	-64.77	7.11	-57.66	-13.00	-44.66	peak	V
444.0000	-70.22	1.50	-68.72	-13.00	-55.72	peak	V
615.5000	-75.63	8.56	-67.07	-13.00	-54.07	peak	V
750.0000	-78.72	10.72	-68.00	-13.00	-55.00	peak	V
875.0000	-79.92	11.07	-68.85	-13.00	-55.85	peak	V
3640.000	-68.13	19.80	-48.33	-13.00	-35.33	peak	V
5668.000	-71.22	23.24	-47.98	-13.00	-34.98	peak	V
7552.000	-71.03	26.49	-44.54	-13.00	-31.54	peak	V

Standard:	FCC Part 22	Test Distance:	3m
Test item:	Radiated Emission	Power:	DC 3.8V
Model Number:	HE910-NAG	Temp.(°C)/Hum.(%RH):	23.0(°C)/55.2%RH
Mode:	2	Date:	04/12/2012
Frequency:	1880.0 MHz	Test By:	Fly Lu

Frequency (MHz)	Reading (dBm)	Correct Factor (dB)	Result (dBm)	Limit (dBm)	Margin (dB)	Remark	Ant.Polar. H / V
96.5000	-64.22	-1.16	-65.38	-13.00	-52.38	peak	H
214.5000	-59.70	0.12	-59.58	-13.00	-46.58	peak	H
444.0000	-71.69	4.04	-67.65	-13.00	-54.65	peak	H
644.5000	-74.26	6.90	-67.36	-13.00	-54.36	peak	H
759.0000	-76.77	9.05	-67.72	-13.00	-54.72	peak	H
896.0000	-80.21	13.89	-66.32	-13.00	-53.32	peak	H
3112.000	-67.92	14.27	-53.65	-13.00	-40.65	peak	H
5548.000	-71.66	21.81	-49.85	-13.00	-36.85	peak	H
7408.000	-70.92	28.90	-42.02	-13.00	-29.02	peak	H
130.5000	-70.99	14.10	-56.89	-13.00	-43.89	peak	V
231.5000	-71.25	1.93	-69.32	-13.00	-56.32	peak	V
399.5000	-55.24	1.33	-53.91	-13.00	-40.91	peak	V
558.5000	-66.69	4.35	-62.34	-13.00	-49.34	peak	V
750.0000	-78.08	10.72	-67.36	-13.00	-54.36	peak	V
864.0000	-79.89	11.46	-68.43	-13.00	-55.43	peak	V
3700.000	-69.56	19.93	-49.63	-13.00	-36.63	peak	V
6004.000	-71.05	22.77	-48.28	-13.00	-35.28	peak	V
7660.000	-71.36	26.45	-44.91	-13.00	-31.91	peak	V

Standard:	FCC Part 22	Test Distance:	3m
Test item:	Radiated Emission	Power:	DC 3.8V
Model Number:	HE910-NAG	Temp.(°C)/Hum.(%RH):	23.0(°C)/55.2%RH
Mode:	2	Date:	04/12/2012
Frequency:	1909.8 MHz	Test By:	Fly Lu

Frequency (MHz)	Reading (dBm)	Correct Factor (dB)	Result (dBm)	Limit (dBm)	Margin (dB)	Remark	Ant.Polar. H / V
96.5000	-63.91	-1.16	-65.07	-13.00	-52.07	peak	H
243.5000	-67.83	-2.83	-70.66	-13.00	-57.66	peak	H
472.5000	-76.00	5.31	-70.69	-13.00	-57.69	peak	H
615.5000	-74.91	7.75	-67.16	-13.00	-54.16	peak	H
799.5000	-73.77	11.22	-62.55	-13.00	-49.55	peak	H
971.5000	-79.03	14.55	-64.48	-13.00	-51.48	peak	H
3436.000	-68.28	15.28	-53.00	-13.00	-40.00	peak	H
5632.000	-71.06	22.05	-49.01	-13.00	-36.01	peak	H
7372.000	-71.46	28.79	-42.67	-13.00	-29.67	peak	H
131.0000	-72.16	13.83	-58.33	-13.00	-45.33	peak	V
200.0000	-67.41	10.15	-57.26	-13.00	-44.26	peak	V
300.5000	-65.03	2.67	-62.36	-13.00	-49.36	peak	V
495.0000	-71.55	2.66	-68.89	-13.00	-55.89	peak	V
673.0000	-74.77	9.50	-65.27	-13.00	-52.27	peak	V
898.5000	-78.81	10.61	-68.20	-13.00	-55.20	peak	V
3952.000	-68.66	20.49	-48.17	-13.00	-35.17	peak	V
6148.000	-71.04	23.38	-47.66	-13.00	-34.66	peak	V
7660.000	-71.64	26.45	-45.19	-13.00	-32.19	peak	V

Standard:	FCC Part 22	Test Distance:	3m
Test item:	Radiated Emission	Power:	DC 3.8V
Model Number:	HE910-NAG	Temp.(°C)/Hum.(%RH):	23.0(°C)/55.2%RH
Mode:	3	Date:	04/12/2012
Frequency:	824.2 MHz	Test By:	Fly Lu

Frequency (MHz)	Reading (dBm)	Correct Factor (dB)	Result (dBm)	Limit (dBm)	Margin (dB)	Remark	Ant.Polar. H / V
96.5000	-62.51	-1.16	-63.67	-13.00	-50.67	peak	H
215.0000	-55.38	0.06	-55.32	-13.00	-42.32	peak	H
399.5000	-62.91	2.50	-60.41	-13.00	-47.41	peak	H
558.5000	-70.35	7.83	-62.52	-13.00	-49.52	peak	H
772.0000	-71.97	9.74	-62.23	-13.00	-49.23	peak	H
967.5000	-79.24	14.64	-64.60	-13.00	-51.60	peak	H
3532.000	-68.55	15.55	-53.00	-13.00	-40.00	peak	H
5728.000	-71.99	22.31	-49.68	-13.00	-36.68	peak	H
7900.000	-71.22	29.53	-41.69	-13.00	-28.69	peak	H
131.0000	-70.17	13.83	-56.34	-13.00	-43.34	peak	V
215.0000	-63.06	7.11	-55.95	-13.00	-42.95	peak	V
399.0000	-54.98	1.35	-53.63	-13.00	-40.63	peak	V
530.0000	-64.63	3.68	-60.95	-13.00	-47.95	peak	V
701.5000	-77.43	10.24	-67.19	-13.00	-54.19	peak	V
928.5000	-78.77	12.24	-66.53	-13.00	-53.53	peak	V
3640.000	-69.10	19.80	-49.30	-13.00	-36.30	peak	V
5524.000	-71.73	23.45	-48.28	-13.00	-35.28	peak	V
7564.000	-71.80	26.49	-45.31	-13.00	-32.31	peak	V

Standard:	FCC Part 22	Test Distance:	3m
Test item:	Radiated Emission	Power:	DC 3.8V
Model Number:	HE910-NAG	Temp.(°C)/Hum.(%RH):	23.0(°C)/55.2%RH
Mode:	3	Date:	04/12/2012
Frequency:	836.4 MHz	Test By:	Fly Lu

Frequency (MHz)	Reading (dBm)	Correct Factor (dB)	Result (dBm)	Limit (dBm)	Margin (dB)	Remark	Ant.Polar. H / V
96.0000	-62.23	-1.06	-63.29	-13.00	-50.29	peak	H
215.0000	-55.40	0.06	-55.34	-13.00	-42.34	peak	H
399.5000	-61.55	2.50	-59.05	-13.00	-46.05	peak	H
530.0000	-69.92	7.95	-61.97	-13.00	-48.97	peak	H
732.5000	-77.59	7.92	-69.67	-13.00	-56.67	peak	H
940.5000	-77.60	14.86	-62.74	-13.00	-49.74	peak	H
3376.000	-67.83	15.10	-52.73	-13.00	-39.73	peak	H
5836.000	-71.14	22.60	-48.54	-13.00	-35.54	peak	H
7828.000	-71.81	29.46	-42.35	-13.00	-29.35	peak	H
132.5000	-68.58	13.02	-55.56	-13.00	-42.56	peak	V
215.0000	-62.73	7.11	-55.62	-13.00	-42.62	peak	V
400.0000	-55.96	1.33	-54.63	-13.00	-41.63	peak	V
530.0000	-64.38	3.68	-60.70	-13.00	-47.70	peak	V
720.5000	-76.44	10.85	-65.59	-13.00	-52.59	peak	V
940.5000	-75.65	12.73	-62.92	-13.00	-49.92	peak	V
2932.000	-69.20	15.87	-53.33	-13.00	-40.33	peak	V
4732.000	-70.95	22.76	-48.19	-13.00	-35.19	peak	V
7168.000	-70.84	25.84	-45.00	-13.00	-32.00	peak	V

Standard:	FCC Part 22	Test Distance:	3m
Test item:	Radiated Emission	Power:	DC 3.8V
Model Number:	HE910-NAG	Temp.(°C)/Hum.(%RH):	23.0(°C)/55.2%RH
Mode:	3	Date:	04/12/2012
Frequency:	848.8 MHz	Test By:	Fly Lu

Frequency (MHz)	Reading (dBm)	Correct Factor (dB)	Result (dBm)	Limit (dBm)	Margin (dB)	Remark	Ant.Polar. H / V
130.5000	-62.44	-4.79	-67.23	-13.00	-54.23	peak	H
243.5000	-67.38	-2.83	-70.21	-13.00	-57.21	peak	H
412.0000	-70.94	3.07	-67.87	-13.00	-54.87	peak	H
644.5000	-74.48	6.90	-67.58	-13.00	-54.58	peak	H
775.5000	-78.68	9.94	-68.74	-13.00	-55.74	peak	H
952.5000	-77.11	14.83	-62.28	-13.00	-49.28	peak	H
3580.000	-68.04	15.64	-52.40	-13.00	-39.40	peak	H
5932.000	-70.08	22.87	-47.21	-13.00	-34.21	peak	H
7780.000	-69.92	29.43	-40.49	-13.00	-27.49	peak	H
130.0000	-70.12	14.37	-55.75	-13.00	-42.75	peak	V
300.0000	-60.86	2.71	-58.15	-13.00	-45.15	peak	V
400.0000	-56.00	1.33	-54.67	-13.00	-41.67	peak	V
558.5000	-66.14	4.35	-61.79	-13.00	-48.79	peak	V
774.5000	-74.70	11.20	-63.50	-13.00	-50.50	peak	V
952.0000	-75.02	12.53	-62.49	-13.00	-49.49	peak	V
3724.000	-69.57	20.00	-49.57	-13.00	-36.57	peak	V
6052.000	-71.85	22.97	-48.88	-13.00	-35.88	peak	V
7744.000	-71.45	26.43	-45.02	-13.00	-32.02	peak	V

Standard:	FCC Part 22	Test Distance:	3m
Test item:	Radiated Emission	Power:	DC 3.8V
Model Number:	HE910-NAG	Temp.(°C)/Hum.(%RH):	23.0(°C)/55.2%RH
Mode:	4	Date:	04/12/2012
Frequency:	1850.2 MHz	Test By:	Fly Lu

Frequency (MHz)	Reading (dBm)	Correct Factor (dB)	Result (dBm)	Limit (dBm)	Margin (dB)	Remark	Ant.Polar. H / V
120.0000	-64.69	-5.42	-70.11	-13.00	-57.11	peak	H
215.0000	-58.62	0.06	-58.56	-13.00	-45.56	peak	H
398.5000	-63.08	2.41	-60.67	-13.00	-47.67	peak	H
597.5000	-74.87	7.90	-66.97	-13.00	-53.97	peak	H
771.5000	-80.29	9.72	-70.57	-13.00	-57.57	peak	H
896.0000	-77.56	13.89	-63.67	-13.00	-50.67	peak	H
3520.000	-68.61	15.54	-53.07	-13.00	-40.07	peak	H
5440.000	-70.89	21.50	-49.39	-13.00	-36.39	peak	H
7744.000	-71.37	29.40	-41.97	-13.00	-28.97	peak	H
130.5000	-69.79	14.10	-55.69	-13.00	-42.69	peak	V
289.5000	-66.61	1.77	-64.84	-13.00	-51.84	peak	V
400.0000	-56.10	1.33	-54.77	-13.00	-41.77	peak	V
615.5000	-75.03	8.56	-66.47	-13.00	-53.47	peak	V
744.0000	-78.57	10.59	-67.98	-13.00	-54.98	peak	V
933.5000	-79.97	12.45	-67.52	-13.00	-54.52	peak	V
3604.000	-69.05	19.73	-49.32	-13.00	-36.32	peak	V
5872.000	-71.25	22.93	-48.32	-13.00	-35.32	peak	V
7480.000	-71.75	26.47	-45.28	-13.00	-32.28	peak	V

Standard:	FCC Part 22	Test Distance:	3m
Test item:	Radiated Emission	Power:	DC 3.8V
Model Number:	HE910-NAG	Temp.(°C)/Hum.(%RH):	23.0(°C)/55.2%RH
Mode:	4	Date:	04/12/2012
Frequency:	1880.0 MHz	Test By:	Fly Lu

Frequency (MHz)	Reading (dBm)	Correct Factor (dB)	Result (dBm)	Limit (dBm)	Margin (dB)	Remark	Ant.Polar. H / V
96.5000	-63.50	-1.16	-64.66	-13.00	-51.66	peak	H
215.0000	-58.97	0.06	-58.91	-13.00	-45.91	peak	H
398.5000	-61.47	2.41	-59.06	-13.00	-46.06	peak	H
558.5000	-70.38	7.83	-62.55	-13.00	-49.55	peak	H
726.5000	-79.38	7.72	-71.66	-13.00	-58.66	peak	H
854.5000	-80.57	12.77	-67.80	-13.00	-54.80	peak	H
3592.000	-67.95	15.67	-52.28	-13.00	-39.28	peak	H
5872.000	-70.93	22.70	-48.23	-13.00	-35.23	peak	H
7660.000	-71.03	29.33	-41.70	-13.00	-28.70	peak	H
132.5000	-71.22	13.02	-58.20	-13.00	-45.20	peak	V
200.0000	-67.35	10.15	-57.20	-13.00	-44.20	peak	V
300.0000	-65.92	2.71	-63.21	-13.00	-50.21	peak	V
501.0000	-67.33	2.75	-64.58	-13.00	-51.58	peak	V
701.5000	-77.23	10.24	-66.99	-13.00	-53.99	peak	V
854.5000	-80.15	11.54	-68.61	-13.00	-55.61	peak	V
3496.000	-69.10	19.49	-49.61	-13.00	-36.61	peak	V
5536.000	-70.81	23.44	-47.37	-13.00	-34.37	peak	V
7492.000	-71.30	26.48	-44.82	-13.00	-31.82	peak	V

Standard:	FCC Part 22	Test Distance:	3m
Test item:	Radiated Emission	Power:	DC 3.8V
Model Number:	HE910-NAG	Temp.(°C)/Hum.(%RH):	23.0(°C)/55.2%RH
Mode:	4	Date:	04/12/2012
Frequency:	1909.8 MHz	Test By:	Fly Lu

Frequency (MHz)	Reading (dBm)	Correct Factor (dB)	Result (dBm)	Limit (dBm)	Margin (dB)	Remark	Ant.Polar. H / V
96.5000	-63.93	-1.16	-65.09	-13.00	-52.09	peak	H
284.0000	-67.17	-3.94	-71.11	-13.00	-58.11	peak	H
444.0000	-72.46	4.04	-68.42	-13.00	-55.42	peak	H
644.5000	-74.47	6.90	-67.57	-13.00	-54.57	peak	H
796.5000	-70.80	11.06	-59.74	-13.00	-46.74	peak	H
951.0000	-79.19	14.85	-64.34	-13.00	-51.34	peak	H
4036.000	-68.84	16.49	-52.35	-13.00	-39.35	peak	H
6160.000	-71.65	24.04	-47.61	-13.00	-34.61	peak	H
7876.000	-71.74	29.51	-42.23	-13.00	-29.23	peak	H
132.0000	-71.71	13.29	-58.42	-13.00	-45.42	peak	V
215.0000	-64.27	7.11	-57.16	-13.00	-44.16	peak	V
398.5000	-55.56	1.34	-54.22	-13.00	-41.22	peak	V
530.0000	-64.72	3.68	-61.04	-13.00	-48.04	peak	V
781.0000	-73.56	11.31	-62.25	-13.00	-49.25	peak	V
943.0000	-78.55	12.68	-65.87	-13.00	-52.87	peak	V
3616.000	-69.00	19.77	-49.23	-13.00	-36.23	peak	V
5728.000	-70.82	23.16	-47.66	-13.00	-34.66	peak	V
7576.000	-71.37	26.47	-44.90	-13.00	-31.90	peak	V

Standard:	FCC Part 22	Test Distance:	3m
Test item:	Radiated Emission	Power:	DC 3.8V
Model Number:	HE910-NAG	Temp.(°C)/Hum.(%RH):	23.0(°C)/55.2%RH
Mode:	5	Date:	04/12/2012
Frequency:	824.2 MHz	Test By:	Fly Lu

Frequency (MHz)	Reading (dBm)	Correct Factor (dB)	Result (dBm)	Limit (dBm)	Margin (dB)	Remark	Ant.Polar. H / V
96.5000	-62.06	-1.16	-63.22	-13.00	-50.22	peak	H
186.0000	-64.84	-6.49	-71.33	-13.00	-58.33	peak	H
399.0000	-63.28	2.46	-60.82	-13.00	-47.82	peak	H
599.5000	-73.01	7.94	-65.07	-13.00	-52.07	peak	H
746.0000	-77.25	8.47	-68.78	-13.00	-55.78	peak	H
933.5000	-79.35	14.82	-64.53	-13.00	-51.53	peak	H
2968.000	-67.99	13.82	-54.17	-13.00	-41.17	peak	H
5320.000	-71.88	21.12	-50.76	-13.00	-37.76	peak	H
7804.000	-71.81	29.44	-42.37	-13.00	-29.37	peak	H
131.5000	-69.51	13.57	-55.94	-13.00	-42.94	peak	V
200.0000	-66.50	10.15	-56.35	-13.00	-43.35	peak	V
400.0000	-55.60	1.33	-54.27	-13.00	-41.27	peak	V
530.0000	-64.97	3.68	-61.29	-13.00	-48.29	peak	V
717.5000	-76.18	10.78	-65.40	-13.00	-52.40	peak	V
912.0000	-79.73	11.36	-68.37	-13.00	-55.37	peak	V
3628.000	-69.30	19.78	-49.52	-13.00	-36.52	peak	V
5716.000	-71.44	23.17	-48.27	-13.00	-35.27	peak	V
7612.000	-71.39	26.47	-44.92	-13.00	-31.92	peak	V

Standard:	FCC Part 22	Test Distance:	3m
Test item:	Radiated Emission	Power:	DC 3.8V
Model Number:	HE910-NAG	Temp.(°C)/Hum.(%RH):	23.0(°C)/55.2%RH
Mode:	5	Date:	04/12/2012
Frequency:	836.4 MHz	Test By:	Fly Lu

Frequency (MHz)	Reading (dBm)	Correct Factor (dB)	Result (dBm)	Limit (dBm)	Margin (dB)	Remark	Ant.Polar. H / V
96.0000	-62.65	-1.06	-63.71	-13.00	-50.71	peak	H
215.0000	-55.70	0.06	-55.64	-13.00	-42.64	peak	H
398.5000	-61.55	2.41	-59.14	-13.00	-46.14	peak	H
558.5000	-70.39	7.83	-62.56	-13.00	-49.56	peak	H
737.0000	-77.87	8.09	-69.78	-13.00	-56.78	peak	H
940.5000	-78.01	14.86	-63.15	-13.00	-50.15	peak	H
3604.000	-68.21	15.69	-52.52	-13.00	-39.52	peak	H
5920.000	-71.21	22.83	-48.38	-13.00	-35.38	peak	H
7744.000	-71.38	29.40	-41.98	-13.00	-28.98	peak	H
130.5000	-70.49	14.10	-56.39	-13.00	-43.39	peak	V
200.0000	-66.37	10.15	-56.22	-13.00	-43.22	peak	V
329.5000	-68.57	1.11	-67.46	-13.00	-54.46	peak	V
399.5000	-55.03	1.33	-53.70	-13.00	-40.70	peak	V
587.0000	-69.00	6.46	-62.54	-13.00	-49.54	peak	V
923.5000	-79.54	12.02	-67.52	-13.00	-54.52	peak	V
3436.000	-68.27	19.11	-49.16	-13.00	-36.16	peak	V
5644.000	-71.45	23.28	-48.17	-13.00	-35.17	peak	V
7696.000	-71.64	26.45	-45.19	-13.00	-32.19	peak	V

Standard:	FCC Part 22	Test Distance:	3m
Test item:	Radiated Emission	Power:	DC 3.8V
Model Number:	HE910-NAG	Temp.(°C)/Hum.(%RH):	23.0(°C)/55.2%RH
Mode:	5	Date:	04/12/2012
Frequency:	848.8 MHz	Test By:	Fly Lu

Frequency (MHz)	Reading (dBm)	Correct Factor (dB)	Result (dBm)	Limit (dBm)	Margin (dB)	Remark	Ant.Polar. H / V
96.5000	-62.54	-1.16	-63.70	-13.00	-50.70	peak	H
215.0000	-55.72	0.06	-55.66	-13.00	-42.66	peak	H
399.5000	-61.28	2.50	-58.78	-13.00	-45.78	peak	H
587.0000	-71.06	7.72	-63.34	-13.00	-50.34	peak	H
745.0000	-74.92	8.42	-66.50	-13.00	-53.50	peak	H
953.0000	-79.15	14.84	-64.31	-13.00	-51.31	peak	H
2548.000	-65.21	12.36	-52.85	-13.00	-39.85	peak	H
5236.000	-71.01	20.85	-50.16	-13.00	-37.16	peak	H
7612.000	-71.04	29.30	-41.74	-13.00	-28.74	peak	H
130.5000	-69.17	14.10	-55.07	-13.00	-42.07	peak	V
215.0000	-62.66	7.11	-55.55	-13.00	-42.55	peak	V
399.5000	-55.55	1.33	-54.22	-13.00	-41.22	peak	V
558.5000	-66.66	4.35	-62.31	-13.00	-49.31	peak	V
744.0000	-78.65	10.59	-68.06	-13.00	-55.06	peak	V
949.0000	-78.46	12.57	-65.89	-13.00	-52.89	peak	V
3316.000	-68.64	18.38	-50.26	-13.00	-37.26	peak	V
5536.000	-71.32	23.44	-47.88	-13.00	-34.88	peak	V
7720.000	-71.55	26.43	-45.12	-13.00	-32.12	peak	V

Standard:	FCC Part 22	Test Distance:	3m
Test item:	Radiated Emission	Power:	DC 3.8V
Model Number:	HE910-NAG	Temp.(°C)/Hum.(%RH):	23.0(°C)/55.2%RH
Mode:	6	Date:	04/12/2012
Frequency:	1850.2 MHz	Test By:	Fly Lu

Frequency (MHz)	Reading (dBm)	Correct Factor (dB)	Result (dBm)	Limit (dBm)	Margin (dB)	Remark	Ant.Polar. H / V
96.5000	-64.02	-1.16	-65.18	-13.00	-52.18	peak	H
216.0000	-66.51	-0.05	-66.56	-13.00	-53.56	peak	H
399.5000	-61.95	2.50	-59.45	-13.00	-46.45	peak	H
530.0000	-69.17	7.95	-61.22	-13.00	-48.22	peak	H
684.5000	-75.30	7.01	-68.29	-13.00	-55.29	peak	H
864.0000	-80.26	13.05	-67.21	-13.00	-54.21	peak	H
3448.000	-67.66	15.33	-52.33	-13.00	-39.33	peak	H
5656.000	-71.30	22.11	-49.19	-13.00	-36.19	peak	H
7636.000	-71.37	29.31	-42.06	-13.00	-29.06	peak	H
131.5000	-70.87	13.57	-57.30	-13.00	-44.30	peak	V
200.0000	-66.35	10.15	-56.20	-13.00	-43.20	peak	V
398.0000	-54.82	1.36	-53.46	-13.00	-40.46	peak	V
558.5000	-66.94	4.35	-62.59	-13.00	-49.59	peak	V
687.5000	-74.98	9.80	-65.18	-13.00	-52.18	peak	V
840.0000	-79.58	11.35	-68.23	-13.00	-55.23	peak	V
3004.000	-66.22	16.44	-49.78	-13.00	-36.78	peak	V
5404.000	-70.11	23.49	-46.62	-13.00	-33.62	peak	V
7396.000	-71.39	26.30	-45.09	-13.00	-32.09	peak	V

Standard:	FCC Part 22	Test Distance:	3m
Test item:	Radiated Emission	Power:	DC 3.8V
Model Number:	HE910-NAG	Temp.(°C)/Hum.(%RH):	23.0(°C)/55.2%RH
Mode:	6	Date:	04/12/2012
Frequency:	1880.0 MHz	Test By:	Fly Lu

Frequency (MHz)	Reading (dBm)	Correct Factor (dB)	Result (dBm)	Limit (dBm)	Margin (dB)	Remark	Ant.Polar. H / V
96.5000	-63.05	-1.16	-64.21	-13.00	-51.21	peak	H
215.0000	-58.25	0.06	-58.19	-13.00	-45.19	peak	H
399.5000	-61.63	2.50	-59.13	-13.00	-46.13	peak	H
530.0000	-69.22	7.95	-61.27	-13.00	-48.27	peak	H
701.5000	-79.69	6.99	-72.70	-13.00	-59.70	peak	H
880.5000	-80.52	13.23	-67.29	-13.00	-54.29	peak	H
3472.000	-67.93	15.41	-52.52	-13.00	-39.52	peak	H
5872.000	-71.00	22.70	-48.30	-13.00	-35.30	peak	H
7492.000	-72.67	29.17	-43.50	-13.00	-30.50	peak	H
130.5000	-70.93	14.10	-56.83	-13.00	-43.83	peak	V
215.0000	-65.15	7.11	-58.04	-13.00	-45.04	peak	V
398.5000	-55.20	1.34	-53.86	-13.00	-40.86	peak	V
530.0000	-64.90	3.68	-61.22	-13.00	-48.22	peak	V
701.5000	-77.53	10.24	-67.29	-13.00	-54.29	peak	V
864.0000	-80.41	11.46	-68.95	-13.00	-55.95	peak	V
3292.000	-68.52	18.23	-50.29	-13.00	-37.29	peak	V
5620.000	-70.52	23.30	-47.22	-13.00	-34.22	peak	V
7348.000	-71.92	26.20	-45.72	-13.00	-32.72	peak	V

Standard:	FCC Part 22	Test Distance:	3m
Test item:	Radiated Emission	Power:	DC 3.8V
Model Number:	HE910-NAG	Temp.(°C)/Hum.(%RH):	23.0(°C)/55.2%RH
Mode:	6	Date:	04/12/2012
Frequency:	1909.8 MHz	Test By:	Fly Lu

Frequency (MHz)	Reading (dBm)	Correct Factor (dB)	Result (dBm)	Limit (dBm)	Margin (dB)	Remark	Ant.Polar. H / V
96.0000	-64.29	-1.06	-65.35	-13.00	-52.35	peak	H
215.0000	-58.19	0.06	-58.13	-13.00	-45.13	peak	H
398.5000	-62.78	2.41	-60.37	-13.00	-47.37	peak	H
558.5000	-70.06	7.83	-62.23	-13.00	-49.23	peak	H
719.0000	-79.62	7.47	-72.15	-13.00	-59.15	peak	H
896.0000	-77.22	13.89	-63.33	-13.00	-50.33	peak	H
3652.000	-68.44	15.78	-52.66	-13.00	-39.66	peak	H
6172.000	-70.90	24.12	-46.78	-13.00	-33.78	peak	H
7696.000	-70.93	29.37	-41.56	-13.00	-28.56	peak	H
130.0000	-72.08	14.37	-57.71	-13.00	-44.71	peak	V
215.0000	-64.06	7.11	-56.95	-13.00	-43.95	peak	V
399.5000	-54.65	1.33	-53.32	-13.00	-40.32	peak	V
558.5000	-65.69	4.35	-61.34	-13.00	-48.34	peak	V
799.5000	-72.00	11.86	-60.14	-13.00	-47.14	peak	V
916.5000	-79.96	11.65	-68.31	-13.00	-55.31	peak	V
3544.000	-68.80	19.60	-49.20	-13.00	-36.20	peak	V
5500.000	-70.68	23.49	-47.19	-13.00	-34.19	peak	V
7420.000	-72.14	26.34	-45.80	-13.00	-32.80	peak	V

Standard:	FCC Part 22	Test Distance:	3m
Test item:	Radiated Emission	Power:	DC 3.8V
Model Number:	HE910-NAG	Temp.(°C)/Hum.(%RH):	23.0(°C)/55.2%RH
Mode:	7	Date:	04/12/2012
Frequency:	1852.4 MHz	Test By:	Fly Lu

Frequency (MHz)	Reading (dBm)	Correct Factor (dB)	Result (dBm)	Limit (dBm)	Margin (dB)	Remark	Ant.Polar. H / V
96.5000	-63.58	-1.16	-64.74	-13.00	-51.74	peak	H
214.5000	-57.95	0.12	-57.83	-13.00	-44.83	peak	H
398.0000	-63.60	2.37	-61.23	-13.00	-48.23	peak	H
587.0000	-73.41	7.72	-65.69	-13.00	-52.69	peak	H
768.0000	-79.82	9.54	-70.28	-13.00	-57.28	peak	H
899.5000	-79.19	14.04	-65.15	-13.00	-52.15	peak	H
3460.000	-69.50	15.36	-54.14	-13.00	-41.14	peak	H
5836.000	-71.07	22.60	-48.47	-13.00	-35.47	peak	H
7924.000	-72.24	29.55	-42.69	-13.00	-29.69	peak	H
130.5000	-71.67	14.09	-57.58	-13.00	-44.58	peak	V
200.0000	-66.81	10.15	-56.66	-13.00	-43.66	peak	V
399.5000	-56.05	1.33	-54.72	-13.00	-41.72	peak	V
587.0000	-69.22	6.46	-62.76	-13.00	-49.76	peak	V
796.5000	-72.42	11.77	-60.65	-13.00	-47.65	peak	V
924.0000	-80.30	12.04	-68.26	-13.00	-55.26	peak	V
3532.000	-68.54	19.58	-48.96	-13.00	-35.96	peak	V
5656.000	-71.18	23.26	-47.92	-13.00	-34.92	peak	V
7612.000	-71.15	26.47	-44.68	-13.00	-31.68	peak	V

Standard:	FCC Part 22	Test Distance:	3m
Test item:	Radiated Emission	Power:	DC 3.8V
Model Number:	HE910-NAG	Temp.(°C)/Hum.(%RH):	23.0(°C)/55.2%RH
Mode:	7	Date:	04/12/2012
Frequency:	1880.0 MHz	Test By:	Fly Lu

Frequency (MHz)	Reading (dBm)	Correct Factor (dB)	Result (dBm)	Limit (dBm)	Margin (dB)	Remark	Ant.Polar. H / V
96.5000	-64.14	-1.16	-65.30	-13.00	-52.30	peak	H
215.0000	-58.62	0.06	-58.56	-13.00	-45.56	peak	H
398.5000	-60.62	2.41	-58.21	-13.00	-45.21	peak	H
558.5000	-70.96	7.83	-63.13	-13.00	-50.13	peak	H
730.0000	-79.13	7.85	-71.28	-13.00	-58.28	peak	H
898.5000	-79.96	13.99	-65.97	-13.00	-52.97	peak	H
3496.000	-68.95	15.49	-53.46	-13.00	-40.46	peak	H
5764.000	-71.15	22.41	-48.74	-13.00	-35.74	peak	H
7612.000	-71.52	29.30	-42.22	-13.00	-29.22	peak	H
131.0000	-71.74	13.83	-57.91	-13.00	-44.91	peak	V
215.0000	-65.07	7.11	-57.96	-13.00	-44.96	peak	V
399.5000	-54.59	1.33	-53.26	-13.00	-40.26	peak	V
530.0000	-65.51	3.68	-61.83	-13.00	-48.83	peak	V
709.0000	-76.65	10.49	-66.16	-13.00	-53.16	peak	V
899.5000	-78.40	10.60	-67.80	-13.00	-54.80	peak	V
3652.000	-69.08	19.84	-49.24	-13.00	-36.24	peak	V
5644.000	-71.70	23.28	-48.42	-13.00	-35.42	peak	V
7540.000	-71.89	26.49	-45.40	-13.00	-32.40	peak	V

Standard:	FCC Part 22	Test Distance:	3m
Test item:	Radiated Emission	Power:	DC 3.8V
Model Number:	HE910-NAG	Temp.(°C)/Hum.(%RH):	23.0(°C)/55.2%RH
Mode:	7	Date:	04/12/2012
Frequency:	1907.6 MHz	Test By:	Fly Lu

Frequency (MHz)	Reading (dBm)	Correct Factor (dB)	Result (dBm)	Limit (dBm)	Margin (dB)	Remark	Ant.Polar. H / V
96.5000	-63.02	-1.16	-64.18	-13.00	-51.18	peak	H
215.0000	-58.79	0.06	-58.73	-13.00	-45.73	peak	H
386.5000	-68.87	1.35	-67.52	-13.00	-54.52	peak	H
500.0000	-71.50	6.97	-64.53	-13.00	-51.53	peak	H
710.0000	-77.76	7.22	-70.54	-13.00	-57.54	peak	H
840.0000	-76.64	12.10	-64.54	-13.00	-51.54	peak	H
3616.000	-68.53	15.72	-52.81	-13.00	-39.81	peak	H
6040.000	-71.32	23.30	-48.02	-13.00	-35.02	peak	H
7876.000	-71.03	29.51	-41.52	-13.00	-28.52	peak	H
131.5000	-70.47	13.56	-56.91	-13.00	-43.91	peak	V
200.0000	-67.04	10.15	-56.89	-13.00	-43.89	peak	V
340.0000	-71.63	1.19	-70.44	-13.00	-57.44	peak	V
444.0000	-71.20	1.50	-69.70	-13.00	-56.70	peak	V
673.0000	-74.44	9.50	-64.94	-13.00	-51.94	peak	V
875.0000	-79.21	11.07	-68.14	-13.00	-55.14	peak	V
3808.000	-69.77	20.18	-49.59	-13.00	-36.59	peak	V
5848.000	-71.37	22.98	-48.39	-13.00	-35.39	peak	V
7564.000	-71.32	26.49	-44.83	-13.00	-31.83	peak	V

Standard:	FCC Part 22	Test Distance:	3m
Test item:	Radiated Emission	Power:	DC 3.8V
Model Number:	HE910-NAG	Temp.(°C)/Hum.(%RH):	23.0(°C)/55.2%RH
Mode:	8	Date:	04/12/2012
Frequency:	826.4 MHz	Test By:	Fly Lu

Frequency (MHz)	Reading (dBm)	Correct Factor (dB)	Result (dBm)	Limit (dBm)	Margin (dB)	Remark	Ant.Polar. H / V
96.5000	-63.96	-1.16	-65.12	-13.00	-52.12	peak	H
215.0000	-58.81	0.06	-58.75	-13.00	-45.75	peak	H
398.5000	-62.77	2.41	-60.36	-13.00	-47.36	peak	H
558.5000	-70.50	7.83	-62.67	-13.00	-49.67	peak	H
730.0000	-79.98	7.85	-72.13	-13.00	-59.13	peak	H
940.0000	-78.82	14.86	-63.96	-13.00	-50.96	peak	H
3796.000	-68.81	16.05	-52.76	-13.00	-39.76	peak	H
5980.000	-71.75	23.00	-48.75	-13.00	-35.75	peak	H
7780.000	-70.38	29.43	-40.95	-13.00	-27.95	peak	H
131.0000	-71.55	13.83	-57.72	-13.00	-44.72	peak	V
220.0000	-69.11	5.29	-63.82	-13.00	-50.82	peak	V
398.5000	-55.81	1.34	-54.47	-13.00	-41.47	peak	V
558.5000	-67.22	4.35	-62.87	-13.00	-49.87	peak	V
730.0000	-76.35	10.68	-65.67	-13.00	-52.67	peak	V
939.5000	-80.35	12.72	-67.63	-13.00	-54.63	peak	V
3004.000	-67.11	16.44	-50.67	-13.00	-37.67	peak	V
5476.000	-72.04	23.49	-48.55	-13.00	-35.55	peak	V
7660.000	-71.15	26.45	-44.70	-13.00	-31.70	peak	V

Standard:	FCC Part 22	Test Distance:	3m
Test item:	Radiated Emission	Power:	DC 3.8V
Model Number:	HE910-NAG	Temp.(°C)/Hum.(%RH):	23.0(°C)/55.2%RH
Mode:	8	Date:	04/12/2012
Frequency:	836.4 MHz	Test By:	Fly Lu

Frequency (MHz)	Reading (dBm)	Correct Factor (dB)	Result (dBm)	Limit (dBm)	Margin (dB)	Remark	Ant.Polar. H / V
96.5000	-63.15	-1.16	-64.31	-13.00	-51.31	peak	H
215.0000	-58.21	0.06	-58.15	-13.00	-45.15	peak	H
444.0000	-73.00	4.04	-68.96	-13.00	-55.96	peak	H
597.5000	-75.11	7.90	-67.21	-13.00	-54.21	peak	H
756.0000	-79.16	8.91	-70.25	-13.00	-57.25	peak	H
952.0000	-80.76	14.85	-65.91	-13.00	-52.91	peak	H
3652.000	-68.70	15.78	-52.92	-13.00	-39.92	peak	H
6124.000	-71.37	23.82	-47.55	-13.00	-34.55	peak	H
7864.000	-70.96	29.50	-41.46	-13.00	-28.46	peak	H
131.5000	-69.58	13.57	-56.01	-13.00	-43.01	peak	V
215.0000	-64.12	7.11	-57.01	-13.00	-44.01	peak	V
399.5000	-55.56	1.33	-54.23	-13.00	-41.23	peak	V
530.0000	-65.62	3.68	-61.94	-13.00	-48.94	peak	V
701.5000	-77.15	10.24	-66.91	-13.00	-53.91	peak	V
939.5000	-80.22	12.72	-67.50	-13.00	-54.50	peak	V
3496.000	-68.35	19.49	-48.86	-13.00	-35.86	peak	V
5656.000	-71.09	23.26	-47.83	-13.00	-34.83	peak	V
7504.000	-71.39	26.50	-44.89	-13.00	-31.89	peak	V

Standard:	FCC Part 22	Test Distance:	3m
Test item:	Radiated Emission	Power:	DC 3.8V
Model Number:	HE910-NAG	Temp.(°C)/Hum.(%RH):	23.0(°C)/55.2%RH
Mode:	8	Date:	04/12/2012
Frequency:	846.4 MHz	Test By:	Fly Lu

Frequency (MHz)	Reading (dBm)	Correct Factor (dB)	Result (dBm)	Limit (dBm)	Margin (dB)	Remark	Ant.Polar. H / V
157.5000	-66.35	0.67	-65.68	-13.00	-52.68	peak	H
300.0000	-63.78	-2.36	-66.14	-13.00	-53.14	peak	H
444.0000	-71.47	4.04	-67.43	-13.00	-54.43	peak	H
558.5000	-70.49	7.83	-62.66	-13.00	-49.66	peak	H
730.0000	-78.68	7.85	-70.83	-13.00	-57.83	peak	H
958.0000	-79.82	14.83	-64.99	-13.00	-51.99	peak	H
3508.000	-69.23	15.50	-53.73	-13.00	-40.73	peak	H
6040.000	-71.52	23.30	-48.22	-13.00	-35.22	peak	H
7876.000	-71.83	29.51	-42.32	-13.00	-29.32	peak	H
130.5000	-72.46	14.10	-58.36	-13.00	-45.36	peak	V
215.0000	-64.91	7.11	-57.80	-13.00	-44.80	peak	V
398.5000	-55.00	1.34	-53.66	-13.00	-40.66	peak	V
615.5000	-74.61	8.56	-66.05	-13.00	-53.05	peak	V
730.0000	-77.64	10.68	-66.96	-13.00	-53.96	peak	V
952.0000	-78.54	12.53	-66.01	-13.00	-53.01	peak	V
3892.000	-68.81	20.36	-48.45	-13.00	-35.45	peak	V
6220.000	-71.83	23.69	-48.14	-13.00	-35.14	peak	V
8008.000	-71.74	26.34	-45.40	-13.00	-32.40	peak	V

Standard:	RSS-Gen	Test Distance:	3m
Test item:	Radiated Emission	Power:	DC 3.8V
Model Number:	HE910-NAG	Temp.(°C)/Hum.(%RH):	23.0(°C)/55.2%RH
Mode:	9	Date:	04/12/2012
		Test By:	Fly Lu

Frequency (MHz)	Reading (dBm)	Correct Factor (dB)	Result (dBm)	Limit (dBm)	Margin (dB)	Remark	Ant.Polar. H / V
2750.000	39.00	1.32	40.32	74.00	-33.68	peak	H
4598.000	36.30	7.26	43.56	74.00	-30.44	peak	H
5739.000	36.00	10.40	46.40	74.00	-27.60	peak	H
2799.000	41.72	1.49	43.21	74.00	-30.79	peak	V
4416.000	37.45	6.67	44.12	74.00	-29.88	peak	V
5977.000	35.44	10.82	46.26	74.00	-27.74	peak	V

7 Frequency Stability (Temperature Variation) Test

7.1. Limit

The frequency stability shall be measured by variation of ambient temperature and variation of primary supply voltage to ensure that the fundamental emission stays within the authorized frequency block. The frequency stability of the transmitter shall be maintained within $\pm 0.00025\%$ ($\pm 2.5\text{ppm}$) of the center frequency.

7.2. Test Instruments

Equipment	Manufacturer	Model Number	Serial Number	Cal. Date	Remark
Universal Radio Communication Tester	ROHDE & SCHWARZ	CMU200	109369	08/10/2010	(2)
Temperature & Humidity Chamber	TAICHY	MHU-225LA	980729	08/24/2011	(1)
Test Site	ATL	TE05	TE05	N.C.R.	-----

Remark: ⁽¹⁾ Calibration period 1 year. ⁽²⁾ Calibration period 2 years.

Note: N.C.R. = No Calibration Request.

7.3. Setup

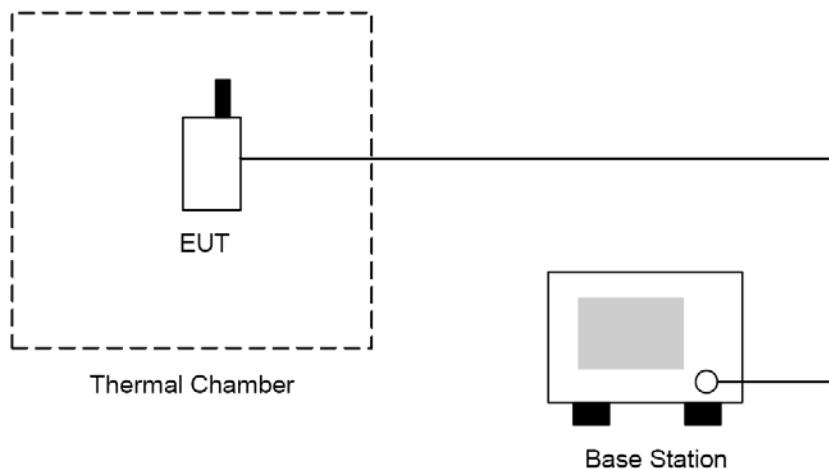

7.4. Test Procedure

The measurement is made according to FCC rules part 22 and 24:

1. The EUT and test equipment were set up as shown on the following section.
2. With all power removed, the temperature was decreased to -30°C and permitted to stabilize for three hours. Power was applied and the maximum change in frequency was note within one minute.
3. With power OFF, the temperature was raised in 10°C steps. The sample was permitted to stabilize at each step for at least one-half hour. Power was applied and the maximum frequency change was noted within one minute.
4. The temperature tests were performed for the worst case.
5. Test data was recorded.

7.5. Uncertainty

The measurement uncertainty is defined as for Frequency Stability (Temperature Variation) measurement is $\pm 10\text{Hz}$.

7.6. Test Result

Model Number	HE910-NAG			
Test Item	Frequency Stability (Temperature Variation)			
Test Mode	Mode 1			
Date of Test	04/12/2012		Test Site	TE05
Temperature (°C)	Deviation (Hz)	Deviation (ppm)	Limit (ppm)	Result
-30	12	0.014	±2.5	Pass
-20	5	0.006	±2.5	Pass
-10	9	0.011	±2.5	Pass
0	10	0.012	±2.5	Pass
10	7	0.008	±2.5	Pass
20	6	0.007	±2.5	Pass
30	8	0.010	±2.5	Pass
40	9	0.011	±2.5	Pass
50	11	0.013	±2.5	Pass

Model Number	HE910-NAG			
Test Item	Frequency Stability (Temperature Variation)			
Test Mode	Mode 2			
Date of Test	04/12/2012		Test Site	TE05
Temperature (°C)	Deviation (Hz)	Deviation (ppm)	Limit (ppm)	Result
-30	11	0.006	±2.5	Pass
-20	7	0.004	±2.5	Pass
-10	9	0.005	±2.5	Pass
0	15	0.008	±2.5	Pass
10	-16	-0.009	±2.5	Pass
20	10	0.005	±2.5	Pass
30	12	0.006	±2.5	Pass
40	8	0.004	±2.5	Pass
50	10	0.005	±2.5	Pass

Model Number	HE910-NAG			
Test Item	Frequency Stability (Temperature Variation)			
Test Mode	Mode 7			
Date of Test	04/12/2012		Test Site	TE05
Temperature (°C)	Deviation (Hz)	Deviation (ppm)	Limit (ppm)	Result
-30	-14	-0.007	±2.5	Pass
-20	-8	-0.004	±2.5	Pass
-10	-6	-0.003	±2.5	Pass
0	-10	-0.005	±2.5	Pass
10	-7	-0.004	±2.5	Pass
20	-15	-0.008	±2.5	Pass
30	-13	-0.007	±2.5	Pass
40	-12	-0.006	±2.5	Pass
50	-6	-0.003	±2.5	Pass

Model Number	HE910-NAG			
Test Item	Frequency Stability (Temperature Variation)			
Test Mode	Mode 8			
Date of Test	04/12/2012		Test Site	TE05
Temperature (°C)	Deviation (Hz)	Deviation (ppm)	Limit (ppm)	Result
-30	-9	-0.011	±2.5	Pass
-20	-5	-0.006	±2.5	Pass
-10	-8	-0.010	±2.5	Pass
0	-6	-0.007	±2.5	Pass
10	-4	-0.005	±2.5	Pass
20	-5	-0.006	±2.5	Pass
30	-7	-0.008	±2.5	Pass
40	-9	-0.011	±2.5	Pass
50	-10	-0.012	±2.5	Pass

8 Frequency Stability (Voltage Variation) Test

8.1. Limit

The frequency stability shall be measured by variation of ambient temperature and variation of primary supply voltage to ensure that the fundamental emission stays within the authorized frequency block. The frequency stability of the transmitter shall be maintained within $\pm 0.00025\%$ ($\pm 2.5\text{ppm}$) of the center frequency.

8.2. Test Instruments

Equipment	Manufacturer	Model Number	Serial Number	Cal. Date	Remark
Universal Radio Communication Tester	ROHDE & SCHWARZ	CMU200	109369	08/10/2010	(2)
Temperature & Humidity Chamber	TAICHY	MHU-225LA	980729	08/24/2011	(1)
Test Site	ATL	TE05	TE05	N.C.R.	-----

Remark: ⁽¹⁾ Calibration period 1 year. ⁽²⁾ Calibration period 2 years.

Note: N.C.R. = No Calibration Request.

8.3. Setup

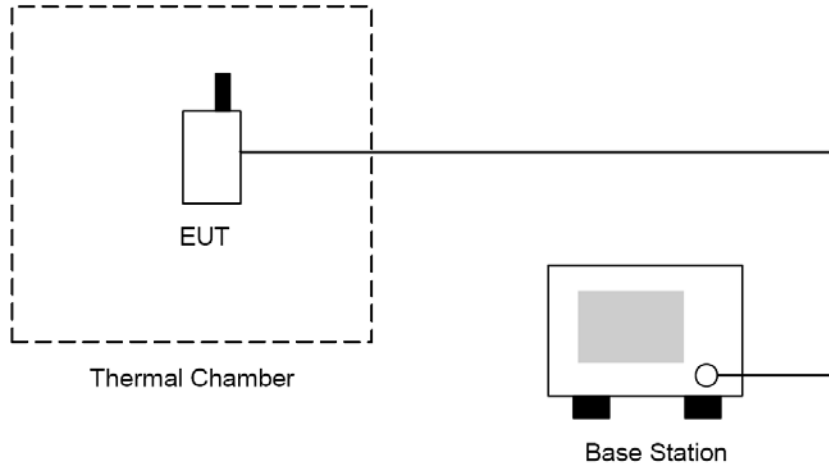

8.4. Test Procedure

1. The EUT was placed in a temperature chamber at $25 \pm 5 \text{ }^\circ\text{C}$ and connected as the following section.
2. The power supply voltage to the EUT was varied from BEP to 115% of the nominal value measured at the input to the EUT.
3. The variation in frequency was measured for the worst case.

8.5. Uncertainty

The measurement uncertainty is defined as for Frequency Stability (Voltage Variation) measurement is $\pm 10\text{Hz}$.

8.6. Test Result

Model Number	HE910-NAG				
Test Item	Frequency Stability (Voltage Variation)				
Test Mode	Mode 1				
Date of Test	04/12/2012		Test Site	TE05	
Level	Voltage [Vdc]	Deviation [Hz]	Deviation [ppm]	Limit [ppm]	Result
Battery full point	4.20	8	0.010	± 2.5	Pass
Normal	3.80	10	0.012	± 2.5	Pass
Battery cut-off point	3.40	9	0.011	± 2.5	Pass

Model Number	HE910-NAG				
Test Item	Frequency Stability (Voltage Variation)				
Test Mode	Mode 2				
Date of Test	04/12/2012		Test Site	TE05	
Level	Voltage [Vdc]	Deviation [Hz]	Deviation [ppm]	Limit [ppm]	Result
Battery full point	4.20	13	0.007	± 2.5	Pass
Normal	3.80	11	0.006	± 2.5	Pass
Battery cut-off point	3.40	10	0.005	± 2.5	Pass

Model Number	HE910-NAG				
Test Item	Frequency Stability (Voltage Variation)				
Test Mode	Mode 7				
Date of Test	04/12/2012		Test Site	TE05	
Level	Voltage [Vdc]	Deviation [Hz]	Deviation [ppm]	Limit [ppm]	Result
Battery full point	4.20	-9	-0.005	± 2.5	Pass
Normal	3.80	-12	-0.006	± 2.5	Pass
Battery cut-off point	3.40	-8	-0.004	± 2.5	Pass

Model Number	HE910-NAG					
Test Item	Frequency Stability (Voltage Variation)					
Test Mode	Mode 8					
Date of Test	04/12/2012			Test Site	TE05	
Level	Voltage [Vdc]	Deviation [Hz]	Deviation [ppm]	Limit [ppm]	Result	
Battery full point	4.20	-9	-0.011	±2.5	Pass	
Normal	3.80	-8	-0.010	±2.5	Pass	
Battery cut-off point	3.40	-6	-0.007	±2.5	Pass	