

FCC 47 CFR PART 27 SUBPART L

Product Type : 2G/3G Module
Applicant : Telit Communications S.p.A.
Address : Via Stazione di Prosecco, 5/B, Sgonico, TS 34010, Italy
Trade name : Telit
Model No. : HE910
Test : ANSI/TIA-603-C-2004
Specification : RSS-Gen Issue 3, December 2010
RSS-139 Issue 2, February 2009
Issue Date : Feb. 03, 2012

Issue by

A Test Lab Techno Corp.
No. 140-1, Changan Street, Bade City,
Taoyuan County 334, Taiwan R.O.C.
Tel : +86-3-2710188 / Fax : +86-3-2710190



Taiwan Accreditation Foundation accreditation number: 1330

Note: This report shall not be reproduced except in full, without the written approval of A Test Lab Techno Corp. This document may be altered or revised by A Test Lab Techno Corp. personnel only, and shall be noted in the revision section of the document. The client should not use it to claim product endorsement by TAF, or any government agencies. The test results in the report only apply to the tested sample.

Revision History

| Rev. | Issue Date | Revisions | Revised By |
|-------------|-------------------|---|-------------------|
| 00 | Jan. 11, 2012 | Initial Issue | |
| 01 | Jan. 30, 2012 | Delete IC ID | Nico Peng |
| 02 | Feb. 03, 2012 | Add IC standard and RX of radiated emission test data | Nico Peng |
| | | | |

Verification of Compliance

Issued Date: 2012/02/03

Product Type : 2G/3G Module
Applicant : Telit Communications S.p.A.
Address : Via Stazione di Prosecco, 5/B, Sgonico, TS 34010, Italy
Trade Name : Telit
Model No. : HE910
FCC ID : RI7HE910
IC ID : 5131A-HE910
EUT Rated Voltage : DC 3.8V
Test Voltage : DC 3.8V
Applicable Standard : FCC 47 CFR PART 27 SUBPART L: Oct. 2010
ANSI/TIA-603-C-2004
RSS-Gen Issue 3, December 2010
RSS-139 Issue 2, February 2009
Test Result : Complied
Performing Lab. : A Test Lab Techno Corp.

No. 140-1, Changan Street, Bade City,
Taoyuan County 334, Taiwan R.O.C.

Tel : +886-3-2710188 / Fax : +886-3-2710190

Taiwan Accreditation Foundation accreditation number:
1330

<http://www.atl-lab.com.tw/e-index.htm>



The above equipment was tested by A Test Lab Techno Corp. The test data, data evaluation, test procedures, and equipment configurations shown in this report were made in accordance with the procedures given in ANSI C63.4: 2009 and the energy emitted by the sample tested as described in this report is in compliance with the requirements of FCC Rules Part 27L.

The test results of this report relate only to the tested sample identified in this report



Approved By :  Reviewed By : 
(Manager) (Murphy Wang) (Testing Engineer) (Charlie Chang)

TABLE OF CONTENTS

| | | |
|----------|---|-----------|
| 1 | General Information..... | 6 |
| 1.1. | EUT Description..... | 6 |
| 1.2. | Mode of Operation..... | 6 |
| 1.3. | EUT Exercise Software..... | 7 |
| 1.4. | Configuration of Test System Details..... | 7 |
| 1.5. | Test Site Environment..... | 7 |
| 1.6. | Summary of Test Result..... | 8 |
| 2 | RF Output Power Test..... | 9 |
| 2.1. | Limit..... | 9 |
| 2.2. | Test Instruments..... | 9 |
| 2.3. | Test Setup..... | 9 |
| 2.4. | Test Procedure..... | 10 |
| 2.5. | Uncertainty..... | 10 |
| 2.6. | Test Result..... | 10 |
| 3 | Effective Radiated Power / Equivalent Isotropic Radiated Power Test..... | 11 |
| 3.1. | Limit..... | 11 |
| 3.2. | Test Instruments..... | 11 |
| 3.3. | Test Setup..... | 12 |
| 3.4. | Test Procedure..... | 13 |
| 3.5. | Uncertainty..... | 13 |
| 3.6. | Test Result..... | 14 |
| 4 | Occupied Bandwidth Test..... | 15 |
| 4.1. | Limit..... | 15 |
| 4.2. | Test Instruments..... | 15 |
| 4.3. | Setup..... | 15 |
| 4.4. | Test Procedure..... | 16 |
| 4.5. | Uncertainty..... | 16 |
| 4.6. | Test Result..... | 16 |
| 5 | Conducted Emission Test..... | 19 |
| 5.1. | Limit..... | 19 |
| 5.2. | Test Instruments..... | 19 |
| 5.3. | Setup..... | 19 |
| 5.4. | Test Procedure..... | 20 |
| 5.5. | Uncertainty..... | 20 |
| 5.6. | Test Result..... | 20 |

| | | |
|----------|---|-----------|
| 6 | Field Strength of Spurious Radiation Test | 36 |
| 6.1. | Limit | 36 |
| 6.2. | Test Instruments..... | 36 |
| 6.3. | Setup..... | 36 |
| 6.4. | Test Procedure..... | 37 |
| 6.5. | Uncertainty..... | 37 |
| 6.6. | Test Result | 38 |
| 7 | Frequency Stability (Temperature Variation) Test | 41 |
| 7.1. | Limit | 41 |
| 7.2. | Test Instruments..... | 41 |
| 7.3. | Setup..... | 41 |
| 7.4. | Test Procedure..... | 41 |
| 7.5. | Uncertainty..... | 42 |
| 7.6. | Test Result | 42 |
| 8 | Frequency Stability (Voltage Variation) Test | 43 |
| 8.1. | Limit | 43 |
| 8.2. | Test Instruments..... | 43 |
| 8.3. | Setup..... | 43 |
| 8.4. | Test Procedure..... | 43 |
| 8.5. | Uncertainty..... | 43 |
| 8.6. | Test Result | 44 |

1 General Information

1.1. EUT Description

| Applicant | Telit Communications S.p.A. | | | | |
|----------------------|---|------|--------------------|--------------------|------------|
| Applicant Address | Via Stazione di Prosecco, 5/B, Sgonico, TS 34010, Italy | | | | |
| Manufacturer | Telit Communications S.p.A. | | | | |
| Manufacturer Address | Via Stazione di Prosecco, 5/B, Sgonico, TS 34010, Italy | | | | |
| Product Type | 2G/3G Module | | | | |
| Trade Name | Telit | | | | |
| Model Number | HE910 | | | | |
| FCC ID | R17HE910 | | | | |
| IC ID | 5131A-HE910 | | | | |
| Hardware Version | 0 | | | | |
| Software Version | 12.00.002 | | | | |
| Mode | WCDMA | Band | UL Frequency (MHz) | DL Frequency (MHz) | Modulation |
| | | IV | 1712.4 ~ 1752.6 | 2112.4 ~ 2152.6 | QPSK |
| Max. RF Output Power | 26.40 dBm / 0.437 W | | | | |
| Max. EIRP | 22.75 dBm / 0.188 W | | | | |
| Emission Designator | 4M06F9W | | | | |

1.2. Mode of Operation

ATL has verified the construction and function in typical operation. All the test modes were carried out with the EUT in normal operation, which was shown in this test report and defined as:

| Test Mode |
|---------------------------------------|
| Mode 1: WCDMA Band IV Link (Transmit) |
| Mode 2: WCDMA Band IV Link (Receive) |

Note: Regards to the frequency band operation: the lowest, middle and highest frequency of channel were selected to perform the test, then shown on this report.

Tested System Details

The types for all equipments, plus descriptions of all cables used in the tested system (including inserted cards) are:

| | Product | Manufacturer | Model No. | Serial No. | Power Cord |
|----|--------------------------------------|--------------|-----------|------------|------------|
| 1. | Universal Radio Communication Tester | R&S | CMU200 | 109369 | N/A |

1.3. EUT Exercise Software

| | |
|----|--|
| 1. | Setup the EUT and Base Station (CMU200) as shown on 1.4. |
| 2. | Turn on the power of all equipment. |
| 3. | The EUT will start to operate function. |

1.4. Configuration of Test System Details

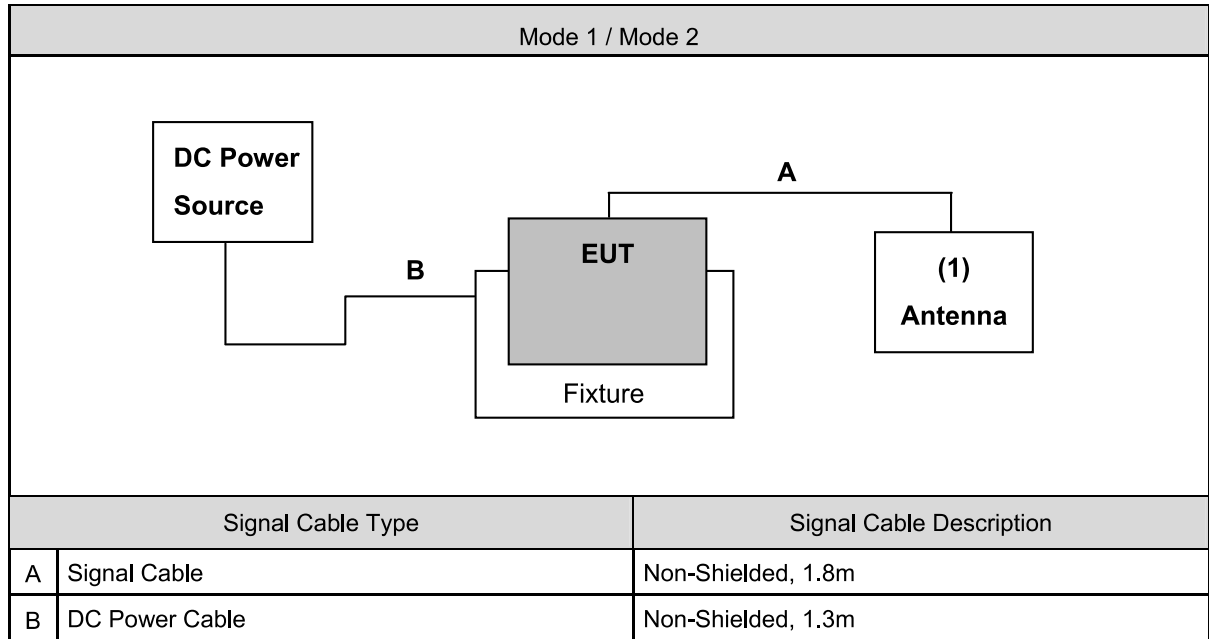

1.5. Test Site Environment

| Items | Required (IEC 68-1) | Actual |
|----------------------------|---------------------|--------|
| Temperature (°C) | 15-35 | 26 |
| Humidity (%RH) | 25-75 | 60 |
| Barometric pressure (mbar) | 860-1060 | 950 |

1.6. Summary of Test Result

| Description | FCC Rule | IC Rule | Limit | Result |
|---|----------------------|----------------------------------|--|--------|
| Conducted Output Power | §2.1046 | N/A | N/A | Pass |
| Equivalent Isotropic Radiated Power | §27.50(d)(2) | RSS-139 (6.4) SRSP-513(5.1.2) | < 1 Watts | Pass |
| Occupied Bandwidth | §2.1049 §27.53(g) | RSS-GEN(4.6.1) | N/A | Pass |
| Band Edge Measurement | §2.1051 §27.53(g) | RSS-139 (6.5) | $< 43 + 10 \log_{10}(P[\text{Watts}])$ | Pass |
| Conducted Emission | §2.1051 §27.53(g) | RSS-139 (6.5) | $< 43 + 10 \log_{10}(P[\text{Watts}])$ | Pass |
| Field Strength of Spurious Radiation | §2.1053 §27.53(g) | RSS-139 (6.5) RSS-GEN(4.10) | $< 43 + 10 \log_{10}(P[\text{Watts}])$ | Pass |
| Frequency Stability for Temperature & Voltage | §2.1055 §27.54 | RSS-139(6.3) | < 2.5 ppm | Pass |

2 RF Output Power Test

2.1. Limit

N/A

2.2. Test Instruments

| Describe | Manufacturer | Model No. | Serial No. | Cal. Date | Remark |
|--------------------------------------|-----------------|-----------|------------|------------|--------|
| Universal Radio Communication Tester | ROHDE & SCHWARZ | CMU200 | 109369 | 08/10/2010 | (2) |
| Single Channel PK Power Sensor | Agilent | N1911A | MY45101619 | 12/15/2011 | (1) |
| Wideband Power Meter | Agilent | N1921A | MY45241957 | 12/15/2011 | (1) |
| Test Site | ATL | TE02 | TE02 | N.C.R. | ----- |

Remark: ⁽¹⁾ Calibration period 1 year. ⁽²⁾ Calibration period 2 years.

NOTE: N.C.R. = No Calibration Request.

2.3. Test Setup

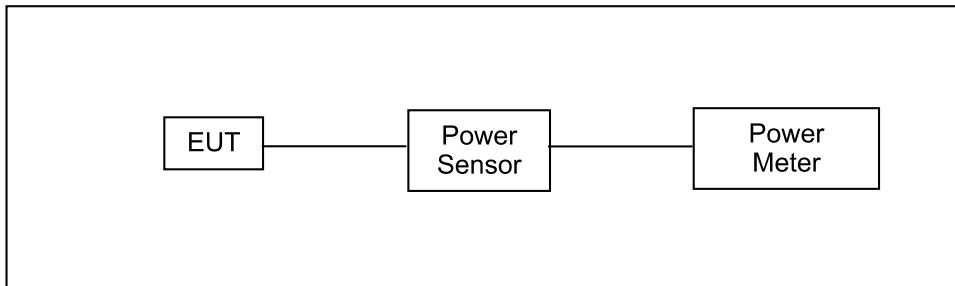

2.4. Test Procedure

The measurement is made according to ANSI/TIA-603-C-2004 as follows:

1. The transmitter output was connected to power meter and base station through power divider.
2. Set base station for EUT at WCDMA Band IV, power level was set to maximum.
3. Select lowest, middle, and highest channels for each band.

2.5. Uncertainty

The measurement uncertainty is defined as for RF output power measurement is 1.2 dB.

2.6. Test Result

| Product | 2G/3G Module | | | | | |
|----------------------|-----------------|-----------------|---------------|-----------|--------------|--------------|
| Test Item | RF Output Power | | | | | |
| Date of Test | 12/06/2011 | | | Test Site | TE02 | |
| Bands | Sub-Test | Frequency (MHz) | Average Power | | Peak Power | |
| | | | (dBm) | (W) | (dBm) | (W) |
| WCDMA IV (RMC 12.2K) | ---- | 1712.4 | 23.54 | 0.226 | 26.40 | 0.437 |
| | | 1740.0 | 23.48 | 0.223 | 26.30 | 0.427 |
| | | 1752.6 | 23.46 | 0.222 | 26.32 | 0.429 |

Note: The testing result was used peak detector.

3 Effective Radiated Power / Equivalent Isotropic Radiated Power Test

3.1. Limit

For FCC Part 27.50(d)(2): The EIRP of mobile transmitters are limited to 1 watt for 1710~1755 MHz.

3.2. Test Instruments

| 3 Meter Chamber (966-A) | | | | | |
|-----------------------------------|--------------------------------|--------------|---------------|------------|--------|
| Equipment | Manufacturer | Model Number | Serial Number | Cal. Date | Remark |
| RF Pre-selector | Agilent | N9039A | MY46520256 | 05/23/2011 | (2) |
| Spectrum Analyzer | Agilent | E4446A | MY46180578 | 01/18/2011 | (1) |
| Pre Amplifier | Agilent | 8449B | 3008A02237 | 02/23/2011 | (1) |
| Pre Amplifier | Agilent | 8447D | 2944A10961 | 02/23/2011 | (1) |
| Broadband Antenna (30MHz~1GHz) | SCHWARZBECK MESS-ELEKTRONIK | VULB9163 | 9163-270 | 07/29/2011 | (1) |
| Horn Antenna (1~18GHz) | SCHWARZBECK MESS-ELEKTRONIK | BBHA9120D | 9120D-550 | 06/29/2011 | (1) |
| Horn Antenna (18~40GHz) | SCHWARZBECK MESS-ELEKTRONIK | BBHA9170 | 9170-320 | 06/28/2011 | (1) |
| Test Site | ATL | TE01 | 888001 | 12/20/2011 | (1) |

Remark: ⁽¹⁾ Calibration period 1 year. ⁽²⁾ Calibration period 2 years.

NOTE: N.C.R. = No Calibration Request.

3.3. Test Setup

Below 1 GHz

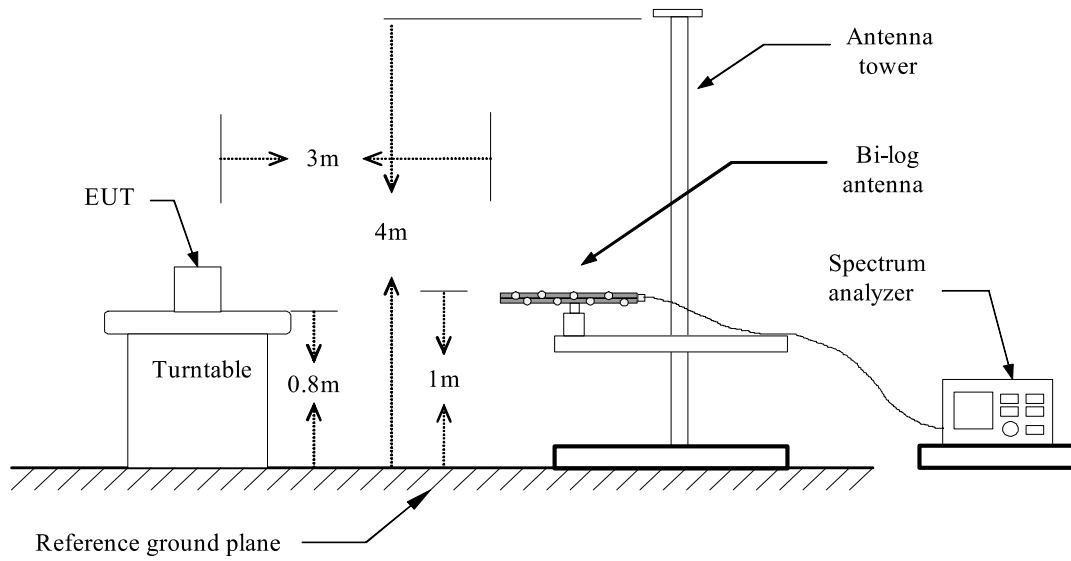

Above 1 GHz

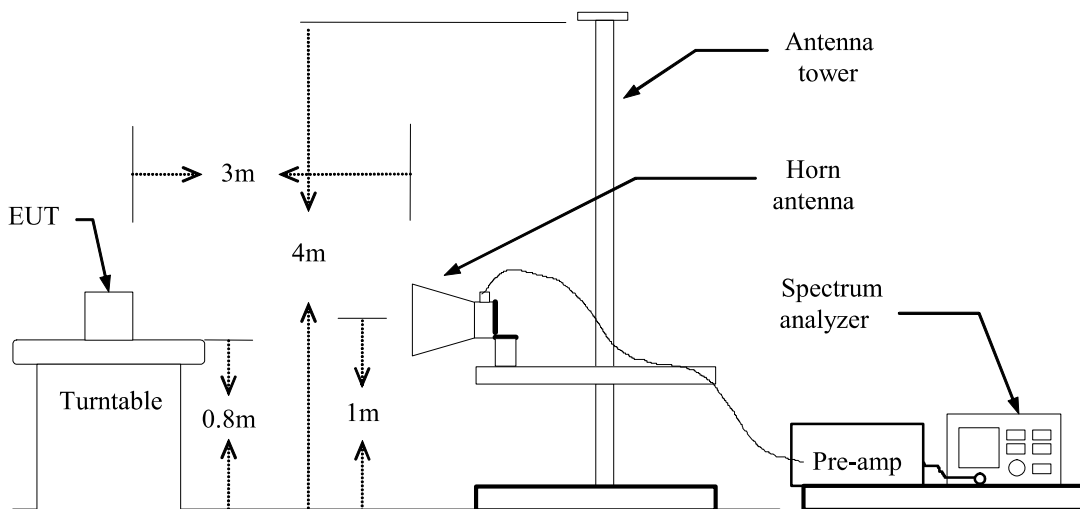

For Substituted Method Test Set-UP

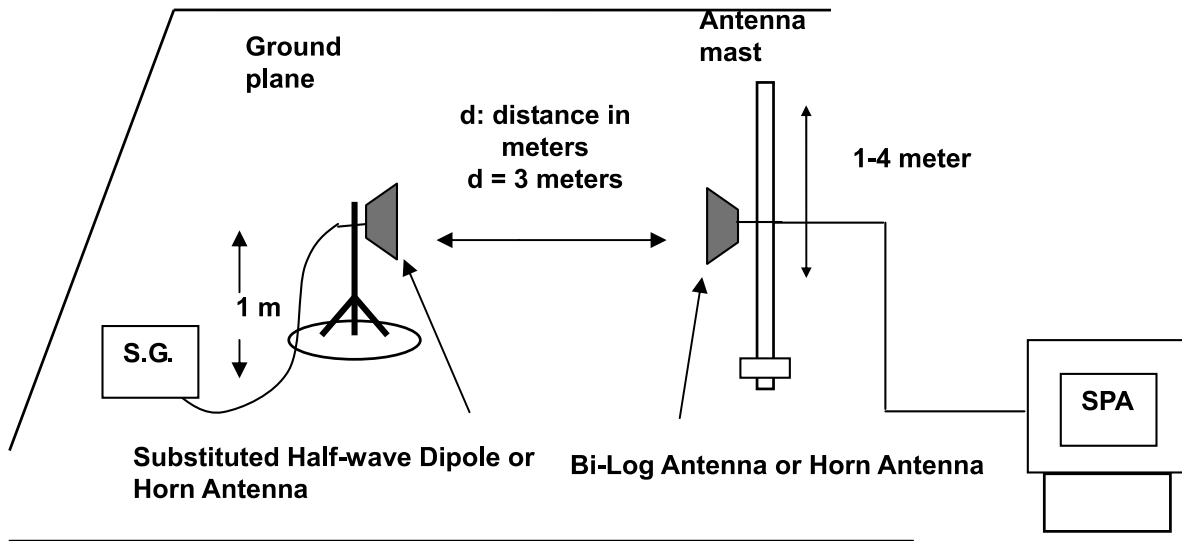

3.4. Test Procedure

The measurement is made according to ANSI/TIA-603-C-2004 as follows:

The EUT was placed on a non-conductive turntable using a non-conductive support. The radiated emission at the fundamental frequency was measured at 3 m with a test antenna and EMI spectrum analyzer.

During the measurement of the EUT, the resolution bandwidth was set to 3MHz and the average bandwidth was set to 3MHz. The highest emission was recorded with the rotation of the turntable and the lowering of the test antenna. The reading was recorded and the field strength (E in dBuV/m) was calculated.

ERP in frequency band 824-849MHz, and EIRP in frequency band 1851.25 –1910MHz were measured using a substitution method. The EUT was replaced by half-wave dipole (824-849MHz) or horn antenna (1851.25-1910MHz) connected to a signal generator. The spectrum analyzer reading was recorded and ERP/EIRP was calculated as follows:

$$\text{ERP} = \text{S.G. output (dBm)} + \text{Antenna Gain (dBd)} - \text{Cable (dB)}$$

$$\text{EIRP} = \text{S.G. output (dBm)} + \text{Antenna Gain (dBi)} - \text{Cable (dB)}$$

3.5. Uncertainty

The measurement uncertainty is defined as for Field Strength of Spurious Radiation measurement is ± 3.072 dB.

3.6. Test Result

| Model Number | HE910 | | | | | | |
|----------------------|----------------------------|-------------|------------------|-------------------------|--------------|--------------|-----------|
| Test Item | E.IR.P. | | | | | | |
| Test Mode | Mode 1: WCDMA Band IV Link | | | | | | |
| Date of Test | 01/06/2012 | | | | Test Site | TE01 | |
| Bands | Frequency (MHz) | Ant. Polar. | Read Level (dBm) | Correction factor (dBm) | E.IR.P. | | Limit (W) |
| | | | | | (dBm) | (W) | |
| WCDMA IV (RMC 12.2K) | 1712.4 | H | 10.14 | 10.45 | 20.59 | 0.115 | < 1 |
| | | V | 15.51 | 7.24 | 22.75 | 0.188 | < 1 |
| | 1740.0 | H | 8.30 | 10.45 | 18.75 | 0.075 | < 1 |
| | | V | 14.94 | 7.39 | 22.33 | 0.171 | < 1 |
| | 1752.6 | H | 10.18 | 10.45 | 20.63 | 0.116 | < 1 |
| | | V | 14.54 | 7.55 | 22.09 | 0.162 | < 1 |

Note: 1. ERP/EIRP = Read Level + Correction factor.

2. For WCDMA signals, a peak detector is used with RBW = VBW = 5MHz.

3. For AMPS, GSM, and NADC TDMA signals, a peak detector is used, with RBW = VBW= 1 MHz.

4 Occupied Bandwidth Test

4.1. Limit

The Occupied Bandwidth Limit:

N/A.

The Band Edge Limit:

The power of any emission outside of the authorized operating frequency ranges must be attenuated below the transmitting power (P) by a factor of at least $43 + 10\log(P)$ dB.

4.2. Test Instruments

| Describe | Manufacturer | Model No. | Serial No. | Cal. Date | Remark |
|--------------------------------------|-----------------|-----------|------------|------------|--------|
| Spectrum Analyzer | Agilent | E4445A | MY46181986 | 05/16/2011 | (2) |
| Universal Radio Communication Tester | ROHDE & SCHWARZ | CMU200 | 109369 | 08/10/2010 | (2) |
| Attenuator | RADIALL | R41572000 | 0603033073 | N.C.R. | ----- |
| Power divider | Agilent | 87302C | 3239A00760 | N.C.R. | ----- |
| Test Site | ATL | TE05 | TE05 | N.C.R. | ----- |

Remark: ⁽¹⁾ Calibration period 1 year. ⁽²⁾ Calibration period 2 years.

NOTE: N.C.R. = No Calibration Request.

4.3. Setup

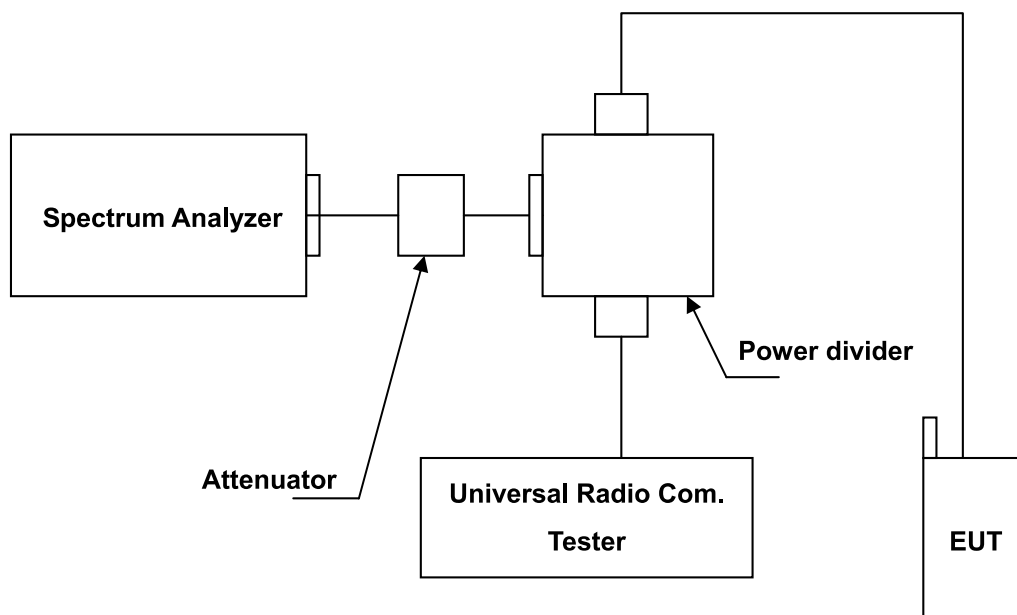

4.4. Test Procedure

The measurement is made according to FCC rules part 27:

1. The EUT was connected to Spectrum Analyzer and Base Station via power divider.
2. The occupied bandwidth of middle channel for the highest and lowest RF powers was measured.
3. The band edge of low and high channels for the highest RF powers within the transmitting frequency band were measured. Setting RBW as roughly BW/100.
4. The band edge setting:RB=51 kHz; VB=160 kHz for WCDMA Band IV.

4.5. Uncertainty

The measurement uncertainty is defined as $\pm 10\text{Hz}$

4.6. Test Result

| Product | 2G/3G Module | | | |
|--------------|----------------------------|----------------------|-------|--------------------------|
| Test Item | Occupied Bandwidth | | | |
| Test Mode | Mode 1: WCDMA Band IV Link | | | |
| Date of Test | 01/06/2012 | Test Site | TE05 | |
| Channel No. | Frequency (MHz) | 99 % Bandwidth (MHz) | Limit | Note |
| 1312 | 1712.4 | 4.0633 | N/A | RBW:100 kHz , VBW:300kHz |
| 1450 | 1740.0 | 4.0610 | N/A | RBW:100 kHz , VBW:300kHz |
| 1513 | 1752.6 | 4.0661 | N/A | RBW:100 kHz , VBW:300kHz |

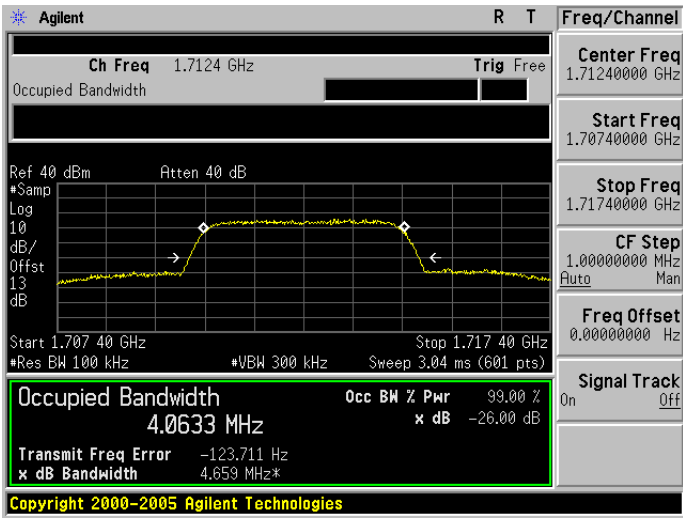
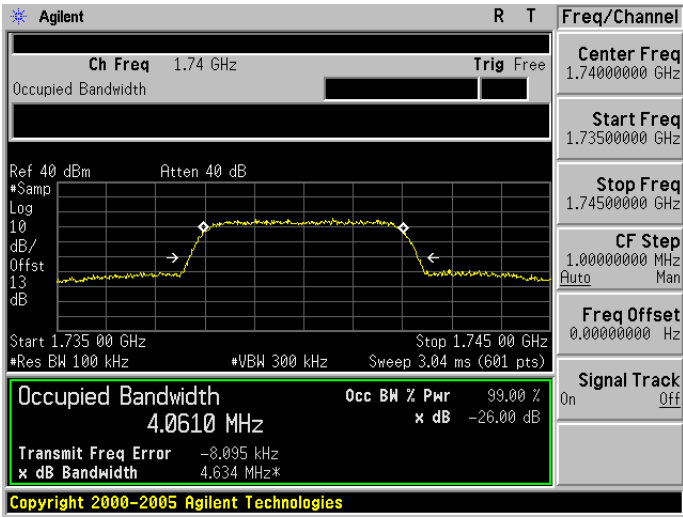
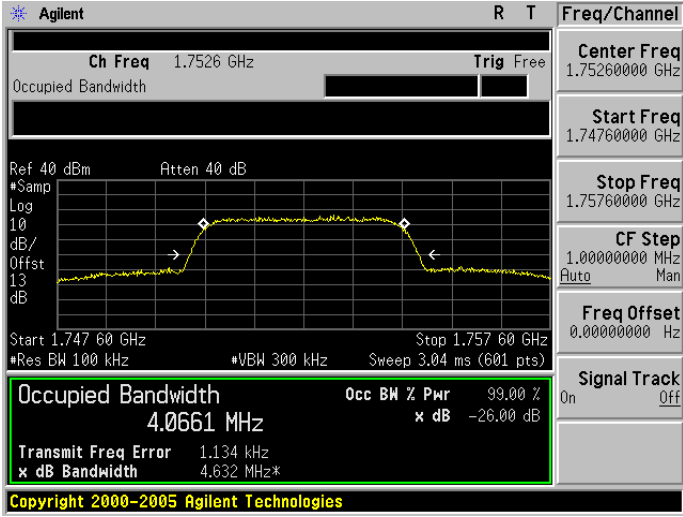
| Mode 1: WCDMA Band IV Link | |
|----------------------------|--|
| <p>CH 1312</p> |  <p>Agilent R T Freq/Channel</p> <p>Ch Freq 1.7124 GHz Trig Free</p> <p>Center Freq 1.71240000 GHz</p> <p>Start Freq 1.70740000 GHz</p> <p>Stop Freq 1.71740000 GHz</p> <p>CF Step 1.00000000 MHz Auto Man</p> <p>Freq Offset 0.00000000 Hz</p> <p>Signal Track On Off</p> <p>Ref 40 dBm Atten 40 dB</p> <p>#Samp 10</p> <p>Log dB/Offst 13 dB</p> <p>Start 1.707 40 GHz Stop 1.717 40 GHz</p> <p>#Res BW 100 kHz #VBW 300 kHz Sweep 3.04 ms (601 pts)</p> <p>Occupied Bandwidth 4.0633 MHz</p> <p>Occ BW % Pwr 99.00 %</p> <p>x dB -26.00 dB</p> <p>Transmit Freq Error -123.711 Hz</p> <p>x dB Bandwidth 4.659 MHz*</p> <p>Copyright 2000-2005 Agilent Technologies</p> |
| <p>CH1450</p> |  <p>Agilent R T Freq/Channel</p> <p>Ch Freq 1.74 GHz Trig Free</p> <p>Center Freq 1.74000000 GHz</p> <p>Start Freq 1.73500000 GHz</p> <p>Stop Freq 1.74500000 GHz</p> <p>CF Step 1.00000000 MHz Auto Man</p> <p>Freq Offset 0.00000000 Hz</p> <p>Signal Track On Off</p> <p>Ref 40 dBm Atten 40 dB</p> <p>#Samp 10</p> <p>Log dB/Offst 13 dB</p> <p>Start 1.735 00 GHz Stop 1.745 00 GHz</p> <p>#Res BW 100 kHz #VBW 300 kHz Sweep 3.04 ms (601 pts)</p> <p>Occupied Bandwidth 4.0610 MHz</p> <p>Occ BW % Pwr 99.00 %</p> <p>x dB -26.00 dB</p> <p>Transmit Freq Error -8.095 kHz</p> <p>x dB Bandwidth 4.634 MHz*</p> <p>Copyright 2000-2005 Agilent Technologies</p> |
| <p>CH1513</p> |  <p>Agilent R T Freq/Channel</p> <p>Ch Freq 1.7526 GHz Trig Free</p> <p>Center Freq 1.75260000 GHz</p> <p>Start Freq 1.74760000 GHz</p> <p>Stop Freq 1.75760000 GHz</p> <p>CF Step 1.00000000 MHz Auto Man</p> <p>Freq Offset 0.00000000 Hz</p> <p>Signal Track On Off</p> <p>Ref 40 dBm Atten 40 dB</p> <p>#Samp 10</p> <p>Log dB/Offst 13 dB</p> <p>Start 1.747 60 GHz Stop 1.757 60 GHz</p> <p>#Res BW 100 kHz #VBW 300 kHz Sweep 3.04 ms (601 pts)</p> <p>Occupied Bandwidth 4.0661 MHz</p> <p>Occ BW % Pwr 99.00 %</p> <p>x dB -26.00 dB</p> <p>Transmit Freq Error 1.134 kHz</p> <p>x dB Bandwidth 4.632 MHz*</p> <p>Copyright 2000-2005 Agilent Technologies</p> |

Band Edge

| Product | 2G/3G Module | | | | |
|--------------|----------------------------|-----------------|-----------------|-------------|--------|
| Test Item | Band Edge | | | | |
| Test Mode | Mode 1: WCDMA Band IV Link | | | | |
| Date of Test | 01/06/2012 | | Test Site | TE05 | |
| Band | Channel | Frequency (MHz) | Band Edge (dBm) | Limit (dBm) | Result |
| Lower | 1312 | 1710.00 | -27.99 | -13 | Pass |
| Higher | 1513 | 1755.00 | -28.54 | -13 | Pass |

Lower Band

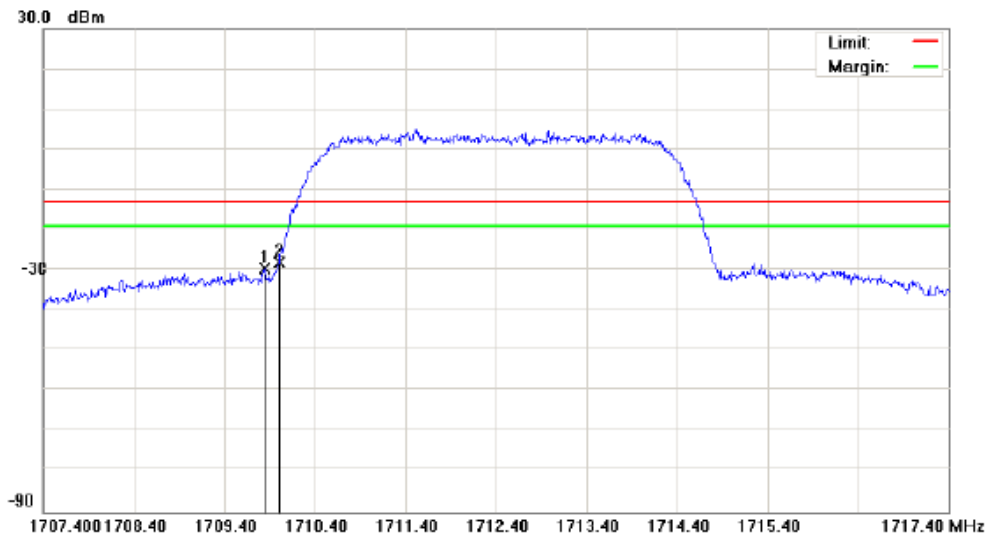

Higher Band

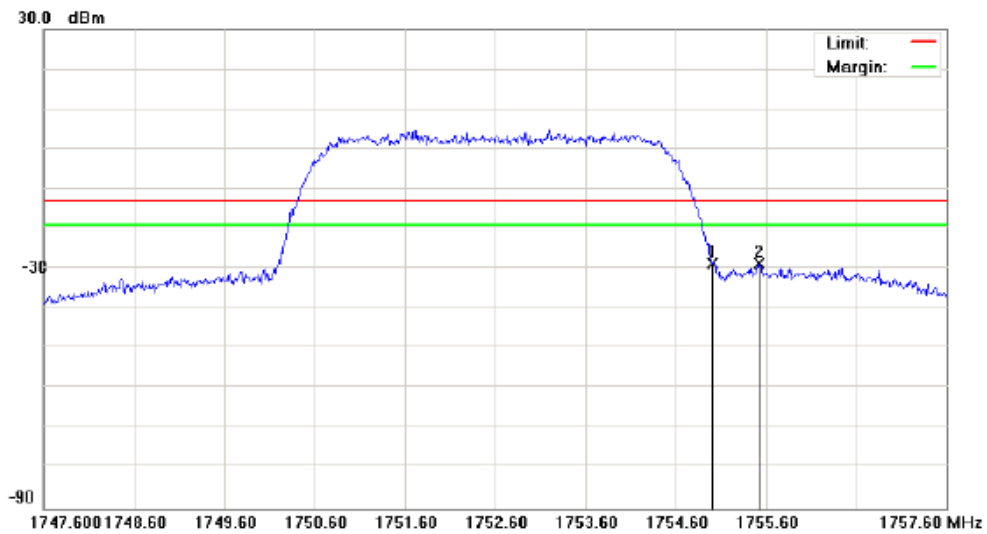

5 Conducted Emission Test

5.1. Limit

The power of any emission outside of the authorized operating frequency ranges must be attenuated below the transmitting power (P) by a factor of at least $43 + 10\log(P)$ dB.

5.2. Test Instruments

| Describe | Manufacturer | Model No. | Serial No. | Cal. Date | Remark |
|--------------------------------------|-----------------|-----------|------------|------------|--------|
| Spectrum Analyzer | Agilent | E4445A | MY46181986 | 05/16/2011 | (2) |
| Universal Radio Communication Tester | ROHDE & SCHWARZ | CMU200 | 109369 | 08/10/2010 | (2) |
| Attenuator | RADIALL | R41572000 | 0603033073 | N.C.R. | ---- |
| Power divider | Agilent | 87302C | 3239A00760 | N.C.R. | ---- |
| Test Site | ATL | TE05 | TE05 | N.C.R. | ---- |

Remark: ⁽¹⁾ Calibration period 1 year. ⁽²⁾ Calibration period 2 years.

NOTE: N.C.R. = No Calibration Request.

5.3. Setup

Below 2.8GHz

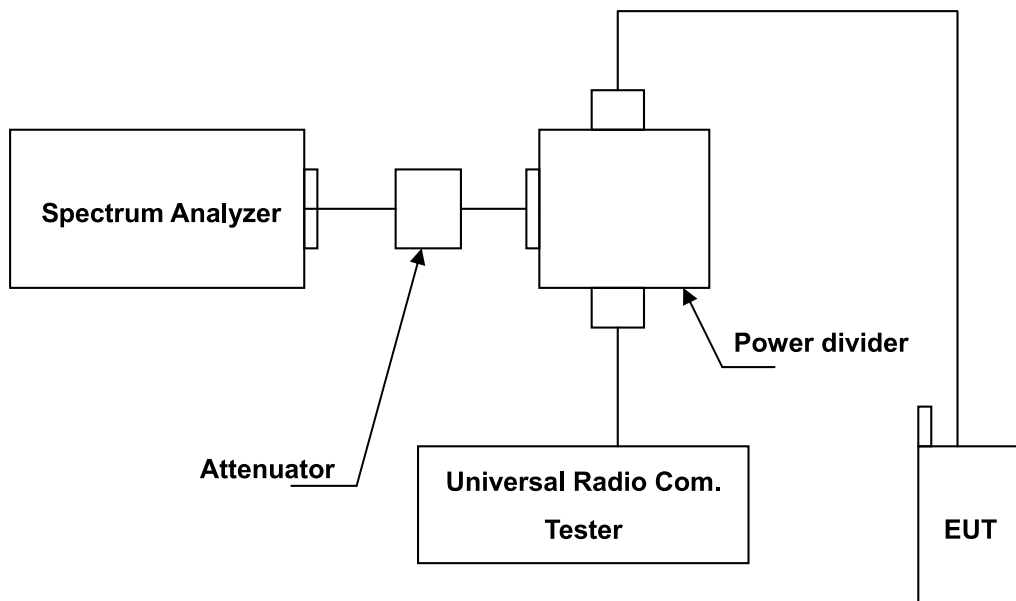

Above 2.8GHz

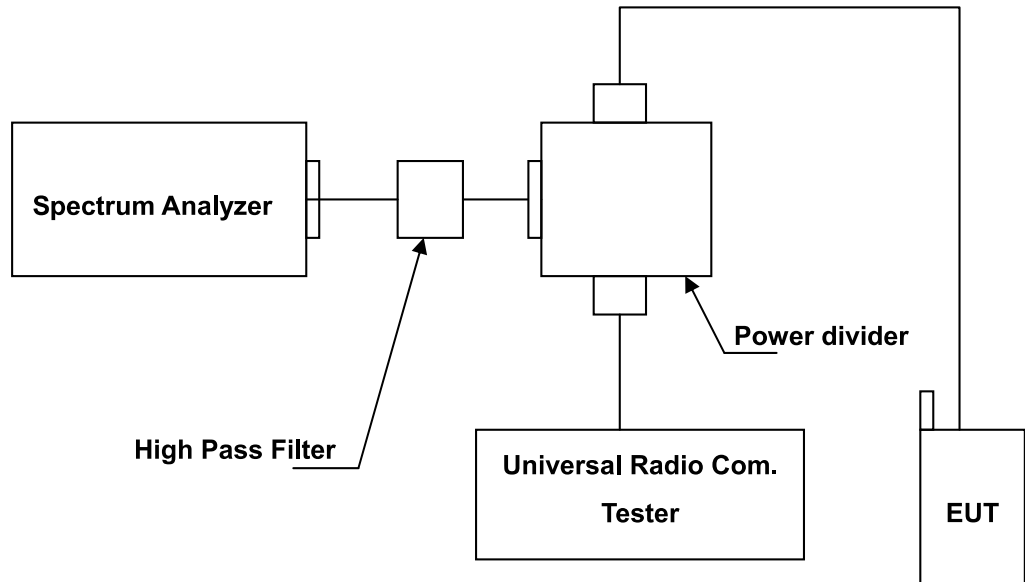

5.4. Test Procedure

1. The EUT was connected to Spectrum Analyzer and Base Station via power divider.
2. The middle channel for the highest RF power within the transmitting frequency was measured.
3. The conducted spurious emission for the whole frequency range was taken.
4. Test setting at WCDMA Band IV RB=1MHz, VB=1MHz.

5.5. Uncertainty

The measurement uncertainty is evaluated as ± 2.24 dB.

5.6. Test Result

| | | | |
|---------------------------------------|----------------------------|-----------|------|
| Product | 2G/3G Module | | |
| Test Item | Conducted Emission | | |
| Mode | Mode 1: WCDMA Band IV Link | | |
| Date of Test | 01/09/2012 | Test Site | TE05 |
| Note: The test results see next page. | | | |

File: HE910(CH1312)

Data: #1

Date: 2012/1/9

Time: 上午 09:40:41

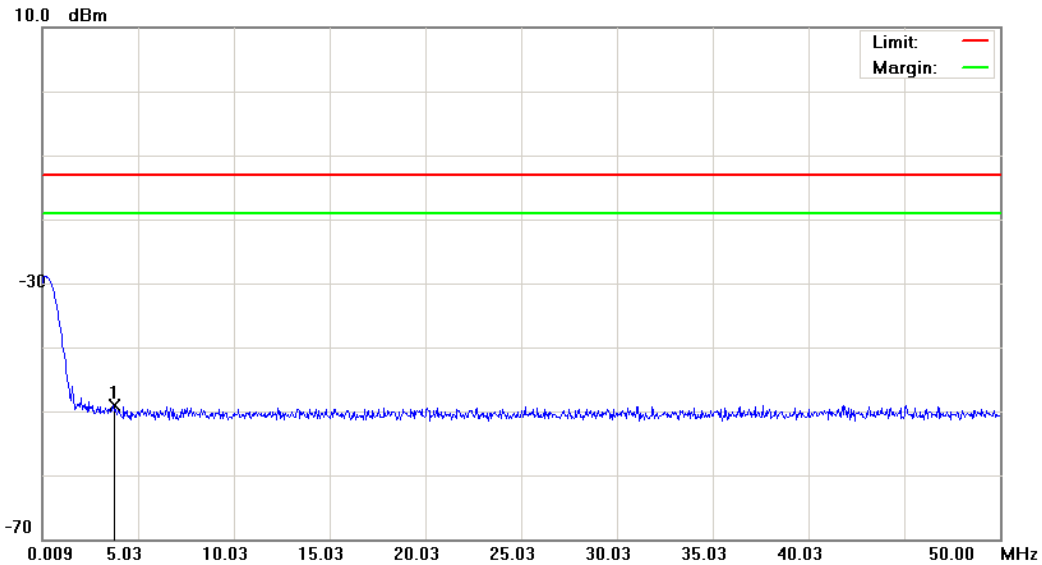

Site: : RF Conducted

 Polarization: **Conducted po**

Temperature: 23 °C

Limit: FCC Part 27 conducted(9k-12.75G)

Power: AC 120V/60Hz

Humidity: 55.2 %

EUT: 2G/3G Module

Distance:

RBW: 1000 KHz VBW: 1000 KHz

M/N: HE910

Mode: WCDMA Band IV

Note:

| No. | Mk. | Freq. | Reading Level | Correct Factor | Measurement | Limit | Over | Antenna Height | Table Degree | Comment |
|-----|-----|--------|---------------|----------------|-------------|--------|--------|----------------|--------------|---------|
| | | MHz | dBm | dB | dBm | dBm | dB | Detector | cm | degree |
| 1 | * | 3.7332 | -62.24 | 13.18 | -49.06 | -13.00 | -36.06 | peak | | |

*:Maximum data x:Over limit !:over margin

File: HE910(CH1312)

Data: #2

Date: 2012/1/9

Time: 上午 09:41:06

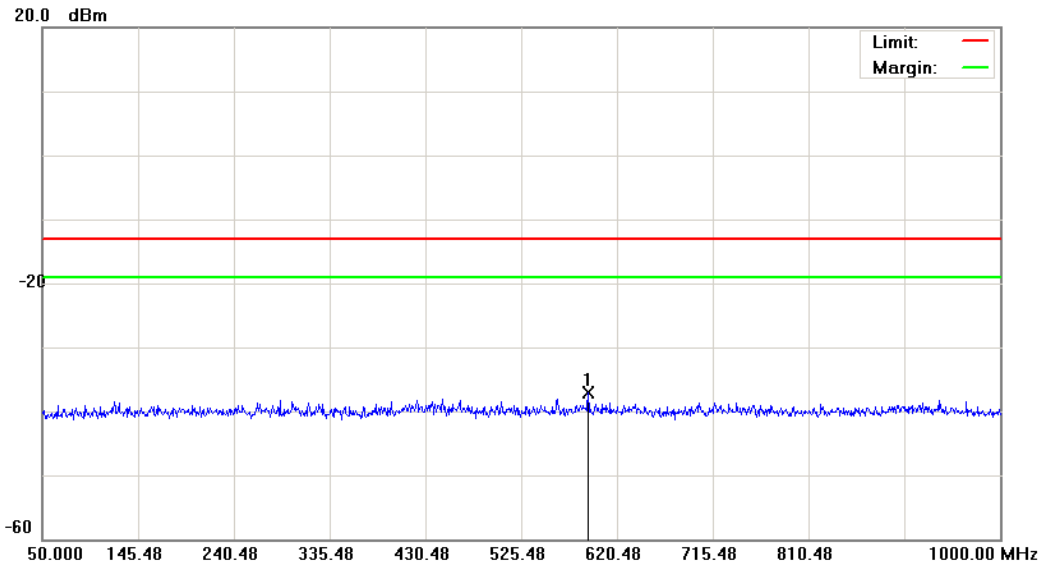

Site: : RF Conducted

 Polarization: **Conducted po**

Temperature: 23 °C

Limit: FCC Part 27 conducted(9k-12.75G)

Power: AC 120V/60Hz

Humidity: 55.2 %

EUT: 2G/3G Module

Distance:

RBW: 1000 KHz VBW: 1000 KHz

M/N: HE910

Mode: WCDMA Band IV

Note:

| No. | Mk. | Freq. | Reading Level | Correct Factor | Measurement | Limit | Over | Antenna Height | Table Degree | Detector | Comment |
|-----|-----|----------|---------------|----------------|-------------|--------|--------|----------------|--------------|----------|---------|
| | | MHz | dBm | dB | dBm | dBm | dB | cm | degree | | |
| 1 | * | 591.5000 | -50.32 | 13.20 | -37.12 | -13.00 | -24.12 | | | peak | |

*:Maximum data x:Over limit !:over margin

File :HE910(CH1312)

Data :#3

Date:2012/1/9

Time: 上午 09:50:34

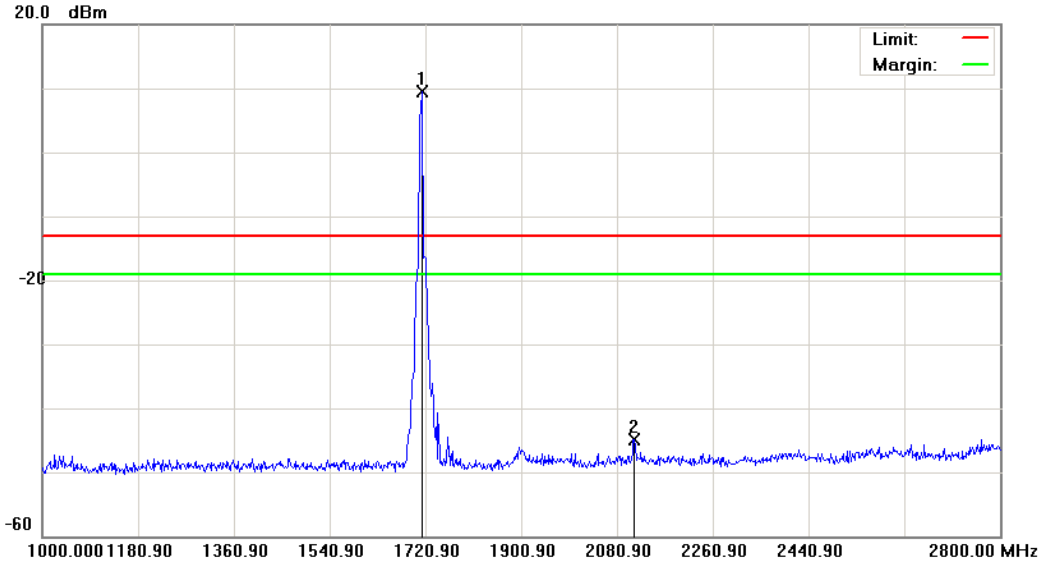

Site: : RF Conducted

 Polarization: **Conducted po**

Temperature: 23 °C

Limit: FCC Part 27 conducted(9k-12.75G)

Power: AC 120V/60Hz

Humidity: 55.2 %

EUT: 2G/3G Module

Distance:

RBW: 1000 KHz VBW: 1000 KHz

M/N: HE910

Mode: WCDMA Band IV

Note:

| No. | Mk. | Freq. MHz | Reading Level dBm | Correct Factor dB | Measure- ment dBm | Limit dBm | Over dB | Detector | Antenna Height cm | Table Degree degree | Comment |
|-----|-----|--------------|-------------------------|-------------------------|-------------------------|--------------|------------|----------|-------------------------|---------------------------|---------|
| 1 | * | 1713.700 | 5.06 | 4.36 | 9.42 | -13.00 | 22.42 | peak | | | Tx |
| 2 | | 2111.500 | -49.58 | 4.71 | -44.87 | -13.00 | -31.87 | peak | | | |

*:Maximum data x:Over limit !:over margin

File :HE910(CH1312)

Data :#4

Date:2012/1/9

Time: 上午 09:59:59

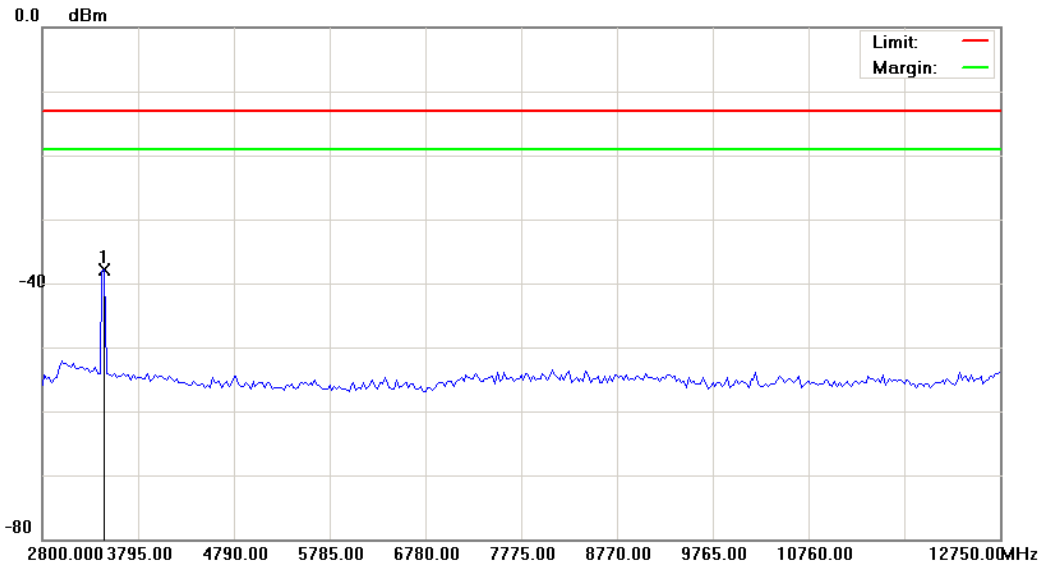

| | | |
|---|-----------------------------------|-----------------------------|
| Site: : RF Conducted | Polarization: Conducted po | Temperature: 23 °C |
| Limit: FCC Part 27 conducted(9k-12.75G) | Power: AC 120V/60Hz | Humidity: 55.2 % |
| EUT: 2G/3G Module | Distance: | RBW: 1000 KHz VBW: 1000 KHz |
| M/N: HE910 | | |
| Mode: WCDMA Band IV | | |
| Note: | | |

| No. | Mk. | Freq. | Reading Level | Correct Factor | Measurement | Limit | Over | Antenna Height | Table Degree | | |
|-----|-----|----------|---------------|----------------|-------------|--------|--------|----------------|--------------|--------|---------|
| | | MHz | dBm | dB | dBm | dBm | dB | Detector | cm | degree | Comment |
| 1 | * | 3446.750 | -42.98 | 5.08 | -37.90 | -13.00 | -24.90 | peak | | | |

*:Maximum data x:Over limit !:over margin

File :HE910(CH1312)

Data :#5

Date:2012/1/9

Time: 上午 10:00:20

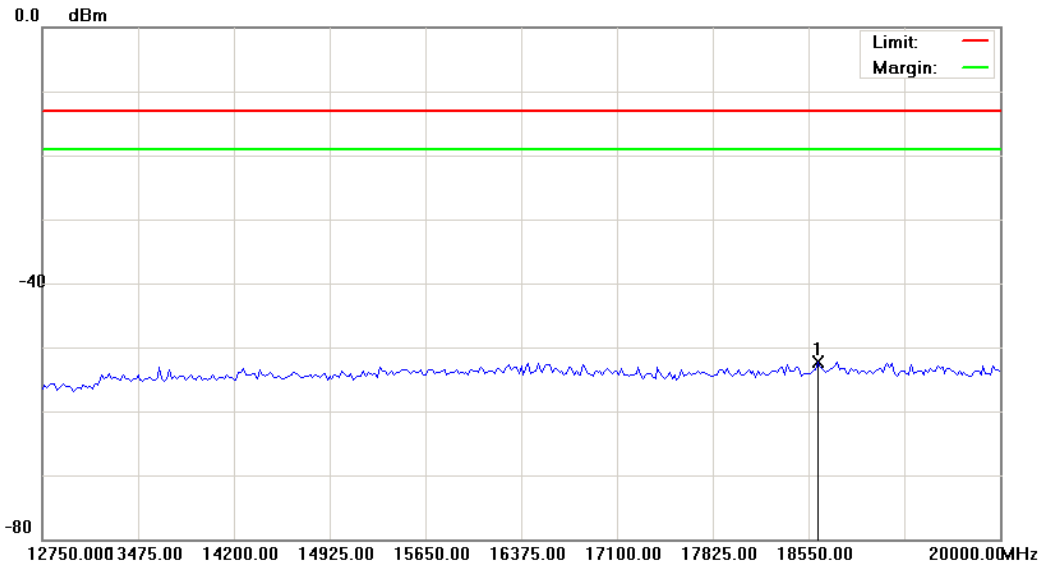

| | | |
|---|-----------------------------------|-----------------------------|
| Site: : RF Conducted | Polarization: Conducted po | Temperature: 23 °C |
| Limit: FCC Part 27 conducted(9k-12.75G) | Power: AC 120V/60Hz | Humidity: 55.2 % |
| EUT: 2G/3G Module | Distance: | RBW: 1000 KHz VBW: 1000 KHz |
| M/N: HE910 | | |
| Mode: WCDMA Band IV | | |
| Note: | | |

| No. | Mk. | Freq. | Reading Level | Correct Factor | Measurement | Limit | Over | Antenna Height | Table Degree | Comment |
|-----|-----|-----------|---------------|----------------|-------------|--------|--------|----------------|--------------|---------|
| | | MHz | dBm | dB | dBm | dBm | dB | Detector | cm | degree |
| 1 | * | 18622.500 | -59.36 | 7.05 | -52.31 | -13.00 | -39.31 | peak | | |

*:Maximum data x:Over limit !:over margin

File: HE910(CH1450)

Data: #1

Date: 2012/1/9

Time: 上午 09:42:23

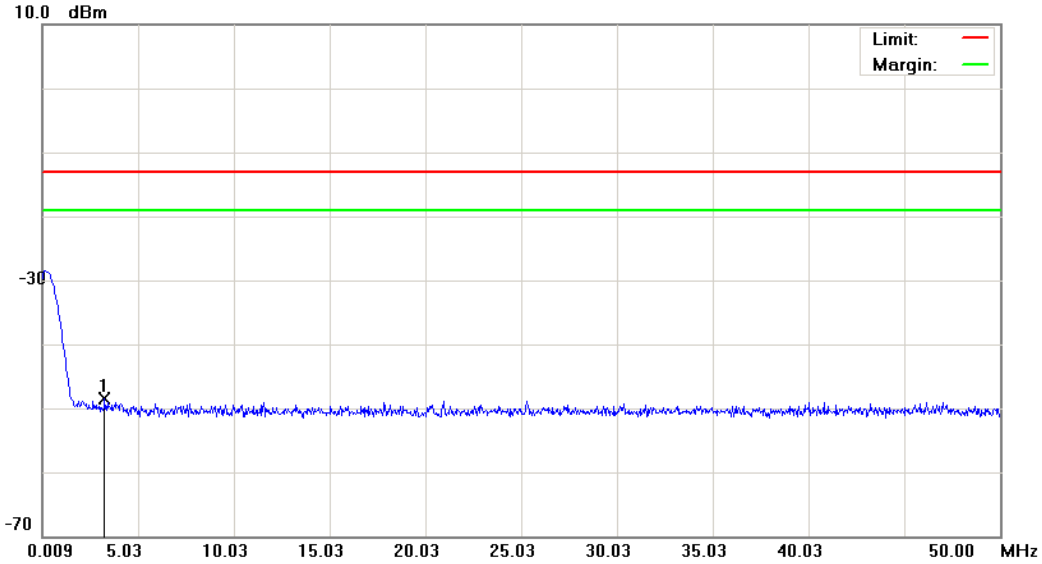

Site: : RF Conducted

 Polarization: **Conducted po**

Temperature: 23 °C

Limit: FCC Part 27 conducted(9k-12.75G)

Power: AC 120V/60Hz

Humidity: 55.2 %

EUT: 2G/3G Module

Distance:

RBW: 1000 KHz VBW: 1000 KHz

M/N: HE910

Mode: WCDMA Band IV

Note:

| No. | Mk. | Freq. | Reading Level | Correct Factor | Measurement | Limit | Over | Antenna Height | Table Degree | Detector | Comment |
|-----|-----|--------|---------------|----------------|-------------|--------|--------|----------------|--------------|----------|---------|
| | | MHz | dBm | dB | dBm | dBm | dB | cm | degree | | |
| 1 | * | 3.2583 | -61.49 | 13.08 | -48.41 | -13.00 | -35.41 | | | peak | |

*:Maximum data x:Over limit !:over margin

File :HE910(CH1450)

Data :#2

Date:2012/1/9

Time: 上午 09:42:48

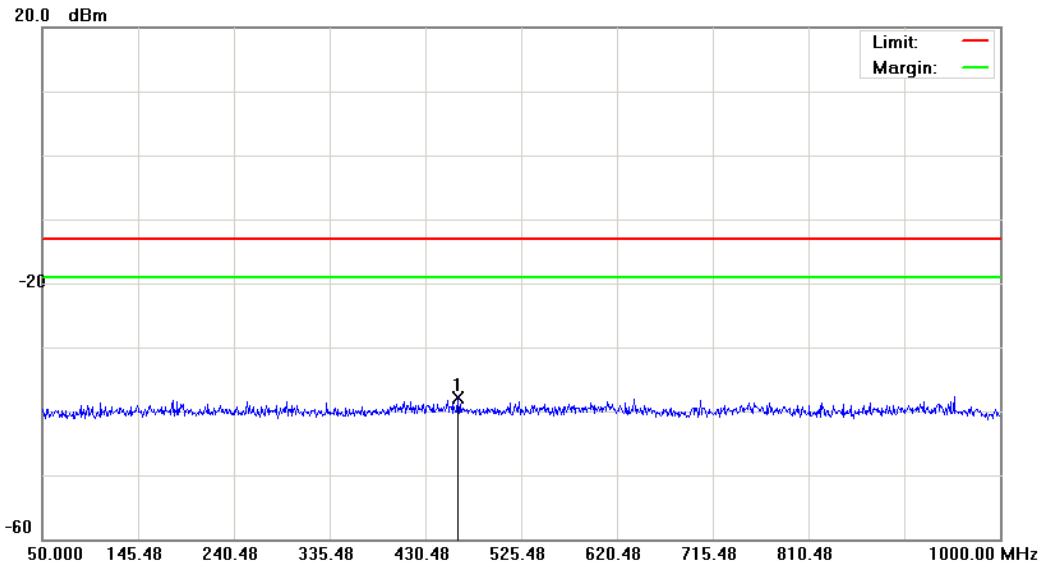

Site: : RF Conducted

 Polarization: **Conducted po**

Temperature: 23 °C

Limit: FCC Part 27 conducted(9k-12.75G)

Power: AC 120V/60Hz

Humidity: 55.2 %

EUT: 2G/3G Module

Distance:

RBW: 1000 KHz VBW: 1000 KHz

M/N: HE910

Mode: WCDMA Band IV

Note:

| No. | Mk. | Freq. | Reading Level | Correct Factor | Measurement | Limit | Over | Antenna Height | Table Degree | Detector | Comment |
|-----|-----|----------|---------------|----------------|-------------|--------|--------|----------------|--------------|----------|---------|
| | | MHz | dBm | dB | dBm | dBm | dB | cm | degree | | |
| 1 | * | 462.3000 | -51.10 | 13.20 | -37.90 | -13.00 | -24.90 | | | peak | |

*:Maximum data x:Over limit !:over margin

File :HE910(CH1450)

Data :#3

Date:2012/1/9

Time: 上午 09:48:18

20.0 dBm

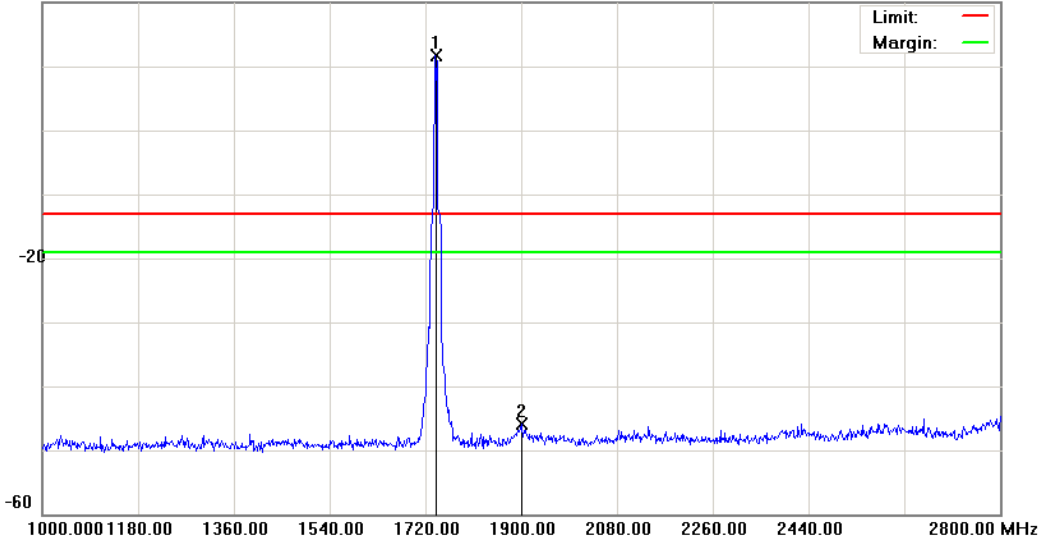

Site: : RF Conducted

 Polarization: *Conducted po*

Temperature: 23 °C

Limit: FCC Part 27 conducted(9k-12.75G)

Power: AC 120V/60Hz

Humidity: 55.2 %

EUT: 2G/3G Module

Distance:

RBW: 1000 KHz VBW: 1000 KHz

M/N: HE910

Mode: WCDMA Band IV

Note:

| No. | Mk. | Freq. MHz | Reading Level dBm | Correct Factor dB | Measure- ment dBm | Limit dBm | Over dB | Detector | Antenna Height cm | Table Degree degree | Comment |
|-----|-----|--------------|-------------------------|-------------------------|-------------------------|--------------|------------|----------|-------------------------|---------------------------|---------|
| 1 | * | 1738.900 | 7.09 | 4.66 | 11.75 | -13.00 | 24.75 | peak | | | Tx |
| 2 | | 1900.000 | -52.51 | 6.63 | -45.88 | -13.00 | -32.88 | peak | | | |

*:Maximum data x:Over limit !:over margin

File: HE910(CH1450)

Data: #4

Date: 2012/1/9

Time: 上午 10:01:10

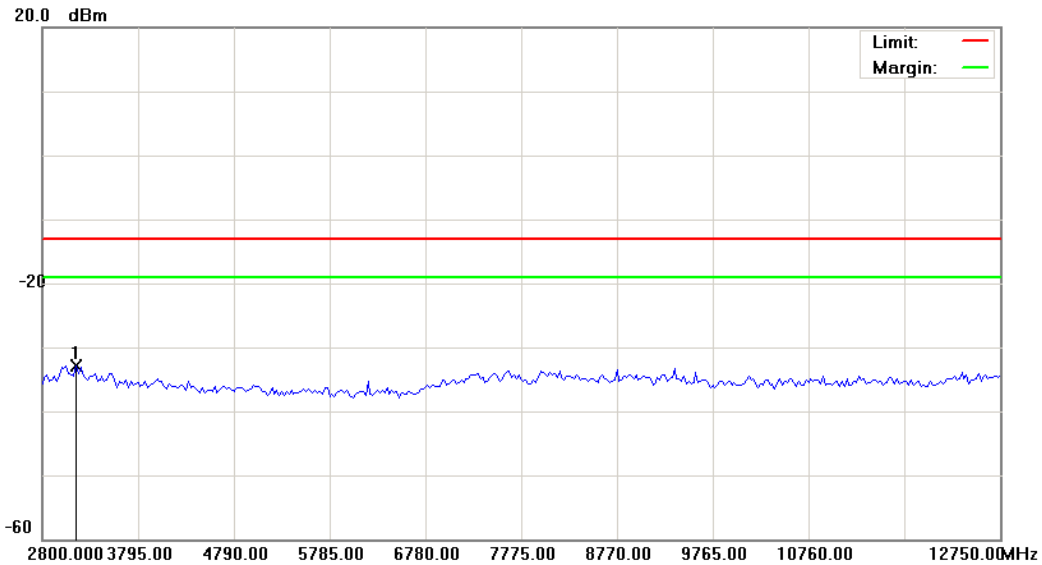

Site: : RF Conducted

 Polarization: **Conducted po**

Temperature: 23 °C

Limit: FCC Part 27 conducted(9k-12.75G)

Power: AC 120V/60Hz

Humidity: 55.2 %

EUT: 2G/3G Module

Distance:

RBW: 1000 KHz VBW: 1000 KHz

M/N: HE910

Mode: WCDMA Band IV

Note:

| No. | Mk. | Freq. | Reading Level | Correct Factor | Measurement | Limit | Over | Antenna Height | Table Degree | Detector | Comment |
|-----|-----|----------|---------------|----------------|-------------|--------|--------|----------------|--------------|----------|---------|
| | | MHz | dBm | dB | dBm | dBm | dB | cm | degree | | |
| 1 | * | 3148.250 | -38.24 | 5.27 | -32.97 | -13.00 | -19.97 | | | peak | |

*:Maximum data x:Over limit !:over margin

File :HE910(CH1450)

Data :#5

Date:2012/1/9

Time: 上午 10:01:32

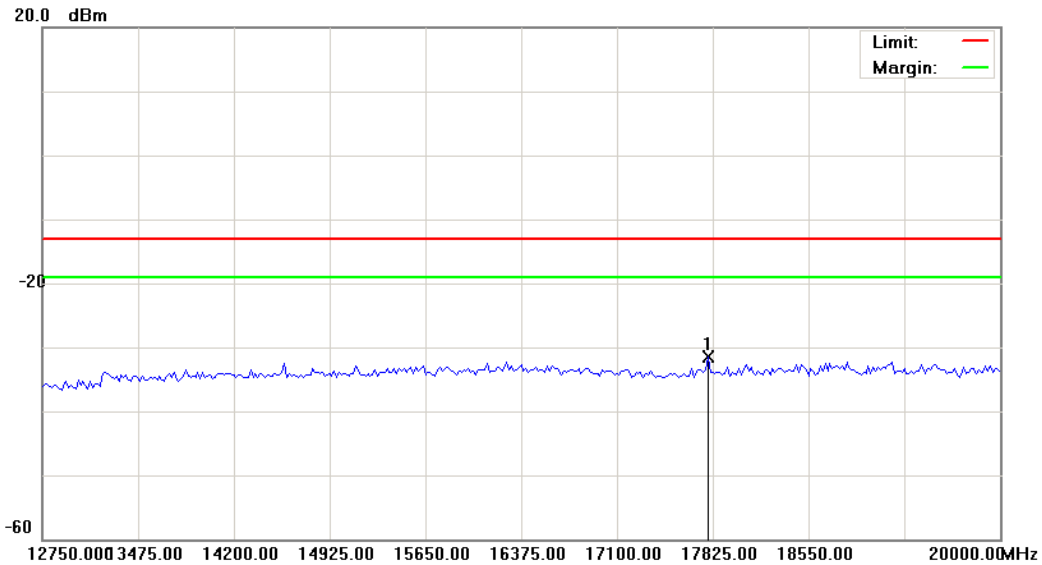

| | | |
|---|-----------------------------------|-----------------------------|
| Site: : RF Conducted | Polarization: Conducted po | Temperature: 23 °C |
| Limit: FCC Part 27 conducted(9k-12.75G) | Power: AC 120V/60Hz | Humidity: 55.2 % |
| EUT: 2G/3G Module | Distance: | RBW: 1000 KHz VBW: 1000 KHz |
| M/N: HE910 | | |
| Mode: WCDMA Band IV | | |
| Note: | | |

| No. | Mk. | Freq. | Reading Level | Correct Factor | Measurement | Limit | Over | Antenna Height | Table Degree |
|-----|-----|-----------|---------------|----------------|-------------|--------|--------|----------------|--------------|
| | | MHz | dBm | dB | dBm | dBm | dB | Detector | cm degree |
| 1 | * | 17788.750 | -38.38 | 6.81 | -31.57 | -13.00 | -18.57 | peak | |

*:Maximum data x:Over limit !:over margin

File: HE910(CH1513)

Data: #1

Date: 2012/1/9

Time: 上午 09:43:44

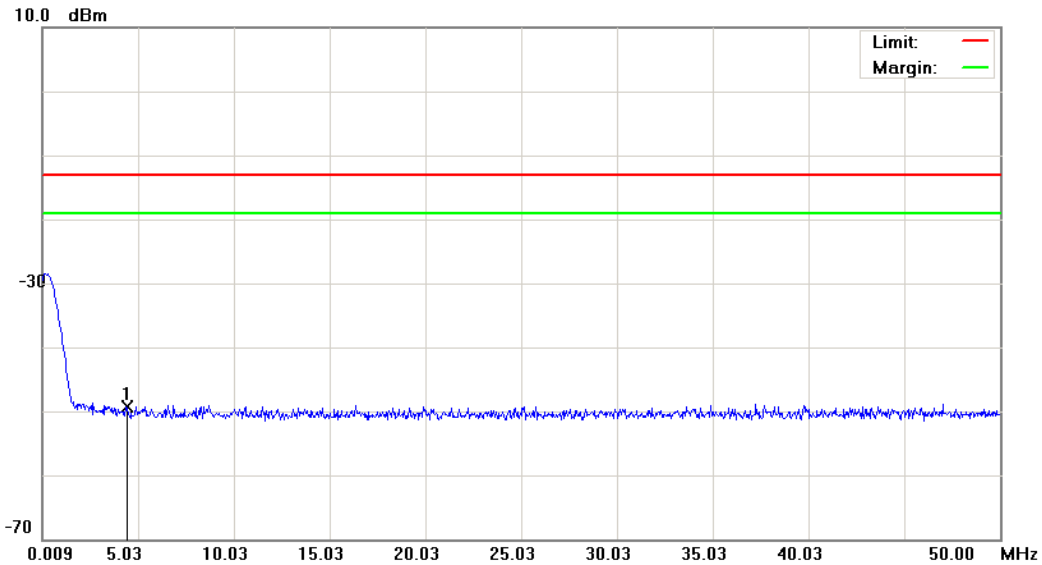

Site: : RF Conducted

 Polarization: **Conducted po**

Temperature: 23 °C

Limit: FCC Part 27 conducted(9k-12.75G)

Power: AC 120V/60Hz

Humidity: 55.2 %

EUT: 2G/3G Module

Distance:

RBW: 1000 KHz VBW: 1000 KHz

M/N: HE910

Mode: WCDMA Band IV

Note:

| No. | Mk. | Freq. | Reading Level | Correct Factor | Measurement | Limit | Over | Antenna Height | Table Degree | Detector | Comment |
|-----|-----|--------|---------------|----------------|-------------|--------|--------|----------------|--------------|----------|---------|
| | | MHz | dBm | dB | dBm | dBm | dB | cm | degree | | |
| 1 | * | 4.3832 | -62.44 | 13.22 | -49.22 | -13.00 | -36.22 | | | peak | |

*:Maximum data x:Over limit !:over margin

File :HE910(CH1513)

Data :#2

Date:2012/1/9

Time: 上午 09:44:09

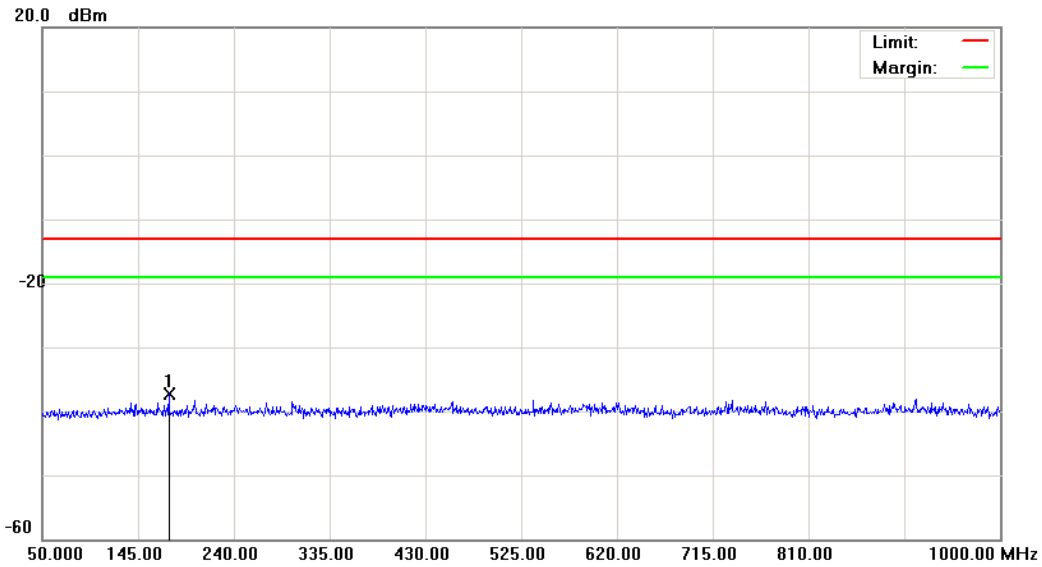

Site: : RF Conducted

 Polarization: **Conducted po**

Temperature: 23 °C

Limit: FCC Part 27 conducted(9k-12.75G)

Power: AC 120V/60Hz

Humidity: 55.2 %

EUT: 2G/3G Module

Distance:

RBW: 1000 KHz VBW: 1000 KHz

M/N: HE910

Mode: WCDMA Band IV

Note:

| No. | Mk. | Freq. | Reading Level | Correct Factor | Measurement | Limit | Over | Antenna Height | Table Degree | Detector | Comment |
|-----|-----|----------|---------------|----------------|-------------|--------|--------|----------------|--------------|----------|---------|
| | | MHz | dBm | dB | dBm | dBm | dB | cm | degree | | |
| 1 | * | 175.4000 | -50.61 | 13.29 | -37.32 | -13.00 | -24.32 | | | peak | |

*:Maximum data x:Over limit !:over margin

File :HE910(CH1513)

Data :#3

Date:2012/1/9

Time: 上午 09:46:13

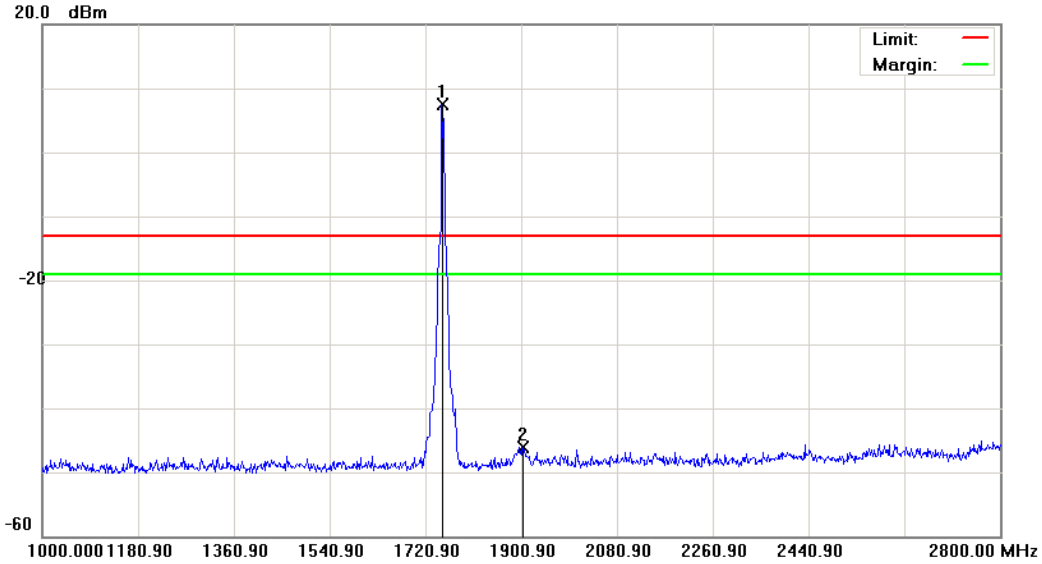

Site: : RF Conducted

 Polarization: **Conducted po**

Temperature: 23 °C

Limit: FCC Part 27 conducted(9k-12.75G)

Power: AC 120V/60Hz

Humidity: 55.2 %

EUT: 2G/3G Module

Distance:

RBW: 1000 KHz VBW: 1000 KHz

M/N: HE910

Mode: WCDMA Band IV

Note:

| No. | Mk. | Freq. MHz | Reading Level dBm | Correct Factor dB | Measure- ment dBm | Limit dBm | Over dB | Detector | Antenna Height cm | Table Degree degree | Comment |
|-----|-----|--------------|-------------------------|-------------------------|-------------------------|--------------|------------|----------|-------------------------|---------------------------|---------|
| 1 | * | 1751.500 | 2.86 | 4.63 | 7.49 | -13.00 | 20.49 | peak | | | Tx |
| 2 | | 1903.600 | -52.33 | 6.30 | -46.03 | -13.00 | -33.03 | peak | | | |

*:Maximum data x:Over limit !:over margin

File :HE910(CH1513)

Data :#4

Date:2012/1/9

Time: 上午 10:02:27

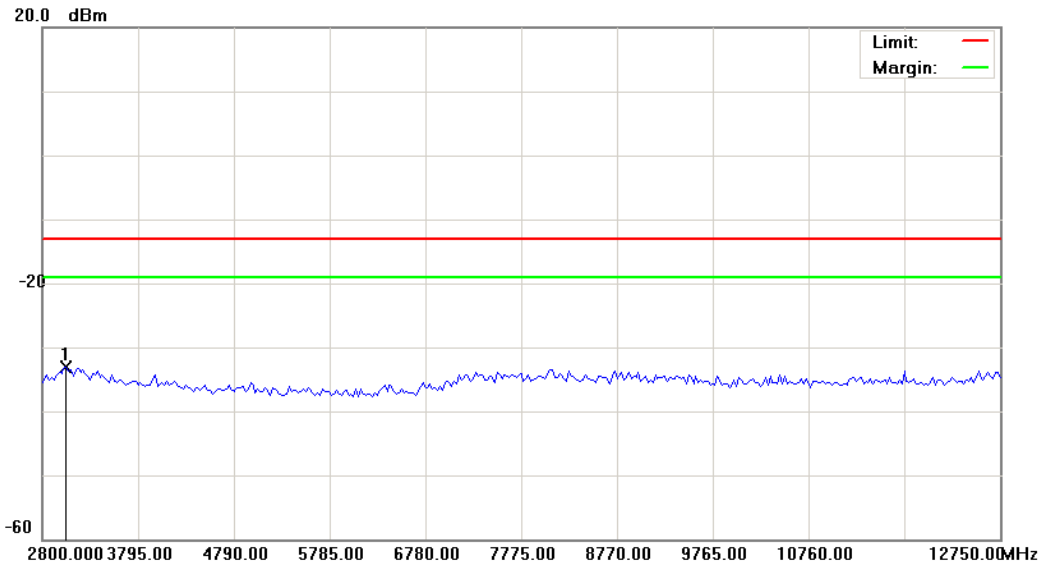

Site: : RF Conducted

 Polarization: **Conducted po**

Temperature: 23 °C

Limit: FCC Part 27 conducted(9k-12.75G)

Power: AC 120V/60Hz

Humidity: 55.2 %

EUT: 2G/3G Module

Distance:

RBW: 1000 KHz VBW: 1000 KHz

M/N: HE910

Mode: WCDMA Band IV

Note:

| No. | Mk. | Freq. | Reading Level | Correct Factor | Measurement | Limit | Over | Antenna Height | Table Degree | Detector | Comment |
|-----|-----|----------|---------------|----------------|-------------|--------|--------|----------------|--------------|----------|---------|
| | | MHz | dBm | dB | dBm | dBm | dB | cm | degree | | |
| 1 | * | 3048.750 | -38.63 | 5.47 | -33.16 | -13.00 | -20.16 | | | peak | |

*:Maximum data x:Over limit !:over margin

File: HE910(CH1513) Data: #5 Date: 2012/1/9 Time: 上午 10:02:49

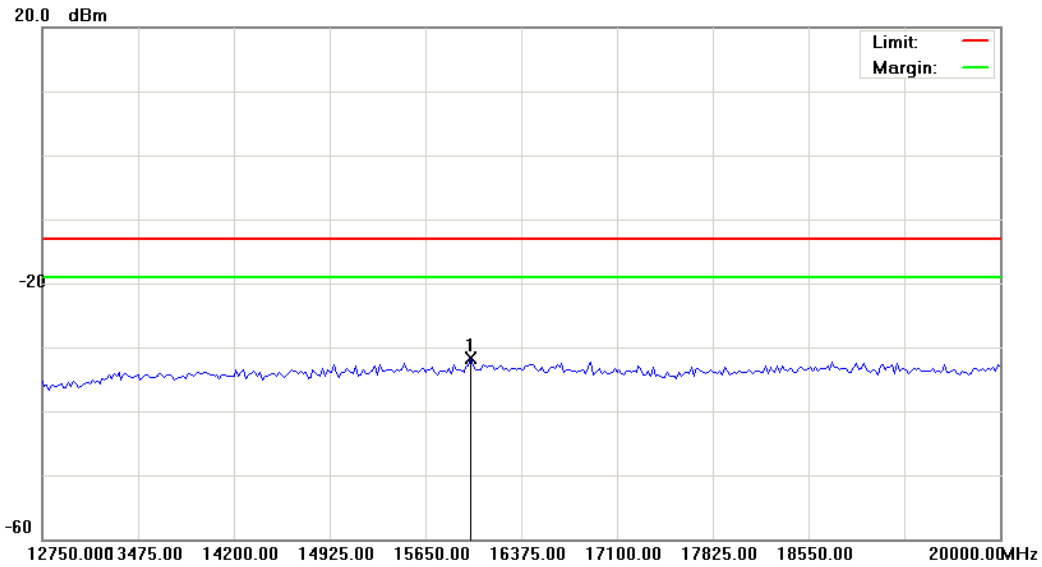

| | | |
|---|-----------------------------------|-----------------------------|
| Site: : RF Conducted | Polarization: Conducted po | Temperature: 23 °C |
| Limit: FCC Part 27 conducted(9k-12.75G) | Power: AC 120V/60Hz | Humidity: 55.2 % |
| EUT: 2G/3G Module | Distance: | RBW: 1000 KHz VBW: 1000 KHz |
| M/N: HE910 | | |
| Mode: WCDMA Band IV | | |
| Note: | | |

| No. | Mk. | Freq. | Reading Level | Correct Factor | Measurement | Limit | Over | Antenna Height | Table Degree |
|-----|-----|-----------|---------------|----------------|-------------|--------|--------|----------------|--------------|
| | | MHz | dBm | dB | dBm | dBm | dB | Detector | cm |
| 1 | * | 15994.375 | -38.03 | 6.30 | -31.73 | -13.00 | -18.73 | peak | |

*:Maximum data x:Over limit !:over margin

6 Field Strength of Spurious Radiation Test

6.1. Limit

The power of any emission outside of the authorized operating frequency ranges must be attenuated below the transmitting power (P) by a factor of at least $43 + 10\log(P)$ dB.

It is measured by means of a calibrated spectrum analyzer and scanned from 30 MHz up to a frequency including its 10th harmonic.

6.2. Test Instruments

| 3 Meter Chamber | | | | | |
|-----------------------------------|--------------------------------|-----------|------------|------------|--------|
| Equipment | Manufacturer | Model No. | Serial No. | Cal. Date | Remark |
| RF Pre-selector | Agilent | N9039A | MY46520256 | 05/23/2011 | (2) |
| Spectrum Analyzer | Agilent | E4446A | MY46180578 | 01/18/2011 | (1) |
| Pre Amplifier | Agilent | 8449B | 3008A02237 | 02/23/2011 | (1) |
| Pre Amplifier | Agilent | 8447D | 2944A10961 | 02/23/2011 | (1) |
| Broadband Antenna (30MHz~1GHz) | SCHWARZBECK MESS-ELEKTRONIK | VULB9163 | 9163-270 | 07/29/2011 | (1) |
| Horn Antenna (1~18GHz) | SCHWARZBECK MESS-ELEKTRONIK | BBHA9120D | 9120D-550 | 06/29/2011 | (1) |
| Horn Antenna (18~40GHz) | SCHWARZBECK MESS-ELEKTRONIK | BBHA9170 | 9170-320 | 06/28/2011 | (1) |
| Test Site | ATL | TE01 | 888001 | 12/20/2011 | (1) |

Remark: ⁽¹⁾ Calibration period 1 year. ⁽²⁾ Calibration period 2 years.

NOTE: N.C.R. = No Calibration Request.

6.3. Setup

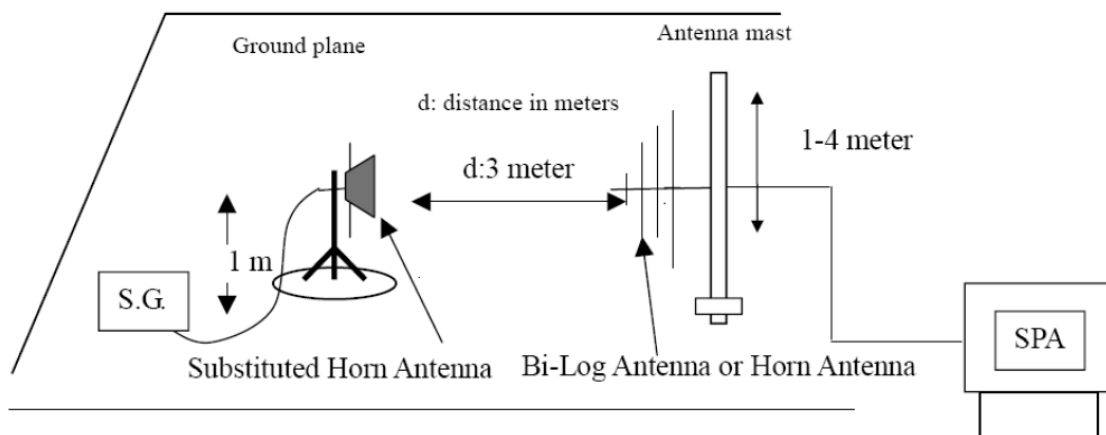

6.4. Test Procedure

The measurement is made according to ANSI/TIA-603-C-2004 as follows:

The equipment under test is placed inside the semi-anechoic chamber on a wooden table at the turntable center. For each spurious frequency, the antenna mast is raised and lowered from 1 to 4 meters and the turntable is rotated 360 degrees to obtain a maximum reading on the spectrum analyzer. This is repeated for both horizontal and vertical polarizations of the receive antenna.

The equipment under test is then replaced with a substitution antenna fed by a signal generator. With the signal generator tuned to a particular spurious frequency, the antenna mast is raised and lowered from 1 to 4 meters to obtain a maximum reading at the spectrum analyzer. The output of the signal generator is then adjusted until a reading identical to that obtained with the actual transmitter is achieved.

The power in dBm of each spurious emission is calculated by correcting the signal generator level for cable loss and gain of the substitution antenna referenced to a dipole. A fully charged battery was used for the supply voltage.

The settings of the receiver were as follows:

| | |
|----------------------|-------|
| Units | dBm |
| Resolution Bandwidth | 1 MHz |
| Video Bandwidth | Auto |
| Sweep Time | Auto |

6.5. Uncertainty

The measurement uncertainty is defined as for Field Strength of Spurious Radiation measurement is ± 3.072 dB.

6.6. Test Result

| | | | |
|------------|-------------------|----------------------|---------------|
| Standard: | FCC Part 27 | Test Distance: | 3m |
| Test item: | Radiated Emission | Power: | AC 120V/60Hz |
| Model: | HE910 | Temp.(°C)/Hum.(%RH): | 26(°C)/60%RH |
| Mode: | Mode 1 | Date: | 12/06/2011 |
| Frequency: | 1712.4 MHz | Test By: | Charlie Chang |

| No. | Frequency (MHz) | Reading (dBm) | Correct Factor(dB) | Result (dBm) | Limit (dBm) | Margin (dB) | Remark | Ant.Polar. H / V |
|-----|-----------------|---------------|--------------------|--------------|-------------|-------------|--------|------------------|
| 1 | 198.5000 | -72.64 | 1.56 | -71.08 | -13.00 | -58.08 | peak | H |
| 2 | 474.0000 | -79.47 | 5.40 | -74.07 | -13.00 | -61.07 | peak | H |
| 3 | 538.0000 | -79.41 | 8.19 | -71.22 | -13.00 | -58.22 | peak | H |
| 4 | 683.0000 | -79.40 | 7.01 | -72.39 | -13.00 | -59.39 | peak | H |
| 5 | 780.0000 | -74.33 | 10.19 | -64.14 | -13.00 | -51.14 | peak | H |
| 6 | 902.0000 | -80.14 | 14.14 | -66.00 | -13.00 | -53.00 | peak | H |
| 7 | 3952.000 | -68.83 | 16.36 | -52.47 | -13.00 | -39.47 | peak | H |
| 8 | 7744.000 | -70.78 | 29.40 | -41.38 | -13.00 | -28.38 | peak | H |
| 9 | 11068.000 | -73.46 | 36.49 | -36.97 | -13.00 | -23.97 | peak | H |
| 1 | 131.5000 | -78.73 | 13.57 | -65.16 | -13.00 | -52.16 | peak | V |
| 2 | 161.0000 | -79.36 | 11.75 | -67.61 | -13.00 | -54.61 | peak | V |
| 3 | 215.0000 | -80.31 | 7.11 | -73.20 | -13.00 | -60.20 | peak | V |
| 4 | 409.5000 | -78.91 | 1.33 | -77.58 | -13.00 | -64.58 | peak | V |
| 5 | 667.5000 | -80.11 | 9.45 | -70.66 | -13.00 | -57.66 | peak | V |
| 6 | 957.5000 | -80.79 | 12.42 | -68.37 | -13.00 | -55.37 | peak | V |
| 7 | 3424.000 | -60.68 | 19.05 | -41.63 | -13.00 | -28.63 | peak | V |
| 8 | 7216.000 | -70.24 | 25.93 | -44.31 | -13.00 | -31.31 | peak | V |
| 9 | 9868.000 | -71.62 | 29.98 | -41.64 | -13.00 | -28.64 | peak | V |

| | | | |
|------------|-------------------|----------------------|---------------|
| Standard: | FCC Part 27 | Test Distance: | 3m |
| Test item: | Radiated Emission | Power: | AC 120V/60Hz |
| Model: | HE910 | Temp.(°C)/Hum.(%RH): | 26(°C)/60%RH |
| Mode: | Mode 1 | Date: | 12/06/2011 |
| Frequency: | 1740.0 MHz | Test By: | Charlie Chang |

| No. | Frequency (MHz) | Reading (dBm) | Correct Factor(dB) | Result (dBm) | Limit (dBm) | Margin (dB) | Remark | Ant.Polar. H / V |
|-----|-----------------|---------------|--------------------|--------------|-------------|-------------|--------|------------------|
| 1 | 37.5000 | -76.18 | 8.89 | -67.29 | -13.00 | -54.29 | peak | H |
| 2 | 198.0000 | -72.03 | 1.11 | -70.92 | -13.00 | -57.92 | peak | H |
| 3 | 451.5000 | -78.50 | 4.31 | -74.19 | -13.00 | -61.19 | peak | H |
| 4 | 552.5000 | -80.01 | 7.97 | -72.04 | -13.00 | -59.04 | peak | H |
| 5 | 745.0000 | -79.98 | 8.42 | -71.56 | -13.00 | -58.56 | peak | H |
| 6 | 859.5000 | -81.44 | 13.00 | -68.44 | -13.00 | -55.44 | peak | H |
| 7 | 5152.000 | -70.49 | 20.58 | -49.91 | -13.00 | -36.91 | peak | H |
| 8 | 7636.000 | -71.76 | 29.31 | -42.45 | -13.00 | -29.45 | peak | H |
| 9 | 10660.000 | -72.64 | 34.84 | -37.80 | -13.00 | -24.80 | peak | H |
| 1 | 140.0000 | -73.73 | 8.94 | -64.79 | -13.00 | -51.79 | peak | V |
| 2 | 283.5000 | -77.63 | 1.23 | -76.40 | -13.00 | -63.40 | peak | V |
| 3 | 493.0000 | -79.84 | 2.62 | -77.22 | -13.00 | -64.22 | peak | V |
| 4 | 530.0000 | -79.58 | 3.68 | -75.90 | -13.00 | -62.90 | peak | V |
| 5 | 741.0000 | -80.07 | 10.51 | -69.56 | -13.00 | -56.56 | peak | V |
| 6 | 863.5000 | -80.50 | 11.48 | -69.02 | -13.00 | -56.02 | peak | V |
| 7 | 3460.000 | -63.93 | 19.26 | -44.67 | -13.00 | -31.67 | peak | V |
| 8 | 6244.000 | -71.94 | 23.80 | -48.14 | -13.00 | -35.14 | peak | V |
| 9 | 7648.000 | -70.87 | 26.46 | -44.41 | -13.00 | -31.41 | peak | V |

| | | | |
|------------|-------------------|----------------------|---------------|
| Standard: | FCC Part 27 | Test Distance: | 3m |
| Test item: | Radiated Emission | Power: | AC 120V/60Hz |
| Model: | HE910 | Temp.(°C)/Hum.(%RH): | 26(°C)/60%RH |
| Mode: | Mode 1 | Date: | 12/06/2011 |
| Frequency: | 1752.6 MHz | Test By: | Charlie Chang |

| No. | Frequency (MHz) | Reading (dBm) | Correct Factor(dB) | Result (dBm) | Limit (dBm) | Margin (dB) | Remark | Ant.Polar. H / V |
|-----|--------------------|------------------|-----------------------|-----------------|----------------|----------------|--------|---------------------|
| 1 | 37.5000 | -75.87 | 8.89 | -66.98 | -13.00 | -53.98 | peak | H |
| 2 | 101.0000 | -66.41 | -2.10 | -68.51 | -13.00 | -55.51 | peak | H |
| 3 | 336.5000 | -80.96 | -0.62 | -81.58 | -13.00 | -68.58 | peak | H |
| 4 | 675.5000 | -79.91 | 7.04 | -72.87 | -13.00 | -59.87 | peak | H |
| 5 | 780.0000 | -72.84 | 10.19 | -62.65 | -13.00 | -49.65 | peak | H |
| 6 | 901.5000 | -79.88 | 14.11 | -65.77 | -13.00 | -52.77 | peak | H |
| 7 | 3508.000 | -63.68 | 15.50 | -48.18 | -13.00 | -35.18 | peak | H |
| 8 | 6952.000 | -71.40 | 27.44 | -43.96 | -13.00 | -30.96 | peak | H |
| 9 | 10756.000 | -72.18 | 35.29 | -36.89 | -13.00 | -23.89 | peak | H |
| 1 | 133.5000 | -65.34 | 12.47 | -52.87 | -13.00 | -39.87 | peak | V |
| 2 | 199.5000 | -79.60 | 9.69 | -69.91 | -13.00 | -56.91 | peak | V |
| 3 | 297.5000 | -78.46 | 2.49 | -75.97 | -13.00 | -62.97 | peak | V |
| 4 | 493.0000 | -79.59 | 2.62 | -76.97 | -13.00 | -63.97 | peak | V |
| 5 | 633.0000 | -79.67 | 8.72 | -70.95 | -13.00 | -57.95 | peak | V |
| 6 | 892.5000 | -79.86 | 10.71 | -69.15 | -13.00 | -56.15 | peak | V |
| 7 | 3508.000 | -62.60 | 19.52 | -43.08 | -13.00 | -30.08 | peak | V |
| 8 | 6172.000 | -71.63 | 23.49 | -48.14 | -13.00 | -35.14 | peak | V |
| 9 | 10708.000 | -72.92 | 34.67 | -38.25 | -13.00 | -25.25 | peak | V |

| | | | |
|------------|-------------------|----------------------|---------------|
| Standard: | FCC Part 27 | Test Distance: | 3m |
| Test item: | Radiated Emission | Power: | AC 120V/60Hz |
| Model: | HE910 | Temp.(°C)/Hum.(%RH): | 26(°C)/60%RH |
| Mode: | Mode 2 | Date: | 12/06/2011 |
| | | Test By: | Charlie Chang |

| No. | Frequency (MHz) | Reading (dBm) | Correct Factor(dB) | Result (dBm) | Peak Limit (dBm) | AVG. Limit (dBm) | Margin (dB) | Remark | Ant.Polar. H / V |
|-----|--------------------|------------------|-----------------------|-----------------|---------------------|---------------------|----------------|--------|---------------------|
| 1 | 3569.000 | 38.03 | 3.67 | 41.70 | 74.00 | 54.00 | -32.30 | peak | H |
| 2 | 5473.000 | 35.05 | 9.91 | 44.96 | 74.00 | 54.00 | -29.04 | peak | H |
| 3 | 6425.000 | 35.93 | 12.58 | 48.51 | 74.00 | 54.00 | -25.49 | peak | H |
| 1 | 2862.000 | 37.09 | 1.73 | 38.82 | 74.00 | 54.00 | -35.18 | peak | V |
| 2 | 4199.000 | 36.35 | 5.93 | 42.28 | 74.00 | 54.00 | -31.72 | peak | V |
| 3 | 5557.000 | 35.05 | 10.08 | 45.13 | 74.00 | 54.00 | -28.87 | peak | V |

7 Frequency Stability (Temperature Variation) Test

7.1. Limit

The frequency stability shall be measured by variation of ambient temperature and variation of primary supply voltage to ensure that the fundamental emission stays within the authorized frequency block. The frequency stability of the transmitter shall be maintained within $\pm 0.00025\%$ ($\pm 2.5\text{ppm}$) of the center frequency.

7.2. Test Instruments

| Describe | Manufacturer | Model No. | Serial No. | Cal. Date | Remark |
|--------------------------------------|-----------------|-----------|------------|------------|--------|
| Universal Radio Communication Tester | ROHDE & SCHWARZ | CMU200 | 109369 | 08/10/2010 | (2) |
| Temperature & Humidity Chamber | TAICHY | MHU-225LA | 980729 | 08/24/2011 | (1) |
| Test Site | ATL | TE05 | TE05 | N.C.R. | ----- |

Remark: (1) Calibration period 1 year. (2) Calibration period 2 years.

NOTE: N.C.R. = No Calibration Request.

7.3. Setup

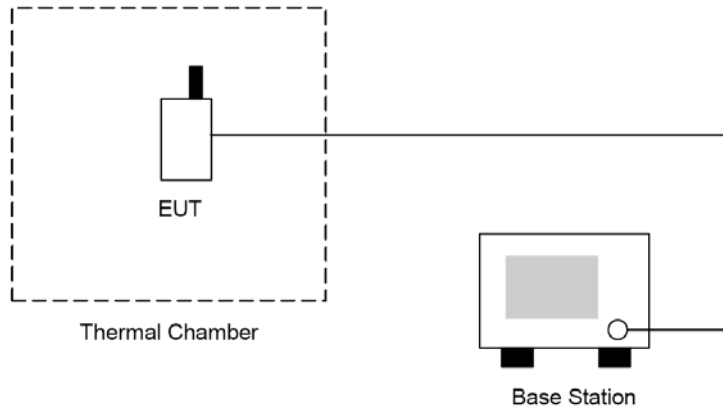

7.4. Test Procedure

The measurement is made according to FCC rules part 27:

1. The EUT and test equipment were set up as shown on the following section.
2. With all power removed, the temperature was decreased to -30°C and permitted to stabilize for three hours. Power was applied and the maximum change in frequency was note within one minute.
3. With power OFF, the temperature was raised in 10°C steps. The sample was permitted to stabilize at each step for at least one-half hour. Power was applied and the maximum frequency change was noted within one minute.
4. The temperature tests were performed for the worst case.
5. Test data was recorded.

7.5. Uncertainty

The measurement uncertainty is defined as for Frequency Stability (Temperature Variation) measurement is $\pm 10\text{Hz}$.

7.6. Test Result

| Product | 2G/3G Module | | | |
|------------------|---|-----------------|-------------|--------|
| Test Item | Frequency Stability (Temperature Variation) | | | |
| Test Mode | Mode 1: WCDMA Band IV Link | | | |
| Date of Test | 01/06/2012 | Test Site | | TE05 |
| Temperature (°C) | Deviation (Hz) | Deviation (ppm) | Limit (ppm) | Result |
| -30 | -6.00 | -0.003 | ± 2.5 | Pass |
| -20 | -9.00 | -0.005 | ± 2.5 | Pass |
| -10 | -7.00 | -0.004 | ± 2.5 | Pass |
| 0 | -10.00 | -0.006 | ± 2.5 | Pass |
| 10 | -11.00 | -0.006 | ± 2.5 | Pass |
| 20 | -11.00 | -0.006 | ± 2.5 | Pass |
| 30 | -6.00 | -0.003 | ± 2.5 | Pass |
| 40 | -9.00 | -0.005 | ± 2.5 | Pass |
| 50 | -10.00 | -0.006 | ± 2.5 | Pass |

8 Frequency Stability (Voltage Variation) Test

8.1. Limit

The frequency stability shall be measured by variation of ambient temperature and variation of primary supply voltage to ensure that the fundamental emission stays within the authorized frequency block. The frequency stability of the transmitter shall be maintained within $\pm 0.00025\%$ ($\pm 2.5\text{ppm}$) of the center frequency.

8.2. Test Instruments

| Describe | Manufacturer | Model No. | Serial No. | Cal. Date | Remark |
|--------------------------------------|-----------------|-----------|------------|------------|--------|
| Universal Radio Communication Tester | ROHDE & SCHWARZ | CMU200 | 109369 | 08/10/2010 | (2) |
| Temperature & Humidity Chamber | TAICHY | MHU-225LA | 980729 | 08/24/2011 | (1) |
| Test Site | ATL | TE05 | TE05 | N.C.R. | ----- |

Remark: ⁽¹⁾ Calibration period 1 year. ⁽²⁾ Calibration period 2 years.

NOTE: N.C.R. = No Calibration Request.

8.3. Setup

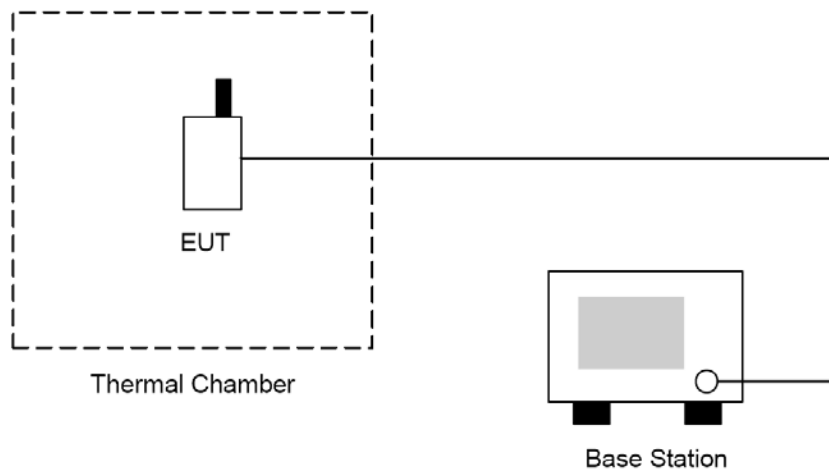

8.4. Test Procedure

1. The EUT was placed in a temperature chamber at $25 \pm 5 \text{ }^\circ\text{C}$ and connected as the following section.
2. The power supply voltage to the EUT was varied from BEP to 115% of the nominal value measured at the input to the EUT.
3. The variation in frequency was measured for the worst case.

8.5. Uncertainty

The measurement uncertainty is defined as for Frequency Stability (Voltage Variation) measurement is $\pm 10\text{Hz}$.

8.6. Test Result

| | | | | | |
|--------------|---|----------------|-----------------|-------------|--------|
| Product | 2G/3G Module | | | | |
| Test Item | Frequency Stability (Voltage Variation) | | | | |
| Test Mode | Mode 1: WCDMA Band IV Link | | | | |
| Date of Test | 01/06/2012 | | Test Site | TE05 | |
| Level | Voltage (V) | Deviation (Hz) | Deviation (ppm) | Limit (ppm) | Result |
| High voltage | 4.20 | -13.00 | -0.007 | ±2.5 | Pass |
| Normal | 3.80 | -11.00 | -0.006 | ±2.5 | Pass |
| Low voltage | 3.40 | -8.00 | -0.005 | ±2.5 | Pass |