

TEST REPORT

Test report no.: 1-4038/11-01-02-A



Testing laboratory

CETECOM ICT Services GmbH
 Untertuerkheimer Strasse 6 – 10
 66117 Saarbruecken / Germany
 Phone: + 49 681 5 98 - 0
 Fax: + 49 681 5 98 - 9075
 Internet: <http://www.cetecom.com>
 e-mail: ict@cetecom.com

Accredited Testing Laboratory:

The testing laboratory (area of testing) is accredited according to DIN EN ISO/IEC 17025 (2005) by the Deutsche Akkreditierungsstelle GmbH (DAkkS). The accreditation is valid for the scope of testing procedures as stated in the accreditation certificate with the registration number: D-PL-12076-01-01
 Area of Testing: Radio/Satellite Communications

Applicant

RSI Video Technologies
 56, rue Jean Giraudoux - Bâtiment 60
 67200 Strasbourg / FRANCE
 Phone: +33 3 90 20 66 96
 Fax: +33 3 90 20 66 36
 Contact: Thierry Petri
 e-mail: thierry.petri@rsivideotech.com
 Phone: +33 3 90 20 66 96

Manufacturer

RSI Video Technologies
 56, rue Jean Giraudoux - Bâtiment 60
 67200 Strasbourg / FRANCE

Test standard/s

47 CFR Part 15	Title 47 of the Code of Federal Regulations; Chapter I Part 15 - Radio frequency devices
RSS - 210 Issue 8	Spectrum Management and Telecommunications - Radio Standards Specification Low-power Licence-exempt Radiocommunication Devices (All Frequency Bands): Category I Equipment

For further applied test standards please refer to section 3 of this test report.

Test Item

Kind of test item:	Burglar Alarm System
Model name:	XTIP600
FCC ID:	X46XT01
IC:	8816A-XT01
Frequency:	902 MHz – 928 MHz
Technology tested:	FSK on FHSS
Antenna:	Integrated wire antenna
Power Supply:	4 x 1.5 V DC from alkaline battery LR20-AM1
Temperature Range:	-20 °C to +55 °C



This test report is electronically signed and valid without handwriting signature. For verification of the electronic signatures, the public keys can be requested at the testing laboratory.

Test report authorised:

[Signature box for Karsten Gerdal]

Karsten Gerdal
 Senior Testing Manager

Test performed:

[Signature box for Meheza Walla]

Meheza Walla
 Expert

1 Table of contents

1	Table of contents	2
2	General information	3
2.1	Notes and disclaimer	3
2.2	Application details	3
3	Test standard/s	3
4	Test environment	4
5	Test item	4
6	Test laboratories sub-contracted	4
7	Summary of measurement results	5
8	RF measurements	6
8.1	Description of test setup	6
8.1.1	Radiated measurements	6
8.2	Additional comments	7
9	Measurement results	8
9.1	Antenna gain	8
9.2	Carrier Frequency Separation	9
9.3	Number of Hopping Channels	10
9.4	Average Time of Occupancy	11
9.5	20 dB Bandwidth	13
9.6	Maximum Output Power Radiated	16
9.7	Maximum Output Power Conducted	17
9.8	Band-edge Compliance of conducted and radiated emissions	20
9.9	Spurious Emissions Conducted (Transmitter)	21
9.10	Spurious Emissions Radiated < 30 MHz	24
9.11	Spurious Emissions Radiated (Transmitter) > 30 MHz	26
9.12	RX spurious emissions radiated	36
10	Test equipment and ancillaries used for tests	39
11	Observations	40
Annex A	Photographs of the test setup	41
Annex B	External photographs of the EUT	42
Annex C	Internal photographs of the EUT	43
Annex D	Document history	55
Annex E	Further information	55
Annex F	Accreditation Certificate	56

2 General information

2.1 Notes and disclaimer

The test results of this test report relate exclusively to the test item specified in this test report. CETECOM ICT Services GmbH does not assume responsibility for any conclusions and generalizations drawn from the test results with regard to other specimens or samples of the type of the equipment represented by the test item.

The test report may only be reproduced or published in full. Reproduction or publication of extracts from the report requires the prior written approval of CETECOM ICT Services GmbH.

The testing service provided by CETECOM ICT Services GmbH has been rendered under the current "General Terms and Conditions for CETECOM ICT Services GmbH".

CETECOM ICT Services GmbH will not be liable for any loss or damage resulting from false, inaccurate, inappropriate or incomplete product information provided by the customer.

Under no circumstances does the CETECOM ICT Services GmbH test report include any endorsement or warranty regarding the functionality, quality or performance of any other product or service provided.

Under no circumstances does the CETECOM ICT Services GmbH test report include or imply any product or service warranties from CETECOM ICT Services GmbH, including, without limitation, any implied warranties of merchantability, fitness for purpose, or non-infringement, all of which are expressly disclaimed by CETECOM ICT Services GmbH.

All rights and remedies regarding vendor's products and services for which CETECOM ICT Services GmbH has prepared this test report shall be provided by the party offering such products or services and not by CETECOM ICT Services GmbH.

In no case this test report can be considered as a Letter of Approval.

This test report is electronically signed and valid without handwritten signature. For verification of the electrical signatures, the public keys can be requested at the testing laboratory.

2.2 Application details

Date of receipt of order:	2012-02-03
Date of receipt of test item:	2012-02-06
Start of test:	2012-02-06
End of test:	2012-02-29
Person(s) present during the test:	-/-

3 Test standard/s

Test standard	Date	Test standard description
47 CFR Part 15	2010-10	Title 47 of the Code of Federal Regulations; Chapter I Part 15 - Radio frequency devices
RSS - 210 Issue 8	2010-12	Spectrum Management and Telecommunications - Radio Standards Specification Low-power Licence-exempt Radiocommunication Devices (All Frequency Bands): Category I Equipment

4 Test environment

Temperature:	T_{nom}	+22 °C during room temperature tests
Relative humidity content:		55 %
Barometric pressure:		not relevant for this kind of testing
Power supply:	V_{nom}	4 x 1.5 V DC from alkaline battery LR20-AM1

5 Test item

Kind of test item	:	Burglar Alarm System
Type identification	:	XT-ip610 (Model: XTIP600)
S/N serial number	:	F5004611230A2CF0
HW hardware status	:	5CA1235A
SW software status	:	XLP.03
Frequency band [MHz]	:	902 MHz – 928 MHz (Band) Low channel: 904.5 MHz; Middle channel: 915.3 MHz; High channel: 926.1 MHz
Type of modulation	:	GFSK
Number of channels	:	25
Antenna	:	Integrated wire antenna
Power supply	:	4 x 1.5 V DC from alkaline battery LR20-AM1
Temperature range	:	-20 °C to +55 °C

6 Test laboratories sub-contracted

None

7 Summary of measurement results



No deviations from the technical specifications were ascertained



There were deviations from the technical specifications ascertained

TC Identifier	Description	Verdict	Date	Remark
RF-Testing	CFR Part 15 RSS 210, Issue 8, Annex 8	Passed	2012-04-20	-/-

Test specification clause	Test case	Temperature conditions	Power source voltages	Mode	Pass	Fail	NA	NP	Results (max.)
§15.247(b)(4)	Antenna Gain	Nominal	Nominal	TX	<input checked="" type="checkbox"/>	<input type="checkbox"/>	<input type="checkbox"/>	<input type="checkbox"/>	complies
§15.247(a)(1) RSS-210 A8.1 (b)	Carrier Frequency Separation	Nominal	Nominal	TX	<input checked="" type="checkbox"/>	<input type="checkbox"/>	<input type="checkbox"/>	<input type="checkbox"/>	complies
§15.247(a)(1)(i) RSS-210 A8.1 (c)	Number of Hopping channels	Nominal	Nominal	TX	<input checked="" type="checkbox"/>	<input type="checkbox"/>	<input type="checkbox"/>	<input type="checkbox"/>	complies
§15.247(a)(1)(i) RSS-210 A8.1 (c)	Average Time of Occupancy (Dwell Time)	Nominal	Nominal	TX	<input checked="" type="checkbox"/>	<input type="checkbox"/>	<input type="checkbox"/>	<input type="checkbox"/>	complies
§15.247(a)(1)(i) RSS-210 A8.1 (c)	20dB Bandwidth	Nominal	Nominal	TX	<input checked="" type="checkbox"/>	<input type="checkbox"/>	<input type="checkbox"/>	<input type="checkbox"/>	complies
§15.247(b)(2) RSS-210 A8.4 (1)	Maximum Output Power Radiated	Nominal	Nominal	TX	<input checked="" type="checkbox"/>	<input type="checkbox"/>	<input type="checkbox"/>	<input type="checkbox"/>	complies
§15.247(b)(4) RSS-210 A8.4 (1)	Maximum Output Power Conducted	Nominal	Nominal	TX	<input checked="" type="checkbox"/>	<input type="checkbox"/>	<input type="checkbox"/>	<input type="checkbox"/>	complies
§15.247(d) §15.205(a)	Band-edge Compliance	Nominal	Nominal	TX	<input checked="" type="checkbox"/>	<input type="checkbox"/>	<input type="checkbox"/>	<input type="checkbox"/>	complies
§15.247(d)	TX Spurious Emission Conducted	Nominal	Nominal	TX	<input checked="" type="checkbox"/>	<input type="checkbox"/>	<input type="checkbox"/>	<input type="checkbox"/>	complies
§15.209(a)	TX Spurious Emission Radiated < 30 MHz	Nominal	Nominal	TX	<input checked="" type="checkbox"/>	<input type="checkbox"/>	<input type="checkbox"/>	<input type="checkbox"/>	complies
§15.247(d) §15.209 A8.5	TX Spurious Emission Radiated > 30 MHz	Nominal	Nominal	TX	<input checked="" type="checkbox"/>	<input type="checkbox"/>	<input type="checkbox"/>	<input type="checkbox"/>	complies
§15.109	RX Spurious Emissions Radiated	Nominal	Nominal	Idle	<input checked="" type="checkbox"/>	<input type="checkbox"/>	<input type="checkbox"/>	<input type="checkbox"/>	complies

Note: NA = Not Applicable; NP = Not Performed

8 RF measurements

8.1 Description of test setup

8.1.1 Radiated measurements

The radiated measurements are performed in vertical and horizontal plane in the frequency range from 9 kHz to 25 GHz in semi-anechoic chambers. The EUT is positioned on a non-conductive support with a height of 0.80 m above a conductive ground plane that covers the whole chamber. The receiving antennas are confirmed with specifications ANSI C63.2-1996 clause 15 and ANSI C63.10-2009 clause 4.1.5. These antennas can be moved over the height range between 1.0 m and 4.0 m in order to search for maximum field strength emitted from EUT. The measurement distances between EUT and receiving antennas are indicated in the test setups for the various frequency ranges. For each measurement, the EUT is rotated in all three axes until the maximum field strength is received. The wanted and unwanted emissions are received by spectrum analysers where the detector modes and resolution bandwidths over various frequency ranges are set according to requirement ANSI C63.10-2009 clause 4.2.

Antennas are confirmed with ANSI C63.2-1996 item 15.

Semi anechoic chamber

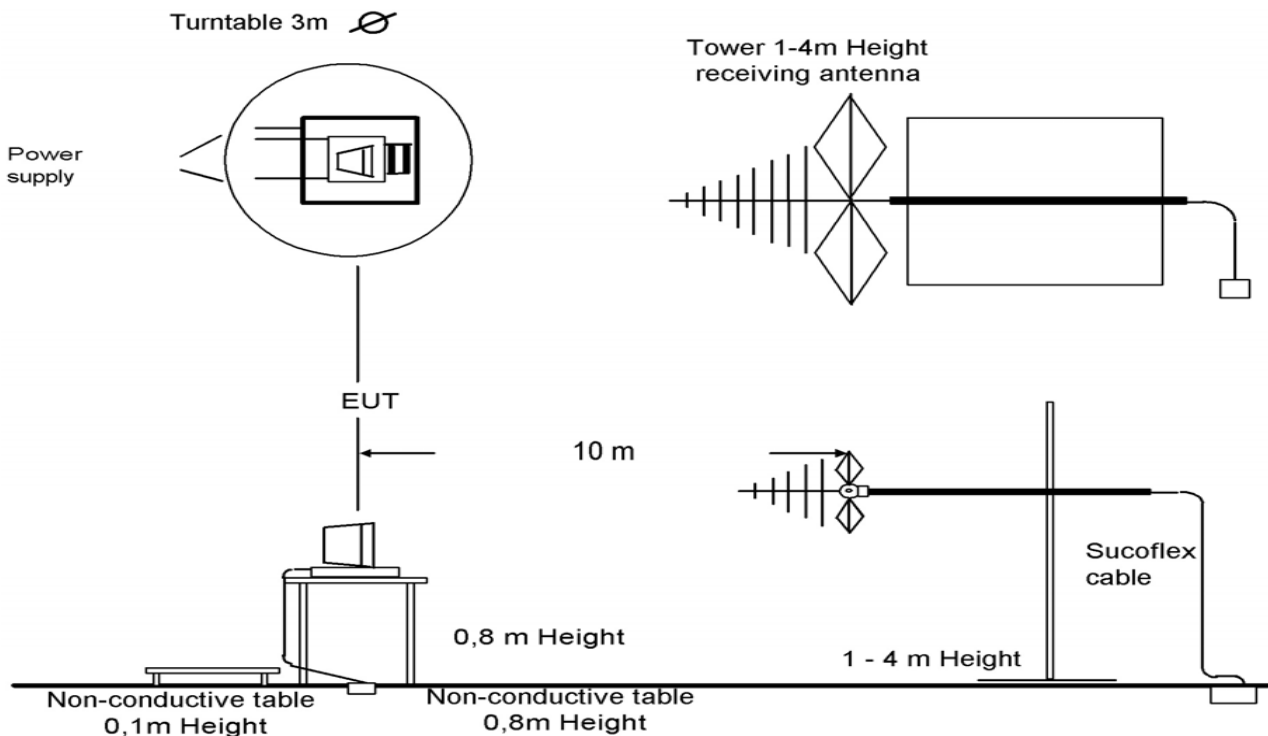

Picture 1: Diagram radiated measurements

9 kHz - 30 MHz:	active loop antenna
30 MHz – 1 GHz:	tri-log antenna
> 1 GHz:	horn antenna

The EUT is powered by an external power supply with nominal voltage or with battery.

8.2 Additional comments

Reference documents: None

Special test descriptions: None

Configuration descriptions: None

Test mode: No test mode available.
Iperf was used to ping another device with the largest support packet size

Special software is used.
EUT is transmitting pseudo random data by itself

Antenna Switch RAx (x: 1 (internal antenna) or 2 (output connector))
RCxx Channel 915 (xx: 0 to 24 decimal)
Reception RRX continuous
Sending RTX cont. (without module)
Sending RTXM cont. (pseudo module rnd)
RTXH Send.freq.hopping (Square module)

Note that the power can not be changed.

9 Measurement results

9.1 Antenna gain

The antenna gain of the complete system is calculated by the difference of radiated power in EIRP and the conducted power of the module.

	Low channel 904.5 MHz	Middle channel 915.3 MHz	High channel 926.1 MHz
Conducted power [dBm]	18.40	18.66	19.03
Radiated power [dBm]	18.68	18.75	18.90
Gain [dBi] Calculated	+0.28	+0.09	-0.13

Limits:

FCC	IC
§15.247(b)(4)	-/-
Antenna gain	
<p>The conducted output power limit specified in paragraph (b) of this section is based on the use of antennas with directional gains that do not exceed 6 dBi. Except as shown in paragraph (c) of this section, if transmitting antennas of directional gain greater than 6 dBi are used, the conducted output power from the intentional radiator shall be reduced below the stated values in paragraphs (b)(1), (b)(2), and (b)(3) of this section, as appropriate, by the amount in dB that the directional gain of the antenna exceeds 6 dBi.</p>	

Result: Passed

9.2 Carrier Frequency Separation

Plot 1:

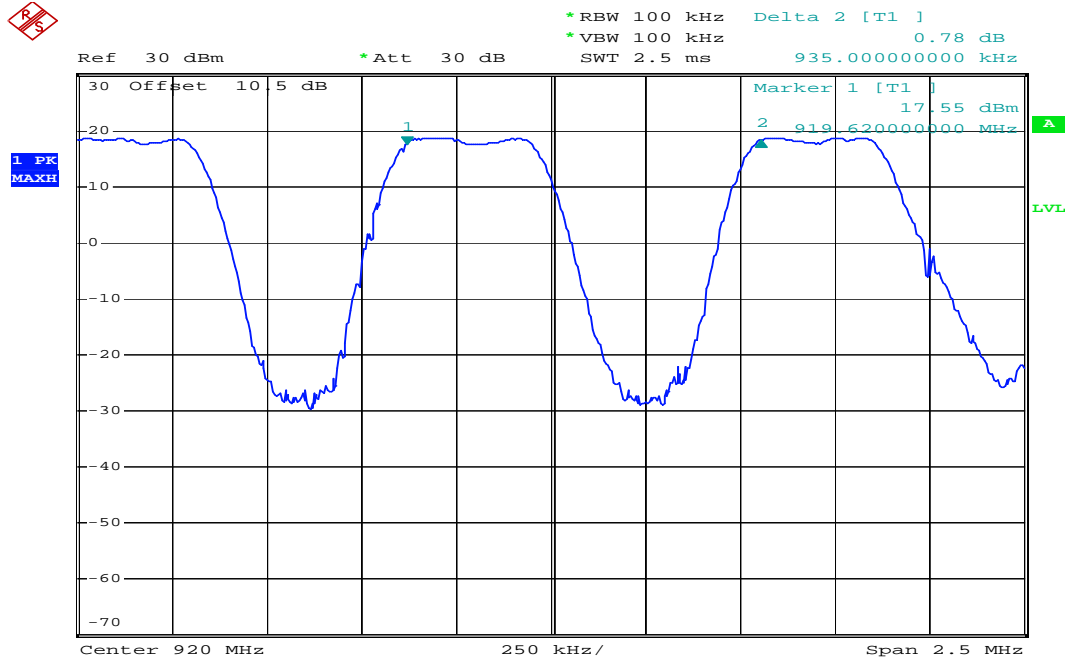

Date: 9.FEB.2012 17:15:00

Result: The channel separation is: 935 kHz

Limits:

FCC	IC
§15.247(a)(1)	RSS-210 / A8.1 (b)
Carrier Frequency Separation	
Frequency hopping systems shall have hopping channel carrier frequencies separated by a minimum of 25 kHz or the 20 dB bandwidth of the hopping channel, whichever is greater.	

Result: Passed

9.3 Number of Hopping Channels

Plot 1:

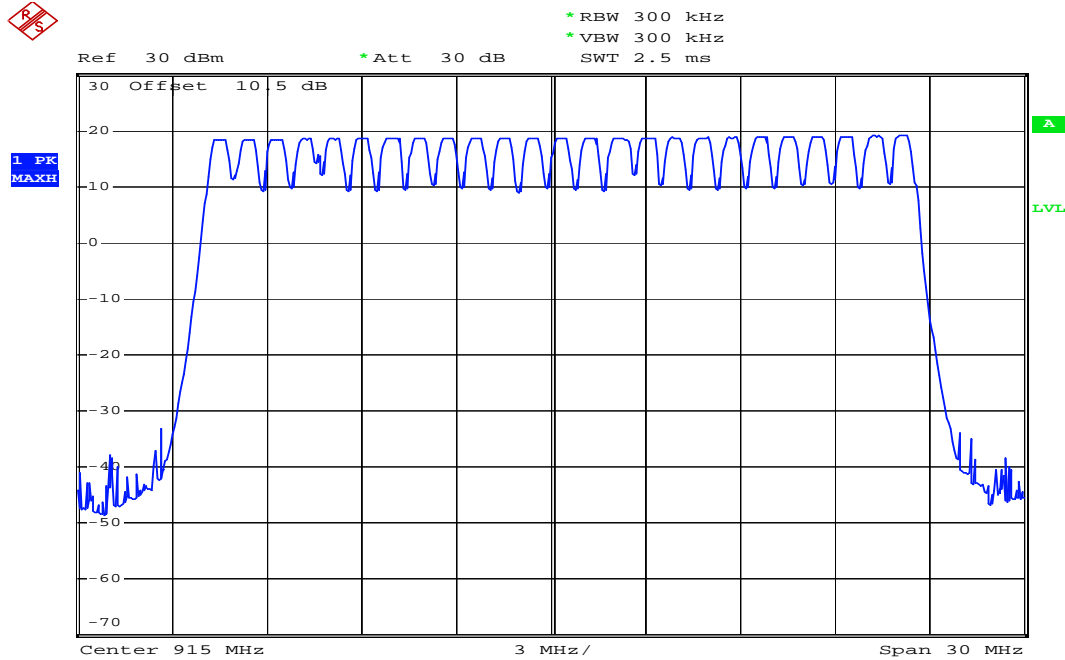

Date: 9.FEB.2012 17:18:01

Result: The number of hopping channels is: 25

Limits:

FCC	IC
§15.247(a)(1)(i)	RSS-210 / A8.1 (c)
Number of Hopping Channels	
For frequency hopping systems operating in the 902-928 MHz band: if the 20 dB bandwidth of the hopping channel is less than 250 kHz, the system shall use at least 50 hopping within a 20 second period; if the 20 dB bandwidth of the hopping channel is 250 kHz or greater, the system shall use at least 25 hopping frequencies.	

Result: Passed

9.4 Average Time of Occupancy

Plot 2: Time slot length = 2.15 ms

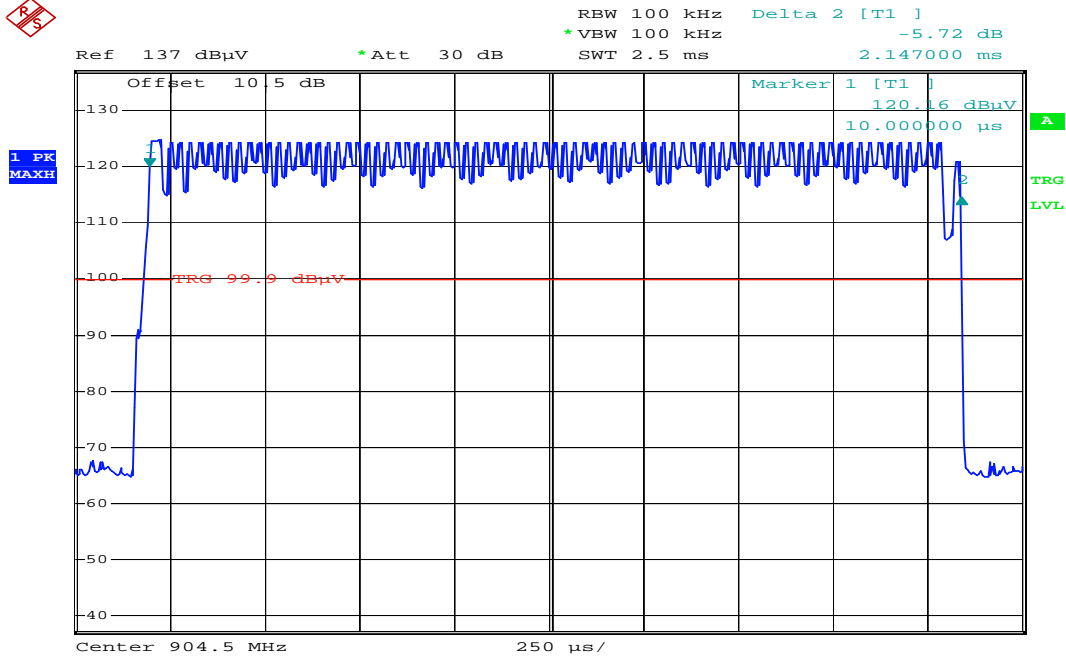

Date: 10.FEB.2012 10:21:42

Plot 3: Number of hopping channels in 1s = 18

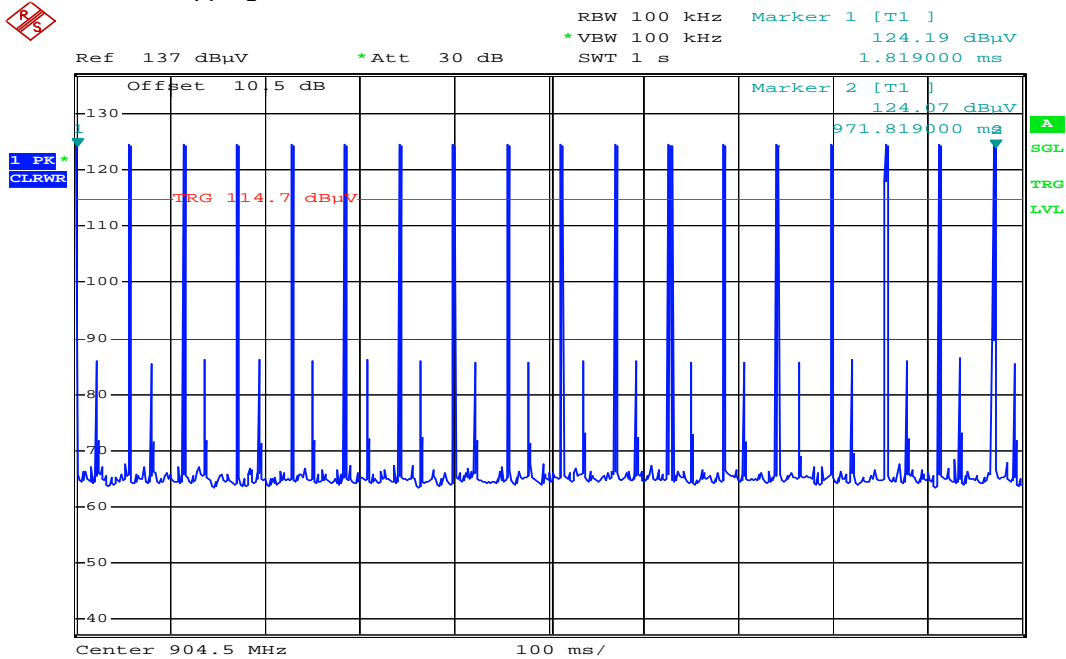

Date: 10.FEB.2012 10:40:30

Result: The time slot length is = 2.15 ms
 The Number of hopping channels in 1s = 18

Within 10s period, the average time of occupancy = $10 * 18 * 2.15 \text{ ms}$

→ The average time of occupancy = 387 ms

Limits:

FCC	IC
§15.247(a)(1)(i)	RSS-210 / A8.1 (c)
Average time of occupancy	
For frequency hopping systems operating in the 902-928 MHz band: if the 20 dB bandwidth of the hopping channel is less than 250 kHz, the system shall use at least 50 hopping within a 20 second period; if the 20 dB bandwidth of the hopping channel is 250 kHz or greater, the system shall use at least 25 hopping frequencies and the average time of occupancy on any frequency shall not be greater than 0.4 seconds within 10 second period.	

Result: Passed

9.5 20 dB Bandwidth

Plot 4: Low Channel

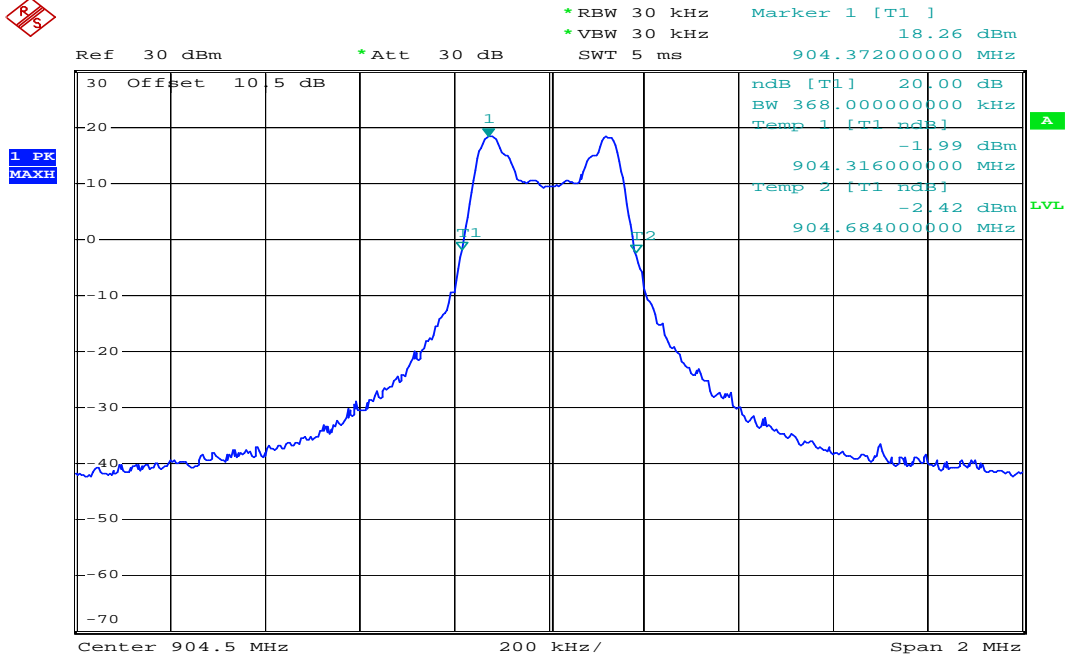

Date: 9.FEB.2012 17:21:12

Plot 5: Middle Channel

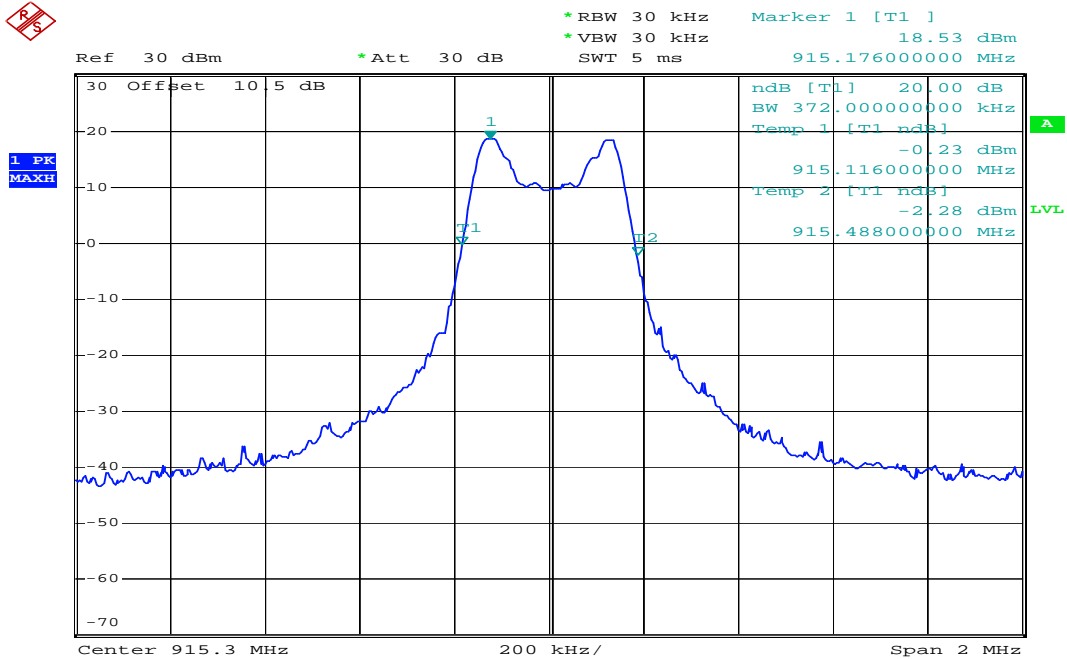

Date: 9.FEB.2012 17:22:36

Plot 6: High Channel

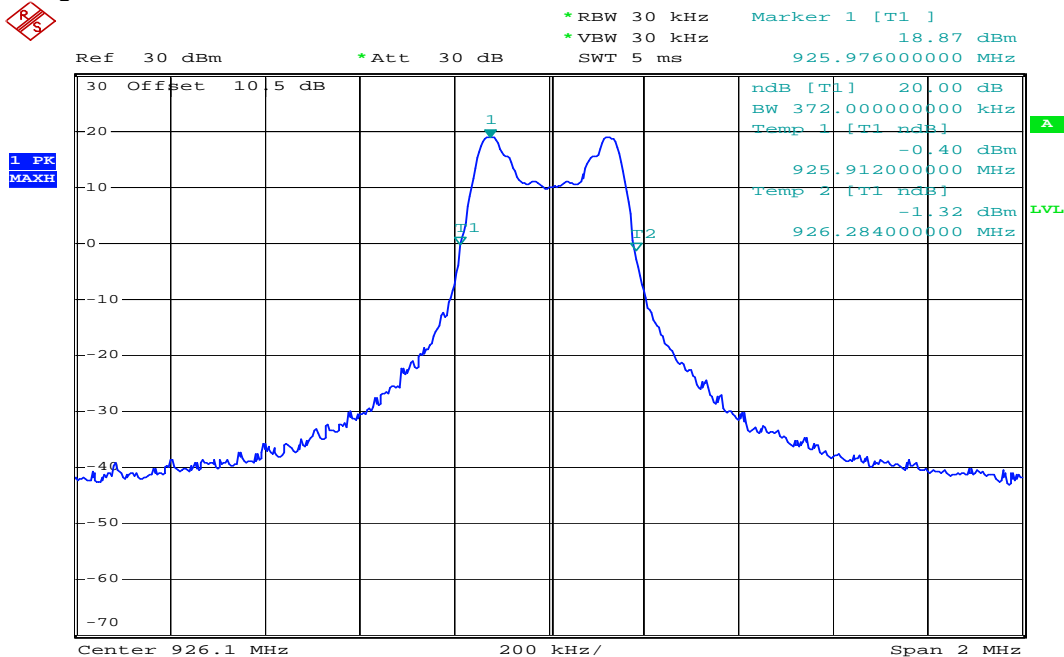

Date: 9.FEB.2012 17:23:55

Result:

Test Conditions		20dB BANDWIDTH [kHz]		
		904.5 MHz	915.3 MHz	926.1 MHz
T _{nom}	V _{nom}	368	372	372
Measurement uncertainty		± 30 kHz		

Limits:

FCC	IC
§15.247(a)(1)(i)	RSS-210 / A8.1 (c)
20dB Bandwidth	
The maximum allowed 20 dB bandwidth of the hopping channel is 500 kHz.	

Result: Passed

9.6 Maximum Output Power Radiated

Measurement:

Measurement parameter	
Detector:	Peak
Sweep time:	Auto
Resolution bandwidth:	1 MHz
Video bandwidth:	1 MHz
Span:	5 MHz
Trace-Mode:	Max Hold

Result:

Test Conditions		EIRP [dBm]		
		904.5 MHz	915.3 MHz	926.1 MHz
T_{nom}	V_{nom}	18.68	18.75	18.90
Measurement uncertainty		± 3dB		

Limits:

FCC	IC
§15.247(b)(2)	RSS-210 / A8.4 (1)
EIRP	
For frequency hopping systems operating in the 902–928 MHz band: 1 watt (30 dBm) for systems employing at least 50 hopping channels; and, 0.25 watts (24 dBm) for systems employing less than 50 hopping channels, but at least 25 hopping channels, as permitted under paragraph (a)(1)(i) of this section.	

Result: Passed

9.7 Maximum Output Power Conducted

Plot 7: Low Channel

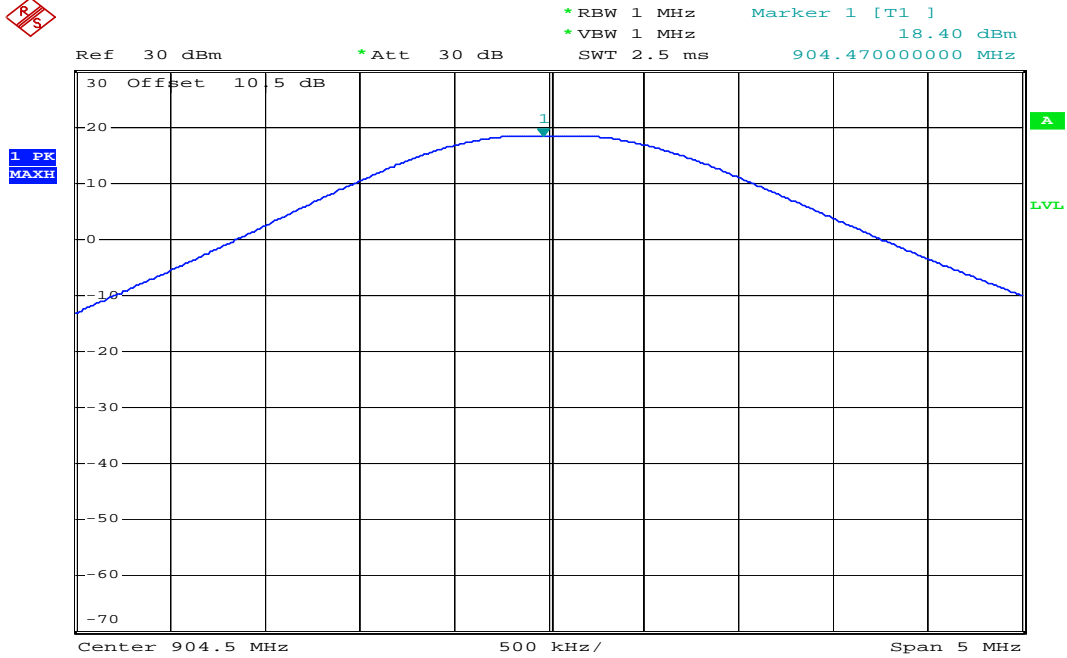

Date: 9.FEB.2012 17:28:54

Plot 8: Middle Channel

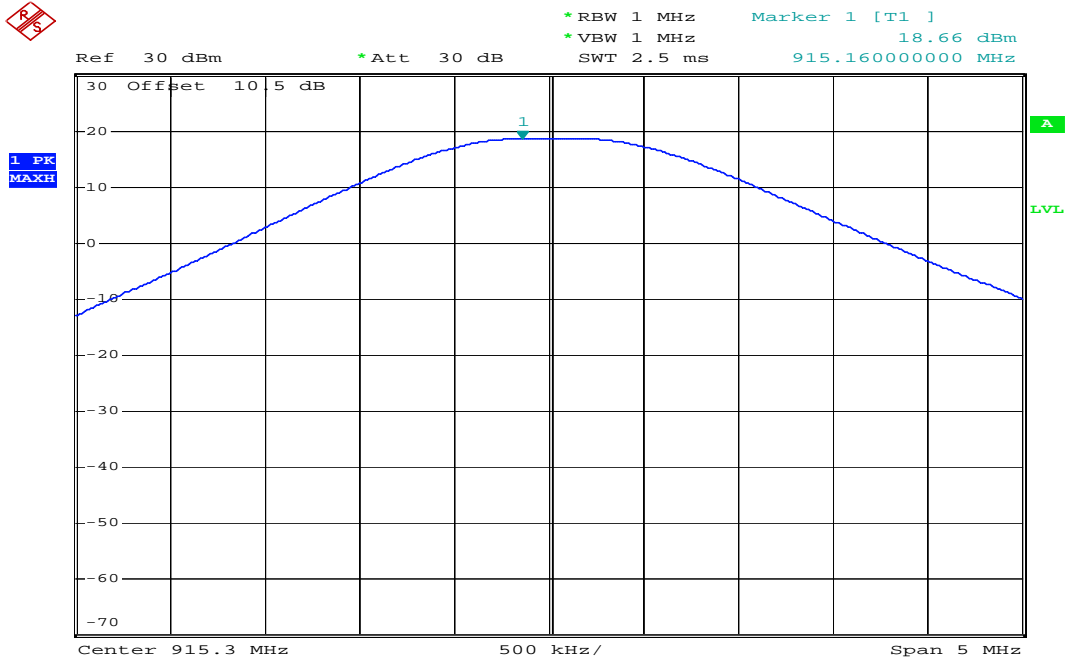

Date: 9.FEB.2012 17:28:01

Plot 9: High Channel

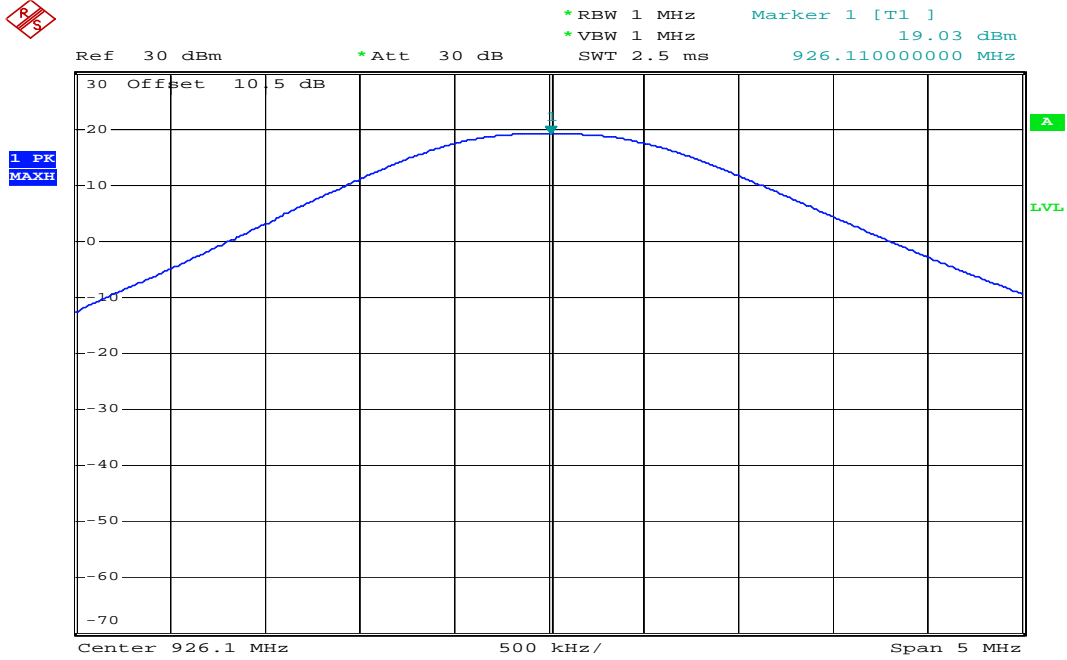

Date: 9.FEB.2012 17:27:00

Result:

Test Conditions		Maximum Output Power Conducted [dBm]		
		904.5 MHz	915.3 MHz	926.1 MHz
T _{nom}	V _{nom}	18.40	18.66	19.03
Measurement uncertainty		± 3 dB		

Limits:

FCC	IC
§15.247(b)(2)	RSS-210 / A8.4 (1)
Maximum Output Power Conducted	
For frequency hopping systems operating in the 902–928 MHz band: 1 watt (30 dBm) for systems employing at least 50 hopping channels; and, 0.25 watts (24 dBm) for systems employing less than 50 hopping channels, but at least 25 hopping channels, as permitted under paragraph (a)(1)(i) of this section.	

Result: Passed

9.8 Band-edge Compliance of conducted and radiated emissions

No restricted band in the range ± 2 channel bandwidths of the Band-edges of the specified emission band! (608 MHz – 614 MHz and 960 MHz – 1240 MHz).

Section 15.205 Restricted bands of operation.

(a) Except as shown in paragraph (d) of this section, only spurious emissions are permitted in any of the frequency bands listed below:

MHz	MHz	MHz	GHz
0.090 - 0.110	16.42 - 16.423	399.9 - 410	4.5 - 5.15
¹ 0.495 - 0.505	16.69475 - 16.69525	608 - 614	5.35 - 5.46
2.1735 - 2.1905	16.80425 - 16.80475	960 - 1240	7.25 - 7.75
4.125 - 4.128	25.5 - 25.67	1300 - 1427	8.025 - 8.5
4.17725 - 4.17775	37.5 - 38.25	1435 - 1626.5	9.0 - 9.2
4.20725 - 4.20775	73 - 74.6	1645.5 - 1646.5	9.3 - 9.5
6.215 - 6.218	74.8 - 75.2	1660 - 1710	10.6 - 12.7
6.26775 - 6.26825	108 - 121.94	1718.8 - 1722.2	13.25 - 13.4
6.31175 - 6.31225	123 - 138	2200 - 2300	14.47 - 14.5
8.291 - 8.294	149.9 - 150.05	2310 - 2390	15.35 - 16.2
8.362 - 8.366	156.52475 - 156.52525	2483.5 - 2500	17.7 - 21.4
8.37625 - 8.38675	156.7 - 156.9	2690 - 2900	22.01 - 23.12
8.41425 - 8.41475	162.0125 - 167.17	3260 - 3267	23.6 - 24.0
12.29 - 12.293	167.72 - 173.2	3332 - 3339	31.2 - 31.8
12.51975 - 12.52025	240 - 285	3345.8 - 3358	36.43 - 36.5
12.57675 - 12.57725	322 - 335.4	3600 - 4400	(²)
13.36 - 13.41			

Limits:

FCC	IC
§15.247(d) / §15.205(a)	-/-
Band-edge Compliance of conducted and radiated emissions	
<p>In any 100 kHz bandwidth outside the frequency band in which the spread spectrum or digitally modulated intentional radiator is operating, the radio frequency power that is produced by the intentional radiator shall be at least 20 dB below that in the 100 kHz bandwidth within the band that contains the highest level of the desired power, based on either an RF conducted or a radiated measurement, provided the transmitter demonstrates compliance with the peak conducted power limits. If the transmitter complies with the conducted power limits based on the use of RMS averaging over a time interval, as permitted under paragraph (b)(3) of this section, the attenuation required under this paragraph shall be 30 dB instead of 20 dB. Attenuation below the general limits specified in §15.209(a) is not required. In addition, radiated emissions which fall in the restricted bands, as defined in §15.205(a), must also comply with the radiated emission limits specified in §15.209(a) (see §15.205(c)).</p>	

Result: Passed

9.9 Spurious Emissions Conducted (Transmitter)

Plot 10: Low Channel

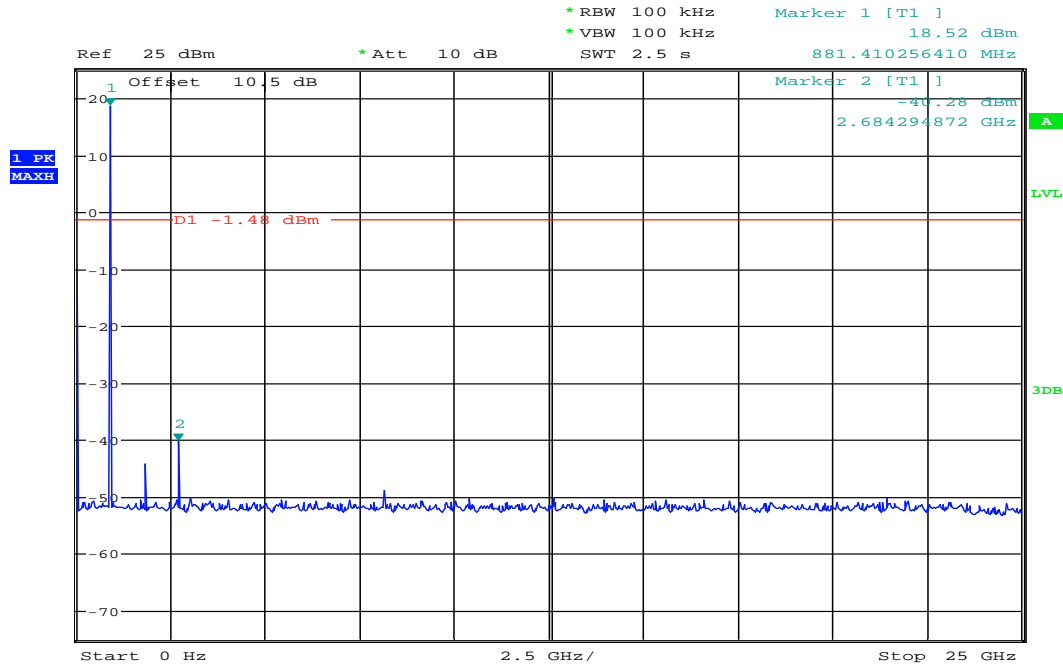

Date: 10.FEB.2012 13:07:13

Plot 11: Middle Channel

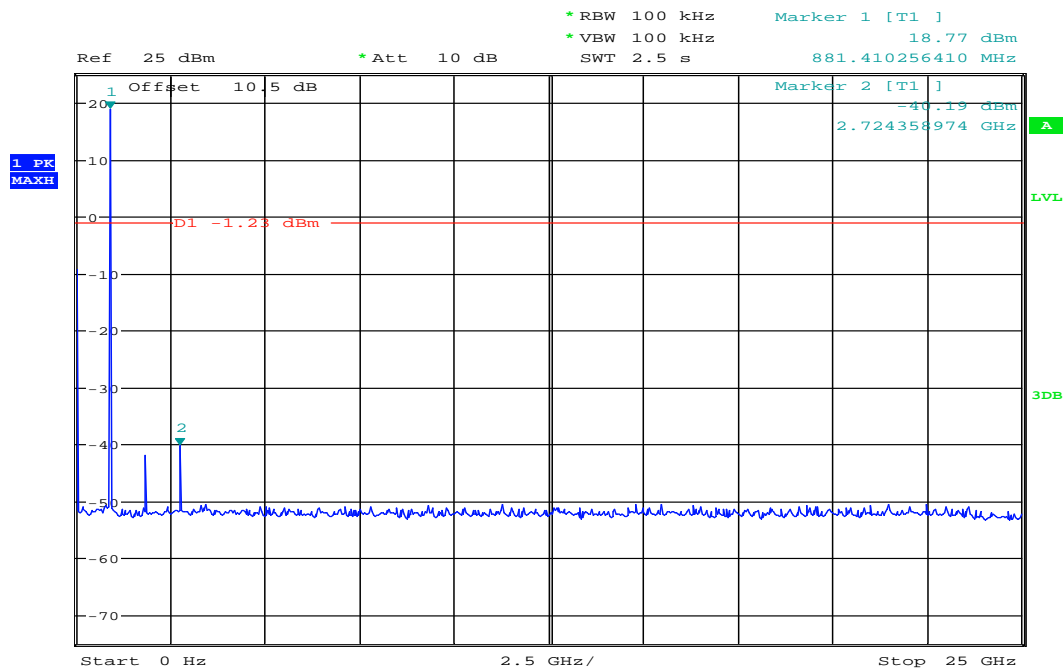

Date: 10.FEB.2012 13:04:49

Plot 12: High Channel

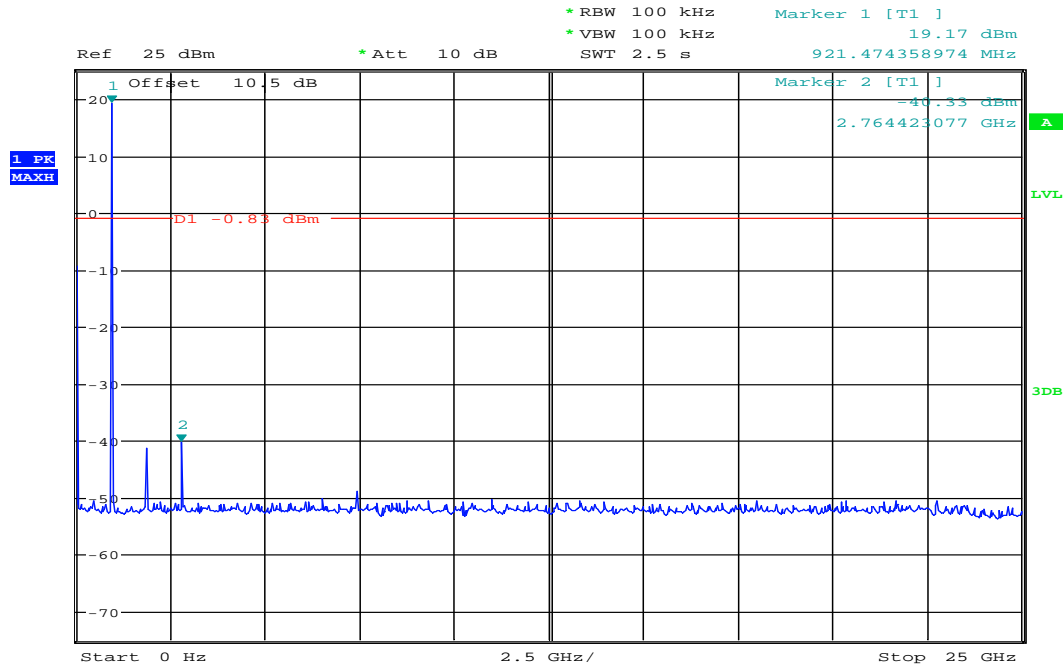

Date: 10.FEB.2012 13:03:10

Result:

Emission Limitation					
Frequency [MHz]	Amplitude of emission [dBm]	Limit max. allowed emission power	actual attenuation below frequency of operation [dB]	Results	
904.5	18.52	24 dBm		Operating frequency	
No critical peaks detected!		-20 dBc			
915.3	18.77	24 dBm		Operating frequency	
No critical peaks detected!		-20 dBc			
926.1	19.17	24 dBm		Operating frequency	
No critical peaks detected!		-20 dBc			
Measurement uncertainty		± 3dB			

Limits:

FCC	IC
§15.247(d)	RSS-210 / A8.5
Spurious emissions conducted	
<p>In any 100 kHz bandwidth outside the frequency band in which the spread spectrum or digitally modulated intentional radiator is operating, the radio frequency power that is produced by the intentional radiator shall be at least 20 dB below that in the 100 kHz bandwidth within the band that contains the highest level of the desired power, based on either an RF conducted or a radiated measurement, provided the transmitter demonstrates compliance with the peak conducted power limits. If the transmitter complies with the conducted power limits based on the use of RMS averaging over a time interval, as permitted under paragraph (b)(3) of this section, the attenuation required under this paragraph shall be 30 dB instead of 20 dB. Attenuation below the general limits specified in §15.209(a) is not required. In addition, radiated emissions which fall in the restricted bands, as defined in §15.205(a), must also comply with the radiated emission limits specified in §15.209(a) (see §15.205(c)).</p>	

Result: Passed

9.10 Spurious Emissions Radiated < 30 MHz

Plot 13: TX-Mode

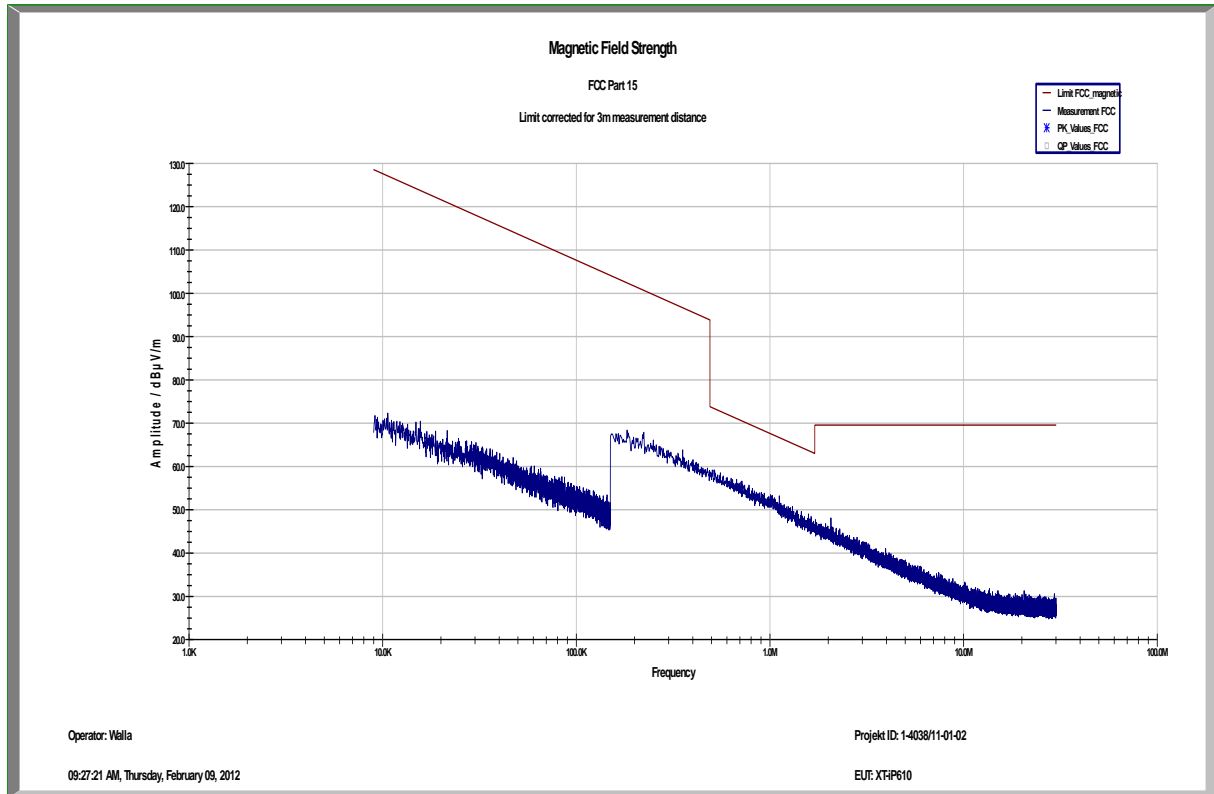

Plot 14: RX-Mode

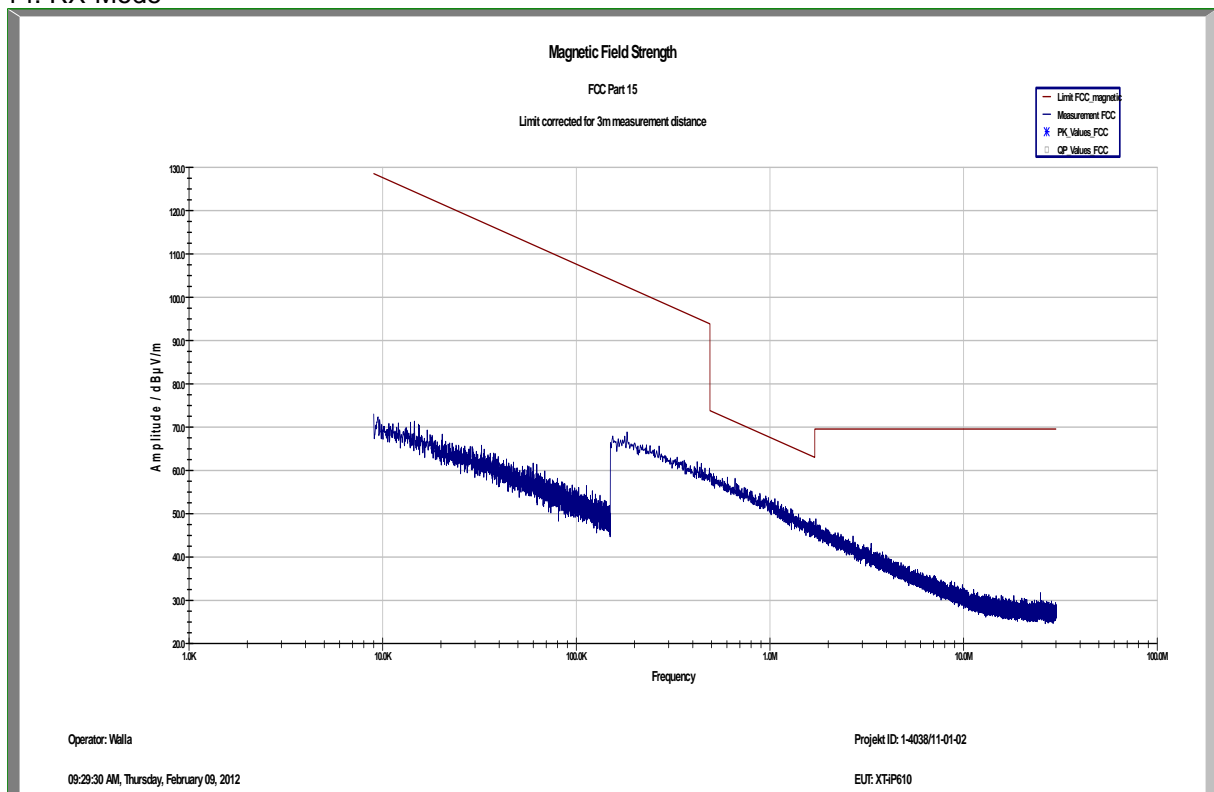

Limits:

FCC		IC
CFR Part 15.209(a)		-/-
Spurious Emissions Radiated < 30 MHz		
Frequency (MHz)	Field Strength (dB μ V/m)	Measurement distance
0.009 – 0.490	2400/F(kHz)	300
0.490 – 1.705	24000/F(kHz)	30
1.705 – 30.0	30	30

Result: Passed

9.11 Spurious Emissions Radiated (Transmitter) > 30 MHz

Plot 15: 0.03 – 1 GHz, antenna vertical / horizontal (lowest channel)

EUT:	XT-iP610
Serial Number:	F5004611230A2CF0
Test Description:	FCC part 15 B class B
Operating Conditions:	TX-Mode, Low Channel @ 904.5 MHz
Operator Name:	Wolsdorfer
Comment:	Battery powered 6V DC

Scan Setup: STAN_Fin [EMI radiated]

Hardware Setup:	Electric Field (NOS)
Receiver:	[ESCI 3]
Level Unit:	dBµV/m

Subrange	Step Size	Detectors	IF BW	Meas. Time	Preamp
30 MHz - 2 GHz	60 kHz	QPK	120 kHz	1 s	20 dB

FCC_10m(B)_3

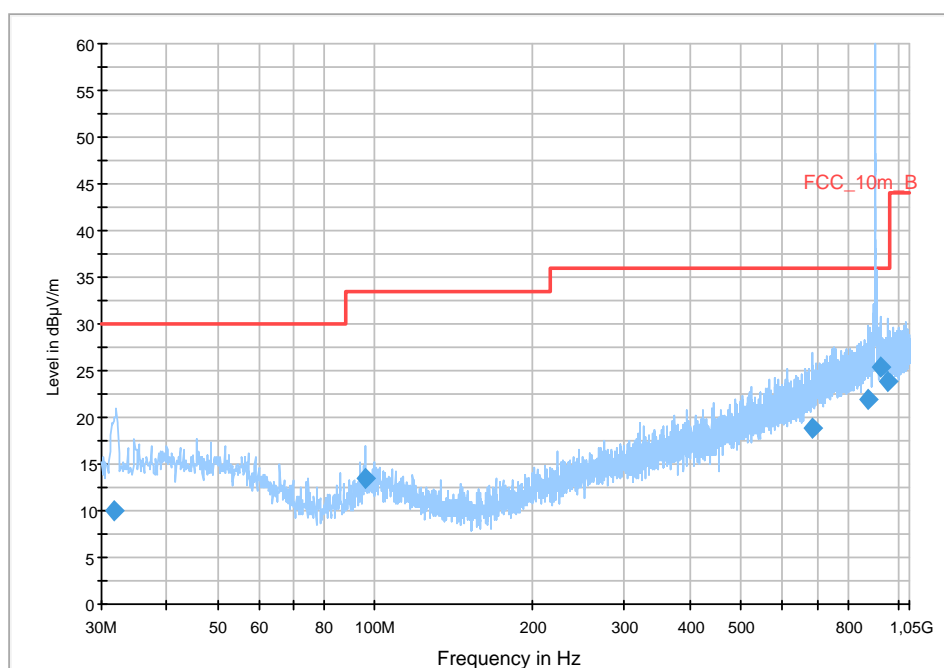

Frequency (MHz)	QuasiPeak (dBµV/m)	Meas. Time (ms)	Bandwidth (kHz)	Height (cm)	Polarization	Azimuth (deg)	Corr. (dB)	Margin (dB)	Limit (dBµV/m)
31.694250	9.9	1000.0	120.000	170.0	V	103.0	12.7	20.1	30.0
96.021300	13.6	1000.0	120.000	170.0	V	89.0	11.4	19.9	33.5
684.023550	18.9	1000.0	120.000	98.0	H	179.0	22.1	17.1	36.0
873.700500	21.9	1000.0	120.000	120.0	V	269.0	24.9	14.1	36.0
925.344150	25.4	1000.0	120.000	98.0	H	194.0	25.3	10.6	36.0
956.524950	23.9	1000.0	120.000	98.0	H	194.0	25.4	12.1	36.0

Plot 16: 1 – 12 GHz, antenna vertical (lowest channel)

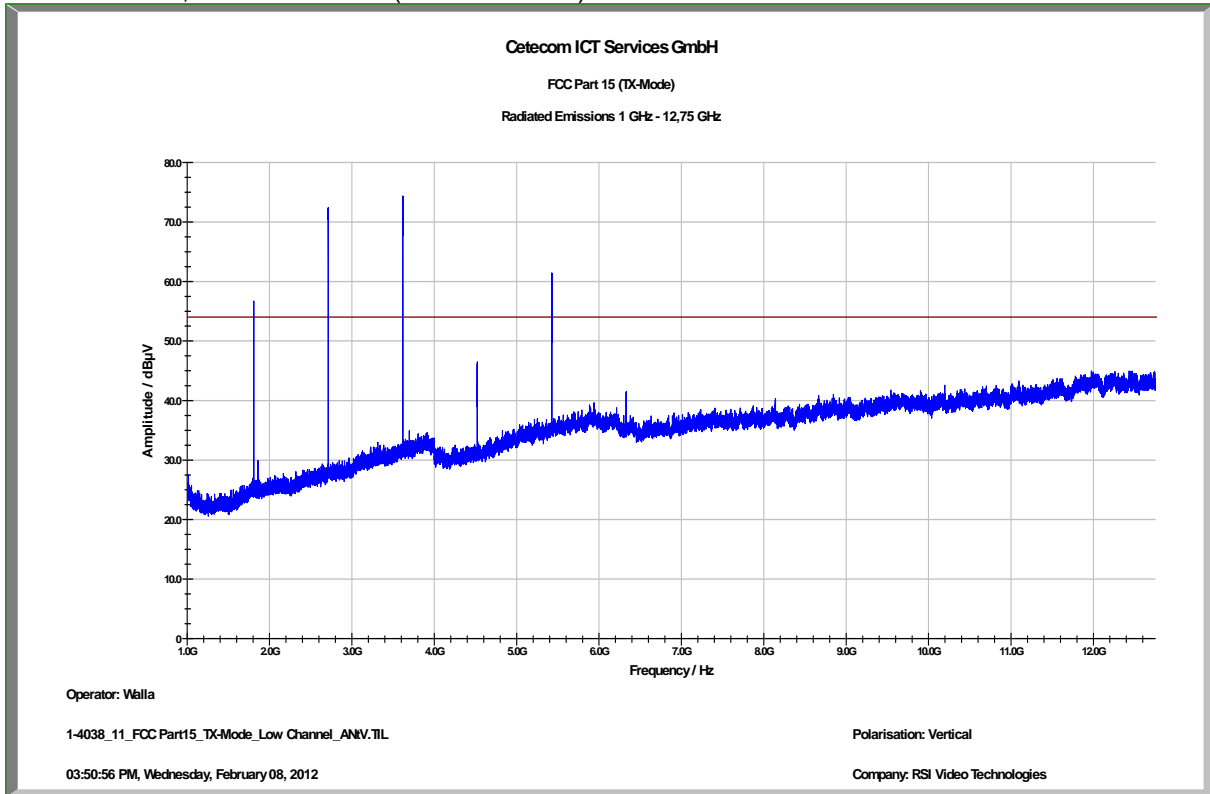

Plot 17: 1 – 12 GHz, antenna horizontal (lowest channel)

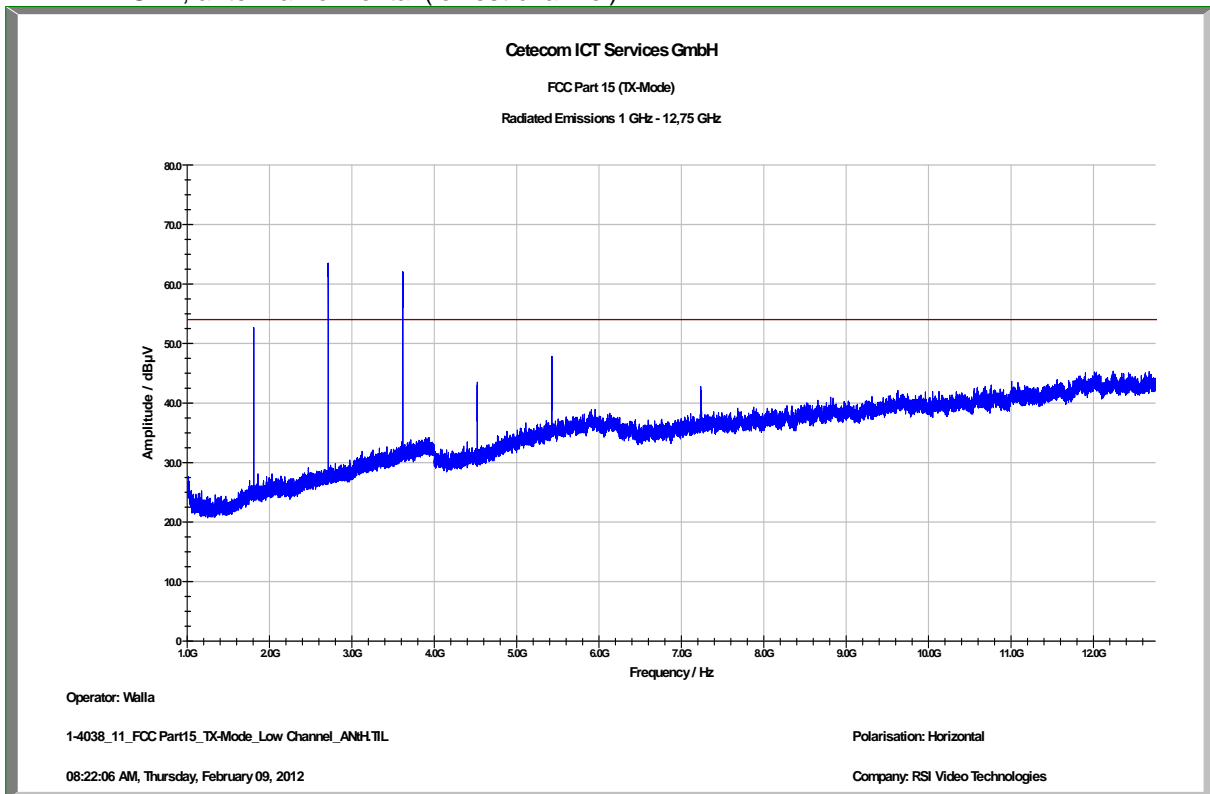

Plot 18: 12 – 25 GHz, antenna vertical / horizontal (valid for all channels)

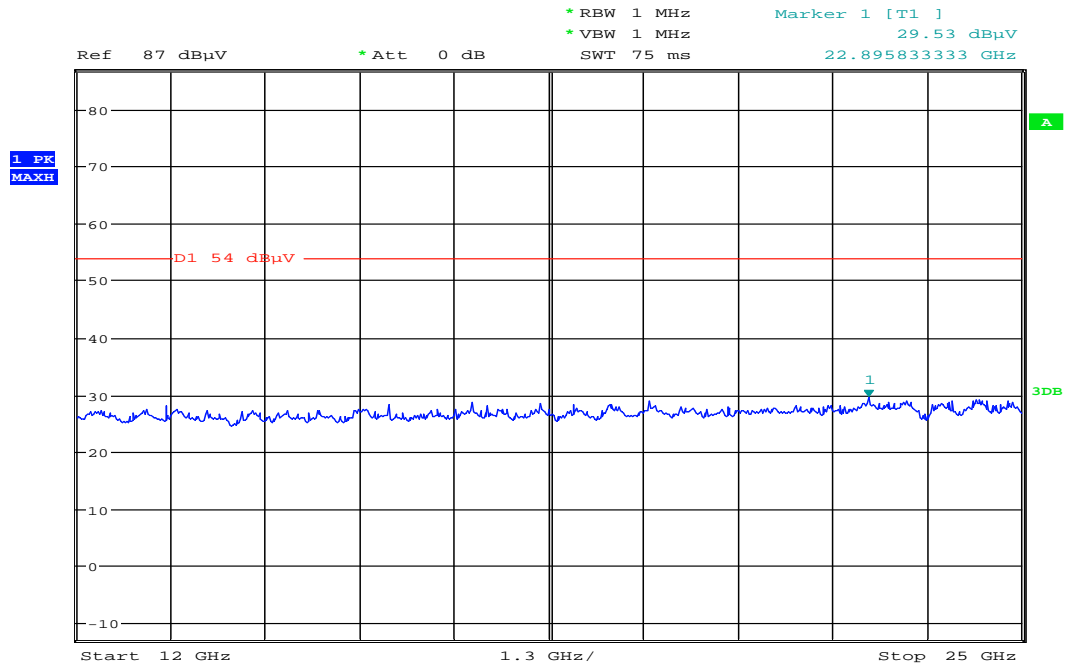

Date: 10.FEB.2012 13:30:19

Plot 19: 0.03 – 1 GHz, antenna vertical / horizontal (middle channel)

EUT:	XT-iP610
Serial Number:	F5004611230A2CF0
Test Description:	FCC part 15 B class B
Operating Conditions:	TX-Mode, Middle Channel @ 915.3 MHz
Operator Name:	Wolsdorfer
Comment:	Battery powered 6V DC

Scan Setup: STAN_Fin [EMI radiated]

Hardware Setup:	Electric Field (NOS)
Receiver:	[ESCI 3]
Level Unit:	dBµV/m

Subrange	Step Size	Detectors	IF BW	Meas. Time	Preamp
30 MHz - 2 GHz	60 kHz	QPK	120 kHz	1 s	20 dB

FCC_10m(B)_3

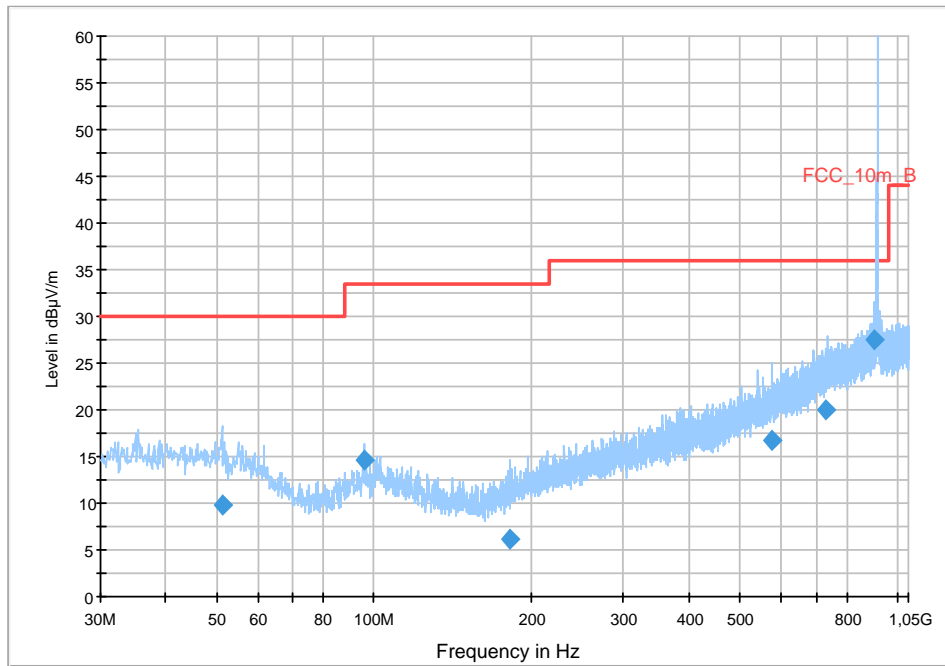

Frequency (MHz)	QuasiPeak (dBµV/m)	Meas. Time (ms)	Bandwidth (kHz)	Height (cm)	Polarization	Azimuth (deg)	Corr. (dB)	Margin (dB)	Limit (dBµV/m)
51.191850	9.8	1000.0	120.000	120.0	V	7.0	13.3	20.2	30.0
96.000450	14.6	1000.0	120.000	170.0	V	-7.0	11.4	18.9	33.5
181.542000	6.2	1000.0	120.000	170.0	H	96.0	10.5	27.3	33.5
575.610600	16.8	1000.0	120.000	170.0	V	7.0	20.1	19.2	36.0
728.423400	20.0	1000.0	120.000	170.0	V	-7.0	23.2	16.0	36.0
905.293650	27.5	1000.0	120.000	98.0	H	179.0	25.2	8.5	36.0

Plot 20: 1 – 12 GHz, antenna vertical (middle channel)

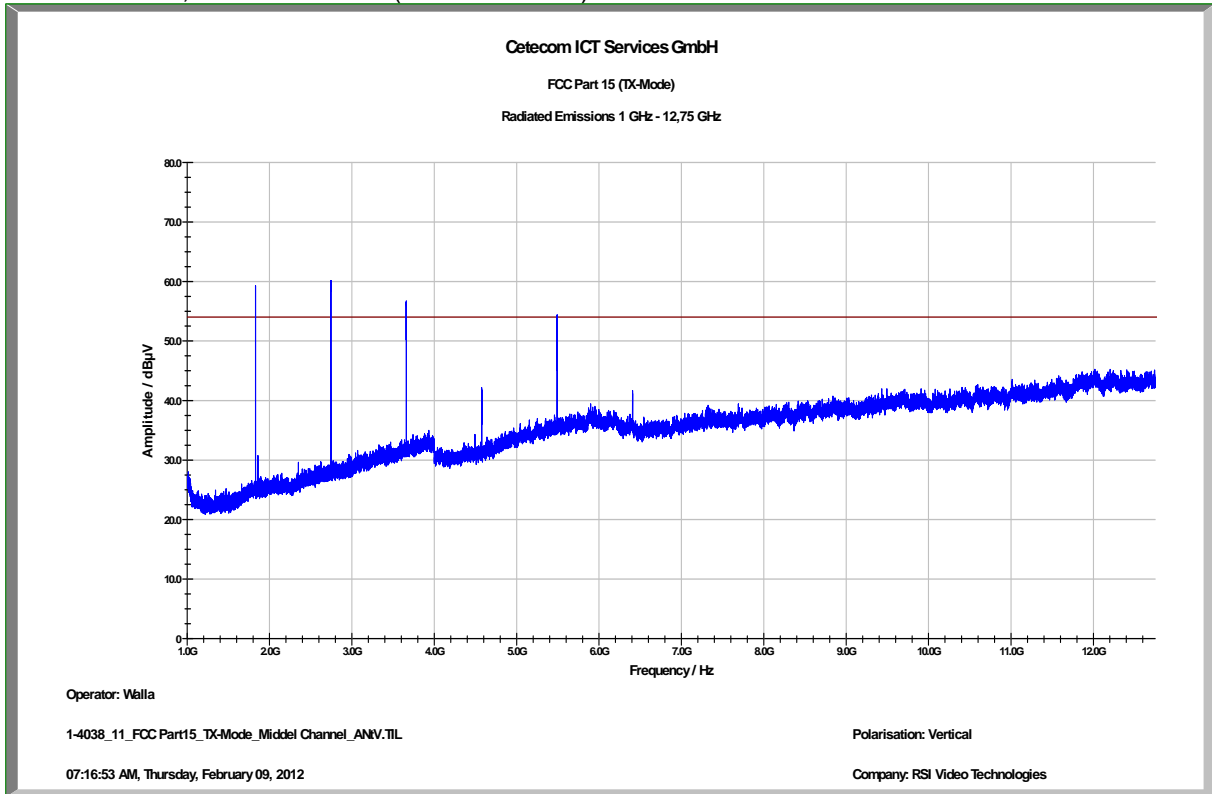

Plot 21: 1 – 12 GHz, antenna horizontal (middle channel)

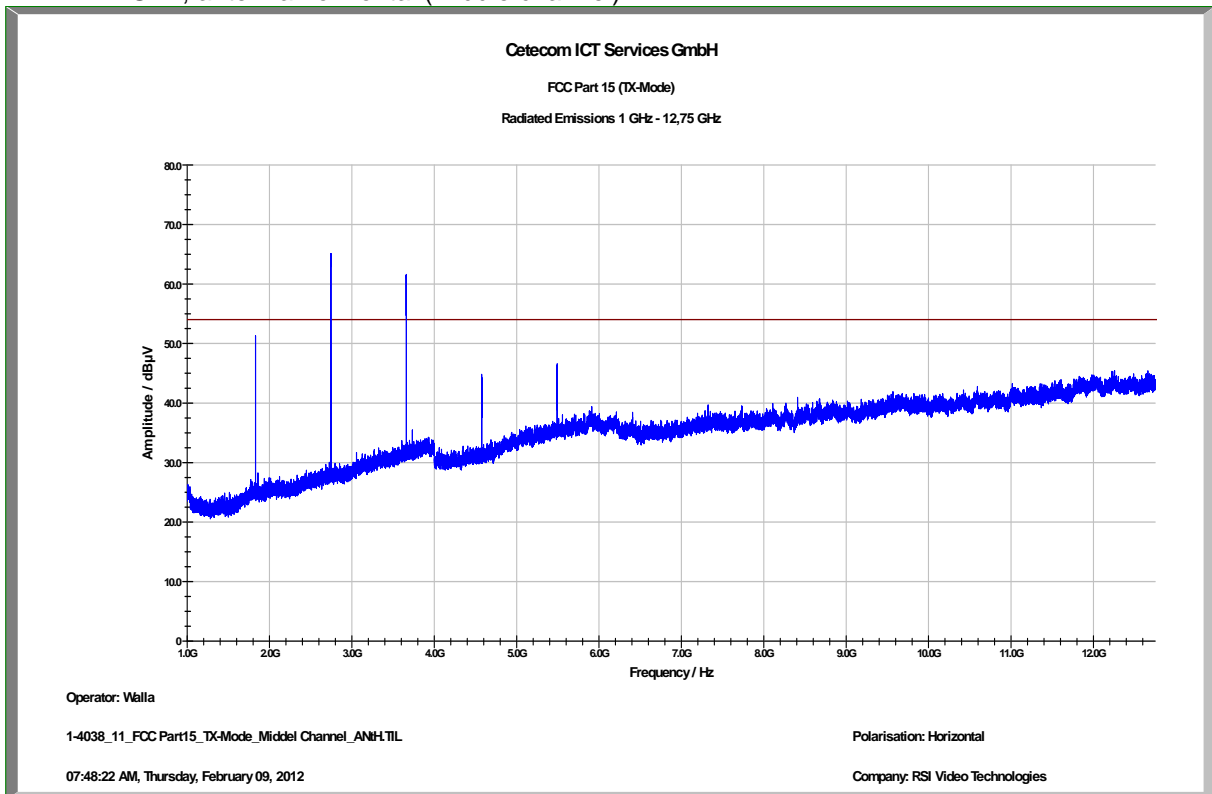

Plot 22: 0.03 – 1 GHz, antenna vertical / horizontal (highest channel)

EUT:	XT-iP610
Serial Number:	F5004611230A2CF0
Test Description:	FCC part 15 B class B
Operating Conditions:	TX-Mode, High Channel @ 926.1 MHz
Operator Name:	Wolsdorfer
Comment:	Battery powered 6V DC

Scan Setup: STAN_Fin [EMI radiated]

Hardware Setup:	Electric Field (NOS)
Receiver:	[ESCI 3]
Level Unit:	dBµV/m

Subrange	Step Size	Detectors	IF BW	Meas. Time	Preamp
30 MHz - 2 GHz	60 kHz	QPK	120 kHz	1 s	20 dB

FCC_10m(B)_3

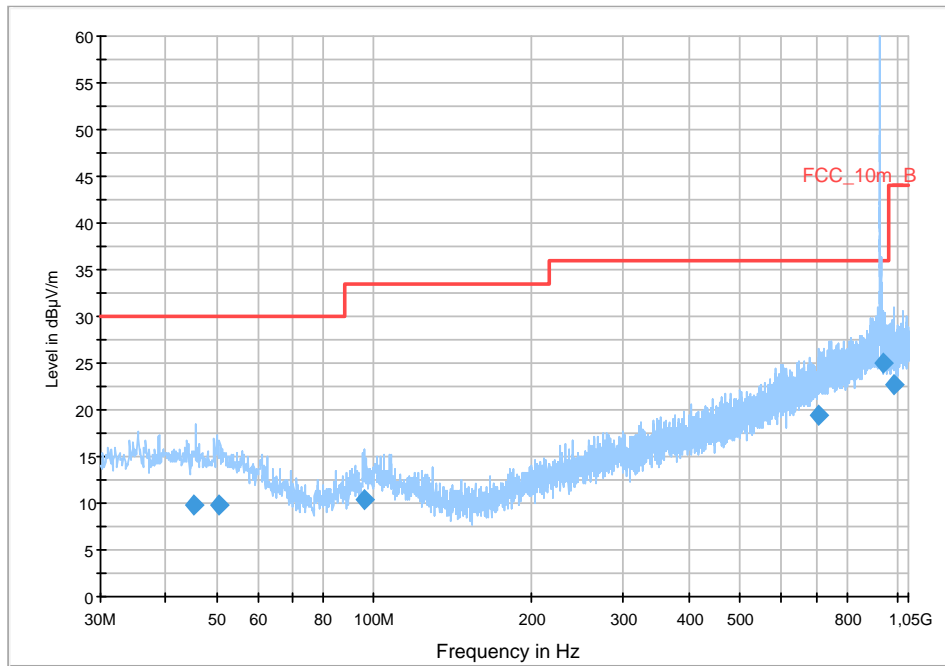

Frequency (MHz)	QuasiPeak (dBµV/m)	Meas. Time (ms)	Bandwidth (kHz)	Height (cm)	Polarization	Azimuth (deg)	Corr. (dB)	Margin (dB)	Limit (dBµV/m)
45.234000	9.8	1000.0	120.000	170.0	V	-6.0	13.3	20.2	30.0
50.544000	9.8	1000.0	120.000	170.0	V	283.0	13.3	20.2	30.0
705.442500	19.5	1000.0	120.000	123.0	H	283.0	22.6	16.5	36.0
95.917500	10.3	1000.0	120.000	98.0	H	196.0	25.3	19.7	30.0
940.911000	25.0	1000.0	120.000	98.0	H	196.0	25.3	11.0	36.0
988.237200	22.7	1000.0	120.000	164.0	V	283.0	25.7	21.3	44.0

Plot 23: 1 – 12 GHz, antenna vertical (highest channel)

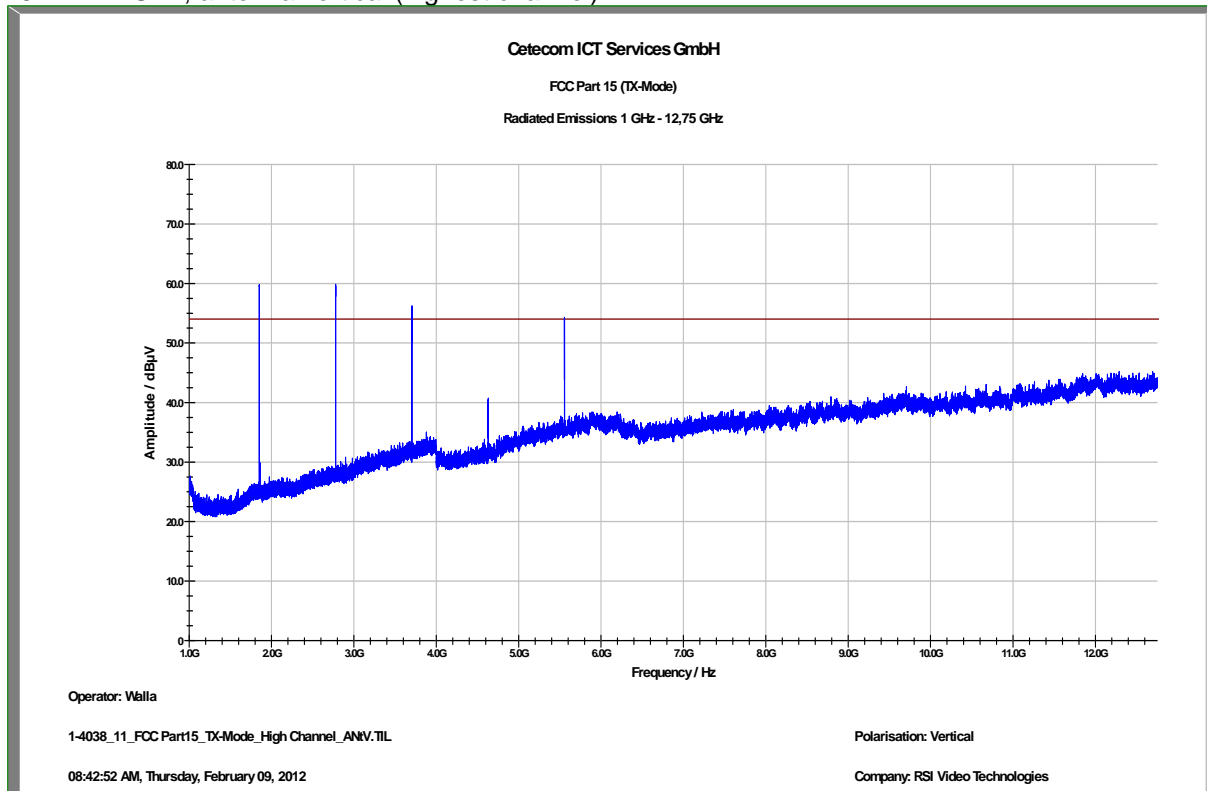

Plot 24: 1 – 12 GHz, antenna horizontal (highest channel)

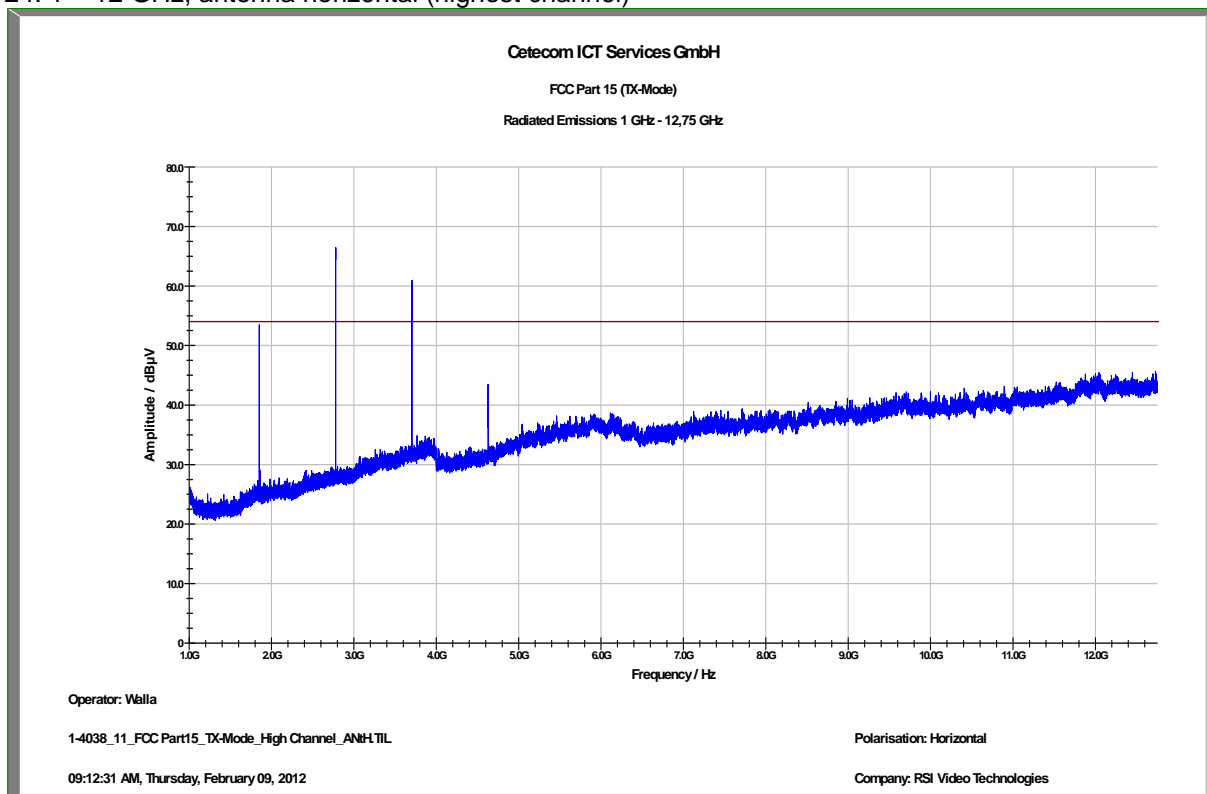

Result:

For radiated spurious emission the limits of 15.209 applies for all frequencies mentioned in 15.205. According to FCC Public Notice DA 00-705 (ANSI C63.10) the average emission shall be determined by using Video averaging (VBW = 10 Hz). If the dwell time of the hopping signal is less than 100 ms (per channel), the VBW=10 Hz reading may be adjusted by a factor:

$$F = 20\log(\text{dwell time}/100 \text{ ms})$$

In a period of 100 ms, we have a maximum of 2 transmissions and that gives the correction factor for spurious measurement.

$$F = 20\log(2 \cdot 2.15/100) = -27.33 \text{ dB}$$

Plot 25: Time slot length = 2.15 ms

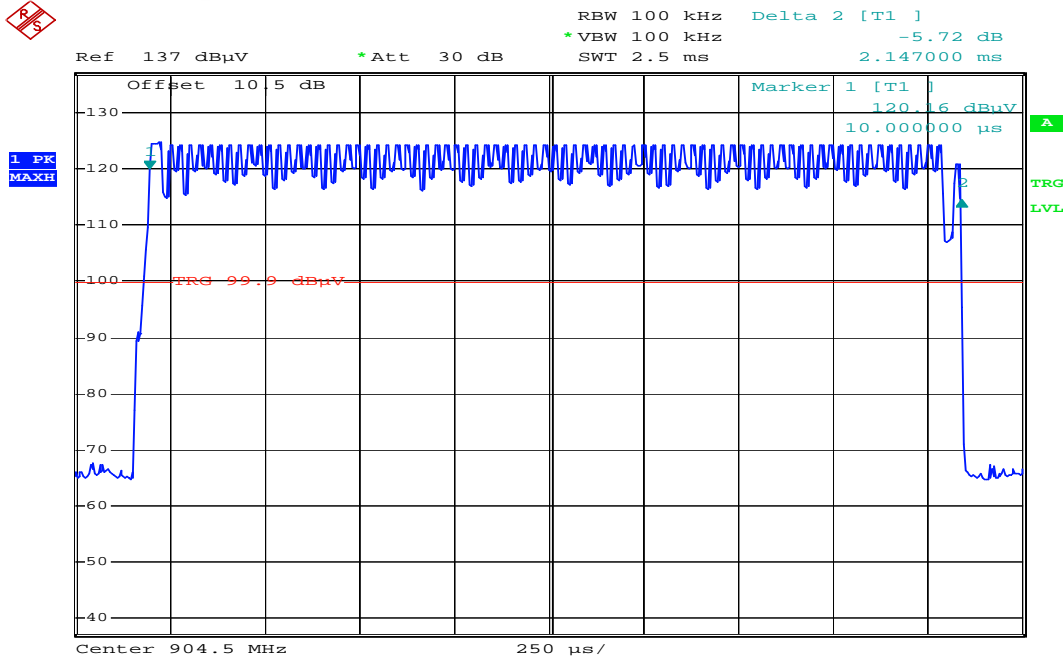

Date: 10.FEB.2012 10:21:42

Plot 26: Number of hopping channels in 1s = 18

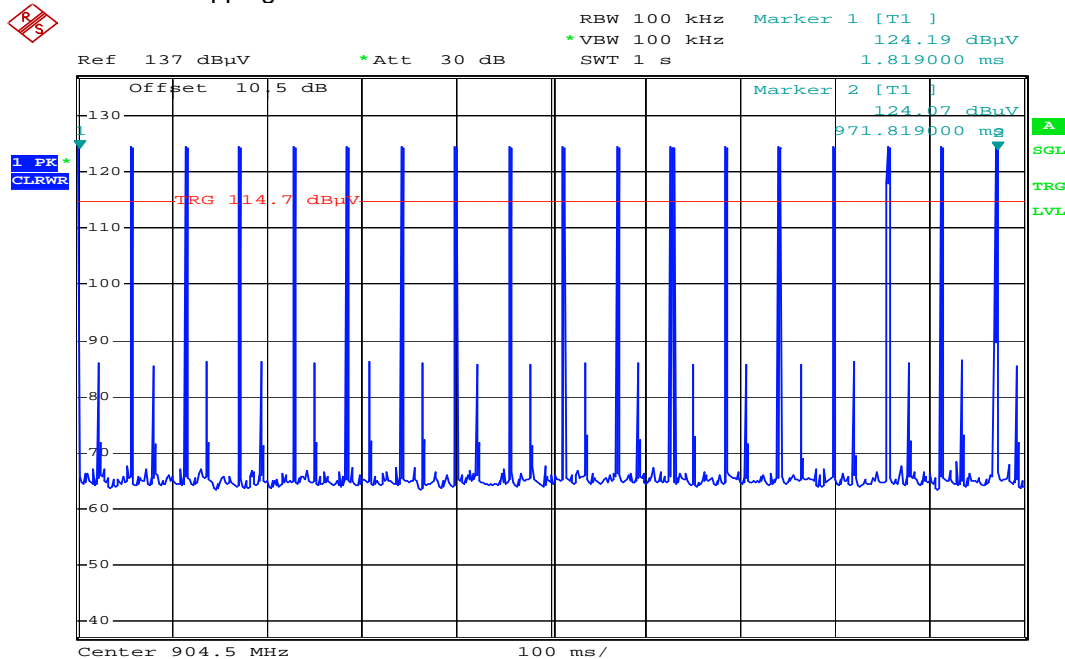

Date: 10.FEB.2012 10:40:30

SPURIOUS EMISSIONS LEVEL [dBµV/m]								
904.5 MHz			915.3 MHz			926.1 MHz		
Frequency [MHz]	Detector	Level [dBµV/m]	Frequency [MHz]	Detector	Level [dBµV/m]	Frequency [MHz]	Detector	Level [dBµV/m]
1809	*Avg	32.92	1831	*Avg	34.32	1852	*Avg	35.53
2713	*Avg	38.49	2746	*Avg	44.42	2778	*Avg	45.46
3618	*Avg	40.67	3661	*Avg	42.00	3704	*Avg	42.27
4523	*Avg	41.67	4577	*Avg	31.43	4631	*Avg	29.67
5426	*Avg	26.82	5492	*Avg	26.07	5556	*Avg	24.32
Measurement uncertainty					±3 dB			

*Avg: Detector Average corrected with the correction factor F = -27.33 dB

Limits:

ANSI C63.10 – FCC Public Notice DA 00-705

The average emission shall be determined by using Video averaging (VBW = 10 Hz). If the dwell time of the hopping signal is less than 100 ms (per channel), the VBW=10 Hz reading may be adjusted by a factor:
 $F = 20\log(\text{dwell time}/100 \text{ ms})$

FCC		IC	
§15.247(d)		RSS-210 / A8.5	
Band-edge Compliance of conducted and radiated emissions			
<p>In any 100 kHz bandwidth outside the frequency band in which the spread spectrum or digitally modulated intentional radiator is operating, the radio frequency power that is produced by the intentional radiator shall be at least 20 dB below that in the 100 kHz bandwidth within the band that contains the highest level of the desired power, based on either an RF conducted or a radiated measurement, provided the transmitter demonstrates compliance with the peak conducted power limits. If the transmitter complies with the conducted power limits based on the use of RMS averaging over a time interval, as permitted under paragraph (b)(3) of this section, the attenuation required under this paragraph shall be 30 dB instead of 20 dB. Attenuation below the general limits specified in §15.209(a) is not required. In addition, radiated emissions which fall in the restricted bands, as defined in §15.205(a), must also comply with the radiated emission limits specified in §15.209(a) (see §15.205(c)).</p>			
§15.209			
Frequency (MHz)	Field Strength (dBµV/m)	Measurement distance	
30 - 88	30.0	10	
88 – 216	33.5	10	
216 – 960	36.0	10	
Above 960	54.0	3	

Result: Passed

9.12 RX spurious emissions radiated

Plot 27: 0.03 – 1 GHz, antenna vertical / horizontal (highest channel)

EUT:	XT-iP610
Serial Number:	F5004611230A2CF0
Test Description:	FCC part 15 B class B
Operating Conditions:	RX-Mode
Operator Name:	Wolsdorfer
Comment:	Battery powered 6V DC

Scan Setup: STAN_Fin [EMI radiated]

Hardware Setup:	Electric Field (NOS)
Receiver:	[ESCI 3]
Level Unit:	dBµV/m

Subrange	Step Size	Detectors	IF BW	Meas. Time	Preamp
30 MHz - 2 GHz	60 kHz	QPK	120 kHz	1 s	20 dB

FCC_10m(B)_3

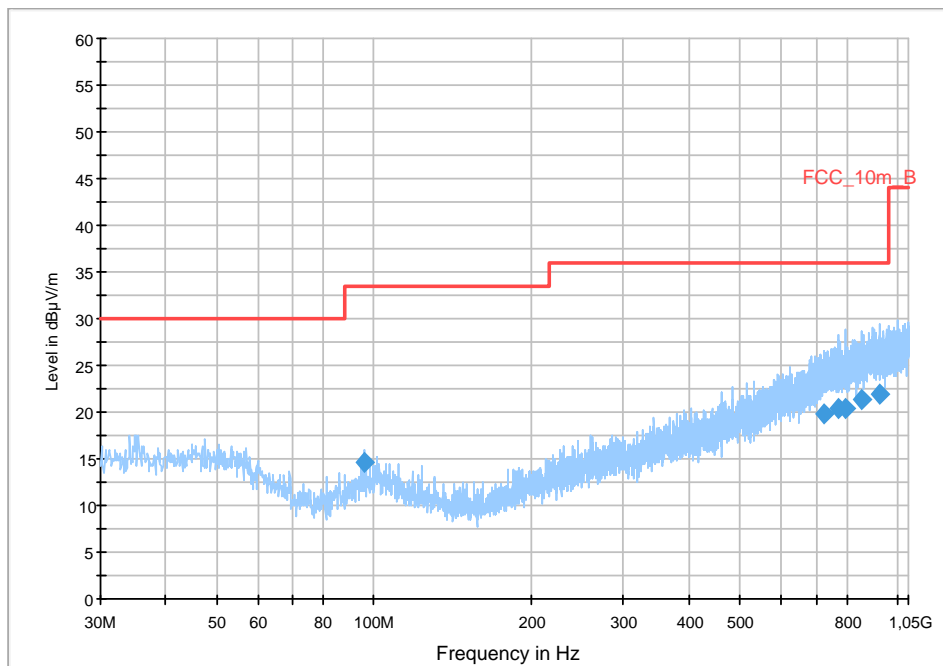

Frequency (MHz)	QuasiPeak (dBµV/m)	Meas. Time (ms)	Bandwidth (kHz)	Height (cm)	Polarization	Azimuth (deg)	Corr. (dB)	Margin (dB)	Limit (dBµV/m)
96.002100	14.6	1000.0	120.000	170.0	V	89.0	11.4	18.9	33.5
723.137700	19.8	1000.0	120.000	170.0	V	106.0	23.0	16.2	36.0
769.252800	20.3	1000.0	120.000	98.0	H	91.0	23.7	15.7	36.0
795.540600	20.4	1000.0	120.000	98.0	V	86.0	23.8	15.6	36.0
853.147050	21.3	1000.0	120.000	170.0	V	0.0	24.6	14.7	36.0
924.405450	21.9	1000.0	120.000	170.0	H	186.0	25.3	14.1	36.0

Plot 28: 1 – 12 GHz, RX-Mode, antenna vertical

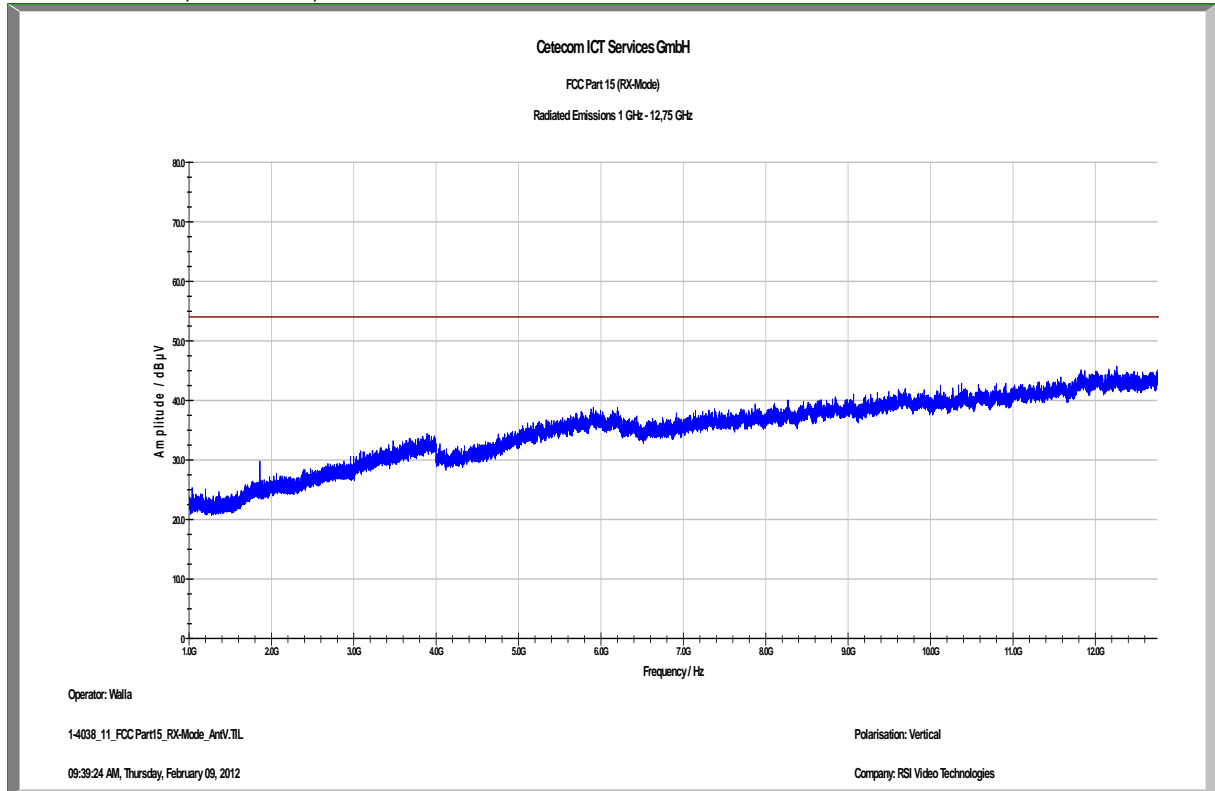

Plot 29: 1 – 12 GHz, RX-Mode, antenna horizontal

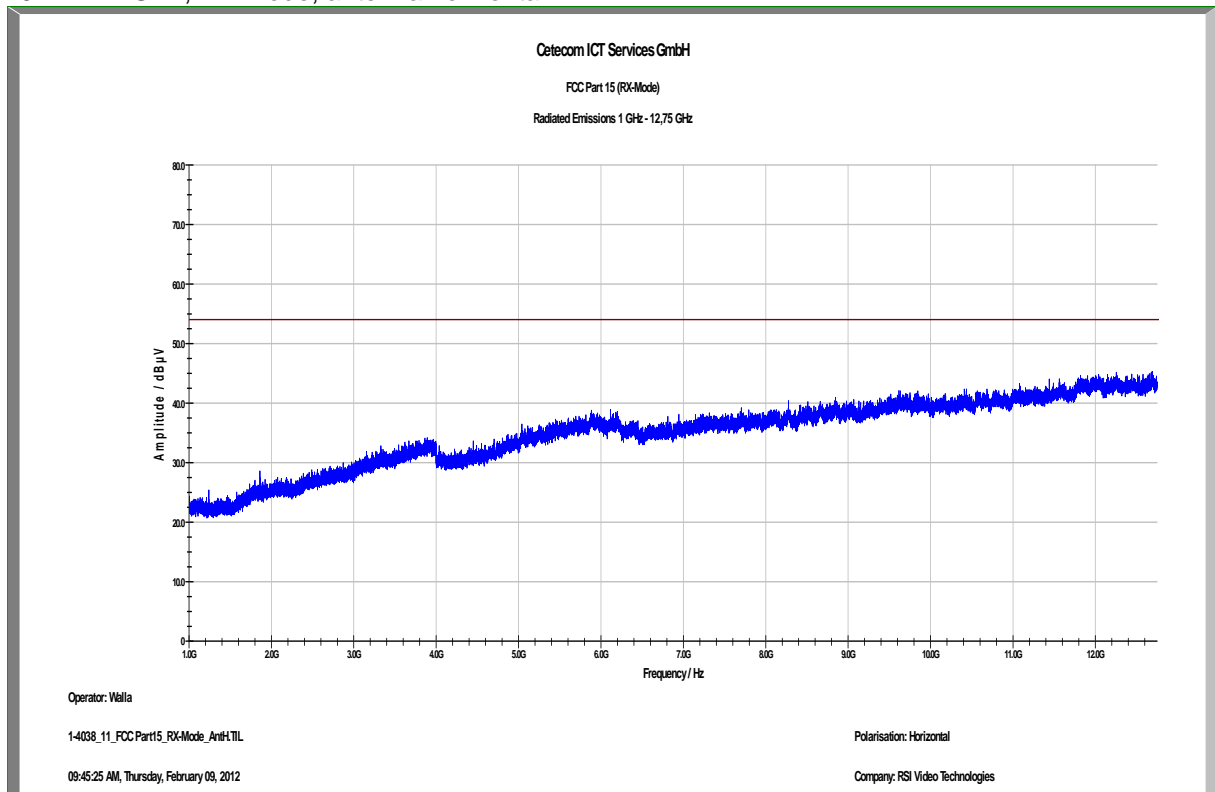

Plot 30: 12 – 25 GHz, RX-Mode, antenna vertical / horizontal

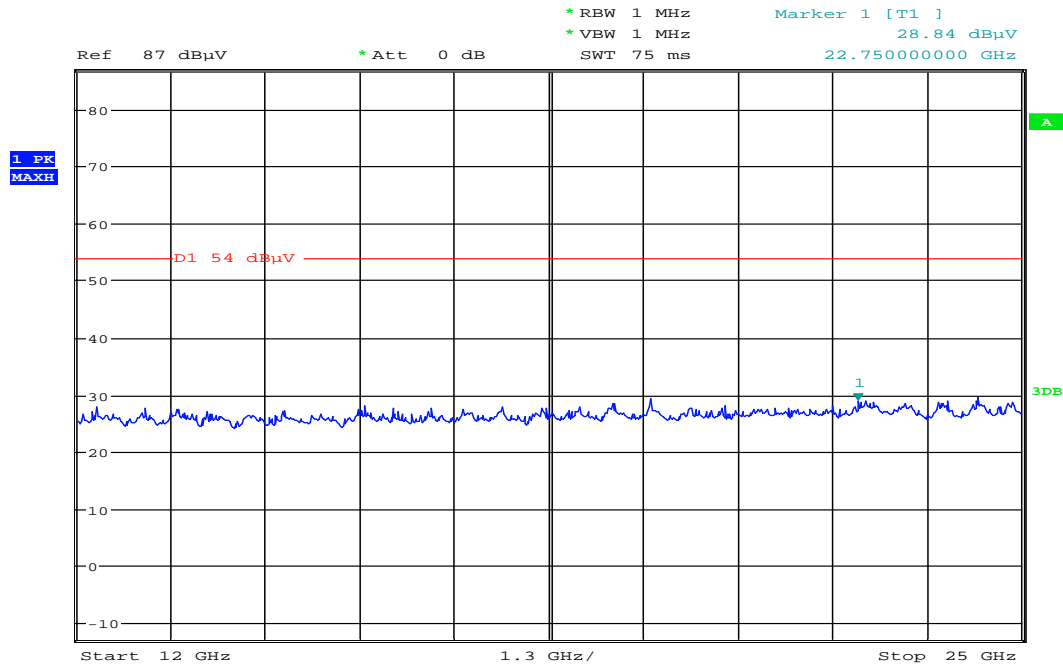

Date: 11.FEB.2012 15:02:51

Limits:

FCC		IC
§15.109		-/-
Frequency (MHz)	Field Strength (dBµV/m)	Measurement distance
30 - 88	40	3
88 – 216	43.5	3
216 – 960	46.0	3
Above 960	54.0	3

Result: Passed

10 Test equipment and ancillaries used for tests

Typically, the calibrations of the test apparatus are commissioned to and performed by an accredited calibration laboratory. The calibration intervals are determined in accordance with the DIN EN ISO/IEC 17025. In addition to the external calibrations, the laboratory executes comparison measurements with other calibrated test systems or effective verifications. Weekly chamber inspections and range calibrations are performed. Where possible, rf-generating and signalling equipment as well as measuring receivers and analyzers are connected to an external high-precision 10 MHz reference (GPS-based or rubidium frequency standard).

In order to simplify the identification of the equipment used at some special tests, some items of test equipment and ancillaries can be provided with an identifier or number in the equipment list below (Labor/Item).

No.	Lab / Item	Equipment	Type	Manufact.	Serial No.	INV. No Cetecom	Kind of Calibration	Last Calibration	Next Calibration
1	n. a.	Isolating Transformer	RT5A	Grundig	8041	300001626	g		
2	n. a.	DC power supply, 60Vdc, 50A, 1200 W	6032A	HP Meßtechnik	2818A03450	300001040	Ve	12.01.2012	12.01.2015
3	n. a.	Coaxial Attenuator 30dB/500W	8325	Bird	1530	300001595	ev		
4	n. a.	Double-Ridged Waveguide Horn Antenna 1-18.0GHz	3115	EMCO	8812-3088	300001032	vIKI!	11.05.2011	11.05.2013
5	n. a.	Active Loop Antenna	6502	EMCO	2210	300001015	ne		
6	n. a.	Anechoic chamber	FAC 3/5m	MWB / TDK	87400/02	300000996		23.03.2009	
7	Spec.A. 2_2e	System rack for EMI measurement solution	85900	HP I.V.	*	300000222	ne		
8	9	Artificial Mains 9 kHz to 30 MHz	ESH3-Z5	R&S	828576/020	300001210	Ve	06.01.2012	06.01.2014
9	n. a.	Relais Matrix	3488A	HP Meßtechnik	2719A15013	300001156	ne		
10	n. a.	Relais Matrix	PSU	R&S	890167/024	300001168	ne		
11	n. a.	Isolating Transformer	RT5A	Grundig	9242	300001263	ne		
12	n. a.	Three-Way Power Splitter, 50 Ohm	11850C	HP Meßtechnik		300000997	ne		
13	n. a.	Switch / Control Unit	3488A	HP	2605e08770	300001443	ne		
14	n. a.	Amplifier	js42-00502650-28-5a	Parzich GMBH	928979	300003143	ne		
15	n. a.	Band Reject filter	WRCG185 5/1910-1835/1925-40/8SS	Wainwright	7	300003350	ev		
16	n. a.	Band Reject filter	WRCG240 0/2483-2375/2505-50/10SS	Wainwright	11	300003351	ev		
17	n. a.	TILE-Software Emission	Quantum Change, Modell TILE-ICS/FULL	EMCO	none	300003451	ne		
18	n. a.	Highpass Filter	WHKX2.9/1 8G-12SS	Wainwright	1	300003492	ev		
19	n. a.	Highpass Filter	WHK1.1/15 G-10SS	Wainwright	3	300003255	ev		
20	n. a.	Highpass Filter	WHKX7.0/1 8G-8SS	Wainwright	18	300003789	ne		
21	n. a.	PSA Spectrum Analyzer 3 Hz - 26.5 GHz	E4440A	Agilent Technologies	MY48250080	300003812	k	08.09.2010	08.09.2012
22	n. a.	MXG Microwave Analog Signal Generator	N5183A	Agilent Technologies	MY47420220	300003813	k	13.09.2010	13.09.2012

23	n. a.	RF Filter Section 9kHz - 1GHz	N9039A	Agilent Technologies	MY48260003	300003825	vKI!	08.09.2010	08.09.2012
24	n. a.	TRIOLOG Broadband Test-Antenna 30 MHz - 3 GHz	VULB9163	Schwarzbeck	371	300003854	vKI!	14.10.2011	14.10.2014
25	45	Switch-Unit	3488A	HP Meßtechnik	2719A14505	300000368	g		
26	50	DC power supply, 60Vdc, 50A, 1200 W	6032A	HP Meßtechnik	2920A04466	300000580	ne		
27	n. a.	software	SPS_PHE 1.4f	Spitzberger & Spieß	B5981; 5D1081;B5979	300000210	ne		
28	n. a.	EMI Test Receiver	ESCI 1166.5950.03	R&S	100083	300003312	k	04.01.2012	04.01.2014
29	n. a.	Analyzer-Reference-System (Harmonics and Flicker)	ARS 16/1	SPS	A3509 07/0 0205	300003314	k	14.07.2011	14.07.2013
30	n. a.	Amplifier	JS42-00502650-28-5A	MITEQ	1084532	300003379	ev		
31	n. a.	Antenna Tower	Model 2175	ETS-LINDGREN	64762	300003745	izw		
32	n. a.	Positioning Controller	Model 2090	ETS-LINDGREN	64672	300003746	izw		
33	n. a.	Turntable Interface-Box	Model 105637	ETS-LINDGREN	44583	300003747	izw		
34	n. a.	TRIOLOG Broadband Test-Antenna 30 MHz - 3 GHz	VULB9163	Schwarzbeck	295	300003787	k	01.04.2010	01.04.2012
35	n. a.	Spectrum-Analyzer	FSU26	R&S	200809	300003874	k	10.01.2011	10.01.2013

Agenda: Kind of Calibration

k	calibration / calibrated		EK	limited calibration
ne	not required (k, ev, izw, zw not required)		zw	cyclical maintenance (external cyclical maintenance)
ev	periodic self verification		izw	internal cyclical maintenance
Ve	long-term stability recognized		g	blocked for accredited testing
vKI!	Attention: extended calibration interval			
NK!	Attention: not calibrated		*)	next calibration ordered / currently in progress

11 Observations

No observations exceeding those reported with the single test cases have been made.

Annex A Photographs of the test setup

Photo 1:



Photo 2:



Annex B External photographs of the EUT

Photo 3:



Photo 4:

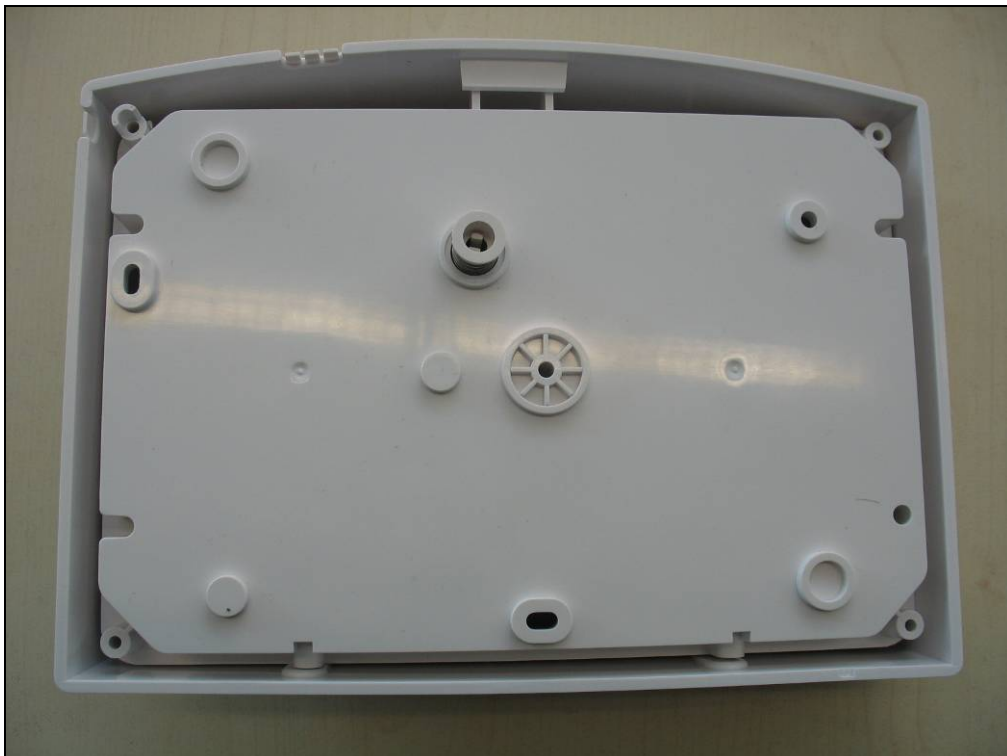

Annex C Internal photographs of the EUT

Photo 5:



Photo 6:

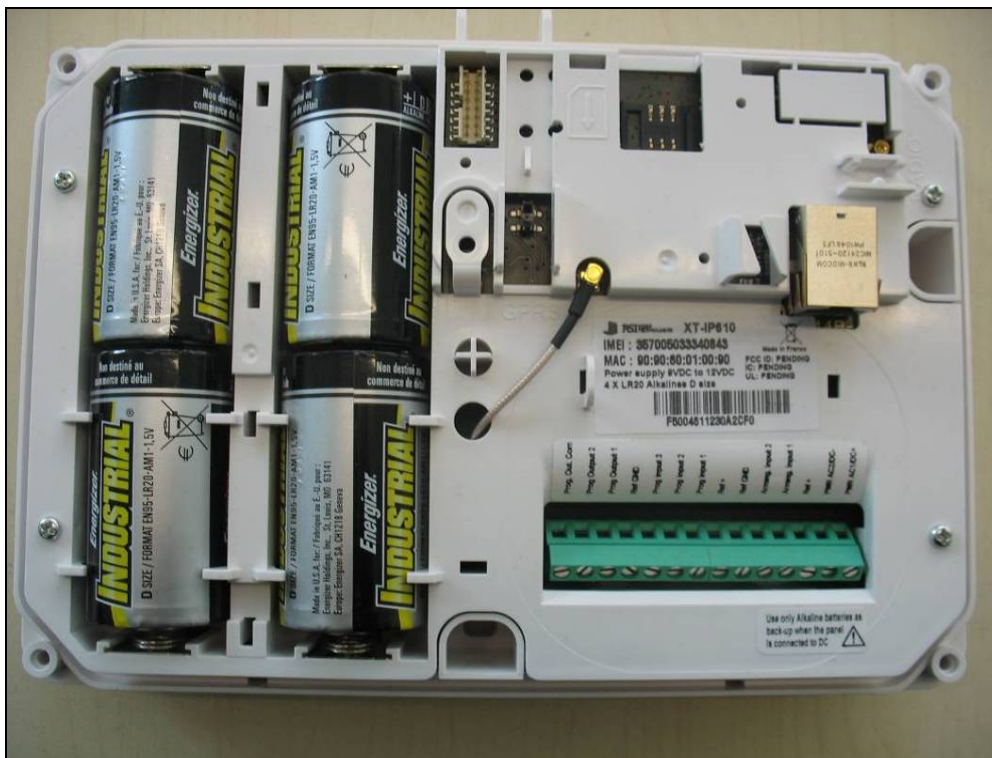

Photo 7:



Photo 8:



Photo 9:

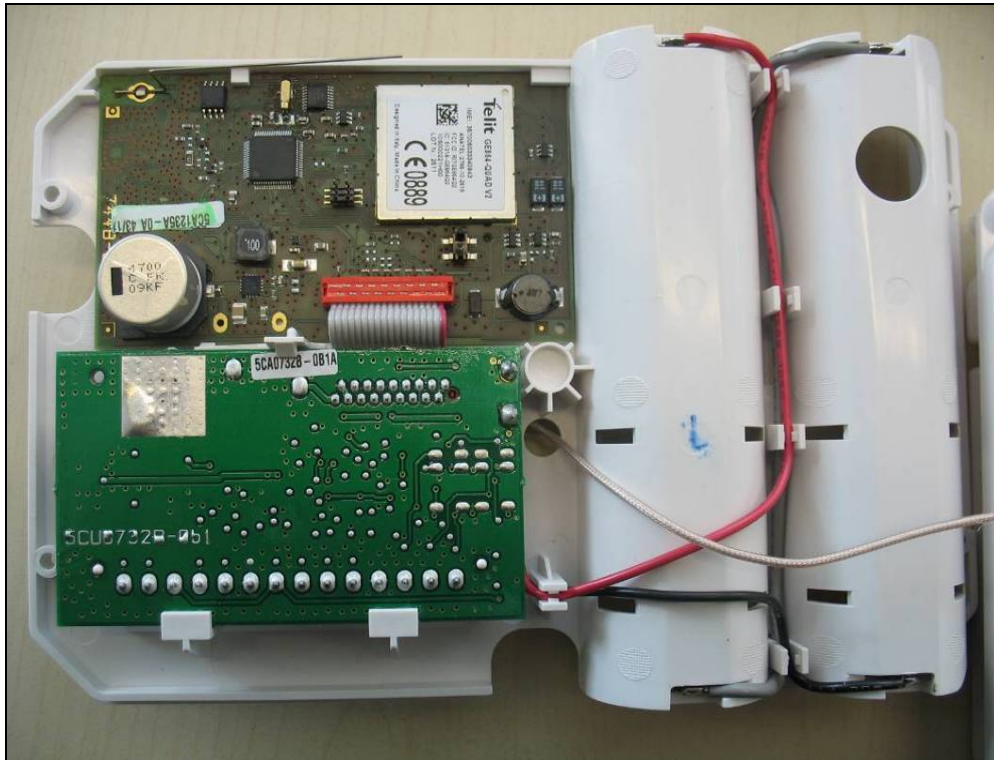

Photo 10:

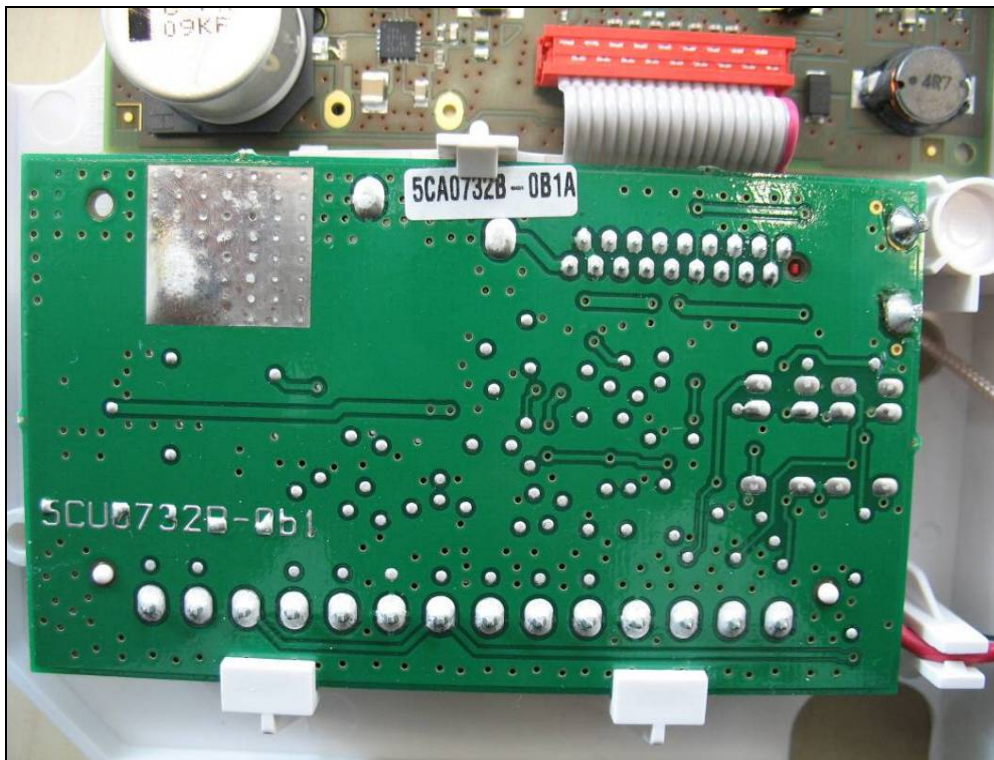

Photo 11:



Photo 12:



Photo 13:

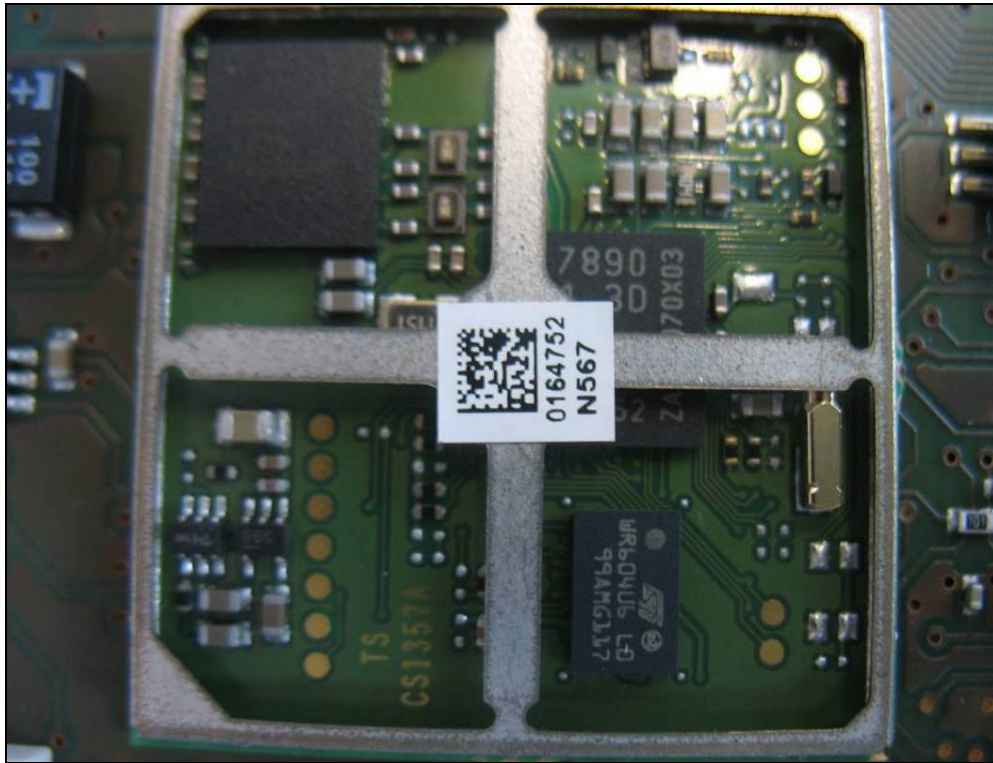

Photo 14:



Photo 15:



Photo 16:

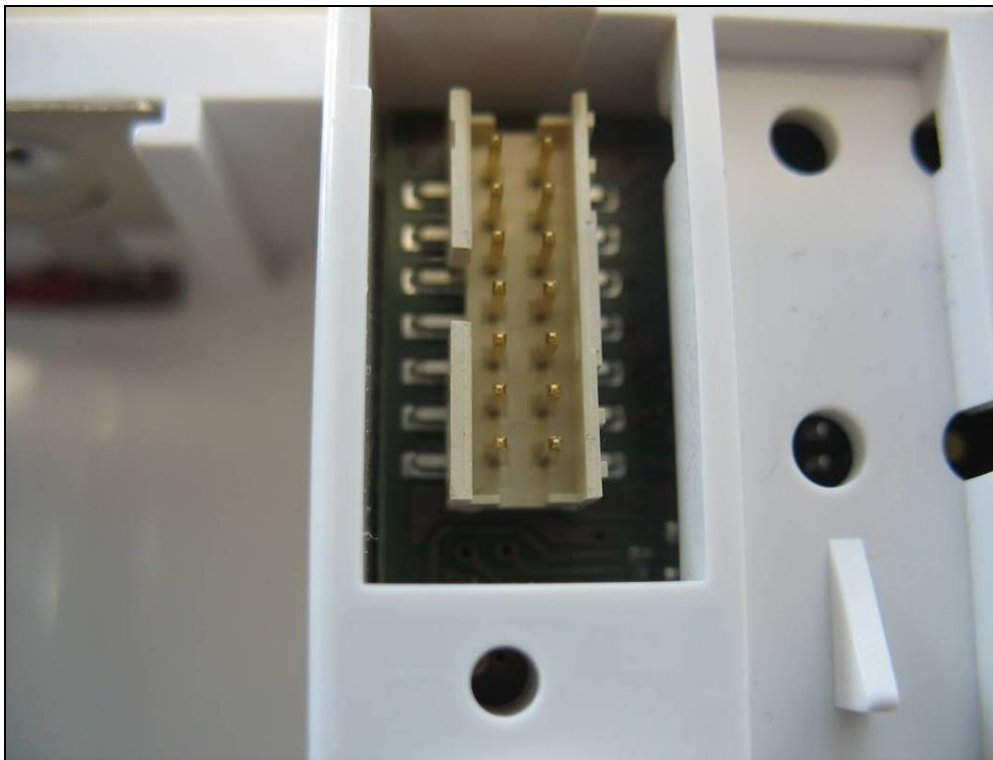

Photo 17:

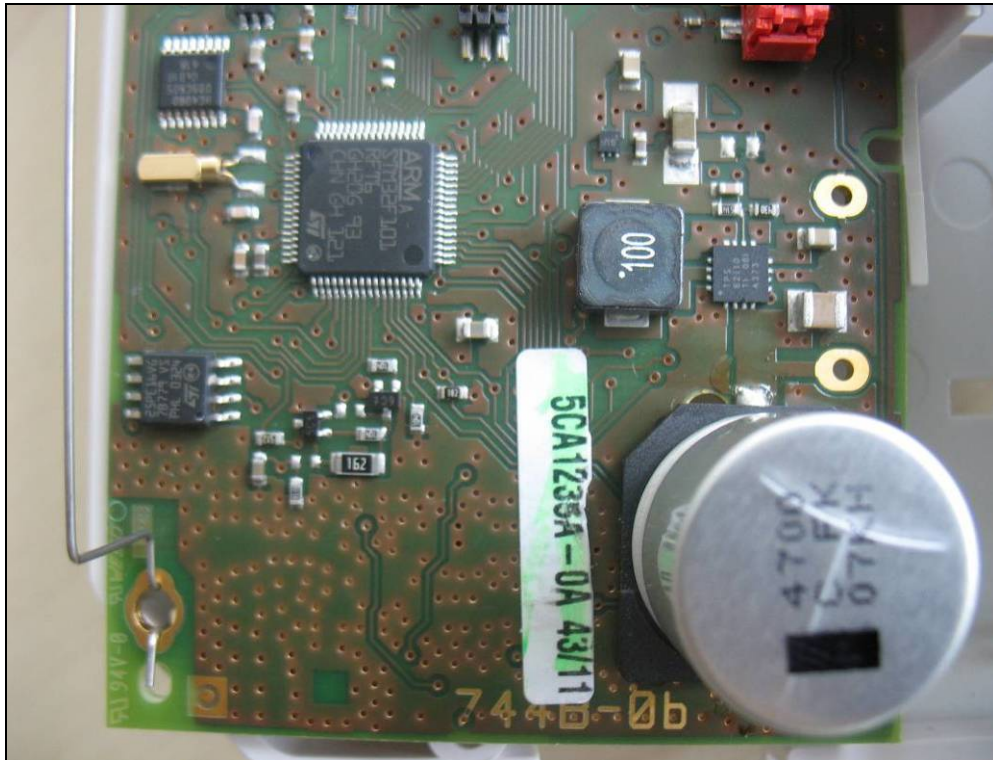

Photo 18:

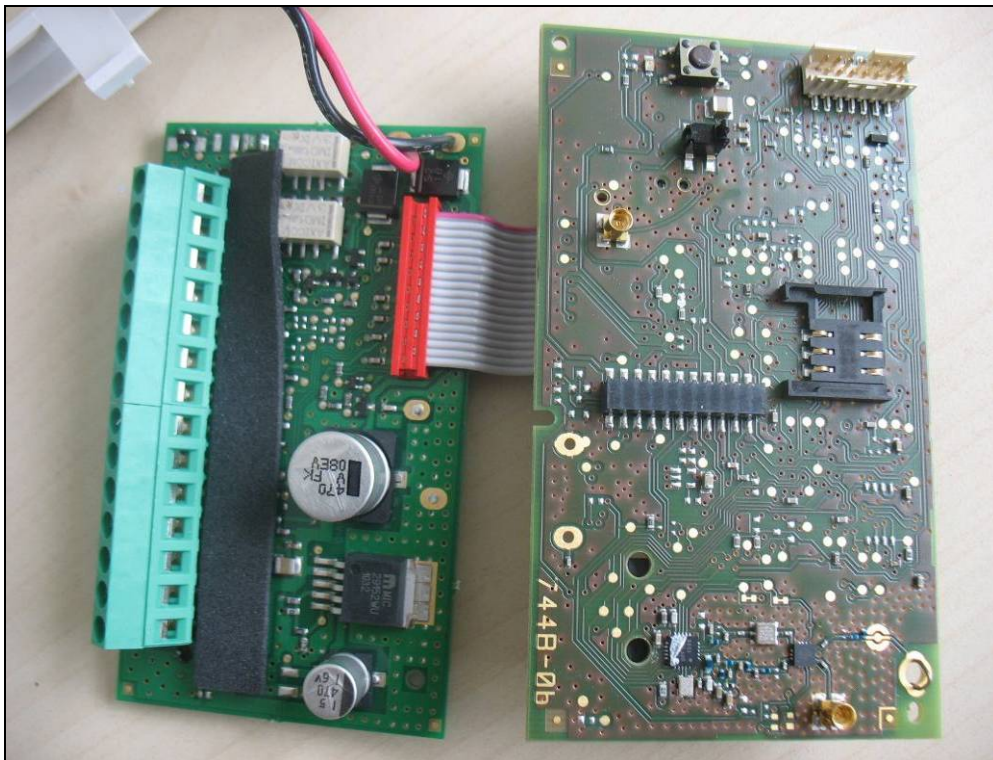

Photo 19:

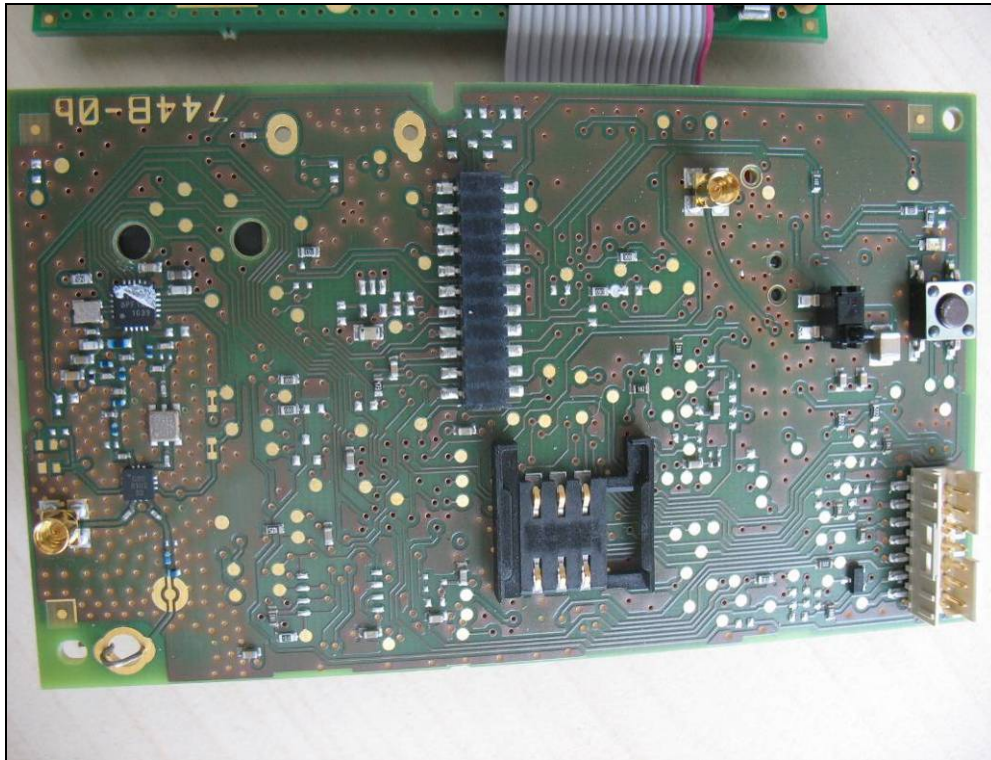

Photo 20:

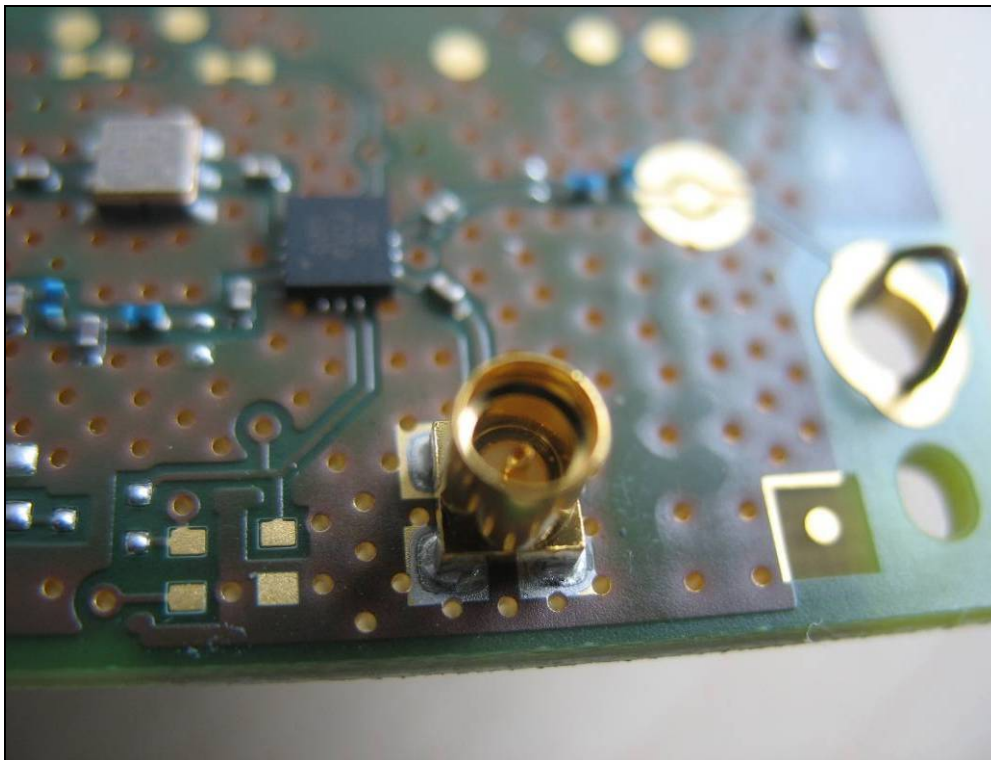

Photo 21:

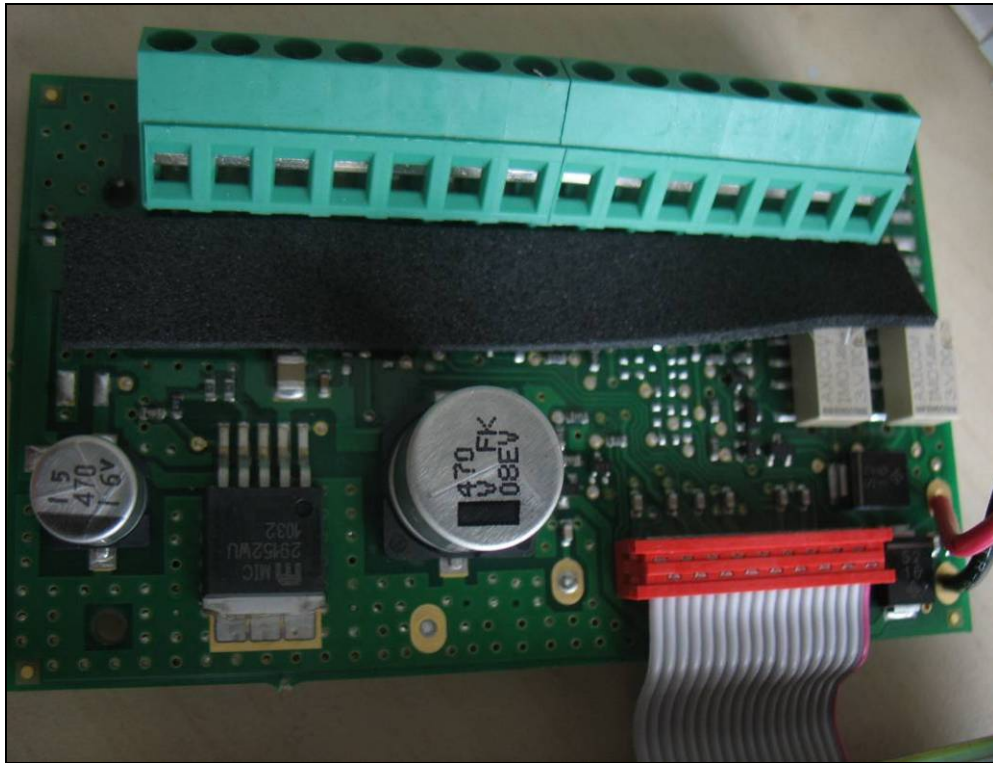

Photo 22:

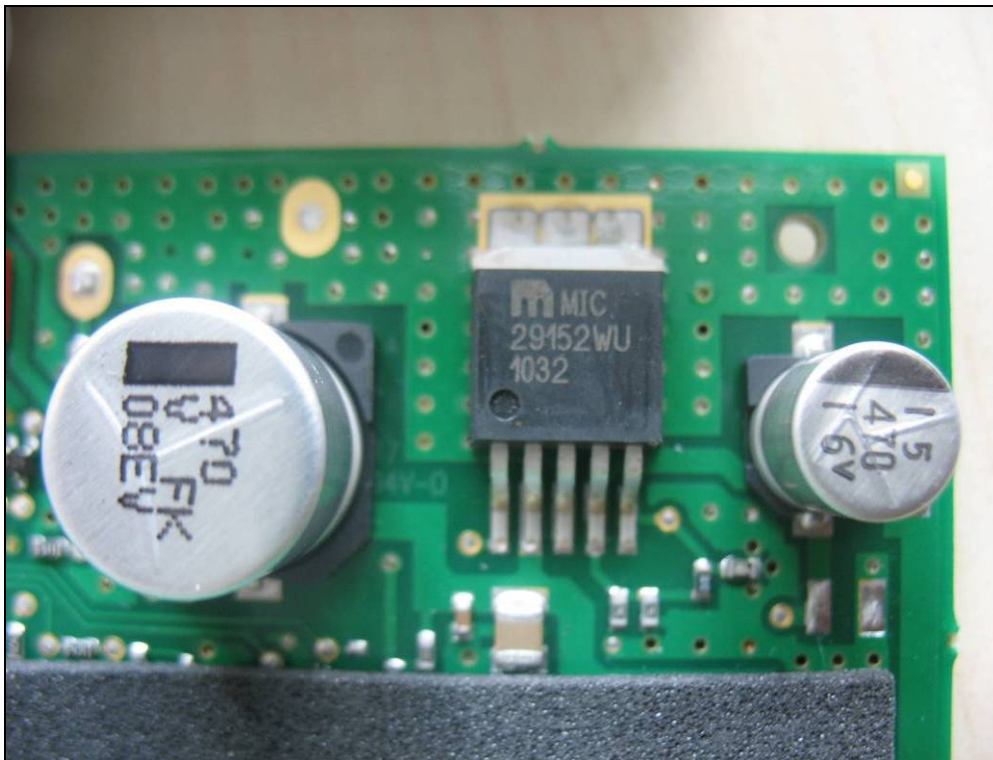

Photo 23:

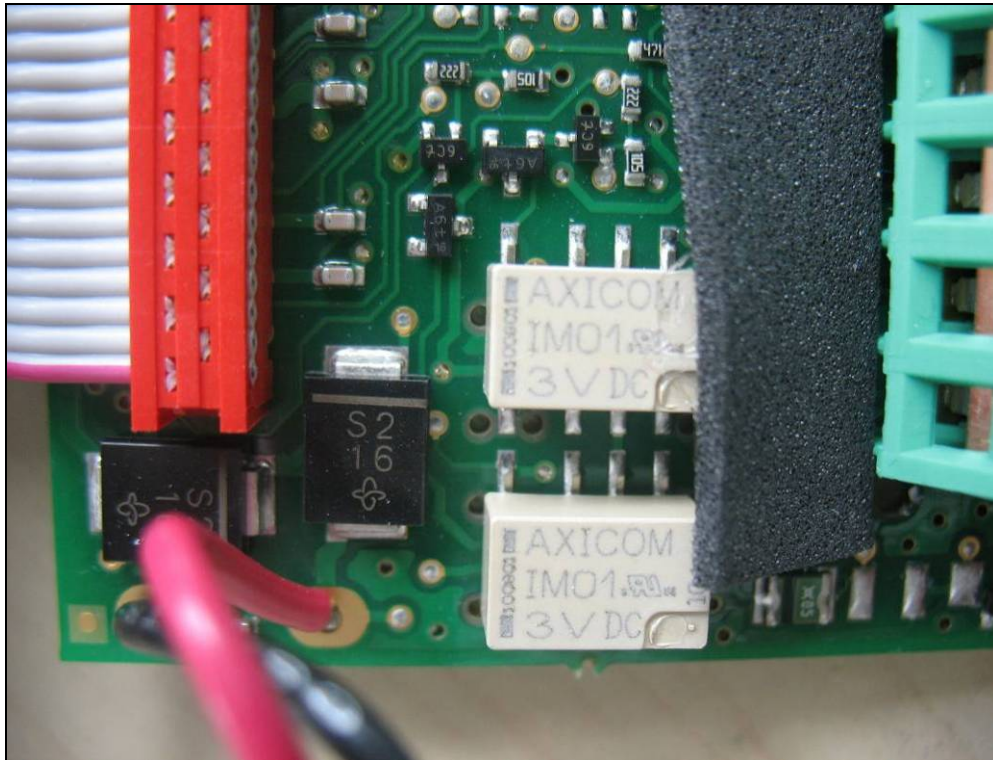

Photo 24:



Photo 25:



Photo 26:

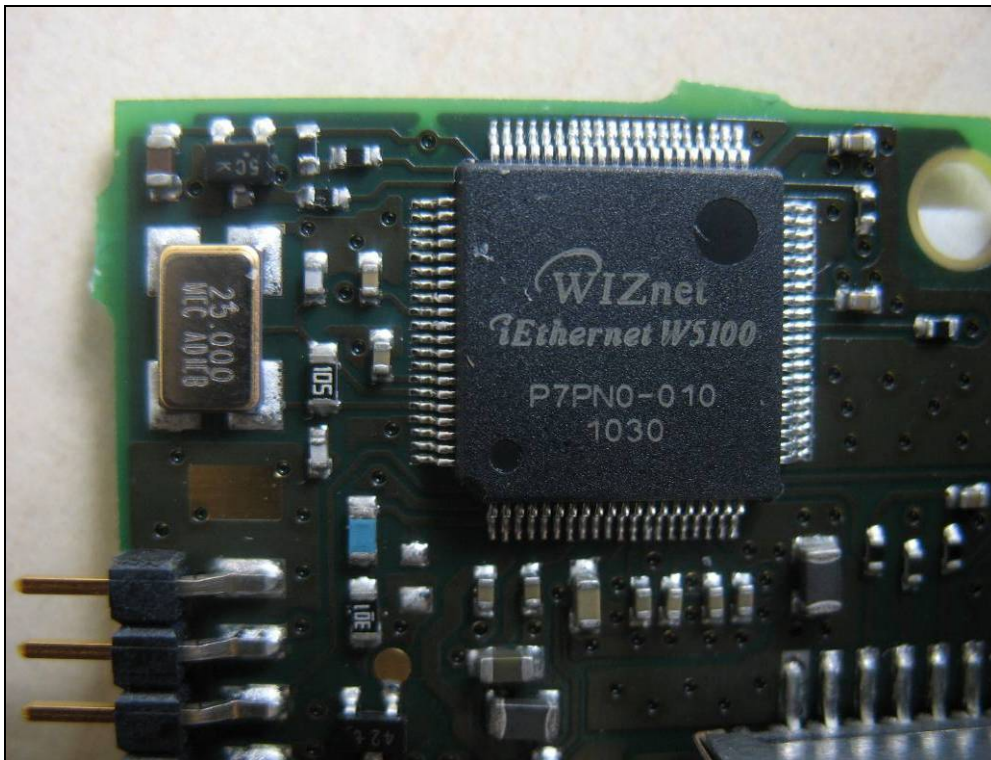

Photo 27:



Photo 28:



Annex D Document history

Version	Applied changes	Date of release
1.0	Initial release	2012-04-20
-A	Model Number changed and new internal photos added	2012-04-20

Annex E Further information**Glossary**

AVG	-	Average
DUT	-	Device under test
EMC	-	Electromagnetic Compatibility
EN	-	European Standard
EUT	-	Equipment under test
ETSI	-	European Telecommunications Standard Institute
FCC	-	Federal Communication Commission
FCC ID	-	Company Identifier at FCC
HW	-	Hardware
IC	-	Industry Canada
Inv. No.	-	Inventory number
N/A	-	Not applicable
PP	-	Positive peak
QP	-	Quasi peak
S/N	-	Serial number
SW	-	Software

Annex F Accreditation Certificate



Front side of certificate



Back side of certificate

Note:

The current certificate including annex is published on our website (see link below) or may be received from CETECOM ICT Services on request.

http://www.cetecom.com/fileadmin/de/CETECOM_D_Saarbruecken/accreditations_Jan_2010/DAKKS_Akkredi_Urk_EN17025-En_incl_Annex.pdf