

FCC Part22H&24E Test Report

Product Name : Module
Model No. : SIM5320A
FCC ID : UDV-1103022011008

Applicant : Shanghai Simcom Ltd.
Address : Building A, SIM Technology Building, No. 633, Jinzhong
Road, Changning Disdriect, Shanghai P.R. China 200335

Date of Receipt : Feb. 16, 2011
Test Date : Feb. 16, 2011 ~ Feb. 21, 2011
Issued Date : Feb. 22, 2011
Report No. : 112S009R-HP-US-P07V01
Report Version : V 3.0

The test results relate only to the samples tested.

The test results shown in the test report are traceable to the national/international standard through the calibration of the equipment and evaluated measurement uncertainty herein.

This report must not be used to claim product endorsement by TAF, NVLAP, NIST or any agency of the Government.

The test report shall not be reproduced except in full without the written approval of QuieTek Corporation.

Test Report Certification

Issued Date : Feb. 22, 2011

Report No. : 112S009R-HP-US-P07V01



Product Name : Module

Applicant : Shanghai Simcom Ltd.

Address : Building A, SIM Technology Building, No. 633, Jinzhong Road, Changning Disdriect, Shanghai P.R. China 200335

Manufacturer : Shanghai Simcom Ltd.

Address : Building A, SIM Technology Building, No. 633, Jinzhong Road, Changning Disdriect, Shanghai P.R. China 200335

Model No. : SIM5320A

FCC ID : UDV-1103022011008

EUT Voltage : 3.7V/3.4V/4.2V

Trade Name : SIMCom

Applicable Standard : FCC CFR Title 47 Part 2,TIA/EIA 603-C
FCC Part22 Subpart H, FCC Part24 Subpart E

Test Result : Complied

Performed Location : Suzhou EMC Laboratory
No.99 Hongye Rd., Suzhou Industrial Park Loufeng Hi-Tech Development Zone., Suzhou, China
TEL: +86-512-6251-5088 / FAX: +86-512-6251-5098
FCC Registration Number: 800392

Documented By : Alice Ni
(Engineering ADM: Alice Ni)

Reviewed By : Robin Wu
(Senior Engineer: Robin Wu)

Approved By : Marlinchen
(Engineering Supervisor: Marlin Chen)

Laboratory Information

We, **Quietek Corporation**, are an independent EMC and safety consultancy that was established the whole facility in our laboratories. The test facility has been accredited/accepted(audited or listed) by the following related bodies in compliance with ISO 17025, EN 45001 and specified testing scope:

Taiwan R.O.C.	: BSMI, NCC, TAF
Germany	: TUV Rheinland
Norway	: Nemko, DNV
USA	: FCC, NVLAP
Japan	: VCCI

The related certificate for our laboratories about the test site and management system can be downloaded from Quietek Corporation's Web Site : <http://www.quietek.com/tw/ctg/cts/accreditations.htm>
 The address and introduction of Quietek Corporation's laboratories can be founded in our Web site : <http://www.quietek.com/>
 If you have any comments, Please don't hesitate to contact us. Our contact information is as below:

HsinChu Testing Laboratory :

No.75-2, 3rd Lin, Wangye Keng, Yonghxing Tsuen, Qionglin Shiang, Hsinchu County 307, Taiwan, R.O.C.
 TEL:+886-3-592-8858 / FAX:+886-3-592-8859 E-Mail : service@quietek.com



LinKou Testing Laboratory :

No. 5-22, Ruei-Shu Valley, Ruei-Ping Tsuen, Lin-Kou Shiang, Taipei, Taiwan, R.O.C.
 TEL : 886-2-8601-3788 / FAX : 886-2-8601-3789 E-Mail : service@quietek.com



Suzhou (China) Testing Laboratory :

No. 99 Hongye Rd., Suzhou Industrial Park Loufeng Hi-Tech Development Zone., Suzhou,China.
 TEL : +86-512-6251-5088 / FAX : +86-512-6251-5098 E-Mail : service@quietek.com



TABLE OF CONTENTS

Description	Page
1. General Information	6
1.1. EUT Description	6
1.2. Mode of Operation	7
1.3. Tested System Details	8
1.4. Configuration of Tested System	9
1.5. EUT Exercise Software	10
2. Technical Test	11
2.1. Summary of Test Result	11
2.2. Test Environment	12
3. Peak Output Power.....	13
3.1. Test Equipment	13
3.2. Test Setup	14
3.3. Limit	14
3.4. Test Procedure	15
3.5. Uncertainty	17
3.6. Test Result	18
4. Occupied Bandwidth.....	24
4.1. Test Equipment	24
4.2. Test Setup	24
4.3. Limit	25
4.4. Test Procedure	25
4.5. Uncertainty	25
4.6. Test Result	26
5. Spurious Emission At Antenna Terminals (+/- 1MHz).....	42
5.1. Test Equipment	42
5.2. Test Setup	42
5.3. Limit	43
5.4. Test Procedure	43
5.5. Uncertainty	43
5.6. Test Result	44
6. Spurious Emission	52
6.1. Test Equipment	52
6.2. Test Setup	53
6.3. Limit	53
6.4. Test Procedure	54
6.5. Uncertainty	55

6.6. Test Result 56

7. Frequency Stability Under Temperature & Voltage Variations 64

7.1. Test Equipment 64

7.2. Test Setup 64

7.3. Limit 65

7.4. Test Procedure 65

7.5. Uncertainty 65

7.6. Test Result 66

Appendix 1 – Test Setup Photograph..... 74

Appendix 2 – EUT Photograph 76

1. General Information

1.1. EUT Description

Product Name		Module		
Brand Name		SIMCom		
Model No.		SIM5320A		
Working Voltage		3.7V/3.4V/4.2V		
Mode	GPRS/EDGE	Band	UL Frequency (MHz)	DL Frequency (MHz)
		850	824~849	869~894
		1900	1850~1910	1930~1990
	WCDMA R99 HSDPA R5	Band	UL Frequency (MHz)	DL Frequency (MHz)
		II	1850~1910	1930~1990
		V	824~849	869~894
Channel Control		Auto		
Antenna Peak Gain		1.83dBi for GSM850; -2.14dBi for PCS1900		

1.2. Mode of Operation

QuieTek has verified the construction and function in typical operation. All the test modes were carried out with the EUT in normal operation, which was shown in this test report and defined as:

Test Mode
Mode 1: GSM850 GPRS Link
Mode 2: PCS1900 GPRS Link
Mode 3: GSM850 EDGE Link
Mode 4: PCS1900 EDGE Link
Mode 5: WCDMA Band II Link
Mode 6: WCDMA Band V Link
Mode 7: HSDPA Band II Link
Mode 8: HSDPA Band V Link

1.3. Tested System Details

The types for all equipments, plus descriptions of all cables used in the tested system (including inserted cards) are:

	Product	Manufacturer	Model No.	Serial No.	Power Cord
1	CMU200	R&S	CMU200	N/A	N/A

1.4. Configuration of Tested System

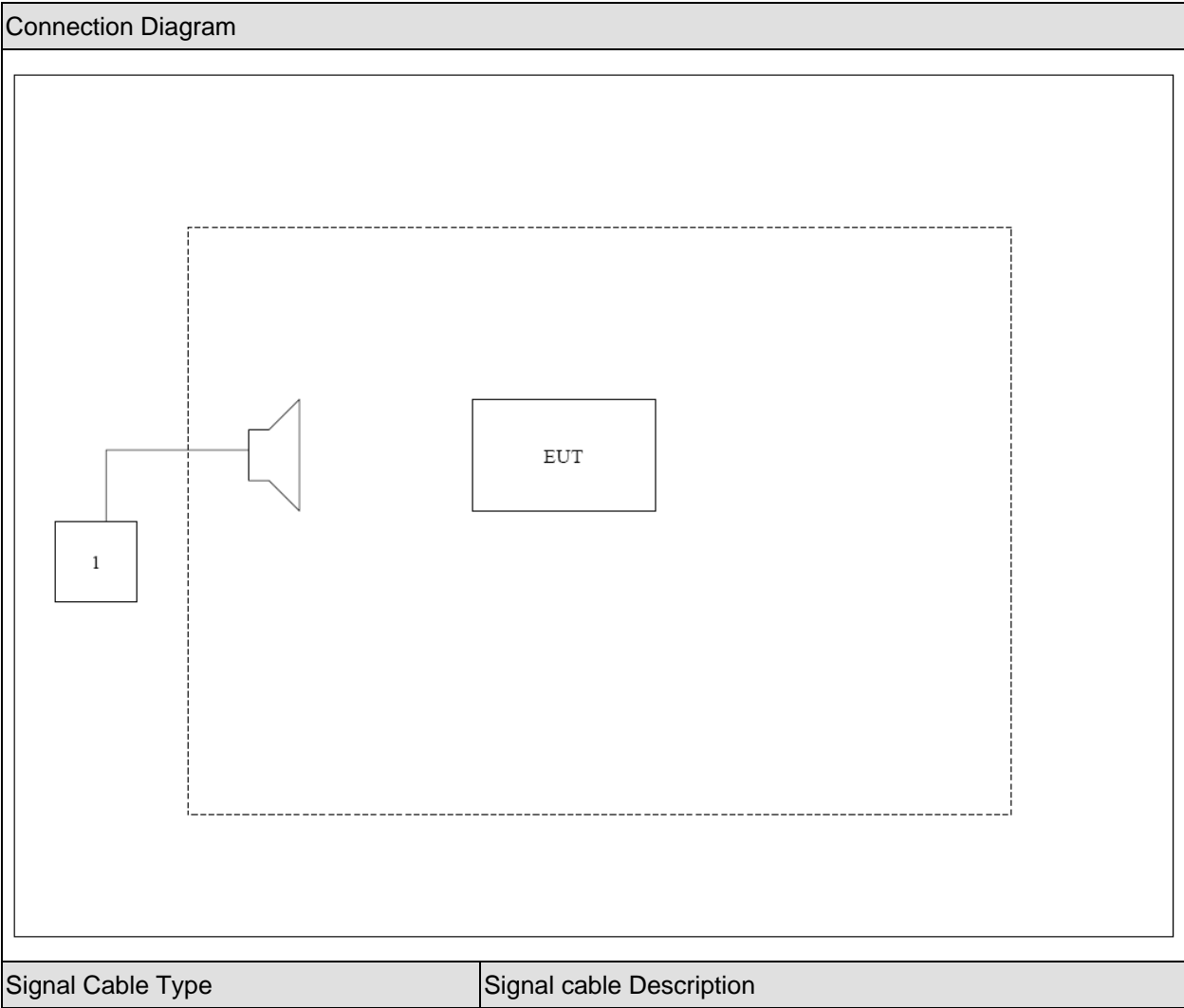

1.5. EUT Exercise Software

1	Setup the EUT and simulators as shown on above.
2	Turn on the power of all equipment.
3	EUT Communicate with CMU200, then select channel to test.

2. Technical Test

2.1. Summary of Test Result

- No deviations from the test standards
- Deviations from the test standards as below description:

For GSM850, and WCDMA Band V (FCC Part 22H & Part 2)

Performed Item	Section in CFR 47	Test Performed	Deviation
Peak Output Power	FCC Part 22.913(a)(2) and Part 2.1046	Yes	No
Modulation Characteristic	FCC Part 2.1047(d)	Yes	No
Occupied Bandwidth	FCC Part 2.1049	Yes	No
Spurious Emission At Antenna Terminals (+/- 1MHz)	FCC Part 22.917(a) and Part 2.1049	Yes	No
Spurious Emission	FCC Part 22.917(b) and Part 2.1051, 2.1053	Yes	No
Frequency Stability Under Temperature & Voltage Variations	FCC Part 22.355 and 2.1055	Yes	No

For PCS1900, and WCDMA Band II (FCC Part 24E & Part 2)

Performed Item	Section in CFR 47	Test Performed	Deviation
Peak Output Power	FCC Part 24.232(b) and Part 2.1046	Yes	No
Modulation Characteristic	FCC Part 2.1047(d)	Yes	No
Occupied Bandwidth	FCC Part 24.238(b) and Part 2.1049	Yes	No
Spurious Emission At Antenna Terminals (+/- 1MHz)	FCC Part 24.238(a) and Part 2.1049	Yes	No
Spurious Emission	FCC Part 24.238(b) and Part 2.1051, 2.1053	Yes	No
Frequency Stability Under Temperature & Voltage Variations	FCC Part 24.235 and 2.1055	Yes	No

2.2. Test Environment

Items	Required (IEC 68-1)	Actual
Temperature (°C)	15-35	23
Humidity (%RH)	25-75	52
Barometric pressure (mbar)	860-1060	950-1000

3. Peak Output Power

3.1. Test Equipment

Peak Output Power / AC-5

Instrument	Manufacturer	Type No.	Serial No	Cali. Due Date
PSA Series Spectrum Analyzer	Agilent	E4440A	MY49420184	2011.04.10
Radio Communication Tester	R&S	CMU 200	117088	2011.07.12
Dual Directional Coupler	Agilent	778D	20160	2011.04.20
10dB Coaxial Coupler	Agilent	87300C	MY44300299	2011.04.20
PSG Analog Signal Generator	Agilent	E8257D	MY44321116	2011.04.23
Preamplifier	QuieTek	AP-025C	CHM-0503006	2011.05.05
Preamplifier	Miteq	NSP1800-25	1364185	2011.05.05
Bilog Antenna	Teseq GmbH	CBL6112D	27612	2011.10.18
Half Wave Tuned Dipole Antenna	COM-POWER	AD-100	40137	2011.11.24
Broad-Band Horn Antenna	Schwarzbeck	BBHA9120D	737	2011.11.24
Broad-Band Horn Antenna	Schwarzbeck	BBHA9120D	499	2011.06.11
Temperature/Humidity Meter	Zhicheng	ZC1-2	AC5-TH	2012.01.14

3.2. Test Setup

Conducted Power Measurement:

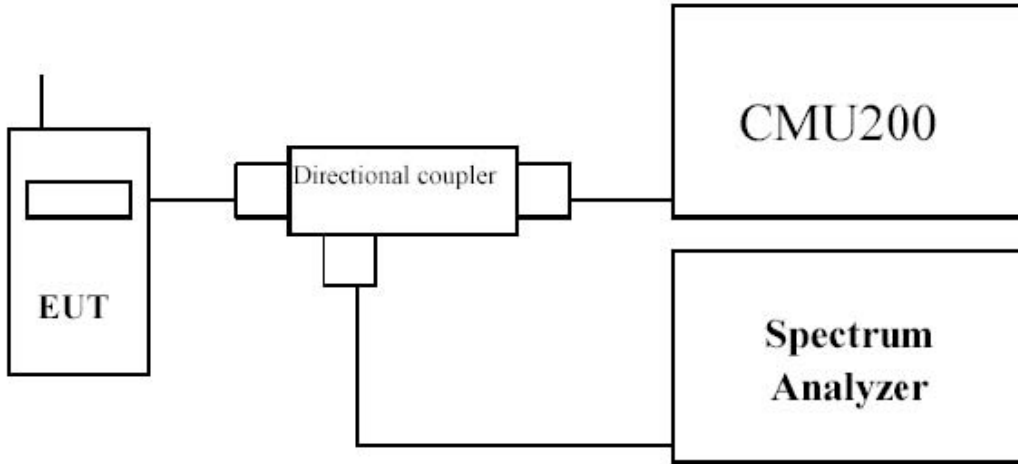

Radiated Power Measurement:

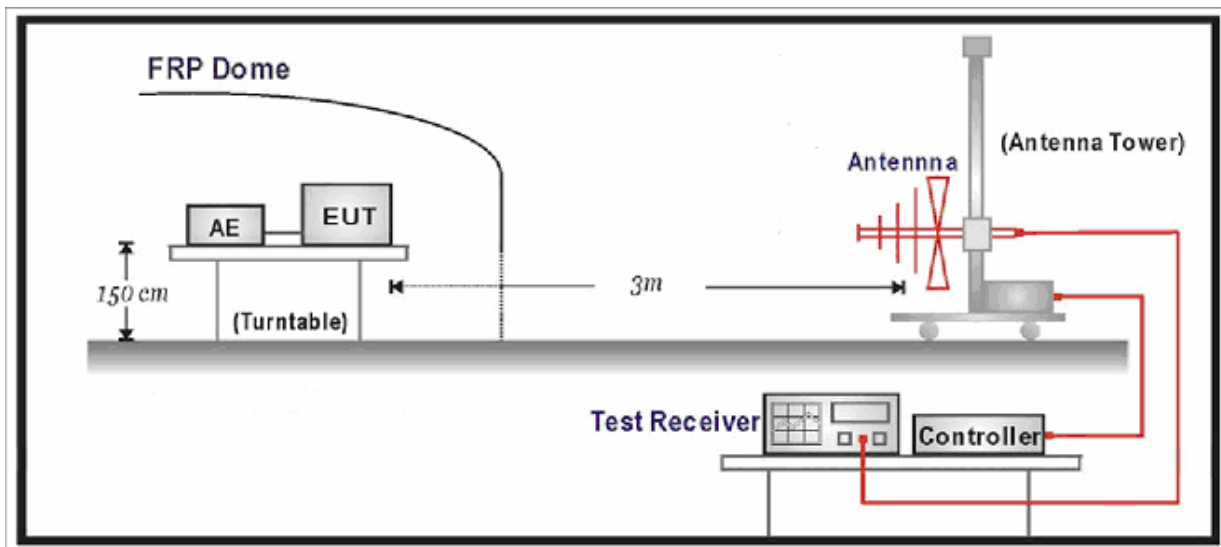

3.3. Limit

For FCC Part 22.913(a)(2):

The ERP of mobile transmitters and auxiliary test transmitters must not exceed 7 Watts.

For FCC Part 24.232(b):

The EIRP of mobile transmitters and auxiliary test transmitters must not exceed 2 Watts.

3.4. Test Procedure

Conducted Power Measurement:

- a) Place the EUT on a bench and set it in transmitting mode.
- b) Connect a low loss RF cable from the antenna port to a spectrum analyzer and CMU200 by a Directional Couple.
- c) EUT Communicate with CMU200, then selects a channel for testing.
- d) Add a correction factor to the display of spectrum, and then test.

Radiated Power Measurement:

- e) The EUT shall be placed at the specified height on a support, and in the position closest to normal use as declared by provider.
- f) The test antenna shall be oriented initially for vertical polarization and shall be chosen to correspond to the frequency of the transmitter
- g) The output of the test antenna shall be connected to the measuring receiver.
- h) The transmitter shall be switched on and the measuring receiver shall be tuned to the frequency of the transmitter under test.
- i) The test antenna shall be raised and lowered through the specified range of height until a maximum signal level is detected by the measuring receiver.
- j) The transmitter shall then be rotated through 360° in the horizontal plane, until the maximum signal level is detected by the measuring receiver.
- k) The test antenna shall be raised and lowered again through the specified range of height until a maximum signal level is detected by the measuring receiver.
- l) The maximum signal level detected by the measuring receiver shall be noted.
- m) The transmitter shall be replaced by a substitution antenna.
- n) The substitution antenna shall be orientated for vertical polarization and the length of the substitution antenna shall be adjusted to correspond to the frequency of the transmitter.
- o) The substitution antenna shall be connected to a calibrated signal generator.
- p) If necessary, the input attenuator setting of the measuring receiver shall be adjusted in order to increase the sensitivity of the measuring receiver.
- q) The test antenna shall be raised and lowered through the specified range of height to ensure that the maximum signal is received.
- r) The input signal to the substitution antenna shall be adjusted to the level that produces a level detected by the measuring receiver, that is equal to the level noted while the transmitter radiated power was measured, corrected for the change of input attenuator setting of the measuring receiver.
- s) The measurement shall be repeated with the test antenna and the substitution antenna orientated for horizontal polarization.

- t) The measure of the effective radiated power is the larger of the two levels recorded at the input to the substitution antenna, corrected for gain of the substitution antenna if necessary.

Base station simulator settings for each test mode:

1. For GSM/GPRS/EDGE

Configure R&S CMU200 to support GMSK and 8PSK call respectively, and set one timeslot transmission for GMSK GSM/GPRS and 8PSK EDGE.

Measure and record power outputs for both modulations.

2. For WCDMA/HSDPA

Configure the CMU-200 to support all WCDMA tests in respect to the 3GPP 34.121.

Measure the EUT output power at 826.4MHz, 836.6MHz and 846.6MHz for WCDMA Band V and 1852.4MHz, 1880MHz and 1907.6MHz for WCDMA Band II.

For Rel 99

- Set a Test Mode 1 loop back with a 12.2kbps Reference Measurement Channel (RMC)
- Set and send continuously Up power control commands to the Gobi2000
- Measure the power at the Gobi2000 Module antenna connector by using CMU-200.

For HSDPA Rel 5

- Establish a Test Mode 1 look back with both 12.2kbps RMC channel and a H-Set1 Fixed Reference Channel (FRC). With the CMU-200 this is accomplished by setting the signal Channel Coding to "Fixed Reference Channel" and configuring for HSET-1 QKSP.
- Set beta values and HSDPA settings for HSDPA Subtest1 according to Table C.10.1.4
- Send continuously Up power control commands to the Gobi2000
- Measure the power at the Gobi2000 Module antenna connector by using CMU-200 mean power.
- The mean power shall be averaged over at least one timeslot.
- Repeat the measurement for the HSDPA Subtest2, 3 and 4 as given in Table C.10.1.4

3GPP HSDPA Sub-test Setting from TS 34 121

Table C.10.1.4: β values for transmitter characteristics tests with HS-DPCCH

Sub-test	β_c	β_d	β_c/β_d	β_{HS}	CM (dB)	MPR (dB)
1	2/15	15/15	2/15	4/15	0.0	0.0
2	12/15	15/15	12/15	24/15	1.0	0.0
3	15/15	8/15	15/8	30/15	1.5	0.5
4	15/15	4/15	15/4	30/15	1.5	0.5

3.5. Uncertainty

The measurement uncertainty is defined as for Conducted Power Measurement ± 1.2 dB, for Radiated Power Measurement ± 3.2 dB

3.6. Test Result

GSM/GPRS/EDGE

GPRS 850

Channel No.	Frequency (MHz)	Modulation	Conducted Output Power (dBm)	ERP (dBm)	Limit (dBm)
128	824.2	GMSK	33.40	32.39	38.50
189	836.4	GMSK	33.20	31.55	38.50
251	848.8	GMSK	32.80	34.01	38.50

GPRS1900

Channel No.	Frequency (MHz)	Modulation	Conducted Output Power (dBm)	EIRP (dBm)	Limit (dBm)
512	1850.2	GMSK	29.61	27.57	33.00
661	1880.0	GMSK	29.34	25.02	33.00
810	1909.8	GMSK	29.16	25.31	33.00

EDGE 850

Channel No.	Frequency (MHz)	Modulation	Conducted Output Power (dBm)	ERP (dBm)	Limit (dBm)
128	824.2	8PSK	27.50	29.33	38.50
189	836.4	8PSK	27.30	25.58	38.50
251	848.8	8PSK	27.00	27.78	38.50

EDGE 1900

Channel No.	Frequency (MHz)	Modulation	Conducted Output Power (dBm)	EIRP (dBm)	Limit (dBm)
512	1850.2	8PSK	25.87	22.17	33.00
661	1880.0	8PSK	25.68	21.68	33.00
810	1909.8	8PSK	25.63	21.92	33.00

Note: All conducted measurements are based on a peak detector.

WCDMA/HSDPA

Mode	3GPP Subtest	Band II (1900MHz) Channel			MPR
		Conducted Power (dBm)			
		9262	9400	9538	
WCDMA R99	1	22.34	22.66	22.22	N/A
Rel5 HSDPA	1	22.46	22.44	22.20	0
	2	22.33	22.26	22.13	0
	3	22.11	21.94	21.87	0.5
	4	21.95	22.03	21.97	0.5

Mode	3GPP Subtest	Band V (850MHz) Channel			MPR
		Conducted Power (dBm)			
		4132	4182	4233	
WCDMA R99	1	23.85	23.10	23.43	N/A
Rel5 HSDPA	1	23.84	23.19	23.28	0
	2	23.68	23.01	23.11	0
	3	23.12	22.76	22.87	0.5
	4	23.21	22.67	22.46	0.5

Note: All conducted measurements are based on an average detector.

Radiated Measurement

GPRS850

Frequency (MHz)	SA Reading (dBm)	Ant.Pol. (H/V)	SG Reading (dBm)	Cable Loss (dB)	Gain (dBd)	ERP (dBm)	Limit (dBm)	Margin (dB)
Low Channel 128								
824.20	18.10	H	34.97	2.56	-0.02	32.39	38.5	-6.11
824.20	14.77	V	30.68	2.56	-0.02	28.10	38.5	-10.40
Middle Channel 189								
836.40	17.24	H	34.04	2.59	0.10	31.55	38.5	-6.95
836.40	15.16	V	31.20	2.59	0.10	28.71	38.5	-9.79
High Channel 251								
848.80	19.69	H	36.42	2.54	0.13	34.01	38.5	-4.49
848.80	18.39	V	34.58	2.54	0.13	32.17	38.5	-6.33

GPRS1900

Frequency (MHz)	SA Reading (dBm)	Ant.Pol. (H/V)	SG Reading (dBm)	Cable Loss (dB)	Gain (dBi)	EIRP (dBm)	Limit (dBm)	Margin (dB)
Low Channel 512								
1850.20	26.58	H	9.80	3.55	10.40	16.65	33	-16.35
1850.20	37.59	V	20.72	3.55	10.40	27.57	33	-5.43
Middle Channel 661								
1880.00	23.22	H	6.42	3.53	10.43	13.32	33	-19.68
1880.00	34.99	V	18.12	3.53	10.43	25.02	33	-7.98
High Channel 810								
1909.80	23.88	H	7.11	3.56	10.44	13.99	33	-19.01
1909.80	35.26	V	18.43	3.56	10.44	25.31	33	-7.69

EDGE850

Frequency (MHz)	SA Reading (dBm)	Ant.Pol. (H/V)	SG Reading (dBm)	Cable Loss (dB)	Gain (dBd)	ERP (dBm)	Limit (dBm)	Margin (dB)
Low Channel 128								
824.20	15.04	H	31.91	2.56	-0.02	29.33	38.5	-9.17
824.20	11.95	V	27.86	2.56	-0.02	25.28	38.5	-13.22
Middle Channel 189								
836.40	11.27	H	28.07	2.59	0.10	25.58	38.5	-12.92
836.40	9.22	V	25.27	2.59	0.10	22.78	38.5	-15.72
High Channel 251								
848.80	13.46	H	30.19	2.54	0.13	27.78	38.5	-10.72
848.80	12.24	V	28.43	2.54	0.13	26.02	38.5	-12.48

EDGE1900

Frequency (MHz)	SA Reading (dBm)	Ant.Pol. (H/V)	SG Reading (dBm)	Cable Loss (dB)	Gain (dBi)	EIRP (dBm)	Limit (dBm)	Margin (dB)
Low Channel 512								
1850.20	26.11	H	9.33	3.55	10.40	16.18	33	-16.82
1850.20	32.20	V	15.32	3.55	10.40	22.17	33	-10.83
Middle Channel 661								
1880.00	19.35	H	2.56	3.53	10.43	9.46	33	-23.54
1880.00	31.64	V	14.78	3.53	10.43	21.68	33	-11.32
High Channel 810								
1909.80	20.42	H	3.65	3.56	10.44	10.53	33	-22.47
1909.80	31.88	V	15.04	3.56	10.44	21.92	33	-11.08

WCDMA FDD II

Frequency (MHz)	SA Reading (dBm)	Ant.Pol. (H/V)	SG Reading (dBm)	Cable Loss (dB)	Gain (dBi)	EIRP (dBm)	Limit (dBm)	Margin (dB)
Low Channel 9262								
1852.40	17.35	H	0.57	3.55	10.40	7.42	33	-25.58
1852.40	30.13	V	13.26	3.55	10.40	20.11	33	-12.89
Middle Channel 9400								
1880.00	18.77	H	1.98	3.53	10.43	8.88	33	-24.12
1880.00	29.99	V	13.12	3.53	10.43	20.02	33	-12.98
High Channel 9538								
1907.60	17.44	H	0.68	3.56	10.44	7.56	33	-25.44
1907.60	31.45	V	14.62	3.56	10.44	21.50	33	-11.50

WCDMA FDD V

Frequency (MHz)	SA Reading (dBm)	Ant.Pol. (H/V)	SG Reading (dBm)	Cable Loss (dB)	Gain (dBd)	ERP (dBm)	Limit (dBm)	Margin (dB)
Low Channel 4132								
826.40	9.40	H	26.28	2.56	-0.02	23.70	38.5	-14.80
826.40	6.41	V	22.40	2.56	-0.02	19.82	38.5	-18.68
Middle Channel 4182								
836.40	8.64	H	25.44	2.59	0.1	22.95	38.5	-15.55
836.40	6.08	V	22.15	2.59	0.1	19.66	38.5	-18.84
High Channel 4233								
846.60	8.84	H	25.57	2.54	0.13	23.16	38.5	-15.34
846.60	7.16	V	23.33	2.54	0.13	20.92	38.5	-17.58

HSDPA FDD II

Frequency (MHz)	SA Reading (dBm)	Ant.Pol. (H/V)	SG Reading (dBm)	Cable Loss (dB)	Gain (dBi)	EIRP (dBm)	Limit (dBm)	Margin (dB)
Low Channel 9262								
1852.40	18.38	H	1.60	3.55	10.40	8.45	33	-24.55
1852.40	29.18	V	12.31	3.55	10.40	19.16	33	-13.84
Middle Channel 9400								
1880.00	19.82	H	3.03	3.53	10.43	9.93	33	-23.07
1880.00	31.57	V	14.70	3.53	10.43	21.60	33	-11.40
High Channel 9538								
1907.60	19.09	H	2.32	3.56	10.44	9.20	33	-23.80
1907.60	30.52	V	13.70	3.56	10.44	20.58	33	-12.42

HSDPA FDD V

Frequency (MHz)	SA Reading (dBm)	Ant.Pol. (H/V)	SG Reading (dBm)	Cable Loss (dB)	Gain (dBd)	ERP (dBm)	Limit (dBm)	Margin (dB)
Low Channel 4132								
826.40	10.60	H	27.47	2.56	-0.02	24.89	38.5	-13.61
826.40	7.62	V	23.60	2.56	-0.02	21.02	38.5	-17.48
Middle Channel 4182								
836.40	9.76	H	26.51	2.59	0.1	24.02	38.5	-14.48
836.40	7.39	V	23.41	2.59	0.1	20.92	38.5	-17.58
High Channel 4233								
846.60	10.15	H	26.88	2.54	0.13	24.47	38.5	-14.03
846.60	8.43	V	24.55	2.54	0.13	22.14	38.5	-16.36

4. Occupied Bandwidth

4.1. Test Equipment

Occupied Bandwidth / AC-6

Instrument	Manufacturer	Type No.	Serial No	Cali. Due Date
PSA Series Spectrum Analyzer	Agilent	E4440A	MY49420184	2011.04.10
Radio Communication Tester	R&S	CMU 200	117088	2011.07.12
Dual Directional Coupler	Agilent	778D	20160	2011.04.20
10dB Coaxial Coupler	Agilent	87300C	MY44300299	2011.04.20
Temperature/Humidity Meter	Zhicheng	ZC1-2	AC6-TH	2012.01.14

4.2. Test Setup

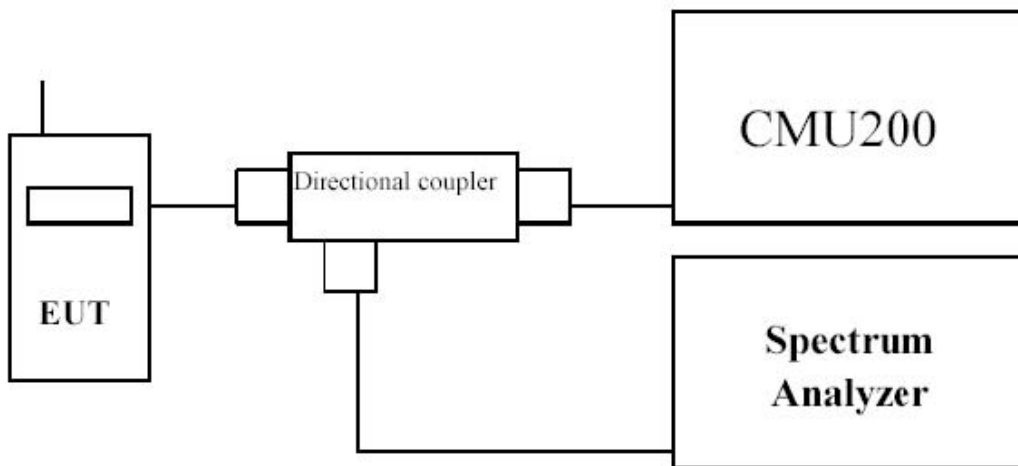

4.3. Limit

N/A

4.4. Test Procedure

Using Occupied Bandwidth measurement function of spectrum analyzer, and setting as follows:

For GPRS/EDGE 850/1900 test --- RBW = 3 kHz and VBW = 10 kHz

For WCDMA/HSDPA FDD Band II/V test --- RBW = 50 kHz and VBW = 200 kHz

4.5. Uncertainty

The measurement uncertainty is defined as ± 10 Hz

4.6. Test Result

Product	Module		
Test Item	Occupied Bandwidth		
Test Mode	Mode 1: GSM850 GPRS Link		
Date of Test	2011/02/20	Test Site	AC-6

Channel No.	Frequency (MHz)	-26dB Occupied Bandwidth (kHz)	99% Occupied Bandwidth (kHz)
128	824.20	317.51	245.44
189	836.40	313.00	244.13
251	848.80	321.26	245.73

Figure Channel 128 (824.20MHz)

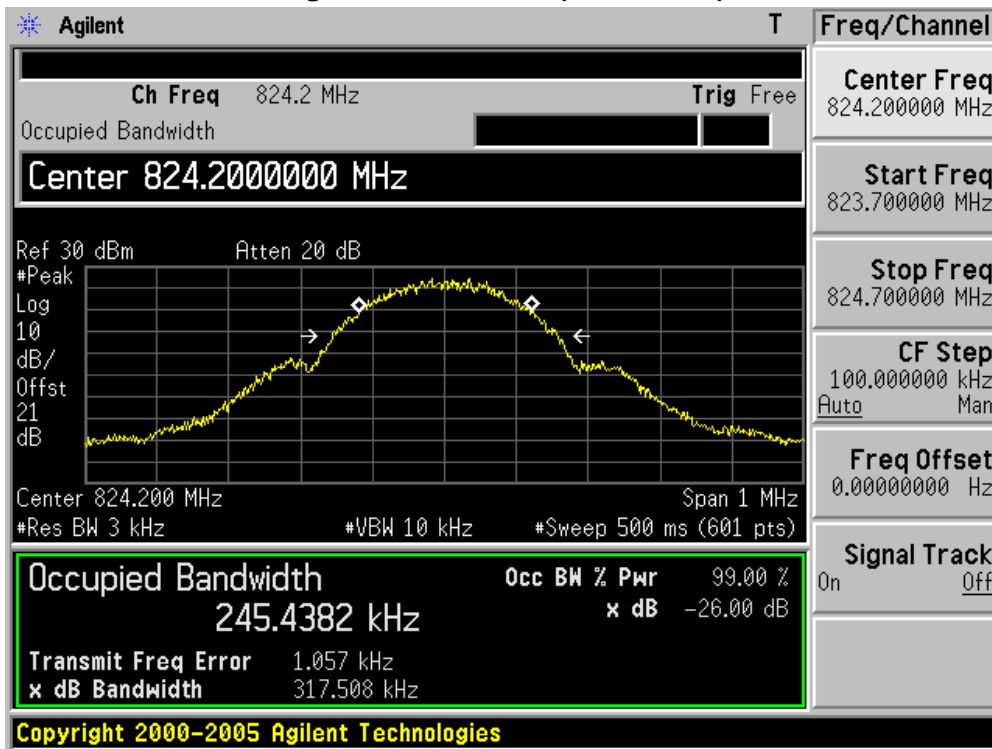

Figure Channel 189 (836.40MHz)

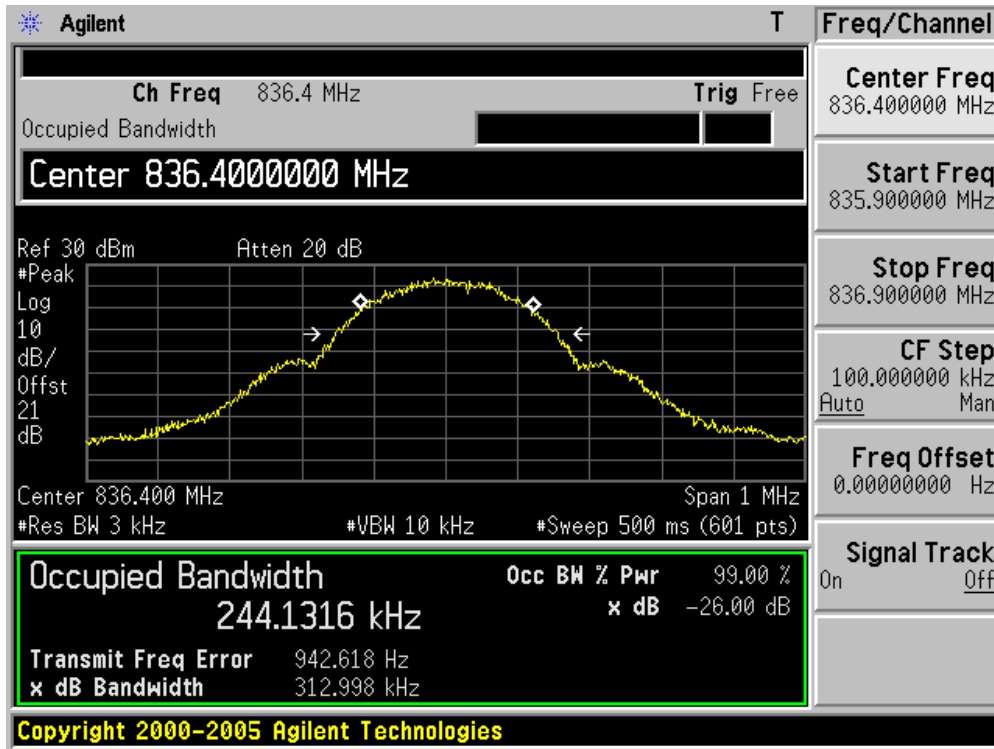
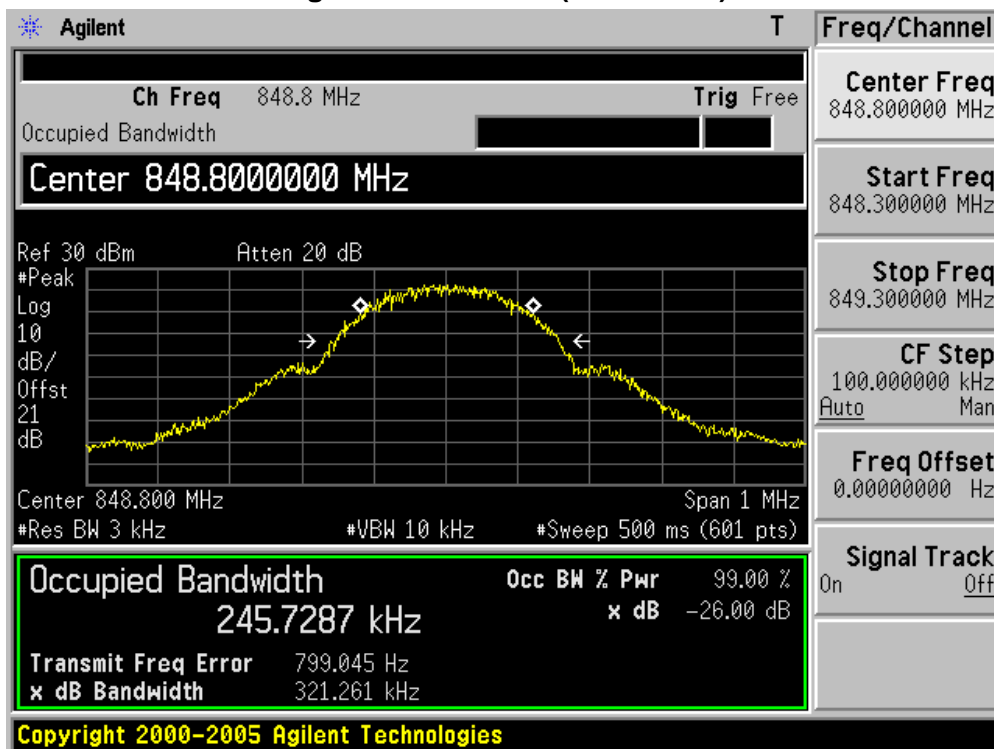

Figure Channel 251 (848.80MHz)



Product	Module		
Test Item	Occupied Bandwidth		
Test Mode	Mode 2: PCS1900 GPRS Link		
Date of Test	2011/02/20	Test Site	AC-6

Channel No.	Frequency (MHz)	-26dB Occupied Bandwidth (kHz)	99% Occupied Bandwidth (kHz)
512	1850.20	313.20	239.49
661	1880.00	313.74	243.99
810	1909.80	310.29	243.35

Figure Channel 512 (1850.20MHz)



Figure Channel 661 (1880.00MHz)

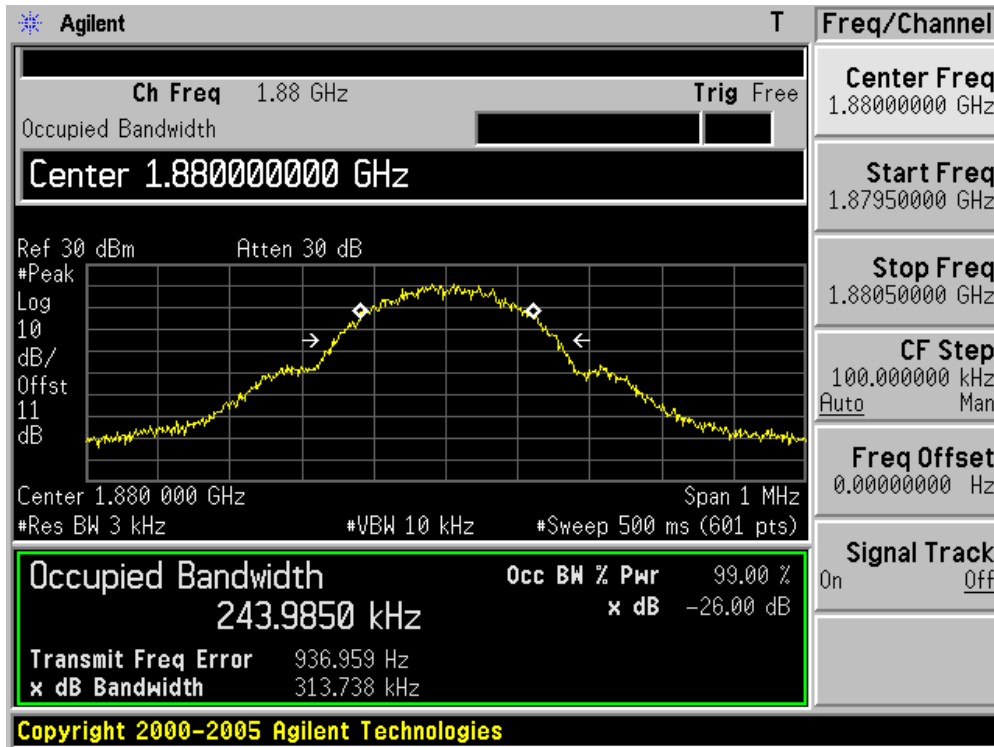

Figure Channel 810 (1909.80MHz)



Product	Module		
Test Item	Occupied Bandwidth		
Test Mode	Mode 3: GSM850 EDGE Link		
Date of Test	2011/02/20	Test Site	AC-6

Channel No.	Frequency (MHz)	-26dB Occupied Bandwidth (kHz)	99% Occupied Bandwidth (kHz)
128	824.20	313.78	237.15
189	836.40	304.32	246.16
251	848.80	296.71	239.66

Figure Channel 128 (824.20MHz)

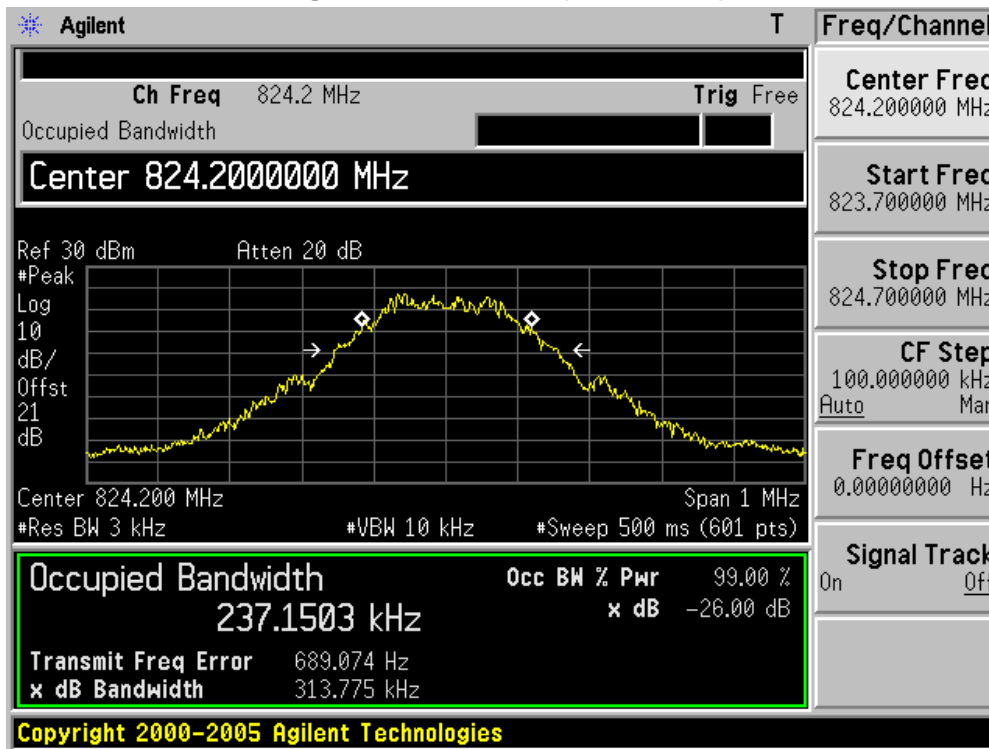

Figure Channel 189 (836.40MHz)

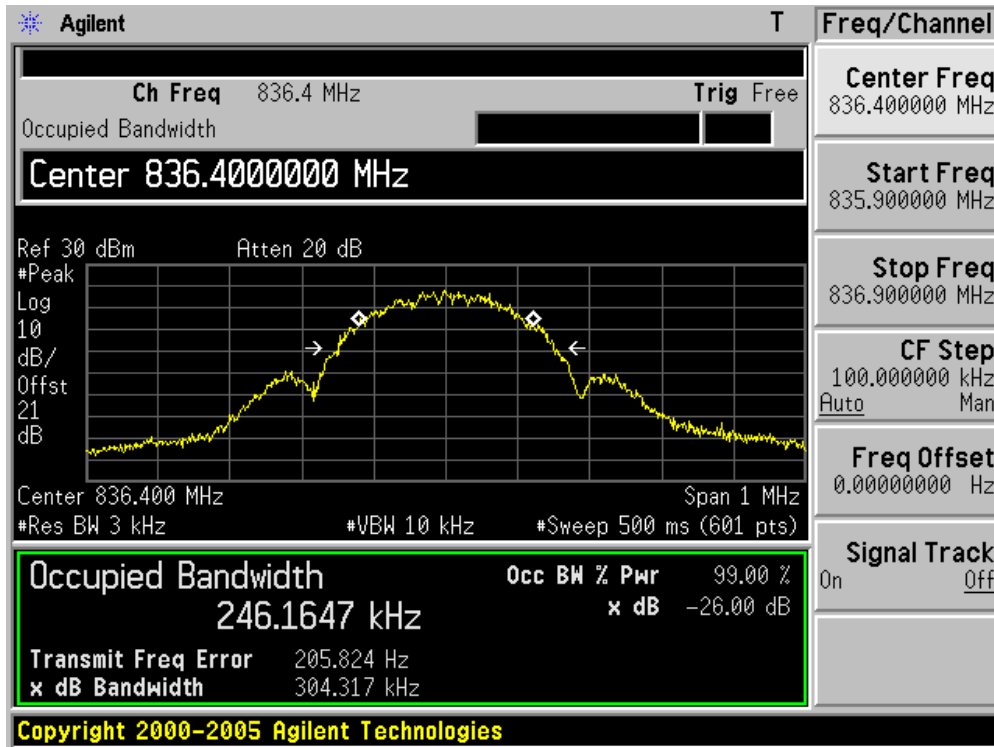
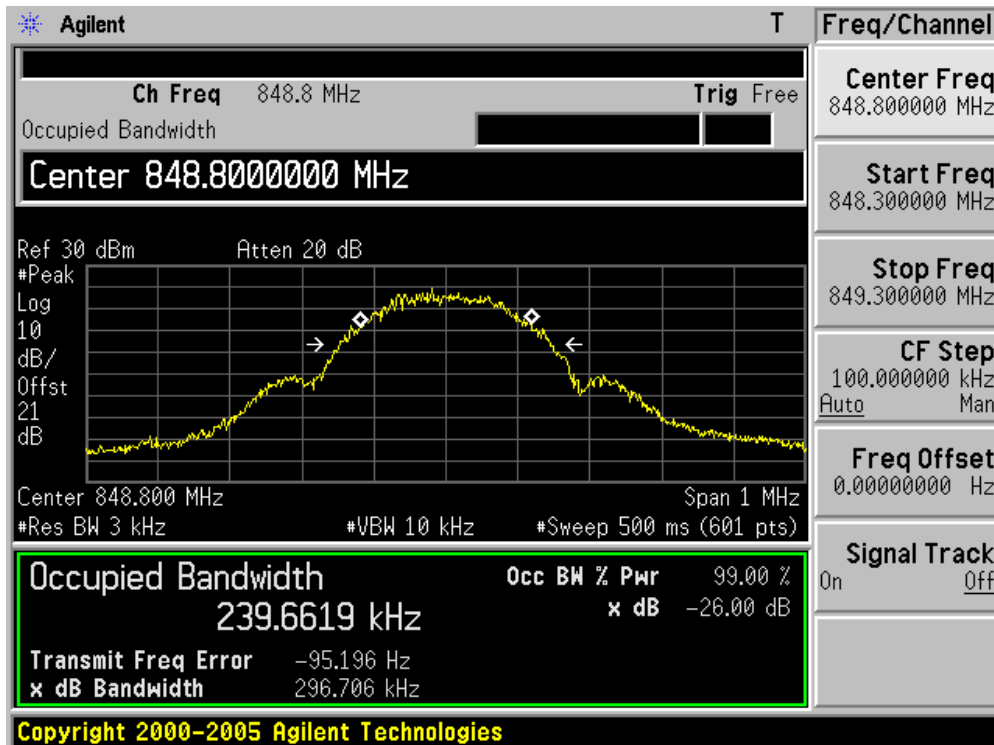

Figure Channel 251 (848.80MHz)



Product	Module		
Test Item	Occupied Bandwidth		
Test Mode	Mode 4: PCS1900 EDGE Link		
Date of Test	2011/02/20	Test Site	AC-6

Channel No.	Frequency (MHz)	-26dB Occupied Bandwidth (kHz)	99% Occupied Bandwidth (kHz)
512	1850.20	298.97	246.73
661	1880.00	308.01	245.10
810	1909.80	313.65	244.21

Figure Channel 512 (1850.20MHz)

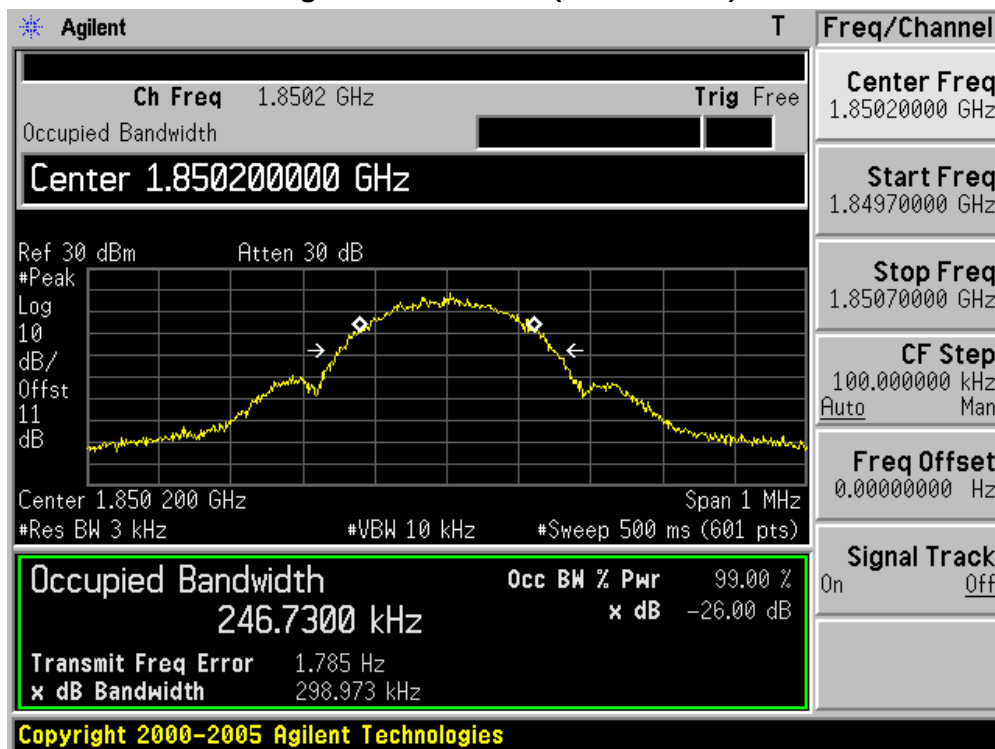

Figure Channel 661 (1880.00MHz)

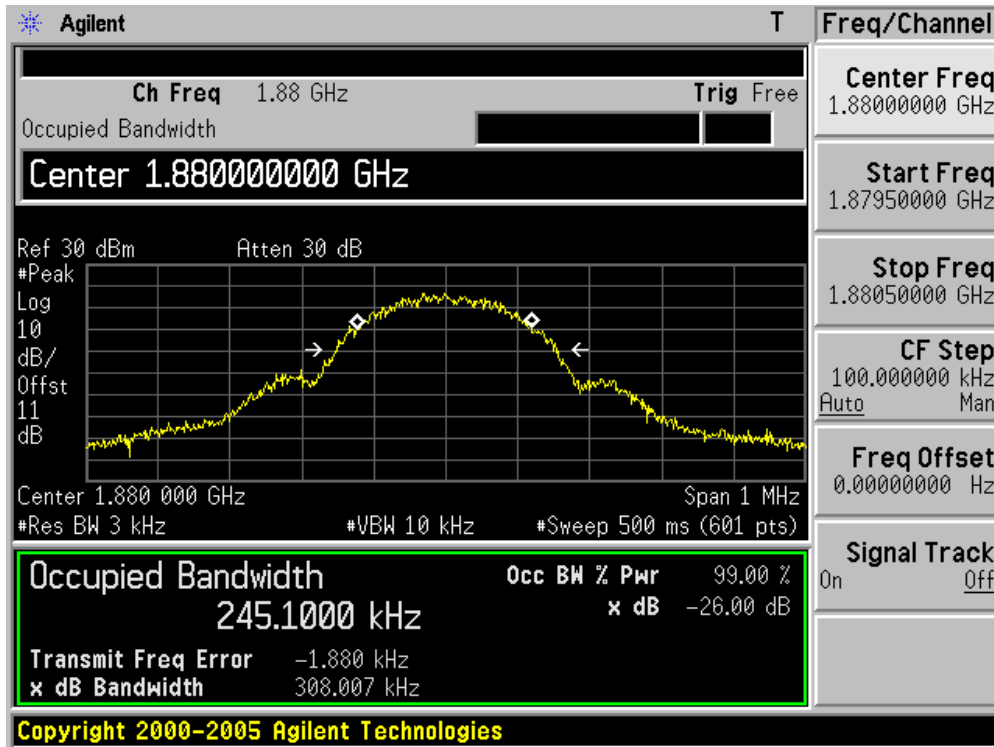
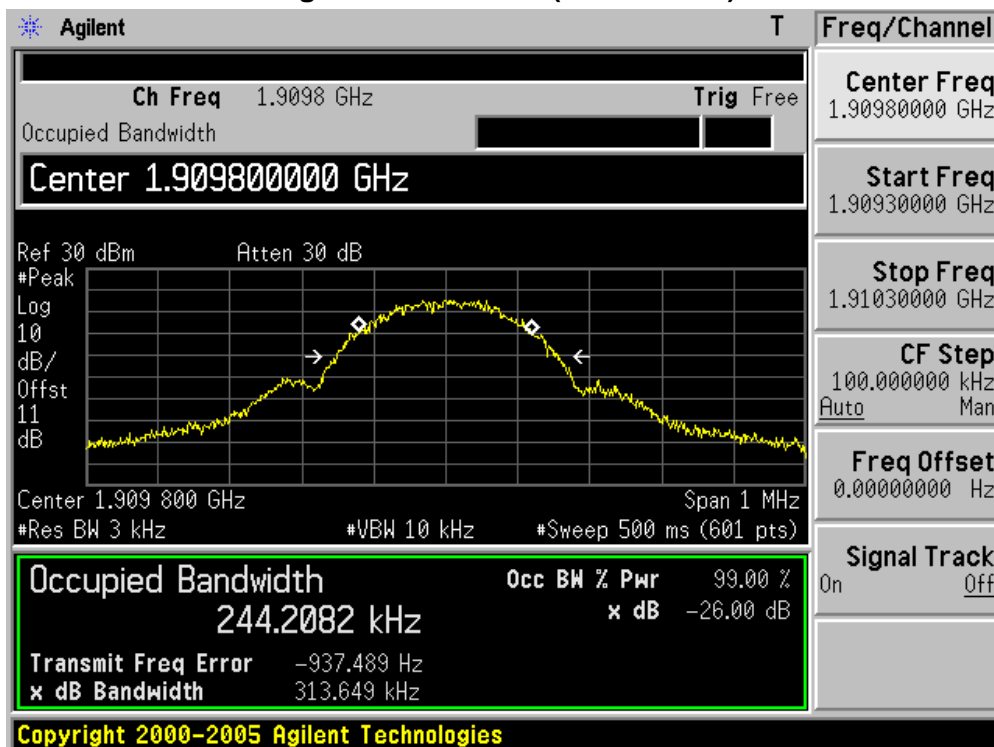

Figure Channel 810 (1909.80MHz)



Product	Module		
Test Item	Occupied Bandwidth		
Test Mode	Mode 5: WCDMA Band II Link		
Date of Test	2011/02/20	Test Site	AC-6

Channel No.	Frequency (MHz)	-26dB Occupied Bandwidth (MHz)	99% Occupied Bandwidth (MHz)
9262	1852.4	4.646	4.1697
9400	1880.0	4.636	4.1631
9538	1907.6	4.638	4.1612

Figure Channel 9262 (1852.4MHz)

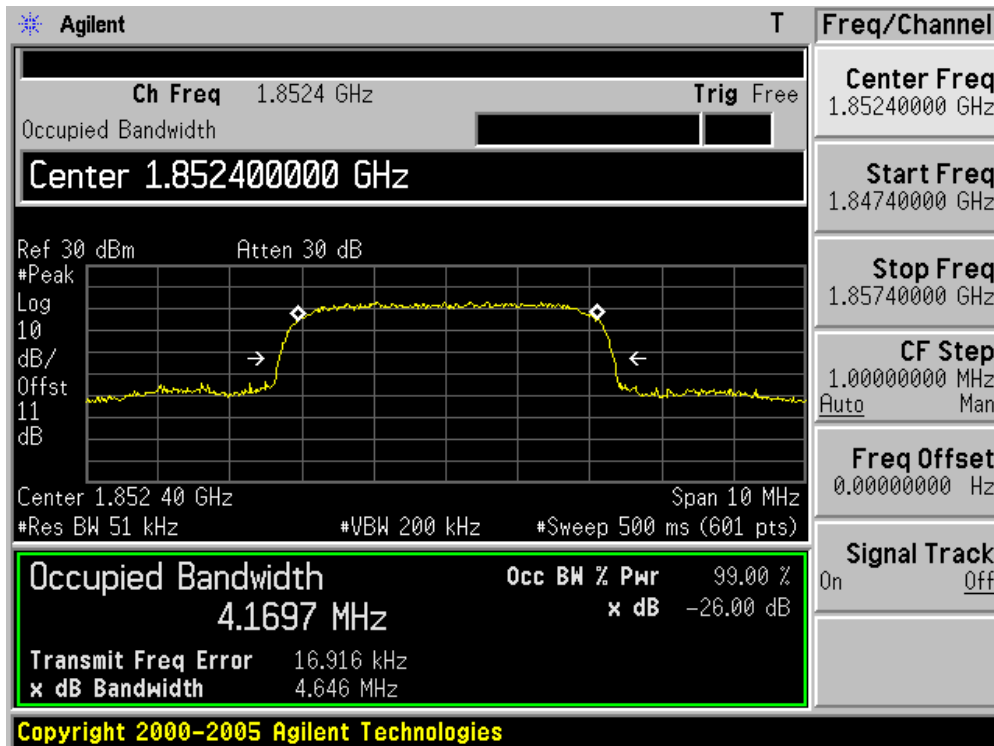

Figure Channel 9400 (1880.0MHz)

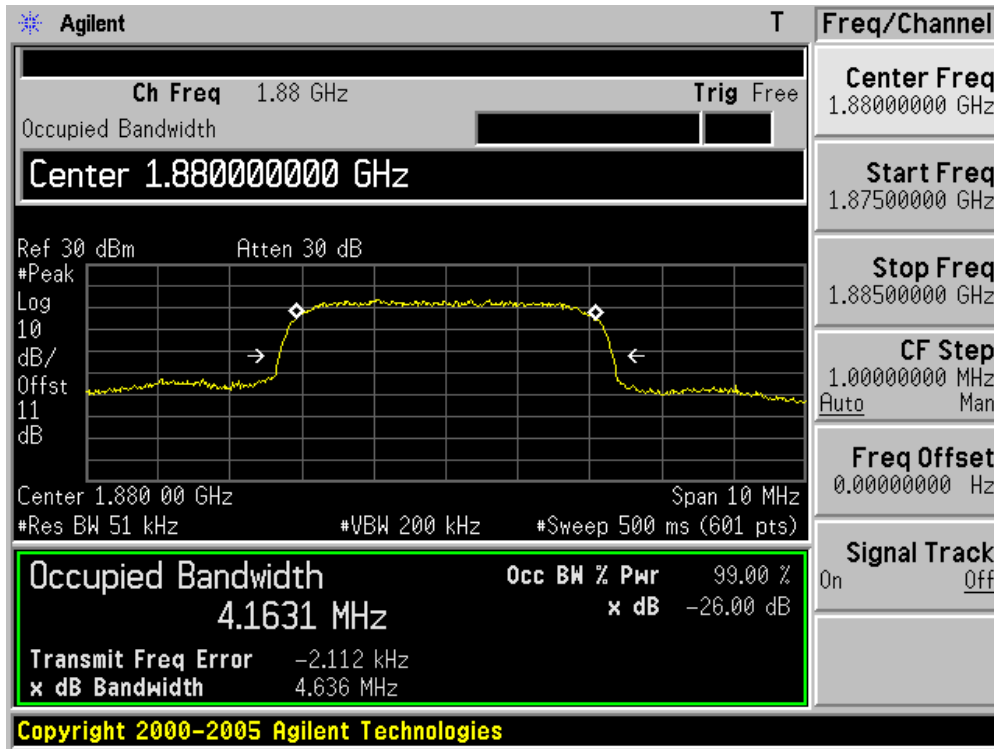
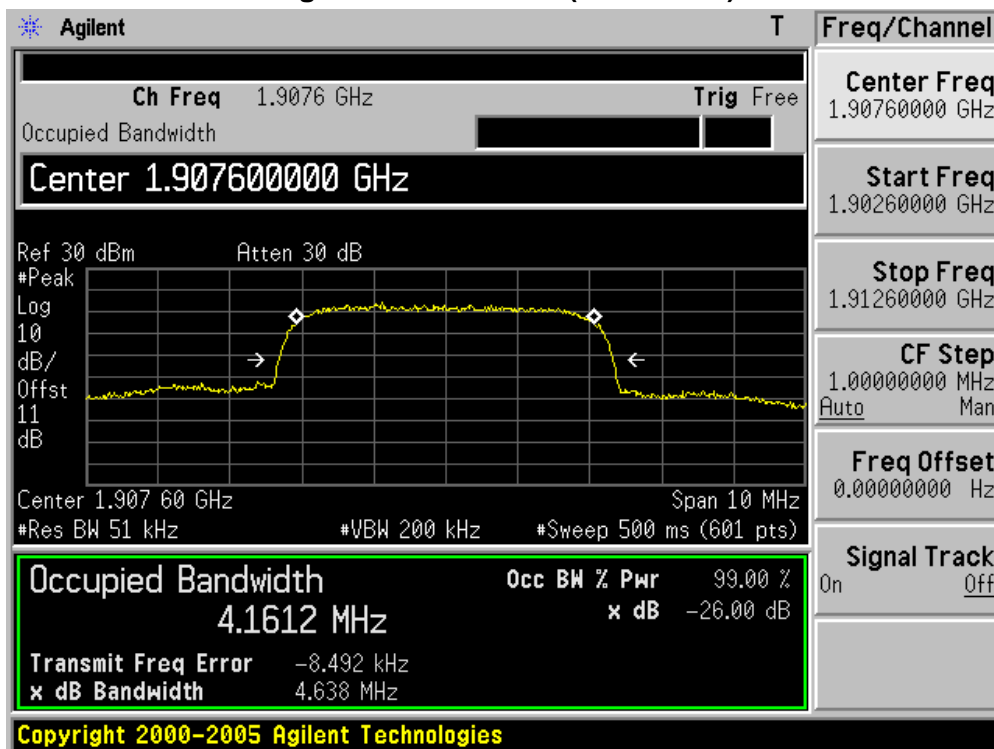

Figure Channel 9538 (1907.6MHz)



Product	Module		
Test Item	Occupied Bandwidth		
Test Mode	Mode 6: WCDMA Band V Link		
Date of Test	2011/02/20	Test Site	AC-6

Channel No.	Frequency (MHz)	-26dB Occupied Bandwidth (MHz)	99% Occupied Bandwidth (MHz)
4132	826.4	4.634	4.1615
4182	836.4	4.645	4.1640
4233	846.6	4.634	4.1499

Figure Channel 4132 (826.4MHz)

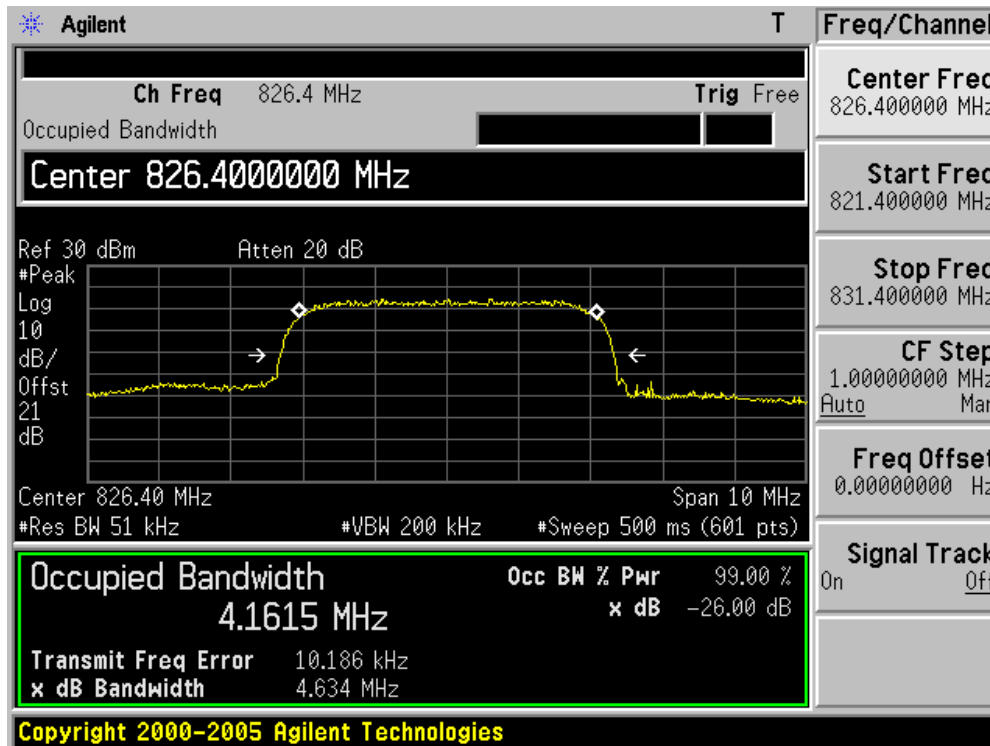

Figure Channel 4182 (836.40MHz)

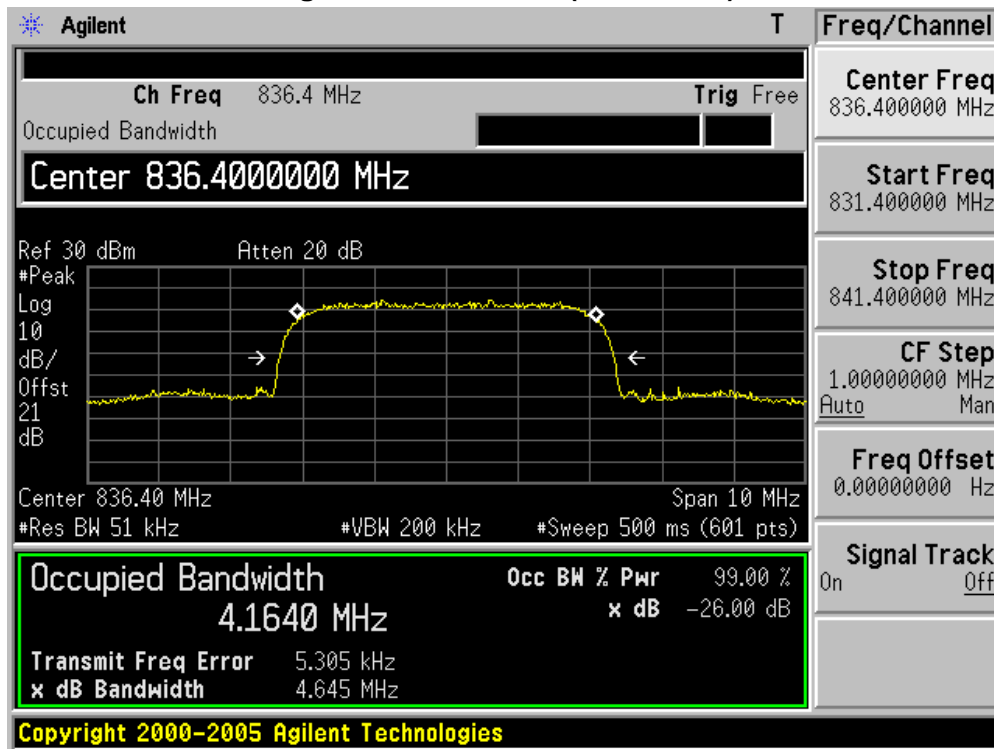
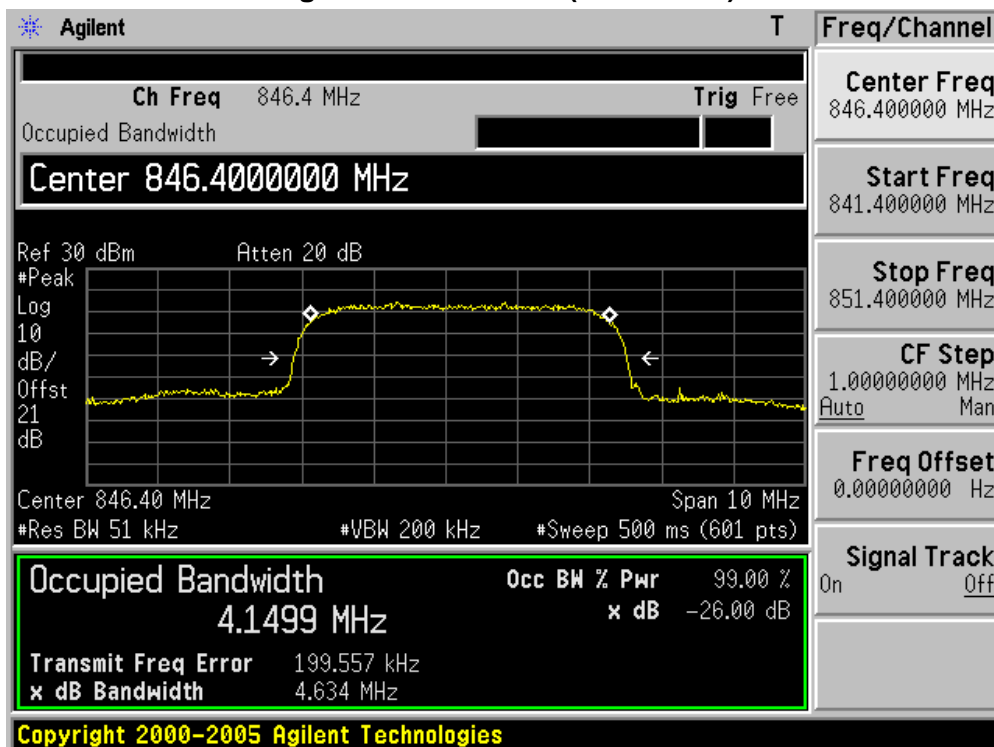

Figure Channel 4233 (846.60MHz)



Product	Module		
Test Item	Occupied Bandwidth		
Test Mode	Mode 7: HSDPA Band II Link		
Date of Test	2011/02/20	Test Site	AC-6

Channel No.	Frequency (MHz)	-26dB Occupied Bandwidth (MHz)	99% Occupied Bandwidth (MHz)
9262	1852.4	4.640	4.1655
9400	1880.0	4.638	4.1669
9538	1907.6	4.652	4.1699

Figure Channel 9262 (1852.4MHz)

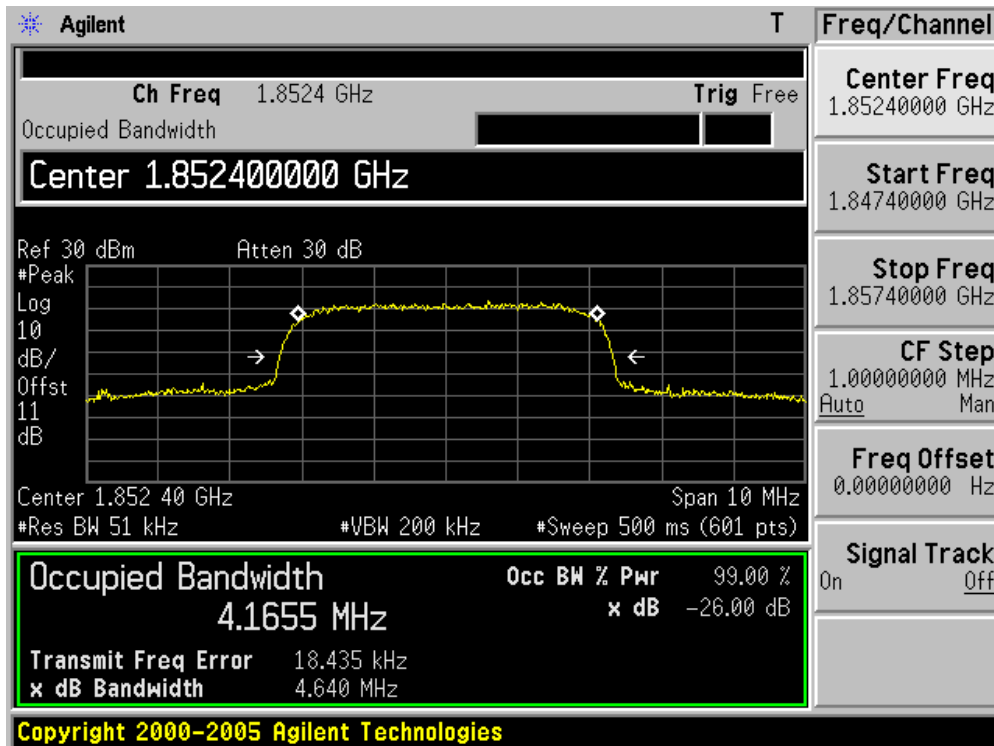

Figure Channel 9400 (1880MHz)

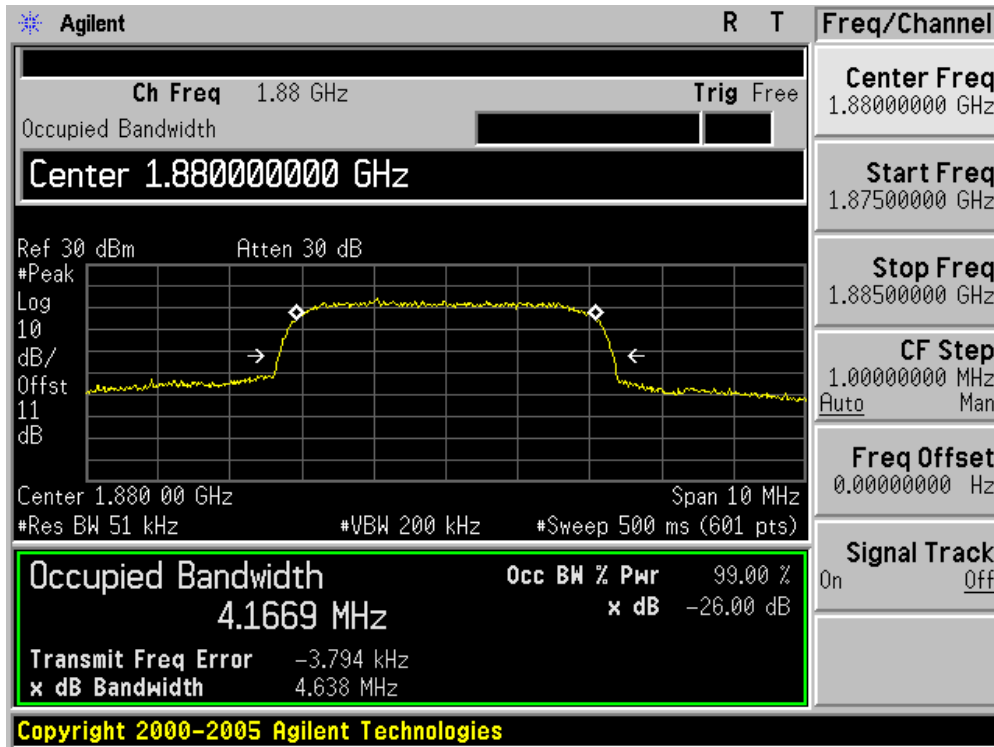
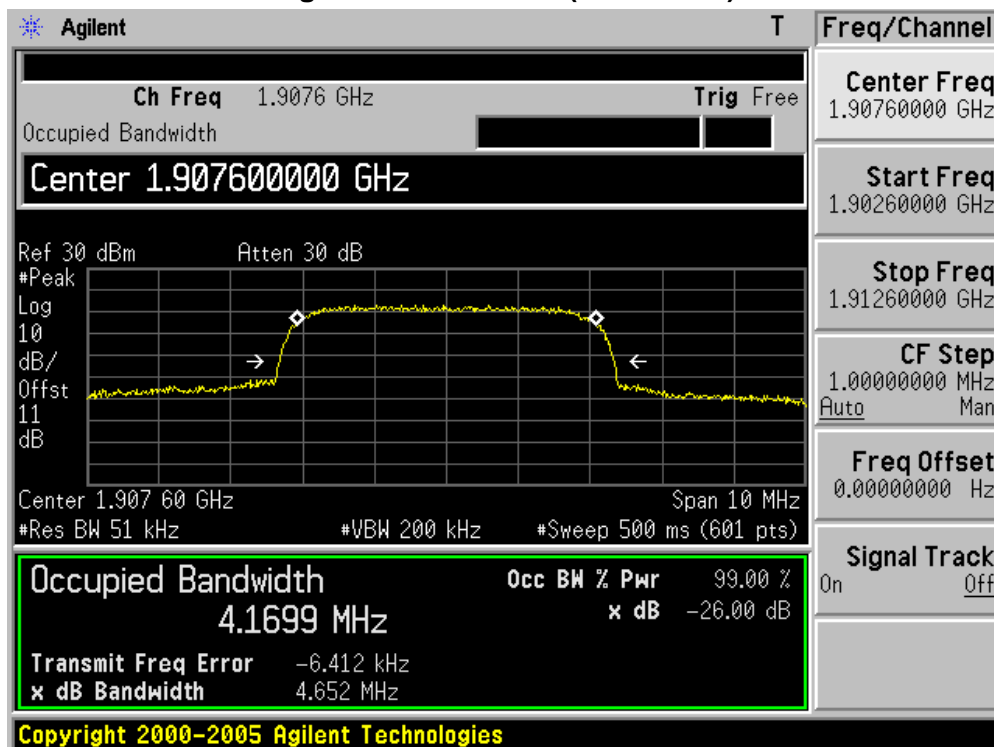

Figure Channel 9538 (1907.6MHz)



Product	Module		
Test Item	Occupied Bandwidth		
Test Mode	Mode 8: HSDPA Band V Link		
Date of Test	2011/02/20	Test Site	AC-6

Channel No.	Frequency (MHz)	-26dB Occupied Bandwidth (MHz)	99% Occupied Bandwidth (MHz)
4132	826.4	4.641	4.1612
4182	836.4	4.640	4.1663
4233	846.6	4.626	4.1657

Figure Channel 4132 (826.4MHz)

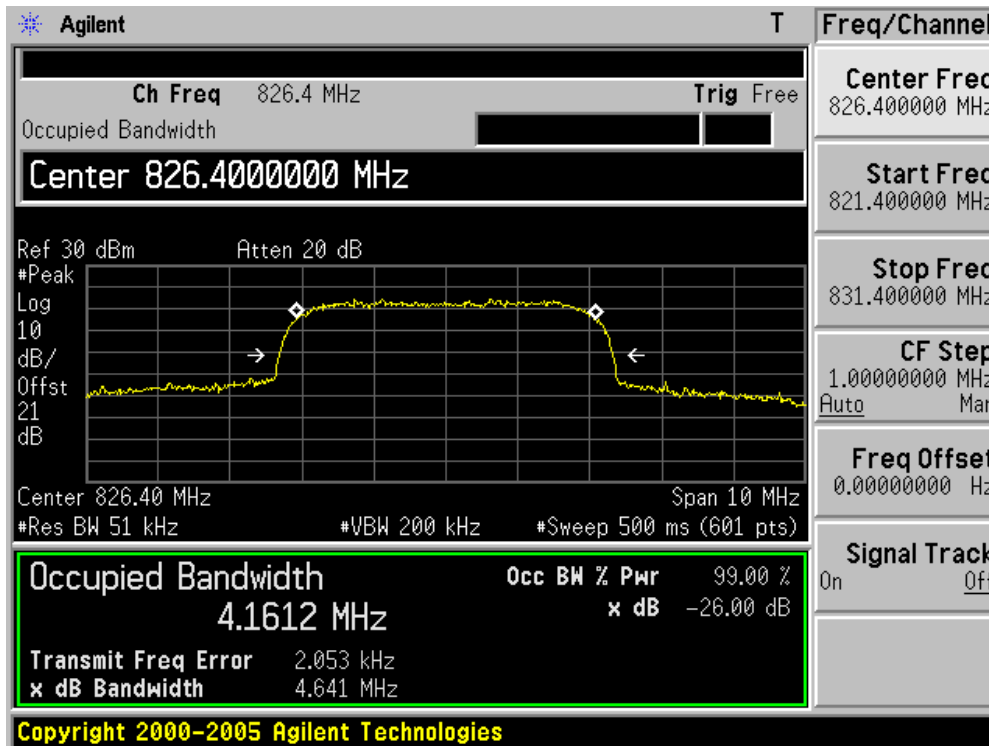

Figure Channel 4182 (836.40MHz)

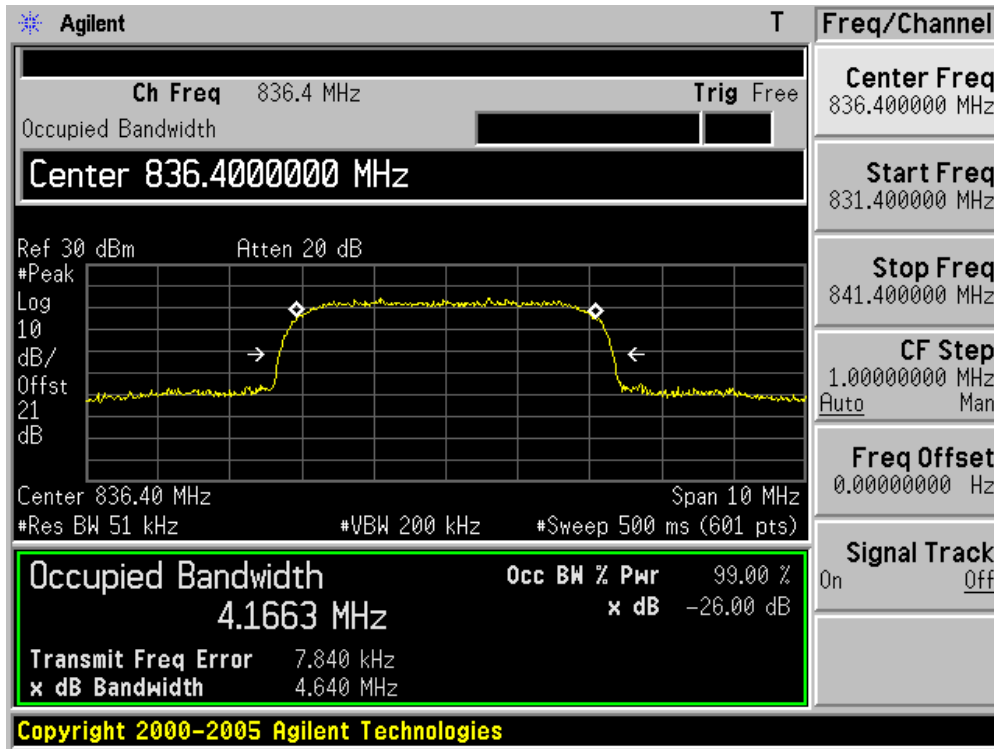
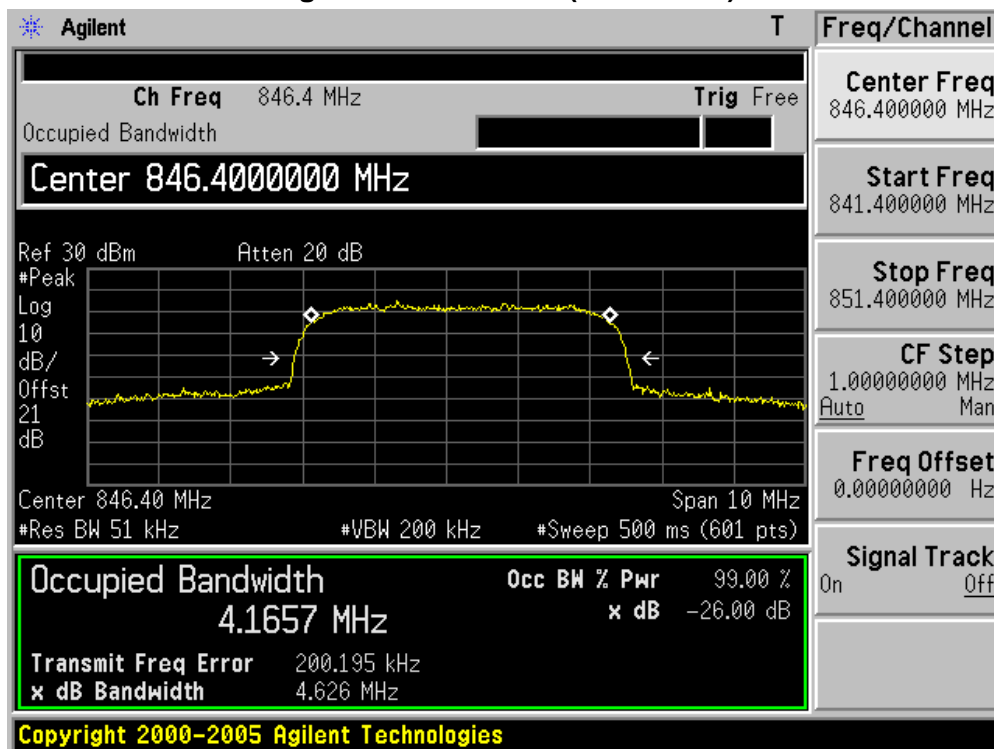

Figure Channel 4233 (846.60MHz)



5. Spurious Emission At Antenna Terminals (+/- 1MHz)

5.1. Test Equipment

Spurious Emission At Antenna Terminals (+/- 1MHz) / AC-6

Instrument	Manufacturer	Type No.	Serial No	Cali. Due Date
PSA Series Spectrum Analyzer	Agilent	E4440A	MY49420184	2011.04.10
Radio Communication Tester	R&S	CMU 200	117088	2011.07.12
Dual Directional Coupler	Agilent	778D	20160	2011.04.20
10dB Coaxial Coupler	Agilent	87300C	MY44300299	2011.04.20
Temperature/Humidity Meter	Zhicheng	ZC1-2	AC6-TH	2012.01.14

5.2. Test Setup

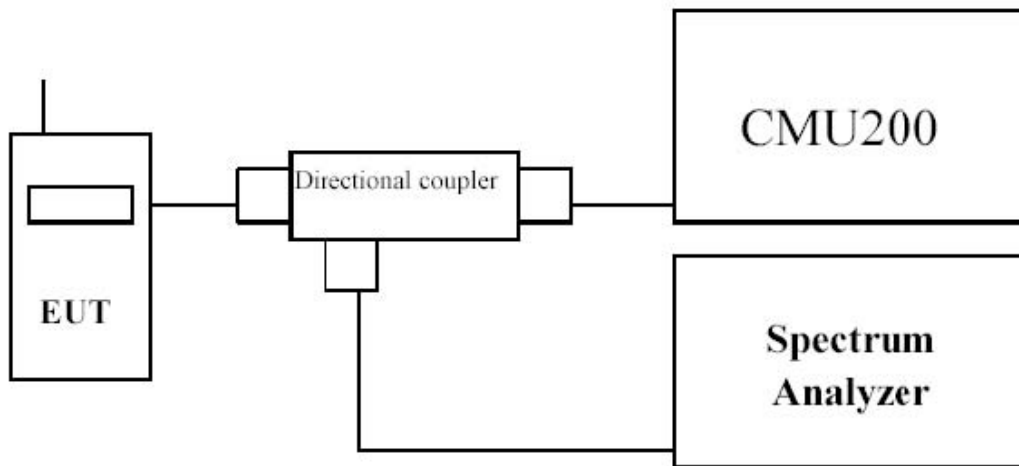

5.3. Limit

The power of any emission outside of the authorized operating frequency ranges must be attenuated below the transmitting power (P) by a factor of at least $43 + 10\log(P)$ dB.

5.4. Test Procedure

In the 1MHz bands immediately outside and adjacent to the frequency block a resolution bandwidth of at least one percent of the emission bandwidth of the fundamental emission of the transmitter may be employed to measure the out of band Emissions.

5.5. Uncertainty

The measurement uncertainty is defined as ± 1.2 dB.

5.6. Test Result

Product	Module		
Test Item	Spurious Emission At Antenna Terminals (+/- 1MHz)		
Test Mode	Mode 1: GSM850 GPRS Link		
Date of Test	2011/02/20	Test Site	AC-6

Figure Channel 128 (824.20MHz)

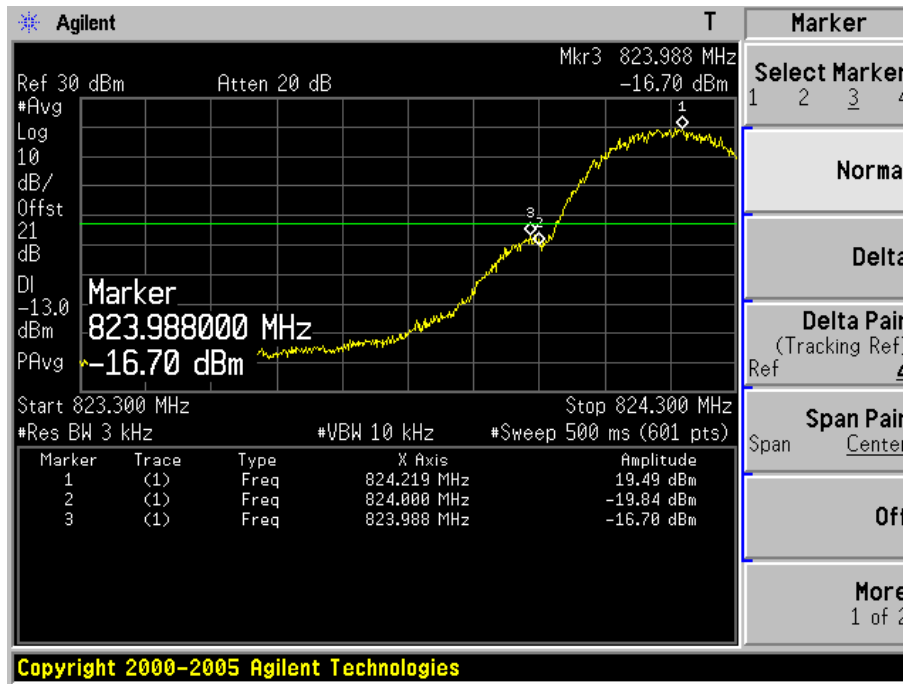
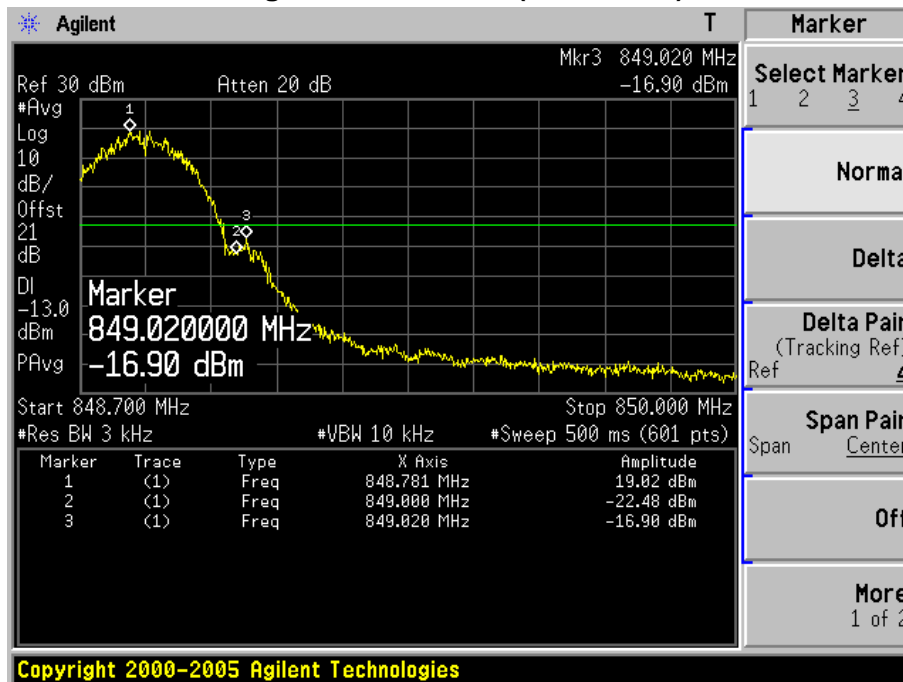

Figure Channel 251 (848.80MHz)



Product	Module		
Test Item	Spurious Emission At Antenna Terminals (+/- 1MHz)		
Test Mode	Mode 2: PCS1900 GPRS Link		
Date of Test	2011/02/20	Test Site	AC-6

Figure Channel 512 (1850.20MHz)

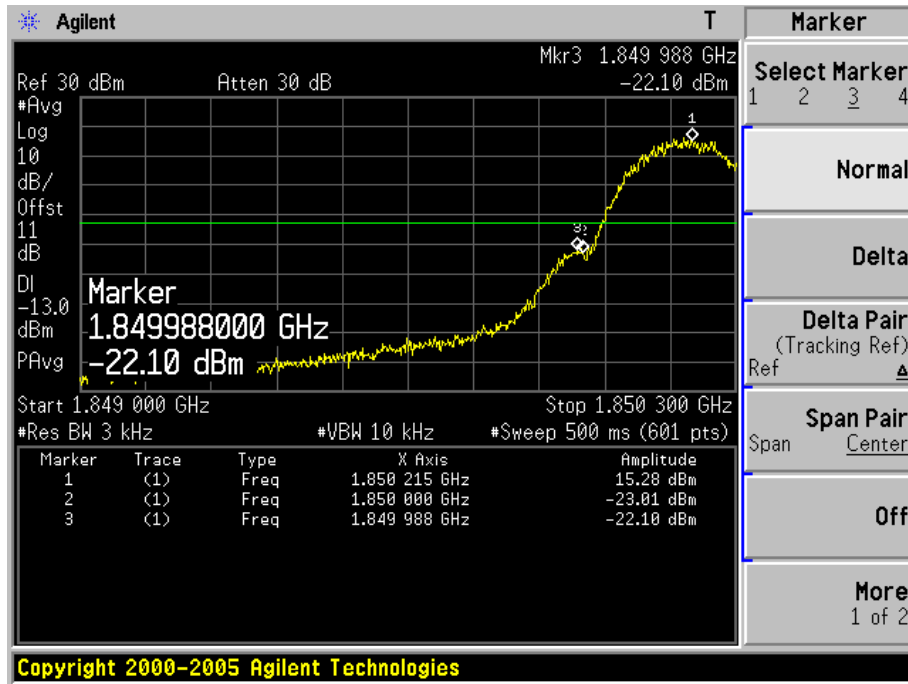
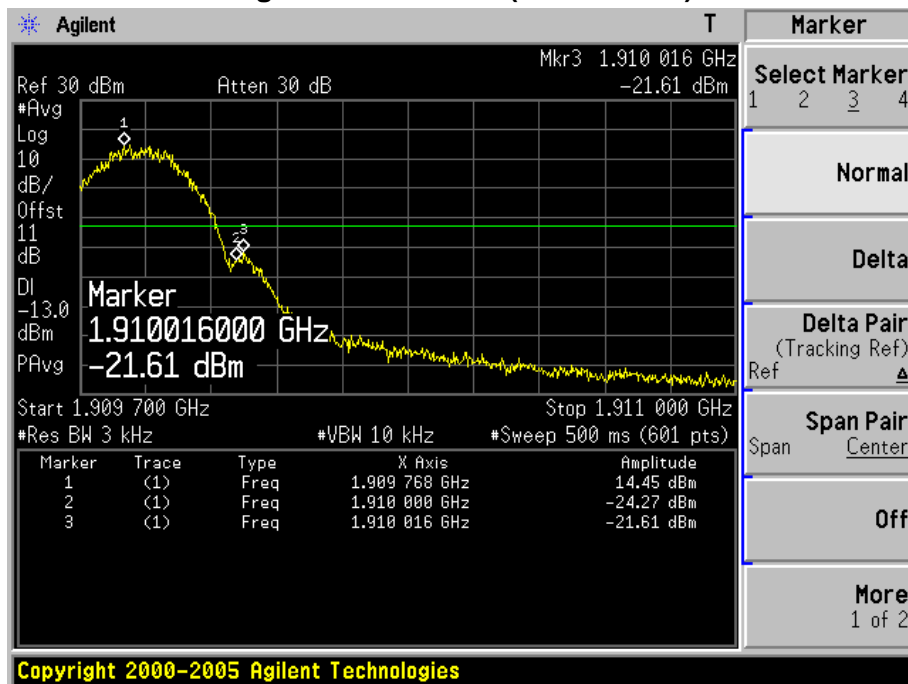

Figure Channel 810 (1909.80MHz)



Product	Module		
Test Item	Spurious Emission At Antenna Terminals (+/- 1MHz)		
Test Mode	Mode 3: GSM850 EDGE Link		
Date of Test	2011/02/20	Test Site	AC-6

Figure Channel 128 (824.20MHz)

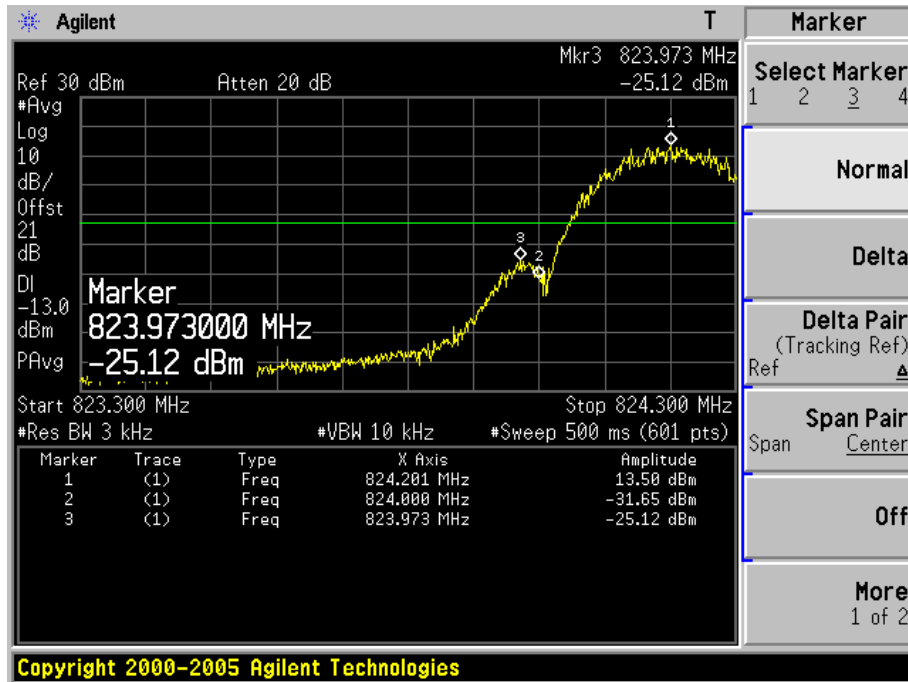
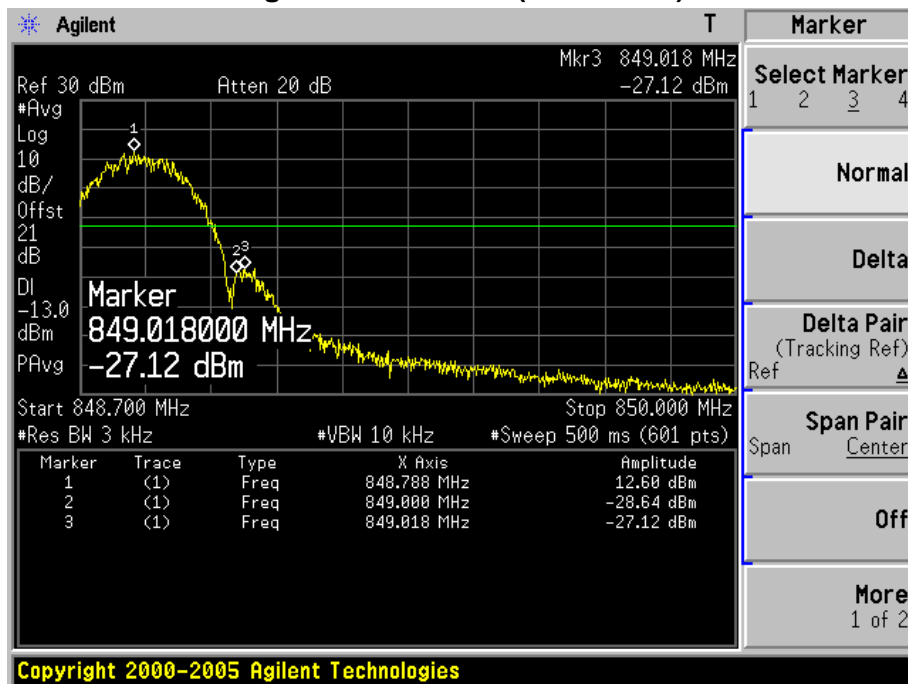

Figure Channel 251 (848.80MHz)



Product	Module		
Test Item	Spurious Emission At Antenna Terminals (+/- 1MHz)		
Test Mode	Mode 4: PCS1900 EDGE Link		
Date of Test	2011/02/20	Test Site	AC-6

Figure Channel 512 (1850.20MHz)

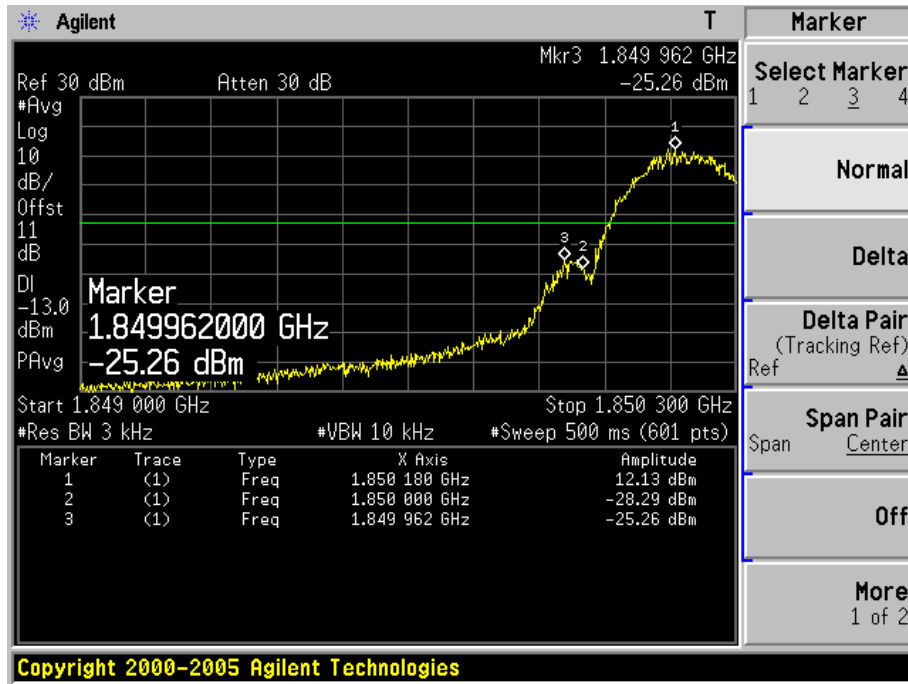
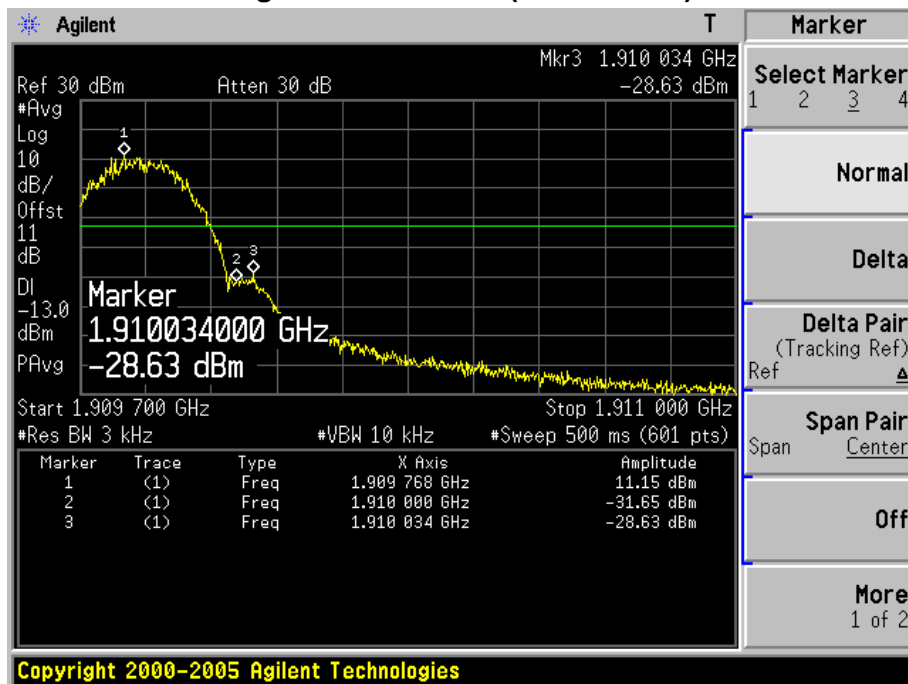

Figure Channel 810 (1909.80MHz)



Product	Module		
Test Item	Spurious Emission At Antenna Terminals (+/- 1MHz)		
Test Mode	Mode 5: WCDMA Band II Link		
Date of Test	2011/02/20	Test Site	AC-6

Figure Channel 9262 (1852.4MHz)

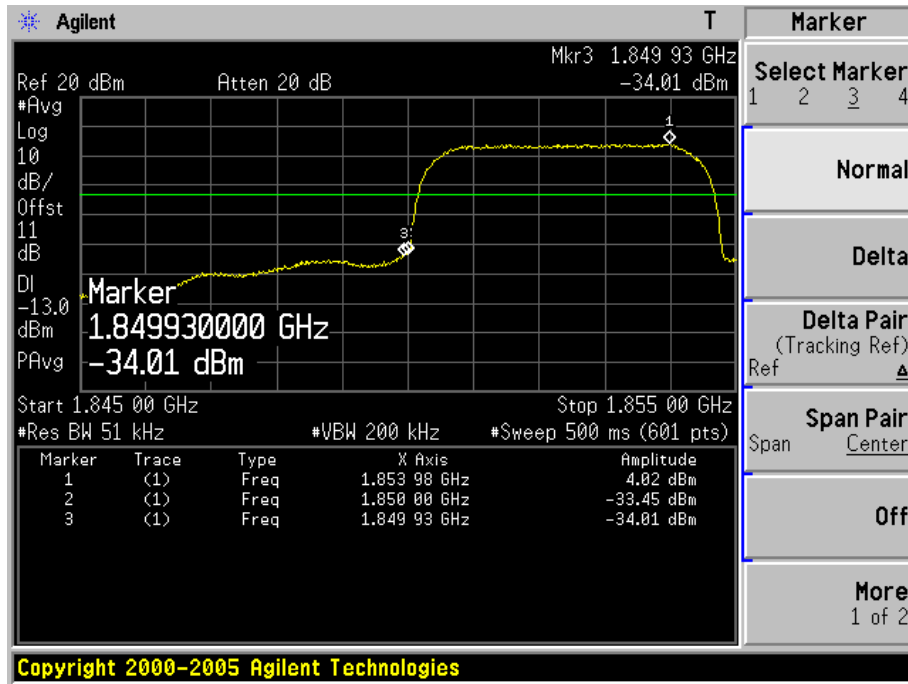
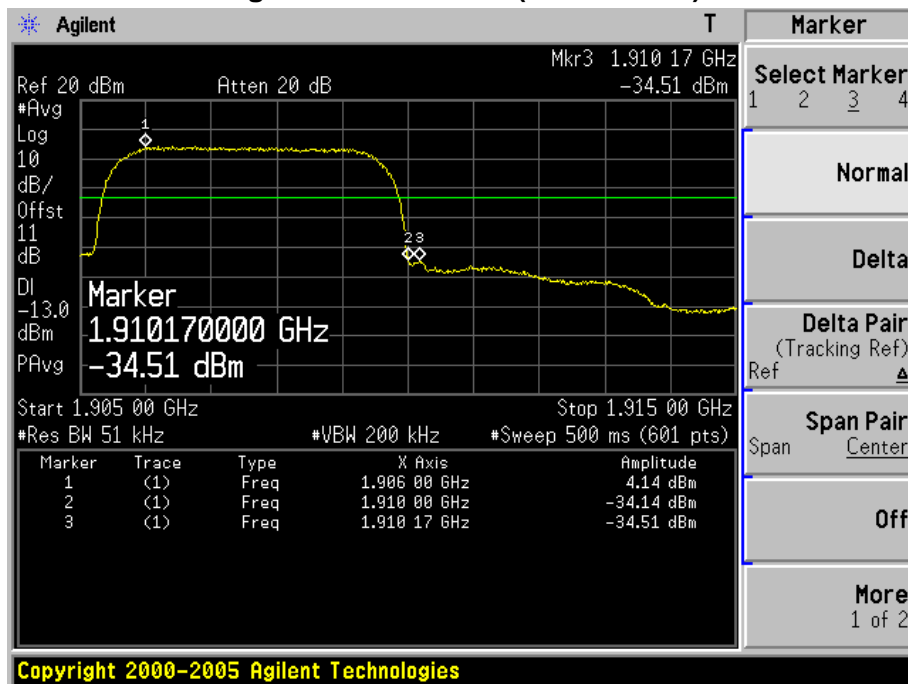

Figure Channel 9538 (1907.60MHz)



Product	Module		
Test Item	Spurious Emission At Antenna Terminals (+/- 1MHz)		
Test Mode	Mode 6: WCDMA Band V Link		
Date of Test	2011/02/20	Test Site	AC-6

Figure Channel 4132 (826.4MHz)

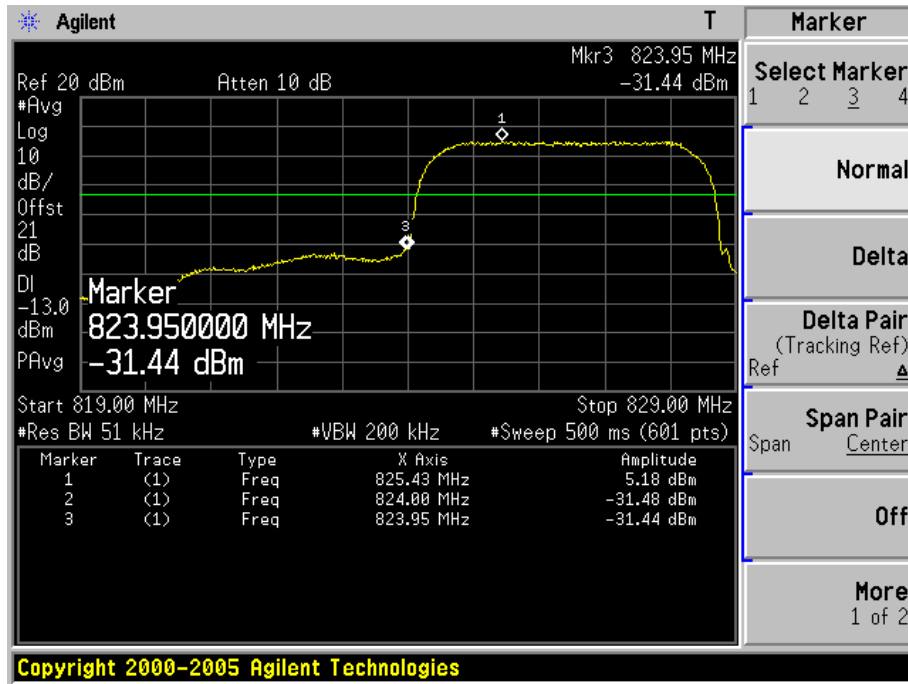
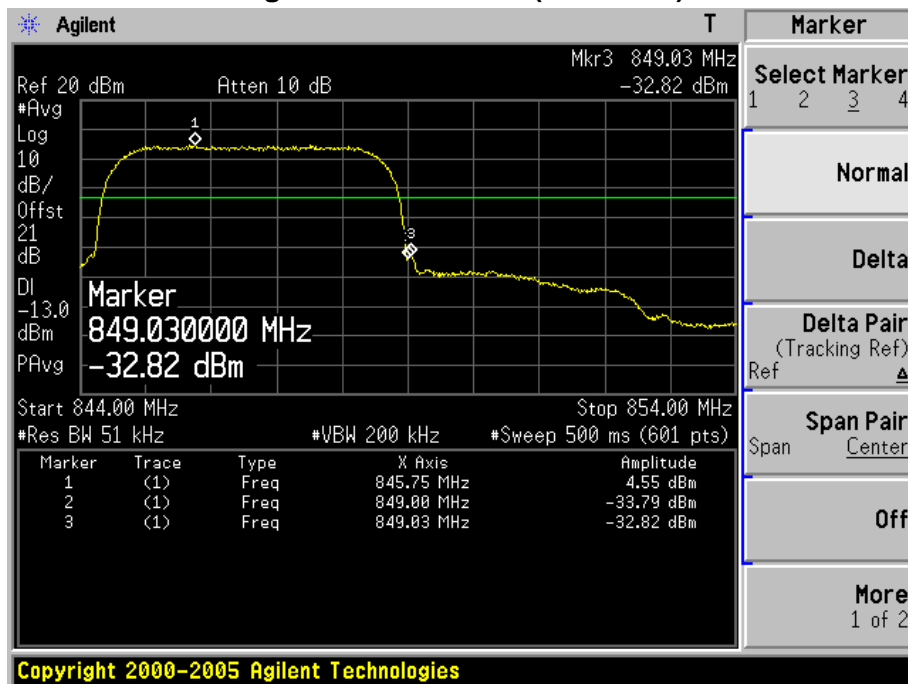

Figure Channel 4233 (846.6MHz)



Product	Module		
Test Item	Spurious Emission At Antenna Terminals (+/- 1MHz)		
Test Mode	Mode 7: HSDPA Band II Link		
Date of Test	2011/02/20	Test Site	AC-6

Figure Channel 9262 (1852.4MHz)

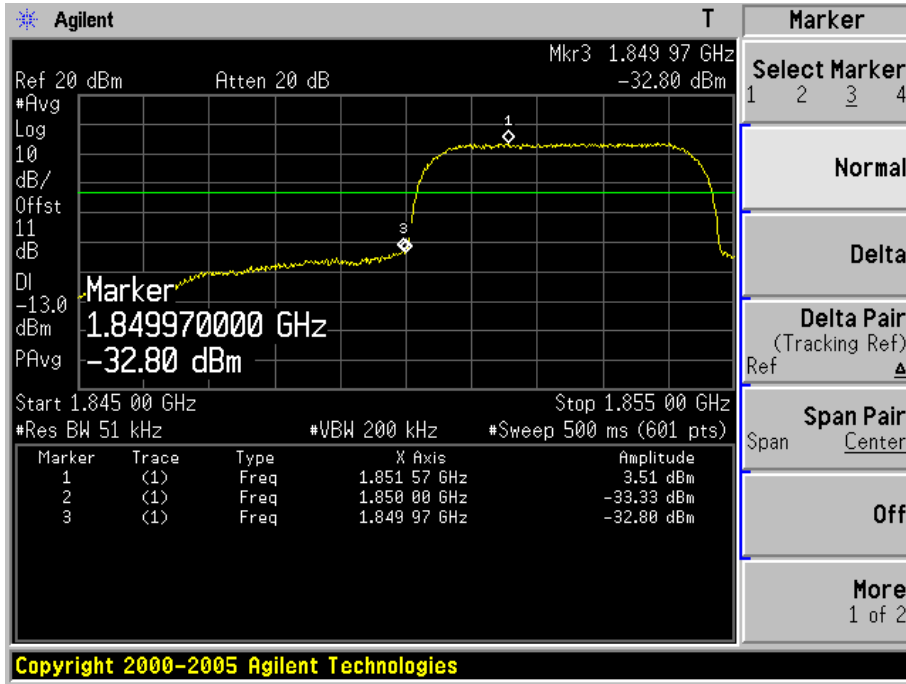
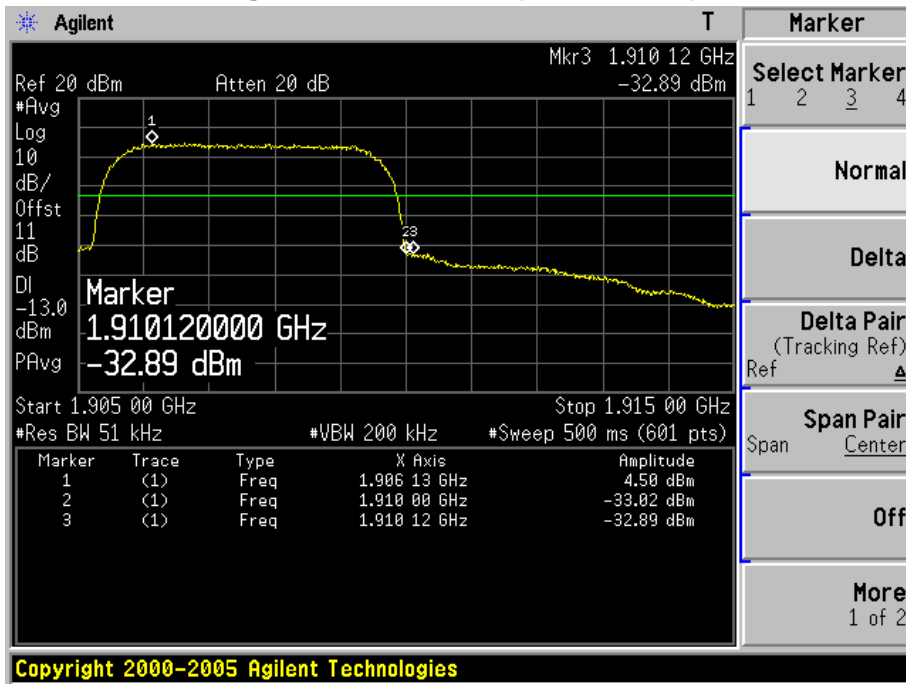

Figure Channel 9538 (1907.60MHz)



Product	Module		
Test Item	Spurious Emission At Antenna Terminals (+/- 1MHz)		
Test Mode	Mode 8: HSDPA Band V Link		
Date of Test	2011/02/20	Test Site	AC-6

Figure Channel 4132 (826.4MHz)

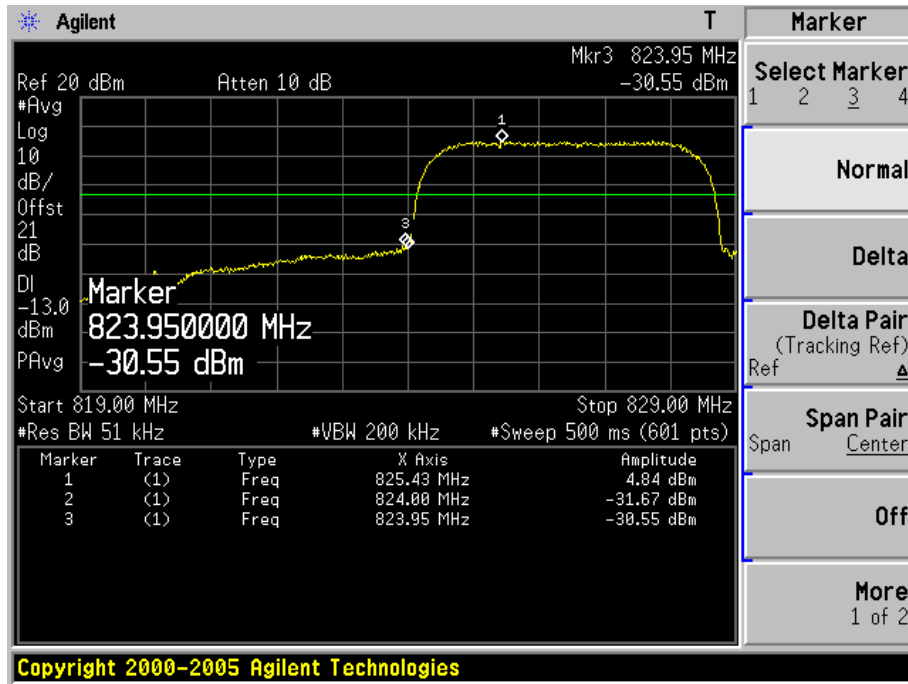
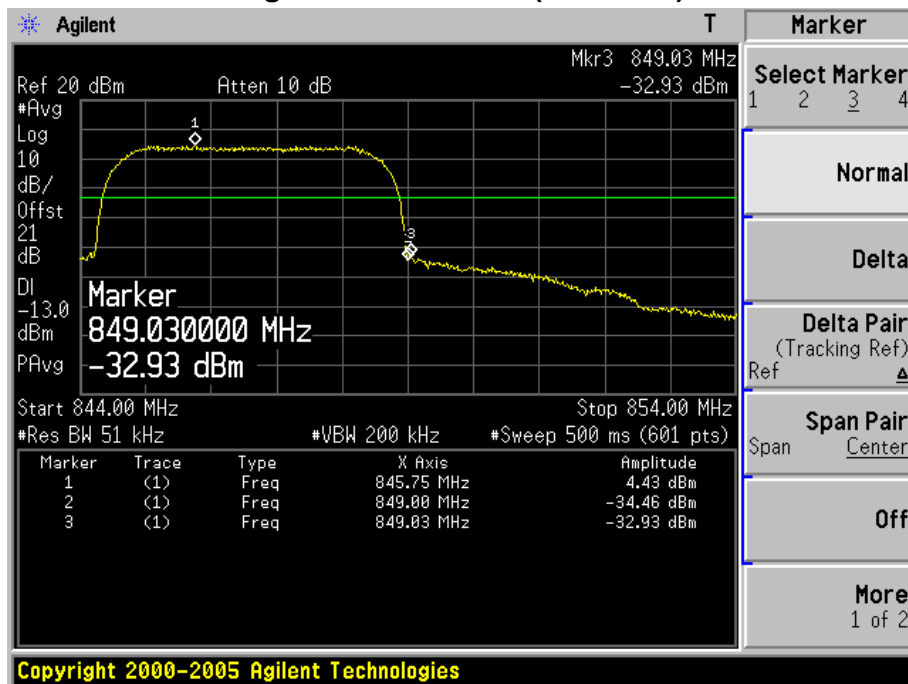

Figure Channel 4233 (846.6MHz)



6. Spurious Emission

6.1. Test Equipment

Spurious Emission / AC-5

Instrument	Manufacturer	Type No.	Serial No	Cali. Due Date
PSA Series Spectrum Analyzer	Agilent	E4440A	MY49420184	2011.04.10
Radio Communication Tester	R&S	CMU 200	117088	2011.07.12
Dual Directional Coupler	Agilent	778D	20160	2011.04.20
10dB Coaxial Coupler	Agilent	87300C	MY44300299	2011.04.20
PSG Analog Signal Generator	Agilent	E8257D	MY44321116	2011.04.23
Preamplifier	QuieTek	AP-025C	CHM-0503006	2011.05.05
Preamplifier	Miteq	NSP1800-25	1364185	2011.05.05
Bilog Antenna	Teseq GmbH	CBL6112D	27612	2011.10.18
Half Wave Tuned Dipole Antenna	COM-POWER	AD-100	40137	2011.11.24
Broad-Band Horn Antenna	Schwarzbeck	BBHA9120D	737	2011.11.24
Broad-Band Horn Antenna	Schwarzbeck	BBHA9120D	499	2011.06.11
Temperature/Humidity Meter	Zhicheng	ZC1-2	AC5-TH	2012.01.14

6.2. Test Setup

Conducted Spurious Measurement:

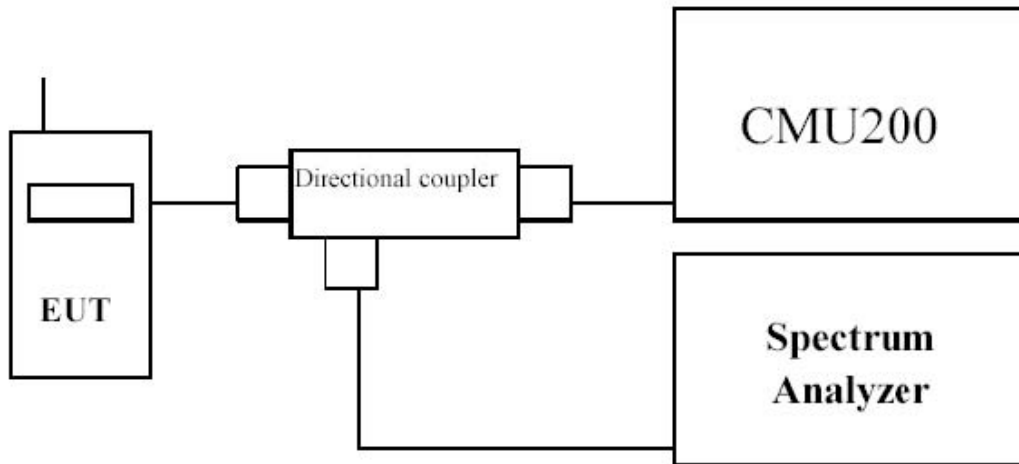

Radiated Spurious Measurement:

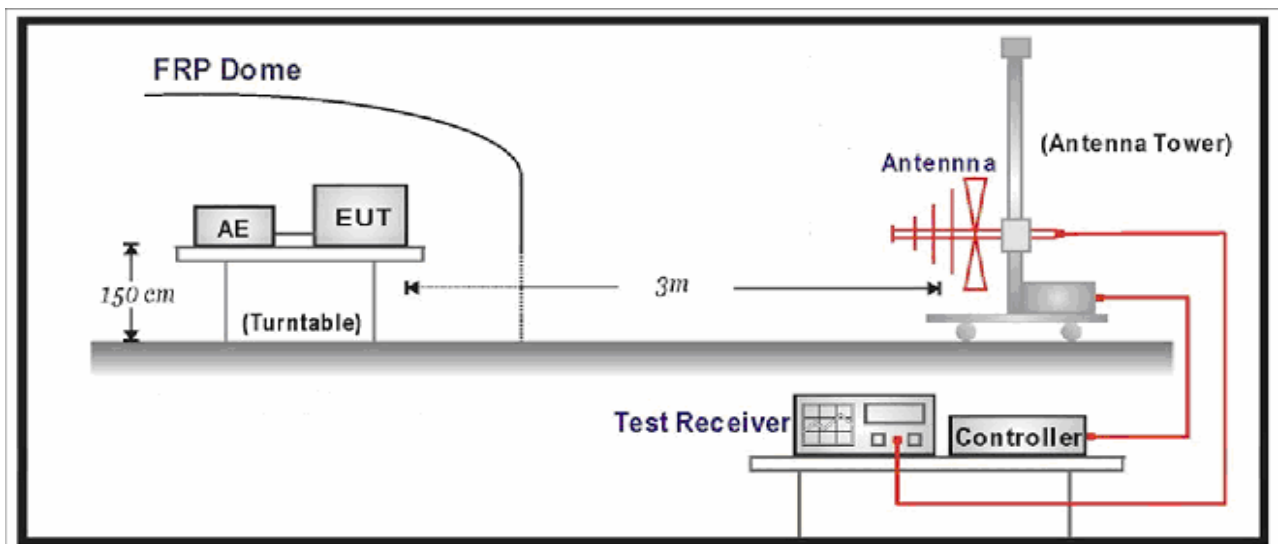

6.3. Limit

The power of any emission outside of the authorized operating frequency ranges must be attenuated below the transmitting power (P) by a factor of at least $43 + 10\log(P)$ dB.

6.4. Test Procedure

Conducted Spurious Measurement:

- a) Place the EUT on a bench and set it in transmitting mode.
- b) Connect a low loss RF cable from the antenna port to a spectrum analyzer and CMU200 by a Directional Couple.
- c) EUT Communicate with CMU200, then select a channel for testing.
- d) Add a correction factor to the display of spectrum, and then test.
- e) The resolution bandwidth of the spectrum analyzer was set at 1 MHz, sufficient scans were taken to show the out of band Emission if any up to 10th harmonic.

Radiated Spurious Measurement:

- a) The EUT shall be placed at the specified height on a support, and in the position closest to normal use as declared by provider.
- b) The test antenna shall be oriented initially for vertical polarization and shall be chosen to correspond to the frequency of the transmitter
- c) The output of the test antenna shall be connected to the measuring receiver.
- d) The transmitter shall be switched on and the measuring receiver shall be tuned to the frequency of the transmitter under test.
- e) The test antenna shall be raised and lowered through the specified range of height until a maximum signal level is detected by the measuring receiver.
- f) The transmitter shall then be rotated through 360° in the horizontal plane, until the maximum signal level is detected by the measuring receiver.
- g) The test antenna shall be raised and lowered again through the specified range of height until a maximum signal level is detected by the measuring receiver.
- u) The maximum signal level detected by the measuring receiver shall be noted.
- h) The transmitter shall be replaced by a substitution antenna.
- i) The substitution antenna shall be orientated for vertical polarization and the length of the substitution antenna shall be adjusted to correspond to the frequency of the transmitter.
- j) The substitution antenna shall be connected to a calibrated signal generator.
- k) If necessary, the input attenuator setting of the measuring receiver shall be adjusted in order to increase the sensitivity of the measuring receiver.
- l) The test antenna shall be raised and lowered through the specified range of height to ensure that the maximum signal is received.
- m) The input signal to the substitution antenna shall be adjusted to the level that produces a level detected by the measuring receiver, that is equal to the level noted while the transmitter radiated power was measured, corrected for the change of input attenuator setting of the measuring receiver.

- n) The measurement shall be repeated with the test antenna and the substitution antenna orientated for horizontal polarization.
- o) The measure of the effective radiated power is the larger of the two levels recorded at the input to the substitution antenna, corrected for gain of the substitution antenna if necessary.
- p) The frequency range was checked up to 10th harmonic.

6.5. Uncertainty

The measurement uncertainty is defined as 3.2 dB for Radiated Power Measurement.

6.6. Test Result

Product	Module		
Test Item	Spurious Emission		
Test Mode	Mode 1: GSM850 GPRS Link		
Date of Test	2011/02/20	Test Site	AC-5

Frequency (MHz)	SA Reading (dBm)	Ant.Pol. (H/V)	SG Reading (dBm)	Cable Loss (dB)	Gain (dBi)	EIRP (dBm)	Limit (dBm)	Margin (dB)
Low Channel 128 (824.20MHz)								
1603.5	-35.56	V	-54.19	2.45	9.50	-47.14	-13.00	-34.14
2496.0	-44.12	V	-59.13	3.18	10.58	-51.73	-13.00	-38.73
1603.5	-42.78	H	-60.66	2.45	9.50	-53.61	-13.00	-40.61
2496.0	-50.34	H	-63.15	3.18	10.58	-55.75	-13.00	-42.75
Middle Channel 189 (836.40MHz)								
1671.5	-35.59	V	-54.33	2.50	9.90	-46.93	-13.00	-33.93
2513.0	-44.99	V	-60.09	3.18	10.62	-52.65	-13.00	-39.65
1671.5	-41.89	H	-60.13	2.50	9.90	-52.73	-13.00	-39.73
2513.0	-50.87	H	-58.78	3.18	10.62	-51.34	-13.00	-38.34
High Channel 251 (848.80MHz)								
1697.0	-38.49	V	-57.16	2.54	10.10	-49.60	-13.00	-36.60
2547.0	-47.30	V	-62.53	3.14	10.68	-54.99	-13.00	-41.99
1697.0	-45.03	H	-63.61	2.54	10.10	-56.05	-13.00	-43.05
2547.0	-49.98	H	-59.96	3.14	10.68	-52.42	-13.00	-39.42

Product	Module		
Test Item	Spurious Emission		
Test Mode	Mode 2: GSM1900 GPRS Link		
Date of Test	2011/02/20	Test Site	AC-5

Frequency (MHz)	SA Reading (dBm)	Ant.Pol. (H/V)	SG Reading (dBm)	Cable Loss (dB)	Gain (dBi)	EIRP (dBm)	Limit (dBm)	Margin (dB)
Low Channel 512 (1850.20MHz)								
3703.0	-49.23	V	-63.13	3.84	12.69	-54.28	-13.00	-41.28
5556.0	-46.48	V	-55.33	4.82	13.15	-47.00	-13.00	-34.00
3703.0	-49.86	H	-63.34	3.84	12.69	-54.49	-13.00	-41.49
5556.0	-50.64	H	-59.70	4.82	13.15	-51.37	-13.00	-38.37
Middle Channel 661 (1880.00MHz)								
3762.5	-47.86	V	-61.07	3.75	12.73	-52.09	-13.00	-39.09
5998.0	-50.18	V	-58.54	5.00	13.00	-50.54	-13.00	-37.54
3762.5	-51.15	H	-64.39	3.75	12.73	-55.41	-13.00	-42.41
5998.0	-55.67	H	-52.84	5.00	13.00	-44.84	-13.00	-31.84
High Channel 810 (1909.80MHz)								
3822.0	-43.16	V	-59.51	4.02	12.73	-50.80	-13.00	-37.80
5554.5	-46.90	V	-55.67	4.82	13.10	-47.39	-13.00	-34.39
3822.0	-49.96	H	-63.11	4.02	12.73	-54.40	-13.00	-41.40
5554.5	-50.63	H	-60.27	4.82	13.10	-51.99	-13.00	-38.99

Product	Module		
Test Item	Spurious Emission		
Test Mode	Mode 3: GSM850 EDGE Link		
Date of Test	2011/02/20	Test Site	AC-5

Frequency (MHz)	SA Reading (dBm)	Ant.Pol. (H/V)	SG Reading (dBm)	Cable Loss (dB)	Gain (dBi)	EIRP (dBm)	Limit (dBm)	Margin (dB)
Low Channel 128 (824.20MHz)								
1646.0	-40.26	V	-59.14	2.50	9.80	-51.84	-13.00	-38.84
2470.5	-47.89	V	-60.40	3.12	10.48	-53.04	-13.00	-40.04
1646.0	-46.49	H	-64.62	2.50	9.80	-57.32	-13.00	-44.32
2470.5	-51.25	H	-64.02	3.12	10.48	-56.66	-13.00	-43.66
Middle Channel 189 (836.40MHz)								
1603.5	-43.55	V	-61.84	2.45	9.40	-54.89	-13.00	-41.89
2496.0	-50.98	V	-62.35	3.18	10.58	-54.95	-13.00	-41.95
1603.5	-50.46	H	-63.58	2.45	9.40	-56.63	-13.00	-43.63
2496.0	-51.63	H	-57.01	3.18	10.58	-49.61	-13.00	-36.61
High Channel 251 (848.80MHz)								
1697.0	-44.69	V	-57.91	8.54	10.10	-56.35	-13.00	-43.35
2547.0	-50.64	V	-62.16	3.14	10.68	-54.62	-13.00	-41.62
1697.0	-50.73	H	-58.26	8.54	10.10	-56.70	-13.00	-43.70
2547.0	-50.66	H	-60.76	3.14	10.68	-53.22	-13.00	-40.22

Product	Module		
Test Item	Spurious Emission		
Test Mode	Mode 4: GSM1900 EDGE Link		
Date of Test	2011/02/20	Test Site	AC-5

Frequency (MHz)	SA Reading (dBm)	Ant.Pol. (H/V)	SG Reading (dBm)	Cable Loss (dB)	Gain (dBi)	EIRP (dBm)	Limit (dBm)	Margin (dB)
Low Channel 512 (1850.20MHz)								
3703.0	-44.08	V	-60.57	3.84	12.69	-51.72	-13.00	-38.72
5998.0	-49.35	V	-57.86	5.00	13.00	-49.86	-13.00	-36.86
3703.0	-50.24	H	-63.22	3.84	12.69	-54.37	-13.00	-41.37
5998.0	-50.52	H	-59.10	5.00	13.00	-51.10	-13.00	-38.10
Middle Channel 661 (1880.00MHz)								
3762.5	-42.80	V	-59.42	3.75	12.73	-50.44	-13.00	-37.44
5530.5	-48.62	V	-61.17	4.82	13.14	-52.85	-13.00	-39.85
3762.5	-40.10	H	-56.58	3.75	12.73	-47.60	-13.00	-34.60
5530.5	-52.82	H	-55.79	4.82	13.14	-47.47	-13.00	-34.47
High Channel 810 (1909.80MHz)								
3822.0	-50.23	V	-63.94	4.02	12.73	-55.23	-13.00	-42.23
5998.0	-47.27	V	-55.76	5.00	13.00	-47.76	-13.00	-34.76
3822.0	-40.35	H	-56.56	4.02	12.73	-47.85	-13.00	-34.85
5998.0	-47.66	H	-56.14	5.00	13.00	-48.14	-13.00	-35.14

Product	Module		
Test Item	Spurious Emission		
Test Mode	Mode 5: WCDMA Band II Link		
Date of Test	2011/02/20	Test Site	AC-5

Frequency (MHz)	SA Reading (dBm)	Ant.Pol. (H/V)	SG Reading (dBm)	Cable Loss (dB)	Gain (dBi)	EIRP (dBm)	Limit (dBm)	Margin (dB)
Low Channel 9262 (1852.40MHz)								
3703.0	-30.64	V	-44.54	3.84	12.69	-35.69	-13.00	-22.69
5607.0	-50.95	V	-59.88	4.80	13.14	-51.54	-13.00	-38.54
3703.0	-33.23	H	-46.71	3.84	12.69	-37.86	-13.00	-24.86
5607.0	-51.10	H	-59.88	4.80	13.14	-51.54	-13.00	-38.54
Middle Channel 9400 (1880.00MHz)								
3745.5	-30.91	V	-44.24	3.74	12.71	-35.27	-13.00	-22.27
5539.0	-52.15	V	-58.61	4.82	13.14	-50.29	-13.00	-37.29
3745.5	-36.16	H	-49.47	3.74	12.71	-40.50	-13.00	-27.50
5539.0	-50.99	H	-58.89	4.82	13.14	-50.57	-13.00	-37.57
High Channel 9538 (1907.60MHz)								
3839.0	-37.05	V	-49.46	4.05	12.72	-40.79	-13.00	-27.79
5998.0	-51.54	V	-58.66	5.00	13.00	-50.66	-13.00	-37.66
3839.0	-42.01	H	-54.79	4.05	12.72	-46.12	-13.00	-33.12
5998.0	-51.22	H	-58.49	5.00	13.00	-50.49	-13.00	-37.49

Product	Module		
Test Item	Spurious Emission		
Test Mode	Mode 6: WCDMA Band V Link		
Date of Test	2011/02/20	Test Site	AC-5

Frequency (MHz)	SA Reading (dBm)	Ant.Pol. (H/V)	SG Reading (dBm)	Cable Loss (dB)	Gain (dBi)	EIRP (dBm)	Limit (dBm)	Margin (dB)
Low Channel 4132 (826.40MHz)								
1654.5	-51.70	V	-70.07	2.49	9.80	-62.76	-13.00	-49.76
2334.5	-43.66	V	-58.16	3.00	9.8	-51.36	-13.00	-38.36
1654.5	-51.97	H	-70.31	2.49	9.8	-63.00	-13.00	-50.00
2334.5	-38.47	H	-52.76	3.00	9.8	-45.96	-13.00	-32.96
Middle Channel 4182 (836.40MHz)								
1595.0	-54.02	V	-71.35	2.46	9.41	-64.40	-13.00	-51.4
2487.5	-42.24	V	-57.17	3.16	10.52	-49.81	-13.00	-36.81
1595.0	-51.95	H	-69.85	2.46	9.41	-62.90	-13.00	-49.90
2487.5	-37.60	H	-52.45	3.16	10.52	-45.09	-13.00	-32.09
High Channel 4233 (846.6MHz)								
1603.5	-52.79	V	-71.67	2.45	9.50	-64.62	-13.00	-51.62
2487.5	-41.20	V	-56.06	3.16	10.52	-48.70	-13.00	-35.70
1603.5	-52.45	H	-71.30	2.45	9.50	-64.25	-13.00	-51.25
2487.5	-37.80	H	-52.65	3.16	10.52	-45.29	-13.00	-32.29

Product	Module		
Test Item	Spurious Emission		
Test Mode	Mode 7: HSDPA Band II Link		
Date of Test	2011/02/20	Test Site	AC-5

Frequency (MHz)	SA Reading (dBm)	Ant.Pol. (H/V)	SG Reading (dBm)	Cable Loss (dB)	Gain (dBi)	EIRP (dBm)	Limit (dBm)	Margin (dB)
Low Channel 9262 (1852.40MHz)								
3703.0	-30.99	V	-44.89	3.84	12.69	-36.04	-13.00	-23.04
5556.0	-50.89	V	-59.81	4.82	13.15	-51.48	-13.00	-38.48
3703.0	-33.75	H	-47.23	3.84	12.69	-38.38	-13.00	-25.38
5556.0	-52.51	H	-59.33	4.82	13.15	-51.00	-13.00	-38.00
Middle Channel 9400 (1880.00MHz)								
3796.5	-31.06	V	-44.26	3.90	12.74	-35.42	-13.00	-22.42
5998.0	-51.63	V	-60.18	5.00	13.00	-52.18	-13.00	-39.18
3796.5	-36.89	H	-50.07	3.90	12.74	-41.23	-13.00	-28.23
5998.0	-52.21	H	-58.69	5.00	13.00	-50.69	-13.00	-37.69
High Channel 9538 (1907.60MHz)								
3813.5	-36.76	V	-49.23	4.00	12.74	-40.49	-13.00	-27.49
5726.0	-51.59	V	-60.41	4.87	13.11	-52.17	-13.00	-39.17
3813.5	-42.59	H	-55.44	4.00	12.74	-46.70	-13.00	-33.70
5726.0	-51.16	H	-59.88	4.87	13.11	-51.64	-13.00	-38.64

Product	Module		
Test Item	Spurious Emission		
Test Mode	Mode 8: HSDPA Band V Link		
Date of Test	2011/02/20	Test Site	AC-5

Frequency (MHz)	SA Reading (dBm)	Ant.Pol. (H/V)	SG Reading (dBm)	Cable Loss (dB)	Gain (dBi)	EIRP (dBm)	Limit (dBm)	Margin (dB)
Low Channel 4132 (826.40MHz)								
1603.5	-32.56	V	-51.11	2.45	9.50	-44.06	-13.00	-31.06
2496.0	-39.01	V	-53.95	3.18	10.58	-46.55	-13.00	-33.55
1603.5	-41.30	H	-59.85	2.45	9.50	-52.80	-13.00	-39.80
2496.0	-37.66	H	-52.55	3.18	10.58	-45.15	-13.00	-32.15
Middle Channel 4182 (836.40MHz)								
1595.0	-32.22	V	-50.52	2.46	9.41	-43.57	-13.00	-30.57
2487.5	-38.41	V	-53.34	3.16	10.52	-45.98	-13.00	-32.98
1595.0	-29.73	H	-47.34	2.46	9.41	-40.39	-13.00	-27.39
2487.5	-49.40	H	-62.47	3.16	10.52	-55.11	-13.00	-42.11
High Channel 4233 (846.6MHz)								
1603.5	-32.01	V	-50.17	2.45	9.50	-43.12	-13.00	-30.12
2496.0	-37.32	V	-52.26	3.18	10.58	-44.86	-13.00	-31.86
1603.5	-42.84	H	-60.89	2.45	9.50	-53.84	-13.00	-40.84
2496.0	-37.94	H	-52.82	3.18	10.58	-45.42	-13.00	-32.42

7. Frequency Stability Under Temperature & Voltage Variations

7.1. Test Equipment

Frequency Stability Under Temperature & Voltage Variations / AC-6

Instrument	Manufacturer	Type No.	Serial No	Cali. Due Date
PSA Series Spectrum Analyzer	Agilent	E4440A	MY49420184	2011.04.10
Radio Communication Tester	R&S	CMU 200	117088	2011.07.12
Dual Directional Coupler	Agilent	778D	20160	2011.04.20
10dB Coaxial Coupler	Agilent	87300C	MY44300299	2011.04.20
DC Power Supply	IDRC	CD-035-020PR	977272	2011.10.21
Temperature & Humidity Chamber	Gaoyu	TH-1P-B	WIT-05121302	2012.01.19
Temperature/Humidity Meter	Zhicheng	ZC1-2	AC6-TH	2012.01.14

7.2. Test Setup

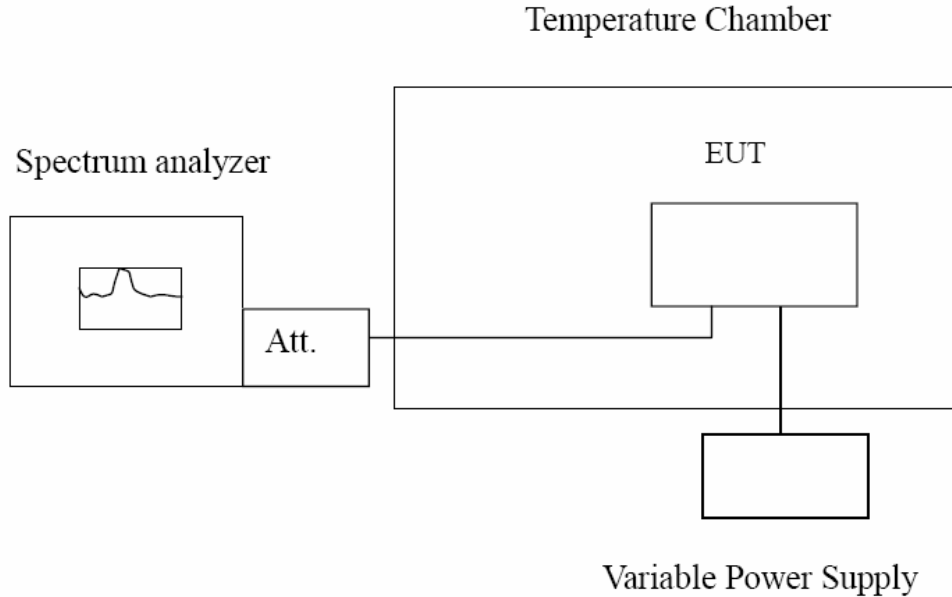

7.3. Limit

The frequency stability shall be sufficient to ensure that the fundamental emission stays within the authorized frequency block.

Limit	$< \pm 2.5 \text{ ppm}$
-------	-------------------------

7.4. Test Procedure

Frequency Stability Under Temperature Variations:

The equipment under test was connected to an external AC or DC power supply and input rated voltage. RF output was connected to a frequency counter or spectrum analyzer via feed through attenuators. The EUT was placed inside the temperature chamber. Set the spectrum analyzer RBW low enough to obtain the desired frequency resolution and measure EUT 20°C operating frequency as reference frequency. Turn EUT off and set the chamber temperature to -30°C. After the temperature stabilized for approximately 30 minutes recorded the frequency. Repeat step measure with 10°C increased per stage until the highest temperature of +50°C reached.

Frequency Stability Under Voltage Variations:

Set chamber temperature to 20°C. Use a variable AC power supply / DC power source to power the EUT and set the voltage to rated voltage. Set the spectrum analyzer RBW low enough to obtain the desired frequency resolution and recorded the frequency. Reduce the input voltage to specify extreme voltage variation ($\pm 15\%$) and endpoint, record the maximum frequency change.

7.5. Uncertainty

The measurement uncertainty is defined as $\pm 10 \text{ Hz}$.

7.6. Test Result

Product	Module		
Test Item	Frequency Stability Under Temperature & Voltage Variations		
Test Mode	Mode 1: GSM850 GPRS Link		
Date of Test	2011/02/20	Test Site	AC-6

Frequency Stability under Temperature

Temperature Interval (°C)	Test Frequency (MHz)	Deviation (Hz)	Limit (kHz)
-15	836.40	35	± 2091
0	836.40	25	± 2091
10	836.40	30	± 2091
20	836.40	28	± 2091
30	836.40	32	± 2091
40	836.40	35	± 2091
55	836.40	40	± 2091

Frequency Stability under Voltage

DC Voltage (V)	Test Frequency (MHz)	Deviation (Hz)	Limit (KHz)
4.200	836.40	44	± 2091
3.600	836.40	65	± 2091
3.200	836.40	77	± 2091

Product	Module		
Test Item	Frequency Stability Under Temperature & Voltage Variations		
Test Mode	Mode 2: PCS1900 GPRS Link		
Date of Test	2011/02/20	Test Site	AC-6

Frequency Stability under Temperature

Temperature Interval (°C)	Test Frequency (MHz)	Deviation (Hz)	Limit (Hz)
-15	1880.00	56	± 4700
0	1880.00	54	± 4700
10	1880.00	45	± 4700
20	1880.00	48	± 4700
30	1880.00	41	± 4700
40	1880.00	47	± 4700
55	1880.00	50	± 4700

Frequency Stability under Voltage

DC Voltage (V)	Test Frequency (MHz)	Deviation (Hz)	Limit (KHz)
4.200	1880.00	77	± 4700
3.600	1880.00	36	± 4700
3.200	1880.00	40	± 4700

Product	Module		
Test Item	Frequency Stability Under Temperature & Voltage Variations		
Test Mode	Mode 3: GSM850 EDGE Link		
Date of Test	2011/02/20	Test Site	AC-6

Frequency Stability under Temperature

Temperature Interval (°C)	Test Frequency (MHz)	Deviation (Hz)	Limit (kHz)
-15	836.40	-31	± 2091
0	836.40	-24	± 2091
10	836.40	-27	± 2091
20	836.40	-19	± 2091
30	836.40	-22	± 2091
40	836.40	-29	± 2091
55	836.40	-37	± 2091

Frequency Stability under Voltage

DC Voltage (V)	Test Frequency (MHz)	Deviation (Hz)	Limit (KHz)
4.200	836.40	67	± 2091
3.600	836.40	52	± 2091
3.200	836.40	18	± 2091

Product	Module		
Test Item	Frequency Stability Under Temperature & Voltage Variations		
Test Mode	Mode 4: PCS1900 EDGE Link		
Date of Test	2011/02/20	Test Site	AC-6

Frequency Stability under Temperature

Temperature Interval (°C)	Test Frequency (MHz)	Deviation (Hz)	Limit (Hz)
-15	1880.00	55	± 4700
0	1880.00	50	± 4700
10	1880.00	54	± 4700
20	1880.00	51	± 4700
30	1880.00	58	± 4700
40	1880.00	62	± 4700
55	1880.00	68	± 4700

Frequency Stability under Voltage

DC Voltage (V)	Test Frequency (MHz)	Deviation (Hz)	Limit (KHz)
4.200	1880.00	23	± 4700
3.600	1880.00	56	± 4700
3.200	1880.00	54	± 4700

Product	Module		
Test Item	Frequency Stability Under Temperature & Voltage Variations		
Test Mode	Mode 5: WCDMA Band II Link		
Date of Test	2011/02/20	Test Site	AC-6

Frequency Stability under Temperature

Temperature Interval (°C)	Test Frequency (MHz)	Deviation (Hz)	Limit (Hz)
-15	1880.00	11	± 4700
0	1880.00	24	± 4700
10	1880.00	46	± 4700
20	1880.00	27	± 4700
30	1880.00	37	± 4700
40	1880.00	40	± 4700
55	1880.00	52	± 4700

Frequency Stability under Voltage

DC Voltage (V)	Test Frequency (MHz)	Deviation (Hz)	Limit (KHz)
4.200	1880.00	33	± 4700
3.600	1880.00	47	± 4700
3.200	1880.00	18	± 4700

Product	Module		
Test Item	Frequency Stability Under Temperature & Voltage Variations		
Test Mode	Mode 6: WCDMA Band V Link		
Date of Test	2011/02/20	Test Site	AC-6

Frequency Stability under Temperature

Temperature Interval (°C)	Test Frequency (MHz)	Deviation (Hz)	Limit (kHz)
-15	836.40	-34	± 2091
0	836.40	-31	± 2091
10	836.40	-24	± 2091
20	836.40	-27	± 2091
30	836.40	-19	± 2091
40	836.40	-22	± 2091
55	836.40	-29	± 2091

Frequency Stability under Voltage

DC Voltage (V)	Test Frequency (MHz)	Deviation (Hz)	Limit (KHz)
4.200	836.40	39	± 2091
3.600	836.40	49	± 2091
3.200	836.40	16	± 2091

Product	Module		
Test Item	Frequency Stability Under Temperature & Voltage Variations		
Test Mode	Mode 7: HSDPA Band II Link		
Date of Test	2011/02/20	Test Site	AC-6

Frequency Stability under Temperature

Temperature Interval (°C)	Test Frequency (MHz)	Deviation (Hz)	Limit (Hz)
-15	1880.00	-36	± 4700
0	1880.00	-32	± 4700
10	1880.00	-25	± 4700
20	1880.00	-19	± 4700
30	1880.00	-33	± 4700
40	1880.00	-24	± 4700
55	1880.00	-37	± 4700

Frequency Stability under Voltage

DC Voltage (V)	Test Frequency (MHz)	Deviation (Hz)	Limit (KHz)
4.200	1880.00	11	± 4700
3.600	1880.00	57	± 4700
3.200	1880.00	25	± 4700

Product	Module		
Test Item	Frequency Stability Under Temperature & Voltage Variations		
Test Mode	Mode 8: HSDPA Band V Link		
Date of Test	2011/02/20	Test Site	AC-6

Frequency Stability under Temperature

Temperature Interval (°C)	Test Frequency (MHz)	Deviation (Hz)	Limit (kHz)
-15	836.40	-36	± 2091
0	836.40	-27	± 2091
10	836.40	-23	± 2091
20	836.40	-21	± 2091
30	836.40	-25	± 2091
40	836.40	-19	± 2091
55	836.40	-28	± 2091

Frequency Stability under Voltage

DC Voltage (V)	Test Frequency (MHz)	Deviation (Hz)	Limit (KHz)
4.200	836.40	66	± 2091
3.600	836.40	41	± 2091
3.200	836.40	32	± 2091

Appendix 1 – Test Setup Photograph

Description: Radiated Spurious Emission Test Setup for Below 1 GHz

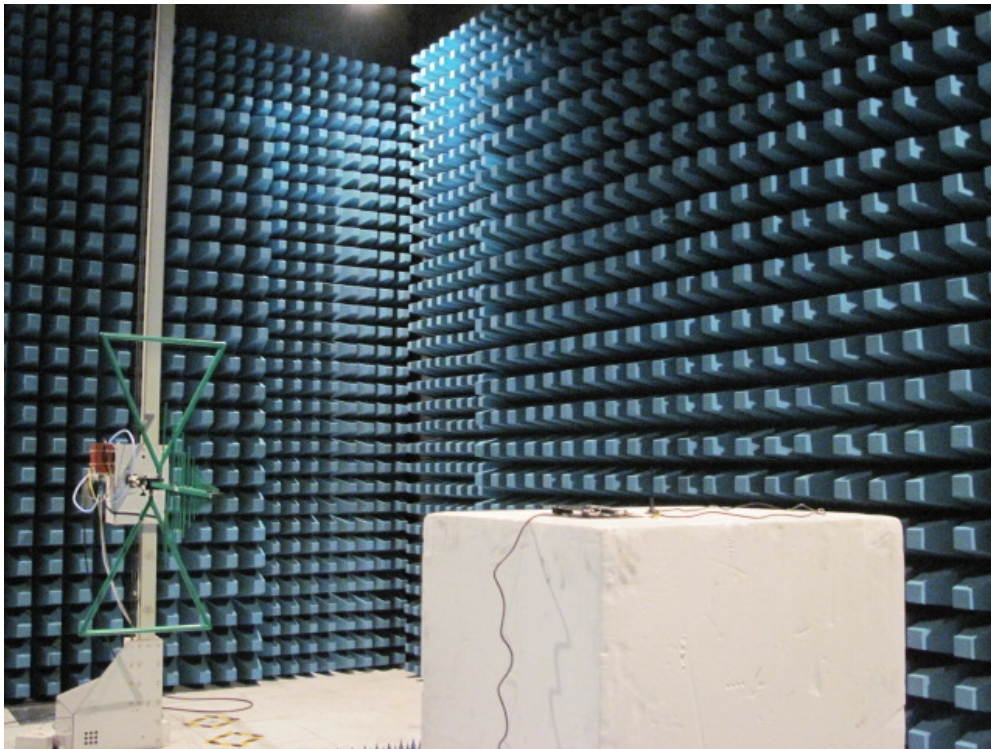

Description: Substitution Antenna Test Setup for Below 1 GHz



Description: Radiated Spurious Emission Test Setup for Above 1 GHz

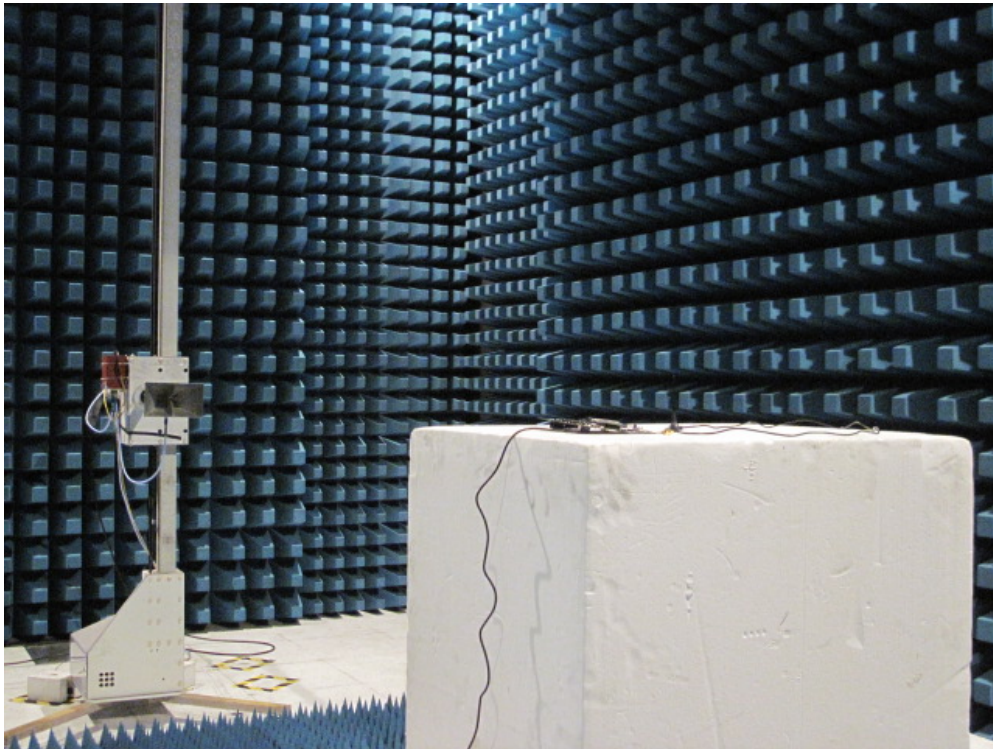

Description: Substitution Antenna Test Setup for Above 1 GHz

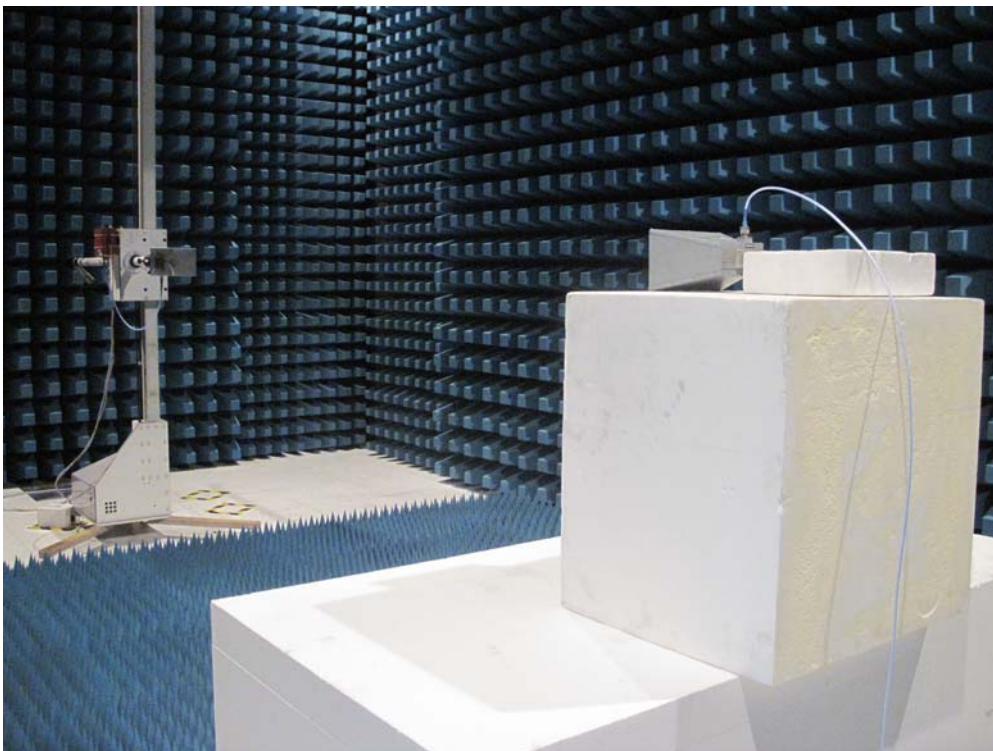

Appendix 2 – EUT Photograph

(1) EUT Photo

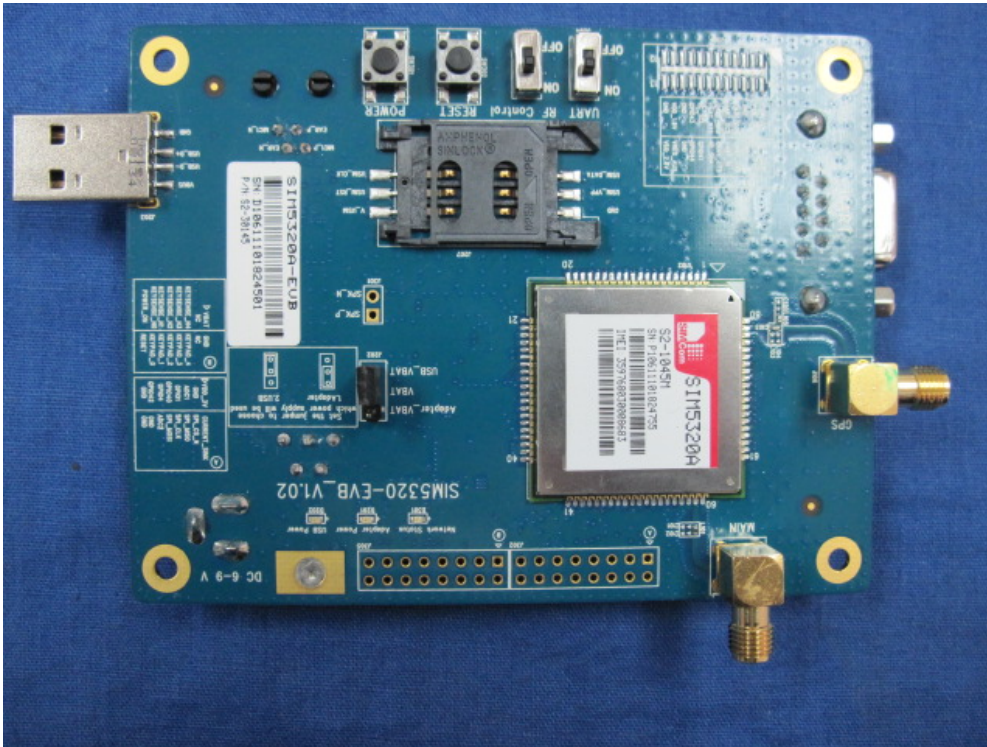

(2) EUT Photo

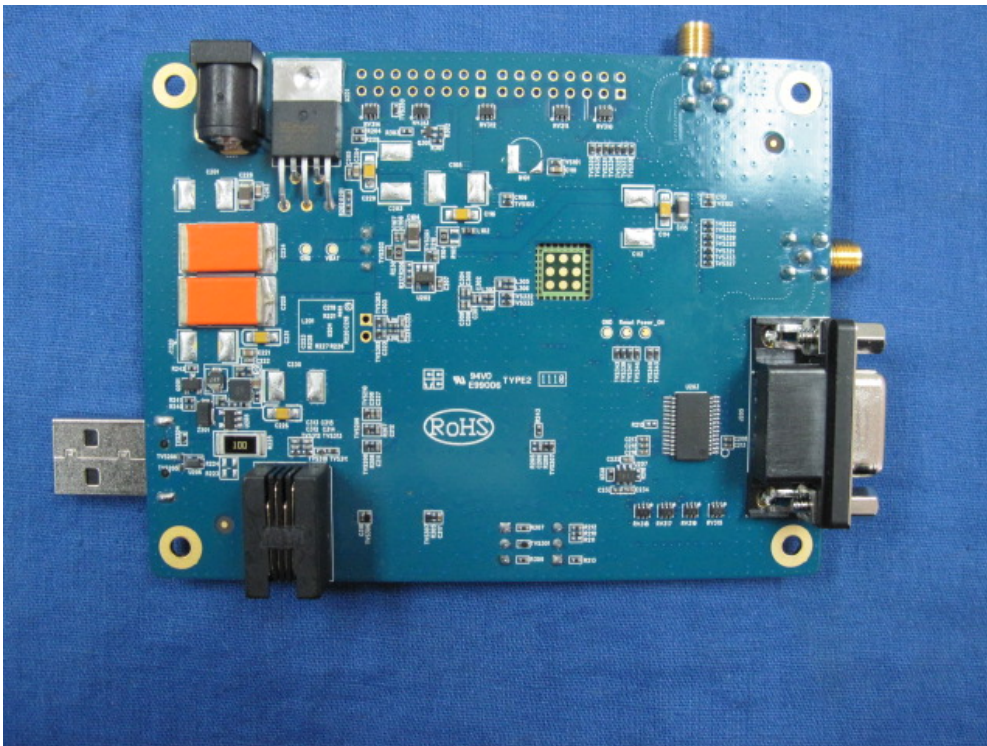

(3) EUT Photo



(4) EUT Photo

