

TEST REPORT

Test report no.: 1-4371/12-01-03



Testing laboratory

CETECOM ICT Services GmbH
 Untertuerkheimer Strasse 6 – 10
 66117 Saarbruecken / Germany
 Phone: + 49 681 5 98 - 0
 Fax: + 49 681 5 98 - 9075
 Internet: <http://www.cetecom.com>
 e-mail: ict@cetecom.com

Accredited Testing Laboratory:

The testing laboratory (area of testing) is accredited according to DIN EN ISO/IEC 17025 (2005) by the Deutsche Akkreditierungsstelle GmbH (DAkkS). The accreditation is valid for the scope of testing procedures as stated in the accreditation certificate with the registration number: D-PL-12076-01-01. Area of Testing: Radio/Satellite Communications

Applicant

RSI Video Technologies
 56, rue Jean Giraudoux - Bâtiment 60
 67200 Strasbourg / FRANCE
 Phone: +33 3 90 20 66 96
 Fax: +33 3 90 20 66 36
 Contact: Thierry Petri
 e-mail: thierry.petri@rsivideotech.com
 Phone: +33 3 90 20 66 96

Manufacturer

RSI Video Technologies
 56, rue Jean Giraudoux - Bâtiment 60
 67200 Strasbourg / FRANCE

Test standard/s

47 CFR Part 15 Title 47 of the Code of Federal Regulations; Chapter I
 Part 15 - Radio frequency devices

RSS - 210 Issue 8 Spectrum Management and Telecommunications - Radio Standards Specification
 Low-power Licence-exempt Radiocommunication Devices (All Frequency Bands):
 Category I Equipment

For further applied test standards please refer to section 3 of this test report.

Test Item

Kind of test item: Wireless Alarm
Model name: CMA600
FCC ID: X46CM00
IC: 8816A-CM00
 Frequency: ISM band 902 MHz to 928 MHz
 (lowest channel 904.5 MHz, highest channel 926.1 MHz)
 Technology tested: FHSS system with FSK modulation
 Antenna: Integrated wire antenna
 Power Supply: 3.6 V 3 X LS14500 Li - battery
 Temperature Range: -30°C to +60 °C



This test report is electronically signed and valid without handwriting signature. For verification of the electronic signatures, the public keys can be requested at the testing laboratory.

Test report authorised:

[Signature box for Marco Bertolino]

Marco Bertolino
 Testing Manager

Test performed:

[Signature box for Andreas Luckenbill]

Andreas Luckenbill

1 Table of contents

1	Table of contents	2
2	General information	3
2.1	Notes and disclaimer	3
2.2	Application details.....	3
3	Test standard/s	3
4	Test environment.....	4
5	Test item.....	4
6	Test laboratories sub-contracted	4
7	Summary of measurement results	5
8	RF measurements	6
8.1	Description of test setup	6
8.1.1	Radiated measurements.....	6
8.1.2	Conducted measurements.....	7
8.2	Additional comments	7
8.3	RSP100 test report cover sheet / performance test data	8
9	Measurement results.....	9
9.1	Antenna gain	9
9.2	Carrier Frequency Separation	10
9.3	Number of Hopping Channels.....	11
9.4	Average Time of Occupancy	12
9.5	20 dB Bandwidth	14
9.6	Maximum Output Power Radiated	16
9.7	Maximum Output Power Conducted	17
9.8	Band-edge Compliance of conducted and radiated emissions.....	19
9.9	Spurious Emissions Conducted (Transmitter).....	20
9.10	Spurious Emissions Radiated < 30 MHz.....	24
9.11	Spurious Emissions Radiated (Transmitter) > 30 MHz	26
9.12	RX spurious emissions radiated	35
10	Test equipment and ancillaries used for tests	38
11	Observations	39
Annex A	Photographs of the test setup	40
Annex B	External photographs of the EUT	44
Annex C	Internal photographs of the EUT	47
Annex D	Document history	53
Annex E	Further information.....	53
Annex F	Accreditation Certificate	54

2 General information

2.1 Notes and disclaimer

The test results of this test report relate exclusively to the test item specified in this test report. CETECOM ICT Services GmbH does not assume responsibility for any conclusions and generalizations drawn from the test results with regard to other specimens or samples of the type of the equipment represented by the test item.

The test report may only be reproduced or published in full. Reproduction or publication of extracts from the report requires the prior written approval of CETECOM ICT Services GmbH.

The testing service provided by CETECOM ICT Services GmbH has been rendered under the current "General Terms and Conditions for CETECOM ICT Services GmbH".

CETECOM ICT Services GmbH will not be liable for any loss or damage resulting from false, inaccurate, inappropriate or incomplete product information provided by the customer.

Under no circumstances does the CETECOM ICT Services GmbH test report include any endorsement or warranty regarding the functionality, quality or performance of any other product or service provided.

Under no circumstances does the CETECOM ICT Services GmbH test report include or imply any product or service warranties from CETECOM ICT Services GmbH, including, without limitation, any implied warranties of merchantability, fitness for purpose, or non-infringement, all of which are expressly disclaimed by CETECOM ICT Services GmbH.

All rights and remedies regarding vendor's products and services for which CETECOM ICT Services GmbH has prepared this test report shall be provided by the party offering such products or services and not by CETECOM ICT Services GmbH.

In no case this test report can be considered as a Letter of Approval.

This test report is electronically signed and valid without handwritten signature. For verification of the electronic signatures, the public keys can be requested at the testing laboratory.

2.2 Application details

Date of receipt of order:	2012-03-06
Date of receipt of test item:	2012-03-26
Start of test:	2012-03-26
End of test:	2012-04-05
Person(s) present during the test:	-/-

3 Test standard/s

Test standard	Date	Test standard description
47 CFR Part 15	2010-10	Title 47 of the Code of Federal Regulations; Chapter I Part 15 - Radio frequency devices
RSS - 210 Issue 8	2010-12	Spectrum Management and Telecommunications - Radio Standards Specification Low-power Licence-exempt Radiocommunication Devices (All Frequency Bands): Category I Equipment

4 Test environment

Temperature:	T_{nom}	+22 °C during room temperature tests
	T_{max}	+60 °C during high temperature tests
	T_{min}	-30 °C during low temperature tests
Relative humidity content:		42 %
Barometric pressure:		not relevant for this kind of testing
Power supply:	V_{nom}	3.6 V 3 X LS14500 Li - battery
	V_{max}	4.1 V
	V_{min}	3.1 V

5 Test item

Kind of test item	:	Wireless Alarm
Type identification	:	CMA600
S/N serial number	:	Radiated unit: 43034511811A0D33 Conducted unit: 43034511811A0D34
HW hardware status	:	No information available!
SW software status	:	No information available!
Frequency band [MHz]	:	ISM band 902 MHz to 928 MHz (lowest channel 904.5 MHz, highest channel 926.1 MHz)
Type of radio transmission	:	FHSS
Use of frequency spectrum	:	
Channel access method	:	FDMA
Type of modulation	:	FSK
Number of channels	:	25
Antenna	:	Integrated wire antenna
Power supply	:	3.6 V 3 X LS14500 Li - battery
Temperature range	:	-30°C to +60 °C

6 Test laboratories sub-contracted

None

7 Summary of measurement results

- No deviations from the technical specifications were ascertained
- There were deviations from the technical specifications ascertained

TC Identifier	Description	Verdict	Date	Remark
RF-Testing	CFR Part 15 RSS 210, Issue 8	Passed	2012-04-10	-/-

Test specification clause	Test case	Temperature conditions	Power source voltages	Mode	Pass	Fail	NA	NP	Results (max.)
§15.247(b)(4)	Antenna Gain	Nominal	Nominal	TX	<input checked="" type="checkbox"/>	<input type="checkbox"/>	<input type="checkbox"/>	<input type="checkbox"/>	complies
§15.247(a)(1) (i) RSS-210 A8.1 (b)	Carrier Frequency Separation	Nominal	Nominal	TX	<input checked="" type="checkbox"/>	<input type="checkbox"/>	<input type="checkbox"/>	<input type="checkbox"/>	complies
§15.247(a)(1)(i) RSS-210 A8.1 (c)	Number of Hopping channels	Nominal	Nominal	TX	<input checked="" type="checkbox"/>	<input type="checkbox"/>	<input type="checkbox"/>	<input type="checkbox"/>	complies
§15.247(a)(1)(i) RSS-210 A8.1 (c)	Average Time of Occupancy (Dwell Time)	Nominal	Nominal	TX	<input checked="" type="checkbox"/>	<input type="checkbox"/>	<input type="checkbox"/>	<input type="checkbox"/>	complies
§15.247(a)(1)(i) RSS-210 A8.1 (c)	20dB Bandwidth	Nominal	Nominal	TX	<input checked="" type="checkbox"/>	<input type="checkbox"/>	<input type="checkbox"/>	<input type="checkbox"/>	complies
§15.247(b)(2) RSS-210 A8.4 (1)	Maximum Output Power Radiated	Nominal	Nominal	TX	<input checked="" type="checkbox"/>	<input type="checkbox"/>	<input type="checkbox"/>	<input type="checkbox"/>	complies
§15.247(b)(4) RSS-210 A8.4 (1)	Maximum Output Power Conducted	Nominal	Nominal	TX	<input checked="" type="checkbox"/>	<input type="checkbox"/>	<input type="checkbox"/>	<input type="checkbox"/>	complies
§15.247(d) §15.205(a)	Band-edge Compliance	Nominal	Nominal	TX	<input checked="" type="checkbox"/>	<input type="checkbox"/>	<input type="checkbox"/>	<input type="checkbox"/>	complies
§15.247(d)	TX Spurious Emission Conducted	Nominal	Nominal	TX	<input checked="" type="checkbox"/>	<input type="checkbox"/>	<input type="checkbox"/>	<input type="checkbox"/>	complies
§15.209(a)	TX Spurious Emission Radiated < 30 MHz	Nominal	Nominal	TX	<input checked="" type="checkbox"/>	<input type="checkbox"/>	<input type="checkbox"/>	<input type="checkbox"/>	complies
§15.247(d) §15.209 A8.5	TX Spurious Emission Radiated > 30 MHz	Nominal	Nominal	TX	<input checked="" type="checkbox"/>	<input type="checkbox"/>	<input type="checkbox"/>	<input type="checkbox"/>	complies
§15.109	RX Spurious Emissions Radiated	Nominal	Nominal	Idle	<input checked="" type="checkbox"/>	<input type="checkbox"/>	<input type="checkbox"/>	<input type="checkbox"/>	complies

Note: NA = Not Applicable; NP = Not Performed

8 RF measurements

8.1 Description of test setup

8.1.1 Radiated measurements

The radiated measurements are performed in vertical and horizontal plane in the frequency range from 9 kHz to 25 GHz in semi-anechoic chambers. The EUT is positioned on a non-conductive support with a height of 0.80 m above a conductive ground plane that covers the whole chamber. The receiving antennas are confirmed with specifications ANSI C63.2-1996 clause 15 and ANSI C63.4-2009 clause 4.1.5. These antennas can be moved over the height range between 1.0 m and 4.0 m in order to search for maximum field strength emitted from EUT. The measurement distances between EUT and receiving antennas are indicated in the test setups for the various frequency ranges. For each measurement, the EUT is rotated in all three axes until the maximum field strength is received. The wanted and unwanted emissions are received by spectrum analysers where the detector modes and resolution bandwidths over various frequency ranges are set according to requirement ANSI C63-4-2009 clause 4.2.

Antennas are confirmed with ANSI C63.2-1996 item 15.

Semi anechoic chamber

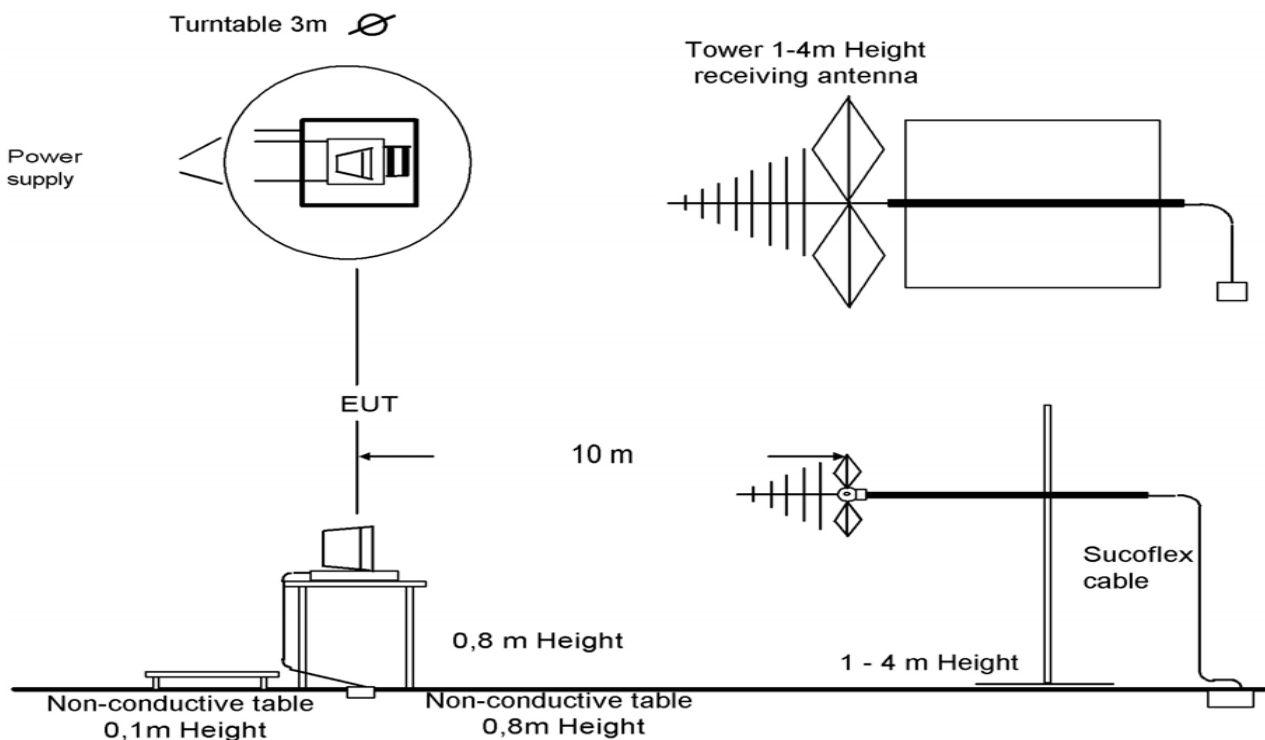

Picture 1: Diagram radiated measurements

9 kHz - 30 MHz:	active loop antenna
30 MHz – 1 GHz:	tri-log antenna
> 1 GHz:	horn antenna

All measurements are done in accordance with the Filing and Measurement Guidelines for Frequency Hopping Spread Spectrum Systems DA 00-705 and Appendix A “BLUETOOTH® APPROVALS”
 The EUT is powered by an external power supply with nominal voltage. The signalling is performed from outside the chamber with a signalling unit (CMU200 or other) by air link using signalling antenna.

8.1.2 Conducted measurements

The EUT's RF signal is coupled out by the antenna connector which is supplied by the manufacturer. The signal is first 10dB attenuated before it is power divided (~6dB loss per branch). One of the signal paths is connected to the communication base Station (CMU200 or other), the other one is connected to the spectrum analyzer. The specific losses for both signal paths are first checked within a calibration. The measurement readings on the signalling unit/spectrum analyzer are corrected by the specific test set-up loss. The attenuator, power divider, signalling unit and the spectrum analyzer are impedance matched on 50 Ohm.

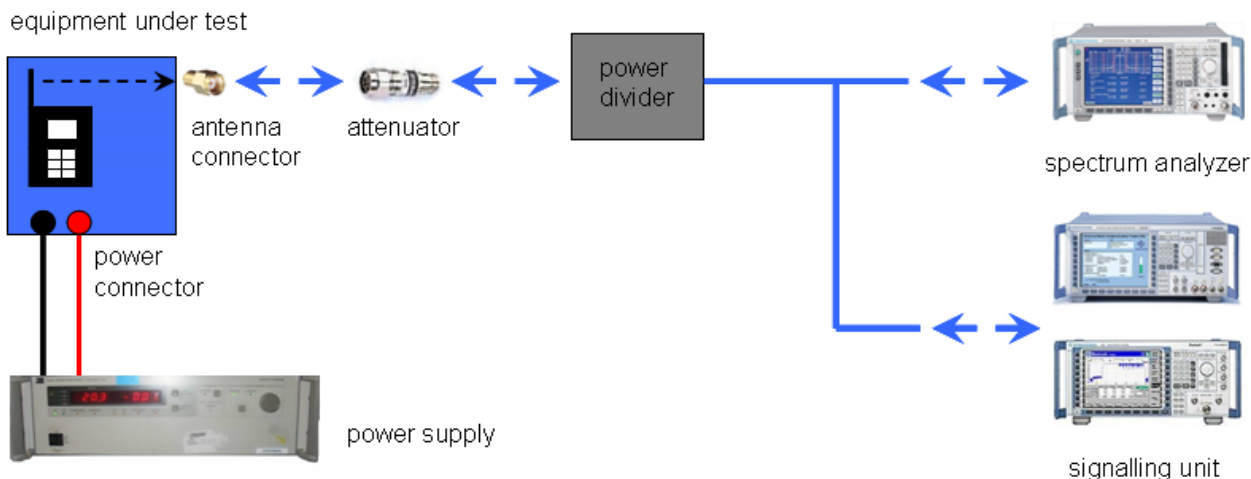

Picture 2: Diagram conducted measurements

8.2 Additional comments

- Reference documents: None
- Special test descriptions: None
- Configuration descriptions: None
- Test mode: Special software is used.
EUT is transmitting pseudo random data by itself

8.3 RSP100 test report cover sheet / performance test data

Test report number	:	1-4371_12-01-03
Equipment model number	:	CMA600
Certification number	:	8816A-CM00
Manufacturer (complete address)	:	RSI Video Technologies 56, rue Jean Giraudoux - Bâtiment 60 67200 Strasbourg / FRANCE
Tested to radio standards specification no.	:	RSS 210, Issue 8
Open area test site IC No.	:	IC 3462C-1
Frequency range	:	ISM band 902 MHz to 928 MHz (lowest channel 904.5 MHz, highest channel 926.1 MHz)
RF-power [W] (max.)	:	Cond.: 64.95 mW (FSK modulation) EIRP: 16.56 mW (FSK modulation)
Occupied bandwidth (99%-BW) [kHz]	:	454 (FSK modulation)
Type of modulation	:	FHSS technology with FSK modulation.
Emission designator (TRC-43)	:	454KFXD (FSK modulation)
Antenna information	:	Integrated wire antenna
Transmitter spurious (worst case) [dB μ V/m @ 3m]:		69.66 @ 2778.7 MHz Peak 42.12 @ 2778.7 MHz AVG
Receiver spurious (worst case) [dB μ V/m @ 3m]:		45 dB μ V/m Peak (noise floor)

ATTESTATION:

DECLARATION OF COMPLIANCE:

I attest that the testing was performed or supervised by me; that the test measurements were made in accordance with the above-mentioned Industry Canada standard(s); and that the equipment identified in this application has been subjected to all the applicable test conditions specified in the Industry Canada standards and all of the requirements of the standard have been met.

Laboratory manager:

2012-04-10

Date

Andreas Luckenbill

Name



Signature

9 Measurement results

9.1 Antenna gain

The antenna gain of the complete system is calculated by the difference of radiated power in EIRP and the conducted power of the module.

	Low channel 904.5 MHz	Middle channel 915.3 MHz	High channel 926.1 MHz
Conducted power [dBm]	17.53	17.84	17.99
Radiated power [dBm]	12.19	11.42	10.93
Gain [dBi] Calculated	-5.34	-6.42	-7.06

Limits:

FCC	IC
Antenna gain	
<p>The conducted output power limit specified in paragraph (b) of this section is based on the use of antennas with directional gains that do not exceed 6 dBi. Except as shown in paragraph (c) of this section, if transmitting antennas of directional gain greater than 6 dBi are used, the conducted output power from the intentional radiator shall be reduced below the stated values in paragraphs (b)(1), (b)(2), and (b)(3) of this section, as appropriate, by the amount in dB that the directional gain of the antenna exceeds 6 dBi.</p>	

Result: **Passed**

9.2 Carrier Frequency Separation

Plot 1:

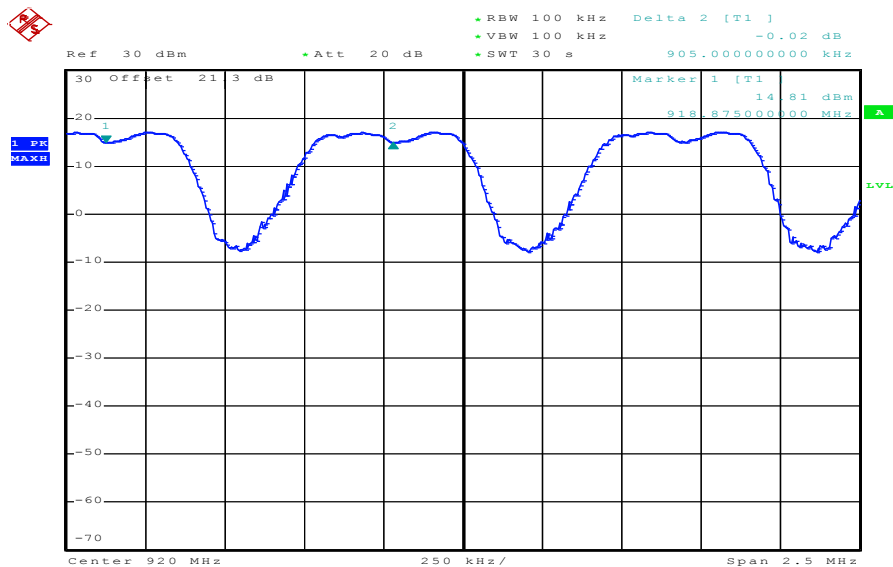

Date: 4.APR.2012 13:44:03

Result: The channel separation is: 905 kHz

Limits:

FCC	IC
Carrier Frequency Separation	
Frequency hopping systems shall have hopping channel carrier frequencies separated by a minimum of 25 kHz or the 20 dB bandwidth of the hopping channel, whichever is greater.	

Result: Passed

9.3 Number of Hopping Channels

Plot 2:

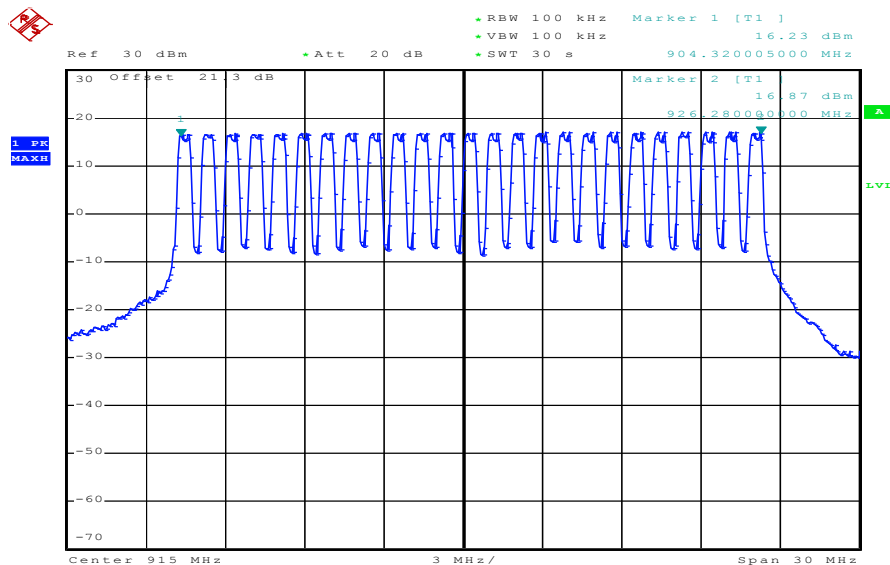

Date: 5.APR.2012 08:28:01

Result: The number of hopping channels is: 25

Limits:

FCC	IC
Number of Hopping Channels	
For frequency hopping systems operating in the 902-928 MHz band: if the 20 dB bandwidth of the hopping channel is less than 250 kHz, the system shall use at least 50 hopping within a 20 second period; if the 20 dB bandwidth of the hopping channel is 250 kHz or greater, the system shall use at least 25 hopping frequencies.	

Result: Passed

9.4 Average Time of Occupancy

Plot 3: Time slot length = 2.098 ms

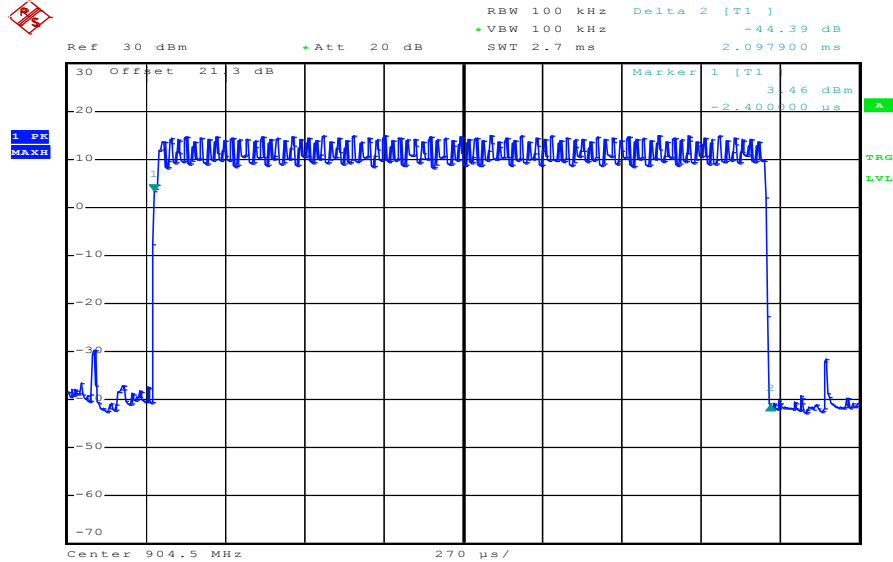

Date: 4.APR.2012 13:44:41

Plot 4: hops / channel @ 1s = 18

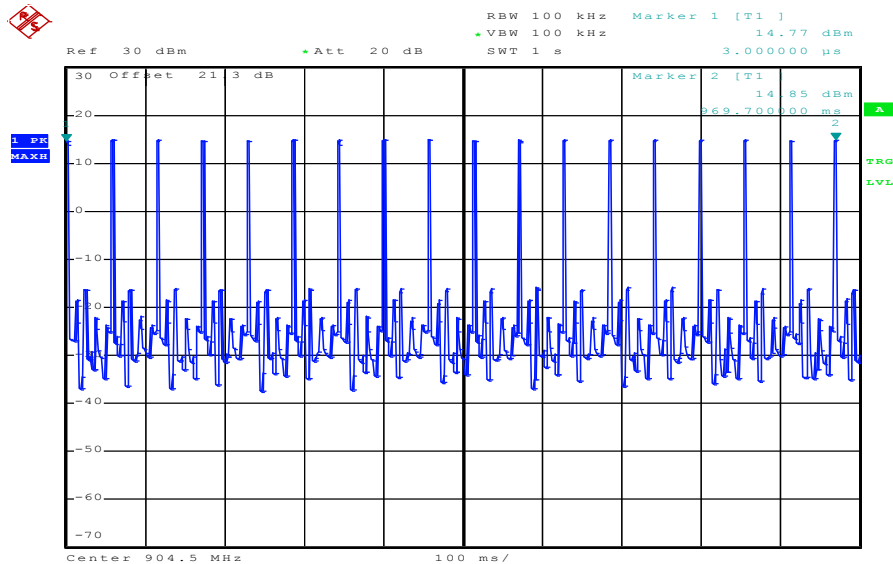

Date: 4.APR.2012 13:46:07

Result: The time slot length is = 2.098 ms
 Number of hops / channel @ 1s = 18

Within 10 s period, the average time of occupancy = $10 \text{ s} * 18 * 2.098 \text{ ms}$

→ The average time of occupancy = 377.64 ms

Limits:

FCC	IC
Average time of occupancy	
For frequency hopping systems operating in the 902-928 MHz band: if the 20 dB bandwidth of the hopping channel is less than 250 kHz, the system shall use at least 50 hopping within a 20 second period; if the 20 dB bandwidth of the hopping channel is 250 kHz or greater, the system shall use at least 25 hopping frequencies and the average time of occupancy on any frequency shall not be greater than 0.4 seconds within 10 second period.	

Result: Passed

9.5 20 dB Bandwidth

Plot 5: Low channel

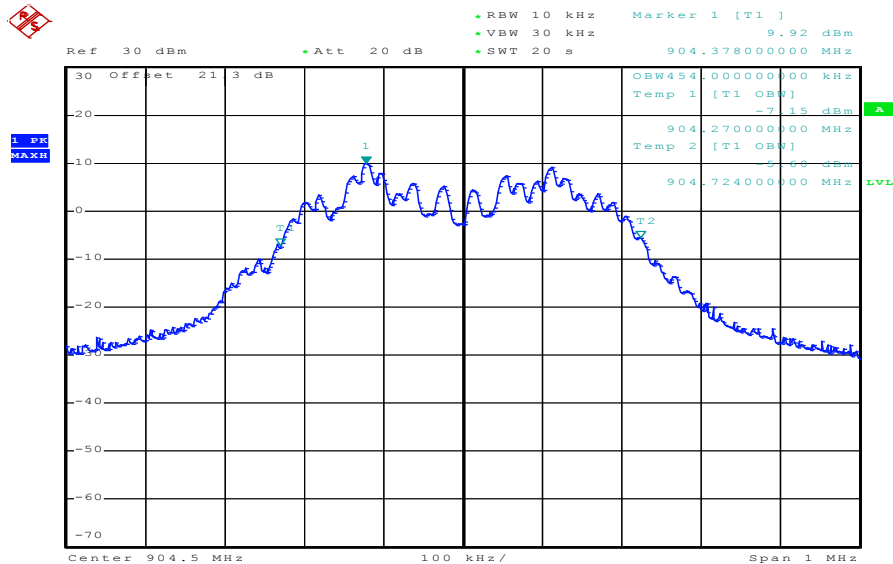

Date: 26.MAR.2012 13:56:03

Plot 6: Middle channel

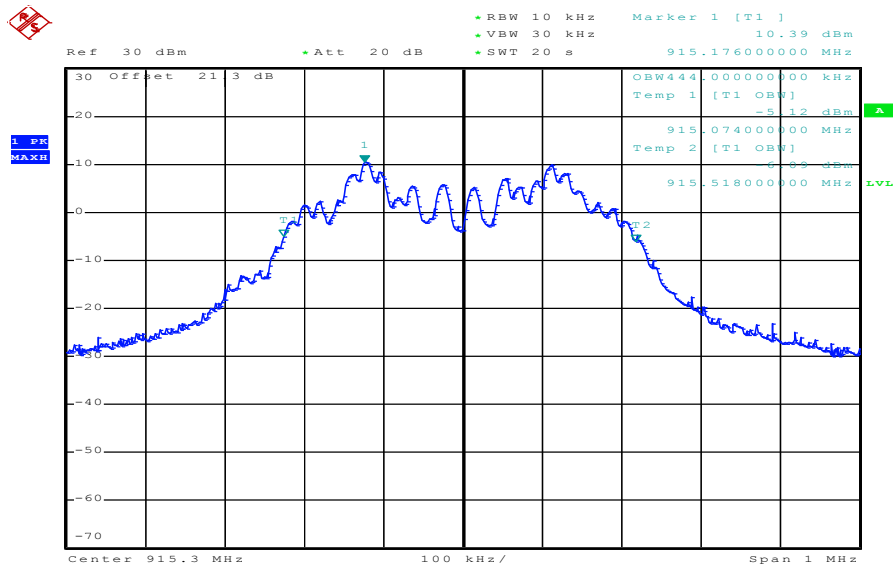

Date: 26.MAR.2012 13:58:11

Plot 7: High channel

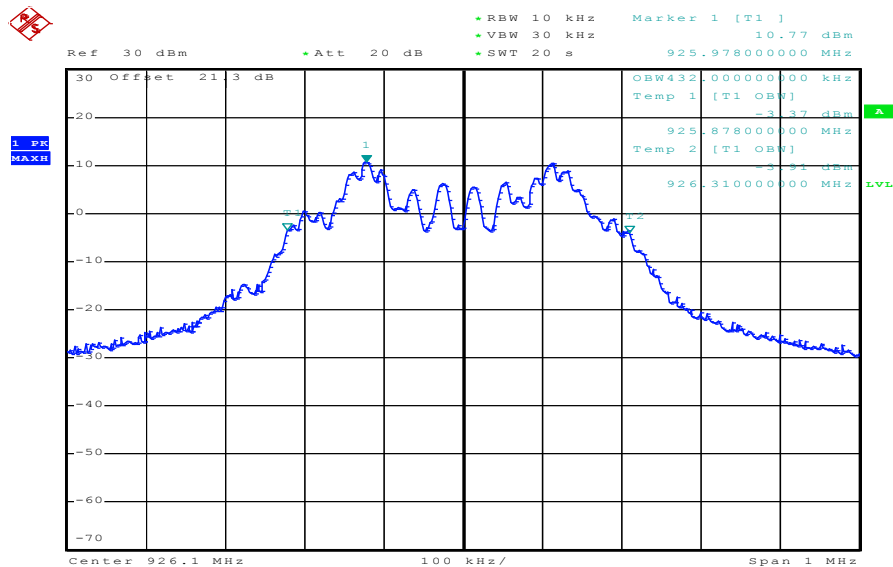

Date: 26.MAR.2012 14:00:18

Result:

Test Conditions		20dB BANDWIDTH [kHz]		
		904.5 MHz	915.3 MHz	926.1 MHz
T_{nom}	V_{nom}	454	444	432
Measurement uncertainty		± 30 kHz		

Limits:

FCC	IC
20dB Bandwidth	
The maximum allowed 20 dB bandwidth of the hopping channel is 500 kHz.	

Result: **Passed**

9.6 Maximum Output Power Radiated

Measurement:

Measurement parameter	
Detector:	Peak
Sweep time:	Auto
Resolution bandwidth:	1 MHz
Video bandwidth:	1 MHz
Span:	5 MHz
Trace-Mode:	Max Hold

Result:

Test Conditions		EIRP [dBm]		
		904.5 MHz	915.3 MHz	926.1 MHz
T_{nom}	V_{nom}	12.19	11.42	10.93
Measurement uncertainty		± 3dB		

Limits:

FCC	IC
EIRP	
For frequency hopping systems operating in the 902–928 MHz band: 1 watt (30 dBm) for systems employing at least 50 hopping channels; and, 0.25 watts (24 dBm) for systems employing less than 50 hopping channels, but at least 25 hopping channels, as permitted under paragraph (a)(1)(i) of this section.	

Result: **Passed**

9.7 Maximum Output Power Conducted

Plot 8: Low channel

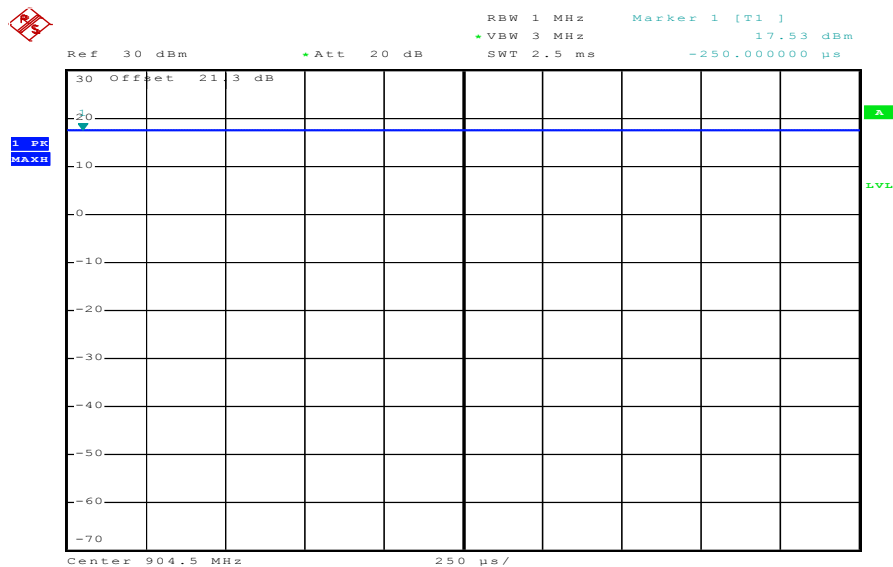

Date: 26.MAR.2012 14:05:01

Plot 9: Middle channel

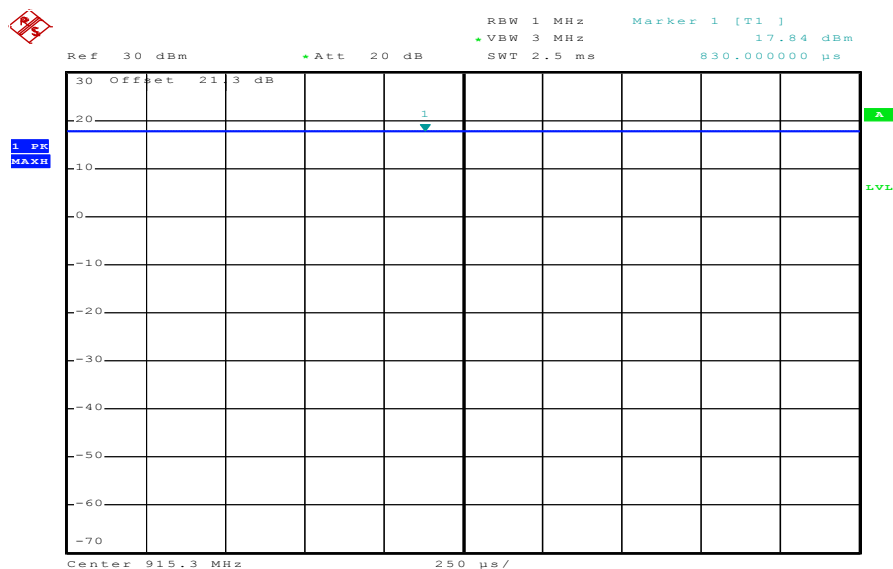

Date: 26.MAR.2012 14:06:23

Plot 10: High channel

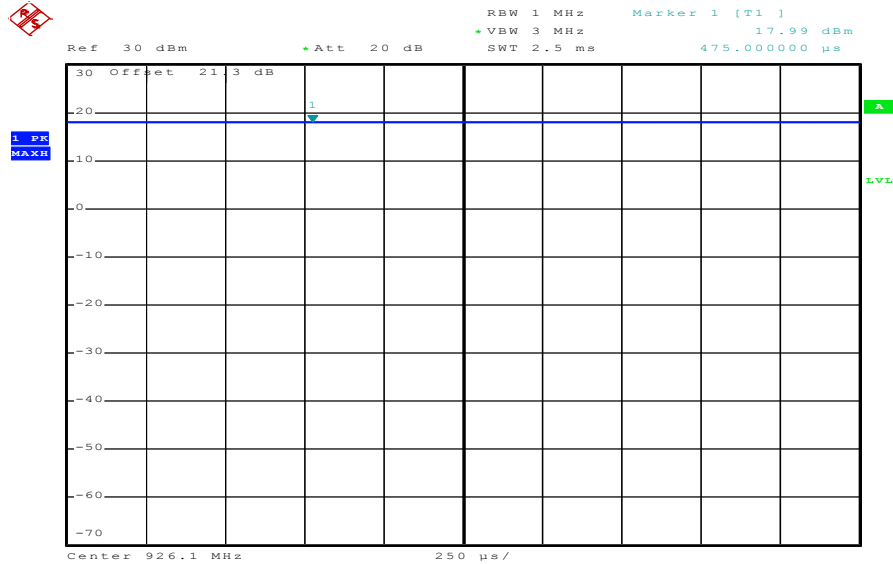

Date: 26.MAR.2012 14:07:31

Result:

Test Conditions		Maximum Output Power Conducted [dBm]		
		904.5 MHz	915.3 MHz	926.1 MHz
T _{nom}	V _{nom}	17.53	17.84	17.99
Measurement uncertainty		± 3 dB		

Limits:

FCC	IC
Maximum Output Power Conducted	
For frequency hopping systems operating in the 902–928 MHz band: 1 watt (30 dBm) for systems employing at least 50 hopping channels; and, 0.25 watts (24 dBm) for systems employing less than 50 hopping channels, but at least 25 hopping channels, as permitted under paragraph (a)(1)(i) of this section.	

Result: **Passed**

9.8 Band-edge Compliance of conducted and radiated emissions

No restricted band in the range ± 2 channel bandwidths of the Band-edges of the specified emission band! (608 MHz – 614 MHz and 960 MHz – 1240 MHz).

Section 15.205 Restricted bands of operation.

(a) Except as shown in paragraph (d) of this section, only spurious emissions are permitted in any of the frequency bands listed below:

MHz	MHz	MHz	GHz
0.090 - 0.110	16.42 - 16.423	399.9 - 410	4.5 - 5.15
¹ 0.495 - 0.505	16.69475 - 16.69525	608 - 614	5.35 - 5.46
2.1735 - 2.1905	16.80425 - 16.80475	960 - 1240	7.25 - 7.75
4.125 - 4.128	25.5 - 25.67	1300 - 1427	8.025 - 8.5
4.17725 - 4.17775	37.5 - 38.25	1435 - 1626.5	9.0 - 9.2
4.20725 - 4.20775	73 - 74.6	1645.5 - 1646.5	9.3 - 9.5
6.215 - 6.218	74.8 - 75.2	1660 - 1710	10.6 - 12.7
6.26775 - 6.26825	108 - 121.94	1718.8 - 1722.2	13.25 - 13.4
6.31175 - 6.31225	123 - 138	2200 - 2300	14.47 - 14.5
8.291 - 8.294	149.9 - 150.05	2310 - 2390	15.35 - 16.2
8.362 - 8.366	156.52475 - 156.52525	2483.5 - 2500	17.7 - 21.4
8.37625 - 8.38675	156.7 - 156.9	2690 - 2900	22.01 - 23.12
8.41425 - 8.41475	162.0125 - 167.17	3260 - 3267	23.6 - 24.0
12.29 - 12.293	167.72 - 173.2	3332 - 3339	31.2 - 31.8
12.51975 - 12.52025	240 - 285	3345.8 - 3358	36.43 - 36.5
12.57675 - 12.57725	322 - 335.4	3600 - 4400	(²)
13.36 - 13.41			

Limits:

FCC	IC
Band-edge Compliance of conducted and radiated emissions	
<p>In any 100 kHz bandwidth outside the frequency band in which the spread spectrum or digitally modulated intentional radiator is operating, the radio frequency power that is produced by the intentional radiator shall be at least 20 dB below that in the 100 kHz bandwidth within the band that contains the highest level of the desired power, based on either an RF conducted or a radiated measurement, provided the transmitter demonstrates compliance with the peak conducted power limits. If the transmitter complies with the conducted power limits based on the use of RMS averaging over a time interval, as permitted under paragraph (b)(3) of this section, the attenuation required under this paragraph shall be 30 dB instead of 20 dB. Attenuation below the general limits specified in §15.209(a) is not required. In addition, radiated emissions which fall in the restricted bands, as defined in §15.205(a), must also comply with the radiated emission limits specified in §15.209(a) (see §15.205(c)).</p>	

Result: **Passed**

9.9 Spurious Emissions Conducted (Transmitter)

Plot 11: Low channel

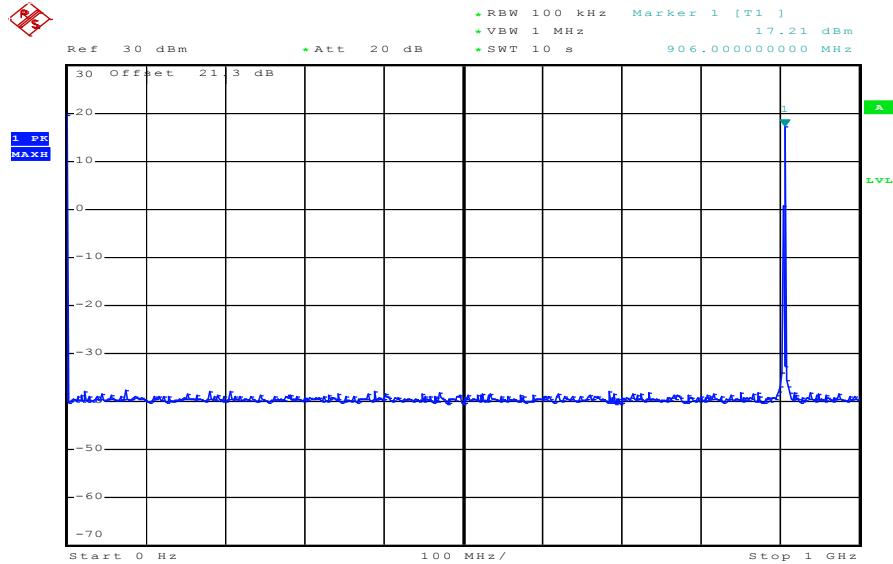

Date: 26.MAR.2012 14:12:04

Plot 12: Low channel

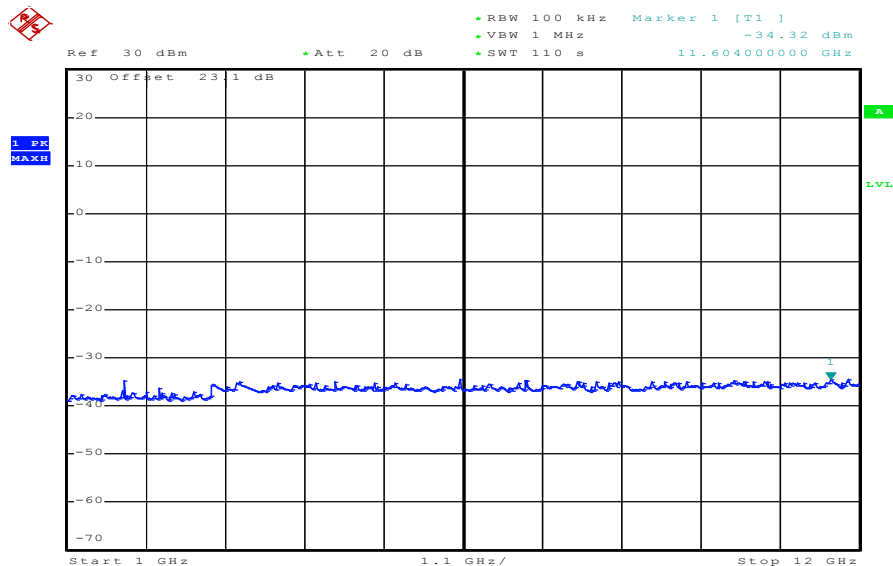

Date: 26.MAR.2012 14:30:50

Plot 13: Middle channel

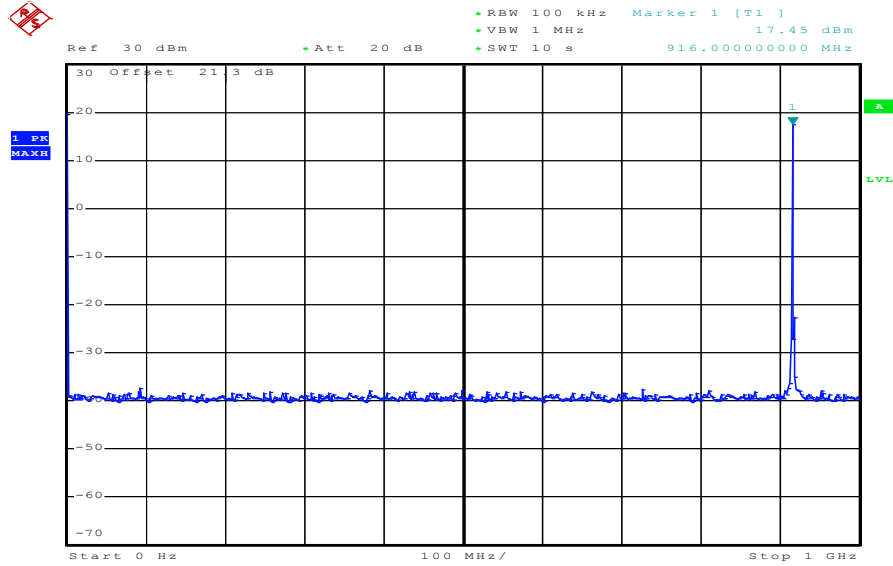

Date: 26.MAR.2012 14:10:40

Plot 14: Middle channel

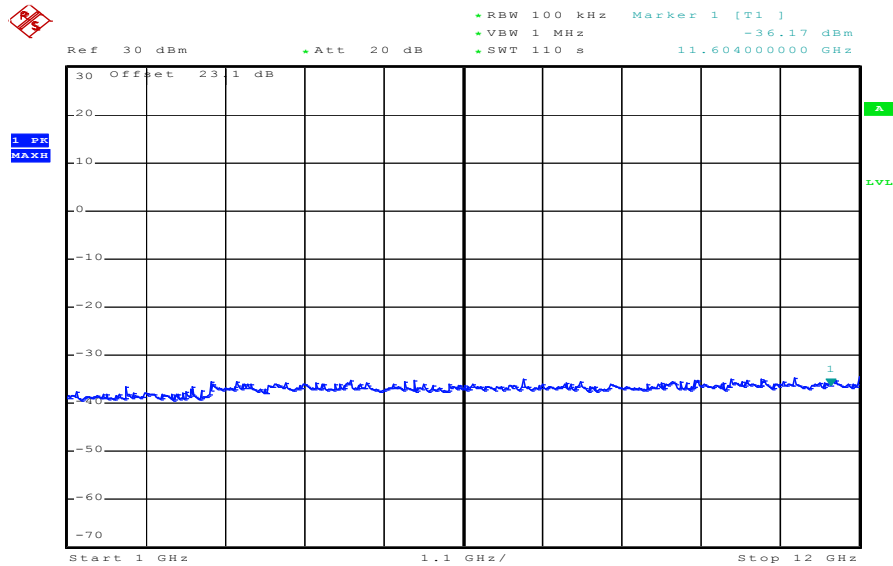

Date: 26.MAR.2012 14:35:38

Plot 15: High channel

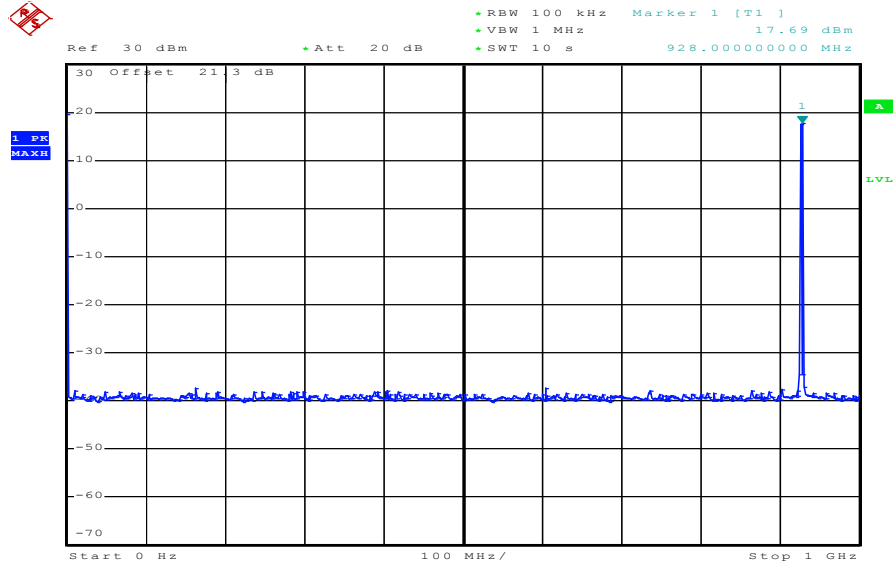

Date: 26.MAR.2012 14:09:09

Plot 16: High channel

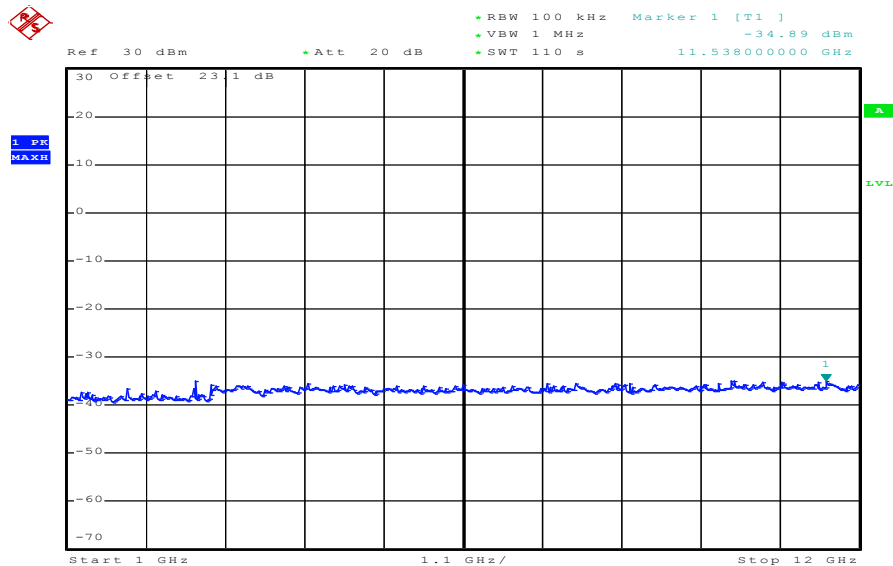

Date: 26.MAR.2012 14:40:20

Result:

Emission Limitation					
Frequency [MHz]		Amplitude of emission [dBm]	Limit max. allowed emission power	actual attenuation below frequency of operation [dB]	Results
904.5		17.21	24 dBm		Operating frequency
No critical peaks detected! All detected emissions are more than 20 dB below the limit!			-20 dBc		passed
915.3		17.45	24 dBm		Operating frequency
No critical peaks detected! All detected emissions are more than 20 dB below the limit!			-20 dBc		passed
926.1		17.69	24 dBm		Operating frequency
No critical peaks detected! All detected emissions are more than 20 dB below the limit!			-20 dBc		passed
Measurement uncertainty		± 3dB			

Limits:

FCC	IC
Spurious emissions conducted	
<p>In any 100 kHz bandwidth outside the frequency band in which the spread spectrum or digitally modulated intentional radiator is operating, the radio frequency power that is produced by the intentional radiator shall be at least 20 dB below that in the 100 kHz bandwidth within the band that contains the highest level of the desired power, based on either an RF conducted or a radiated measurement, provided the transmitter demonstrates compliance with the peak conducted power limits. If the transmitter complies with the conducted power limits based on the use of RMS averaging over a time interval, as permitted under paragraph (b)(3) of this section, the attenuation required under this paragraph shall be 30 dB instead of 20 dB. Attenuation below the general limits specified in §15.209(a) is not required. In addition, radiated emissions which fall in the restricted bands, as defined in §15.205(a), must also comply with the radiated emission limits specified in §15.209(a) (see §15.205(c)).</p>	

Result: Passed

9.10 Spurious Emissions Radiated < 30 MHz

Plot 17: TX-Mode

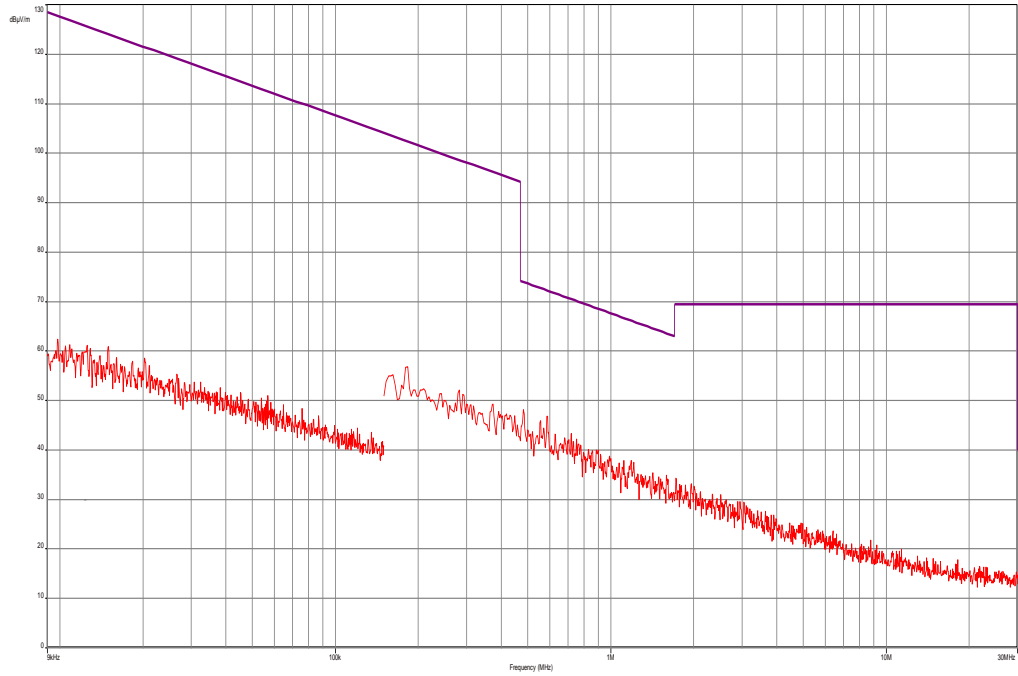

Plot 18: RX-Mode

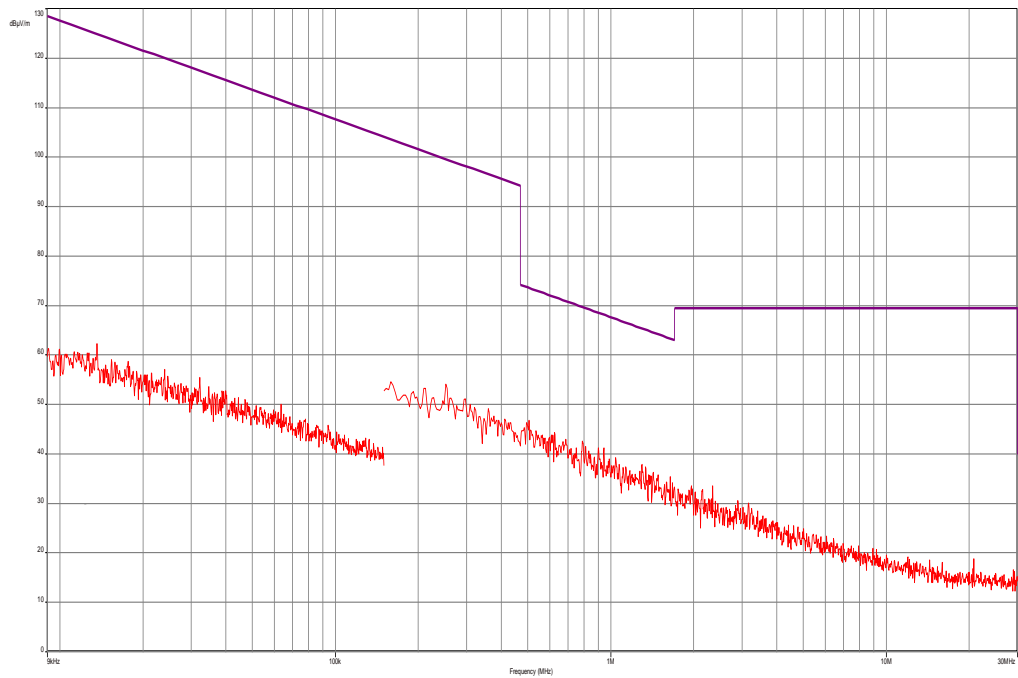

Limits:

FCC		IC
Spurious Emissions Radiated < 30 MHz		
Frequency (MHz)	Field Strength (dB μ V/m)	Measurement distance
0.009 – 0.490	2400/F(kHz)	300
0.490 – 1.705	24000/F(kHz)	30
1.705 – 30.0	30	30

Result: Passed

9.11 Spurious Emissions Radiated (Transmitter) > 30 MHz

Plot 19: 0.03 – 1 GHz, antenna vertical / horizontal (lowest channel)

Fehler! Es ist nicht möglich, durch die Bearbeitung von Feldfunktionen Objekte zu erstellen.

Plot 20: 1 – 12 GHz, antenna vertical & horizontal (lowest channel)

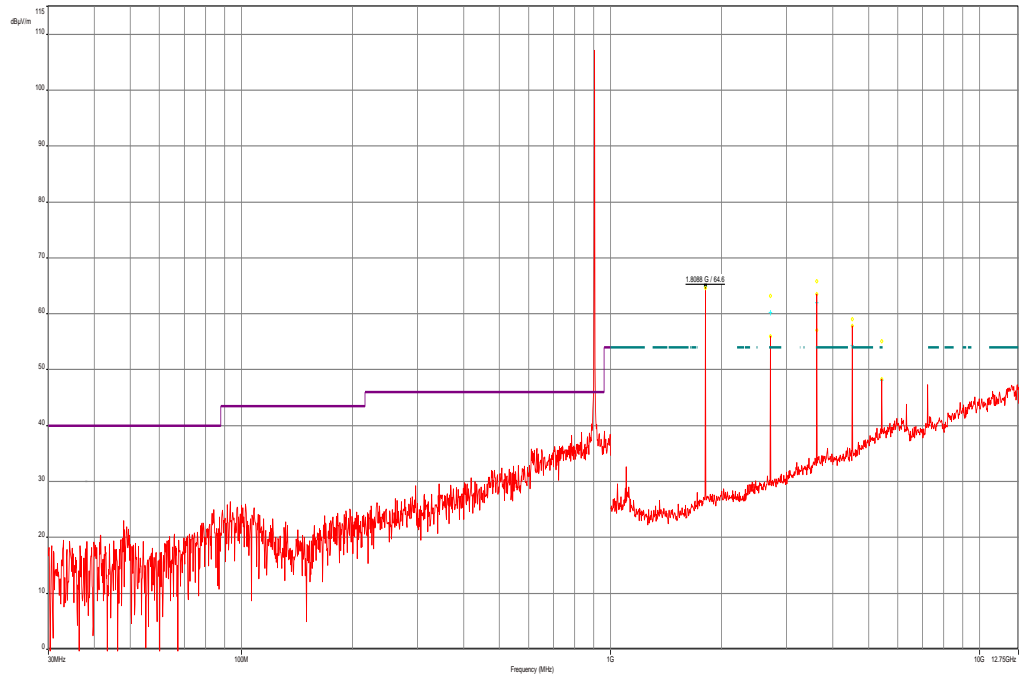

Plot 21: 0.03 – 1 GHz, antenna vertical / horizontal (middle channel)

Fehler! Es ist nicht möglich, durch die Bearbeitung von Feldfunktionen Objekte zu erstellen.

Plot 22: 1 – 12 GHz, antenna vertical & horizontal (middle channel)

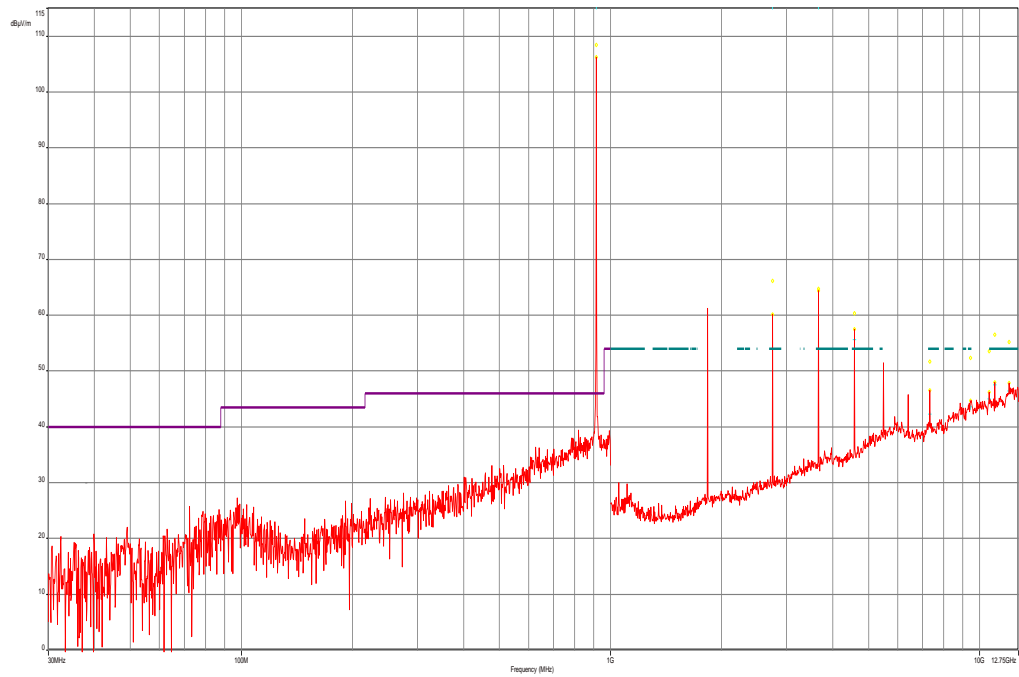

Plot 23: 0.03 – 1 GHz, antenna vertical / horizontal (highest channel)

CETECOM ICT Services GmbH

Common Information

EUT: CMA601w
 Serial Number: 43034511811A0D33
 Test Description: FCC part 15 B class B
 Operating Conditions: cont. TX Ch. 24
 Operator Name: Hennemann
 Comment: battery powered

Scan Setup: STAN_Fin [EMI radiated]

Hardware Setup: Electric Field (NOS)
 Receiver: [ESCI 3]
 Level Unit: dBµV/m

Subrange 30 MHz - 2 GHz **Step Size** 60 kHz **Detectors** QPK **IF BW** 120 kHz **Meas. Time** 1 s **Preamp** 20 dB

FCC_10m(A)_3

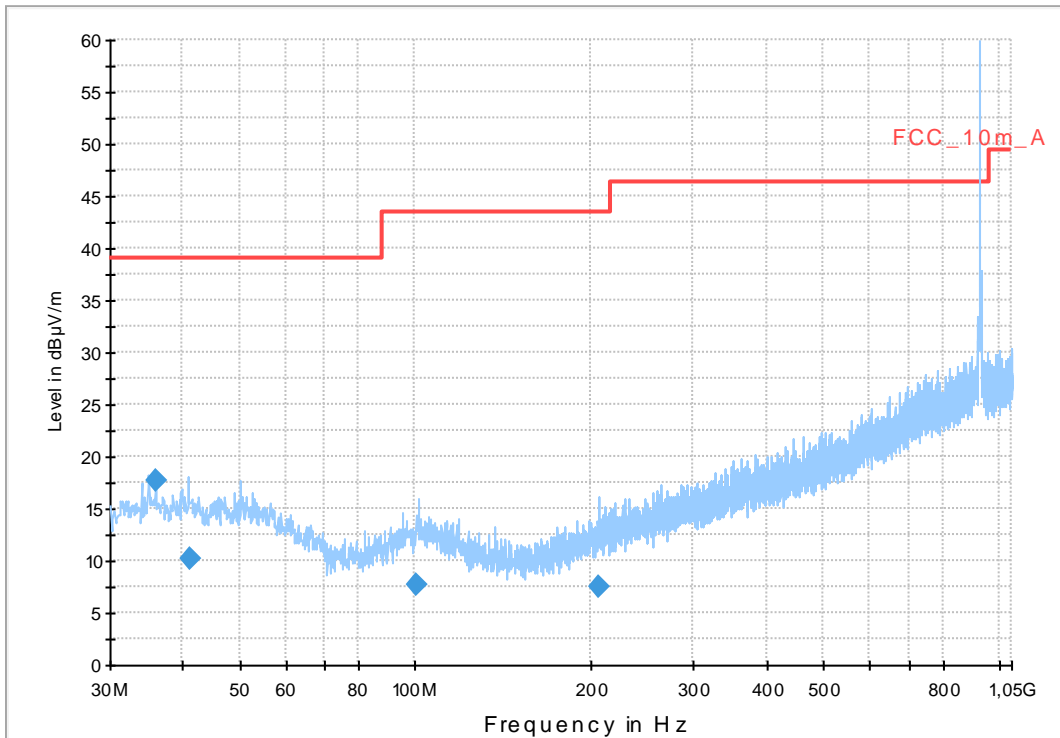

Final Result 1

Frequency (MHz)	QuasiPeak (dBµV/m)	Meas. Time (ms)	Bandwidth (kHz)	Height (cm)	Polarization	Azimuth (deg)	Corr. (dB)	Margin (dB)	Limit (dBµV/m)	Comment
36.002250	17.7	1000.0	120.000	220.0	V	48.0	13.1	21.4	39.1	
41.052150	10.2	1000.0	120.000	163.0	V	48.0	13.4	28.9	39.1	
100.758000	7.6	1000.0	120.000	220.0	H	248.0	11.8	35.9	43.5	
205.848300	7.5	1000.0	120.000	211.0	V	237.0	11.9	36.0	43.5	

Plot 24: 1 – 12 GHz, antenna vertical & horizontal (highest channel)

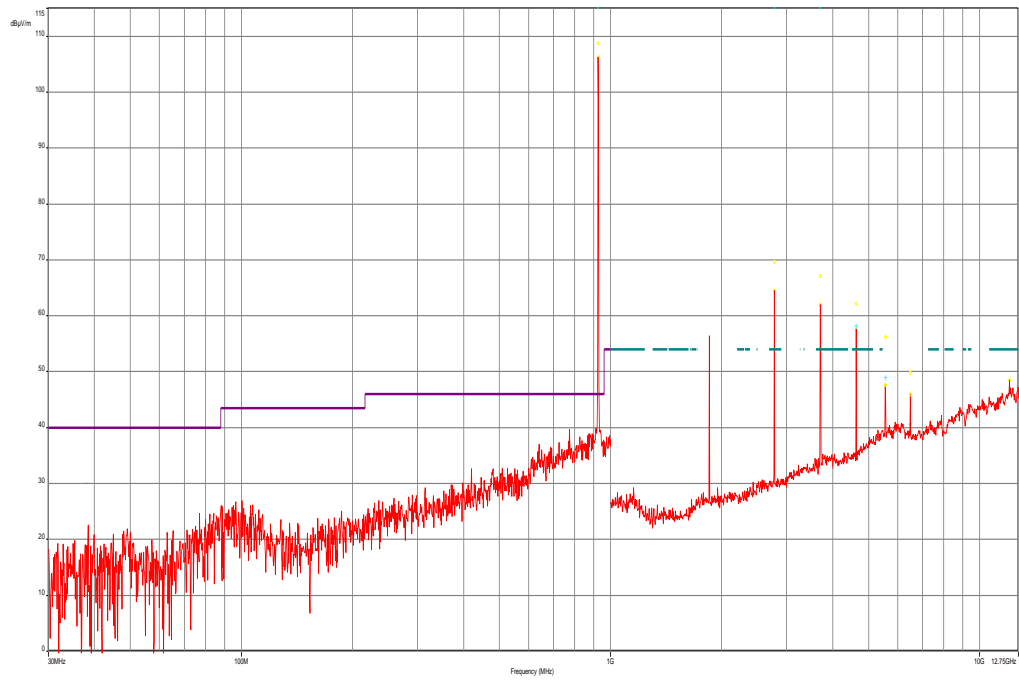

Result:

For radiated spurious emission the limits of 15.209 applies for all frequencies mentioned in 15.205. According to FCC Public Notice DA 00-705 (ANSI C63.10) the average emission shall be determined by using Video averaging (VBW = 10 Hz). If the dwell time of the hopping signal is less than 100 ms (per channel), the VBW=10 Hz reading may be adjusted by a factor:

$$F = 20 * \log (\text{dwell time} / 100 \text{ ms})$$

In a period of 100 ms, we have a maximum of 2 transmissions and that gives the correction factor for spurious measurement.

$$F = 20 * \log (2 * 2.098 / 100) = -27.54 \text{ dB}$$

Plot 25: Time slot length = 2.098 ms

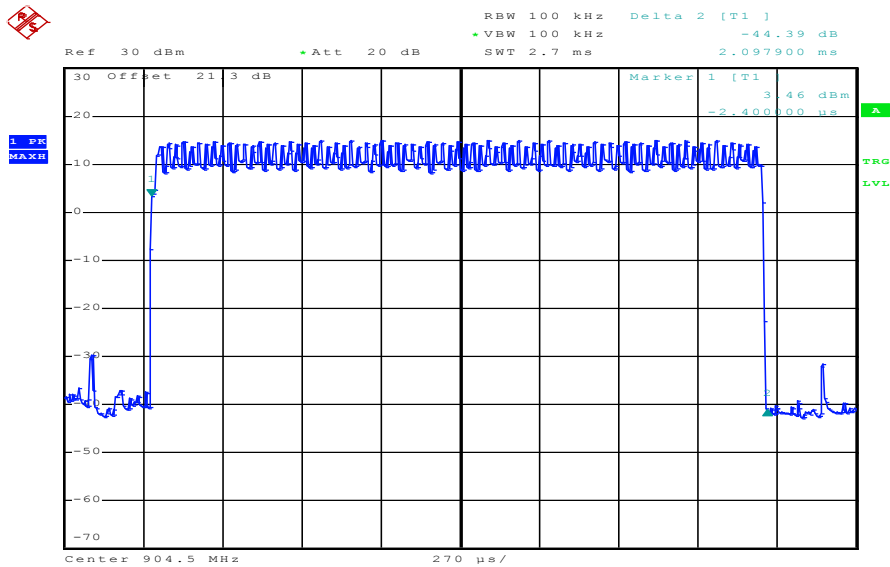

Date: 4.APR.2012 13:44:41

Plot 26: Number of hopping channels in 1s = 18

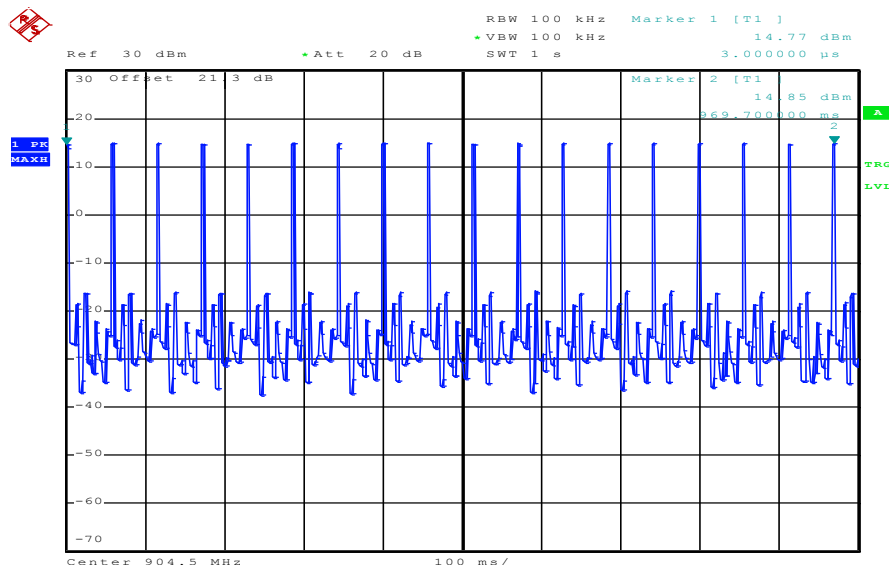

Date: 4.APR.2012 13:46:07

Result:

SPURIOUS EMISSIONS LEVEL [dBμV/m]								
904.5 MHz			915.3 MHz			926.1 MHz		
Frequency [MHz]	Detector	Level [dBμV/m]	Frequency [MHz]	Detector	Level [dBμV/m]	Frequency [MHz]	Detector	Level [dBμV/m]
1808.7	Peak	65.97	2746.3	Peak	66.12	2778.7	Peak	69.66
	AVG	38.43		AVG	38.58		AVG	42.12
2714	Peak	63.20	3661.9	Peak	64.74	3703.9	Peak	67.14
	AVG	35.66		AVG	37.20		AVG	39.60
3617.6	Peak	65.78	4575.8	Peak	60.36	4631.3	Peak	62.26
	AVG	38.24		AVG	32.82		AVG	34.72
4523.1	Peak	59.08	7321.7	Peak	51.68	5557.4	Peak	56.17
	AVG	31.54		AVG	24.14		AVG	28.63
5428.1	Peak	55.06						
	AVG	27.52						
Measurement uncertainty			±3 dB					

*AVG: Detector Average corrected with the correction factor F = -27.54 dB

All peaks above the limit line in the peak pre-scan are below the limit in AVG and Peak!

Limits:

ANSI C63.10 – FCC Public Notice DA 00-705

The average emission shall be determined by using Video averaging (VBW = 10 Hz). If the dwell time of the hopping signal is less than 100 ms (per channel), the VBW=10 Hz reading may be adjusted by a factor:
 $F = 20\log(\text{dwell time}/100 \text{ ms})$

FCC	IC	
Band-edge Compliance of conducted and radiated emissions		
<p>In any 100 kHz bandwidth outside the frequency band in which the spread spectrum or digitally modulated intentional radiator is operating, the radio frequency power that is produced by the intentional radiator shall be at least 20 dB below that in the 100 kHz bandwidth within the band that contains the highest level of the desired power, based on either an RF conducted or a radiated measurement, provided the transmitter demonstrates compliance with the peak conducted power limits. If the transmitter complies with the conducted power limits based on the use of RMS averaging over a time interval, as permitted under paragraph (b)(3) of this section, the attenuation required under this paragraph shall be 30 dB instead of 20 dB. Attenuation below the general limits specified in §15.209(a) is not required. In addition, radiated emissions which fall in the restricted bands, as defined in §15.205(a), must also comply with the radiated emission limits specified in §15.209(a) (see §15.205(c)).</p>		
Frequency (MHz)	Field Strength (dBµV/m)	Measurement distance
30 - 88	30.0	10
88 – 216	33.5	10
216 – 960	36.0	10
Above 960	54.0	3

Result: Passed

9.12 RX spurious emissions radiated

Plot 27: 0.03 – 1 GHz, antenna vertical / horizontal

CETECOM ICT Services GmbH

Common Information

EUT: CMA601w
 Serial Number: 43034511811A0D33
 Test Description: FCC part 15 B class B
 Operating Conditions: RX
 Operator Name: Hennemann
 Comment: battery powered

Scan Setup: STAN_Fin [EMI radiated]

Hardware Setup: Electric Field (NOS)
 Receiver: [ESCI 3]
 Level Unit: dBµV/m

Subrange 30 MHz - 2 GHz **Step Size** 60 kHz **Detectors** QPK **IF BW** 120 kHz **Meas. Time** 1 s **Preamp** 20 dB

FCC_10m(A)_3

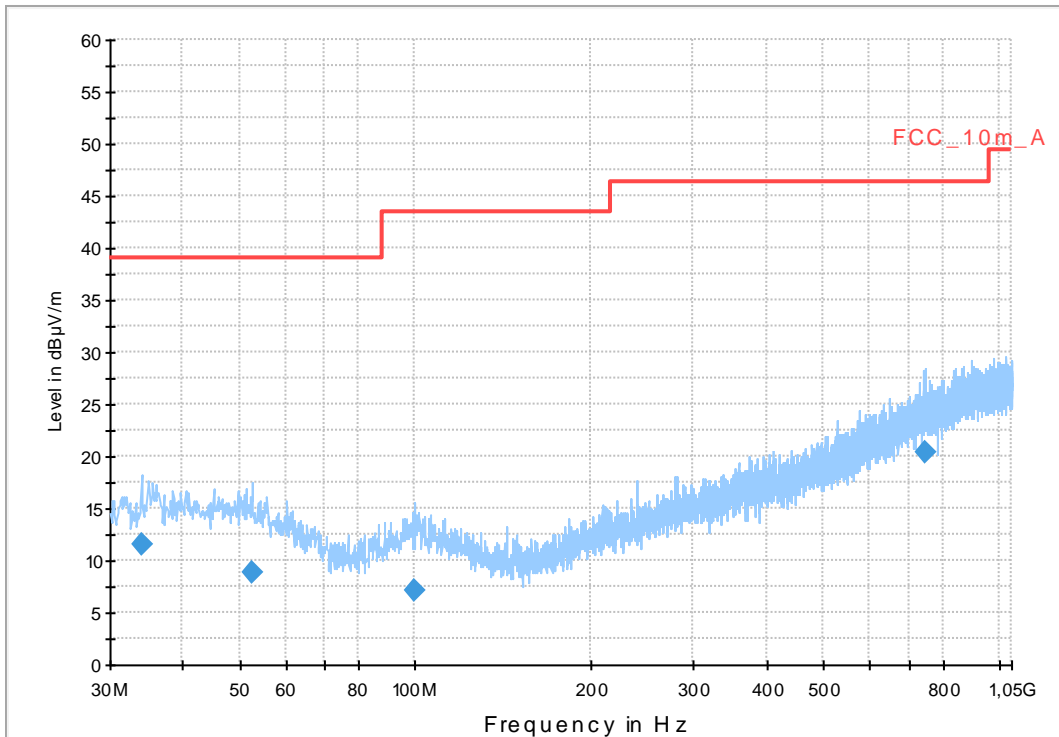

Final Result 1

Frequency (MHz)	QuasiPeak (dBµV/m)	Meas. Time (ms)	Bandwidth (kHz)	Height (cm)	Polarization	Azimuth (deg)	Corr. (dB)	Margin (dB)	Limit (dBµV/m)	Comment
34.000800	11.5	1000.0	120.000	195.0	V	142.0	12.9	27.6	39.1	
52.498500	8.9	1000.0	120.000	98.0	H	36.0	13.1	30.2	39.1	
99.701100	7.2	1000.0	120.000	220.0	V	261.0	11.9	36.3	43.5	
749.261550	20.4	1000.0	120.000	167.0	V	190.0	23.6	26.0	46.4	

Plot 28: 1 – 12 GHz, RX-Mode, antenna vertical

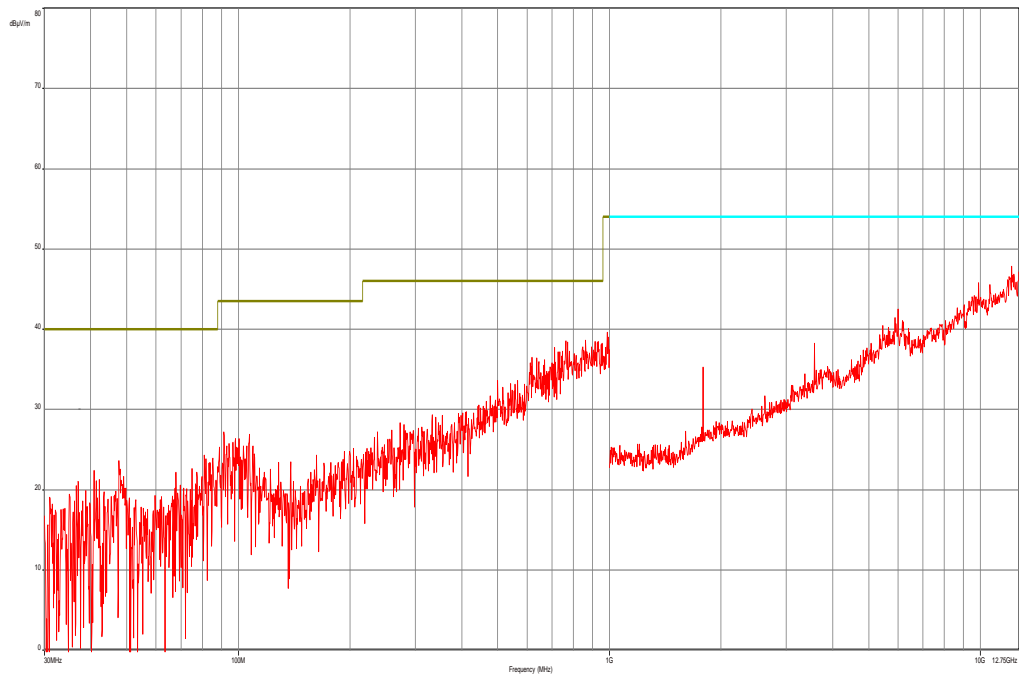

Result:

SPURIOUS EMISSIONS LEVEL [dB μ V/m]								
RX mode								
Frequency [MHz]	Detector	Level [dB μ V/m]	Frequency [MHz]	Detector	Level [dB μ V/m]	Frequency [MHz]	Detector	Level [dB μ V/m]
No critical peaks detected. All detected emissions are more than 20 dB below limit!								
Measurement uncertainty			±3 dB					

Limits:

FCC		IC
Frequency (MHz)	Field Strength (dB μ V/m)	Measurement distance
30 - 88	40	3
88 – 216	43.5	3
216 – 960	46.0	3
Above 960	54.0	3

Result: **Passed**

10 Test equipment and ancillaries used for tests

Typically, the calibrations of the test apparatus are commissioned to and performed by an accredited calibration laboratory. The calibration intervals are determined in accordance with the DIN EN ISO/IEC 17025. In addition to the external calibrations, the laboratory executes comparison measurements with other calibrated test systems or effective verifications. Weekly chamber inspections and range calibrations are performed. Where possible, rf-generating and signalling equipment as well as measuring receivers and analyzers are connected to an external high-precision 10 MHz reference (GPS-based or rubidium frequency standard).

In order to simplify the identification of the equipment used at some special tests, some items of test equipment and ancillaries can be provided with an identifier or number in the equipment list below (Labor/Item).

No.	Lab / Item	Equipment	Type	Manufact.	Serial No.	INV. No Cetecom	Kind of Calibration	Last Calibration	Next Calibration
1	45	Switch-Unit	3488A	HP Meßtechnik	2719A14505	300000368	g		
2	50	DC power supply, 60Vdc, 50A, 1200 W	6032A	HP Meßtechnik	2920A04466	300000580	ne		
3	n. a.	software	SPS_PHE 1.4f	Spitzberger & Spieß	B5981; 5D1081;B5979	300000210	ne		
4	n. a.	EMI Test Receiver	ESCI 1166.5950.03	R&S	100083	300003312	k	04.01.2012	04.01.2014
5	n. a.	Analyzer-Reference-System (Harmonics and Flicker)	ARS 16/1	SPS	A3509 07/0205	300003314	k	14.07.2011	14.07.2013
6	n. a.	Amplifier	JS42-00502650-28-5A	MITEQ	1084532	300003379	ev		
7	n. a.	Antenna Tower	Model 2175	ETS-LINDGREN	64762	300003745	izw		
8	n. a.	Positioning Controller	Model 2090	ETS-LINDGREN	64672	300003746	izw		
9	n. a.	Turntable Interface-Box	Model 105637	ETS-LINDGREN	44583	300003747	izw		
10	n. a.	TRILOG Broadband Test-Antenna 30 MHz - 3 GHz	VULB9163	Schwarzbeck	295	300003787	k		
11	n. a.	Spectrum-Analyzer	FSU26	R&S	200809	300003874	k	06.01.2012	06.01.2014
12	n. a.	Double-Ridged Waveguide Horn Antenna 1-18.0GHz	3115	EMCO	8812-3088	300001032	vIKI!	11.05.2011	11.05.2013
13	n. a.	Active Loop Antenna	6502	EMCO	2210	300001015	ne		
14	n. a.	Anechoic chamber	FAC 3/5m	MWB / TDK	87400/02	300000996		23.03.2009	
15	n. a.	Relais Matrix	3488A	HP Meßtechnik	2719A15013	300001156	ne		
16	n. a.	Relais Matrix	PSU	R&S	890167/024	300001168	ne		
17	n. a.	Three-Way Power Splitter, 50 Ohm	11850C	HP Meßtechnik		300000997	ne		
18	n. a.	Switch / Control Unit	3488A	HP	2605e08770	300001443	ne		
19	n. a.	Amplifier	js42-00502650-28-5a	Parzich GMBH	928979	300003143	ne		
20	n. a.	PSA Spectrum Analyzer 3 Hz - 26.5 GHz	E4440A	Agilent Technologies	MY48250080	300003812	k	08.09.2010	08.09.2012
21	n. a.	RF Filter Section 9kHz - 1GHz	N9039A	Agilent Technologies	MY48260003	300003825	vIKI!	08.09.2010	08.09.2012
22	n. a.	MXE EMI Receiver 20 Hz bis 26,5 GHz	N9038A	Agilent Technologies	MY51210197	3000042xx	k	19.12.2011	19.12.2012
23	n. a.	Spectrum Analyzer 9kHz to 30GHz - 140...+30dBm	FSP30	R&S	100886	300003575	k	07.09.2010	07.09.2012

Agenda: Kind of Calibration

k	calibration / calibrated	EK	limited calibration
ne	not required (k, ev, izw, zw not required)	zw	cyclical maintenance (external cyclical maintenance)
ev	periodic self verification	izw	internal cyclical maintenance
Ve	long-term stability recognized	g	blocked for accredited testing
vk!	Attention: extended calibration interval		
NK!	Attention: not calibrated	*)	next calibration ordered / currently in progress

11 Observations

No observations exceeding those reported with the single test cases have been made.

Annex A Photographs of the test setup

Photo documentation:

Photo 1:

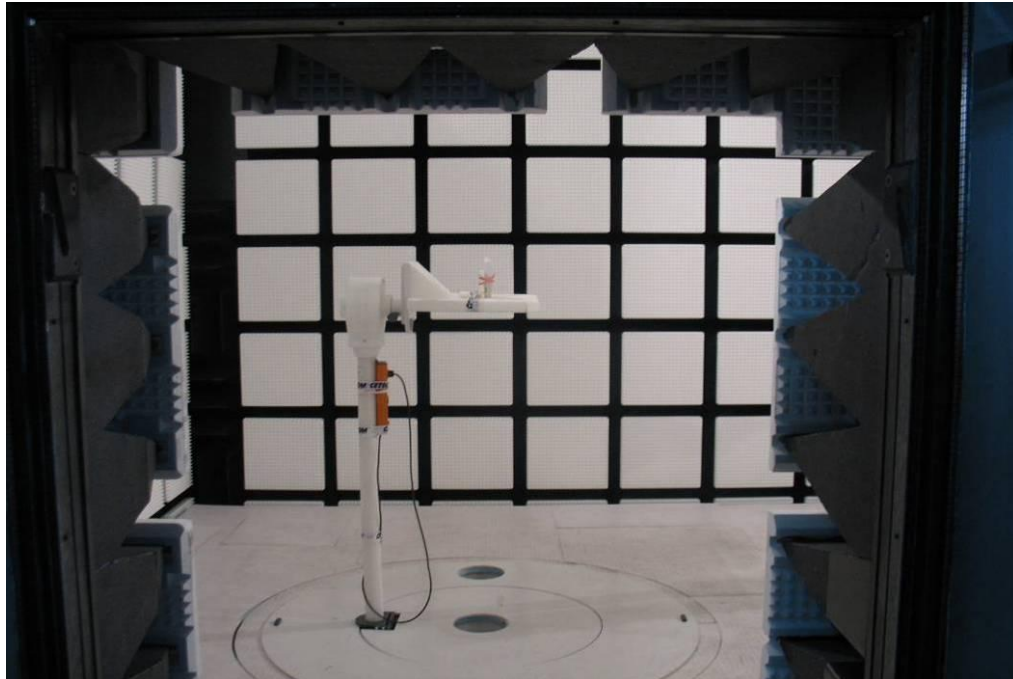

Photo 2:



Photo 3:



Photo 4:

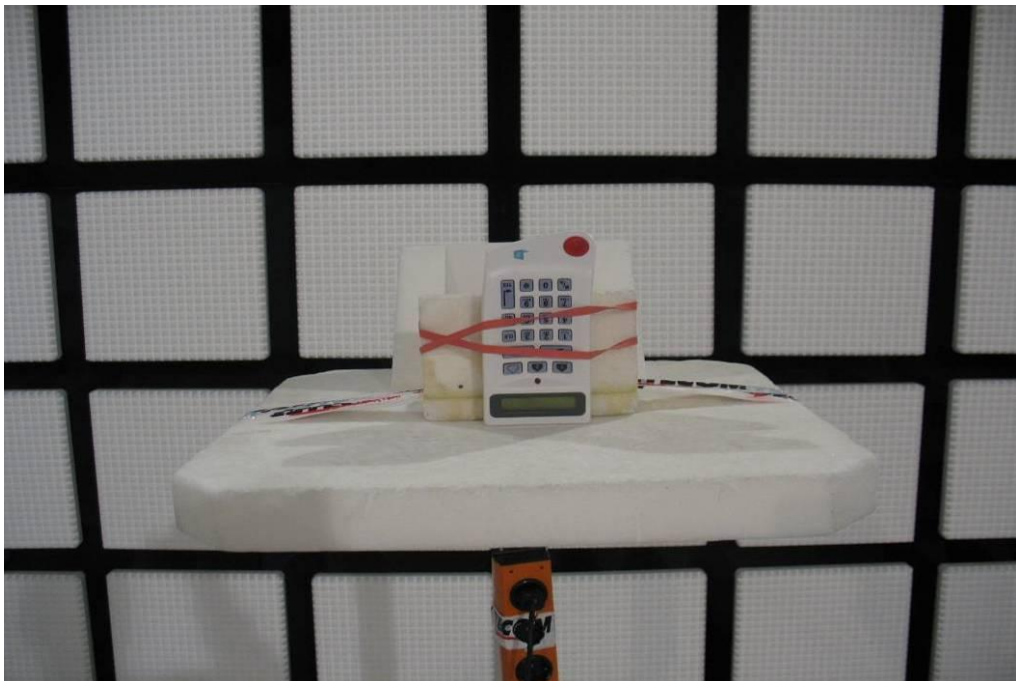

Photo 5:



Photo 6:



Photo 7:

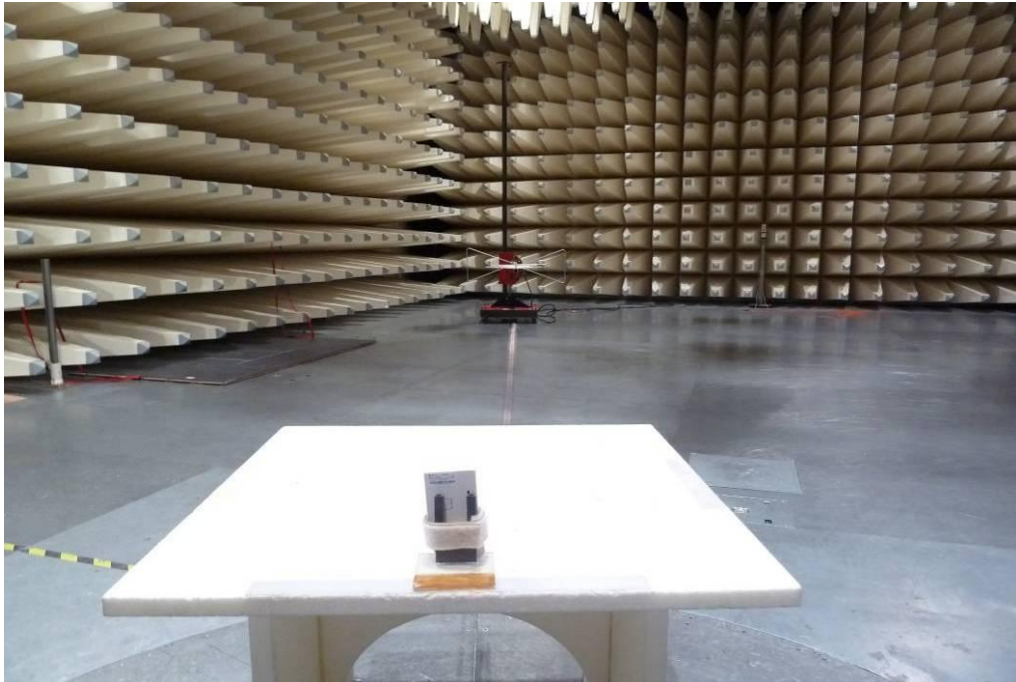

Annex B External photographs of the EUT

Photo documentation:

Photo 1:



Photo 2:



Photo 3:



Photo 4:



Photo 5:



Annex C Internal photographs of the EUT

Photo documentation:

Photo 1:



Photo 2:



Photo 3:



Photo 4:



Photo 5:



Photo 6:

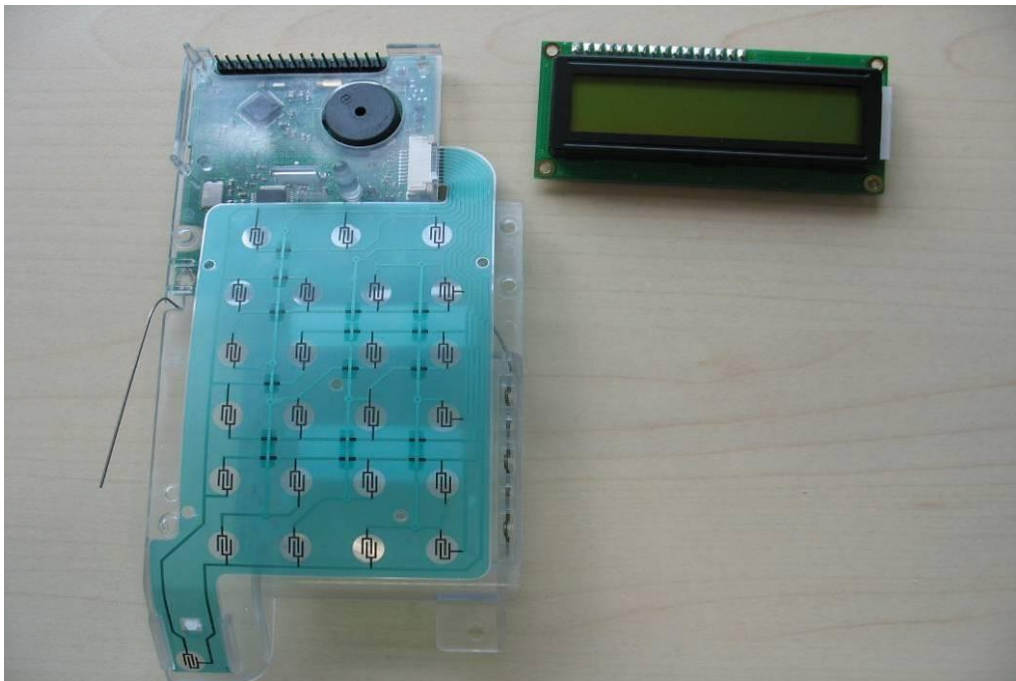

Photo 7:



Photo 8:



Photo 9:

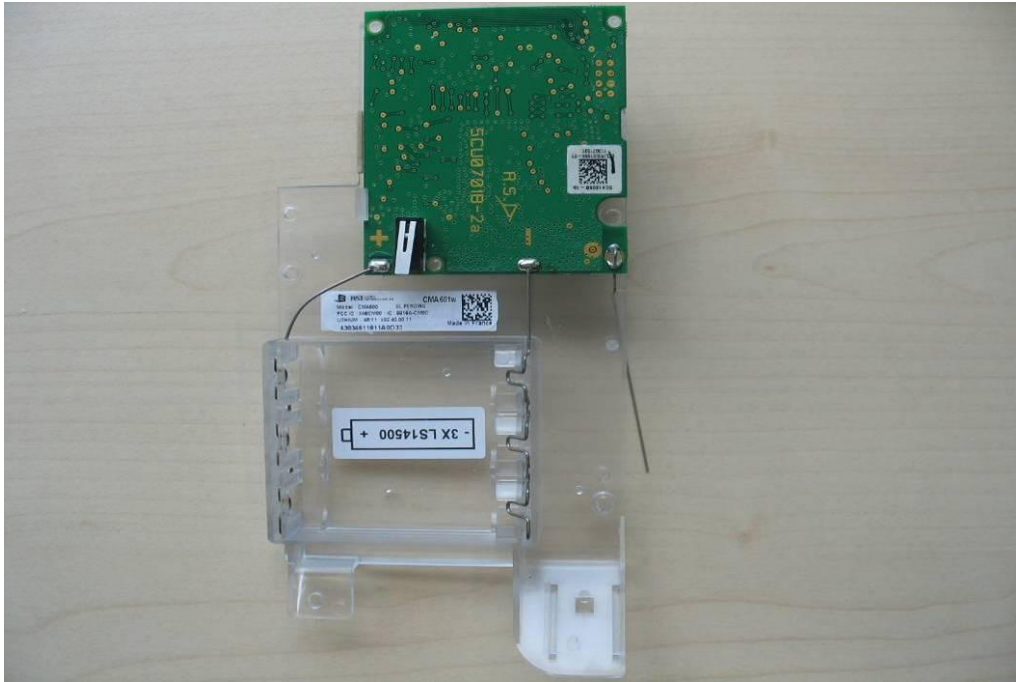
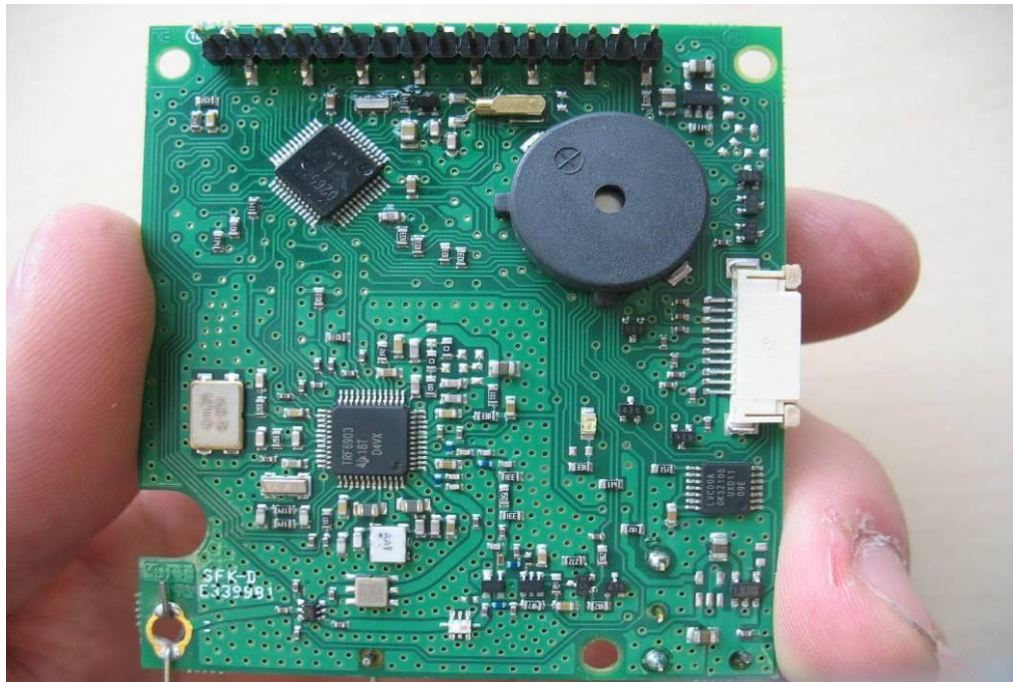

Photo 10:



Photo 11:



Annex D Document history

Version	Applied changes	Date of release
1.0	Initial release	2012-04-10

Annex E Further information**Glossary**

AVG	-	Average
DUT	-	Device under test
EMC	-	Electromagnetic Compatibility
EN	-	European Standard
EUT	-	Equipment under test
ETSI	-	European Telecommunications Standard Institute
FCC	-	Federal Communication Commission
FCC ID	-	Company Identifier at FCC
HW	-	Hardware
IC	-	Industry Canada
Inv. No.	-	Inventory number
N/A	-	Not applicable
PP	-	Positive peak
QP	-	Quasi peak
S/N	-	Serial number
SW	-	Software

Annex F Accreditation Certificate



Deutsche Akkreditierungsstelle GmbH
German Accreditation Body

Entrusted according to Section 8 subsection 1 AkkStelleG in connection with Section 1 subsection 1 AkkStelleGBV
Signatory to the Multilateral Agreements of EA, ILAC and IAF for Mutual Recognition

Accreditation



The Deutsche Akkreditierungsstelle GmbH (German Accreditation Body) attests that the testing laboratory

CETECOM ICT Services GmbH
Untertürkheimer Straße 6-10
66117 Saarbrücken

is competent under the terms of DIN EN ISO/IEC 17025:2005 to carry out tests in the following fields:

- Wired communications and DECT
- Acoustic
- Radio
- Shirt Range Devices (SRD)
- RFID
- WiMax and Richtfunk
- Mobile radio (GSM / DCS), Over the Air (OTA) Performance
- Electromagnetic Compatibility (EMC) incl. Automotive
- Product safety
- SAR and Hearing Aid Compatibility (HAC)
- Environmental simulation
- Smart Card Terminals
- Bluetooth
- Wi-Fi-Services

The accreditation certificate shall only apply in connection with the notice of accreditation of 13.04.2011 with the accreditation number D-PL-12076-01 and is valid until 03.09.2014. It comprises the cover sheet, the reverse side of the cover sheet and the following annex with a total of 82 pages.

Registration number of the certificate: **D-PL-12076-01-01**

Frankfurt am Main, 13.04.2011

Dipl.-Ing. (FH) Eger
Head of Division 2

This document is a translation. The definitive version is the original German accreditation certificate.
See annex overleaf.

Front side of certificate

Deutsche Akkreditierungsstelle GmbH

Office Berlin
Spittelmarkt 10
10117 Berlin

Office Frankfurt am Main
Gartenstraße 6
60594 Frankfurt am Main

Office Braunschweig
Bundesallee 100
38116 Braunschweig

The publication of extracts of the accreditation certificate is subject to the prior written approval by Deutsche Akkreditierungsstelle GmbH (DAKKS). Exempted is the unchanged form of separate disseminations of the cover sheet by the conformity assessment body mentioned overleaf.

No impression shall be made that the accreditation also extends to fields beyond the scope of accreditation attested by DAKKS.

The accreditation was granted pursuant to the Act on the Accreditation Body (AkkStelleG) of 31 July 2009 (Federal Law Gazette I p. 2625) and the Regulation (EC) No 765/2008 of the European Parliament and of the Council of 9 July 2008 setting out the requirements for accreditation and market surveillance relating to the marketing of products (Official Journal of the European Union L 218 of 9 July 2008, p. 30). DAKKS is a signatory to the Multilateral Agreements for Mutual Recognition of the European co-operation for Accreditation (EA), International Accreditation Forum (IAF) and International Laboratory Accreditation Cooperation (ILAC). The signatories to these agreements recognise each other's accreditations.

The up-to-date state of membership can be retrieved from the following websites:
EA: www.european-accreditation.org
ILAC: www.ilac.org
IAF: www.iaf.nu

Back side of certificate

Note:

The current certificate including annex is published on our website (see link below) or may be received from CETECOM ICT Services on request.

http://www.cetecom.com/fileadmin/de/CETECOM_D_Saarbruecken/accreditations_Jan_2010/DAKKS_Akkredi_Urk_EN17025-En_incl_Annex.pdf