



No.6, Wangjing Dong Lu, Chaoyang District, Beijing, China

EXHIBIT 2A

Class II Permissive Changes TEST REPORT

Applicant: Ericsson (China)
Communications Company Ltd

**For FCC PCII
Application on:
FCC: X3VNT1900MFRM3**

Restricted

Test Report for FCC Equipment Authorization Class 2 Permissive Change Test Report

Dataset Name: X3VNT1900MFRM3
Document Status: Approved
Stream: 01
Issue: 01
Issue Date: September 06, 2010
Author: Tamim Alkhalfah
Security Status: Ericsson Confidential

The master of this document is stored on an electronic database and is "write protected"; it may be altered only by authorized persons. While copies may be printed, it is not recommended. Viewing of the master document electronically ensures access to the current issue. Any hardcopies must be regarded as uncontrolled copies.

© 2010 Ericsson

The information disclosed herein is proprietary to Ericsson or others and is not to be used by or disclosed to unauthorized persons without the written consent of Ericsson. The recipient of this document shall respect the security status of the information.

BLANK PAGE

Table of Contents

PUBLICATION HISTORY.....	6
REVISION HISTORY.....	6
LIST OF CONSULTANTS.....	7
DECISION MAKER.....	7
DECISION RATIFIER	7
ACRONYMS AND ABBREVIATIONS.....	8
1. INTRODUCTION.....	9
1.1. REQUIRED TESTS.....	9
2. ENGINEERING DECLARATION.....	10
3. EQUIPMENT AUTHORIZATION APPLICATION REQUIREMENTS.....	11
3.1. STANDARD TEST CONDITIONS AND TEST EQUIPMENT	11
3.2. EUT IDENTIFICATION LIST.....	11
3.3. TEST EQUIPMENT LIST	11
4. TRANSMITTER TESTS	12
4.1. RF POWER OUTPUT.....	12
4.1.1 RF Power Output Requirements	12
4.1.2 Test Method	12
4.1.3 Test Setup.....	12
4.1.4 RF Output Power Test Results.....	13
4.2. OCCUPIED BANDWIDTH	13
4.2.1 Occupied Bandwidth Requirements.....	13
4.2.2 Test Method	14

4.2.3 Test Setup.....	14
4.2.4 Occupied Bandwidth Test Results.....	15
4.3. SPURIOUS EMISSIONS AT ANTENNA TERMINALS.....	18
4.3.1 Spurious Emissions Requirements	18
4.3.2 Test Method	19
4.3.3 Test Setup.....	21
4.3.4 Spurious Emissions Test Results.....	21
4.4. FREQUENCY STABILITY.....	22
4.4.1 Frequency Stability Requirements	22
4.4.2 Test Method	23
4.4.3 Frequency Stability Test Results.....	23
REFERENCES	24
APPENDIX (EMISSIONS SCREENSHOTS)	25

List of Figures

FIGURE 1: POWER TEST BLOCK DIAGRAM	12
FIGURE 2: OCCUPIED BANDWIDTH TEST SETUP	14
FIGURE 3: OCCUPIED BANDWIDTH, 1 CARRIER, CHANNEL 1225.....	15
FIGURE 4: OCCUPIED BANDWIDTH, 1 CARRIER, CHANNEL 1275.....	16
FIGURE 5: OCCUPIED BANDWIDTH, 2 CARRIERS, CHANNEL 1225, 1250	17
FIGURE 6: OCCUPIED BANDWIDTH, 3 CARRIERS, CHANNEL 1225, 1250, 1275.....	18
FIGURE 7: SPURIOUS EMISSIONS -1 CARRIER -CHANNEL 1225, 9 kHz TO LOWER ADJACENT 1 MHz	26
FIGURE 8: SPURIOUS EMISSIONS -1 CARRIER -CHANNEL 1225, 9 kHz TO LOWER ADJACENT 1 MHz (VERIFICATION).....	27
FIGURE 9: SPURIOUS EMISSIONS -1 CARRIER -CHANNEL 1225, LOWER ADJACENT 1 MHz.....	28
FIGURE 10: SPURIOUS EMISSIONS -1 CARRIER -CHANNEL 1275, UPPER ADJACENT 1 MHz	29
FIGURE 11: SPURIOUS EMISSIONS -1 CARRIER -CHANNEL 1275, UPPER ADJACENT 1 MHz TO 5 GHz.....	30
FIGURE 12: SPURIOUS EMISSIONS -1 CARRIER -CHANNEL 1275, UPPER ADJACENT 1 MHz TO 5 GHz (VERIFICATION).....	31
FIGURE 13: SPURIOUS EMISSIONS -1 CARRIER -CHANNEL 1275, 5 GHz TO 22 GHz.....	32
FIGURE 14: SPURIOUS EMISSIONS -2 CARRIERS -CHANNEL 1225, 1250, 9 kHz TO LOWER ADJACENT 1 MHz	33
FIGURE 15: SPURIOUS EMISSIONS -2 CARRIERS -CHANNEL 1225, 1250, 9 kHz TO LOWER ADJACENT 1 MHz (VERIFICATION).....	34
FIGURE 16: SPURIOUS EMISSIONS -2 CARRIERS -CHANNEL 1225, 1250, LOWER ADJACENT 1 MHz	35
FIGURE 17: SPURIOUS EMISSIONS -2 CARRIERS -CHANNEL 1250, 1275, UPPER ADJACENT 1 MHz.....	36
FIGURE 18: SPURIOUS EMISSIONS -2 CARRIERS -CHANNEL 1250, 1275, UPPER ADJACENT 1 MHz TO 5 GHz	37
FIGURE 19: SPURIOUS EMISSIONS -2 CARRIERS -CHANNEL 1250, 1275, UPPER ADJACENT 1 MHz TO 5 GHz (VERIFICATION).....	38
FIGURE 20: SPURIOUS EMISSIONS -2 CARRIERS -CHANNEL 1250, 1275, 5 GHz TO 22 GHz	39
FIGURE 21: SPURIOUS EMISSIONS -3 CARRIERS -CHANNEL 1225, 1250, 1275, 9 kHz TO LOWER ADJACENT 1 MHz.....	40
FIGURE 22: SPURIOUS EMISSIONS -3 CARRIERS -CHANNEL 1225, 1250, 1275, 9 kHz TO LOWER ADJACENT 1 MHz (VERIFICATION).....	41
FIGURE 23: SPURIOUS EMISSIONS -3 CARRIERS -CHANNEL 1225, 1250, 1275, LOWER ADJACENT 1 MHz..	42
FIGURE 24: SPURIOUS EMISSIONS -3 CARRIERS -CHANNEL 1225, 1250, 1275, UPPER ADJACENT 1 MHz..	43
FIGURE 25: SPURIOUS EMISSIONS -3 CARRIERS -CHANNEL 1225, 1250, 1275, UPPER ADJACENT 1 MHz TO 5 GHz.....	44
FIGURE 26: SPURIOUS EMISSIONS -3 CARRIERS -CHANNEL 1225, 1250, 1275, UPPER ADJACENT 1 MHz TO 5 GHz (VERIFICATION)	45
FIGURE 27: SPURIOUS EMISSIONS -3 CARRIERS -CHANNEL 1225, 1250, 1275, 5 GHz TO 22 GHz.....	46

List of Tables

TABLE 1 :REVISION HISTORY.....	6
TABLE 2 :LIST OF CONSULTANTS	7
TABLE 3 :DECISION MAKER TABLE.....	7
TABLE 4 :DECISION RATIFIER TABLE.....	7
TABLE 5 :REQUIRED TESTS	9
TABLE 6 :EUT IDENTIFICATION	11
TABLE 7 :TEST EQUIPMENT TABLE	11
TABLE 8 :RF OUTPUT POWER FOR THE 1900 MFRM-3 IN A 1 CARRIER CONFIGURATION	13
TABLE 9 :RF OUTPUT POWER FOR THE 1900 MFRM-3 IN A 2 CARRIER CONFIGURATION	13
TABLE 10 :RF OUTPUT POWER FOR THE 1900 MFRM-3 IN A 3 CARRIER CONFIGURATION	13
TABLE 11 :OCCUPIED BANDWIDTH RESULTS FOR A 1 CARRIER CONFIGURATION.....	15
TABLE 12 :OCCUPIED BANDWIDTH RESULTS FOR A 2 CARRIER CONFIGURATION.....	15
TABLE 13 :OCCUPIED BANDWIDTH RESULTS FOR A 3 CARRIER CONFIGURATION.....	15
TABLE 14 :SPECTRUM ANALYZER NOISE FLOOR	19
TABLE 15 :SPECTRUM ANALYZER SETTINGS FOR ADJACENT 1 MHz MEASUREMENTS	20
TABLE 16 :SPECTRUM ANALYZER SETTINGS FOR EMISSIONS UP TO 5 GHz	20
TABLE 17 :SPECTRUM ANALYZER SETTINGS FOR EMISSIONS BETWEEN 5 GHz AND 22 GHz	20
TABLE 18 :EMISSIONS MEASUREMENTS FOR 1 CARRIER.....	21
TABLE 19 :EMISSIONS MEASUREMENTS FOR 2 CARRIERS	21
TABLE 20 :EMISSIONS MEASUREMENTS FOR 3 CARRIERS	21
TABLE 21 :OVER VOLTAGE FREQUENCY STABILITY MEASUREMENTS.....	23
TABLE 22 :OVER TEMPERATURE FREQUENCY STABILITY MEASUREMENTS.....	23

Publication History

The latest controlled release of this document is located in Livelink at the following location:

<http://livelink-ott.ca.nortel.com/livelink/livelink.exe?func=ll&objId=30579406&objAction=browse&sort=name&viewType=1>

All other soft and hard copies are uncontrolled. It is the responsibility of the reader to ensure that the latest release of this document is being used.

Revision History

Table 1: Revision History

Stream/Issue	Revision Date	Reason for Change	Author
00/01	September 06, 2010	Document Created	Tamim Alkhalifah
00/02	September 06, 2010	Test Results Added	Tamim Alkhalifah
00/03	September 06, 2010	Screenshots Added	Tamim Alkhalifah
00/04	September 06, 2010	<ul style="list-style-type: none">• Add Dataset name to the document.• Add the document's livelink location.• Add specs and limits to the required tests table.• Add an area in the Engineering Declaration section for sign off• Update Decision maker name• Add PECs of the M3 and other equipment to the EUT table• Replace the OBW plot for 3carriers by one with the correct RBW• Add the noise floor of the PSA to the table.	Tamim Alkhalifah
00/05	September 06, 2010	Minor Changes based on regulatory prime feedback	Tamim Alkhalifah
01/00	September 06, 2010	Document approved	Tamim Alkhalifah

List of Consultants

Table 2: List of Consultants

Name	Function	Department
Rahim Nathoo	System Prime	2M40
Igor Acimovic	Systems Design	2M40
Radu Trandafir	SPIR (Safety, Product Integrity and Regulatory) team leader	2M
Mark Willetts	Systems Manager	2M40
Hossein Yektaii	Systems Design	2M40
Marin Sampaleanu	Regulatory Prime	2U20

Decision Maker

Table 3: Decision Maker Table

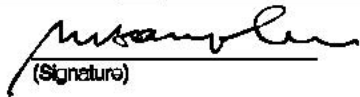
Name	Signature	Date
Marin Sampaleanu	 (Signature)	September 30, 2008

Decision Ratifier

Table 4: Decision Ratifier Table

Name	Signature	Date
Radu Trandafir		

Acronyms and Abbreviations

ASIC	Application Specific Integrated Circuit
AWS	Advanced Wireless Service
BBW	Breathing, Blossoming and Wilting
BPF	Bandpass Filter
BTS	Base Station Transceiver Subsystem
BW	Bandwidth
CDMA	Code Division Multiple Access
CR	Cost Reduced
dBFS	dB relative to Full Scale
DDS	Direct Digital Synthesizer
DPM	Duplexer Preselector Module
EEPROM	Electrically Erasable and Programmable ROM
EC	Engineering Change
ERLCE	Excess Reverse Link Capacity Estimate
HSSPC	High-Speed Serial Protocol Controller
HW	Hardware
IF	Intermediate Frequency
IIC	Inter-Integrated Circuit Bus
IS	Interim Standard
LO	Local Oscillator
LPF	Lowpass Filter
MFRM-3	Multi-Carrier Flexible Radio Module
NF	Noise Figure
OCNS	Orthogonal Channel Noise Source
OH	OverHead
PA	Power Amplifier
PC	Personal Computer
PPR	Peak Power Reduction
PSA	Product Specification Agreement
RBW	Resolution BandWidth
RF	Radio Frequency
Rx	Receive
SA	Spectrum Analyzer
SFRM	Single Carrier Flexible Radio Module
SW	Software
TBD	To Be Determined
TDM	Tri-sector Duplexer Module
TM	Triplexer Module
TPTL	Transmit Power Tracking Loop
TRM	Transmitter Receiver Module
Tx	Transmit

1. Introduction

The 1900 MHz MFRM-3 was previously certified to operate in the A, B, C, D, E, and F blocks of the PCS band. This test report supports a Class 2 Permissive Change FCC filing for the 1900 MHz MFRM-3 operating in the G Block of the PCS band. This filing includes single, two, and three carrier modes for band class 14. The following tests were performed: RF Power Output, Occupied Bandwidth, Spurious Emissions at Antenna Terminals, and Transmitter Test (CDMA Mode Transmitter). Over voltage and temperature Frequency Stability test results are included. Power, Emissions, and Occupied Bandwidth tests were conducted at -48 VDC at room temperature.

The 1900 MFRM-3 was tested at Channels 1225, 1250, 1275 (valid channels in the G Block spectrum). In addition to that, the Power Test was conducted for channels in the previously tested blocks. The channels tested were 25, 50, 75, as well as 425, 450, 475 and 825, 850, 875.

This test report will be submitted in accordance with the FCC Rules and Regulations, Part 2, Subpart J, Sections 2.1046 through 2.1057 for equipment authorization of Ericsson's CDMA 1900 MFRM-3 operating in band class 14.

The 1900 MFRM-3 is intended for use in the Domestic Public Cellular Radio Telecommunications Service and is designed in accordance with the following standards:

- *CFR 47, Part 24, Subpart E, Broadband Personal Communications Systems [1]*
- *CFR 47, Part 2, Subpart J, Equipment Authorization Procedures - Equipment Authorization [2]*
- *TIA/EIA-97-E, Recommended Minimum Performance Standards for Base Stations Supporting Dual Mode Spread Spectrum Systems [3]*

1.1. Required Tests

The table below summarizes the required tests for the 1900 MFRM-3 operating in band class 14.

Table 5: Required Tests

FCC Measurement Spec	FCC Limit Specification	Description	Test to be Performed?
2.1046		RF Output Power	Yes
2.1049		Occupied Bandwidth	Yes
2.1051, 2.1057	24.238	Spurious Emissions at Antenna Terminals	Yes
2.1053, 2.1057		Field Strength of Spurious Emissions	No
2.1055	24.235	Frequency Stability	Yes

2. Engineering Declaration

The 1900 MFRM-3 has been tested in accordance with the requirements contained in the Federal Communications Commission Rules and Regulations Part 2 and 24. To the best of my knowledge, these tests were performed in accordance with good engineering practices using measurement procedures consistent with industry or commission standards or previous Commission correspondence or guidance and demonstrate that this equipment complies with the appropriate standards. All tests were conducted on a representative sample of the equipment for which equipment authorization is sought.

Marin Sampaleanu, FCC Regulatory Prime

Name

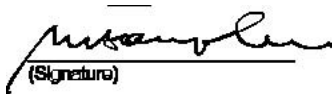

(Signature)

Date: September 06, 2010

3. Equipment Authorization Application Requirements

3.1. Standard Test Conditions and Test Equipment

The 1900 MFRM-3 was tested under the following standard test conditions unless otherwise noted:

Ambient
Temperature: 20 to 35 degrees C
Ambient Humidity: 20 to 40%
DC Supply Voltage: -48 VDC (nominal)
Input modulation: IS-95

3.2. EUT Identification List

The following table shows the components of the system required for the tests.

Table 6: EUT Identification

Equipment Description	Model / Part Number	Release Number	Serial Number
1900 MFRM-3	NTGZ70BA	03	NNTMEEJ0107Y
G Block Triplexer Module	NTGS5414	P1	ACET01000643
XCEM_192 Modem	NTRZ80BA	50	NNTM74X194G4

3.3. Test Equipment List

The following table shows the measurement equipment information.

Table 7: Test Equipment Table

Description	Manufacturer	Model	Serial Number	Cal Due Date
3 Hz - 26.5 GHz PSA Series Spectrum Analyzer	Agilent	E4440A	MY46187461	25-Dec-08
RF Power Meter	Agilent	438A	3513U04169	15-Feb-09
RF Power Sensor Head	Agilent	8482A	MY41093304	25-Sep-08
30dB Attenuator (>100W)				
RF Cables				

4. Transmitter Tests

4.1. RF Power Output

4.1.1 RF Power Output Requirements

FCC Part 2.1046

(a) For transmitters other than single sideband, independent sideband and controlled carrier radiotelephone, power output shall be measured at the RF output terminals when the transmitter is adjusted in accordance with the tune-up procedure to give the values of current and voltage on the circuit elements specified in Sec. 2.1033(c)(8). The electrical characteristics of the radio frequency load attached to the output terminals when this test is made shall be stated.

4.1.2 Test Method

Setup the 1900 MFRM-3 to transmit at the rated power for each of the carrier configurations for all three sectors. Measurements were made on channels ranging from the bottom to the top of the operator PCS band (including G Block) with the 1900 MFRM-3 operating with -48VDC. The RF output power was measured using the power meter at the sector's output. The measured power was maintained within +/- 0.25 dB

4.1.3 Test Setup

The set-up required for the 1900 MFRM-3 RF output power test is illustrated in Figure 1. RF output power measurements were referenced to the sector antenna port of the Triplexer Module.

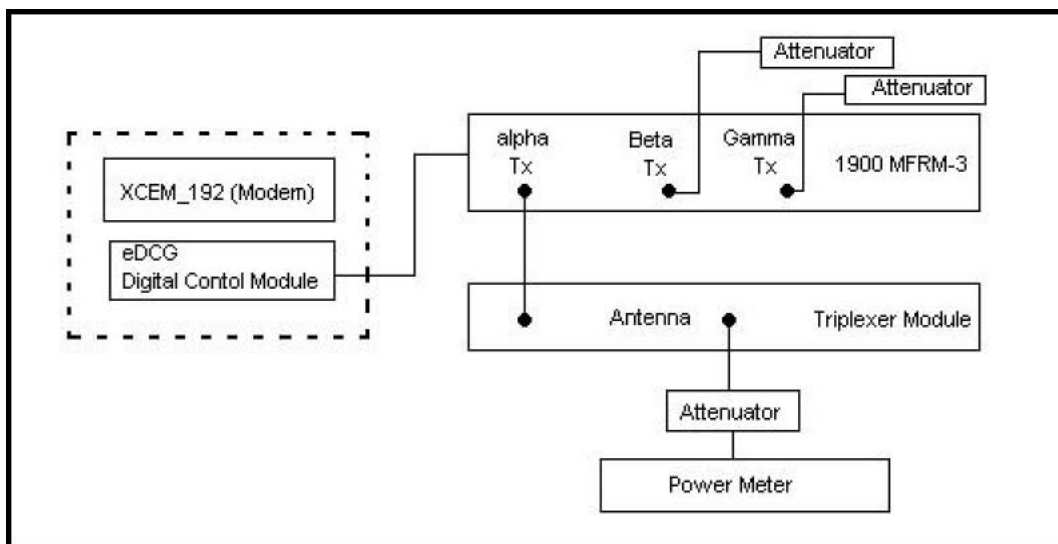

Figure 1: Power Test Block Diagram

4.1.4 RF Output Power Test Results

Below are the results of the Output Power test.

Table 8: RF Output Power for the 1900 MFRM-3 in a 1 Carrier Configuration

Channel Number	Frequency (MHz)	Measured RF Power (dBm)	Max. Typical Rated Power (dBm)
25	1931.25	48.60	48.80
875	1973.75	48.70	48.80
1225 ¹	1991.25	48.80	48.80
1250	1992.50	48.66	48.80
1275	1993.75	48.90	48.80

Table 9: RF Output Power for the 1900 MFRM-3 in a 2 Carrier Configuration

Channel Number	Frequency (MHz)	Measured RF Power (dBm)	Max. Typical Rated Power (dBm)
25, 50	1931.25, 1932.50	48.85	48.80
850, 875	1972.5, 1973.75	48.70	48.80
1225, 1250	1991.25, 1992.50	48.60	48.80

Table 10: RF Output Power for the 1900 MFRM-3 in a 3 Carrier Configuration

Channel Number	Frequency (MHz)	Measured RF Power (dBm)	Max. Typical Rated Power (dBm)
25, 50, 75	1931.25, 1932.50, 1933.75	48.70	48.80
425, 450, 475	1951.25, 1952.50, 1953.75	48.80	48.80
825, 850, 875	1971.25, 1972.50, 1973.75	48.87	48.80
1225, 1250, 1275	1991.25, 1992.50, 1993.75	48.75	48.80

4.2. Occupied Bandwidth

4.2.1 Occupied Bandwidth Requirements

FCC Part 2.1049

The OBW, that is the frequency bandwidth such that, below its lower and above its upper frequency limits, the mean powers radiated are each equal to

¹ Channels 1225, 1250, and 1275 are part of the G Block (band class 14)

0.5 percent of the total mean power radiated by a given emission shall be measured under the following conditions as applicable:

(g) Transmitter in which the modulating baseband comprises not more than three independent channels - when modulated by the full complement of signals for which the transmitter is rated. The level of modulation for each channel should be set to that prescribed in rule parts applicable to the services for which the transmitter is intended. If specific modulation levels are not set forth in the rules, the tests should provide the manufacturer's maximum rated condition.

(h) Transmitters employing digital modulation techniques - when modulated by an input signal such that its amplitude and symbol rate represent the maximum rated conditions under which the equipment will be operated. The signal shall be applied through any filter networks, pseudo-random generators or other devices required in normal service. Additionally, the occupied bandwidth shall be shown for operation with any devices used for modifying the spectrum when such devices are optional at discretion of the user.

4.2.2 Test Method

Setup the BTS controller to enable the 1900 MFRM-3 to transmit at maximum rated power for each of the carrier configurations. Measurements were made on channels at the G Block Band.

The Occupied Bandwidth was measured using the 99% channel power feature of the spectrum analyzer.

4.2.3 Test Setup

The test setup required for the occupied bandwidth measurement is illustrated in Figure 2.

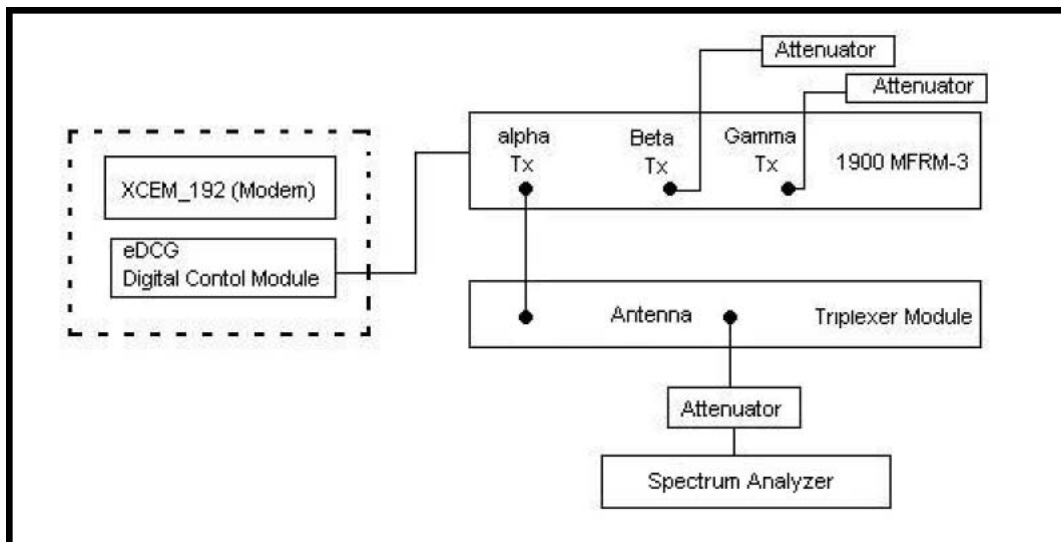

Figure 2: Occupied Bandwidth Test Setup

4.2.4 Occupied Bandwidth Test Results

Below are the results for the Occupied Bandwidth Measurements:

Table 11: Occupied Bandwidth Results for a 1 Carrier Configuration

Channel Number	Frequency (MHz)	Occupied Bandwidth (MHz)
1225	1991.25	1.2717
1275	1993.75	1.2735

Table 12: Occupied Bandwidth Results for a 2 Carrier Configuration

Channel Number	Frequency (MHz)	Occupied Bandwidth (MHz)
1225, 1250	1991.25, 1992.5	2.4985

Table 13: Occupied Bandwidth Results for a 3 Carrier Configuration

Channel Number	Frequency (MHz)	Occupied Bandwidth (MHz)
1225, 1250, 1275	1991.25, 1992.5, 1993.75	3.7140

The screenshots of the measurements are shown below:

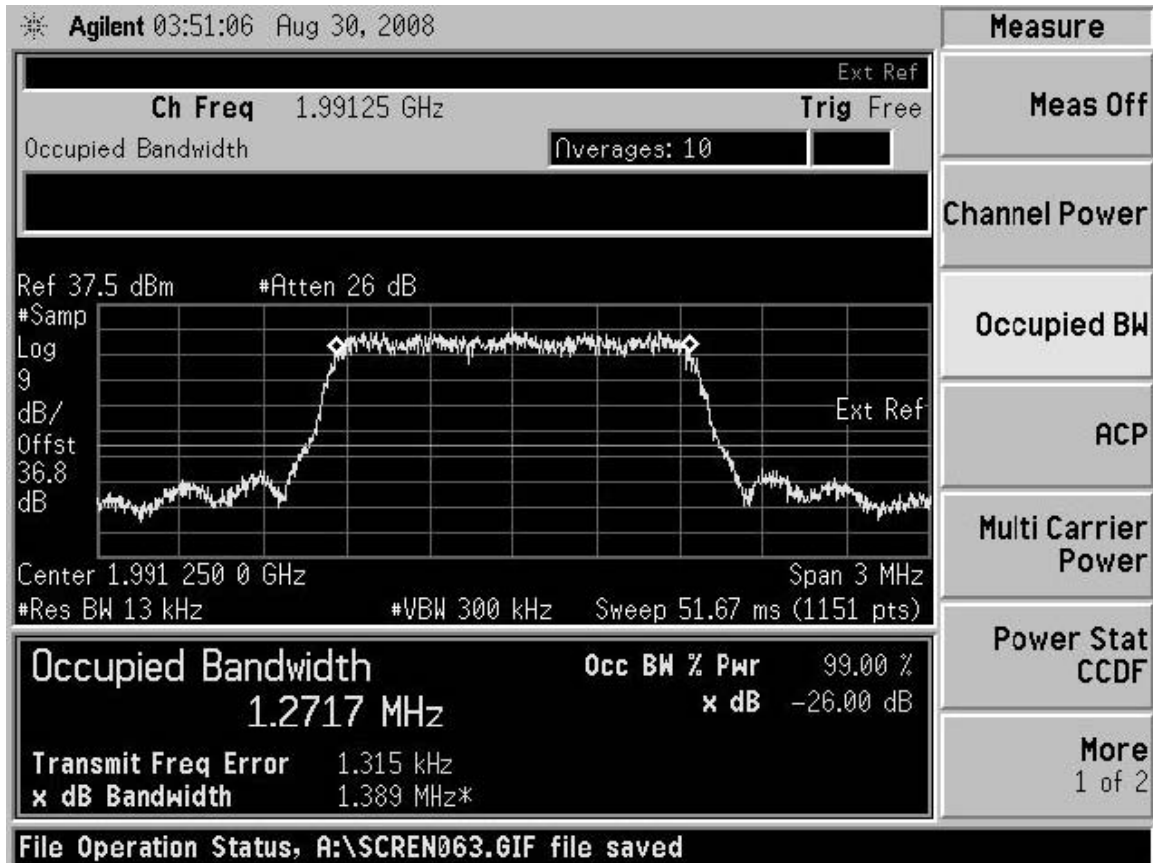

Figure 3: Occupied Bandwidth, 1 Carrier, Channel 1225

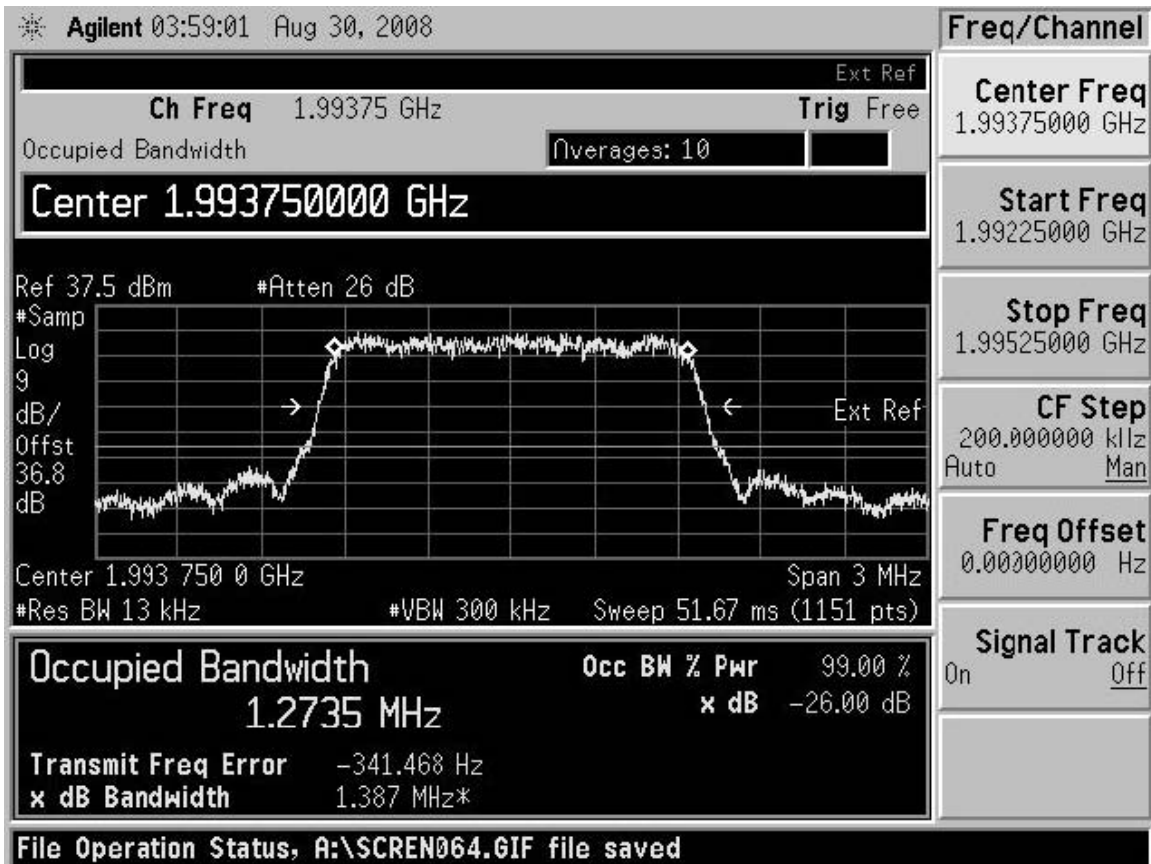

Figure 4: Occupied Bandwidth, 1 Carrier, Channel 1275

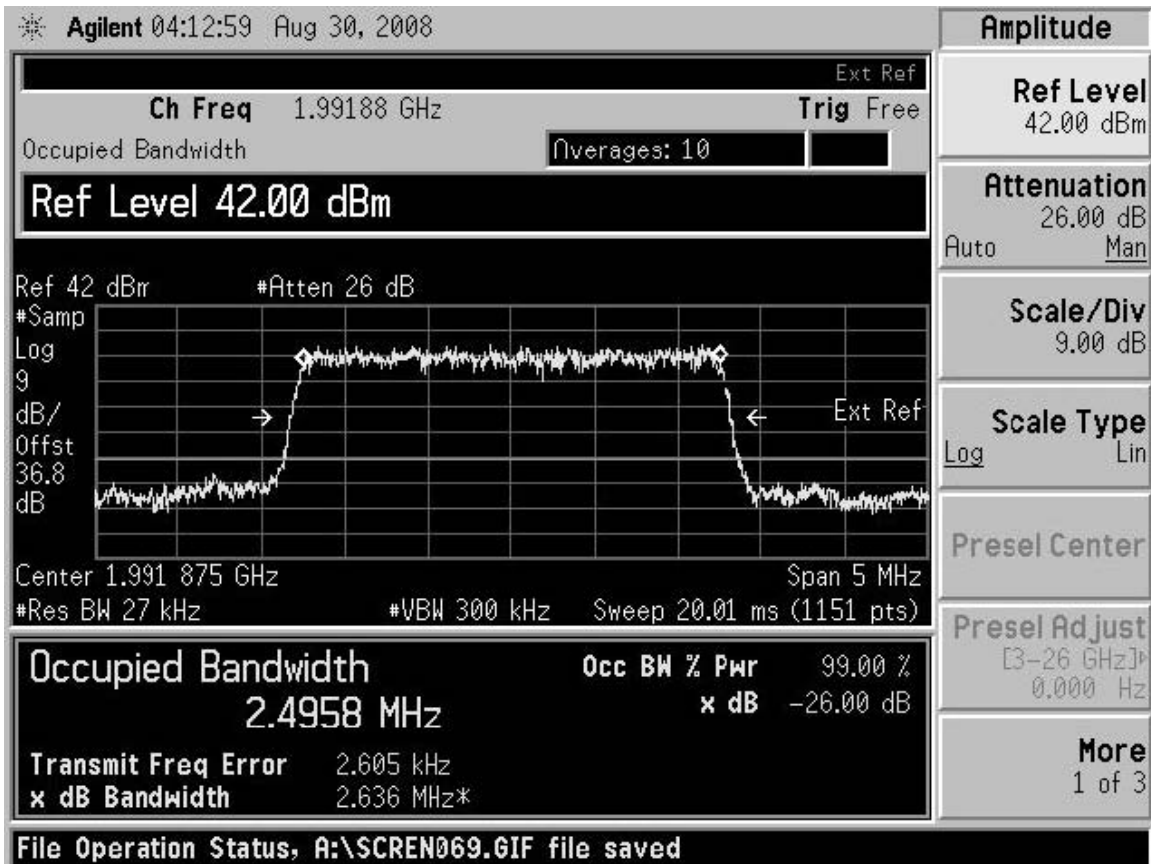

Figure 5: Occupied Bandwidth, 2 Carriers, Channel 1225, 1250

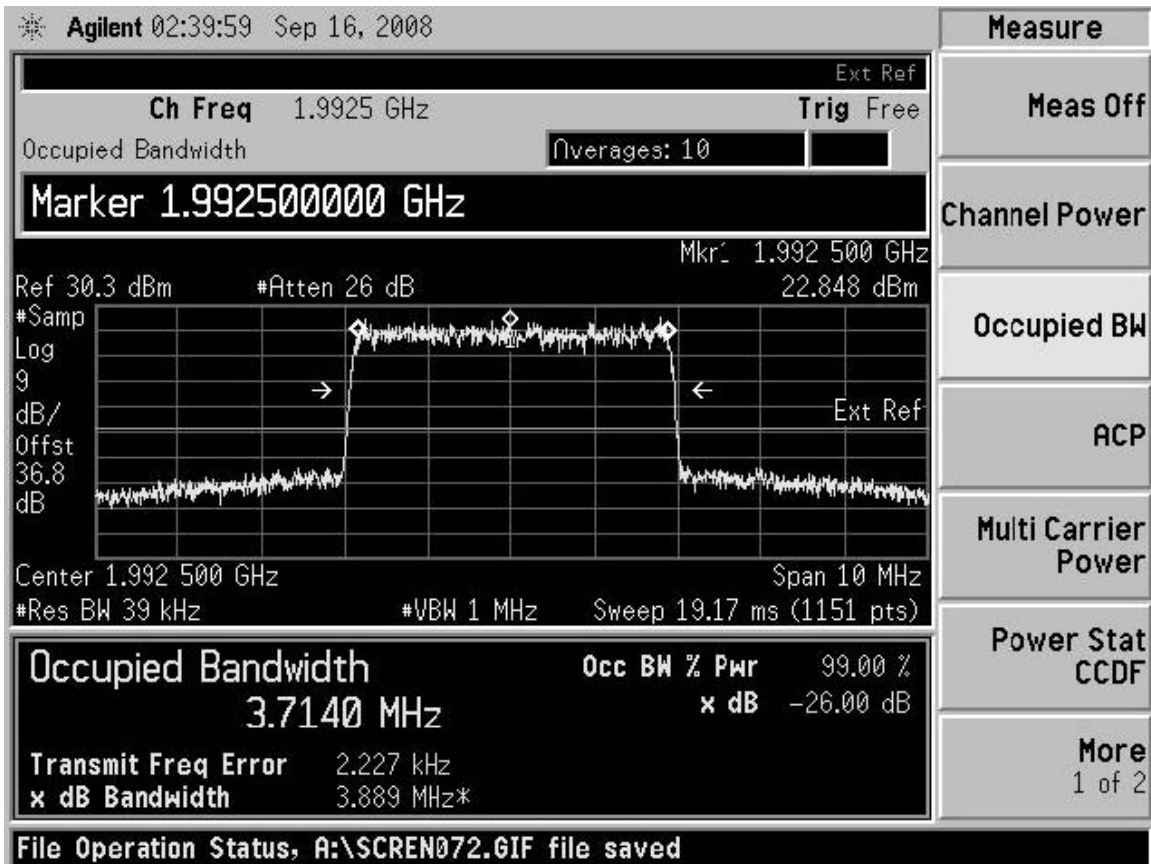

Figure 6: Occupied Bandwidth, 3 Carriers, Channel 1225, 1250, 1275

4.3. Spurious Emissions at Antenna Terminals

4.3.1 Spurious Emissions Requirements

FCC Part 2.1051

The radio frequency voltage or powers generated within the equipment and appearing on a spurious frequency shall be checked at the equipment output terminals when properly loaded with a suitable artificial antenna. Curves or equivalent data shall show the magnitude of each harmonic and other spurious emission that can be detected when the equipment is operated under the conditions specified in Sec. 2.1049 as appropriate. The magnitude of spurious emissions which are attenuated more than 20 dB below the permissible value need not be specified.

FCC Part 2.1057 - Frequency Spectrum to be investigated

(a) In all of the measurements set forth in Sec. 2.1051, the spectrum shall be investigated from the lowest radio frequency signal generated in the equipment, without going below 9 kHz, up to at least the tenth harmonic of the highest fundamental frequency or to 40 GHz, whichever is lower.

.(b) Particular attention should be paid to harmonics and subharmonics of the carrier frequency as well as to those frequencies removed from the carrier by multiples of the oscillator frequency. Radiation at the frequencies of multiplier stages should also be checked.

.(c) The amplitude of spurious emissions which are attenuated more than 20 dB below the permissible value need not be reported.

FCC Part 27.53 Limit

.(g) On any frequency outside a licensee's frequency block, the power of any emission shall be attenuated below the transmitter power (P) by at least $43 + 10 \log (P)$ dB.

.(1) Compliance with these provisions is based on the use of measurement instrumentation employing a resolution bandwidth of 1 MHz or greater. However, in the 1 MHz bands immediately outside and adjacent to the frequency block a resolution bandwidth of at least one percent of the emission bandwidth of the fundamental emission of the transmitter may be employed. The emission bandwidth is defined as the width of the signal between two points, one below the carrier center frequency and one above the carrier center frequency, outside of which all emissions are attenuated at least 26 dB below the transmitter power.

.(2) When measuring the emission limits, the nominal carrier frequency shall be adjusted as close to the licensee's frequency block edges, both upper and lower, as the design permits.

.(3) The measurements of emission power can be expressed in peak or average values, provided they are expressed in the same parameters as the transmitter power.

4.3.2 Test Method

Configure the BTS to enable the 1900 MFRM-3 to transmit at maximum rated power for each of the carrier configurations. Measurements were made on channels at the bottom and top of the G Block (bandclass 14). The following spectrum analyzer settings were used for the measurement of the antenna port spurious emissions:

Noise Floor

The table below lists the noise floor of the measurement system with no signal present.

Table 14: Spectrum Analyzer Noise Floor

Frequency (Band)	Noise Floor (dBm)
9 kHz to Lower adjacent 1 MHz	-29.64
Lower Adjacent 1 MHz	-42.66

Upper Adjacent 1 MHz	-41.93
Upper Adjacent 1 MHz to 5 GHz	-26.50
5 GHz to 22 GHz	-31.50

Settings for adjacent 1 MHz to indicated subband (upper and lower)

Table 15: Spectrum Analyzer Settings for adjacent 1 MHz Measurements

Setting	1 Carrier	2 Carriers	3 Carriers
Resolution Bandwidth	13 kHz	27 kHz	39 kHz
Average	10	10	10
Detector	RMS	RMS	RMS
Attenuation	26 dB	26 dB	26 dB
Ref. Offset	36.8 dB	36.8 dB	36.8 dB

All other spurious emissions up to 5 GHz

Table 16: Spectrum Analyzer Settings for Emissions up to 5 GHz

Setting	1 Carrier	2 Carriers	3 Carriers
Resolution Bandwidth	1 MHz	1 MHz	1 MHz
Average	10	10	10
Detector	RMS	RMS	RMS
Attenuation	26 dB	26 dB	26 dB
Ref. Offset	36.8 dB	36.8 dB	36.8 dB

Spurious emissions from 5 GHz to 22 GHz

Table 17: Spectrum Analyzer Settings for Emissions between 5 GHz and 22 GHz

Setting	1 Carrier	2 Carriers	3 Carriers
Resolution Bandwidth	1 MHz	1 MHz	1 MHz
Average	10	10	10
Detector	RMS	RMS	RMS
Attenuation	26 dB	26 dB	26 dB
Ref. Offset	27.2 dB	27.2 dB	27.2 dB

The emissions will be investigated up to 20 GHz (the 10th harmonic of the fundamental emission) for all carrier configurations (1, 2, and 3) as per FCC Part 27.

4.3.3 Test Setup

Refer to Figure 2 for the test setup block diagram.

4.3.4 Spurious Emissions Test Results

Table 18: Emissions Measurements for 1 Carrier

Frequency (Band)	Spurious Emissions Level (dBm)	Margin to FCC Limit of -13 dBm (dB)
1989 to 1990 MHz (Lower Adjacent 1 MHz) Channel 1225	-26.53	13.53
1995 to 1996 MHz (Upper Adjacent 1 MHz) Channel 1275	-27.11	14.11
9 kHz to lower adjacent 1 MHz (RBW = 1 MHz)	-22.31	9.31
Upper adjacent 1 MHz to 5 Ghz (RBW = 1 MHz)	-21.88	8.88
5 GHz to 22 GHz (RBW = 1 MHz)	-31.48	18.48

Table 19: Emissions Measurements for 2 Carriers

Frequency (Band)	Spurious Emissions Level (dBm)	Margin to FCC Limit of -13 dBm (dB)
1989 to 1990 MHz (Lower Adjacent 1 MHz) Channel 1225, 1250	-21.26	8.26
1995 to 1996 MHz (Upper Adjacent 1 MHz) Channel 1250, 1275	-22.74	9.74
9 kHz to lower adjacent 1 MHz (RBW = 1 MHz)	-17.87	4.87
Upper adjacent 1 MHz to 5 Ghz (RBW = 1 MHz)	-16.04	3.04
5 GHz to 22 GHz (RBW = 1 MHz)	-31.63	18.63

Table 20: Emissions Measurements for 3 Carriers

Frequency (Band)	Spurious Emissions Level (dBm)	Margin to FCC Limit of -13 dBm (dB)
1989 to 1990 MHz (Lower Adjacent 1 MHz) Channel 1225,1250,1275	-22.38	9.38
1995 to 1996 MHz (Upper Adjacent 1 MHz) Channel 1225,1250,1275	-20.99	7.99
9 kHz to lower adjacent 1 MHz (RBW = 1 MHz)	-18.26	5.26
Upper adjacent 1 MHz to 5 Ghz (RBW = 1 MHz)	-17.12	4.12
5 GHz to 22 GHz (RBW = 1 MHz)	-31.45	18.45

4.4. Frequency Stability

4.4.1 Frequency Stability Requirements

FCC Part 2.1055

.(a) The frequency stability shall be measured with variation of ambient temperature as follows:

.(1) From -30 to +50 centigrade for all equipment except that specified in subparagraphs (2) and (3) of this paragraph.

.(b) Frequency measurements shall be made at the extremes of the specified temperature range and at intervals of not more than 10 centigrade through the range. A period of time sufficient to stabilize all of the components of the oscillator circuit at each temperature level shall be allowed prior to frequency measurement. The short term transient effects on the frequency of the transmitter due to keying (except for broadcast transmitters) and any heating element cycling normally occurring at each ambient temperature level also shall be shown. Only the portion or portions of the transmitter containing the frequency determining and stabilizing circuitry need be subjected to the temperature variation test.

.(d) The frequency stability shall be measured with variation of primary supply voltage as follows:

.(1) Vary primary supply voltage from 85 to 115 percent of the nominal value for other than hand carried battery equipment.

.(2) For hand carried, battery powered equipment, reduce primary supply voltage to the battery operating end point which shall be specified by the manufacturer.

.(3) The supply voltage shall be measured at the input to the cable normally provided with the equipment, or at the power supply terminals if cables are not normally provided. Effects on frequency of transmitter keying (except for broadcast transmitters) and any heating element cycling at the nominal supply voltage and at each extreme also shall be shown.

*.(e) When deemed necessary, the Commission may require tests of frequency stability under conditions in addition to those specifically set out in paragraphs (a), (b), (c) and (d) of this section. (For example, measurements showing the effect of proximity to large metal objects, or of various types of antennas, may be required for portable equipment.) *

FCC Part 27.54 Limit

The frequency stability shall be sufficient to ensure that the fundamental emission stays within the authorized frequency block.

4.4.2 Test Method

Measure the frequency tolerance at -40, -48, and -56 VDC. After that, set the voltage to -48 VDC and measure the frequency tolerance at temperatures from -40 degrees Celsius to +50 degrees Celsius by 10 degrees increments. Record the frequency tolerance at each temperature.

4.4.3 Frequency Stability Test Results

The test results for Frequency stability provided in this section were measured with the BTS configured with channels 1225, 1250, 1275. All carriers were IS-95 modulated. The BTS was

configured to transmit at maximum transmit power.

Table 21: Over Voltage Frequency Stability Measurements

Voltage (VDC)	Maximum Carrier Frequency Deviation (ppm)	Maximum Carrier Frequency Deviation (Hz)
-40	0.002434	4.85
-48	0.002304	4.59
-56	0.001676	3.34

Table 22: Over Temperature Frequency Stability Measurements

Temperature (degrees Celsius)	Maximum Carrier Frequency Deviation (ppm)	Maximum Carrier Frequency Deviation (Hz)
-40	0.000522	1.04
-30	0.000151	0.3
-20	0.000075	0.15
-10	0.000437	0.87
0	0.001310	2.61
10	0.001215	2.42
20	0.000055	0.11
30	0.001064	2.12
40	0.000336	0.67
50	0.002831	5.64

References

- [1] FCC Part 24, Subpart E, Broadband Personal Communications Systems
http://www.access.gpo.gov/nara/cfr/waisidx_01/47cfr22_01.html
- [2] FCC Part 2 Subpart J, "Frequency allocations and radio treaty matters; general rules and regulations", http://www.access.gpo.gov/nara/cfr/waisidx_01/47cfr2_01.html
- [3] TIA/EIA-97-E "Recommended Minimum Performance Standards for Base Stations Supporting Dual Mode Spread Spectrum Systems"

Appendix (Emissions Screenshots)

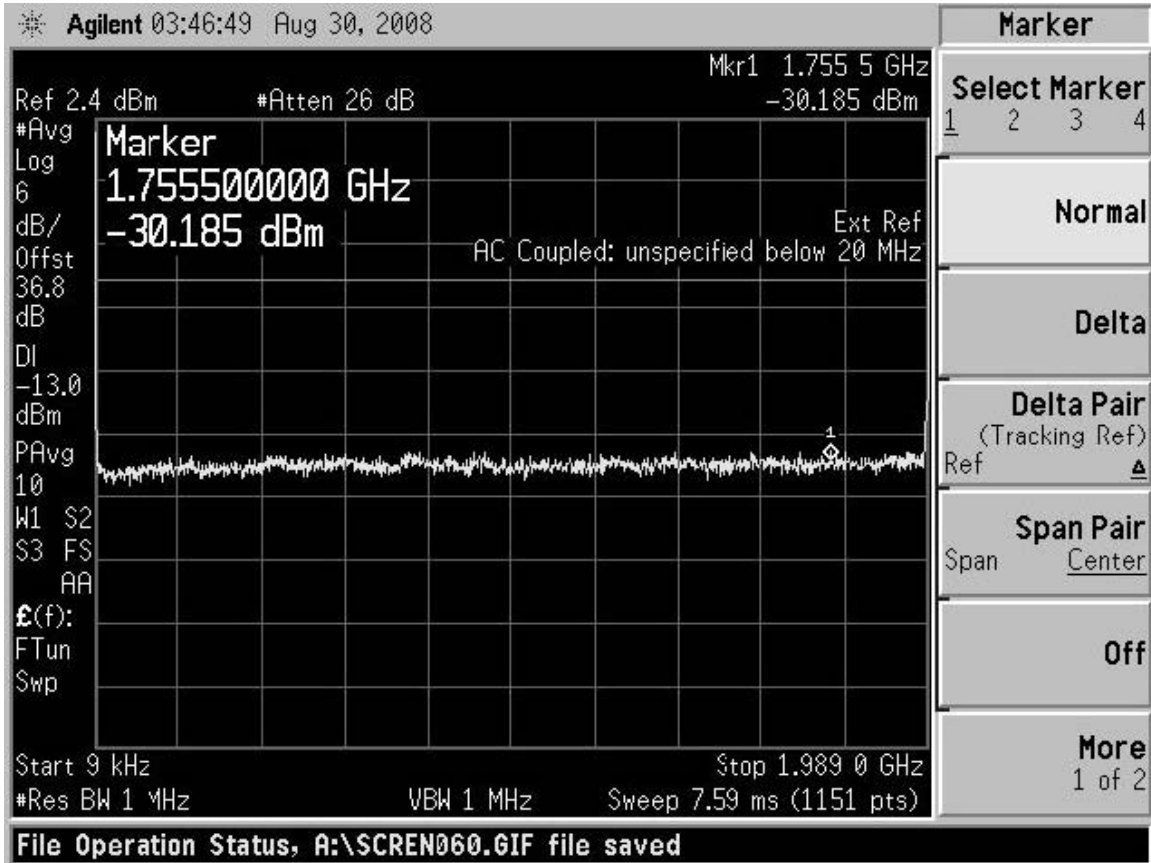

Figure 7: Spurious Emissions - 1 Carrier - Channel 1225, 9 kHz to Lower Adjacent 1 MHz

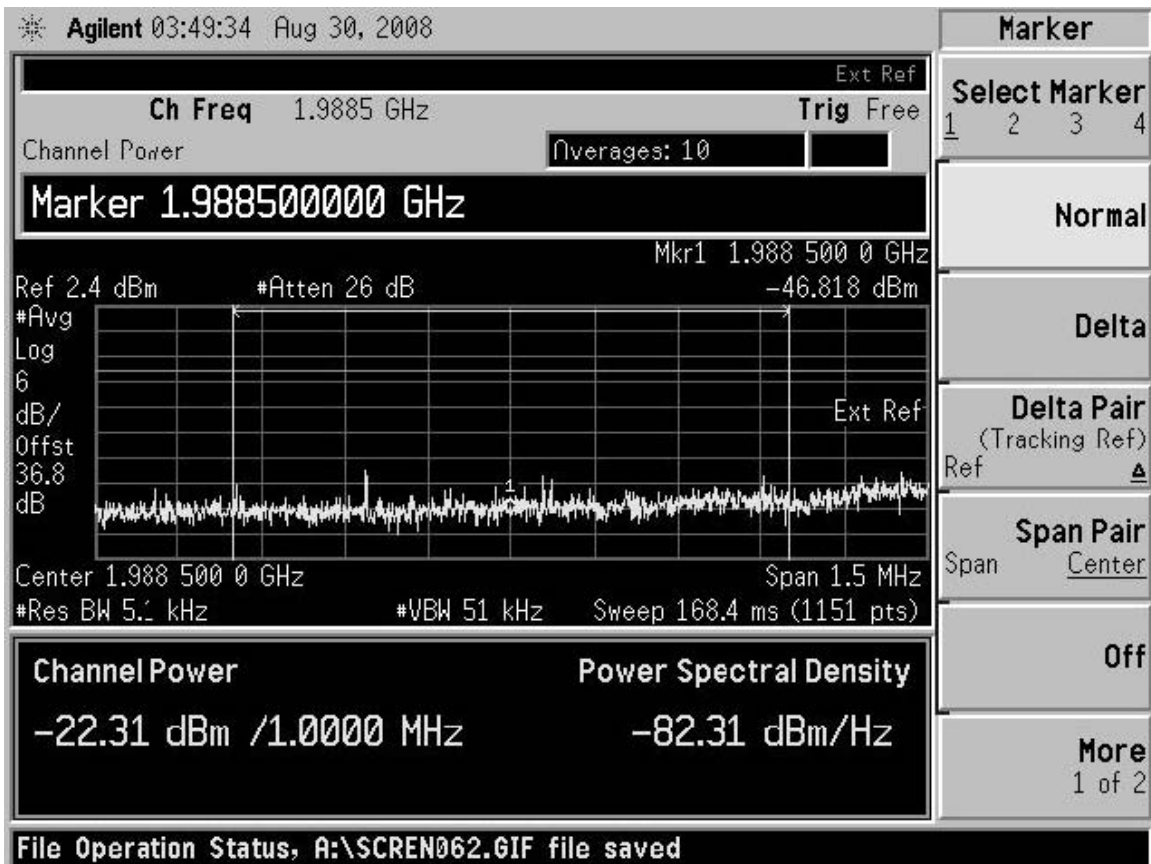

Figure 8: Spurious Emissions - 1 Carrier - Channel 1225, 9 kHz to Lower Adjacent 1 MHz (Verification)

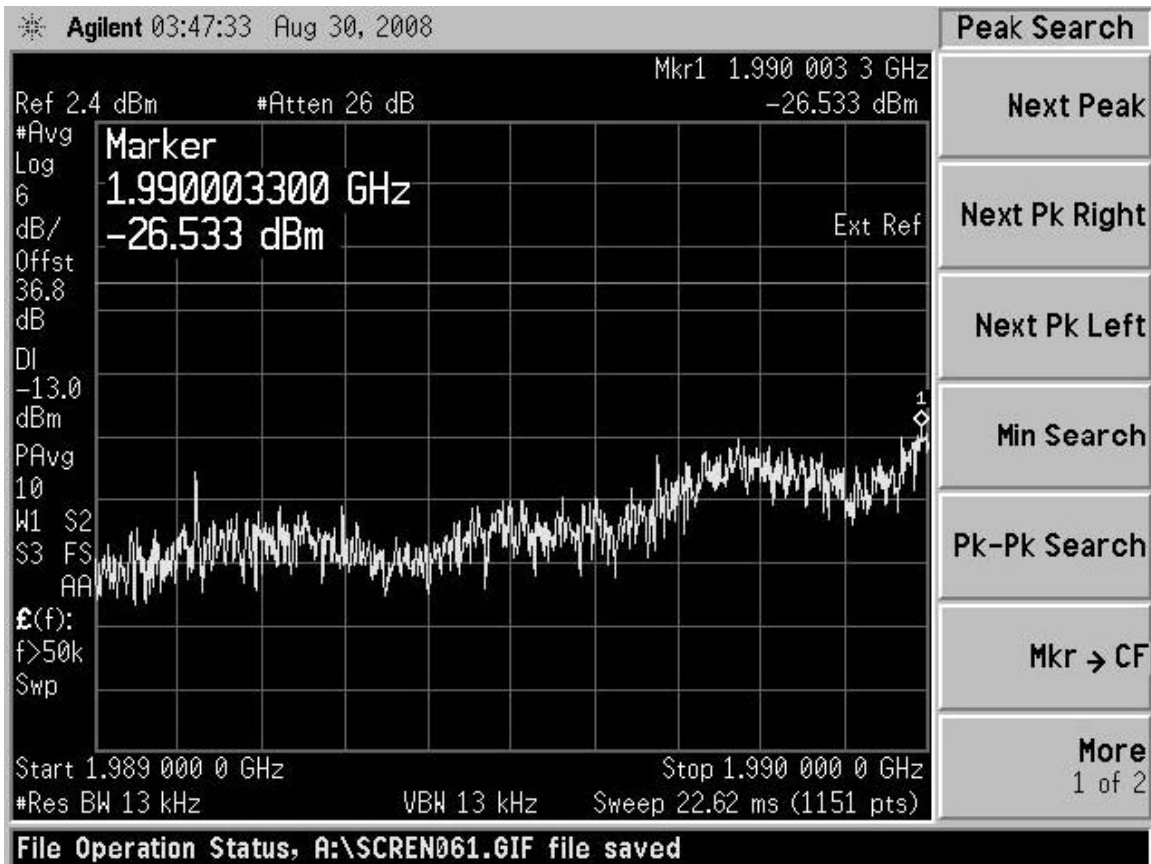

Figure 9: Spurious Emissions - 1 Carrier - Channel 1225, Lower Adjacent 1 MHz

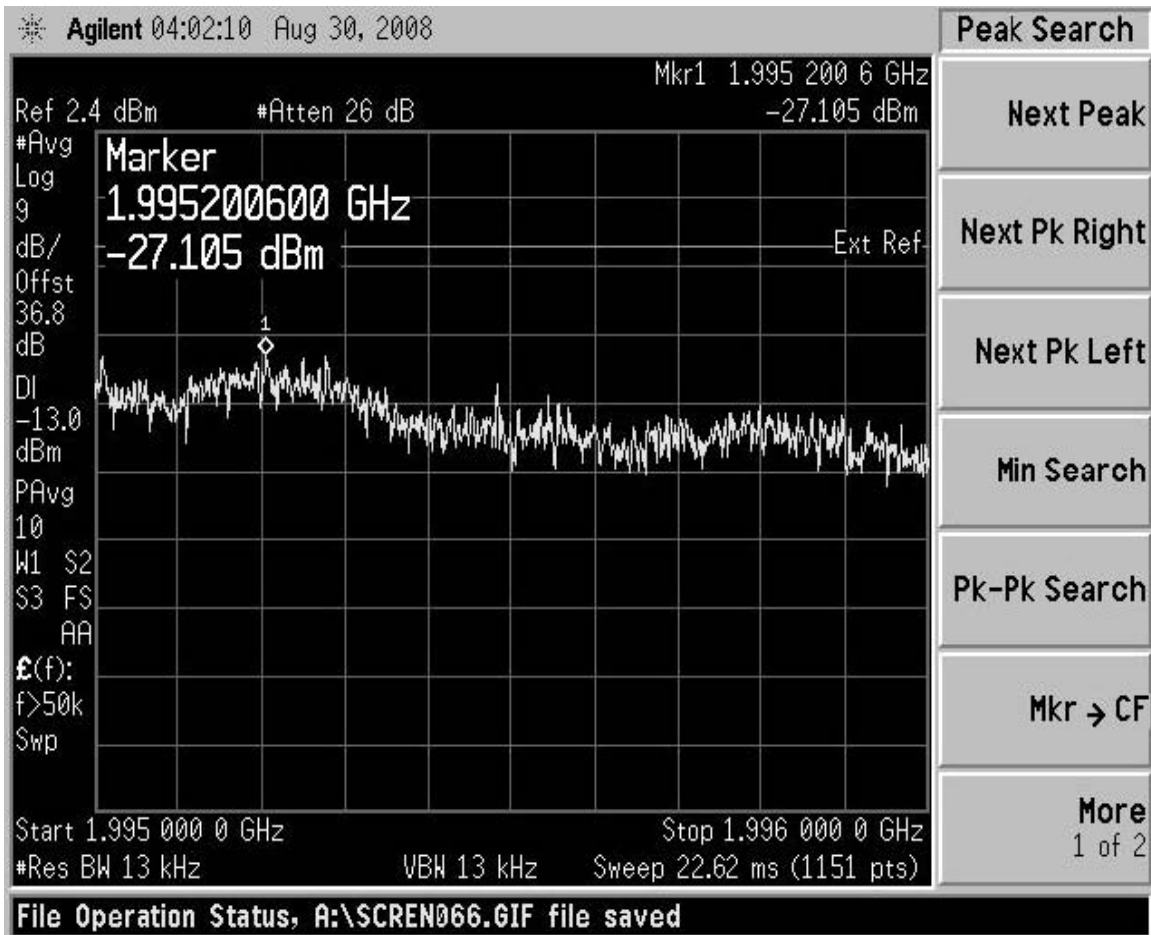

Figure 10: Spurious Emissions - 1 Carrier - Channel 1275, Upper Adjacent 1 MHz

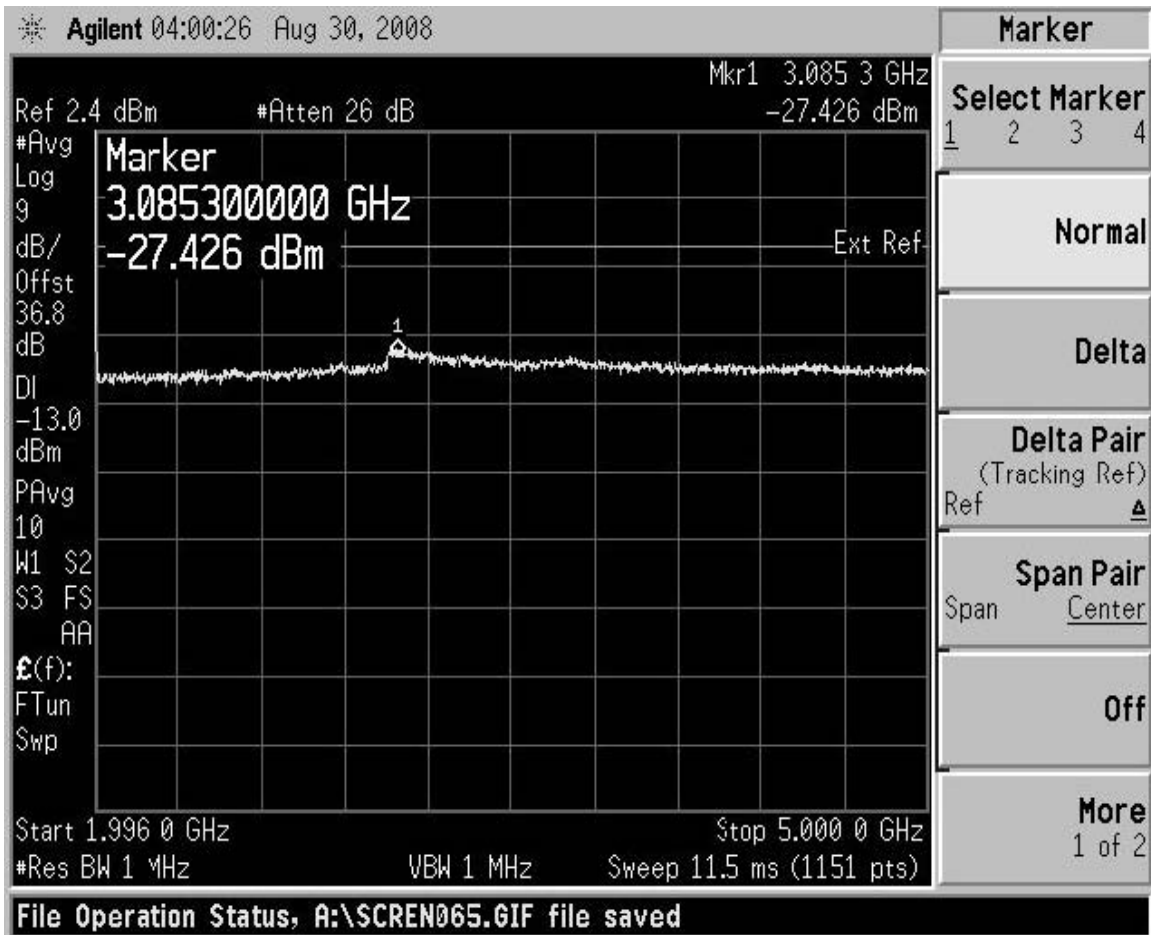

Figure 11: Spurious Emissions - 1 Carrier - Channel 1275, Upper Adjacent 1 MHz to 5 GHz

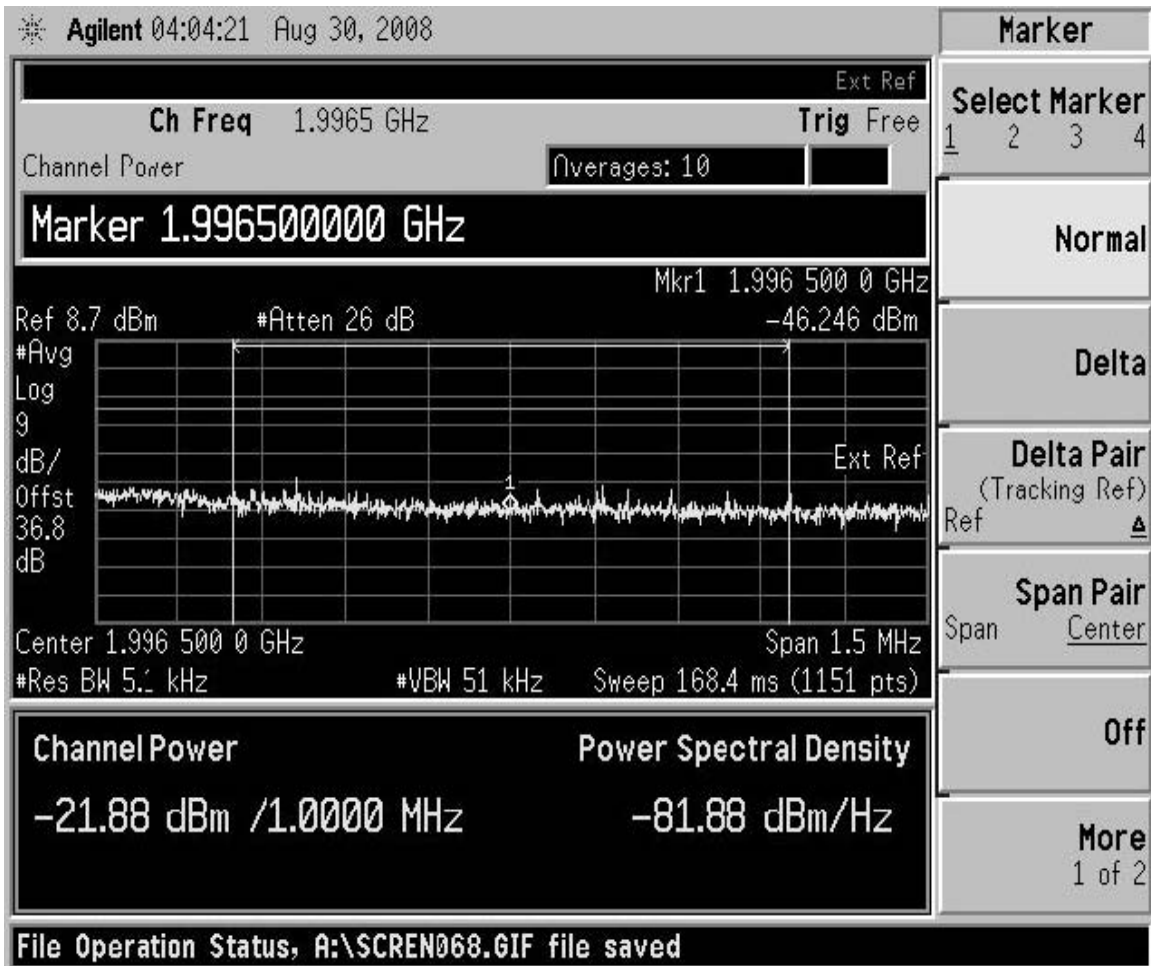

Figure 12: Spurious Emissions - 1 Carrier - Channel 1275, Upper Adjacent 1 MHz to 5 GHz (Verification)

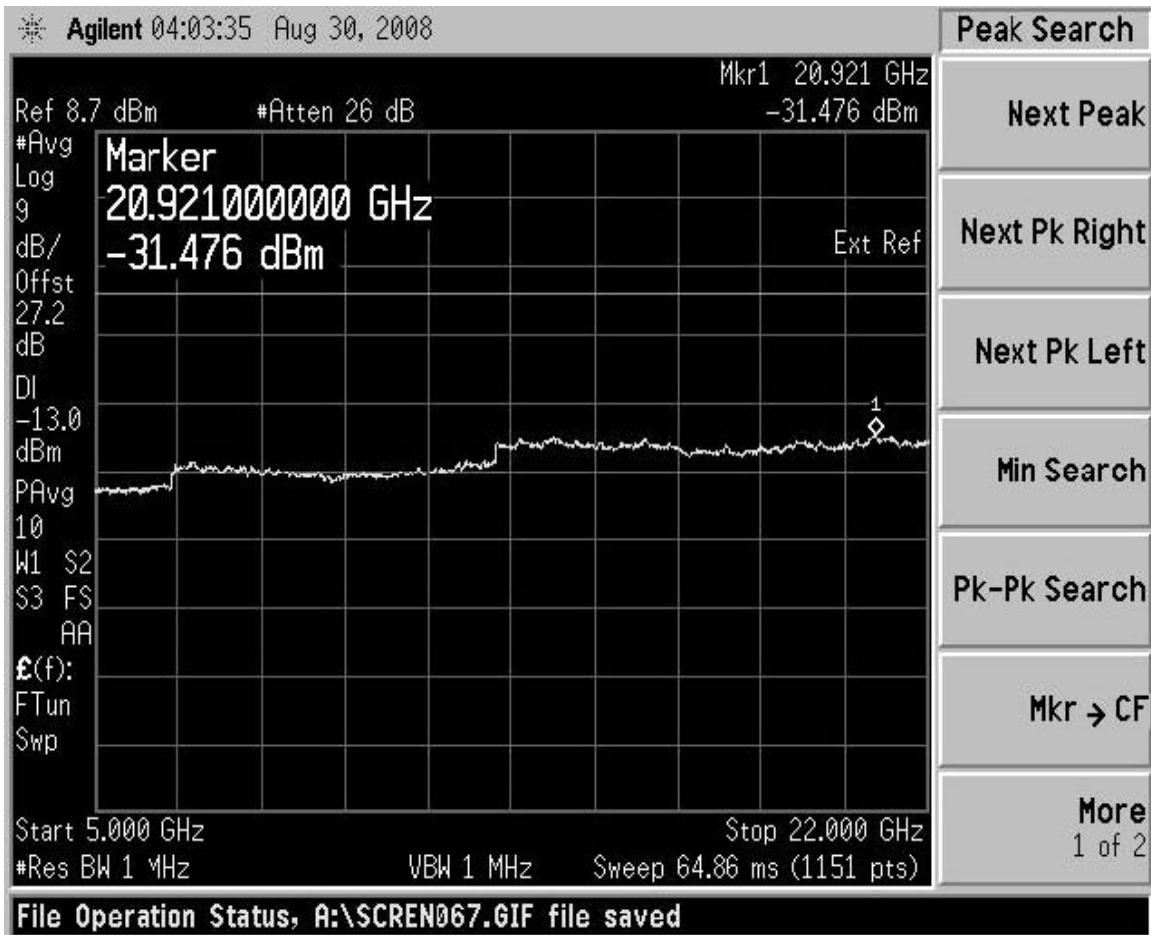

Figure 13: Spurious Emissions - 1 Carrier - Channel 1275, 5 GHz to 22 GHz

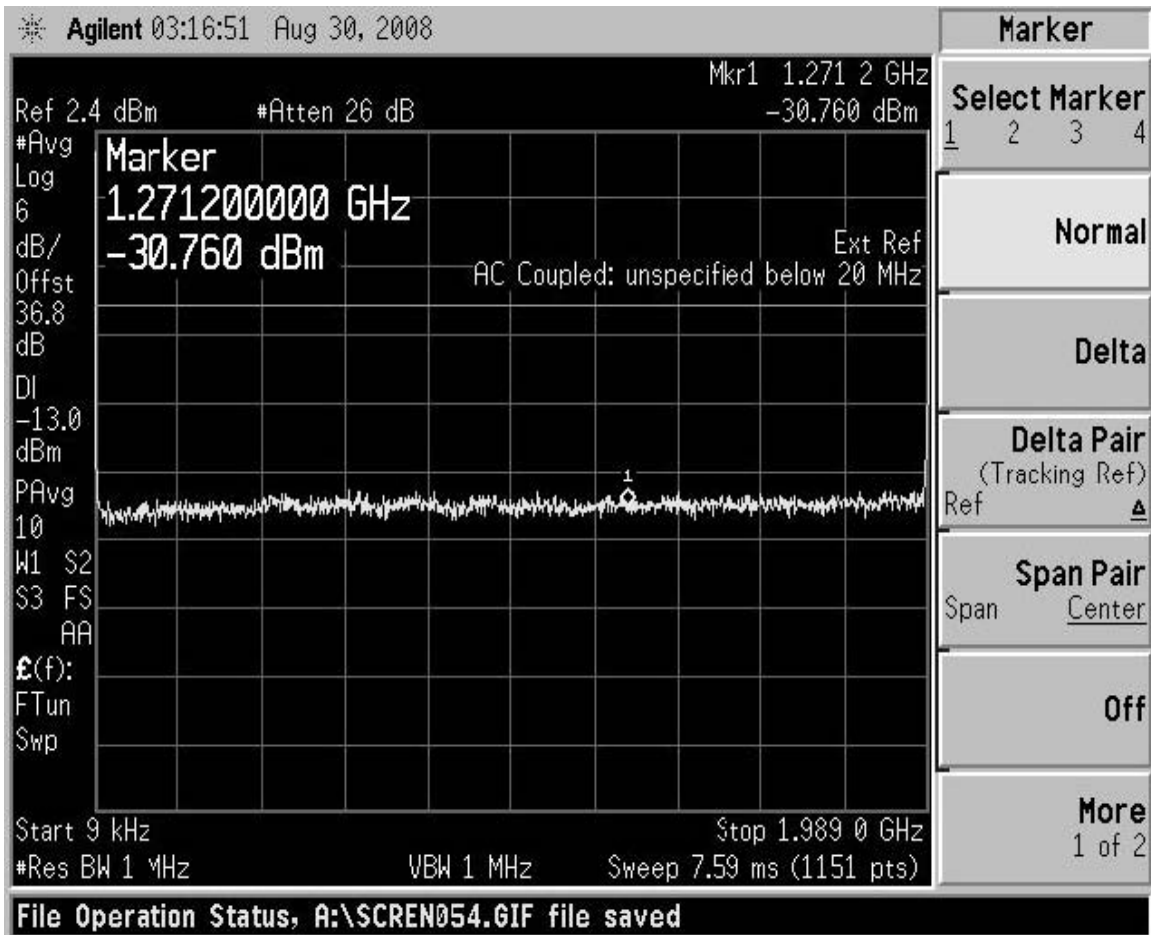

Figure 14: Spurious Emissions - 2 Carriers - Channel 1225, 1250, 9 kHz to Lower Adjacent 1 MHz

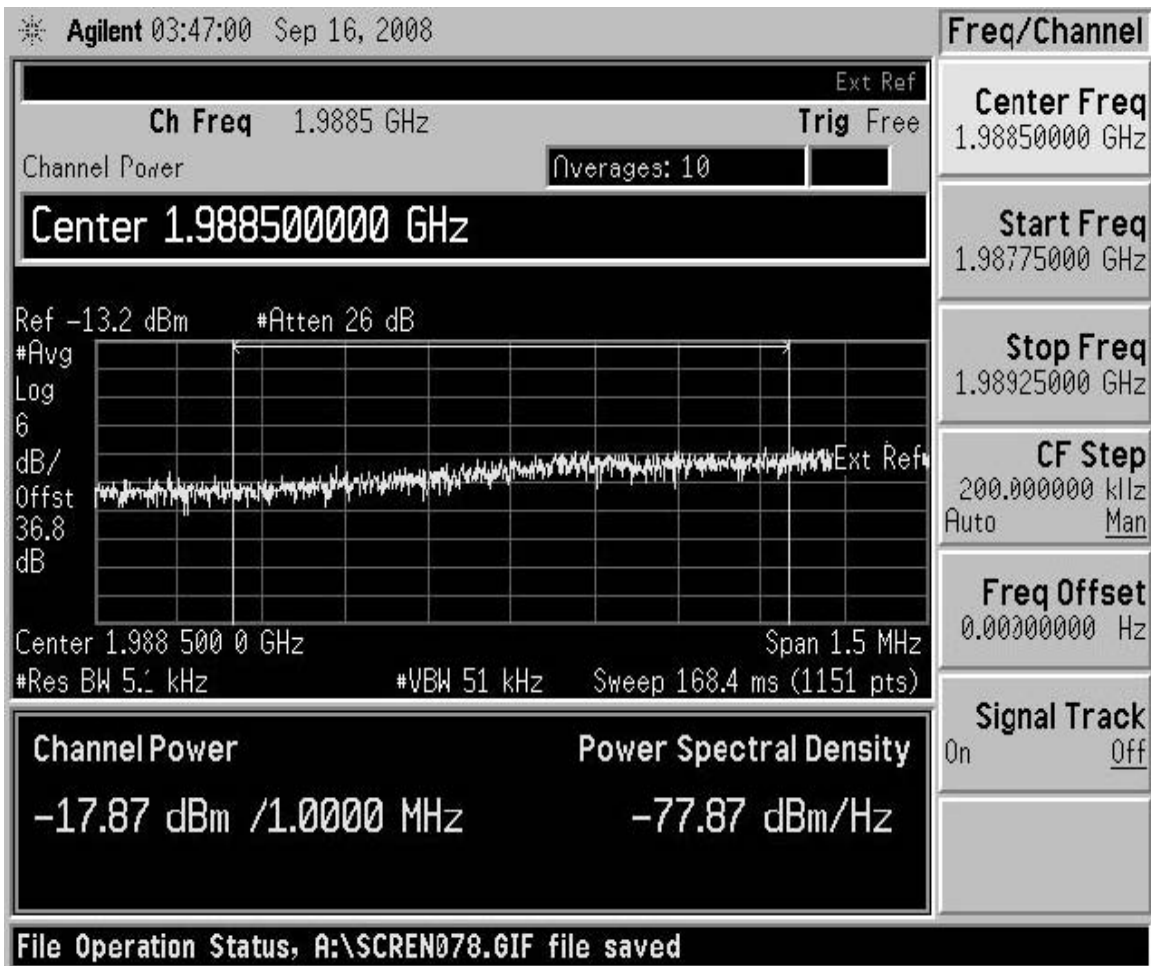

Figure 15: Spurious Emissions - 2 Carriers - Channel 1225, 1250, 9 kHz to Lower Adjacent 1 MHz (Verification)

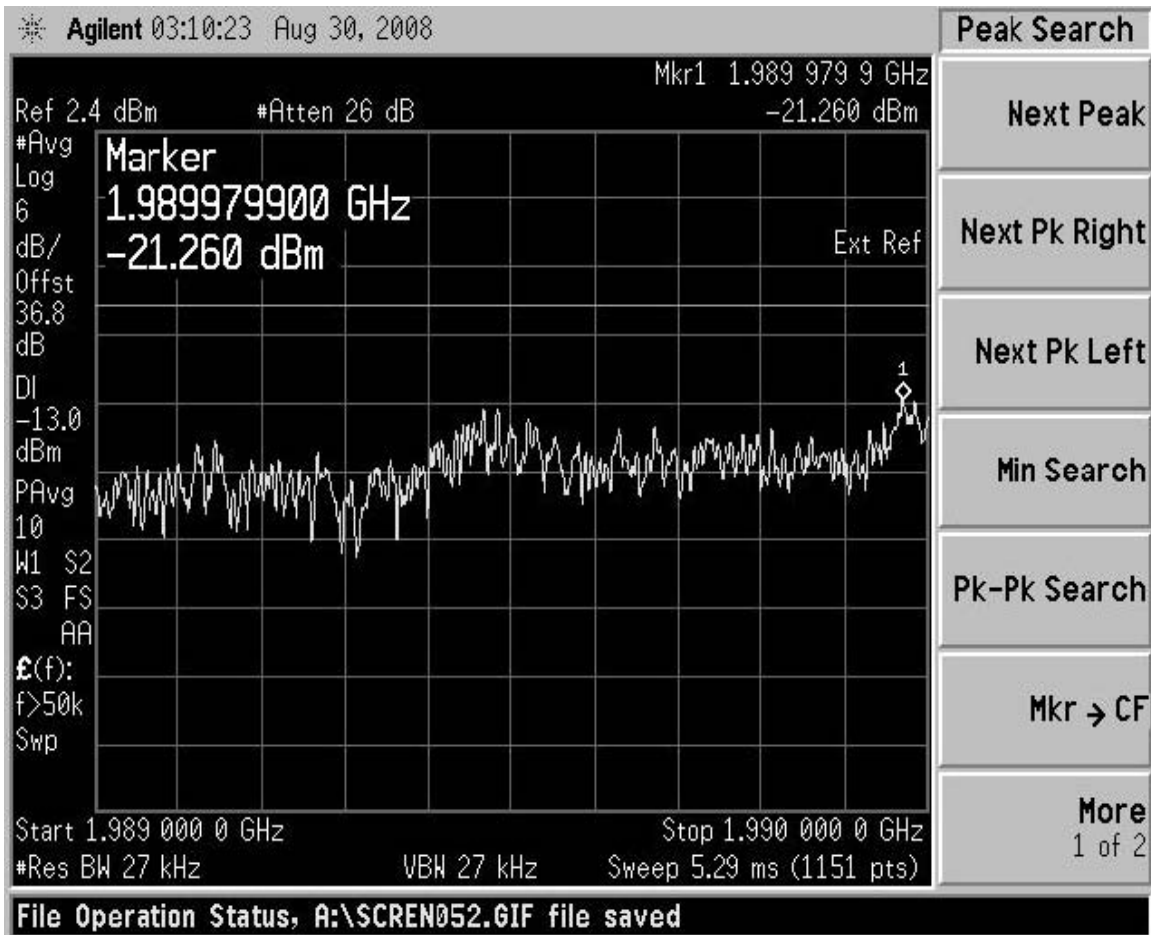

Figure 16: Spurious Emissions - 2 Carriers - Channel 1225, 1250, Lower Adjacent 1 MHz

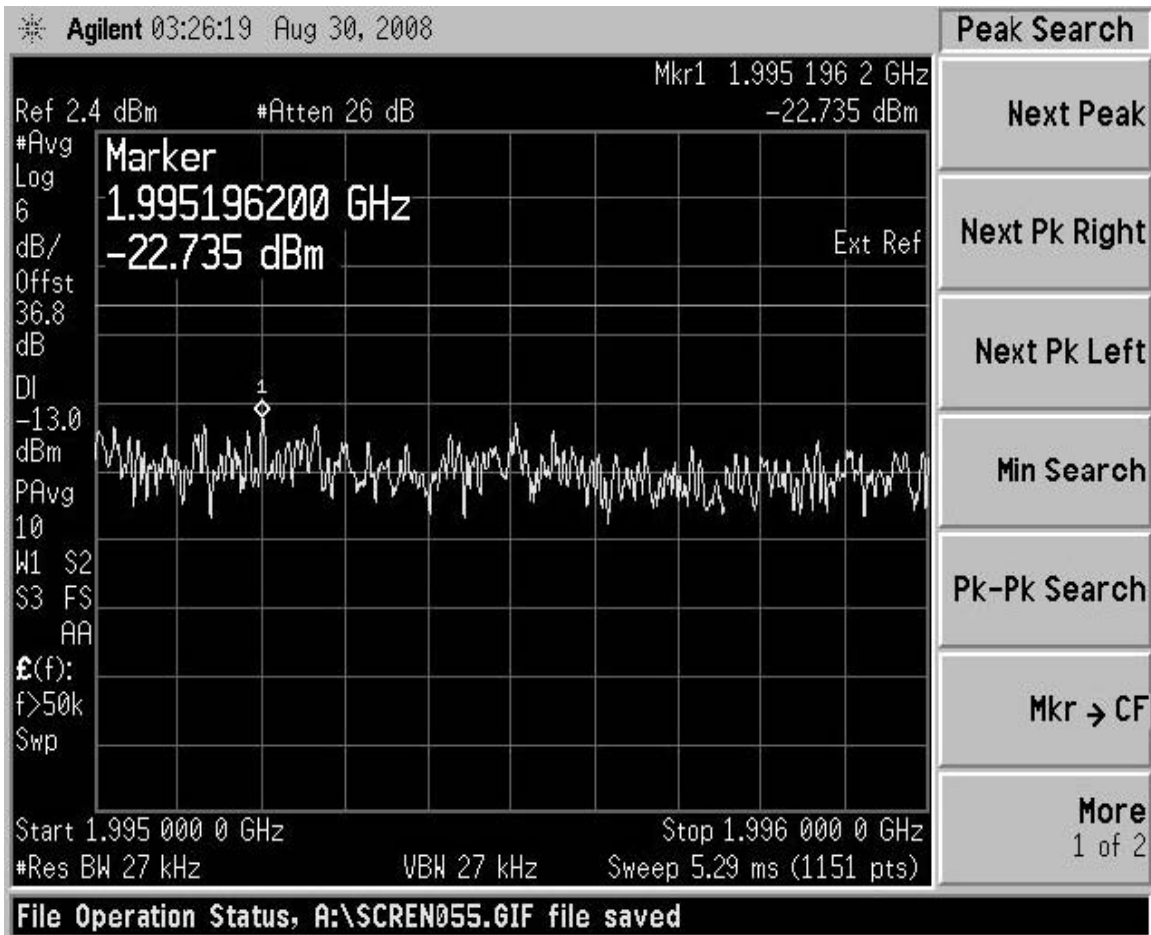

Figure 17: Spurious Emissions - 2 Carriers - Channel 1250, 1275, Upper Adjacent 1 MHz

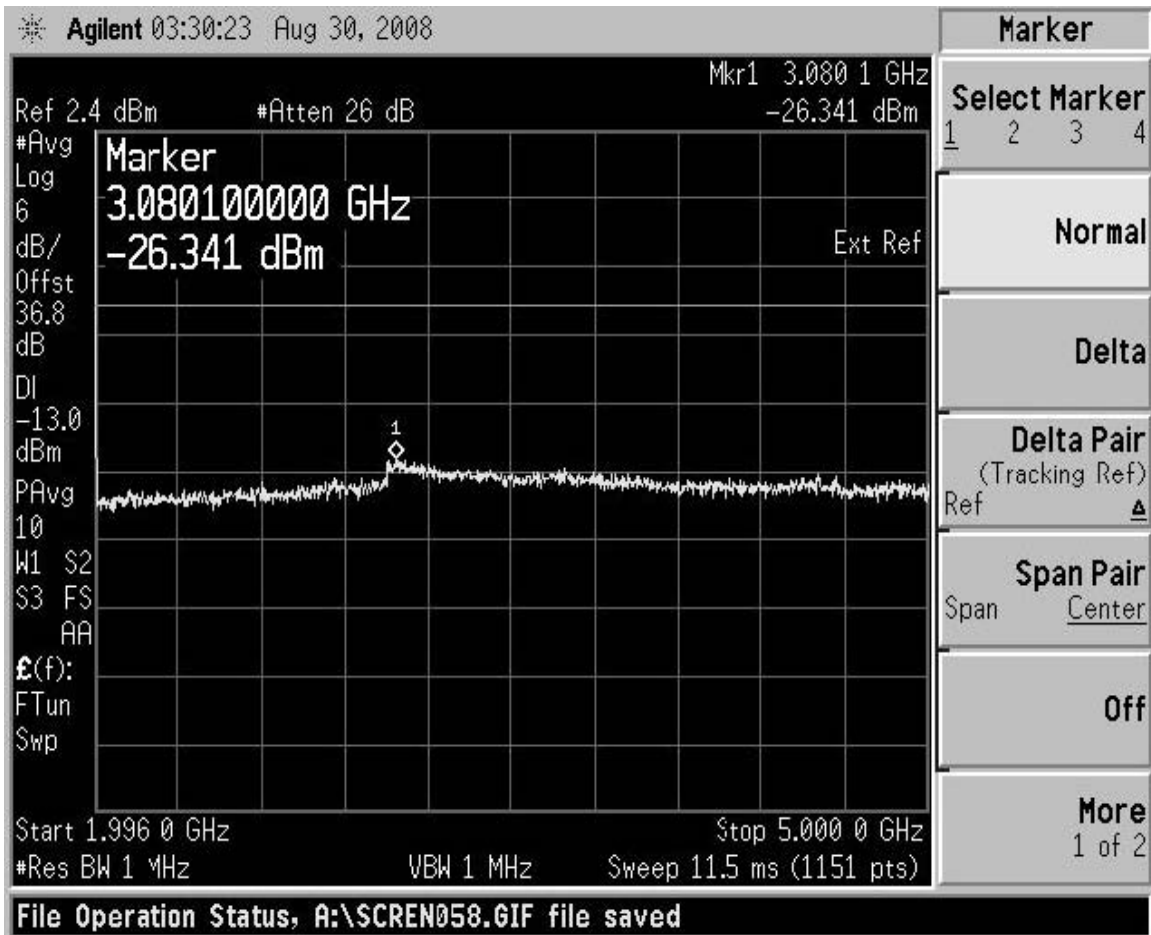

Figure 18: Spurious Emissions - 2 Carriers - Channel 1250, 1275, Upper Adjacent 1 MHz to 5 GHz

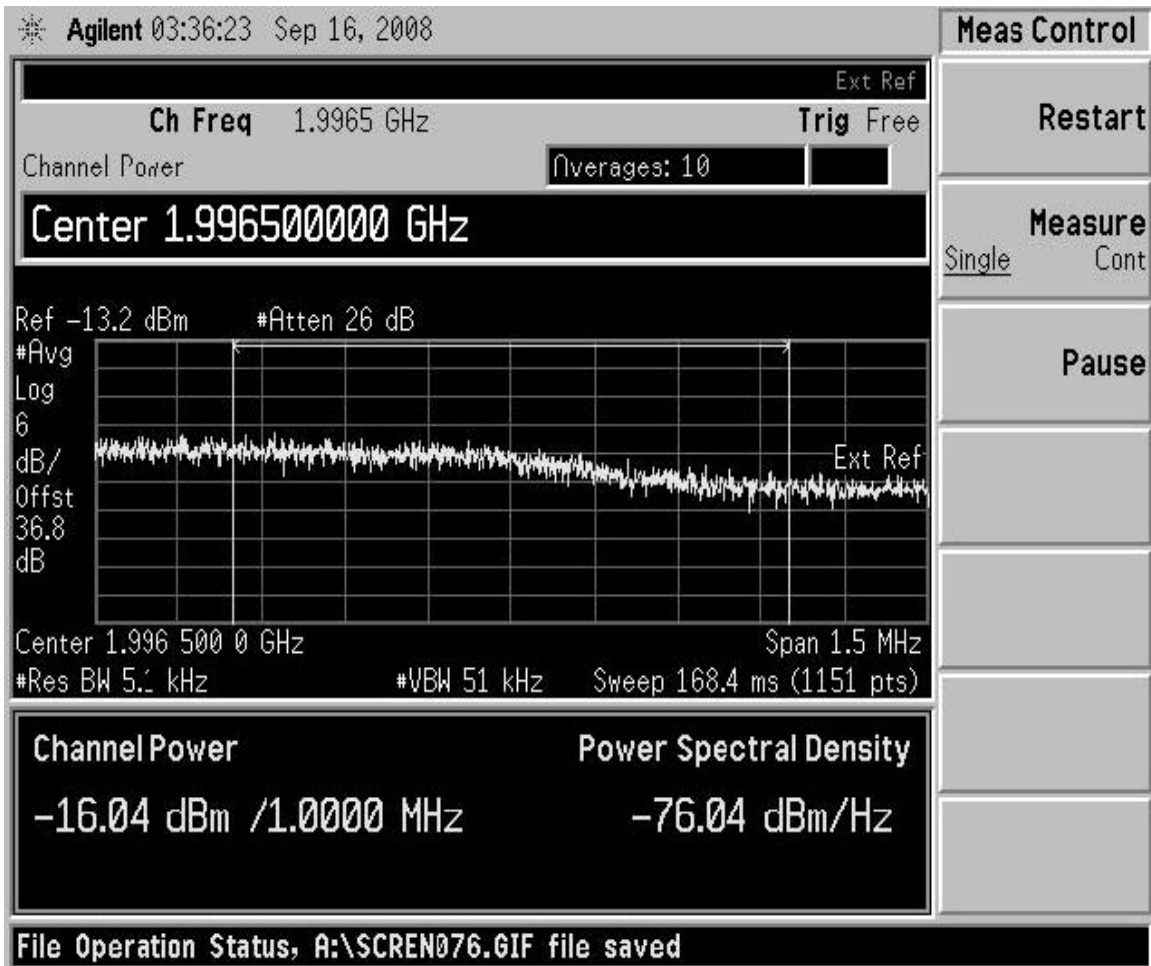

Figure 19: Spurious Emissions - 2 Carriers - Channel 1250, 1275, Upper Adjacent 1 MHz to 5 GHz (Verification)



Figure 20: Spurious Emissions - 2 Carriers - Channel 1250, 1275, 5 GHz to 22 GHz

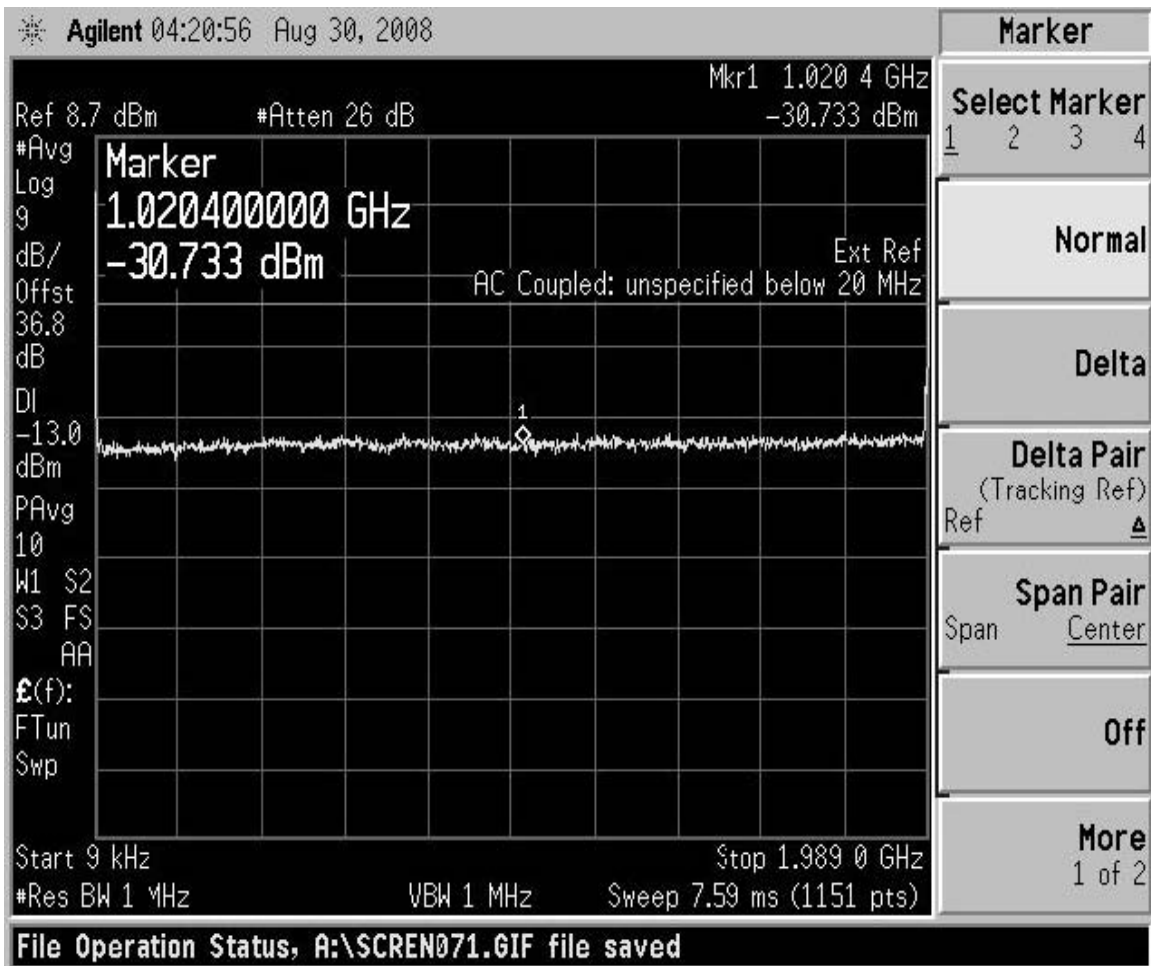

Figure 21: Spurious Emissions - 3 Carriers - Channel 1225, 1250, 1275, 9 kHz to Lower Adjacent 1 MHz

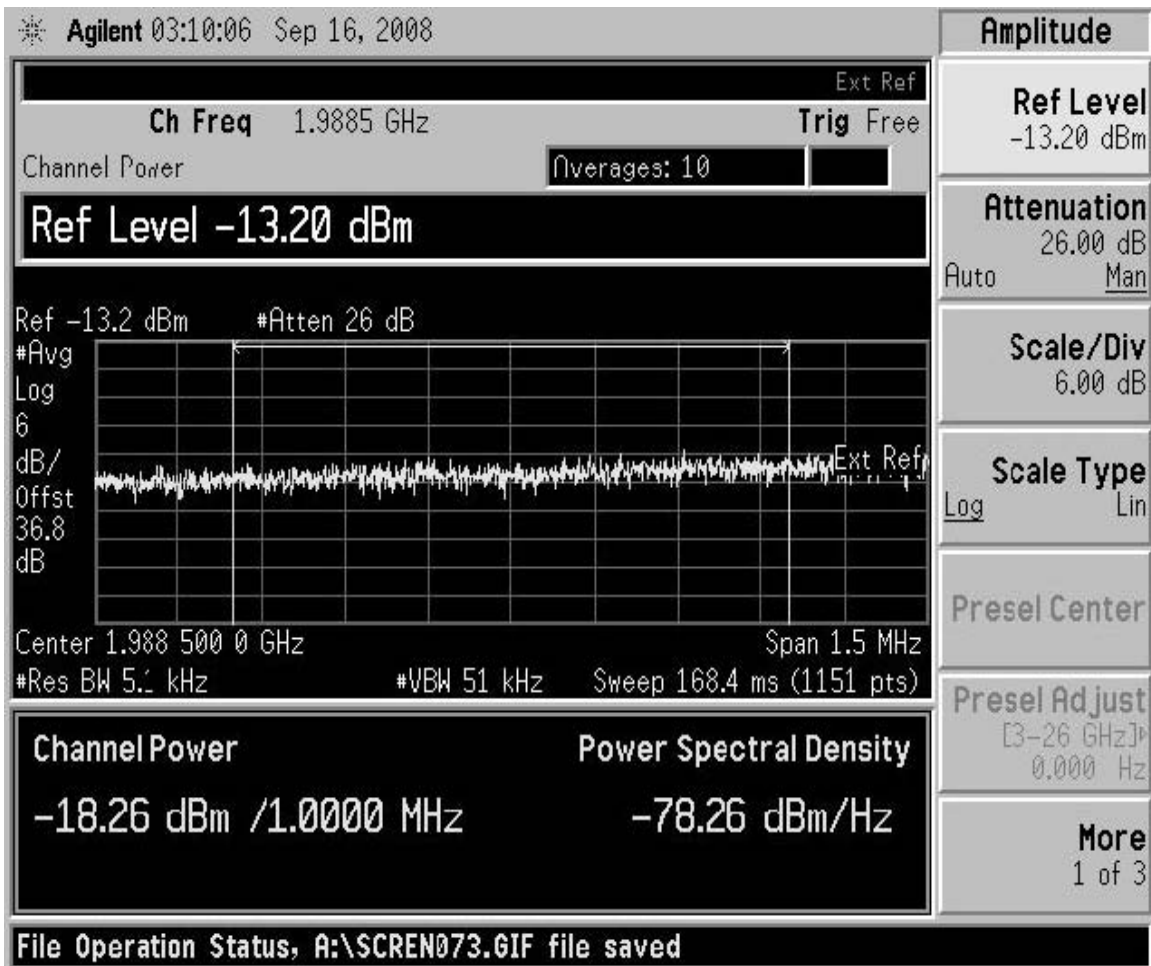

Figure 22: Spurious Emissions - 3 Carriers - Channel 1225, 1250, 1275, 9 kHz to Lower Adjacent 1 MHz (Verification)

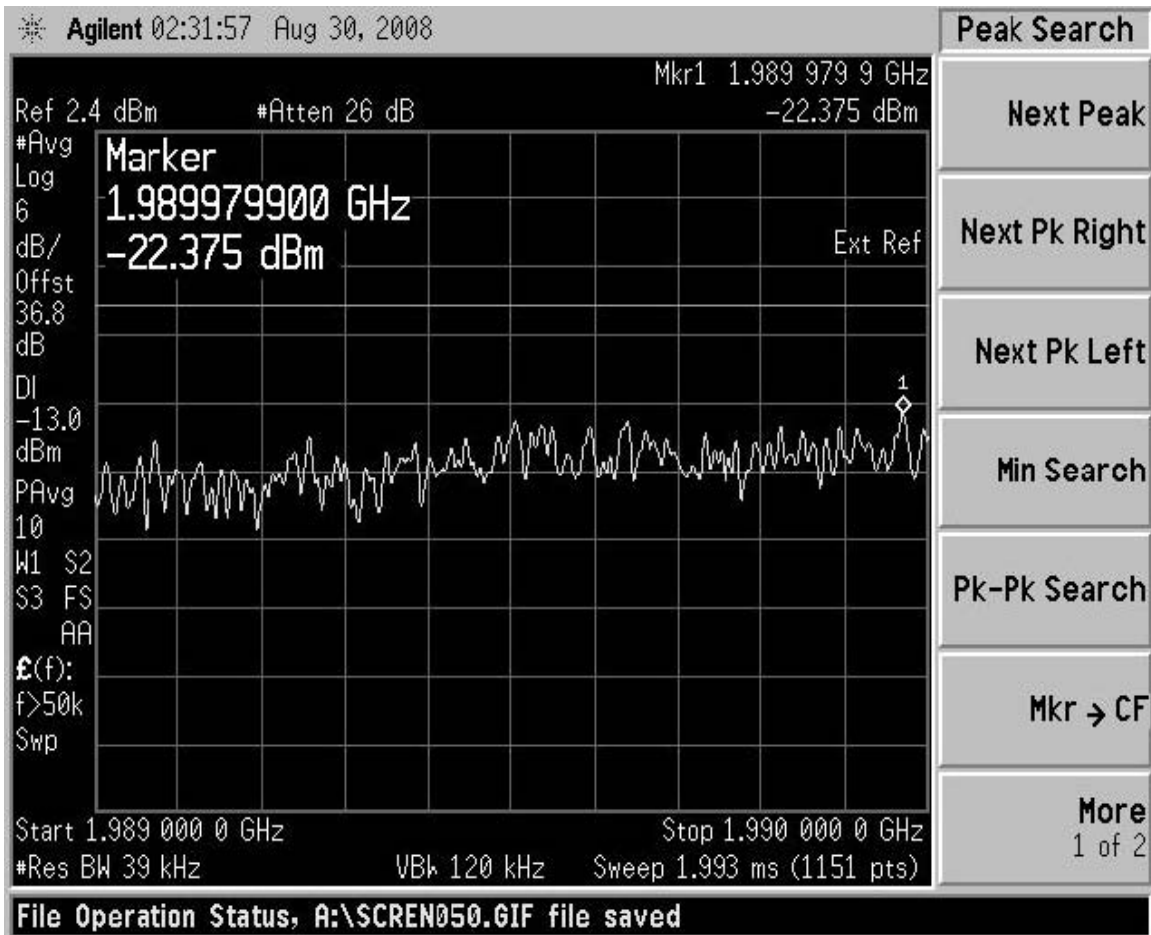

Figure 23: Spurious Emissions - 3 Carriers - Channel 1225, 1250, 1275, Lower Adjacent 1 MHz

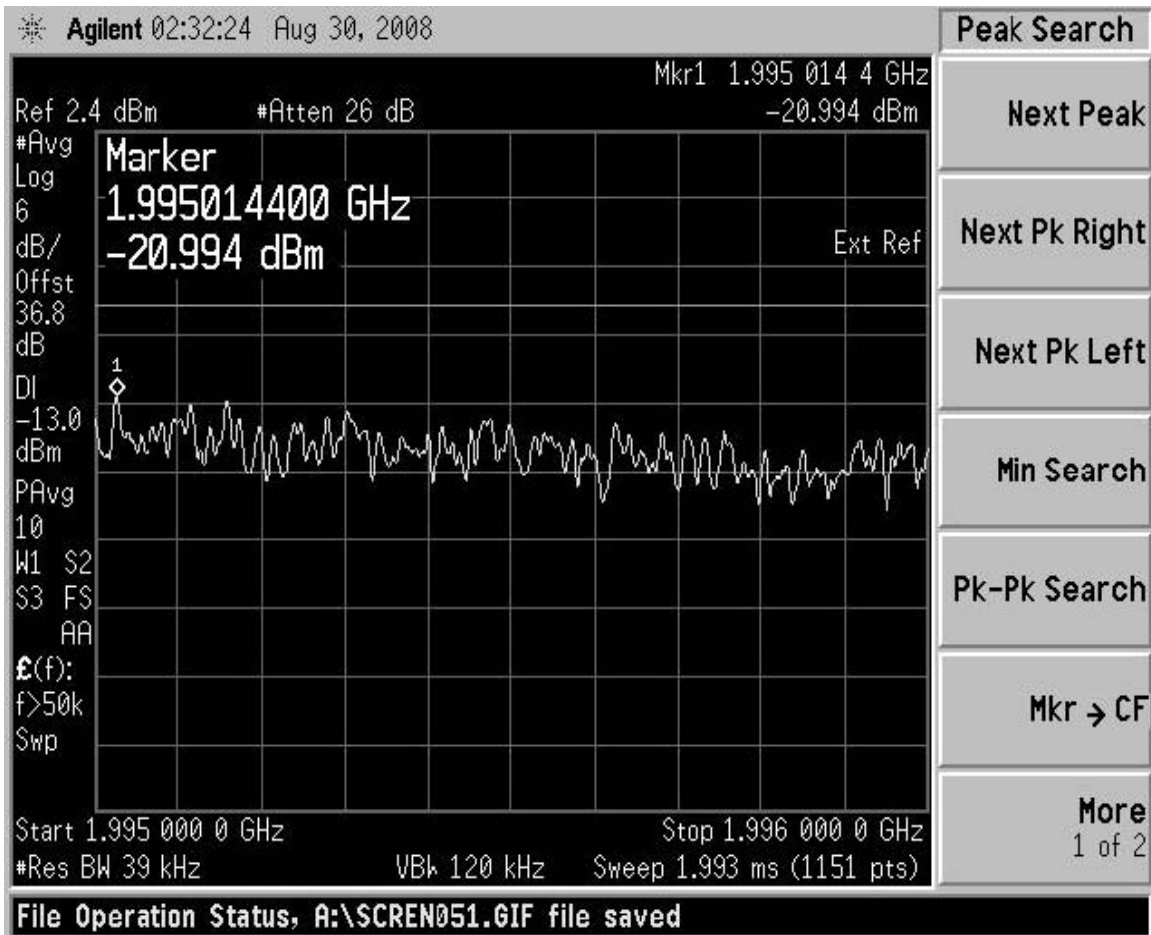

Figure 24: Spurious Emissions - 3 Carriers - Channel 1225, 1250, 1275, Upper Adjacent 1 MHz

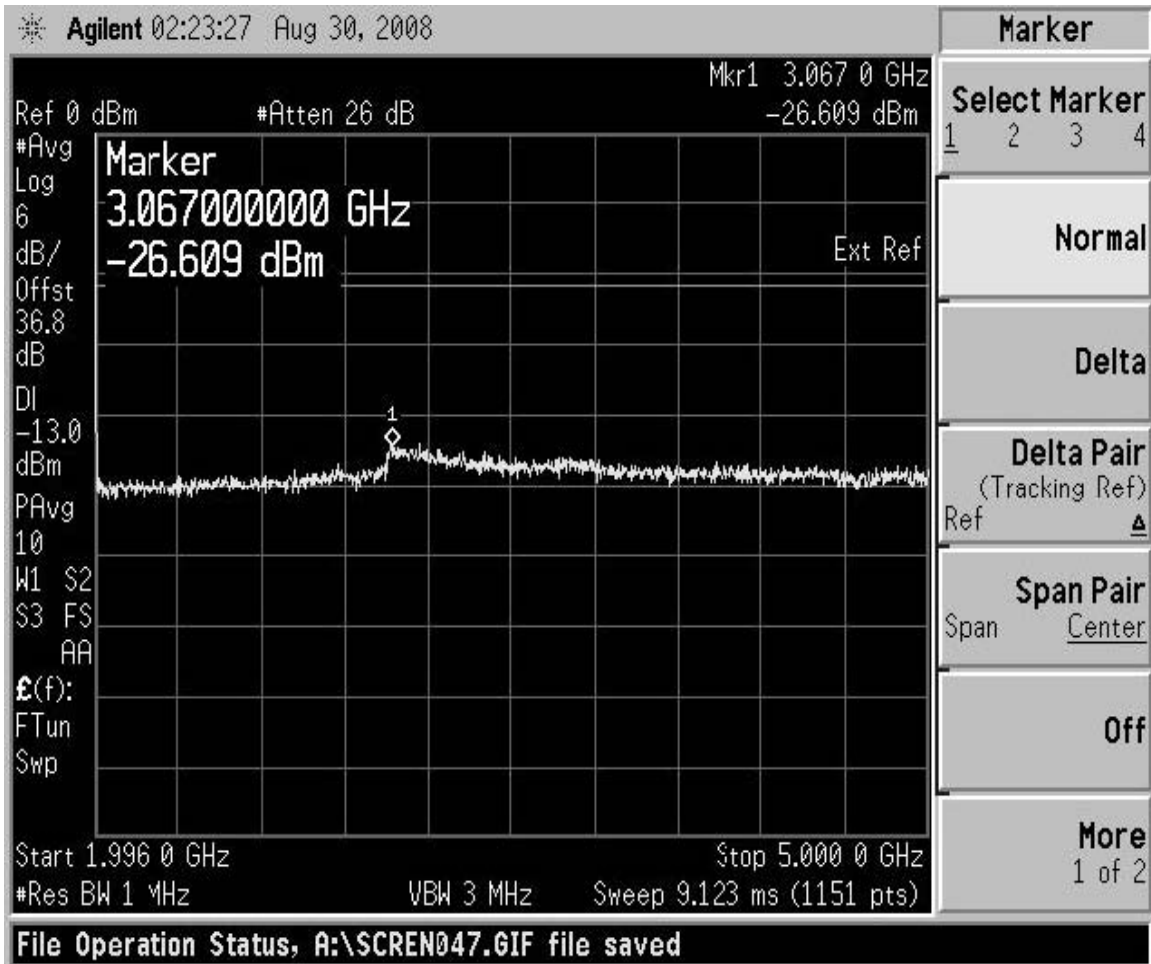

Figure 25: Spurious Emissions - 3 Carriers - Channel 1225, 1250, 1275, Upper Adjacent 1 MHz to 5 GHz

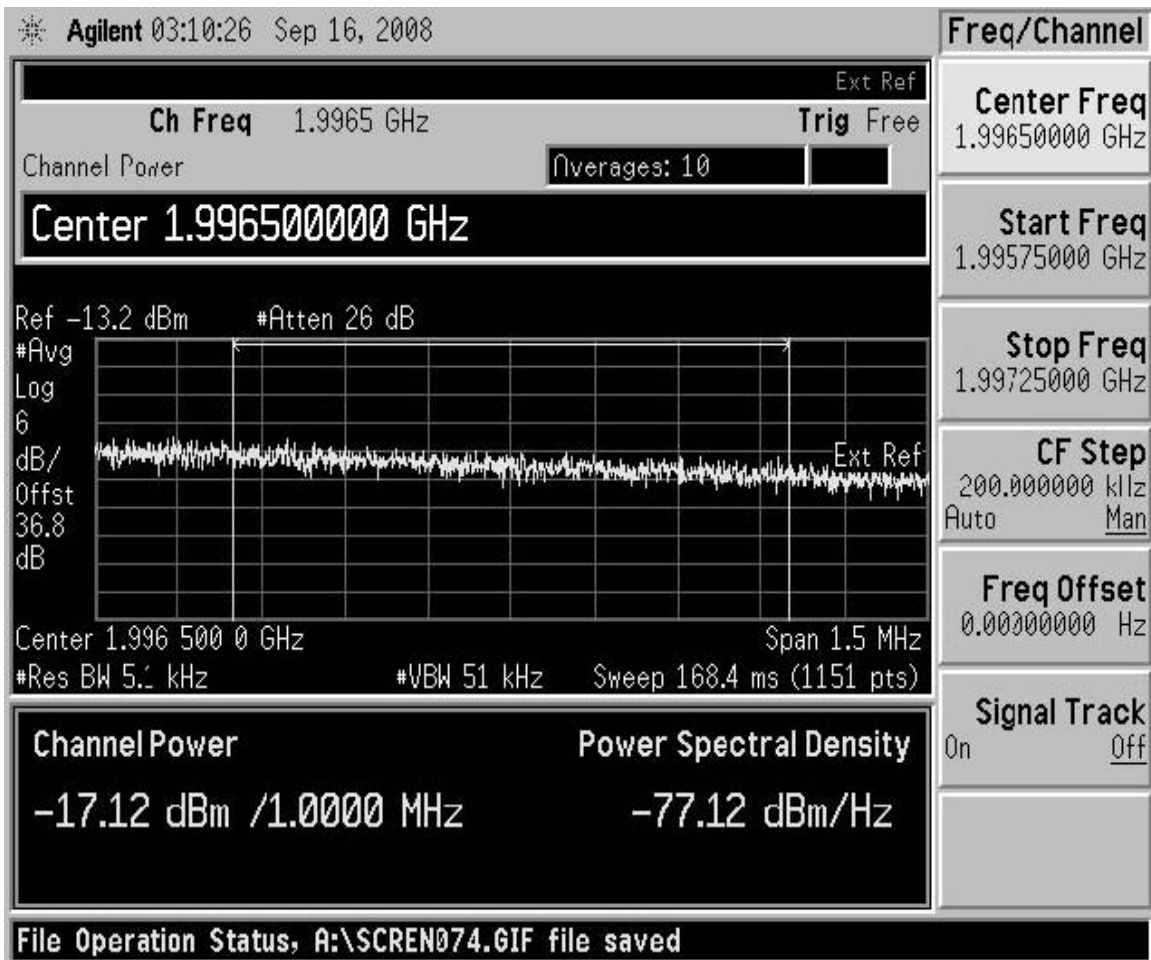

Figure 26: Spurious Emissions - 3 Carriers - Channel 1225, 1250, 1275, Upper Adjacent 1 MHz to 5 GHz (Verification)



Figure 27: Spurious Emissions - 3 Carriers - Channel 1225, 1250, 1275, 5 GHz to 22 GHz