

# Amber Helm Development L.C.

92723 Michigan Hwy-152  
Sister Lakes, MI 49047

## EMC Test Report

#01001348FX

Issued 06/11/2010

### Regarding the FCC 15.247 testing of



### V50-2X End Unit

Model Numbers : 31570001-12, 31570001-13

Grantee FCC Registration Number: 0018833475 Grantee Code: X3R

FCC IDs: X3R-31570001-12, X3R-31570001-13 Equipment Class: K1D

Category: **2.4 GHz Intentional Radiating Transceiver Device**

**Judgments: FCC Article 15.247, FCC Part 15 Intentional Radiator – Compliant**  
(Note: Spurious data within spec and outside of AHD's 95% 1.4dB confidence margin)



NVLAP LAB CODE 200129-0

Prepared for:

Bob Porter  
AMPT LLC  
4850 Innovation Dr.  
Ft. Collins, Co. 80525

Test Date(s):

03/25/10-05/27/10

Report prepared by:



David J. Miller, NCE

Report reviewed by



Gordon Helm, NCE

Data recorded by:



Gordon Helm, NCE  
Test Engineer, AHD

**Table of Contents**

Statements concerning this report.....	3
FCC Required user statements:.....	4
Summary of Results.....	5
Changes Made to Achieve Compliance:.....	7
EUT Descriptions.....	8
Specifications:.....	9
EUT Block Diagram:.....	12
EUT Pictures.....	13
Equipment Test Setup:.....	16
Support Equipment & Cabling.....	16
Setup Pictures.....	17
Measurement Report.....	22
Standards Applied to Test.....	22
Equipment Configuration.....	22
Test Methodology.....	22
Line Conducted:.....	22
Radiated.....	23
Variance from Test Procedure:.....	24
Test Data.....	25
Line Conducted:.....	25
Radiated Spurious Emissions.....	27
Radiated Receive Local Oscillator Emissions.....	29
Radiated Transmit Emissions.....	30
RF Exposure Calculation:.....	42
Measurement Facilities & Equipment.....	43
Test Site 2.....	43
Environment.....	44
APPENDIX A.....	45
Measurement Procedures.....	45
Line Conducted.....	45
Radiated.....	46
Cable Loss.....	47
Antenna Factors.....	48
AHD Accreditation.....	49
NARTE Seal.....	50

**Statements concerning this report****NVLAP Accreditation: NVLAP Lab Code 200129-0**

The scope of AHD accreditation are the test methods of:

IEC/CISPR 22:	Limits and methods measurement of radio disturbance characteristics of information technology equipment.
FCC Method – 47 CFT Part 15:	Digital Devices.
AS/NZS 3548:	Electromagnetic Interference – Limits and Methods of Measurement of Information Technology Equipment.
IEC61000-4-2 and Amend.1:	Electrostatic Discharge Immunity
IEC61000-4-5:	Surge Immunity

**Test Data:**

This test report contains data included in the scope of NVLAP accreditation.

**Subcontracted Testing:**

This report contains data recorded at the University of Michigan Radiation Laboratory. The University of Michigan test facility is located at 8501 Beck Road, Belleville, Michigan 48111. This test facility has been fully described and accepted by the FCC and Industry Canada. This facility was utilized to measure emissions occurring at frequencies greater than 6GHz.

**Test Traceability:**

The calibration of all measuring and test equipment and the measured data using this equipment are traceable to the National Institute for Standards and Technology (NIST).

**Limitations on results:**

The test results contained in this report relate only to the Item(s) tested. Any electrical or mechanical modification made to the test item subsequent to the test date shall invalidate the data presented in this report. Any electrical or mechanical modification made to the test item subsequent to this test date shall require an evaluation to verify continued compliance.

**Limitations on copying:**

This report shall not be reproduced, except in full, without the written approval of AHD.

**Limitations of the report:**

This report shall not be used to claim product endorsement by NVLAP, FCC, or any agency of the US Government.

**Statement of Test Results Uncertainty:**

Following the guidelines of NAMAS publication NIS81 and NIST Technical Note 1297, the Measurement Uncertainty at a 95% confidence level is determined to be: +/-1.4 dB

**Retention of Records:**

For equipment verified to comply with FCC regulations, the manufacturer is obliged to retain this report with the product records for ten years following the manufacture of the equipment that was tested.

For equipment verified to comply with RSS-210, the manufacturer is obliged to retain this report with the product records for as long as the model is being marketed in Canada.

**FCC Required user statements:**

**Applies to:** [Class B Digital Device or Peripheral].

For products satisfying the FCC Part 15 Class B requirements the following are to be satisfied:

1. The following statement is required to be labeled on the product or, if the device is too small, in the user's manual:

*This device complies with part 15 of the FCC Rules. Operation is subject to the following two conditions: (1) This device may not cause harmful interference, and (2) this device must accept any interference received, including interference that may cause undesired operation.*

2. A statement is required to be placed in the User's Manual shall caution the user that changes or modifications not expressly approved by the party responsible for compliance could void the user's authority to operate the equipment.
3. The User's Manual shall include this or similar statement:

*NOTE: This equipment has been tested and found to comply with the limits for a Class B digital device, pursuant to part 15 of the FCC Rules. These limits are designed to provide reasonable protection against harmful interference in a residential installation. This equipment generates, uses, and can radiate radio frequency energy and, if not installed and used in accordance with the instruction manual, may cause harmful interference to radio communications. However, there is no guarantee that interference will not occur in a particular installation. If this equipment does cause harmful interference to radio or television reception, which can be determined by turning the equipment off and on, the user is encouraged to try to correct the interference by one or more of the following measures:*

- *Reorient or relocate the receiving antenna.*
- *Increase the separation between the equipment and receiver.*
- *Connect the equipment into an outlet on a circuit different from that to which the receiver is connected.*
- *Consult the dealer or an experienced radio/TV technician for help.*

4. For products certified using the Declaration of Conformity approach,
  - a. The FCC conformity LOGO is to be placed on the Class B Digital Device.

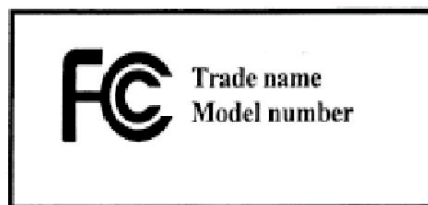

- b. The FCC requires a Compliance Information statement (Declaration of Conformity) to accompany each product to the end user.

## **Summary of Results**

1. The device model number 31570003-10 was tested for compliance with FCC Regulations, Part 15, SubPart C.
2. The test results apply to models 31570001-12 and 31570001-13.
3. The system tested is compliant to the requirement of CFR 47, FCC Part 15, SubPart C for operation in the 2400-2483.5 MHz frequency band, article 15.247, as a hybrid system with both frequency hopping and digital modulation modes of operation.
4. These tests were performed at AHD EMC Laboratory following the procedures outlined in ANSIC63.4.
5. The equipment under test was received on 3/25/10 and this test series commenced on 3/25/10.
6. In 120VAC 60Hz operation, the conducted emission level nearest the limit during normal tx / rx operation occurred at 170 kHz. The signal was measured to be 11.04dB below the Class B Quasi-Peak limit and 40.34 dB below the Class B Average limit when measuring phase to ground.
7. The spurious radiated emission level nearest the limit during normal tx / rx operation occurred at 45.48 MHz vertically polarized. This signal was measured to be 0.24 dB below the Class B Quasi-peak limit. Note that this measurement is outside of AHD's 95% 1.4dB confidence margin.
8. The radiated fundamental Local Oscillator emission level nearest the limit occurred at 2441 MHz. The signal was measured to be 38.7 dB below the FCC class B average limit.
9. The radiated harmonic Local Oscillator emission level nearest the limit occurred 4883 MHz. This signal was measured to be 18.9 dB below the FCC class B average limit.
10. Fundamental transmit band edge measurements were performed in all three operational modes: frequency hopping, 250Kbod broadband, and 500Kbod broadband, using an average detection method. The worst case band edge spurious emission occurred at 2482.8 MHz in 500 Kbod broadband mode. The signal was measured to be 22.5 dB below the FCC class B average limit.
11. A maximized data rate mode was used to measure transmit power in peak detector mode, therefore a correction factor corresponding to the normal operational duty cycle is required to correlate peak measurements to the limits expressed in terms of average detection. The width of a transmitted packet was measured to be 30.042 mSec. The time period from one packet to the next was measured to be 5564.63mSec. Over the FCC 15.35c specified 100 mSec period, the packet width represents a 30% duty cycle, or -10.45 dB correction factor.
12. The fundamental transmission level was measured using radiated emissions measurements. The formula used to convert measured electrical field strength to conducted power was  $EIRP = ((D^2 * E^2) / 30G)$ . The distance used in the measurement was 3 Meters ( $D=3$ ) and the antenna gain factor used in calculations was one ( $G=1$ ). While the manufacturer specified antenna gain is specified at 2.15dB, a gain factor of one is used in the calculations to ensure worst case calculations.
13. The radiated fundamental transmit emission level nearest the limit occurred at 2442.09 MHz. The field strength level of the fundamental was observed to be 124.5 mW below the average

limit of 125mW The EUT was positioned on the flat orientation and the receive antenna oriented in the Horizontal polarization.

14. The radiated second harmonic transmit emission level nearest the limit occurred at 4819.75 MHz. The field strength level was observed to be 3.51 dB below the average limit of 54dBuV/m (500uV/m). The EUT was positioned on the FLAT orientation and the receive antenna oriented in the Horizontal polarization.
15. The radiated upper level harmonic transmit emission level nearest the limit occurred at 24735 MHz. The field strength level was observed to be 13.73 dB below the average limit of 54 dBuV/m (500uV/m).
16. As a frequency hopping device, the system operates on 26 channels, with one channel left blank. This meets the minimum 15 channel requirement of 15.247.a.1
17. As a frequency hopping device, the system operates with each channel occupying a 713 KHz 20 dB bandwidth, and each channel separated by 2.52 MHz. The carrier separation is 1.81 MHz wider than the 20dB bandwidth, satisfying the 15.247.a.1 requirement for channel separation.
18. The algorithm used for selecting hopping frequencies is pseudo random in nature, using the base channel as an algorithmic “seed” frequency. The algorithm ensures equal distribution among available channels during operation.
19. The time occupied per any channel in any 10.4 second cycle (0.4 seconds\*26 channels) is by design at most 374.16 mS, satisfying the maximum 15.247.a.iii limit of 400 mSec on any channel per cycle.
20. The antenna used in the system is integrated on the system PCB, and has a specified maximum gain of 2.15dB.
21. In frequency hopping mode, the peak in band 100KHz BW signal strength is 98.69 dBuV. The strongest 100 KHz non operating band signal strengths adjacent to the in band peak signals are more than 20dB below the peak, satisfying the 15.247.d requirements.
22. As a 250 Kbod digitally modulated device, the system operates on 10 channels. As a 500Kbod digitally modulated device, the system operates on up to 25 channels.
23. As a 250 digitally modulated device, the minimum 6 dB bandwidth of any channel is 630 KHz. As a 500 digitally modulated device, the minimum 6 dB bandwidth of any channel is 550 KHz. Both digital modes satisfy the minimum bandwidth requirements 500 KHz in 15.247.a.2.
24. As both 250 Kbod and 500Kbod digitally modulated devices, the maximum power of the device is 0.51 mW. This satisfies the 1000 mW maximum signal requirements of 15.247.d
25. As a digitally modulated device, the maximum 3KHz power density of the device is 93.6 dBuV, or -1.63dBm. This is 9.63 dB below the 15.247.e limit of 8 dBm.
26. Under normal operating conditions, the general public is not exposed to this device. However, even under conditions of exposure to this device at a distance of 2.5 cm, the expected exposure is .006 mw/cm<sup>2</sup>, or 0.994mw/cm<sup>2</sup> under the FCC 1.1310 general population limit of 1 mw/cm<sup>2</sup>.
27. With regard to SAR evaluation, the worst case EIRP of 0.51 mW is 23.98 mW below the FCC KDB 447948 recommended SAR evaluation limit of 24.5 mW at 2.45 GHz.

**Changes Made to Achieve Compliance:**

1. 3 Ohm Resistor in Series with Power Supply
2. Test performed with 16 Ohm load configuration

## **EUT Descriptions**

**Model:** V50-2X End Unit

**Model numbers:** 31570001-12, 31570001-13

**Power Specification: Device Controls 102V, 420W Max**

**Serial/ID No:** 0310K004089

**Antenna: 2.15 dB gain, Integrated on PCB**

**PCB: AMPT 33070007**

### **Description:**

This device is a Hybrid – mode (Frequency hopping and / or digital modulation) radio controlled Solar Array Management System End Unit. The device can be configured in one of three modes. End Unit mode utilizes 25 frequency hopping channels, with each channel separated by 10 of the possible 256 channels. The exact subset of 25 hopping channels utilized depends on the initial channel selected during initialization.

When operating in Digital Modulation mode, the device operates in one of two modes: a 250 Kbd 25 fixed channel mode, with each channel separated by 10 of the possible channels, or a 500 Kbd 10 fixed channel mode, with each channel separated by 25 of the possible channels. The 500 Kbd 10 channel mode is included for backward compatibility with previous products. The frequency usage, channel selection, and hopping algorithms are described in a separate proprietary Exhibit B document.

### **ED Modes.**

Any given ED may be in 3 distinctively different modes. ED may be commanded to switch between those 3 modes. ED on some circumstances ( "search algorithm" enabled ) may switch himself between those modes while searching for connection to Gateway. Those modes are as follows:

1. "FREE RUNNING ED" mode transmits at the same speed as gateway (12 kbod) and hops by the same frequency sequence as the gateway. It is guaranteed that its transmission is no longer than 31.18 ms in any given cycle. Free running ED mode is a 15.247 device according to paragraph (1) of page 818 of 47CFR15.247 2008 revision.

2. SLAVE mode stays on single frequency with digital modulation turned on. It may be guaranteed that it does not transmit longer then 5 ms in any given cycle. In this mode ED behaves as 15.247 device as described in paragraph (2) on page 819 of 47CFR15.247 2008 revision.

3. REPEATER. Behaves mostly the same way as (1), but it also retransmits GW packages at 250 or 500 kbod to slaves, no longer than 5 ms in any cycle. Then it listens and receives digitally modulated packets from slaves and retransmits slaves packets on 12 kbod to the Gateway on hopping frequencies. In a worst case scenario it transmits no more then 78 ms in any sliding 100 ms window.



In this mode the ED is a 15.247 hybrid device, according to paragraph (f) of page 821 of 47CFR15.247 2008 revision.

Digital Modulation Power Density requirements are satisfied by the fact that both 250 and 500 kbod transmissions utilize 5 ms per cycle with the same power level as Slave ED.

In our system devices hops on 25 frequencies, so the period between one given frequency is 25 \* cycle\_size. The first limitation may be translated to following:

ED on any given hopping frequency cannot transmit longer then 400 ms if cycle is longer then 0.4 seconds.

Each transmission on the hopping frequency is 31.18 ms long, so, repeater is allowed for  $400 / 31.18 = 12$  transmissions per cycle. The exact production algorithm describing how we guarantee that each Repeater uses no more then 12 timeslots is attached.

## Specifications:

**Input Power:** Nominal 48 VDC. Power input is regulated over a range from 12VDC to 120VDC

**Outputs Signals:** DC power to external load, 2.4 GHZ Transmit

**Input Signals: 2.4 GHz Receive**

## Channel Frequencies:

Ch	Freq, MHz	Example: Ch 0 Hopping or Slave 250 Kbod freq:	Example: Slave 500Kbod operation:
0	2410.000	0 2410.000	0 2410.000
1	2410.253	10 2412.527	25 2416.317
2	2410.505	20 2415.054	50 2422.634
3	2410.758	30 2417.581	75 2428.951
4	2411.011	40 2420.107	100 2435.269
5	2411.263	50 2422.634	125 2441.586
6	2411.516	60 2425.161	150 2447.903
7	2411.769	70 2427.688	175 2427.688
8	2412.021	80 2430.215	200 2430.215
9	2412.274	90 2432.742	225 2432.742
10	2412.527	100 2435.269	
11	2412.780	110 2437.795	
12	2413.032	120 2440.322	
13	2413.285	130 2442.849	
14	2413.538	140 2445.376	
15	2413.790	150 2447.903	
16	2414.043	160 2450.430	
17	2414.296	170 2452.957	
18	2414.548	180 2455.483	
19	2414.801	190 2458.010	
20	2415.054	200 2460.537	

## FCC Article 15.247, FCC Part 15 Class B for AMPT V50X2 End Unit

---

21	2415.306	210	2463.064
22	2415.559	220	2465.591
23	2415.812	230	2468.118
24	2416.064	240	2470.645
25	2416.317		
26	2416.570		
27	2416.823		
28	2417.075		
29	2417.328		
30	2417.581		
31	2417.833		
32	2418.086		
33	2418.339		
34	2418.591		
35	2418.844		
36	2419.097		
37	2419.349		
38	2419.602		
39	2419.855		
40	2420.107		
41	2420.360		
42	2420.613		
43	2420.865		
44	2421.118		
45	2421.371		
46	2421.624		
47	2421.876		

Ch	Freq	Ch	Freq	Ch	Freq	Ch	Freq	Ch	Freq
48	2422.129	97	2434.510	146	2446.892	195	2459.274	244	2471.655
49	2422.382	98	2434.763	147	2447.145	196	2459.526	245	2471.908
50	2422.634	99	2435.016	148	2447.397	197	2459.779	246	2472.161
51	2422.887	100	2435.269	149	2447.650	198	2460.032	247	2472.413
52	2423.140	101	2435.521	150	2447.903	199	2460.284	248	2472.666
53	2423.392	102	2435.774	151	2448.156	200	2460.537	249	2472.919
54	2423.645	103	2436.027	152	2448.408	201	2460.790	250	2473.171
55	2423.898	104	2436.279	153	2448.661	202	2461.042	251	2473.424
56	2424.150	105	2436.532	154	2448.914	203	2461.295	252	2473.677
57	2424.403	106	2436.785	155	2449.166	204	2461.548	253	2473.929
58	2424.656	107	2437.037	156	2449.419	205	2461.801	254	2474.182
59	2424.908	108	2437.290	157	2449.672	206	2462.053	255	2474.435
60	2425.161	109	2437.543	158	2449.924	207	2462.306		
61	2425.414	110	2437.795	159	2450.177	208	2462.559		
62	2425.667	111	2438.048	160	2450.430	209	2462.811		
63	2425.919	112	2438.301	161	2450.682	210	2463.064		
64	2426.172	113	2438.553	162	2450.935	211	2463.317		
65	2426.425	114	2438.806	163	2451.188	212	2463.569		
66	2426.677	115	2439.059	164	2451.440	213	2463.822		
67	2426.930	116	2439.312	165	2451.693	214	2464.075		
68	2427.183	117	2439.564	166	2451.946	215	2464.327		
69	2427.435	118	2439.817	167	2452.198	216	2464.580		
70	2427.688	119	2440.070	168	2452.451	217	2464.833		
71	2427.941	120	2440.322	169	2452.704	218	2465.085		

FCC Article 15.247, FCC Part 15 Class B for AMPT V50X2 End Unit

---

72 2428.193	121 2440.575	170 2452.957	219 2465.338
73 2428.446	122 2440.828	171 2453.209	220 2465.591
74 2428.699	123 2441.080	172 2453.462	221 2465.844
75 2428.951	124 2441.333	173 2453.715	222 2466.096
76 2429.204	125 2441.586	174 2453.967	223 2466.349
77 2429.457	126 2441.838	175 2454.220	224 2466.602
78 2429.709	127 2442.091	176 2454.473	225 2466.854
79 2429.962	128 2442.344	177 2454.725	226 2467.107
80 2430.215	129 2442.596	178 2454.978	227 2467.360
81 2430.468	130 2442.849	179 2455.231	228 2467.612
82 2430.720	131 2443.102	180 2455.483	229 2467.865
83 2430.973	132 2443.354	181 2455.736	230 2468.118
84 2431.226	133 2443.607	182 2455.989	231 2468.370
85 2431.478	134 2443.860	183 2456.241	232 2468.623
86 2431.731	135 2444.113	184 2456.494	233 2468.876
87 2431.984	136 2444.365	185 2456.747	234 2469.128
88 2432.236	137 2444.618	186 2457.000	235 2469.381
89 2432.489	138 2444.871	187 2457.252	236 2469.634
90 2432.742	139 2445.123	188 2457.505	237 2469.886
91 2432.994	140 2445.376	189 2457.758	238 2470.139
92 2433.247	141 2445.629	190 2458.010	239 2470.392
93 2433.500	142 2445.881	191 2458.263	240 2470.645
94 2433.752	143 2446.134	192 2458.516	241 2470.897
95 2434.005	144 2446.387	193 2458.768	242 2471.150
96 2434.258	145 2446.639	194 2459.021	243 2471.403

**EUT Block Diagram:**

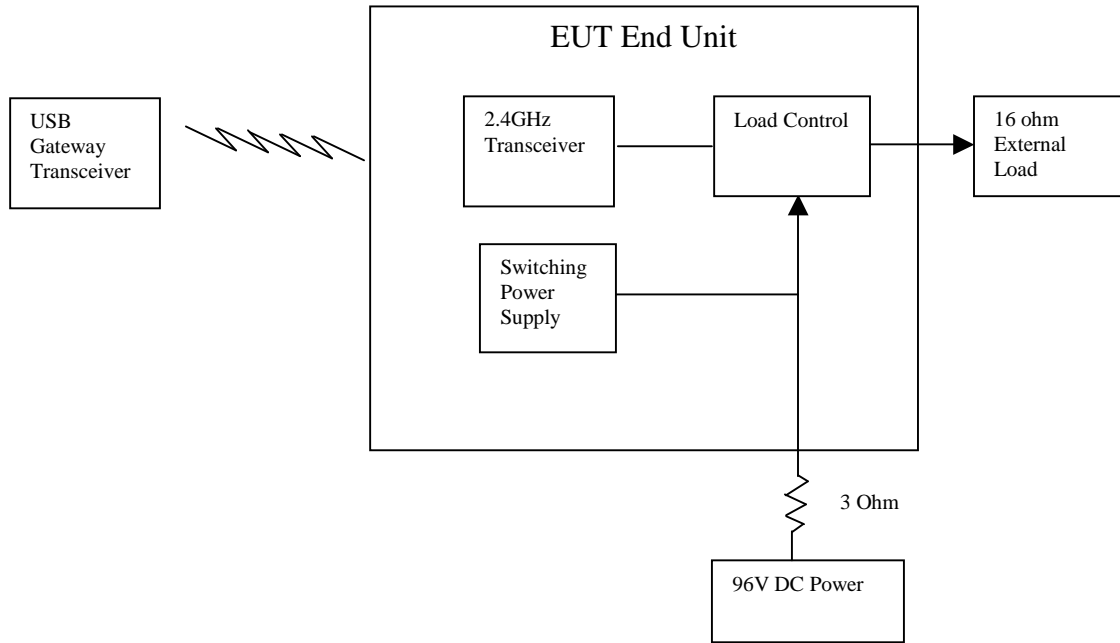

## EUT Pictures

Exterior Top View	Page 13
Exterior Bottom View	Page 13
Interior PCB Top View	Page 14
Interior PCB Bottom View	Page 14
Associated USB Gateway Device	Page 15
Gateway Control Application	Page 15

### Exterior Top View



### Exterior Bottom View

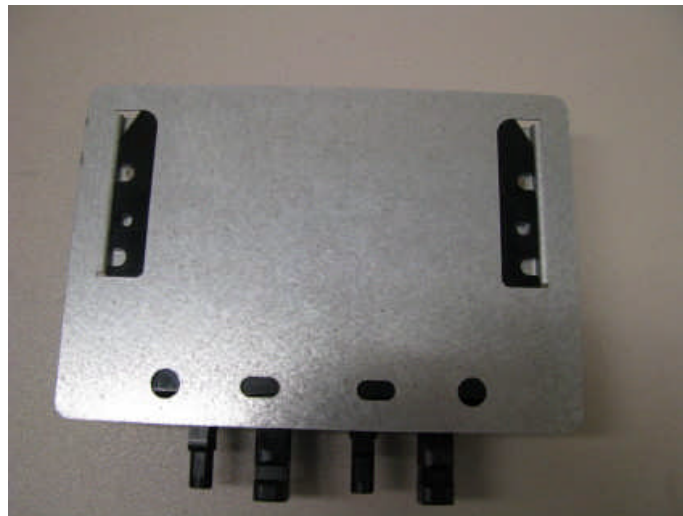

### Interior PCB Top View

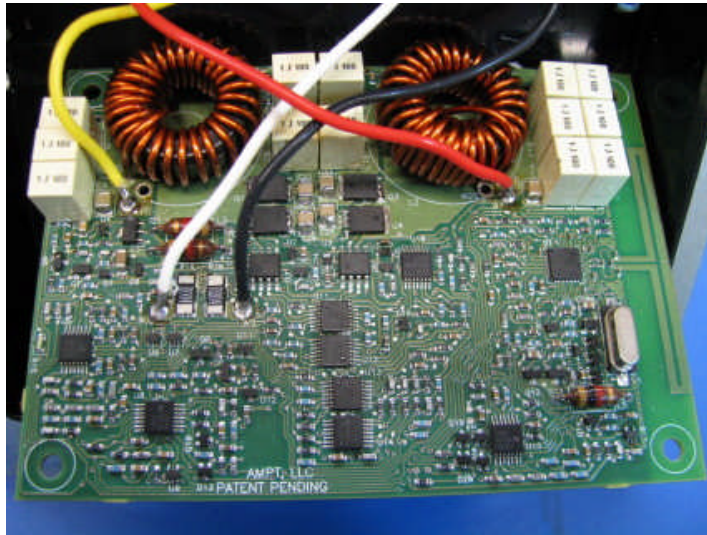

### Interior PCB Bottom View

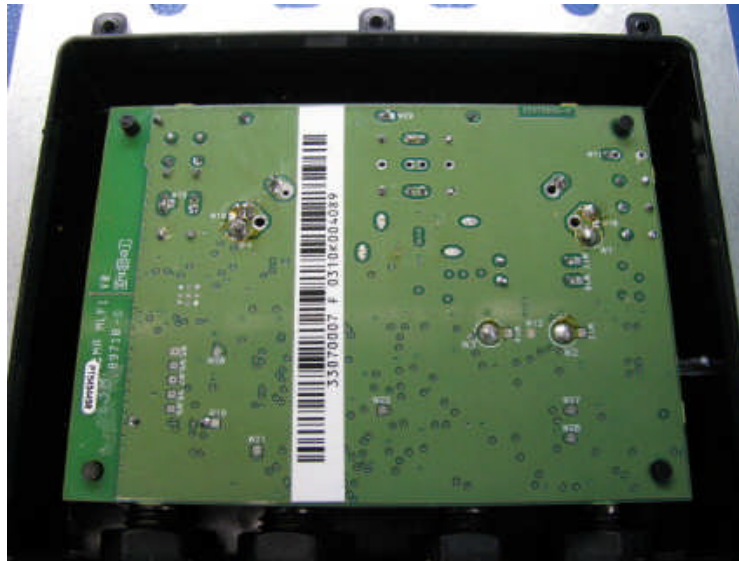

### USB Gateway Device View



### Gateway Control Application View

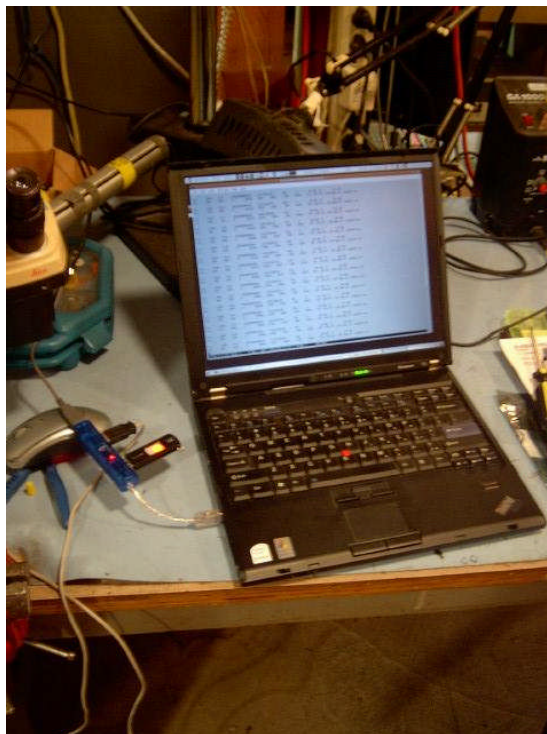

**Equipment Test Setup:**

**Support Equipment & Cabling**

Setup Diagram Legend	Description	Model	Serial No. / Part No.	EMC Consideration
A	End Unit Transceiver	31570011-10	0310K004089	2.4 GHZ TRANSCEIVER
B	Power Supply	Kempco	ATE-55-5M	1 Meter Shielded
C	Load Unit	8 ea - Dale 1 Ohm Resistor Array in series with 2 ea 16 ohm resistors connected in parallel	RE75G1R0	CAL RMC50030W 1% / FVE-300-16
D	Load Cable			3 Meters
E	Power Supply DC Cable			3 Meters
F	48V DC Battery			

**Block Diagram**

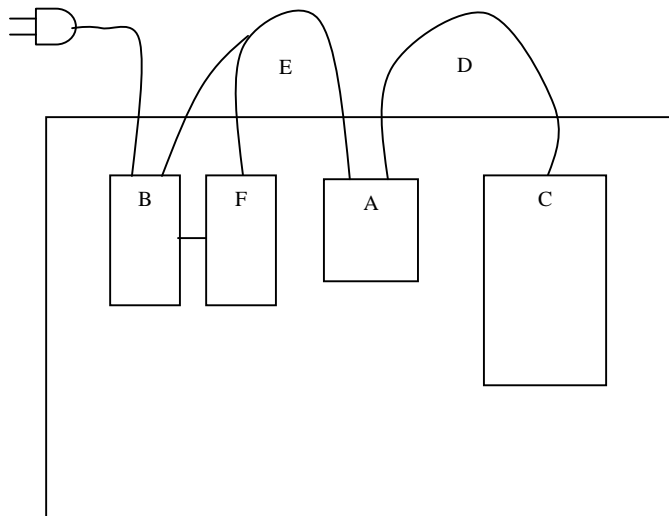



## Setup Pictures

Spurious Radiated Prescreen Setup	Page 17
Conducted Setup Front View	Page 18
Conducted Setup Rear View	Page 18
Spurious and Rx Radiated Setup Front View	Page 19
Spurious and Rx Radiated Setup Rear View	Page 19
Transmit Setup Front Orientation	Page 20
Transmit Setup End Orientation	Page 20
Transmit Setup Side Orientation	Page 21

### Spurious Radiated Prescreen Setup



### Conducted Setup Front View



### Conducted Setup Rear View



### Spurious and Rx Radiated Setup Front View

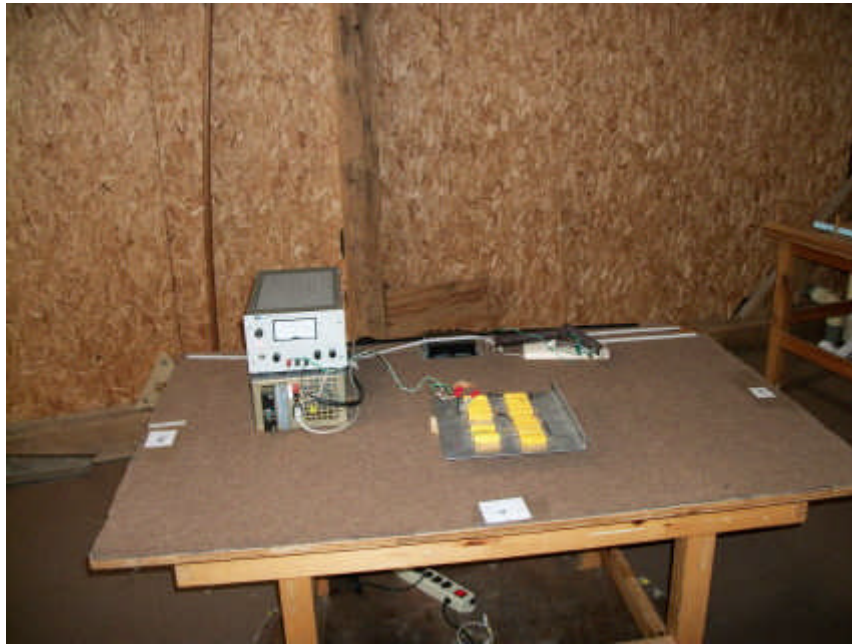

### Spurious and Rx Radiated Setup Rear View

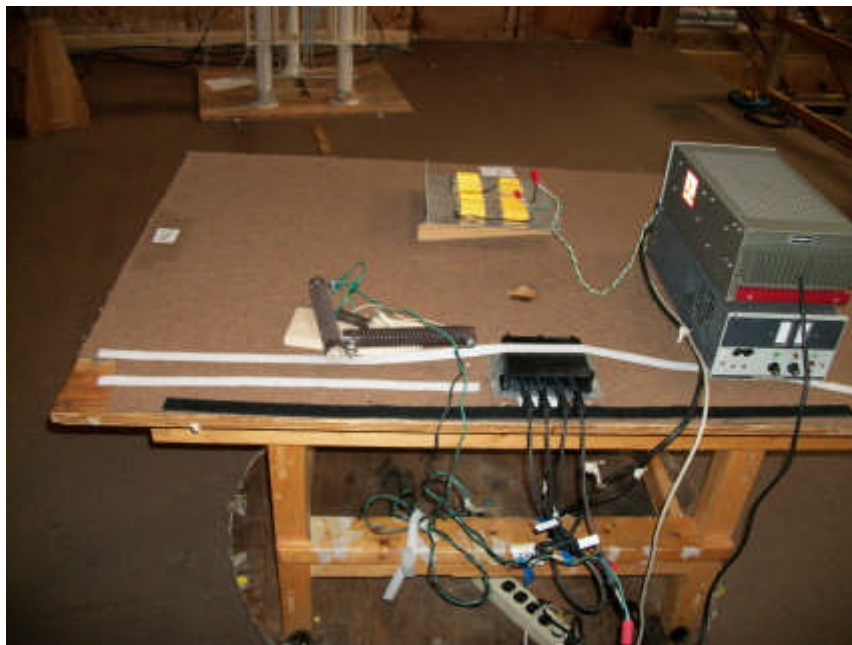

### Transmit Setup Flat Orientation

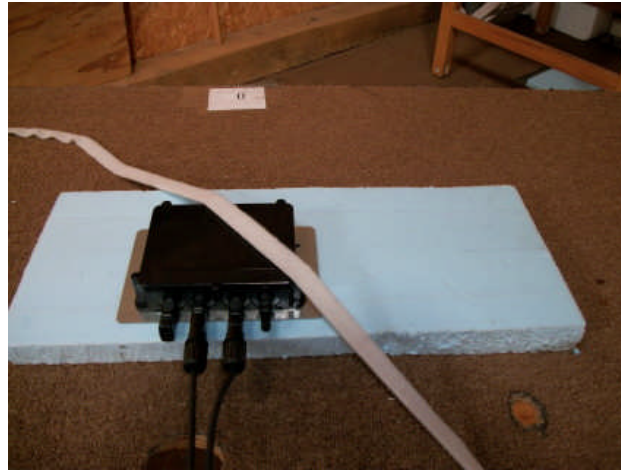

### Transmit Setup End Orientation



### Transmit Setup Side Orientation



## **Measurement Report**

### **Standards Applied to Test**

ANSI C63.4 – 2003

CFR47 FCC Part 15, Subpart B, Class B limits

AHD test procedures TP0101-01, TP0102-01

### **Equipment Configuration**

For the testing, the placement of the EUT and the support equipment was selected to –

- Be a representation of a configuration typical of user installation, and
- Comply with the minimum system configuration of ANSI C63.4.

### **Test Methodology**

#### **Line Conducted:**

Detailed Line Conducted test methodology is located in Appendix A.

Conducted testing was performed in normal operating mode, with the device configured for 400 watt operation (76V at 5.2A).

The cable losses of the coax used in line conducted testing are charted in this appendix.

## **Radiated**

Spurious, transmit, and receive radiated testing was performed at a 3 meter open field test site, and completed according to the procedures in FCC 15, Subpart B with supporting instructions from ANSI C63.4. Please reference Appendix A for further details on Test Methodology.

A scan of the EUT was made in a shielded room to study the emission profile of this EUT. This scan indicated low level spurious emissions from the unit.

The suspect spurious signals recorded in the shielded room prescan for each module were then measured at the 3-meter open area test site. Spurious radiated emissions were measured in normal operating tx/rx mode with the EUT loaded to its maximum power capacity, 400 Watts (80V at 5.00A).

For transmit signal strength measurement, the EUT was configured to operate in a maximized packet rate mode and measurements were taken at the mid-range fundamental and second harmonic frequencies (2442, 4884 MHz) in two polarizations (horizontal, vertical) and three orientations (flat, side, and end.) This was done to determine the EUT orientation that maximized emissions.

Once positioned in the maximized orientation, the EUT was tested at the low (2410 MHz), mid range (2442 MHz), and high (2475 MHz) operating frequencies within the EUT's operating range.

Because the EUT has an integrated antenna, measurements were converted from electrical field strength (dBuV/m) to EIRP (watts and dBm) using the formula  $P = (ED)^2/30$ .

Because maximized packet rate mode was utilized to test the device, zero span (time scale) measurements were taken to determine PWM duty cycle attenuation over a 100 mSec period. Based on these findings, the maximized data rate mode (peak) measurements were then compensated -9.11 dB to provide average transmit signal strength for comparison to FCC limits.

Upper level harmonics were measured to 10 harmonics (24 GHz) over the total range of operating frequencies. Worst case signal conditions were recorded at harmonics of the low, mid, and high operating range frequencies.

For receive operation, the EUT was exercised at the low (2410 MHz), medium (2442 MHz), and high (2474 MHz) frequencies within the EUT's operating range, as well as 5 harmonics (12 GHz) of those frequencies. Averaging and peak detection methods were used and evaluated against averaging based limits. Worst case signal conditions were recorded. When local oscillator signals were not measurable at a distance of 3 meters, the device was located 10 cm from the antenna and a factor of -29.5 dB was used to adjust the measured signal to an equivalent 3 meter signal strength.

Tx and Rx Harmonics over 6 GHz were measured at the University of Michigan test Site (see Appendix.)

In addition, a variety of 15.247 specific band edge measurements were taken, in both frequency hopping and digital modulation modes.

The EUT under test was placed per ANSI C63.4

The EUT was exercised as follows:

1. Device was powered via external power supply
2. The device was activated via Gateway Transceiver Control Application
3. Receive Operation was evidenced by Local Oscillator signal
4. Transmit Operation was evidenced by Transmit Signal

The pictures, in the preceding pages, show the position of the equipment and cabling that produced the maximum signal level.

**Variance from Test Procedure:**

None



## Test Data

### Line Conducted:

#### NEUTRAL to Ground Measurement. Class B Plot of Peak Values

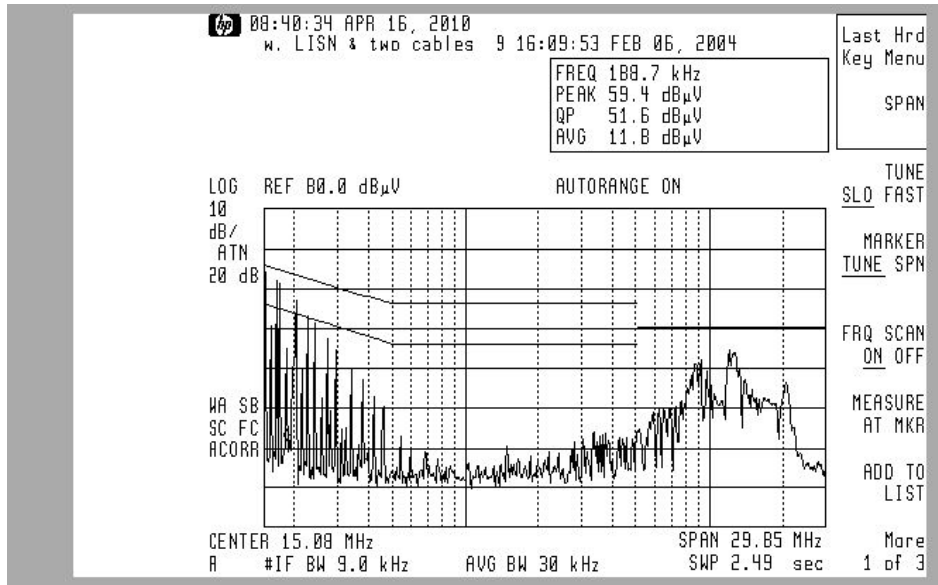

#### NEUTRAL to Ground Conducted Class B Tabulated Measurements

Frequency MHz	dBuV Reading		FCC / EN55022 dBuV Class B Limit		dB Margin	
	QP	Avg	QP	Avg	QP	Avg
<b>0.19</b>	<b>51.60</b>	<b>11.80</b>	64.09	54.09	12.49	42.29
<b>0.22</b>	<b>47.52</b>	<b>9.09</b>	62.91	52.91	15.39	43.82
<b>0.31</b>	<b>36.04</b>	<b>1.61</b>	59.99	49.99	23.95	48.38
<b>9.54</b>	<b>40.71</b>	<b>34.78</b>	60.00	50.00	19.29	15.22
<b>12.43</b>	<b>43.90</b>	<b>40.37</b>	60.00	50.00	16.10	9.63
<b>20.63</b>	<b>36.06</b>	<b>31.54</b>	60.00	50.00	23.94	18.46



### Radiated Spurious Emissions

#### Vertically Polarized 3 Meter Class B Graph of Spurious Quasi-Peak Measurements

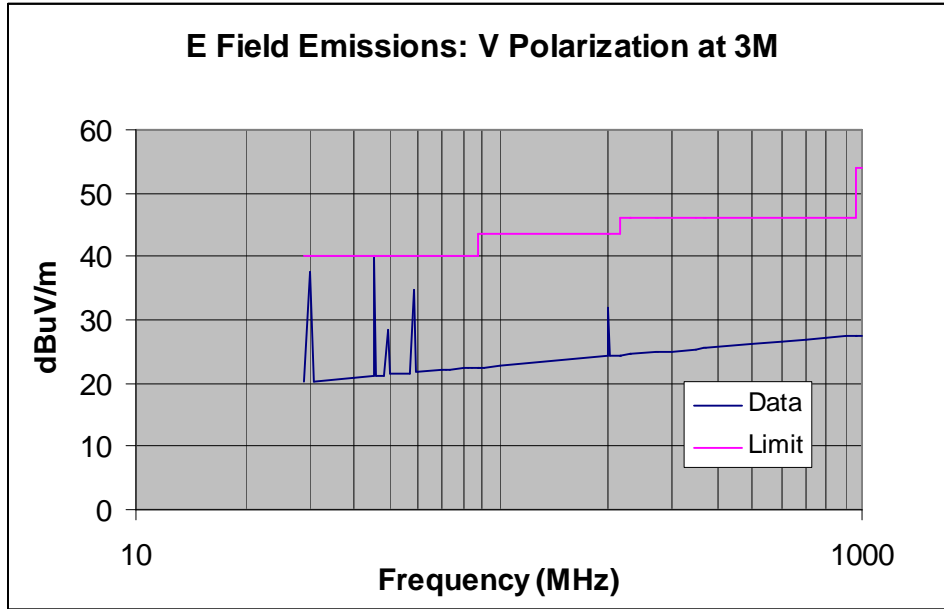

#### Mode Class B Tabulated Spurious Quasi-Peak Measurements

Frequency	Corrected Quasipeak Measurement	Turntable Azimuth	Antenna Height	FCC Class B Limit	Margin Class B
MHz	dBuV/m	deg	Mtr	dBuV/m	dBuV/m
<b>30.01</b>	<b>37.61</b>	<b>280</b>	<b>1.0</b>	<b>40.00</b>	<b>2.39</b>
<b>45.48</b>	<b>39.76</b>	<b>190</b>	<b>1.0</b>	<b>40.00</b>	<b>0.24</b>
<b>49.25</b>	<b>28.51</b>	<b>300</b>	<b>1.0</b>	<b>40.00</b>	<b>11.49</b>
<b>58.15</b>	<b>34.59</b>	<b>280</b>	<b>1.0</b>	<b>43.50</b>	<b>8.91</b>
<b>200.01</b>	<b>31.85</b>	<b>350</b>	<b>1.1</b>	<b>43.50</b>	<b>11.65</b>
<b>370.26</b>	<b>21.11</b>	<b>0</b>	<b>1.0</b>	<b>46.00</b>	<b>24.89</b>

**Horizontally Polarized  
Class B Graph of Spurious Quasi-Peak Measurements**

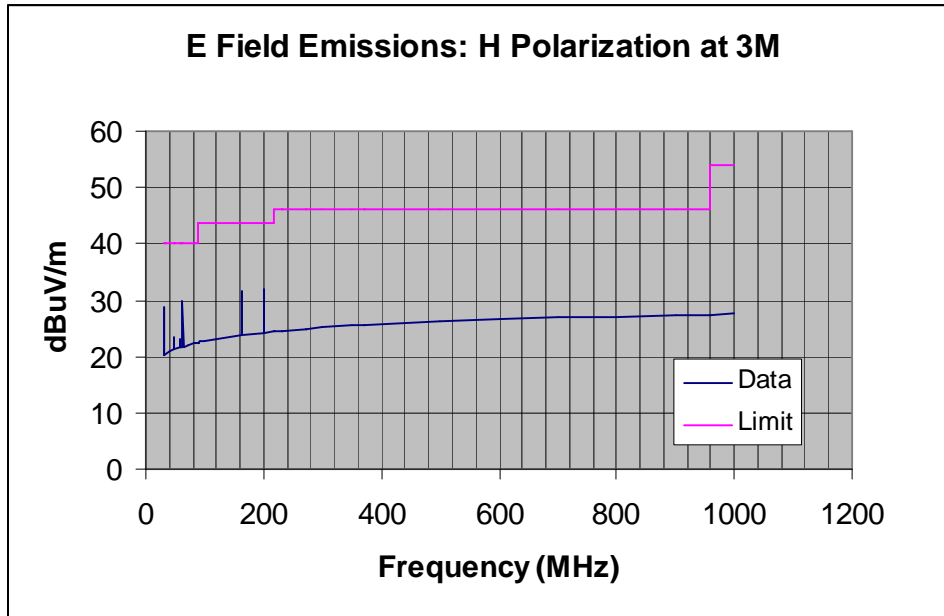

**Class B Tabulated Quasi-Peak Measurements**

Frequency	Corrected Quasipeak Measurement	Turntable Azimuth	Antenna Height	FCC Class b Limit	Margin
MHz	dBuV/m	deg	Mtr	dBuV/m	dBuV/m
<b>30.02</b>	<b>28.83</b>	<b>90</b>	<b>1.8</b>	<b>40.00</b>	<b>11.17</b>
<b>48.53</b>	<b>23.28</b>	<b>230</b>	<b>1.4</b>	<b>40.00</b>	<b>16.72</b>
<b>57.72</b>	<b>23.17</b>	<b>90</b>	<b>1.8</b>	<b>40.00</b>	<b>16.83</b>
<b>62.25</b>	<b>29.82</b>	<b>270</b>	<b>3.0</b>	<b>40.00</b>	<b>10.18</b>
<b>162.51</b>	<b>31.68</b>	<b>180</b>	<b>2.2</b>	<b>43.50</b>	<b>11.82</b>
<b>200.00</b>	<b>31.95</b>	<b>180</b>	<b>2.2</b>	<b>43.50</b>	<b>11.55</b>

**Radiated Receive Local Oscillator Emissions****Horizontally Polarized  
Class B Tabulated Peak Measurements**

Frequency	Corrected Peak Measurement	Turntable Azimuth	Antenna Height	FCC Class B Limit	Margin Class B
MHz	dBuV/m	deg	Mtr	dBuV/m	dBuV/m
<b>2409.00</b>	<b>12.70</b>	<b>0</b>	<b>1.0</b>	<b>54.00</b>	<b>41.30</b>
<b>2441.00</b>	<b>15.30</b>	<b>0</b>	<b>1.0</b>	<b>54.00</b>	<b>38.70</b>
<b>2473.00</b>	<b>14.00</b>	<b>0</b>	<b>1.0</b>	<b>54.00</b>	<b>40.00</b>
<b>4819.00</b>	<b>33.70</b>	<b>0</b>	<b>1.0</b>	<b>54.00</b>	<b>20.30</b>
<b>4883.00</b>	<b>35.10</b>	<b>0</b>	<b>1.0</b>	<b>54.00</b>	<b>18.90</b>
<b>4948.00</b>	<b>30.60</b>	<b>0</b>	<b>1.0</b>	<b>54.00</b>	<b>23.40</b>

\*Note: Rx signals were measured at a distance of 10cm from the antenna and adjusted by -29.5 dB to provide an equivalent 3 Meter signal strength.

**Maximized  
Class B Upper Harmonic Measurements**

Frequency	Corrected Average Measurement	Turntable Azimuth	Antenna Height	FCC Class B Limit	Margin Class B
MHz	dBuV/m	deg	Mtr	dBuV/m	dBuV/m
<b>7635.0</b>	<b>39.4</b>	<b>0</b>	<b>1.0</b>	<b>54.00</b>	<b>14.63</b>
<b>10180.0</b>	<b>39.3</b>	<b>0</b>	<b>1.0</b>	<b>54.00</b>	<b>14.68</b>
<b>12725.0</b>	<b>46.0</b>	<b>0</b>	<b>1.0</b>	<b>54.00</b>	<b>8.00</b>

Note: No signals detected, noise floor measurements

### Radiated Transmit Emissions

### Transmit Duty Cycle Period Width Plot

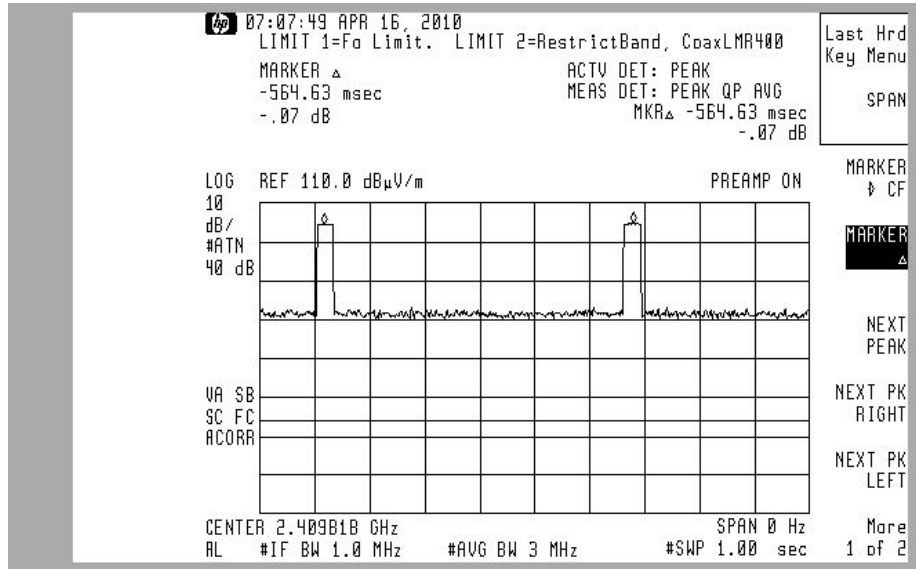

### Transmit Duty Cycle Pulse Width Plot

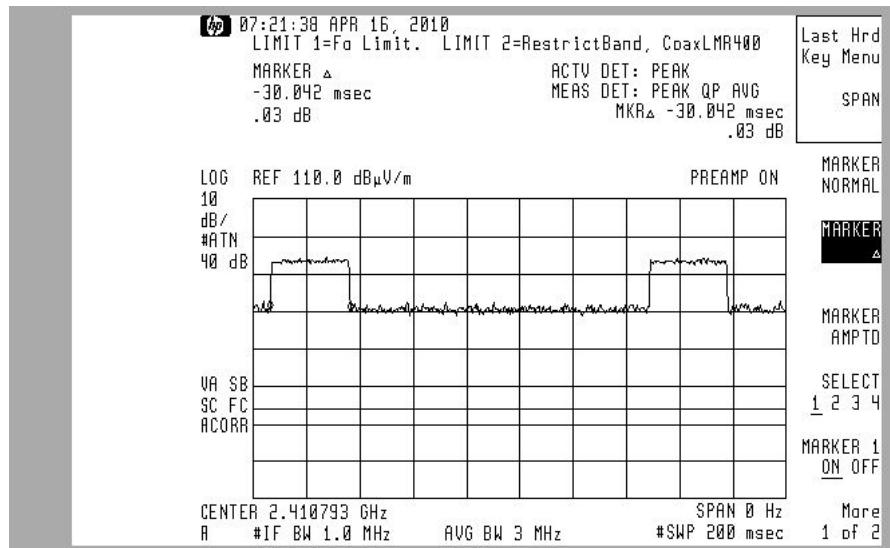

### Fundamental Worst Case Tabulated Measurements

Frequency	Corrected Peak Measurement	EUT orientation	Compensated Average Measurement	V/m	EIRP	Turntable Azimuth	Antenna Height	FCC 15.247 limit	Margin
MHz	dBuV/m		dBuV/m	V/m	mW	deg	Mtr	mW	mW
<b>2409.88</b>	<b>102.58</b>	<b>h-flat</b>	<b>92.13</b>	<b>0.04</b>	<b>0.49</b>	<b>270</b>	<b>2.0</b>	<b>125.0</b>	<b>124.5</b>
<b>2442.09</b>	<b>102.76</b>	<b>h-flat</b>	<b>92.31</b>	<b>0.04</b>	<b>0.51</b>	<b>280</b>	<b>1.9</b>	<b>125.0</b>	<b>124.5</b>
<b>2474.37</b>	<b>101.49</b>	<b>h-flat</b>	<b>91.04</b>	<b>0.04</b>	<b>0.38</b>	<b>270</b>	<b>2.1</b>	<b>125.0</b>	<b>124.6</b>

### Second Harmonic Worst Case Tabulated Measurements

Frequency	Corrected Peak Measurement	EUT orientation	Compensated Average Measurement	Turntable Azimuth	Antenna Height	Average FCC Class B limit	Margin Class B
MHz	dBuV/m		dBuV/m	deg	Mtr	dBuV/m	dBuV/m
<b>4819.75</b>	<b>60.94</b>	<b>h-flat</b>	<b>50.49</b>	<b>60</b>	<b>1.3</b>	<b>54.0</b>	<b>3.51</b>
<b>4884.19</b>	<b>57.09</b>	<b>h-flat</b>	<b>46.64</b>	<b>260</b>	<b>1.5</b>	<b>54.0</b>	<b>7.36</b>
<b>4948.79</b>	<b>59.25</b>	<b>h-flat</b>	<b>48.80</b>	<b>65</b>	<b>1.2</b>	<b>54.0</b>	<b>5.20</b>

### Maximized Upper Harmonic Tabulated Measurement

Frequency	Corrected Peak Measurement	EUT orientation	Compensated Average Measurement	Turntable Azimuth	Antenna Height	Average FCC limit	Margin Class B
MHz	dBuV/m		dBuV/m	deg	Mtr	dBuV/m	dBuV/m
<b>7230.00</b>	43.9359	na	<b>33.49</b>	-	<b>1.00</b>	<b>54.00</b>	<b>20.51</b>
<b>7327.50</b>	41.016825	na	<b>30.57</b>	-	<b>1.00</b>	<b>54.00</b>	<b>23.43</b>
<b>7420.50</b>	37.994015	na	<b>27.54</b>	-	<b>1.00</b>	<b>54.00</b>	<b>26.46</b>
<b>9640.00</b>	39.8184	na	<b>29.37</b>	-	<b>1.00</b>	<b>54.00</b>	<b>24.63</b>
<b>9770.00</b>	39.1912	na	<b>28.74</b>	-	<b>1.00</b>	<b>54.00</b>	<b>25.26</b>
<b>9894.00</b>	39.56064	na	<b>29.11</b>	-	<b>1.00</b>	<b>54.00</b>	<b>24.89</b>
<b>12050.00</b>	41.7606796	na	<b>31.31</b>	-	<b>1.00</b>	<b>54.00</b>	<b>22.69</b>
<b>12212.50</b>	40.8795564	na	<b>30.43</b>	-	<b>1.00</b>	<b>54.00</b>	<b>23.57</b>
<b>12367.50</b>	41.2285048	na	<b>30.78</b>	-	<b>1.00</b>	<b>54.00</b>	<b>23.22</b>
<b>14460.00</b>	47.8802926	na	<b>37.43</b>	-	<b>1.00</b>	<b>54.00</b>	<b>16.57</b>
<b>14655.00</b>	47.0980818	na	<b>36.65</b>	-	<b>1.00</b>	<b>54.00</b>	<b>17.35</b>
<b>14841.00</b>	47.1106844	na	<b>36.66</b>	-	<b>1.00</b>	<b>54.00</b>	<b>17.34</b>
<b>16870.00</b>	40.7548713	na	<b>30.30</b>	-	<b>1.00</b>	<b>54.00</b>	<b>23.70</b>
<b>17097.50</b>	41.2961852	na	<b>30.85</b>	-	<b>1.00</b>	<b>54.00</b>	<b>23.15</b>
<b>17314.50</b>	41.131317	na	<b>30.68</b>	-	<b>1.00</b>	<b>54.00</b>	<b>23.32</b>
<b>19280.00</b>	42.02715	na	<b>31.58</b>	-	<b>1.00</b>	<b>54.00</b>	<b>22.42</b>
<b>19540.00</b>	45.3767734	na	<b>34.93</b>	-	<b>1.00</b>	<b>54.00</b>	<b>19.07</b>
<b>19788.00</b>	44.5243315	na	<b>34.07</b>	-	<b>1.00</b>	<b>54.00</b>	<b>19.93</b>
<b>21690.00</b>	46.1963718	na	<b>35.75</b>	-	<b>1.00</b>	<b>54.00</b>	<b>18.25</b>
<b>21982.50</b>	47.6547323	na	<b>37.20</b>	-	<b>1.00</b>	<b>54.00</b>	<b>16.80</b>
<b>22261.50</b>	48.9106838	na	<b>38.46</b>	-	<b>1.00</b>	<b>54.00</b>	<b>15.54</b>
<b>24100.00</b>	48.4663332	na	<b>38.02</b>	-	<b>1.00</b>	<b>54.00</b>	<b>15.98</b>
<b>24425.00</b>	49.0539938	na	<b>38.60</b>	-	<b>1.00</b>	<b>54.00</b>	<b>15.40</b>
<b>24735.00</b>	50.7188831	na	<b>40.27</b>	-	<b>1.00</b>	<b>54.00</b>	<b>13.73</b>



**500 Kbod Band Edge  
Tabulated Measurement Digital Modulation Mode**

Frequency	Average Measurement	EUT orientation	Turntable Azimuth	Antenna Height	Average FCC Class B limit	Margin Class B
MHz	dBuV/m		deg	Mtr	dBuV/m	dBuV/m
<b>2400.01</b>	<b>30.40</b>	<b>h-flat</b>	<b>250</b>	<b>2.5</b>	<b>54.0</b>	<b>23.60</b>
<b>2482.80</b>	<b>31.50</b>	<b>h-flat</b>	<b>270</b>	<b>2.6</b>	<b>54.0</b>	<b>22.50</b>

**250 Kbod Band Edge  
Tabulated Measurement Digital Modulation Mode**

Frequency	Average Measurement	EUT orientation	Turntable Azimuth	Antenna Height	Average FCC Class B limit	Margin Class B
MHz	dBuV/m		deg	Mtr	dBuV/m	dBuV/m
<b>2400.01</b>	<b>29.52</b>	<b>h-flat</b>	<b>250</b>	<b>2.5</b>	<b>54.0</b>	<b>24.48</b>
<b>2482.80</b>	<b>31.39</b>	<b>h-flat</b>	<b>270</b>	<b>2.6</b>	<b>54.0</b>	<b>22.61</b>

**Band Edge  
Tabulated Measurement Hopping Frequency Mode**

Frequency	Average Measurement	EUT orientation	Turntable Azimuth	Antenna Height	Average FCC Class B limit	Margin Class B
MHz	dBuV/m		deg	Mtr	dBuV/m	dBuV/m
<b>2400.01</b>	<b>29.48</b>	<b>h-flat</b>	<b>250</b>	<b>2.5</b>	<b>54.0</b>	<b>24.52</b>
<b>2483.51</b>	<b>31.26</b>	<b>h-flat</b>	<b>270</b>	<b>2.6</b>	<b>54.0</b>	<b>22.74</b>

### 15.247 Specific Transmit Emissions, Hopping Frequency Mode

#### 25 Channel Plot

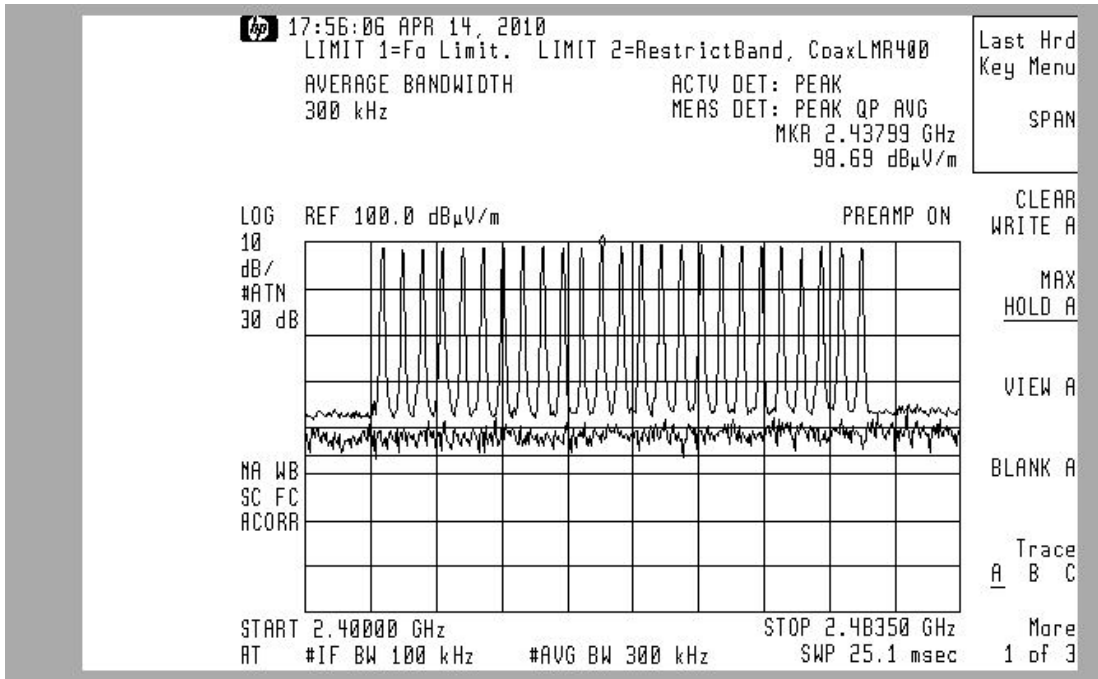

#### 20 dB Bandwidth Plot

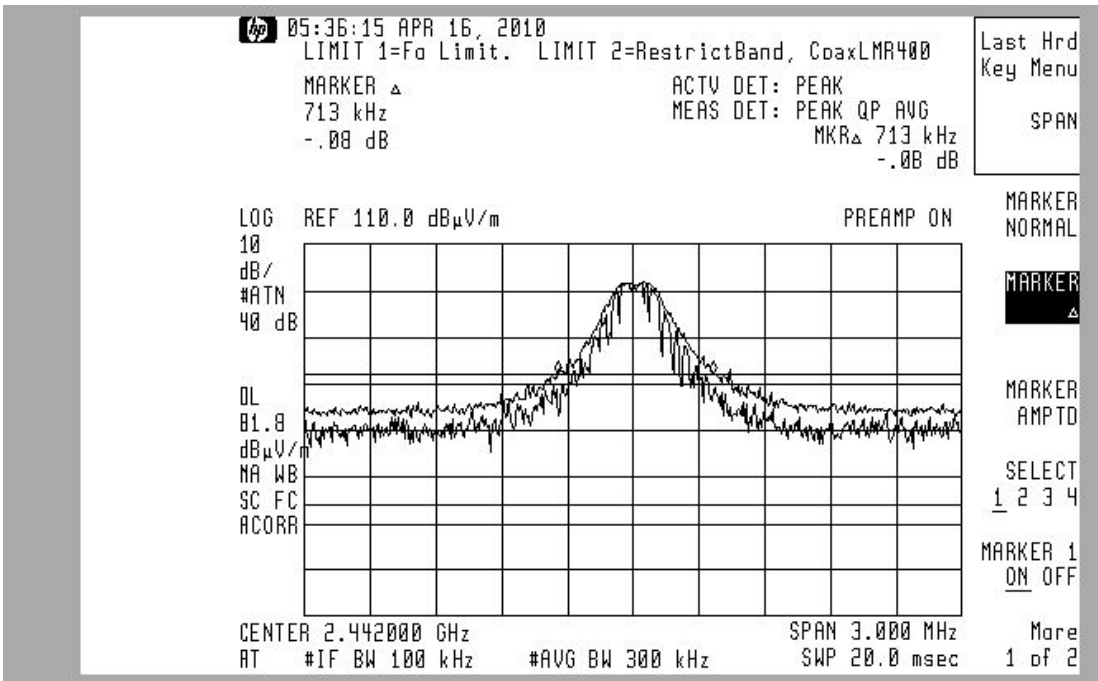

### Carrier Separation

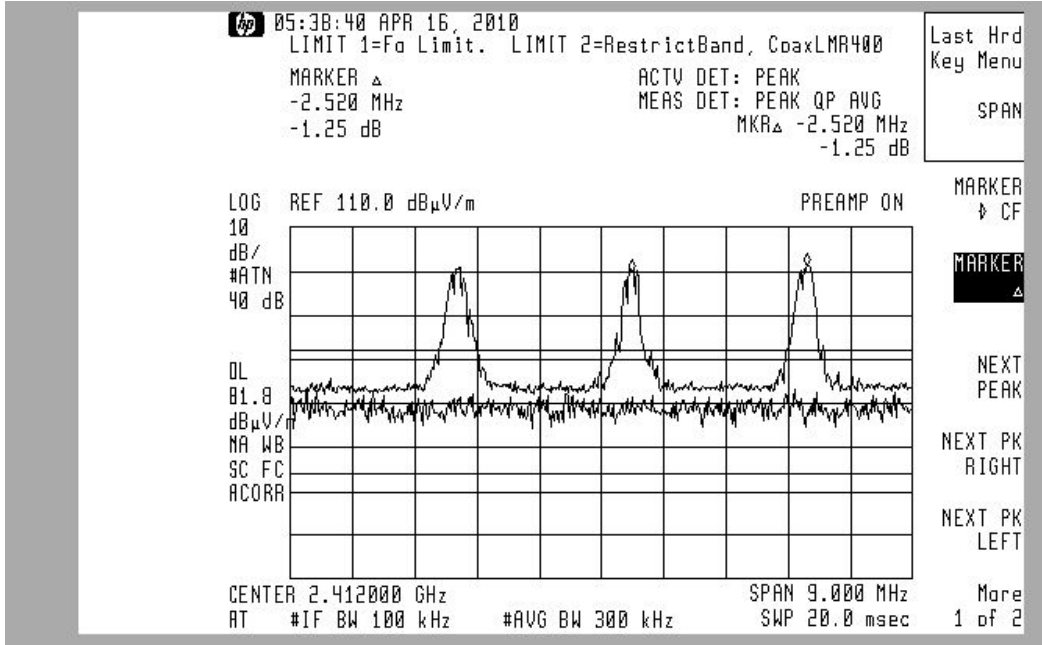

### 100KHz BW In Band Low End Max

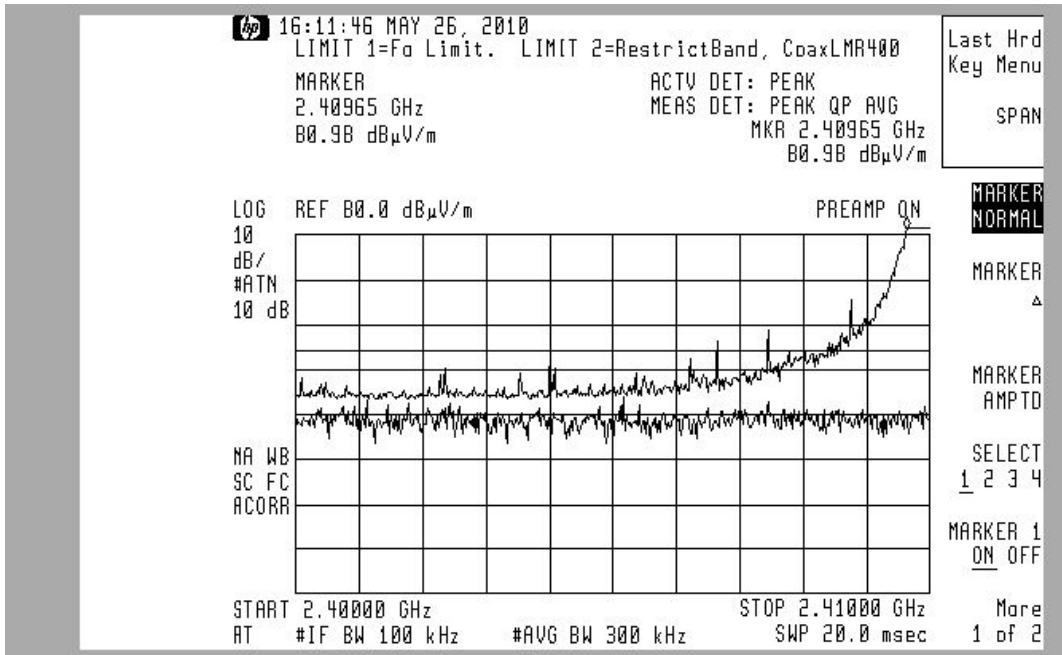

### 100KHz BW In Band High End Max

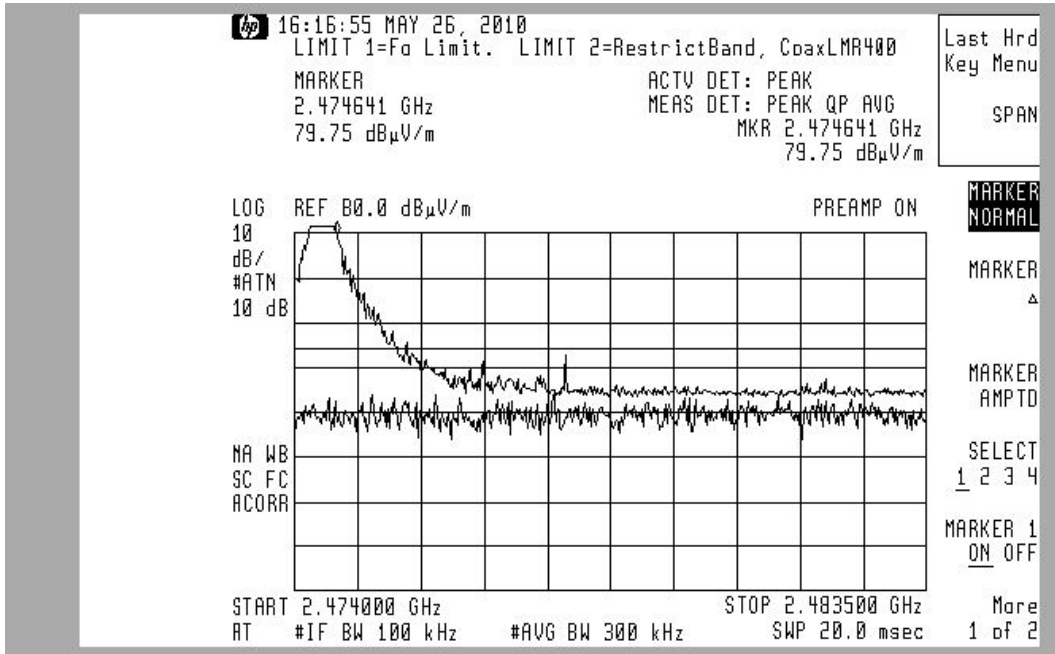

**Tabulated 15.247 Frequency Hopping Data**

15.247 Reference	Spec Data	Units	Spec	Data	Margin
	Operating Mode		Frequency Hopper / Digital Modulation	Frequency Hopper	NA
a.1	Min # of channels		15	25	10
a.1	Channel Carrier Frequencies		2400-2483	2410-2475	NA
a.1	channel 20 dB BW	MHz	None	0.713	NA
a.1	Min Carrier separation	MHz	0.713	2.52	1.81
a.1	hopping algorithm		Pseudo Random, equal distribution		
a.1.iii	max time occupied per channel	msec	400	374.16	25.84
b.1	max power (eirp)	mw	125	0.51	124.49
b.4	max antenna gain		6	2.15	3.85
d	measured in band 100 KHz BW signal	dBuV	None	98.69	NA
d	measured out of band 100KHz BW signal	dBuV	No signals outside operating band > 20dB below 100KHz BW signal	Compliant	NA

### 15.247 Specific Transmit Emissions, Digital Modulation Mode

#### 250 Kbod 10 Channel Plot

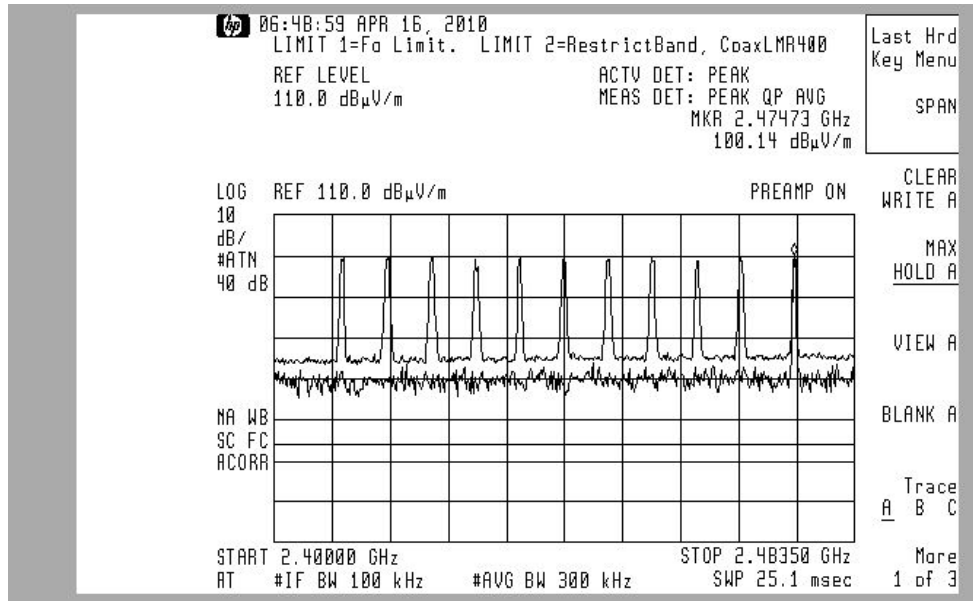

\* Note: Regarding 10 Channel Plot: 11 channels are displayed because the highest channel 255 is not used in slave mode.

#### 500 Kbod 25 Channel Plot

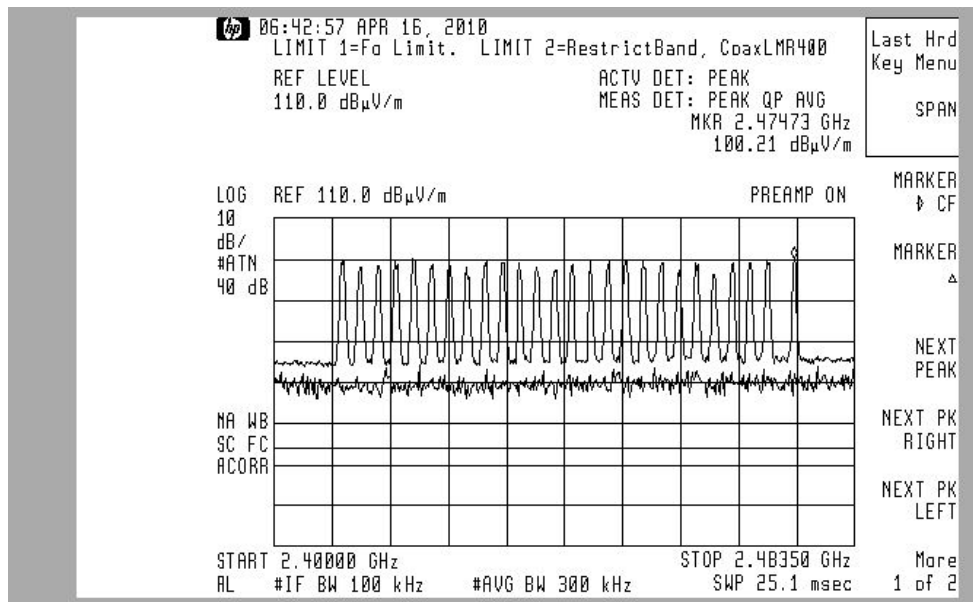

### 250 Kbd Digital Channel 6dB BW Plot

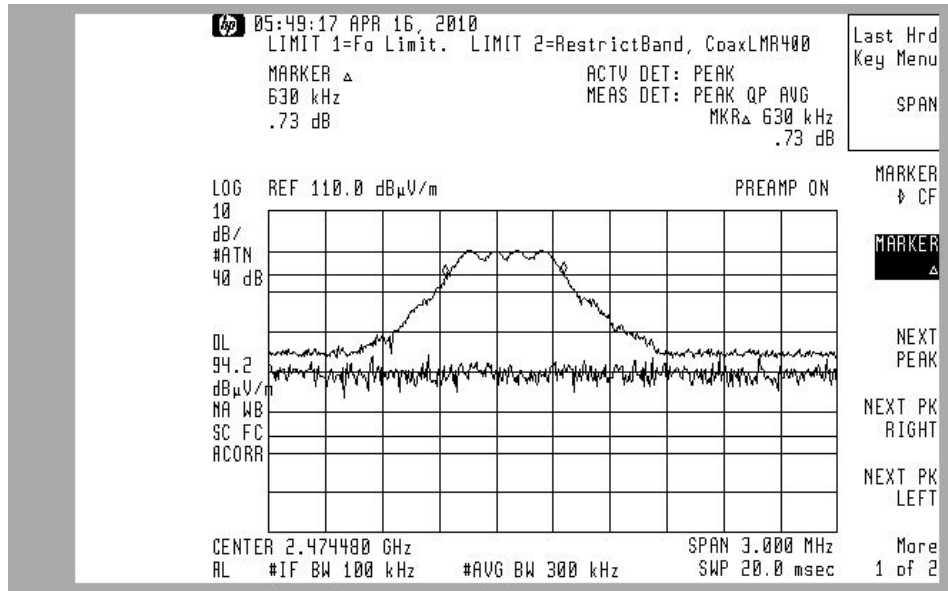

### 500 Kbd Digital Channel 6dB BW Plot

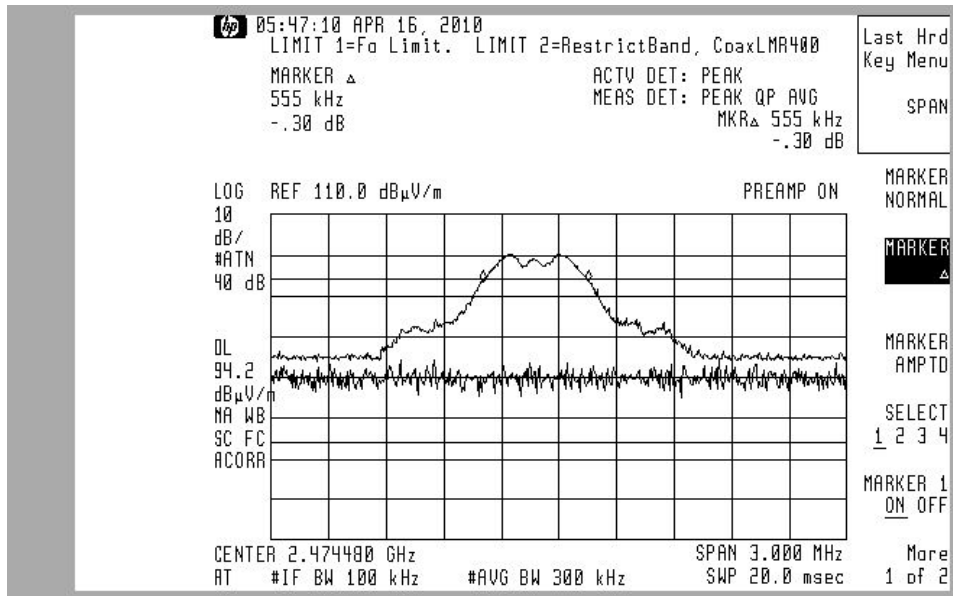

### 250 Kbd Digital Channel 3 KHz Power Density Plot

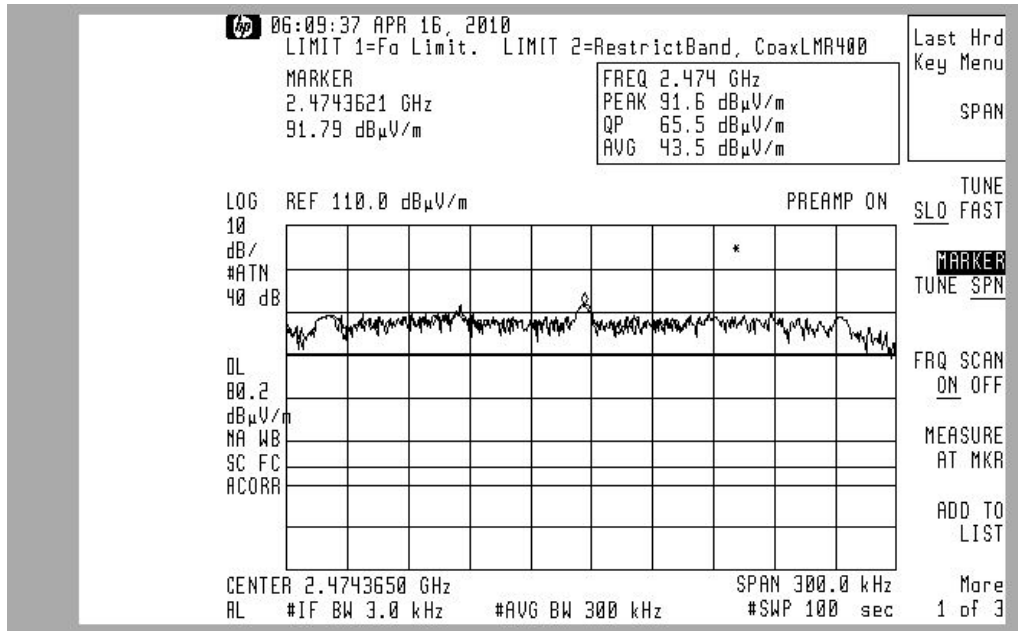

### 500 Kbd Digital Channel 3 KHz Power Density Plot

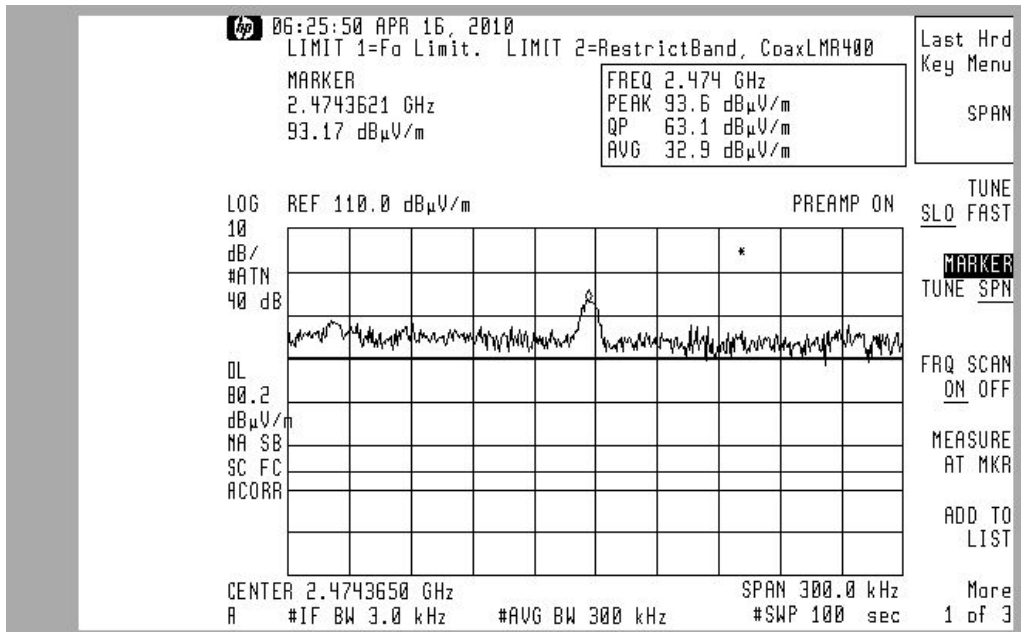



**Tabulated 15.247 250 Kbod Digital Modulation Data**

15.247 Reference	Spec Data	Units	Spec	Measurement	Margin
	Operating Mode		Frequency Hopper / Digital Modulation	Digital Modulation	NA
a.1	# of channels	12	NA		
a.1	Channel Carrier Frequencies	2410-2474	2400-2483		
a.2	min channel 6 dB BW	MHz	0.5	0.63	0.13
a.1	max Carrier separation	MHz	0.63	6.3	5.67
b.3	max power (eirp)		1000	0.51	999.49
e	Measured 3 KHz Field Density	dBuV	103.23	91.6	11.63
e	Max 3 KHz Power Density	dBm	8	-3.63	11.63

**Tabulated 15.247 500 Kbod Digital Modulation Data**

15.247 Reference	Spec Data	Units	Spec	Measurement	Margin
	Operating Mode		Frequency Hopper / Digital Modulation	Digital Modulation	NA
a.1	# of channels	12	NA		
a.1	Channel Carrier Frequencies	2410-2474	2400-2483		
a.2	min channel 6 dB BW	MHz	0.5	0.55	0.05
a.1	max Carrier separation	MHz	0.55	2.31	1.76
b.3	max power (eirp)		1000	0.51	999.49
e	Measured 3 KHz Field Density	dBuV	103.23	93.6	9.63
e	Max 3 KHz Power Density	dBm	8	-1.63	9.63

**RF Exposure Calculation:**

**Tabulated RF Exposure Calculations**

FCC Spec Reference	Spec Data	Units	Spec	Data	Margin
KDB 447948 D01	min SAR Evaluation Limit = 60/2.45GHz	mW	24.490	0.510	23.980
15.203	Fixed Antenna	NA	Antenna unchangeable by end user	Integrated PCB Antenna	
1.1310	Max Occupational Exposure (assuming distance of 2.5cm) using formula $EIRP/(4*(\pi)*(d^2))$	mW/cm <sup>2</sup>	5.000	0.006	4.994
1.1310	General Population Exposure (assuming distance of 2.5cm) using formula $EIRP/(4*(\pi)*(d^2))$	mW/cm <sup>2</sup>	1.000	0.006	0.994

## Measurement Facilities & Equipment

### Test Site

The AHD test facility is centered on 9 acres of rural property near Sister Lakes, Michigan. The mailing address is 92723 Michigan Hwy152, Sister Lakes, 49047. This test facility is NVLAP accredited (LabCode 200129-0). It has been fully described in a report filed with the FCC (No.90413) and Industry Canada (file:IC3161).

### Measurement Equipment Used

Equipment	Model	S/N	Last Cal Date	Calibration Interval
HP EMI Receiver system	HP 8546A			
RF Filter Section	HP-85460A	3448A00283	25 July-09	12 months
RF Receiver Section	HP-85462A	3625A00342	25 July-09	12 months
EMCO BiconiLog Antenna	3142	1069	27-July-09	12 months
Solar LISN	8012-50-R-24-BNC	962137	3-Aug-09	12 months
Solar LISN	8012-50-R-24-BNC	962138	23-July-09	12 months
(LCI) Double shielded 50ohm Coax	RG58/U	920809	10-Mar-10	12 months
(3-m) LMR-400 Ultra Flex	LMR400	C090804	18-May-10	6 months
(3-m) CS-3227 RG8	CS-3227	C060914	18-May-10	6 months
(10-m) Amelco 50ohm Coax	RG213U	9903-10ab	18-May-10	6 months
Double Ridged Horn	ONO91202-2	A00329	27-July-09	12 months
Schaffner ESD	NSG432	01027	04-Feb-10	12 months

### Test Site 2

The University of Michigan test facility is located at 8501 Beck Road, Belleville, Michigan 48111. This test facility has been fully described and accepted by the FCC and Industry Canada. This facility was utilized to measure emissions occurring at frequencies greater than 6GHz.

### Measurement Equipment Used

Equipment	Model	S/N	Last Cal Date	Calibration Interval
C-Band Std. Gain Horn	UM NRL design		calibration by design & physical inspection.	
XN-Band Std. Gain Horn	UM NRL design		calibration by design & physical inspection.	
X-Band Std. Gain Horn	SA 12-8.2	730	calibration by design & physical inspection.	
Avantek RF amplifier	AFT-12665		28-July-09	12 months
3ft Low Loss coax	RG142	-	with Avantek amp	
Spectrum Analyzer	HP 8593E	3412A01131	2-June-09	12 months

## **Environment**

The test was performed with the equipment under test, and measurement equipment inside the all-weather enclosure. Ambient temperature was 76 deg F, the relative humidity 33 %.

**APPENDIX A****Measurement Procedures****Line Conducted**

The system was placed upon a 1 x 1.5 meter non-metallic table 80cm from the ground floor and 40cm from the vertical conducting plane in the prescribed setup per ANSI C63.4. This table is housed in a shielded enclosure to prevent the detection of unwanted ambients.

The EUT, or host unit if applicable, was connected to the LISN being monitored by the EMI Receiver. The remaining support devices requiring mains power were connected to a second LISN.

The EUT was continuously exercised by methods supplied by the manufacturer.

While monitoring the display of the EMI Receiver, via remote video monitor, the cables were manipulated to determine a position that maximized the emissions being observed. Once the highest amplitude relative to the limit was determined for the Phase current carrying line the procedure was repeated for the Neutral current carrying line.

The configuration that created an emission closest to the limit was used during the course of taking final measurements. Pictures of this final configuration are recorded in this report.

The principal settings of the EMI Receiver for line conducted testing include:

Bandwidth = 9 kHz

Detector Function: scanning and signal search = Peak Detection Mode  
measurements = Quasi Peak Detection and Average Detection

The cable losses of the coax used in line conducted testing are charted in this appendix.

## Radiated

The system was placed upon a 1 x 1.5 meter non-metallic table 80cm from the open field site ground plane in the prescribed setup per ANSI C63.4, Figure 9(c).

The table sits upon a remote controlled turntable. The receiving antenna, located at the appropriate standards distance of 3 or 10 meters from the table center, is also remote controlled.

The EUT was continuously exercised by software supplied by the manufacturer.

Preliminary tests were done at the 3 meter open field test site. The final tests are done at the appropriate standards distance of 3 or 10 meters. The "Biconical/Log Periodic" broadband antenna connected to an EMI Receiver, meeting CISPR 16, is used throughout the testing.

During the preliminary scans and while monitoring the display of the EMI Receiver, the turntable was rotated 360 degrees and the receiving antenna height varied from 1 to 4 meters to search out the highest emissions. At the significant emissions, the cables were manipulated to determine a position that maximized the emissions being observed. Once the cable position was determined that presented the highest amplitude relative to the limit for Vertical polarized emissions the procedure was repeated for the Horizontal polarization.

The configuration that created an emission closest to the limit was used during the course of taking final measurements. Pictures of this final configuration are recorded in this report.

The principal settings of the EMI Receiver for radiated testing include:

Bandwidth: 120kHz  
Detector Function: scanning and signal search = Peak Mode  
measurements = Quasi Peak Mode.  
Search Range: 30MHz to 1000MHz or to 2GHz as appropriate

The cable loss of the coax used in radiated scanning is charted in this appendix.

The antenna factors, for the test distance used, are charted in this appendix.

The resultant Field Strength (FS) is a summation in decibels (dB) of the Indicated Receiver Level (RF), the Antenna Correction Factor (AF), and the Cable Loss Factor (CF). If a PreAmplifier (PA) is used, its gain (dB) is subtracted from the above sum.

Formula 1:  $FS(\text{dBuV/m}) = RF(\text{dBuV}) + AF(\text{dB/m}) + CF(\text{dB}) - PA(\text{dB})$

To convert the Field Strength dBuV/m term to uV/m, the dBuV/m is first divided by 20. The Base 10 AntiLog is taken of this quotient. The result is the Field Strength value in uV/m terms.

Formula 2:  $FS(\text{uV/m}) = \text{AntiLog}[(FS(\text{dBuV/m}))/20]$

# Cable Loss

Line Conducted 150KHz through 30MHz, Coax #920809

Last Calibration date: Mar 10, 2010

TEST DATE: ----- COAX # 9208091 Tester: -----

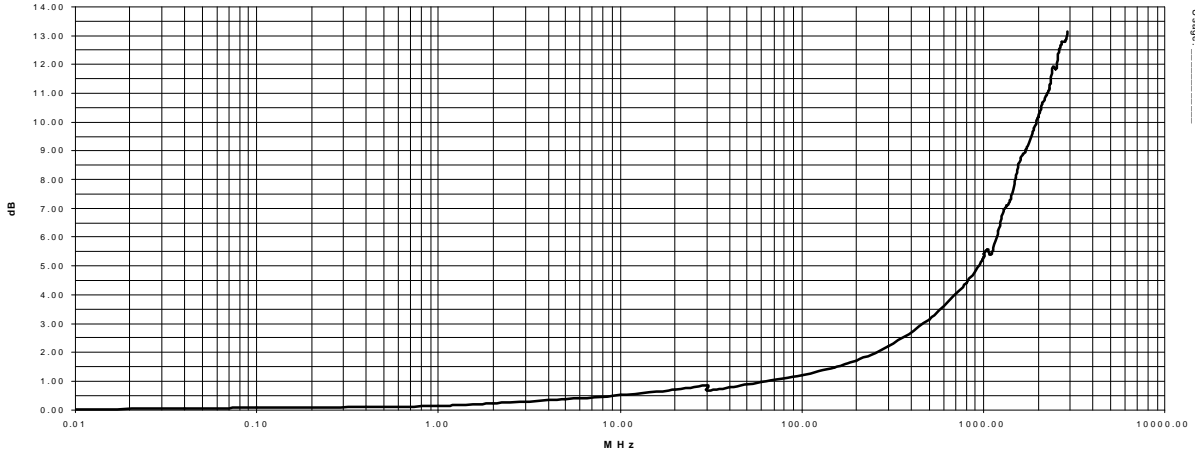

Radiated at 3 meters; 30MHz through 3000MHz, Coax #C090804

Last Calibration date: May 18, 2010

TEST DATE: ----- COAX # 9812\_11 Tester: -----

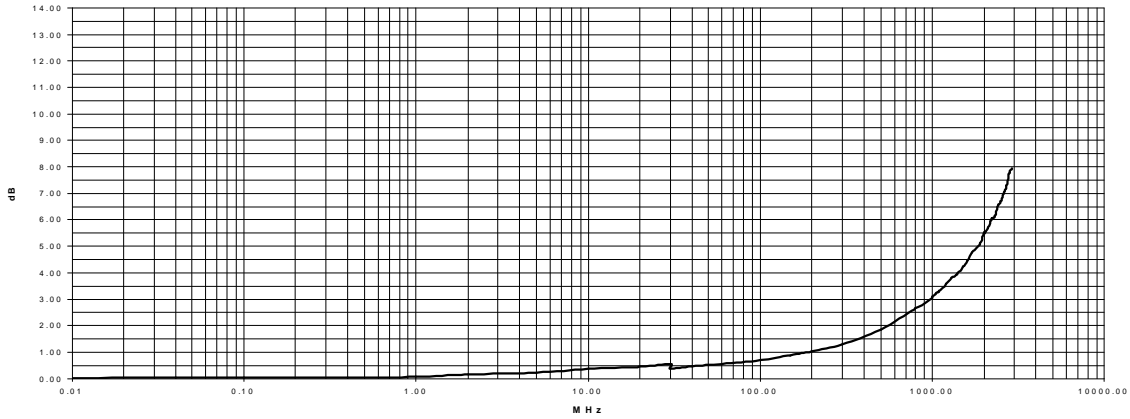

## Antenna Factors

EMCO Model 3142 Antenna #1069

Last Calibration Date; 27-July-09

3 Meter Distance Factors

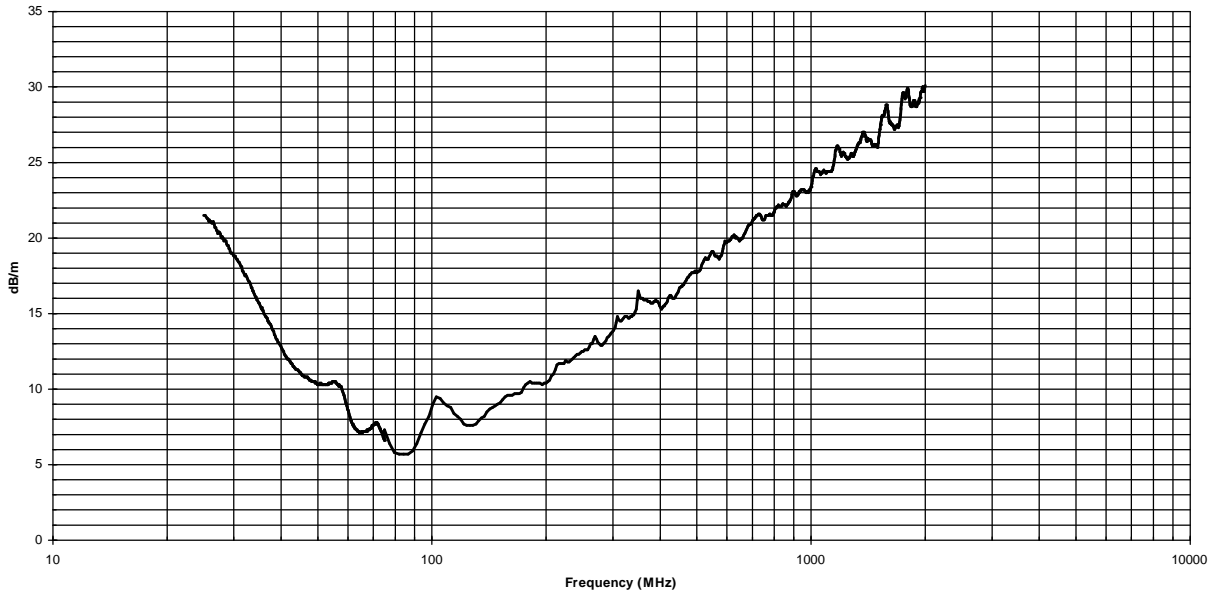

10 Meter Distance Factors

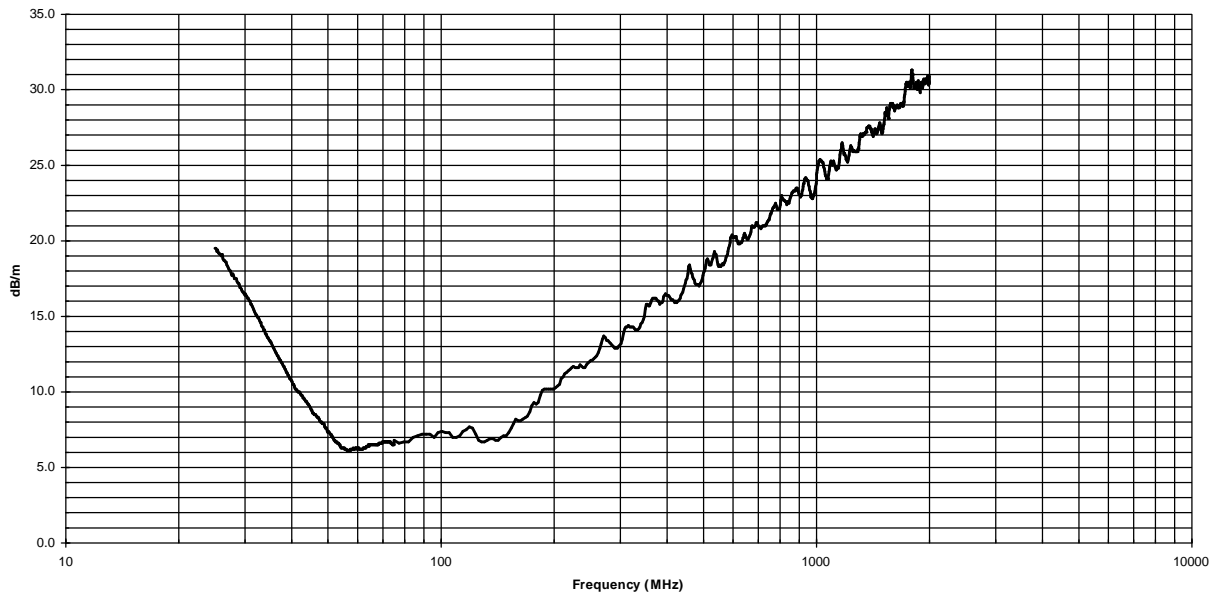



# AHD Accreditation

United States Department of Commerce  
National Institute of Standards and Technology

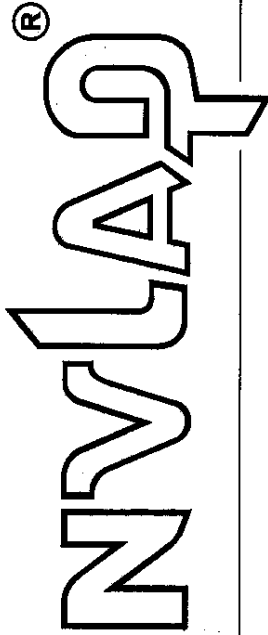

## Certificate of Accreditation to ISO/IEC 17025:2005

NVLAP LAB CODE: 200129-0

**AHD (Amber Helm Development, L.C.)**  
Dowagiac, MI

is accredited by the National Voluntary Laboratory Accreditation Program for specific services,  
listed on the Scope of Accreditation, for:

### ELECTROMAGNETIC COMPATIBILITY AND TELECOMMUNICATIONS

This laboratory is accredited in accordance with the recognized International Standard ISO/IEC 17025:2005.  
This accreditation demonstrates technical competence for a defined scope and the operation of a laboratory quality management system (refer to joint ISO-LAC-IAF Communiqué dated January 2009).



2010-07-01 through 2011-06-30  
Effective dates

*Jolly S. Bruce*  
For the National Institute of Standards and Technology

NVLAP-01C (REV. 2009-01-28)

**FEDERAL COMMUNICATIONS COMMISSION**

Laboratory Division  
7435 Oakland Mills Road  
Columbia, MD 21046

April 16, 2008

Registration Number: 90413

AHD EMC Laboratory  
92723 M-152,  
Dowagiac, MI 49047

Attention: Gordon Helm

Re: Measurement facility located at Sister Lakes  
3 & 10 meter site  
Date of Renewal: April 16, 2008

Dear Sir or Madam:

Your request for renewal of the registration of the subject measurement facility has been received. The information submitted has been placed in your file and the registration has been renewed. The name of your organization will remain on the list of facilities whose measurement data will be accepted in conjunction with applications for Certification under Parts 15 or 18 of the Commission's Rules. Please note that the file must be updated for any changes made to the facility and the registration must be renewed at least every three years.

Measurement facilities that have indicated that they are available to the public to perform measurement services on a fee basis may be found on the FCC website [www.fcc.gov](http://www.fcc.gov) under E-Filing OET Equipment Authorization Electronic Filing, Test Firms.

Sincerely,



Phyllis Parrish  
Industry Analyst

**NARTE Seal**

