

Shanghai Smarfid Security Equipment Co.,Ltd

Card Reader

Model: MW4621

22 July, 2011
Report No.: 11020588-FCC
(This report supersedes NONE)



Modifications made to the product : None

This Test Report is Issued Under the Authority of:

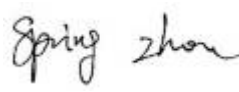
	
Peter Cai Test Engineer	Spring Zhou Technical Manager

This test report may be reproduced in full only.
Test result presented in this test report is applicable to the representative sample only.

RF Test Report

T0: FCC Part 15.225: 2010

SIEMIC, INC.
Accessing global markets

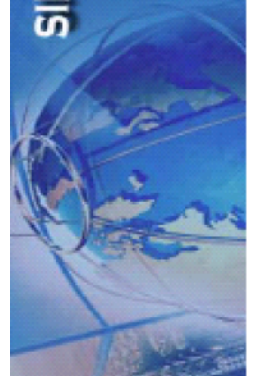

Laboratory Introduction

SIEMIC, headquartered in the heart of Silicon Valley, with superior facilities in US and Asia, is one of the leading independent testing and certification facilities providing customers with one-stop shop services for Compliance Testing and Global Certifications.



In addition to [testing](#) and [certification](#), SIEMIC provides initial design reviews and [compliance management](#) through out a project. Our extensive experience with [China](#), [Asia Pacific](#), [North America](#), [European](#), and [international](#) compliance requirements, assures the fastest, most cost effective way to attain regulatory compliance for the [global markets](#).

Accreditations for Conformity Assessment

Country/Region	Accreditation Body	Scope
USA	FCC, A2LA	EMC , RF/Wireless , Telecom
Canada	IC, A2LA, NIST	EMC, RF/Wireless , Telecom
Taiwan	BSMI , NCC , NIST	EMC, RF, Telecom , Safety
Hong Kong	OFTA , NIST	RF/Wireless ,Telecom
Australia	NATA, NIST	EMC, RF, Telecom , Safety
Korea	KCC/RRA, NIST	EMI, EMS, RF , Telecom, Safety
Japan	VCCI, JATE, TELEC, RFT	EMI, RF/Wireless, Telecom
Mexico	NOM, COFETEL, Caniety	Safety, EMC , RF/Wireless, Telecom
Europe	A2LA, NIST	EMC, RF, Telecom , Safety

Accreditations for Product Certifications

Country	Accreditation Body	Scope
USA	FCC TCB, NIST	EMC , RF , Telecom
Canada	IC FCB , NIST	EMC , RF , Telecom
Singapore	iDA, NIST	EMC , RF , Telecom
EU	NB	EMC & R&TTE Directive



SIEMIC, INC.

Accessing global markets

Title: RF Test Report for Card Reader
Model: MW4621
To: FCC Part 15.225: 2010

Serial#: 11020588-FCC
Issue Date: 22 July, 2011
Page: 3 of 37
www.siemac.com.cn

This page has been left blank intentionally.



CONTENTS

1	EXECUTIVE SUMMARY & EUT INFORMATION	5
2	TECHNICAL DETAILS	6
3	MODIFICATION	7
4	TEST SUMMARY	8
5	MEASUREMENTS, EXAMINATION AND DERIVED RESULTS	9
	ANNEX A. TEST INSTRUMENT & METHOD.....	21
	ANNEX B. EUT AND TEST SETUP PHOTOGRAPHS	25
	ANNEX C. TEST SETUP AND SUPPORTING EQUIPMENT.....	30
	ANNEX D. USER MANUAL / BLOCK DIAGRAM / SCHEMATICS / PART LIST	34
	ANNEX E. SIEMIC ACCREDITATION CERTIFICATES.....	35



SIEMIC, INC.

Accessing global markets

Title: RF Test Report for Card Reader
Model: MW4621
To: FCC Part 15.225: 2010

Serial#: 11020588-FCC
Issue Date: 22 July, 2011
Page: 5 of 37
www.siemac.com.cn

1 Executive Summary & EUT information

The purpose of this test programme was to demonstrate compliance of the Shanghai Smarfid Security Equipment Co.,Ltd, Card Reader, and model: MW4621 against the current Stipulated Standards. The Card Reader has demonstrated compliance with the FCC Part 15.225: 2010.

EUT Information

EUT : Card Reader
Description
Model No : MW4621 (Note)
Serial No : N/A
Input Power : Voltage:5V, Current:70mA
Classification
Per Stipulated : Class B Emission Product
Test Standard

Note: Other model MW4631, LE4621 and LE4631, only look different other identical.

2 TECHNICAL DETAILS

Purpose	Compliance testing of Card Reader with stipulated standard
Applicant / Client	Shanghai Smarfid Security Equipment Co.,Ltd Rm.206,4th Bldg,No.471 Guiping Road,Shanghai
Manufacturer	Shanghai Smarfid Security Equipment Co.,Ltd Rm.206,4th Bldg,No.471 Guiping Road,Shanghai
Laboratory performing the tests	SIEMIC Nanjing (China) Laboratories NO.2-1,Longcang Dadao, Yuhua Economic Development Zone, Nanjing, China Tel:+86(25)86730128/86730129 Fax:+86(25)86730127 Email:info@siemic.com
Test report reference number	11020588-FCC
Date EUT received	28 March, 2011
Standard applied	FCC Part 15.225: 2010
Dates of test (from – to)	11 July to 21 July, 2011
No of Units :	#1
Equipment Category :	DXX
Trade Name :	Vitto
Model :	MW4621
RF Operating Frequency (ies) :	13.56MHz
Number of Channels :	1
Modulation :	ASK
FCC ID :	X3A-USB
IC ID :	N/A

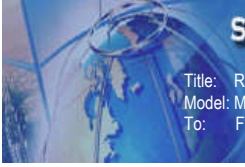

SIEMIC, INC.

Accessing global markets

Title: RF Test Report for Card Reader
Model: MW4621
To: FCC Part 15.225: 2010

Serial#: 11020588-FCC
Issue Date: 22 July, 2011
Page: 7 of 37
www.siemic.com.cn

3 MODIFICATION

NONE

4 TEST SUMMARY

The product was tested in accordance with the following specifications.
All testing has been performed according to below product classification:

Class B Emission Product
Test Results Summary

Test Standard	Description	Pass/Fail
FCC Part 15.225:2010		
15.203	Antenna Requirement	Pass
15.207(a)	Conducted Emissions Voltage	Pass
15.225(a)	Limit in the band of 13.553-13.567MHz	Pass
15.225(b)	Limit in the band of 13.410-13.553MHz and 13.567-13.710MHz	Pass
15.225(c)	Limit in the band of 13.110-13.410MHz	Pass
15.225(d),15.209	Limit outside the band of 13.110-14.010MHz	Pass
15.225(e)	Frequency Stability	Pass

ANSI C63.4: 2009

PS: All measurement uncertainties are not taken into consideration for all presented test result.

5 MEASUREMENTS, EXAMINATION AND DERIVED RESULTS

5.1 Antenna Requirement

Requirement(s): 47 CFR §15.203

An intentional radiator shall be designed to ensure that no antenna other than that furnished by the responsible party shall be used with the device.

Antenna requirement must meet at least one of the following:

- a) Antenna must be permanently attached to the device.
- b) Antenna must use a unique type of connector to attach to the device.
- c) Device must be professionally installed. Installer shall be responsible for ensuring that the correct antenna is employed with the device.

The antenna is permanently attached to the device.

5.2 Conducted Emissions Voltage

Requirement:

Frequency of emission (MHz)	Conducted limit (dB μ V)	
	Quasi-peak	Average
0.15–0.5	66 to 56*	56 to 46*
0.5–5	56	46
5–30	60	50

*Decreases with the logarithm of the frequency.

Procedures:

- All possible modes of operation were investigated. Only the 6 worst case emissions measured, using the correct CISPR and Average detectors, are reported. All other emissions were relatively insignificant.
- A "-ve" margin indicates a PASS as it refers to the margin present below the limit line at the particular frequency.
- Conducted Emissions Measurement Uncertainty
All test measurements carried out are traceable to national standards. The uncertainty of the measurement at a confidence level of approximately 95% (in the case where distributions are normal), with a coverage factor of 2, in the range 9kHz – 30MHz (Average & Quasi-peak) is ± 3.5 dB.
- Environmental Conditions

Temperature	15°C
Relative Humidity	50%
Atmospheric Pressure	1019mbar
- Test date : 21 July, 2011
Tested By : Peter Cai

Peak Detector  **Quasi Peak Limit** 
Average Detector  **Average Limit** 

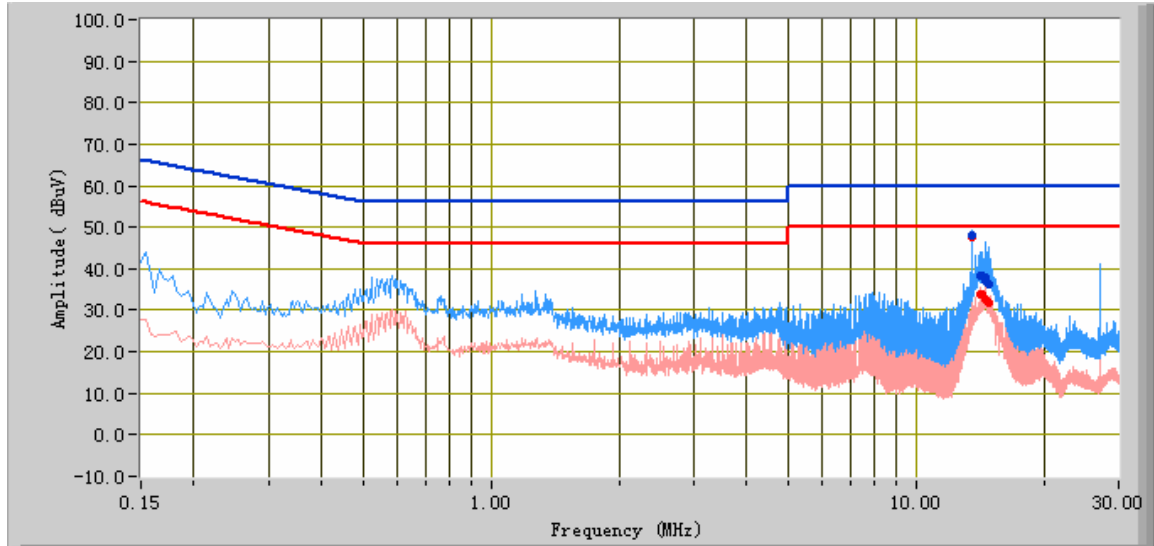

Test Data

Frequency (MHz)	Quasi Peak (dBuV)	Limit (dBuV)	Margin (dB)	Average (dBuV)	Limit (dBuV)	Margin (dB)	Factors (dB)
13.57	48.10	60.00	-11.90	47.64	50.00	-2.36	10.44
14.56	37.70	60.00	-22.30	32.82	50.00	-17.18	10.46
14.78	36.37	60.00	-23.63	31.61	50.00	-18.39	10.46
14.54	37.28	60.00	-22.72	32.59	50.00	-17.41	10.46
14.18	38.40	60.00	-21.60	33.78	50.00	-16.22	10.45
14.37	38.41	60.00	-21.59	33.96	50.00	-16.04	10.46

Peak Detector  **Quasi Peak Limit** 
Average Detector  **Average Limit** 

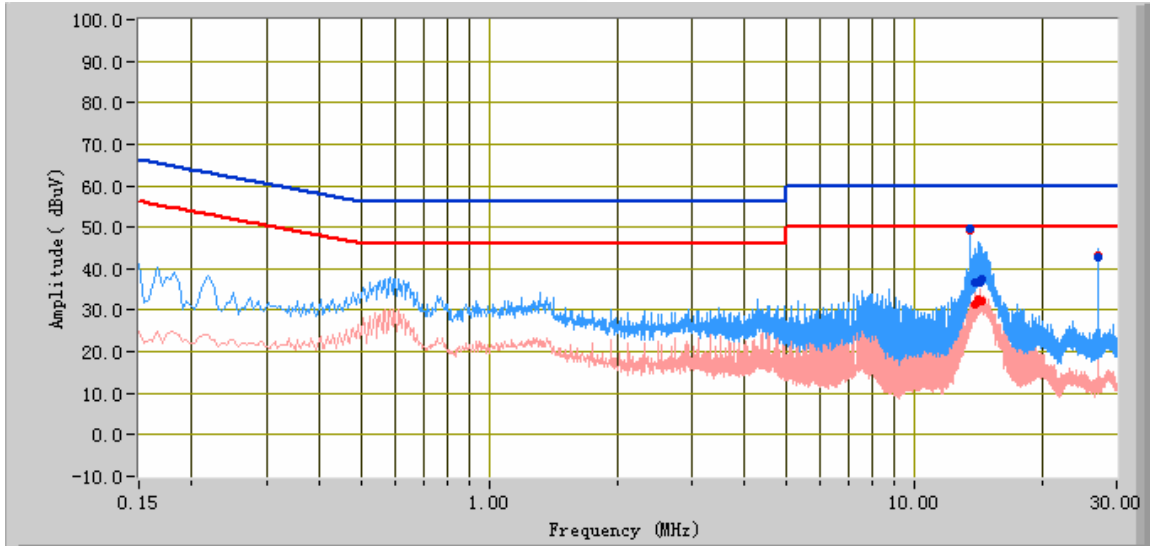

Test Data

Frequency (MHz)	Quasi Peak (dBuV)	Limit (dBuV)	Margin (dB)	Average (dBuV)	Limit (dBuV)	Margin (dB)	Factors (dB)
13.57	49.59	60.00	-10.41	49.29	50.00	-0.71	10.44
14.18	36.53	60.00	-23.47	32.63	50.00	-17.37	10.45
14.33	36.78	60.00	-23.22	32.25	50.00	-17.75	10.46
14.43	37.58	60.00	-22.42	32.05	50.00	-17.95	10.46
13.95	36.63	60.00	-23.37	31.41	50.00	-18.59	10.45
27.14	42.95	60.00	-17.05	43.15	50.00	-6.85	11.07

5.3 Radiated Emission <30MHz(9KHz – 30MHz,H-Field)

Requirement(s): 47 CFR § 15.225 & RSS-210(A2.6)

Procedures: For <30MHz, Radiated emissions were measured according to ANSIC63.4. The EUT was set to transmit at the highest output power. The EUT was set 10 meter away from the measuring antenna. The loop antenna was positioned 1 meter above the ground from the centre of the loop. The measuring bandwidth was set to 10KHz. (Note: During testing the receive antenna was rotated about its axis to maximize the emission from the EUT.)

The limit is converted from microvolt/meter to decibel microvolt/meter.

Sample Calculation: Corrected Amplitude=Raw Amplitude(dBuV/m)+ACF(dB)+Cable Loss(dB)-Distance Correction Factor

1. All possible modes of operation were investigated. Only the 6 worst case emissions measured, using the correct CISPR detectors are reported. All other emissions were relatively insignificant.
2. A “-ve” margin indicates a PASS as it refers to the margin present below the limit line at the particular frequency.
3. Radiated Emissions Measurement Uncertainty
All test measurements carried out are traceable to national standards. The uncertainty of the measurement at a confidence level of approximately 95% (in the case where distributions are normal), with a coverage factor of 2, is +/-6dB.
4. Environmental Conditions

Temperature	15°C
Relative Humidity	50%
Atmospheric Pressure	1019mbar
5. Test date : 21 July, 2011
Tested By : Peter Cai

The result: Pass

Loop Antenna Positioned at 0 degree

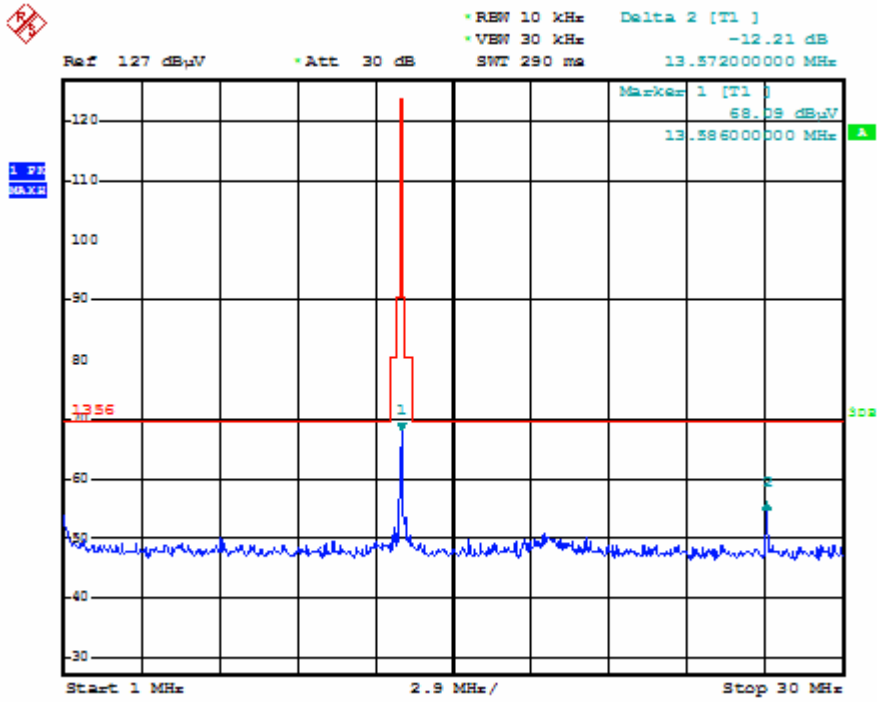

Loop Antenna Positioned at 90 degree

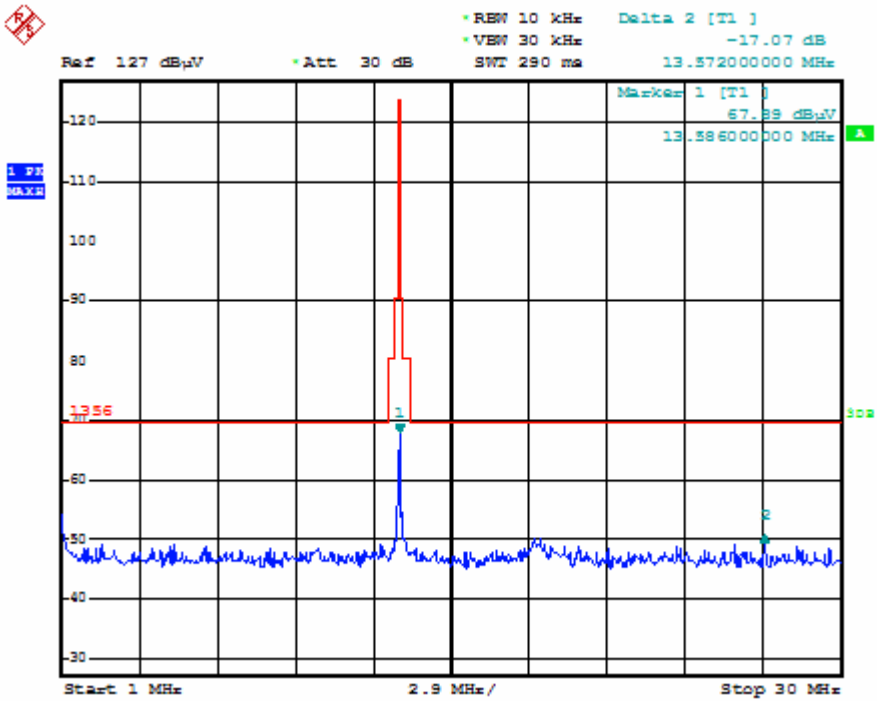

Note:

- (1) Emissions from 9KHz to 1MHz is very low under transmit mode so test data is not presented in this report.
- (2) Emissions from 9KHz to 30MHz is very low under receiver mode so test data is not presented in this report.

5.4 Radiated Emissions > 30MHz(30MHz-1GHz,E-Field)

Requirement(s): 47 CFR § 15.209; 47 CFR § 15.225(d)

Procedures: For >30MHz, Radiated emissions were measured according to ANSIC63.4. The EUT was set to transmit at the highest output power. The EUT was set 10 meter away from the measuring antenna. The Log periodic antenna was positioned 1 meter above the ground from the centre of the antenna. The measuring bandwidth was set to 120KHz. (Note: During testing the receive antenna was raise from 1-4meters to maximize the emission from the EUT.)

The limit is converted from microvolt/meter to decibel microvolt/meter.



Sample Calculation: Corrected Amplitude=Raw Amplitude(dBuV/m)+ACF(dB)+Cable Loss(dB)-Distance Correction Factor

1. All possible modes of operation were investigated. Only the 6 worst case emissions measured, using the correct CISPR detectors are reported. All other emissions were relatively insignificant.
2. A “-ve” margin indicates a PASS as it refers to the margin present below the limit line at the particular frequency.
3. Radiated Emissions Measurement Uncertainty
All test measurements carried out are traceable to national standards. The uncertainty of the measurement at a confidence level of approximately 95% (in the case where distributions are normal), with a coverage factor of 2, is +/-6dB.
4. Environmental Conditions

Temperature	15°C
Relative Humidity	50%
Atmospheric Pressure	1019mbar
5. Test date : 21 July, 2011
Tested By : Peter Cai

The result: Pass



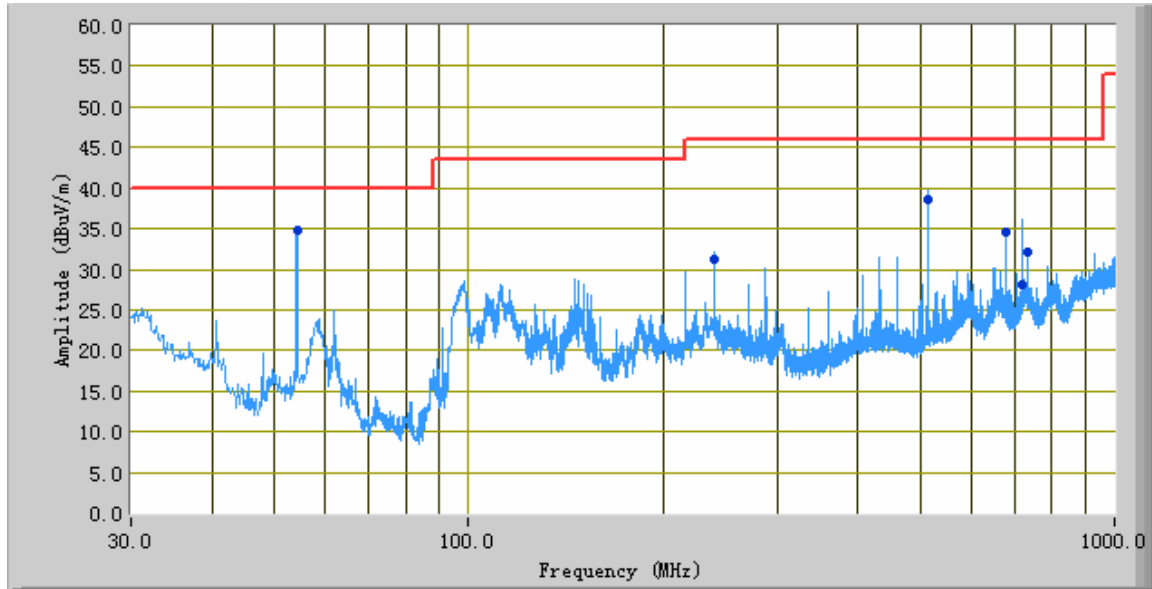

Peak Detector 
Quasi Peak Limit 



Test Data

Frequency (MHz)	Quasi Peak (dBuV/m)	Azimuth	Polarity(H/V)	Height (cm)	Factors (dB)	Limit (dBuV/m)	Margin (dB)
54.25	34.69	46.00	V	203.00	-36.89	40.00	-5.31
515.36	38.55	348.00	V	107.00	-27.51	46.00	-7.45
721.44	28.16	290.00	V	141.00	-20.80	46.00	-17.84
678.11	34.62	86.00	V	103.00	-21.79	46.00	-11.38
732.36	32.08	1.00	V	102.00	-20.72	46.00	-13.92
240.00	31.25	84.00	V	194.00	-30.62	46.00	-14.75

Peak Detector 
 Quasi Peak Limit 

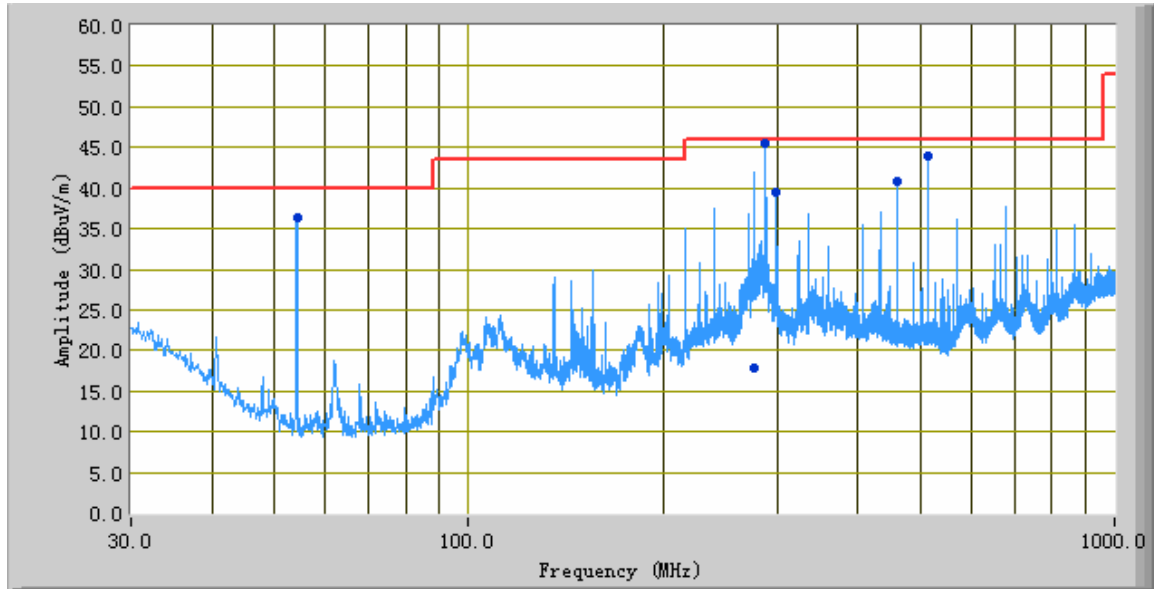

Test Data

Frequency (MHz)	Quasi Peak (dBuV/m)	Azimuth	Polarity(H /V)	Height (cm)	Factors (dB)	Limit (dBuV/m)	Margin (dB)
288.00	45.41	312.00	H	100.00	-27.11	46.00	-0.59
515.36	43.90	262.00	H	211.00	-27.13	46.00	-2.10
54.25	36.46	355.00	H	396.00	-36.78	40.00	-3.54
276.26	17.75	96.00	H	288.00	-27.73	46.00	-28.25
461.09	40.85	318.00	H	203.00	-27.15	46.00	-5.15
298.36	39.40	317.00	H	101.00	-27.48	46.00	-6.60

5.5 Frequency Stability

Requirement(s): 47 CFR § 15.225(e)

Procedures: Frequency Stability was measured according to 47 CFR § 2.1055. Measurement was taken with spectrum analyzer. The spectrum analyzer bandwidth and span was set to read in hertz. A voltmeter was used to monitor when varying the voltage.

Limit: $\pm 0.01\%$ of 13.56MHz=1356Hz

- | | | | |
|----|---------------------------|----------------------|----------|
| 1. | Environmental Conditions | Temperature | 15°C |
| | | Relative Humidity | 50% |
| | | Atmospheric Pressure | 1019mbar |
| 2. | Test date : 21 July, 2011 | | |
| | Tested By : Peter Cai | | |

The result: Pass

Frequency Stability versus Temperature: The Frequency tolerance of the carrier signal shall be maintained within $\pm 0.01\%$ of the operating frequency over a temperature variation of -20°C to +50°C at normal supply voltage.

Reference Frequency: 13.56MHz at -20°C to +50°C

Temperature (oC)	Measured Freq. (MHz)	Freq. Drift (Hz)	Freq. Deviation (Limit: 0.01%)	Pass/Fail
50	13.5607	700	<0.01	Pass
40	13.5608	800	<0.01	Pass
30	13.5609	900	<0.01	Pass
20	Reference			
10	13.5607	700	<0.01	Pass
0	13.5607	700	<0.01	Pass
-10	13.5607	700	<0.01	Pass
-20	13.5608	800	<0.01	Pass

Frequency Stability versus Input Voltage: The frequency tolerance of the carrier signal shall be maintained within $\pm 0.01\%$, the frequency of the transmitter was measured at 85% and at 115% of the rated power supply voltage at 20°C environmental temperature.

Carrier Frequency: 13.56MHz at 20°C at 5VDC

Measured Voltage $\pm 15\%$ of nominal (DC)	Measured Freq. (MHz)	Freq. Drift (Hz)	Freq. Deviation (Limit: 0.01%)	Pass/Fail
4.25	13.5607	700	<0.01	Pass
5.75	13.5606	600	<0.01	Pass



Loop Antenna Positioned at 0 degree

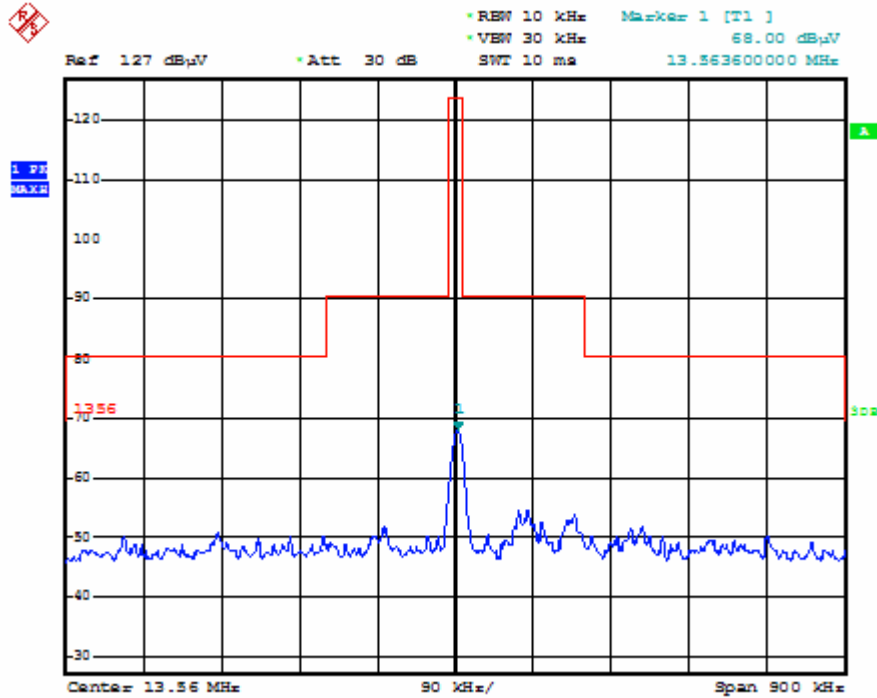

Loop Antenna Positioned at 90 degree

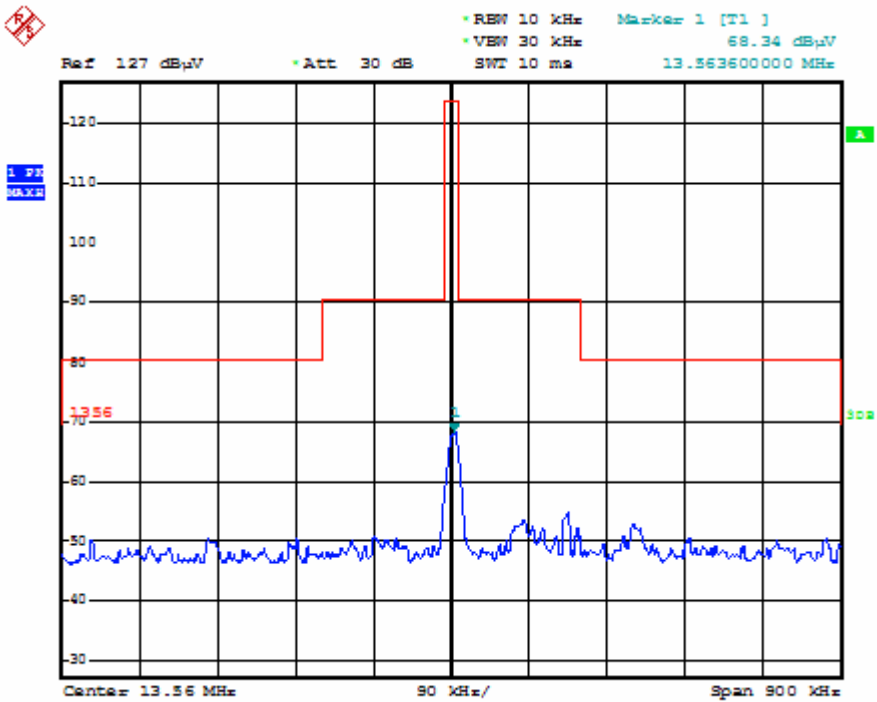

Annex A. TEST INSTRUMENT & METHOD

Annex A.i. TEST INSTRUMENTATION & GENERAL PROCEDURES

Instrument	Manufacturer	Model	CAL Due Date
Spectrum Analyzer	HP	8563 E	2012.01.10
EMI Receiver	Rohde & Schwarz	ESPI 3	2012.05.25
Antenna (30MHz~2GHz)	Sunol Sciences	JB1	2011.10.04
Horn Antenna (1~18GHz)	A-INFOMW	JXTXLB-10180	2012.06.24
Horn Antenna (1~18GHz)	ETS-Lindgren	3115	2011.10.03
Pre-Amplifier(0.01 ~ 1.3GHz)	HP	8447F	2012.05.25
Pre-Amplifier(0.1 ~ 18GHz)	MITEQ	AMF-7D-00101800-30- 10P	2012.05.25
Horn Antenna (18~40GHz)	Com Power	AH-840	2012.05.21
Microwave Pre-Amp (18~40GHz)	Com Power	PA-840	2012.05.21
RF POWER METER	BOONTON	4231A	2012.04.23
POWER SENSOR	BOONTON	51011-EMC	2012.04.23

Annex A.ii. CONDUCTED EMISSIONS TEST DESCRIPTION

Test Set-up

1. The EUT and supporting equipment were set up in accordance with the requirements of the standard on top of a 1.5m x 1m x 0.8m high, non-metallic table, as shown in Annex B.
2. The power supply for the EUT was fed through a 50Ω/50μH EUT LISN, connected to filtered mains.
3. The RF OUT of the EUT LISN was connected to the EMI test receiver via a low-loss coaxial cable.
4. All other supporting equipments were powered separately from another main supply.

Test Method

1. The EUT was switched on and allowed to warm up to its normal operating condition.
2. A scan was made on the NEUTRAL line (for AC mains) or Earth line (for DC power) over the required frequency range using an EMI test receiver.
3. High peaks, relative to the limit line, were then selected.
4. The EMI test receiver was then tuned to the selected frequencies and the necessary measurements made with a receiver bandwidth setting of 10 KHz. For FCC tests, only Quasi-peak measurements were made; while for CISPR/EN tests, both Quasi-peak and Average measurements were made.
5. Steps 2 to 4 were then repeated for the LIVE line (for AC mains) or DC line (for DC power).

Sample Calculation Example

At 20 MHz limit = 250 μV = 47.96 dBμV

Transducer factor of LISN, pulse limiter & cable loss at 20 MHz = 11.20 dB

Q-P reading obtained directly from EMI Receiver = 40.00 dBμV
(Calibrated for system losses)

Therefore, Q-P margin = 47.96 – 40.00 = 7.96 i.e. **7.96 dB below limit**

Annex A. iii. RADIATED EMISSIONS TEST DESCRIPTION

EUT Characterisation

EUT characterisation, over the frequency range from 30MHz to 10th Harmonic , was done in order to minimise radiated emissions testing time while still maintaining high confidence in the test results.

The EUT was placed in the chamber, at a height of about 0.8m on a turntable. Its radiated emissions frequency profile was observed, using a spectrum analyzer /receiver with the appropriate broadband antenna placed 3m away from the EUT. Radiated emissions from the EUT were maximised by rotating the turntable manually, changing the antenna polarisation and manipulating the EUT cables while observing the frequency profile on the spectrum analyzer / receiver. Frequency points at which maximum emissions occurred, clock frequencies and operating frequencies were then noted for the formal radiated emissions test at the Open Area Test Site (OATS).

Test Set-up

1. The EUT and supporting equipment were set up in accordance with the requirements of the standard on top of a 1.5m X 1.0m X 0.8m high, non-metallic table.
2. The filtered power supply for the EUT and supporting equipment were tapped from the appropriate power sockets located on the turntable.
3. The relevant broadband antenna was set at the required test distance away from the EUT and supporting equipment boundary.

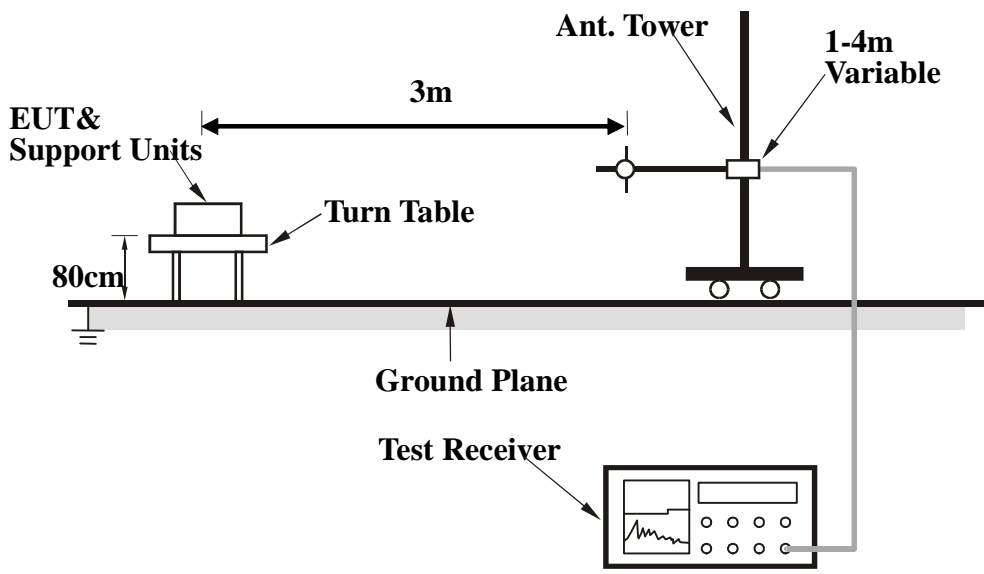

Test Method

The following procedure was performed to determine the maximum emission axis of EUT:

1. With the receiving antenna is H polarization, rotate the EUT in turns with three orthogonal axes to determine the axis of maximum emission.
2. With the receiving antenna is V polarization, rotate the EUT in turns with three orthogonal axes to determine the axis of maximum emission.
3. Compare the results derived from above two steps. So, the axis of maximum emission from EUT was determined and the configuration was used to perform the final measurement.

Final Radiated Emission Measurement

1. Setup the configuration according to figure 1. Turn on EUT and make sure that it is in normal function.
2. For emission frequencies measured below 1 GHz, a pre-scan is performed in a shielded chamber to determine the accurate frequencies of higher emissions will be checked on a open test site. As the same purpose, for emission frequencies measured above 1 GHz, a pre-scan also be performed with a 1 meter measuring distance before final test.
3. For emission frequencies measured below and above 1 GHz, set the spectrum analyzer on a 100 kHz and 1 MHz resolution bandwidth respectively for each frequency measured in step 2.
4. The search antenna is to be raised and lowered over a range from 1 to 4 meters in horizontally polarized orientation. Position the highness when the highest value is indicated on spectrum analyzer, then change the orientation of EUT on test table over a range from 0 ° to 360 ° with a speed as slow as possible, and keep the azimuth that highest emission is indicated on the spectrum analyzer. Vary the antenna position again and record the highest value as a final reading.
5. Repeat step 4 until all frequencies need to be measured were complete.
6. Repeat step 5 with search antenna in vertical polarized orientations.

During the radiated emission test, the Spectrum Analyzer was set with the following configurations:

Frequency Band (MHz)	Function	Resolution bandwidth	Video Bandwidth
30 to 1000	Peak	100 kHz	100 kHz
Above 1000	Peak	1 MHz	1 MHz
	Average	1 MHz	10 Hz

Sample Calculation Example

The field strength is calculated by adding the Antenna Factor and Cable Factor, and subtracting the Amplifier Gain (if any) from the measured reading. For the limit is employed average value, therefore the peak value can be transferred to average value by subtracting the duty factor. The basic equation with a sample calculation is as follows:

$$\text{Peak} = \text{Reading} + \text{Corrected Factor}$$

where

$$\text{Corr. Factor} = \text{Antenna Factor} + \text{Cable Factor} - \text{Amplifier Gain (if any)}$$

And the average value is

$$\text{Average} = \text{Peak Value} + \text{Duty Factor or}$$

$$\text{Set RBW} = 1\text{MHz, VBW} = 10\text{Hz.}$$

Note:

If the measured frequencies are fall in the restricted frequency band, the limit employed must be quasi peak value when frequencies are below or equal to 1 GHz. And the measuring instrument is set to quasi peak detector function.

Annex B. EUT AND TEST SETUP PHOTOGRAPHS

Annex B.i. Photograph: EUT External Photo



Top View of EUT



Bottom View of EUT

Annex B.ii. Photograph: EUT Internal Photo

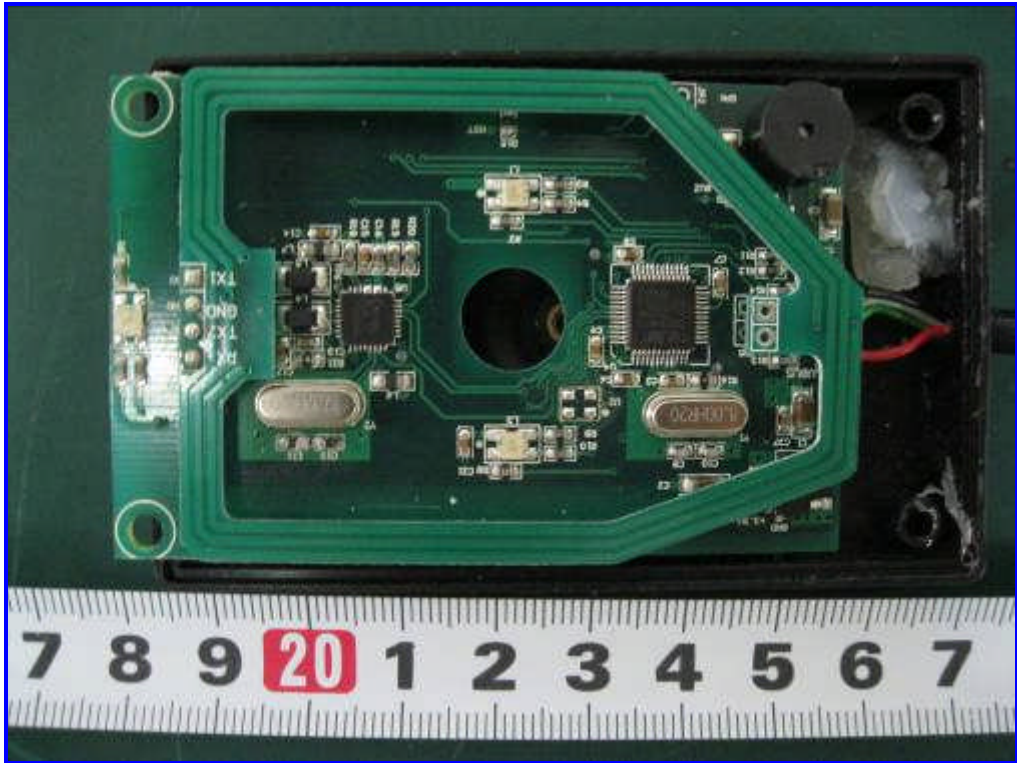

Front View of Main PCB Board

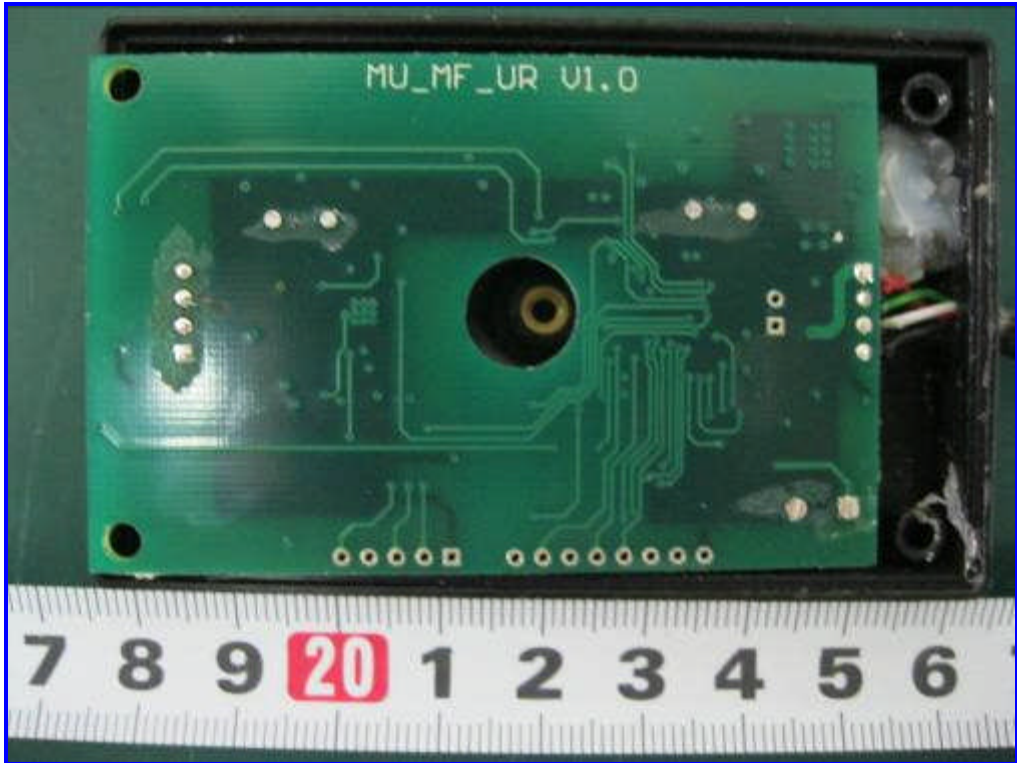

Rear View of Main PCB Board

Annex B.iii. Photograph: Test Setup Photo



Conducted Emission Test Setup Front View



Conducted Emission Test Setup Side View

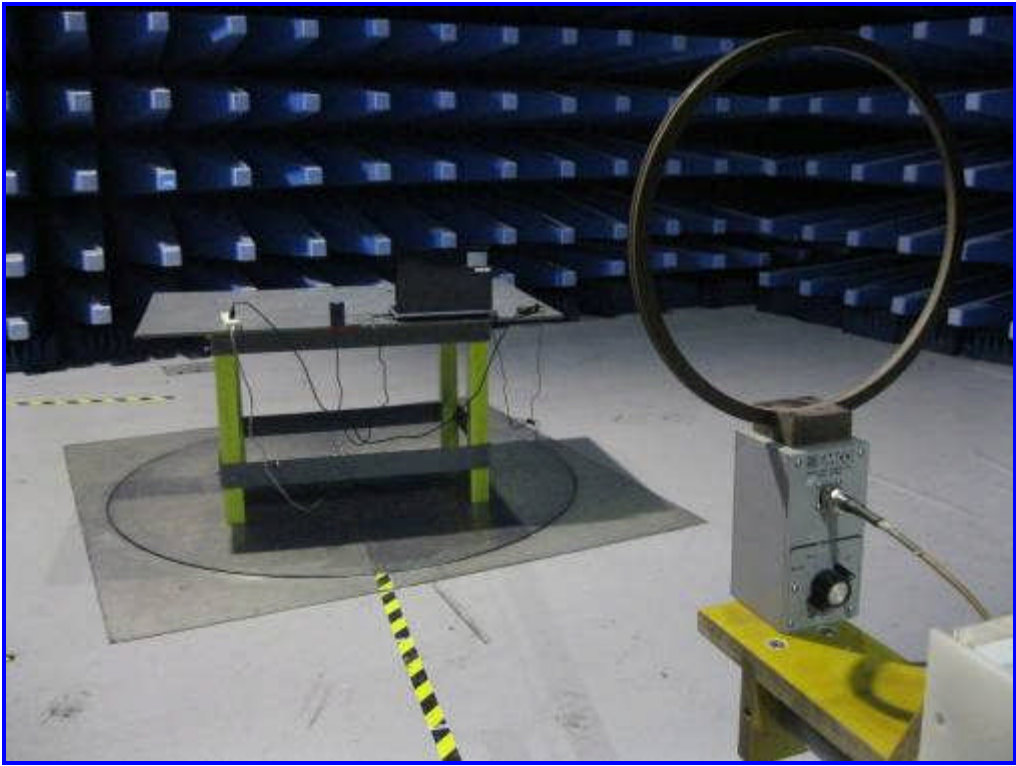

Front View of Radiated Emission Test Setup below 30MHz

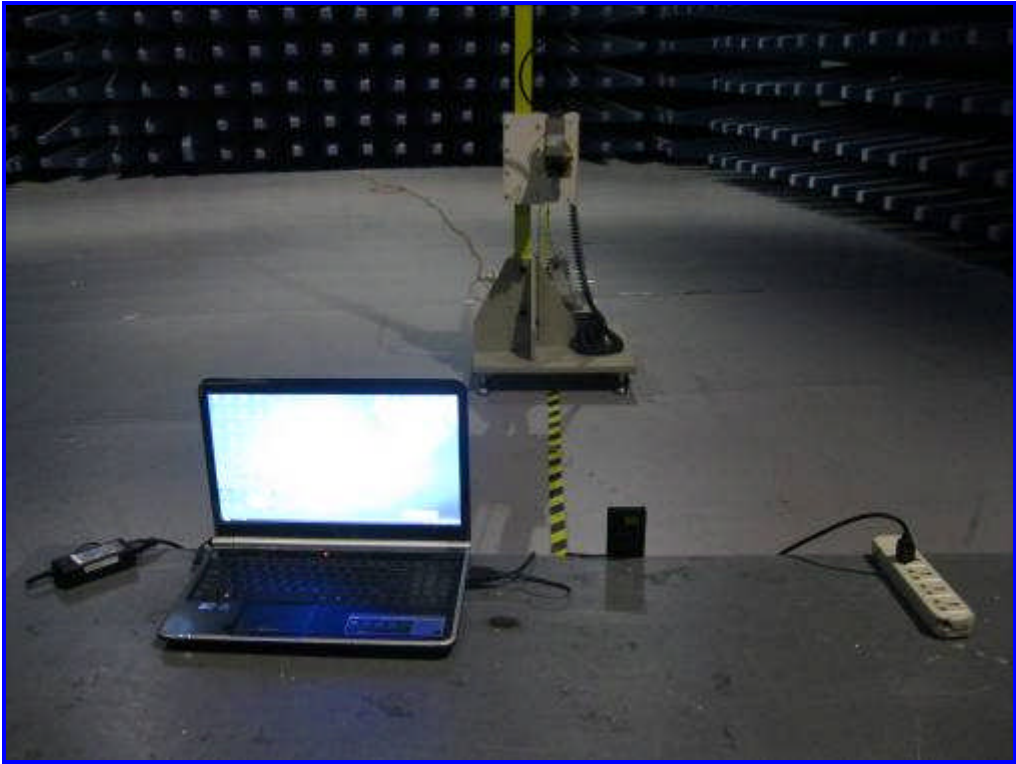

Rear View of Radiated Emission Test Setup below 30MHz



Front View of Radiated Emission Test Setup above 30MHz

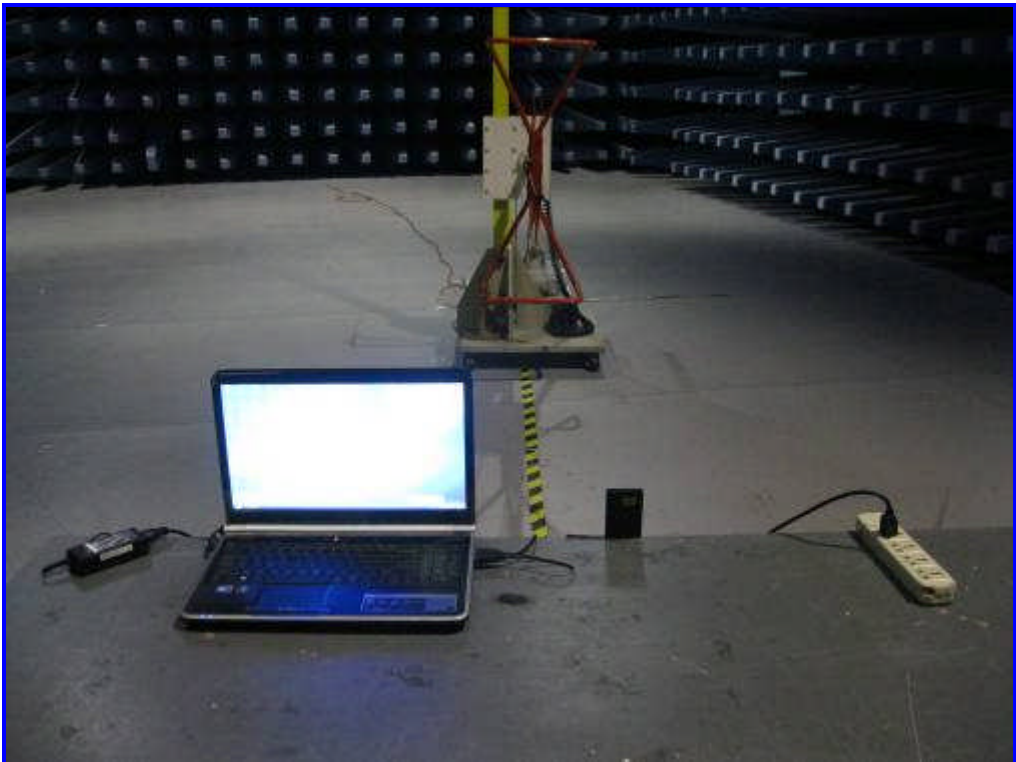

Rear View of Radiated Emission Test Setup above 30MHz

Annex C. TEST SETUP AND SUPPORTING EQUIPMENT

EUT TEST CONDITIONS

Annex C. i. SUPPORTING EQUIPMENT DESCRIPTION

The following is a description of supporting equipment and details of cables used with the EUT.

Equipment Description (Including Brand Name)	Model & Serial Number	Cable Description (List Length, Type & Purpose)
Gateway Laptop	MS2288 & LXWHF02013951C3CA92200	N/A



Block Configuration Diagram for Conducted Emissions

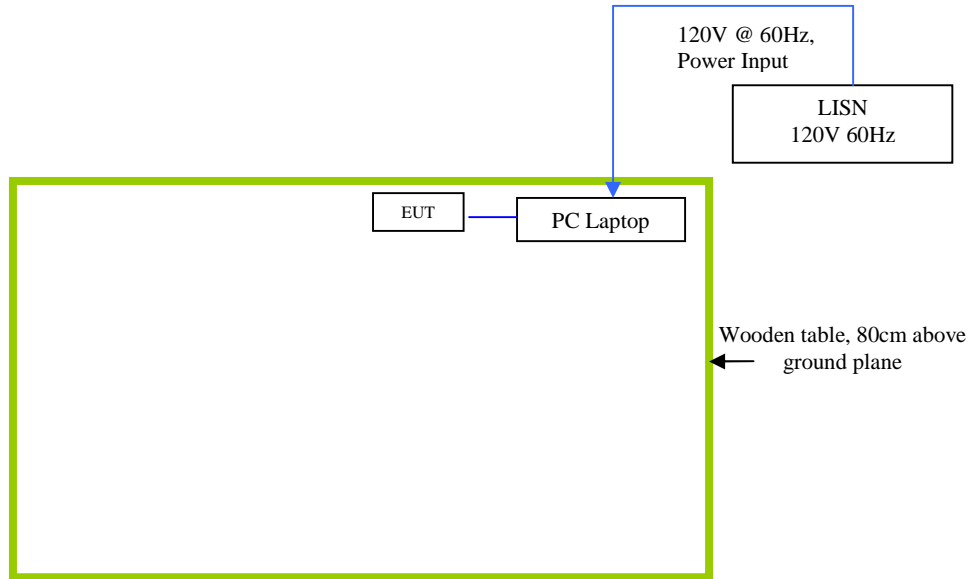

Block Configuration Diagram for Radiated Emissions

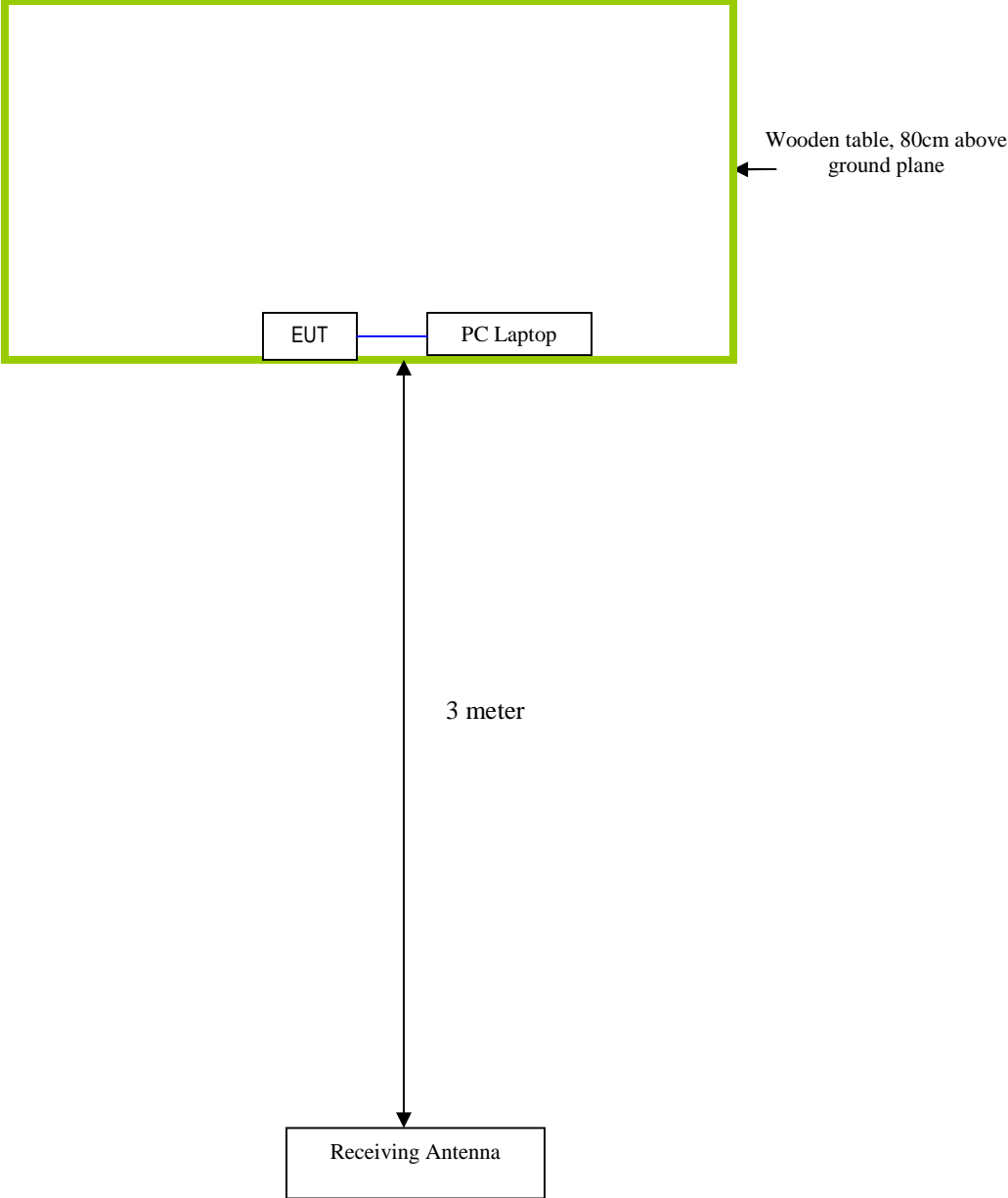



SIEMIC, INC.

Accessing global markets

Title: RF Test Report for Card Reader
Model: MW4621
To: FCC Part 15.225: 2010

Serial#: 11020588-FCC
Issue Date: 22 July, 2011
Page: 33 of 37
www.siemec.com.cn

Annex C.ii. EUT OPERATING CONDITIONS

The following is the description of how the EUT is exercised during testing.

Test	Description Of Operation
Emissions Testing	The EUT was continuously transmitting to stimulate the worst case.



SIEMIC, INC.

Accessing global markets

Title: RF Test Report for Card Reader
Model: MW4621
To: FCC Part 15.225: 2010

Serial#: 11020588-FCC
Issue Date: 22 July, 2011
Page: 34 of 37
www.siemac.com.cn

Annex D. USER MANUAL / BLOCK DIAGRAM / SCHEMATICS / PART LIST

Please see attachment

Annex E. SIEMIC ACCREDITATION CERTIFICATES

SIEMIC ACCREDITATION DETAILS: FCC Registration NO:986914





SIEMIC, Inc.

Accessing global markets

Title: RF Test Report for Card Reader
Model: MW4621
To: FCC Part 15.225: 2010

Serial#: 11020588-FCC
Issue Date: 22 July, 2011
Page: 36 of 37
www.siemic.com.cn

SIEMIC ACCREDITATION DETAILS: FCC Listing, Registration NO:986914

FEDERAL COMMUNICATIONS COMMISSION

Laboratory Division
7435 Oakland Mills Road
Columbia, MD 21046

April 25, 2008

Registration Number: 986914

SIEMIC Nanjing (China) Laboratories
2-1 Longcang Avenue,
Yuhua Economic and Technology Development Park,
Nanjing, 210039
China

Attention: Leslie Bai

Re: Measurement facility located at 2-1 Longcang Avenue, Nanjing, China
Anechoic chamber (3 meters) and 3&10 meter OATS
Date of Listing: April 25, 2008

Dear Sir or Madam:

Your request for registration of the subject measurement facility has been reviewed and found to be in compliance with the requirements of Section 2.948 of the FCC rules. The information has, therefore, been placed on file and the name of your organization added to the list of facilities whose measurement data will be accepted in conjunction with applications for Certification under Parts 15 or 18 of the Commission's Rules. Please note that the file must be updated for any changes made to the facility and the registration must be renewed at least every three years.

Measurement facilities that have indicated that they are available to the public to perform measurement services on a fee basis may be found on the FCC website www.fcc.gov under E-Filing, OET Equipment Authorization Electronic Filing, Test Firms.

Sincerely,

Katie Hawkins
Electronics Engineer



SIEMIC, INC.

Accessing global markets

Title: RF Test Report for Card Reader
Model: MW4621
To: FCC Part 15.225: 2010

Serial#: 11020588-FCC
Issue Date: 22 July, 2011
Page: 37 of 37
www.siemic.com.cn

SIEMIC ACCREDITATION DETAILS: Industry of Canada Registration No. 4842

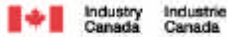

January 25, 2011

OUR FILE: 46405-4842
Submission No: 145222

Siemic Nanjing (China) Laboratories
2-1 Longcang Avenue
Yuhua Economic & Technology Dev. Park, Nanjing
China

Attention: Leslie Bai

Dear Sir/Madame:

The Bureau has received your application for the registration of a 3/10m OATS. Be advised that the information received was satisfactory to Industry Canada. The following number(s) is now associated to the site(s) for which registration / renewal was sought (Site# 4842B-2). Please reference the appropriate site number in the body of test reports containing measurements performed on the site. In addition, please keep for your records the following information;

- The company address code associated to the site(s) located at the above address is: **4842B**

Furthermore, to obtain or renew a unique site number, the applicant shall demonstrate that the site has been accredited to ANSI C63.4-2003 or later. A scope of accreditation indicating the accreditation by a recognized accreditation body to ANSI C63.4-2003 or later shall be accepted. Please indicate in a letter the previous assigned site number if applicable and the type of site (example: 3 metre OATS or 3 metre chamber). If the test facility is not accredited to ANSI C63.4-2003 or later, the test facility shall submit test data demonstrating full compliance with the ANSI standard. The Bureau will evaluate the filing to determine if recognition shall be granted.

The frequency for re-validation of the test site and the information that is required to be filed or retained by the testing party shall comply with the requirements established by the accrediting organization. However, in all cases, test site re-validation shall occur on an interval not to exceed three years. There is no fee or form associated with an OATS filing. OATS submissions are encouraged to be submitted electronically to the Bureau using the following URL;
http://strategis.ic.gc.ca/epic/internet/inceb-bhst.nsf/en/h_tr00052e.html.

If you have any questions, you may contact the Bureau by e-mail at certification.bureau@ic.gc.ca Please reference our file and submission number above for all correspondence.

Yours sincerely,

Dalwinder Gill
For: Wireless Laboratory Manager
Certification and Engineering Bureau
3701 Carling Ave., Building 94
P.O. Box 11490, Station "H"
Ottawa, Ontario K2H 8S2
Email: dalwinder.gill@ic.gc.ca
Tel. No. (613) 998-8363
Fax. No. (613) 990-4752