

Power Module

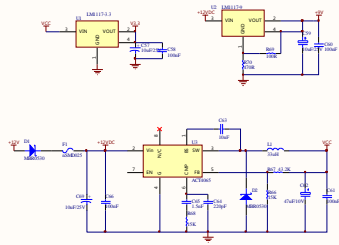

Interface module

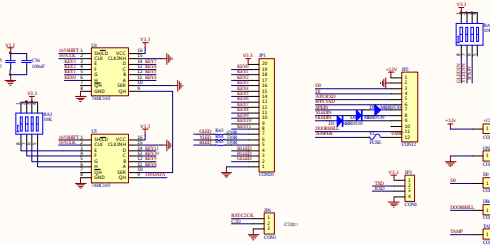

Driver Module

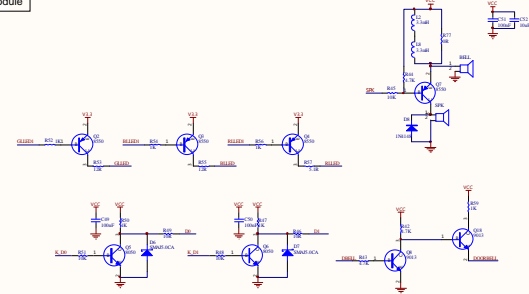

Tamper circuit module

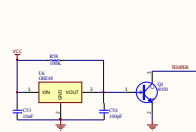

Communication Module

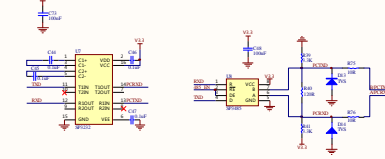

MCU module-1

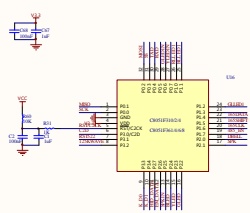

11520 MF module

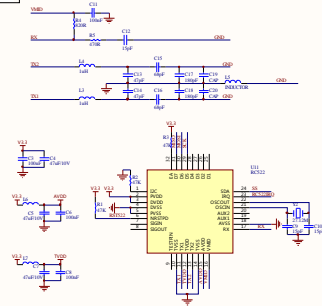

Rev		
By		
Chk		
Appr		