

EMC TEST REPORT



Report No.: 16020760-FCC-E

Supersede Report No.: N/A

Applicant	Shanghai Smarfid Security Equipment Co.,Ltd	
Product Name	Magic MINI 125KHZ Reader	
Main Model	HR382-8N	
Serial Model	EM382-8N	
Test Standard	FCC Part 15 Subpart C:2015, ANSI C63.10:2013	
Test Date	July 25 to July 27, 2016	
Issue Date	August 05, 2016	
Test Result	<input checked="" type="checkbox"/> Pass <input type="checkbox"/> Fail	
Equipment complied with the specification	<input checked="" type="checkbox"/>	
Equipment did not comply with the specification	<input type="checkbox"/>	
<i>Louise Tu</i>	<i>Miro Bao</i>	
Louise Tu Test Engineer	Miro Bao Checked By	
This test report may be reproduced in full only Test result presented in this test report is applicable to the tested sample only		

Issued by:

SIEMIC (Nanjing-China) Laboratories

2-1 Longcang Avenue Yuhua Economic and
Technology Development Park, Nanjing, China

Tel:+86(25)86730128/86730129 Fax:+86(25)86730127 Email: China@siemic.com.cn

Laboratories Introduction

SIEMIC, headquartered in the heart of Silicon Valley, with superior facilities in US and Asia, is one of the leading independent testing and certification facilities providing customers with one-stop shop services for Compliance Testing and Global Certifications.



In addition to testing and certification, SIEMIC provides initial design reviews and compliance management throughout a project. Our extensive experience with China, Asia Pacific, North America, European, and International compliance requirements, assures the fastest, most cost effective way to attain regulatory compliance for the global markets.

Accreditations for Conformity Assessment

Country/Region	Scope
USA	EMC, RF/Wireless, SAR, Telecom
Canada	EMC, RF/Wireless, SAR, Telecom
Taiwan	EMC, RF, Telecom, SAR, Safety
Hong Kong	RF/Wireless, SAR, Telecom
Australia	EMC, RF, Telecom, SAR, Safety
Korea	EMI, EMS, RF, SAR, Telecom, Safety
Japan	EMI, RF/Wireless, SAR, Telecom
Singapore	EMC, RF, SAR, Telecom
Europe	EMC, RF, SAR, Telecom, Safety

Test Report No.	16020760-FCC-E
Page	3 of 28

This page has been left blank intentionally.

CONTENTS

1. REPORT REVISION HISTORY.....	5
2. CUSTOMER INFORMATION	5
3. TEST SITE INFORMATION.....	5
4. EQUIPMENT UNDER TEST (EUT) INFORMATION	6
5. TEST SUMMARY	7
6. MEASUREMENTS, EXAMINATION AND DERIVED RESULTS	8
6.1 AC POWER LINE CONDUCTED EMISSIONS.....	8
6.2 RADIATED EMISSIONS.....	12
ANNEX A. TEST INSTRUMENT.....	16
ANNEX B. EUT AND TEST SETUP PHOTOGRAPHS	17
ANNEX C. TEST SETUP AND SUPPORTING EQUIPMENT.....	24
ANNEX D. USER MANUAL / BLOCK DIAGRAM / SCHEMATICS / PARTLIST.....	27
ANNEX E. DECLARATION OF SIMILARITY	28

1. Report Revision History

Report No.	Report Version	Description	Issue Date
16020760-FCC-E	NONE	Original	August 05, 2016

2. Customer information

Applicant Name	Shanghai Smarfid Security Equipment Co.,Ltd
Applicant Add	Room 301,4th Bldg., No.4 TongLi Road, SongJiang District,Shanghai 201615,China
Manufacturer	Shanghai Smarfid Security Equipment Co.,Ltd
Manufacturer Add	Room 301,4th Bldg., No.4 TongLi Road, SongJiang District,Shanghai 201615,China

3. Test site information

Lab performing tests	SIEMIC (Nanjing-China) Laboratories
Lab Address	2-1 Longcang Avenue Yuhua Economic and Technology Development Park, Nanjing, China
FCC Test Site No.	986914
IC Test Site No.	4842B-1
Test Software	Labview of SIEMIC version 1.0

4. Equipment under Test (EUT) Information

Description of EUT: Magic MINI 125KHZ Reader

Main Model: HR382-8N

Serial Model: EM382-8N

Date EUT received: July 21, 2016

Test Date(s): July 25 to July 27, 2016

Operating Frequency : 125kHz

Antenna Gain 15 dBi

Type of Modulation: ASK

Number of Channels: 1 CH

Trade Name : N/A

FCC ID: X3A-MG382125K

Note: the difference between these models please refer to **ANNEX E. DECLARATION OF SIMILARITY.**

5. Test Summary

The product was tested in accordance with the following specifications.
All testing has been performed according to below product classification:

FCC Rules	Description of Test	Result
§15.207; ANSI C63.10: 2013	AC Power Line Conducted Emissions	Compliance
§15.209; ANSI C63.10: 2013	Radiated Emissions	Compliance

Measurement Uncertainty

Emissions		
Test Item	Description	Uncertainty
Radiated Emissions	Confidence level of approximately 95% (in the case where distributions are normal), with a coverage factor of 2 (for EUTs < 0.5m X 0.5m X 0.5m)	3.952dB

6. Measurements, Examination And Derived Results

6.1 AC Power Line Conducted Emissions

Temperature	24°C
Relative Humidity	50%
Atmospheric Pressure	1019mbar
Test date :	July 27, 2016
Tested By :	Louise Tu

Requirement(s):

Spec	Requirement	Applicable														
§15.207	<p>For Low-power radio-frequency devices that is designed to be connected to the public utility (AC) power line, the radio frequency voltage that is conducted back onto the AC power line on any frequency or frequencies, within the band 150 kHz to 30 MHz, shall not exceed the limits in the following table, as measured using a 50 [mu]H/50 ohms line impedance stabilization network (LISN). The lower limit applies at the boundary between the frequencies ranges.</p> <table border="1"> <thead> <tr> <th rowspan="2">Frequency ranges (MHz)</th> <th colspan="2">Limit (dBµV)</th> </tr> <tr> <th>QP</th> <th>Average</th> </tr> </thead> <tbody> <tr> <td>0.15 ~ 0.5</td> <td>66 – 56</td> <td>56 – 46</td> </tr> <tr> <td>0.5 ~ 5</td> <td>56</td> <td>46</td> </tr> <tr> <td>5 ~ 30</td> <td>60</td> <td>50</td> </tr> </tbody> </table>	Frequency ranges (MHz)	Limit (dBµV)		QP	Average	0.15 ~ 0.5	66 – 56	56 – 46	0.5 ~ 5	56	46	5 ~ 30	60	50	<input checked="" type="checkbox"/>
Frequency ranges (MHz)	Limit (dBµV)															
	QP	Average														
0.15 ~ 0.5	66 – 56	56 – 46														
0.5 ~ 5	56	46														
5 ~ 30	60	50														
Test Setup	<p style="text-align: center;"> Note: 1. Support units were connected to second LISN. 2. Both of LISNs (AMN) are 80cm from EUT and at least 80cm from other units and other metal planes support units. </p>															
Procedure	<ol style="list-style-type: none"> The EUT and supporting equipment were set up in accordance with the requirements of the standard on top of a 1.5m x 1m x 0.8m high, non-metallic table. The power supply for the EUT was fed through a 50W/50mH EUT LISN, connected to filtered mains. The RF OUT of the EUT LISN was connected to the EMI test receiver via a low-loss coaxial cable. All other supporting equipment were powered separately from another main supply. The EUT was switched on and allowed to warm up to its normal operating condition. A scan was made on the NEUTRAL line (for AC mains) or Earth line (for DC power) over the required frequency range using an EMI test receiver. High peaks, relative to the limit line, were then selected, The EMI test receiver was then tuned to the selected frequencies and the necessary measurements made with a receiver bandwidth setting of 10kHz. Steps 6-7 were repeated for the LIVE line (for AC mains) or DC line (for DC power). 															
Remark																
Result	<input checked="" type="checkbox"/> Pass <input type="checkbox"/> Fail															

Test Report No.	16020760-FCC-E
Page	9 of 28

Test Data	<input checked="" type="checkbox"/> Yes	<input type="checkbox"/> N/A
Test Plot	<input checked="" type="checkbox"/> Yes	<input type="checkbox"/> N/A

Data sample

Frequency (MHz)	Quasi-Peak (dB μ V)	Limit (dB μ V)	Margin (dB)	Average (dB μ V)	Limit (dB μ V)	Margin (dB)	Factors (dB)
xxx	56.21	66.00	-9.79	39.20	56.00	-16.80	12.22

Frequency (MHz) = Emission frequency in MHz

Quasi-Peak/Average (dB μ V)=Receiver Reading(dB μ V)+ Factor(dB)

Limit(dB μ V)=Limit stated in standard

Factor (dB)= cable loss+ Insertion loss of LISN+ Insertion loss of transient limiter (The transient limiter included 10dB attenuation)

Calculation Formula:

Margin (dB)=Quasi Peak / Average (dB μ V) – limit (dB μ V)

Test Mode:	Transmitting Mode
-------------------	--------------------------

Peak Detector  Quasi Peak Limit 
 Average Detector  Average Limit 

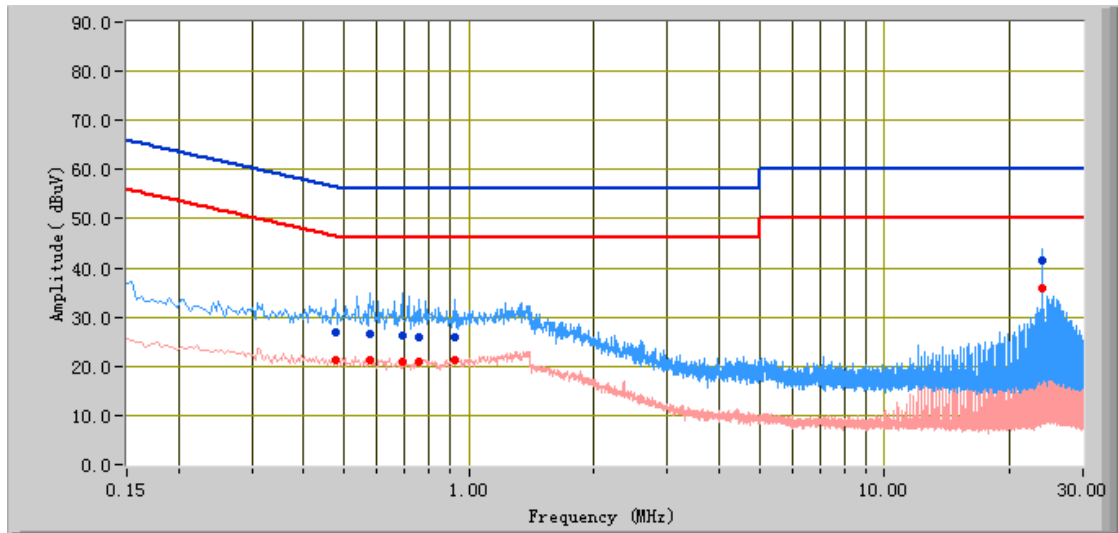

Test Data

Phase Line Plot at 120Vac, 60Hz

Frequency (MHz)	Quasi Peak (dBµV)	Limit (dBµV)	Margin (dB)	Average (dBµV)	Limit (dBµV)	Margin (dB)	Factors (dB)
24.01	41.38	60.00	-18.62	35.73	50.00	-14.27	11.67
0.69	26.10	56.00	-29.90	20.85	46.00	-25.15	10.93
0.58	26.63	56.00	-29.37	21.39	46.00	-24.61	11.03
0.75	26.04	56.00	-29.96	20.95	46.00	-25.05	10.88
0.92	26.00	56.00	-30.00	21.16	46.00	-24.84	10.74
0.48	26.75	56.37	-29.62	21.23	46.37	-25.15	11.12

Test Mode:	Transmitting Mode
-------------------	--------------------------

Peak Detector  Quasi Peak Limit 
 Average Detector  Average Limit 

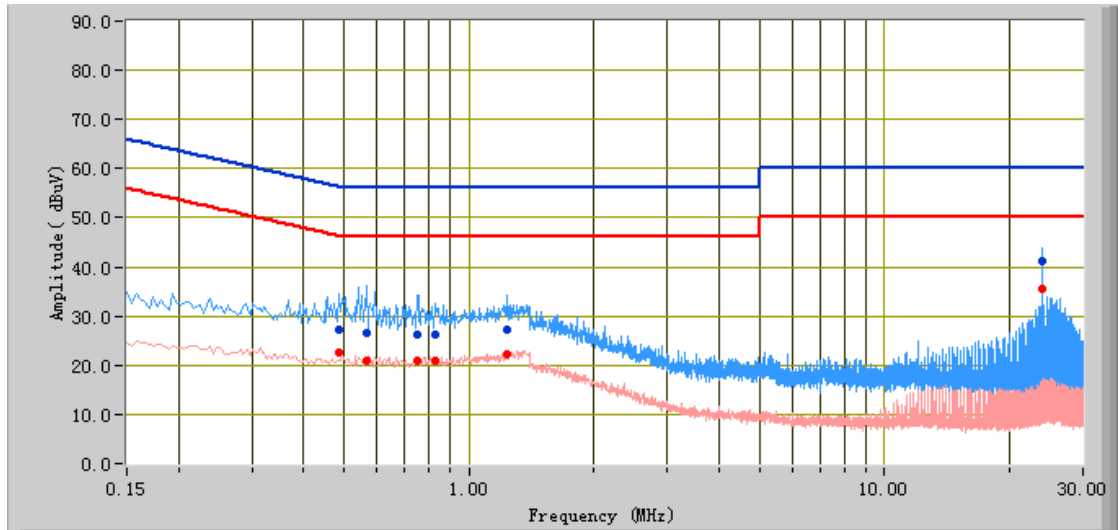

Test Data

Phase Neutral Plot at 120Vac, 60Hz

Frequency (MHz)	Quasi Peak (dBµV)	Limit (dBµV)	Margin (dB)	Average (dBµV)	Limit (dBµV)	Margin (dB)	Factors (dB)
24.01	41.06	60.00	-18.94	35.41	50.00	-14.59	11.70
0.57	26.56	56.00	-29.44	21.08	46.00	-24.92	11.01
0.49	27.28	56.24	-28.96	22.62	46.24	-23.62	11.08
1.24	27.17	56.00	-28.83	22.21	46.00	-23.79	10.75
0.75	26.15	56.00	-29.85	20.92	46.00	-25.08	10.88
0.83	26.11	56.00	-29.89	20.93	46.00	-25.07	10.83

6.2 Radiated Emissions

Temperature	22°C
Relative Humidity	50%
Atmospheric Pressure	1019mbar
Test date :	July 25, 2016
Tested By :	Louise Tu

Requirement(s):

Spec	Requirement	Applicable										
§15.209	<p>Except higher limit as specified elsewhere in other section, the emissions from the low-power radio-frequency devices shall not exceed the field strength levels specified in the following table and the level of any unwanted emissions shall not exceed the level of the fundamental emission. The tighter limit applies at the band edges</p> <table border="1"> <thead> <tr> <th>Frequency range (MHz)</th> <th>Field Strength ($\mu\text{V/m}$)</th> </tr> </thead> <tbody> <tr> <td>30 – 88</td> <td>100</td> </tr> <tr> <td>88 – 216</td> <td>150</td> </tr> <tr> <td>216 – 960</td> <td>200</td> </tr> <tr> <td>Above 960</td> <td>500</td> </tr> </tbody> </table>	Frequency range (MHz)	Field Strength ($\mu\text{V/m}$)	30 – 88	100	88 – 216	150	216 – 960	200	Above 960	500	<input checked="" type="checkbox"/>
Frequency range (MHz)	Field Strength ($\mu\text{V/m}$)											
30 – 88	100											
88 – 216	150											
216 – 960	200											
Above 960	500											

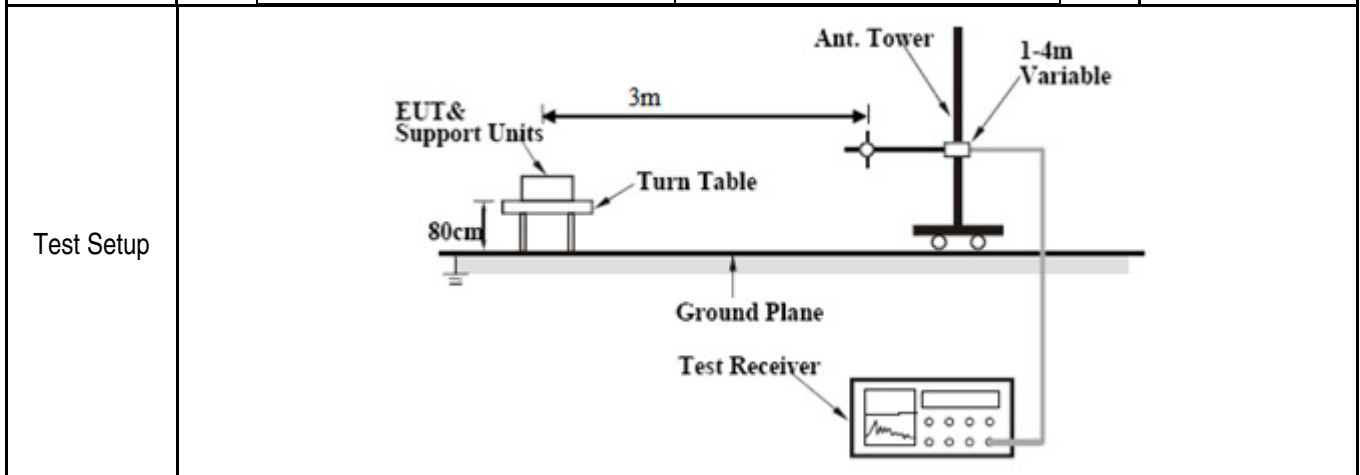

Procedure	<ol style="list-style-type: none"> The EUT was switched on and allowed to warm up to its normal operating condition. The test was carried out at the selected frequency points obtained from the EUT characterisation. Maximization of the emissions, was carried out by rotating the EUT, changing the antenna polarization, and adjusting the antenna height in the following manner: <ol style="list-style-type: none"> Vertical or horizontal polarisation (whichever gave the higher emission level over a full rotation of the EUT) was chosen. The EUT was then rotated to the direction that gave the maximum emission. Finally, the antenna height was adjusted to the height that gave the maximum emission. For emission frequencies measured below and above 1GHz, set the spectrum analyzer on a 100kHz and 1MHz resolution bandwidth respectively for each frequency measured. Steps 2 and 3 were repeated for the next frequency point, until all selected frequency points were measured.
-----------	---

Remark	
--------	--

Result	<input checked="" type="checkbox"/> Pass <input type="checkbox"/> Fail
--------	--

Test Data	<input checked="" type="checkbox"/> Yes <input type="checkbox"/> N/A
-----------	--

Test Plot	<input checked="" type="checkbox"/> Yes <input type="checkbox"/> N/A
-----------	--

Data sample

Frequency (MHz)	Quasi Peak (dB μ V/m)	Azimuth	Polarity (H/V)	Height (cm)	Factors (dB)	Limit (dB μ V/m)	Margin (dB)
xxx	32.23	181.00	H	350.00	-38.23	40.00	-7.77

Frequency (MHz) = Emission frequency in MHz

Quais-Peak (dB μ V/m)= Receiver Reading(dB μ V/m)+ Factor(dB)

Azimuth=Position of turn table

Polarity=Polarity of Receiver antenna

Height(cm)= Height of Receiver antenna

Factor (dB)=Antenna factor + cable loss- antenna gain



Limit (dB μ V/m)=Limit stated in standard

Calculation Formula:

Margin (dB)=Quasi Peak (dB μ V/m) – limit (dB μ V/m)

Test Mode:	Transmitting Mode
-------------------	--------------------------

(30MHz - 1GHz)

Peak Detector 
 Quasi Peak Limit 

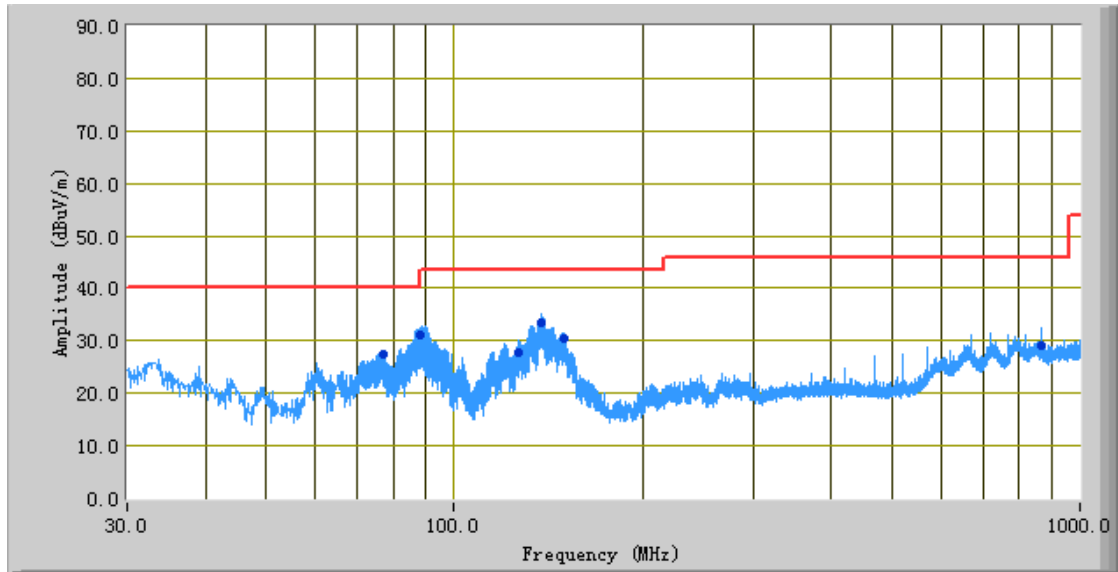



Test Data

Vertical Polarity Plot @3m

Frequency (MHz)	Quasi Peak (dBµV/m)	Azimuth	Polarity (H/V)	Height (cm)	Factors (dB)	Limit (dBµV/m)	Margin (dB)
88.08	31.26	40.00	V	114.00	-36.62	40.00	-8.74
138.12	33.54	55.00	V	103.00	-31.16	43.50	-9.96
149.92	30.29	37.00	V	185.00	-31.21	43.50	-13.21
76.88	27.38	44.00	V	146.00	-37.18	40.00	-12.62
126.47	27.91	66.00	V	107.00	-31.89	43.50	-15.59
866.47	29.14	0.00	V	102.00	-18.13	46.00	-16.86

Test Mode:	Transmitting Mode
-------------------	--------------------------

(30MHz - 1GHz)

Peak Detector 
 Quasi Peak Limit 

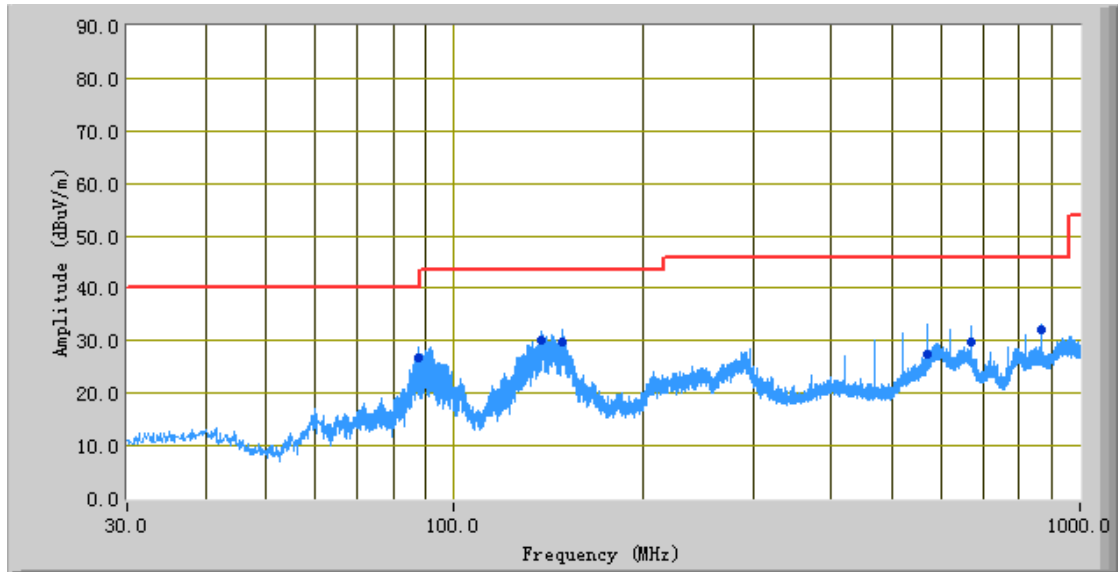

Test Data

Horizontal Polarity Plot @3m

Frequency (MHz)	Quasi Peak (dBµV/m)	Azimuth	Polarity (H/V)	Height (cm)	Factors (dB)	Limit (dBµV/m)	Margin (dB)
87.58	26.90	273.00	H	208.00	-35.85	40.00	-13.10
148.91	29.69	292.00	H	190.00	-31.45	43.50	-13.81
137.75	29.95	287.00	H	210.00	-31.49	43.50	-13.55
569.46	27.48	277.00	H	99.00	-22.88	46.00	-18.52
866.37	32.24	237.00	H	111.00	-19.29	46.00	-13.76
668.35	29.86	0.00	H	352.00	-21.53	46.00	-16.14

Note: The data (9 kHz -30MHz) which below 20 dB to the limit was not recorded.

Note: The highest frequency of the internal sources of the EUT is less than 108MHz, so the measurement shall only be made up to 1GHz.

Annex A. TEST INSTRUMENT

Instrument	Model	Serial #	Cal Date	Cal Due	In use
AC Line Conducted Emissions					
R&S EMI Test Receiver	ESPI3	101216	03/31/2016	03/31/2017	<input checked="" type="checkbox"/>
V-LISN	ESH3-Z5	838979/005	03/31/2016	03/31/2017	<input checked="" type="checkbox"/>
SIEMIC Conducted Labview Emissions software	V1.0	N/A	N/A	N/A	<input checked="" type="checkbox"/>
Radiated Emissions					
Agilent Technologies Spectrum Analyzer	N9010A	MY47191130	03/31/2016	03/31/2017	<input checked="" type="checkbox"/>
R&S EMI Receiver	ESPI3	101216	03/31/2016	03/31/2017	<input checked="" type="checkbox"/>
Antenna (30MHz~6GHz)	JB6	A121411	10/31/2015	10/31/2016	<input checked="" type="checkbox"/>
EMCO Passive Loop Antenna	6509	9909-1469	10/09/2015	10/08/2016	<input checked="" type="checkbox"/>
Hp Agilent Pre-Amplifier	8447F	1937A01160	10/27/2015	10/26/2016	<input checked="" type="checkbox"/>
EMCO Passive Loop Antenna	6509	9909-1469	10/09/2015	10/08/2016	<input checked="" type="checkbox"/>
SIEMIC Radiated Labview Emissions software	V1.0	N/A	N/A	N/A	<input checked="" type="checkbox"/>

Annex B. EUT And Test Setup Photographs

Annex B.i. Photograph: EUT External Photo



EUT – Front View

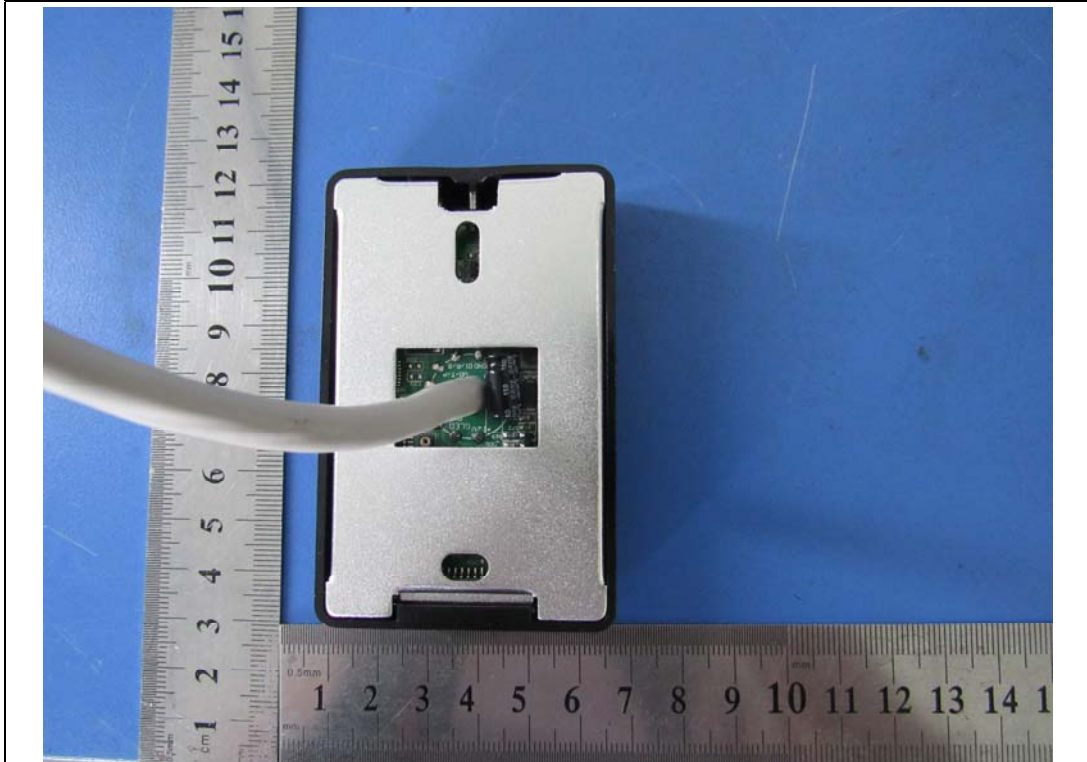

EUT – Rear View

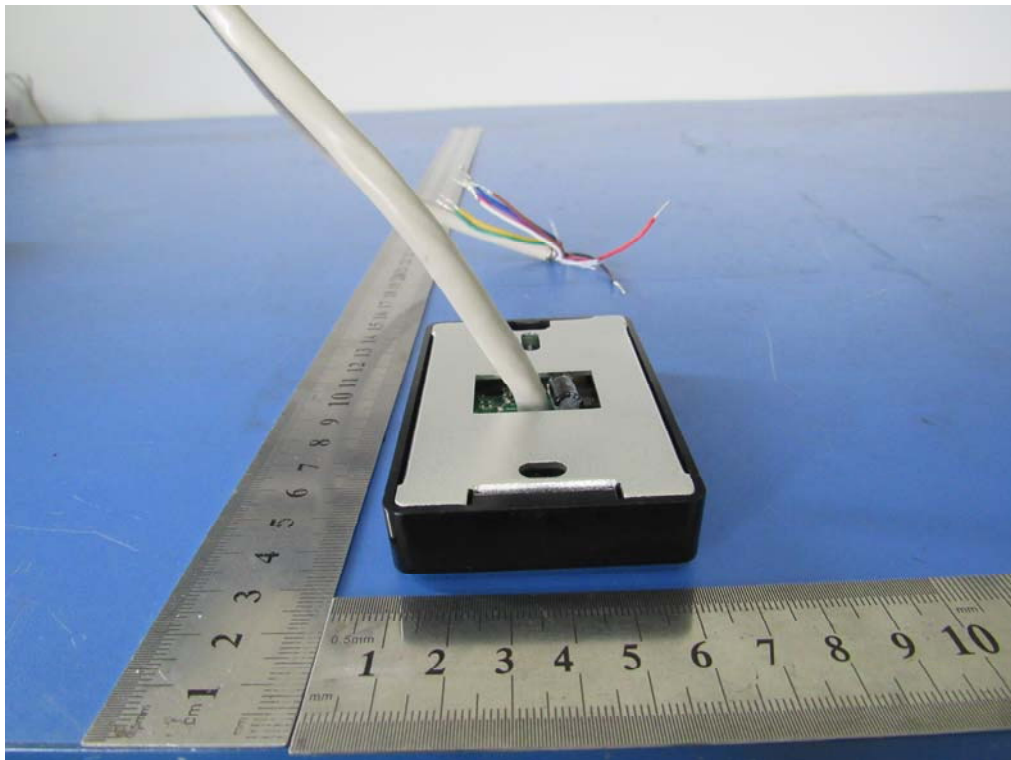

EUT – Top View

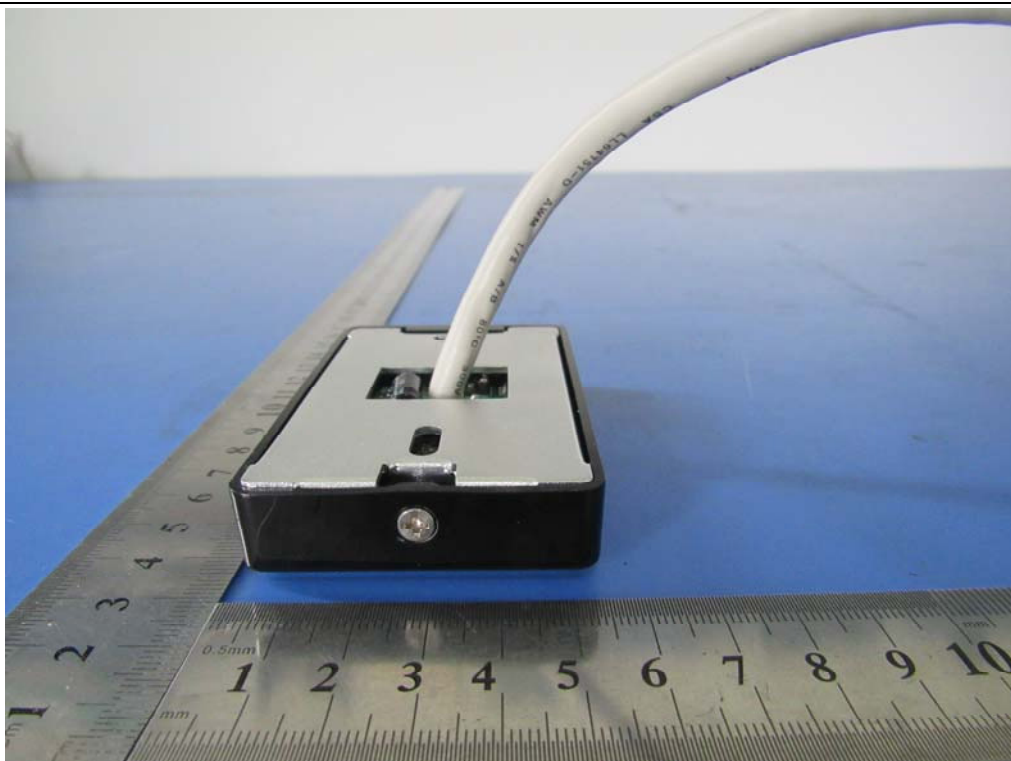

EUT – Bottom View

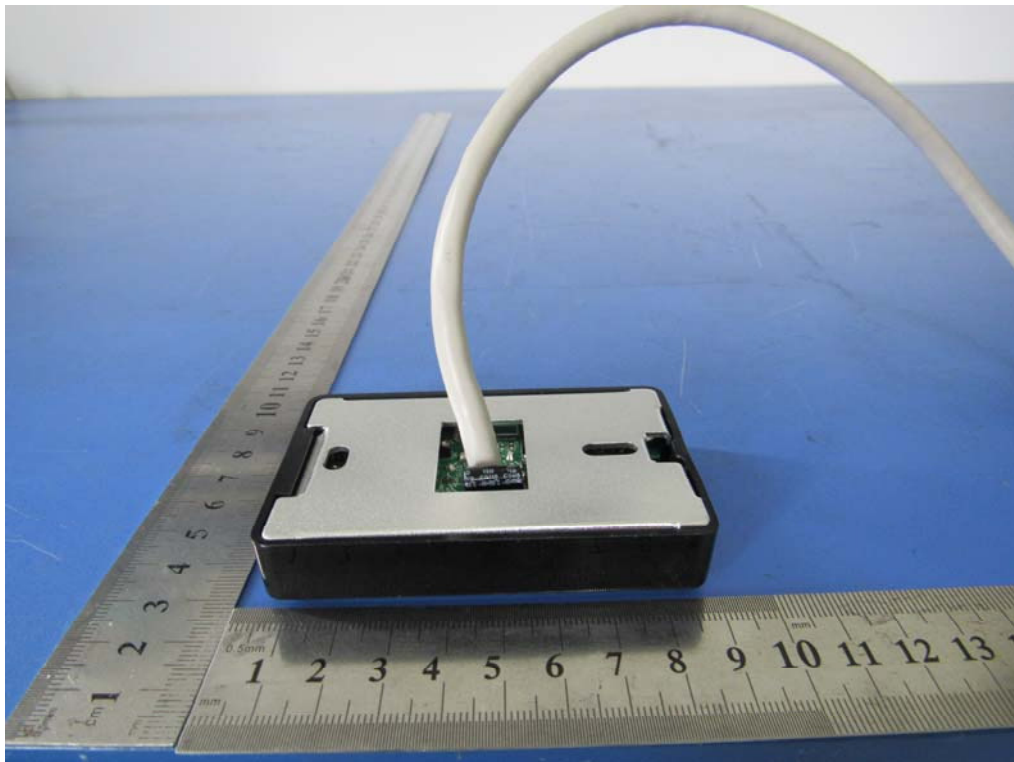

EUT – Left View

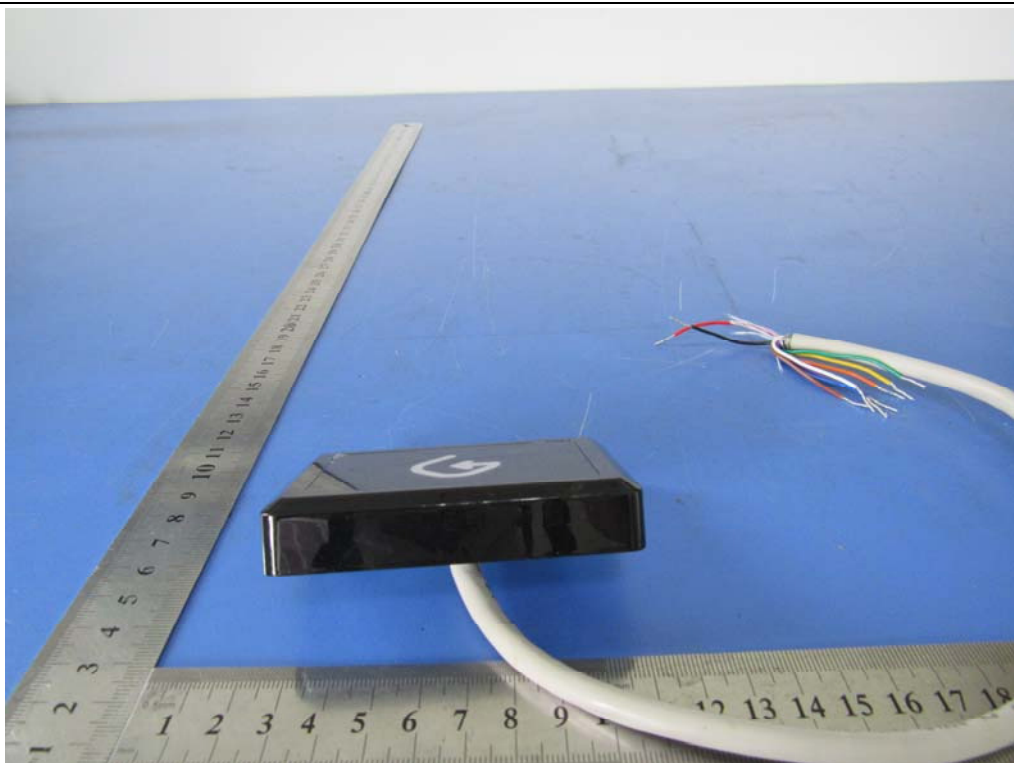

EUT – Right View

Annex B.ii. Photograph: EUT Internal Photo

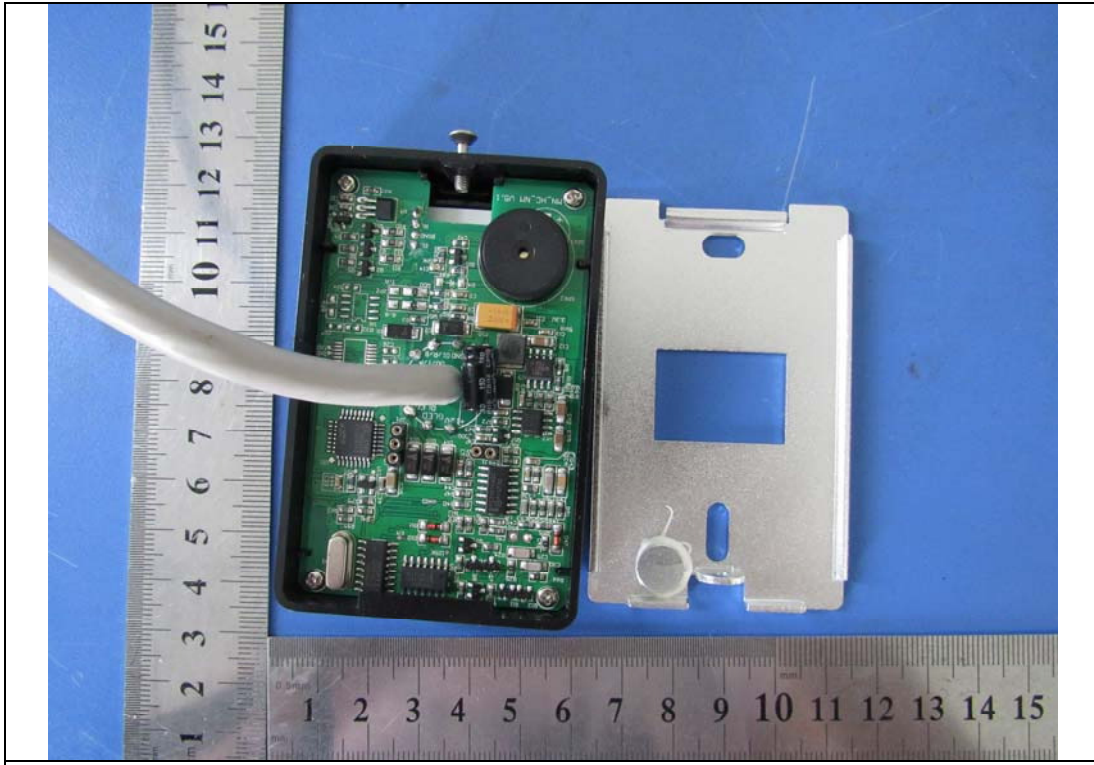

EUT – Uncover Front View



EUT – Uncover Rear View

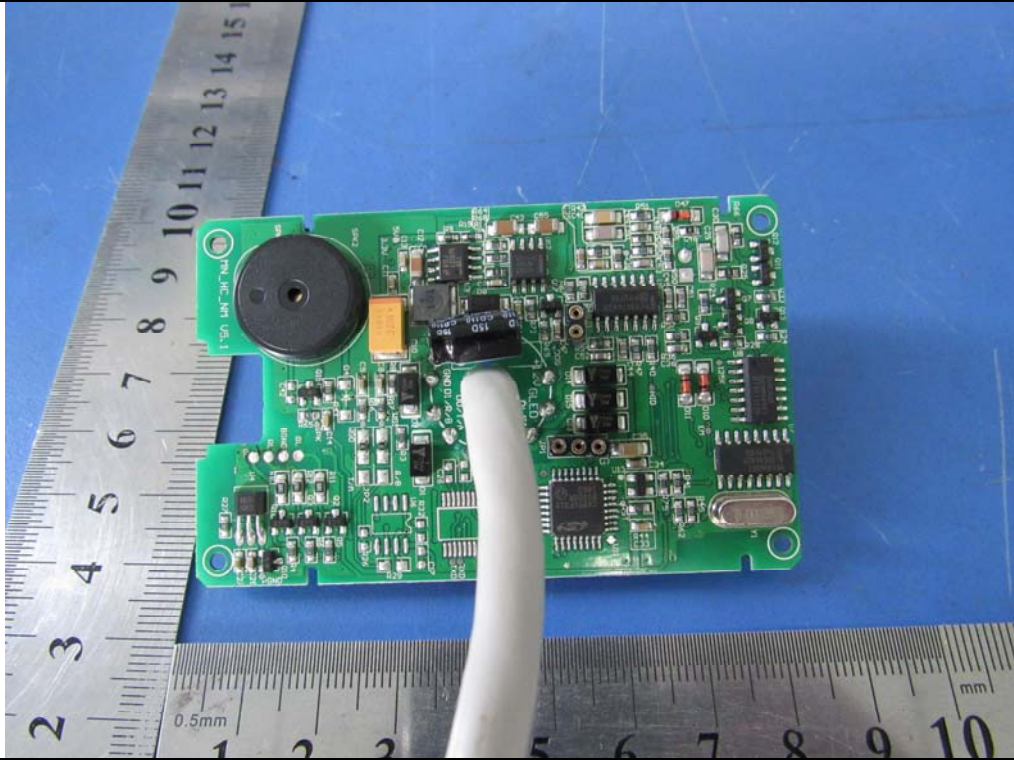

EUT – PCBA Front View

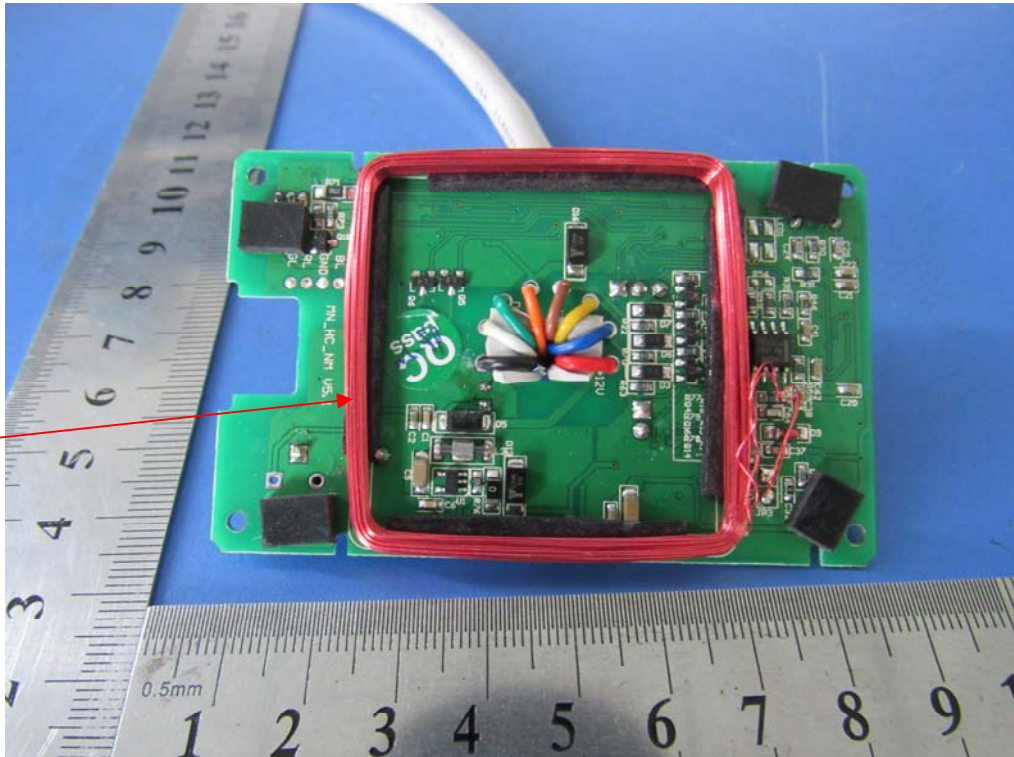

Antenna

EUT – PCBA Rear View

Annex B.iii. Photograph Test Setup Photo



Conducted Emissions Setup Front View



Conducted Emissions Setup Side View

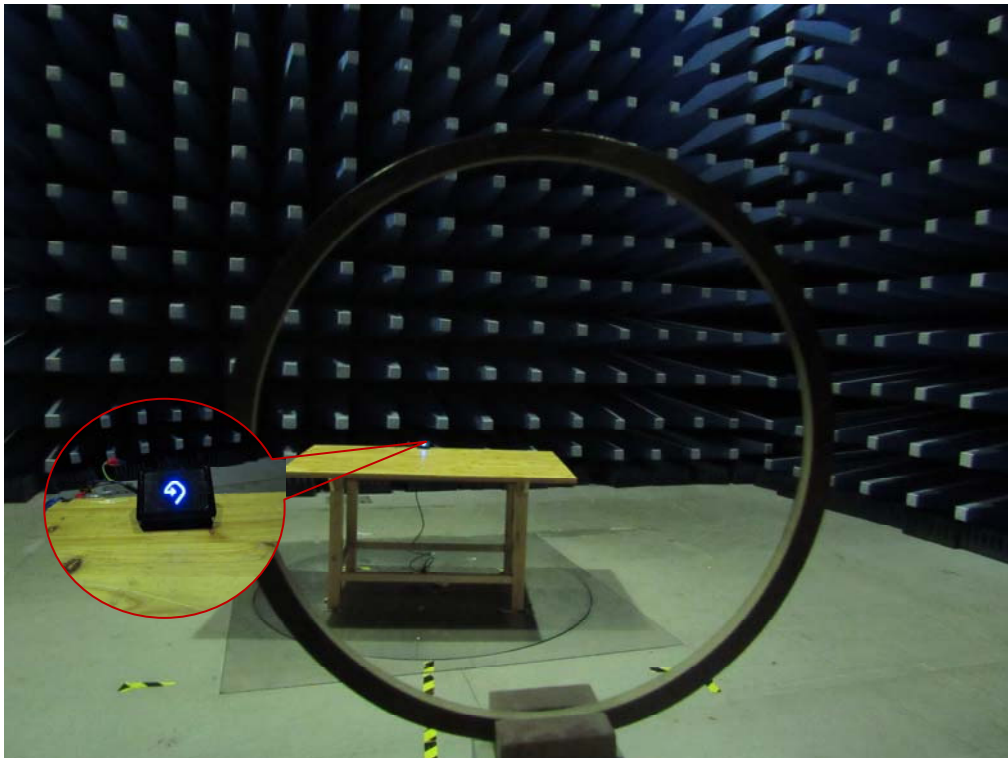

Front View of Radiated Emissions Test Setup below 30MHz

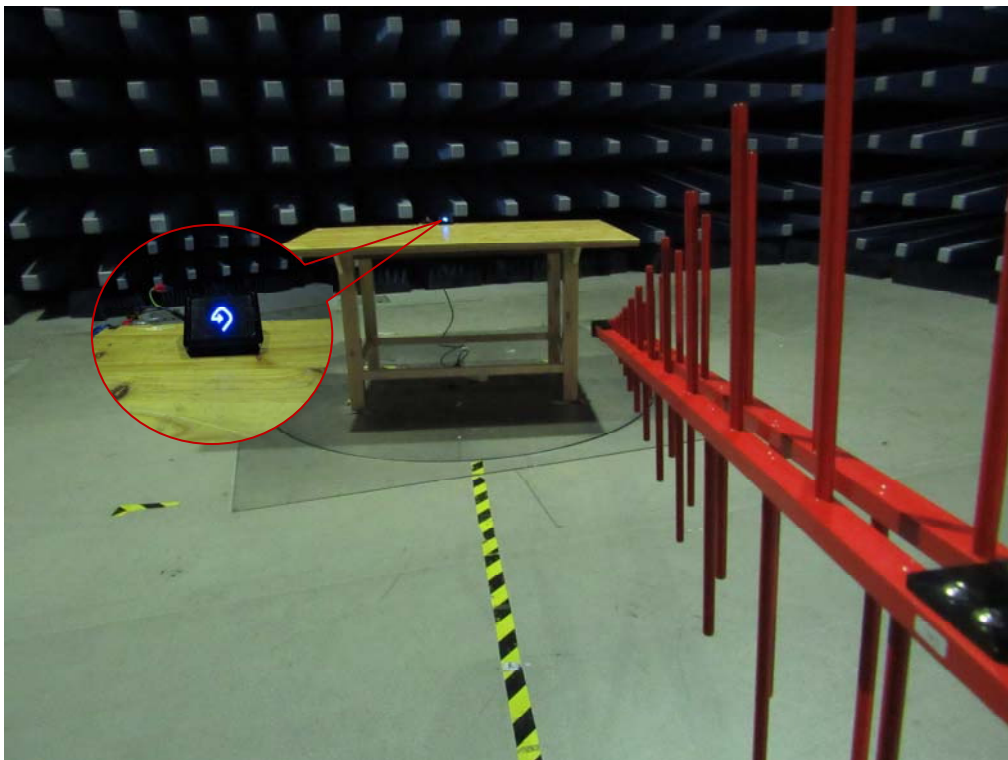

Radiated Emissions Setup Below 1GHz Front View

Annex C. TEST SETUP AND SUPPORTING EQUIPMENT

Annex C.i. TEST SET UP BLOCK

Block Configuration Diagram for Conducted Emissions

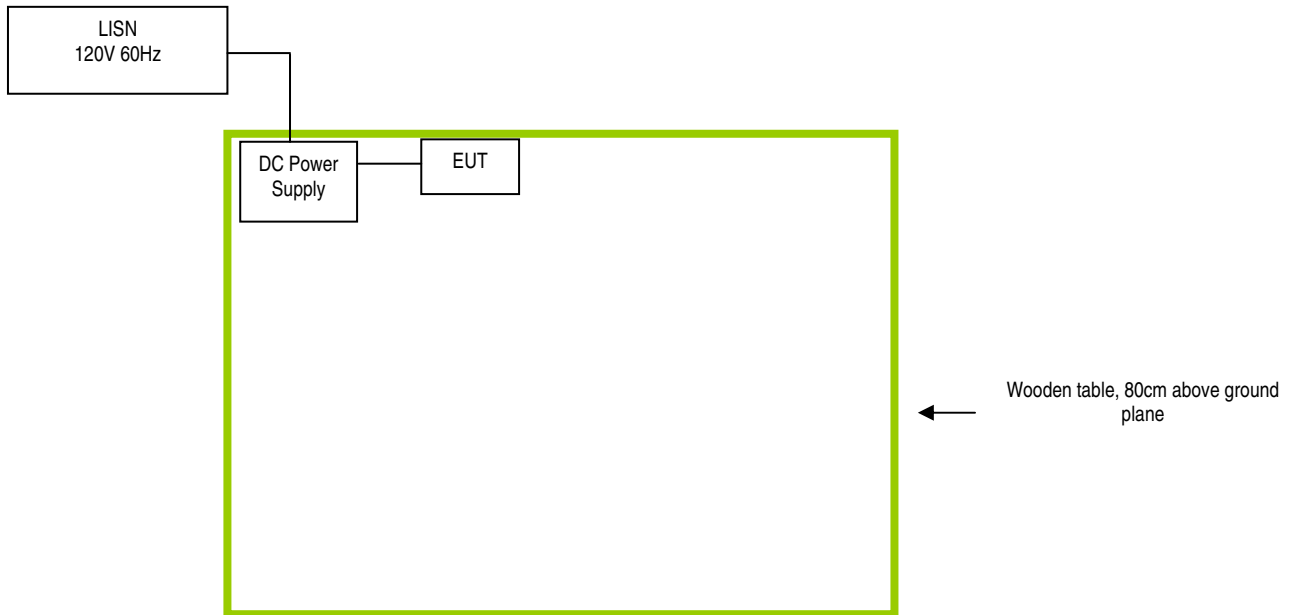

Block Configuration Diagram for Radiated Emissions

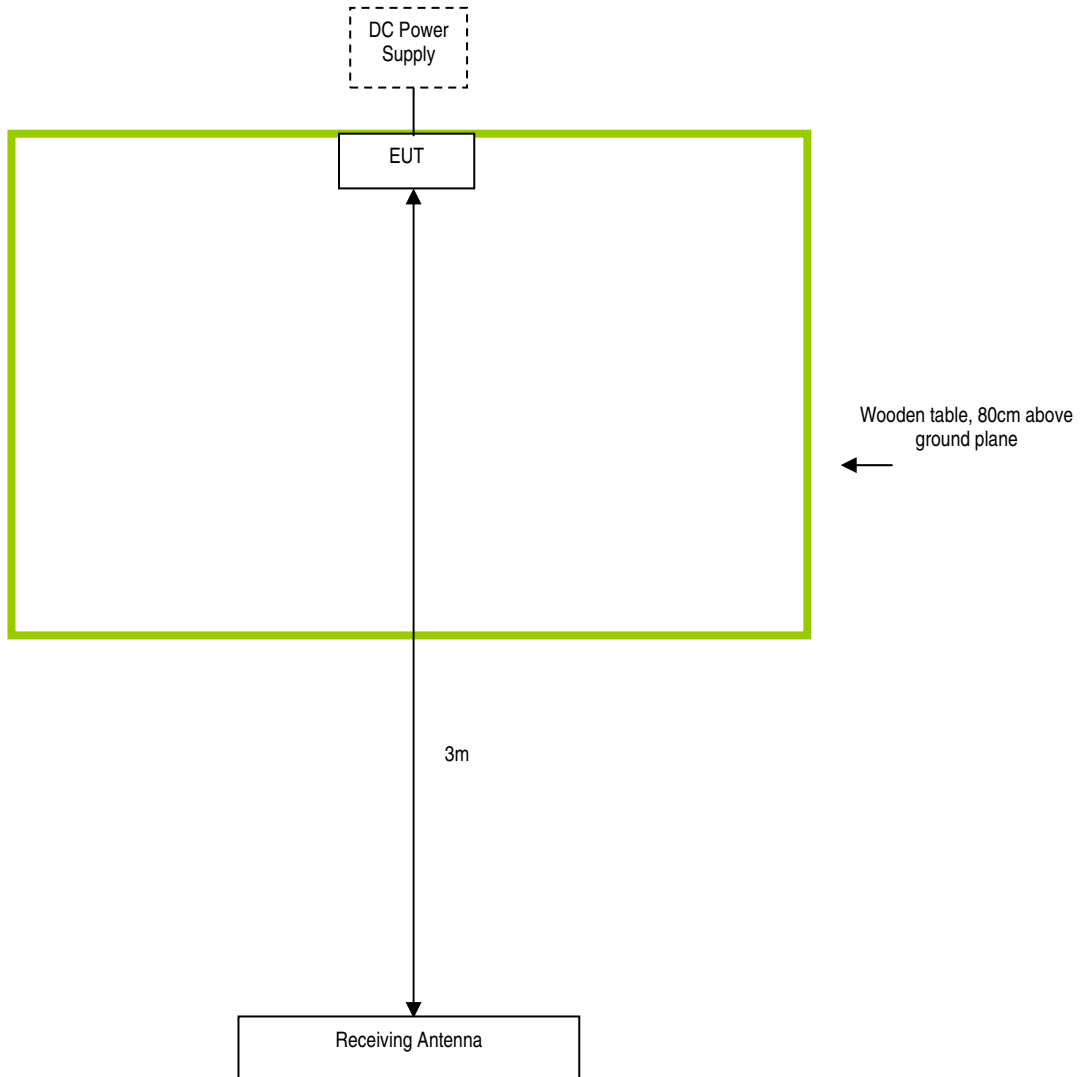

Test Report No.	16020760-FCC-E
Page	26 of 28

Annex C. ii. SUPPORTING EQUIPMENT DESCRIPTION

The following is a description of supporting equipment and details of cables used with the EUT.

Manufacturer	Equipment Description	Model	Cal Date	Cal Due Date
BK PRECISION	DC Power Supply	1786B	N/A	N/A

Test Report No.	16020760-FCC-E
Page	27 of 28

Annex D. User Manual / Block Diagram / Schematics / Partlist

Please see Attachment

Test Report No.	16020760-FCC-E
Page	28 of 28

Annex E. DECLARATION OF SIMILARITY

SMARFID

Shanghai Smarfid Security Equipment Co., Ltd.
Add: Room 301, 4th Bldg., No.4 TongLi Road, SongJiang District, Shanghai 201615,
China
Tel: (86-21) 54260103, 54260132 ext.215 Fax: (86-21) 54260132 ext.222

To: SIEMIC INC

Declaration letter

Dear :

For our business issue and marketing requirement, we would like to list different models numbers on the FCC certificate and reports, as following:

Model No: HR382-8N、EM382-8N

The two models have the same Circuits, components and color.

The difference of these models are have different model name, but others differences as follows:

The difference between HR382-8N and EM382-8N is

The card they can read is different, which "HR" means 125 kHz and "EM" means EM Technology.

Thank you!

Signature:

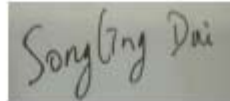

Printed name/title: Songling Dai