

Shanghai Smarfid Security Equipment Co.,Ltd

Smarfid -232 Leigc Reader

Main Model: MI392-8N

Serial Model: N/A

December 11, 2013

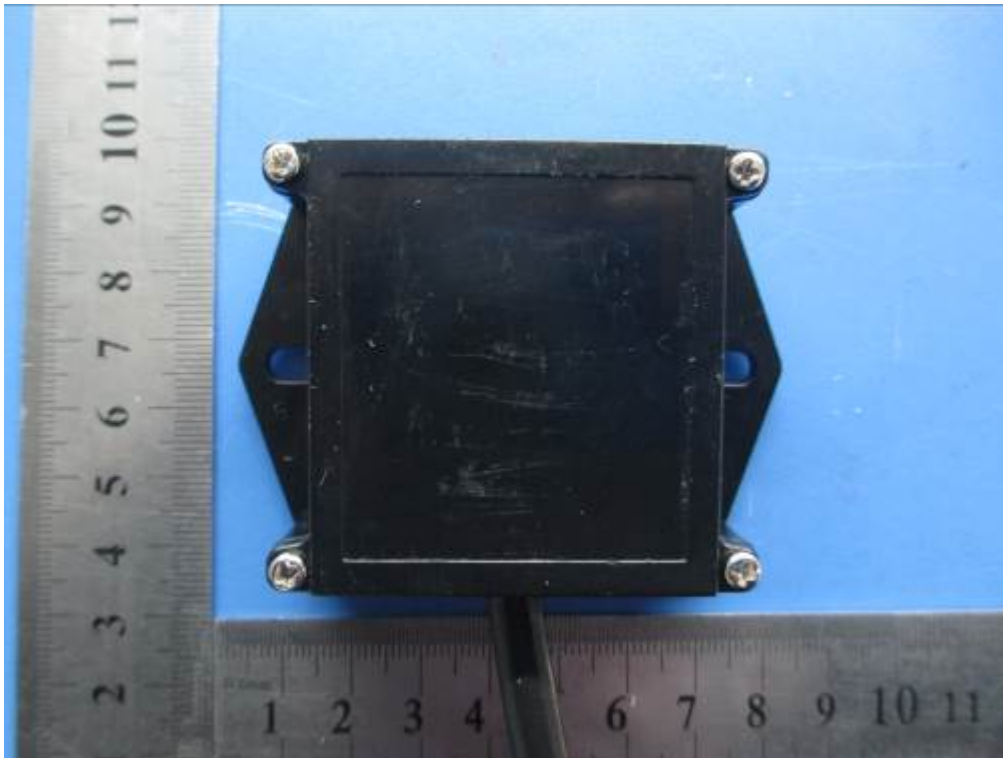

Report No.: 13020915-FCC-R1

(This report supersedes NONE)

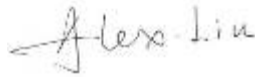

Modifications made to the product : None

This Test Report is Issued Under the Authority of:

		
William Long Compliance Engineer	Alex Liu Technical Manager	

This test report may be reproduced in full only.
Test result presented in this test report is applicable to the representative sample only.

RF Test Report

TO: FCC Part 15.225: 2013, ANSI C63.4: 2009

SIEMIC, INC.
Accessing global markets

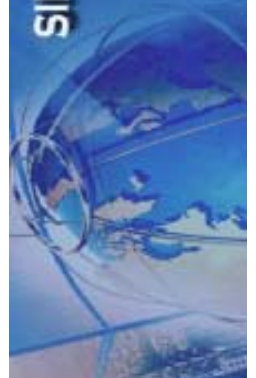

Laboratory Introduction

SIEMIC, headquartered in the heart of Silicon Valley, with superior facilities in US and Asia, is one of the leading independent testing and certification facilities providing customers with one-stop shop services for Compliance Testing and Global Certifications.



In addition to [testing](#) and [certification](#), SIEMIC provides initial design reviews and [compliance management](#) through out a project. Our extensive experience with [China](#), [Asia Pacific](#), [North America](#), [European](#), and [international](#) compliance requirements, assures the fastest, most cost effective way to attain regulatory compliance for the [global markets](#).

Accreditations for Conformity Assessment

Country/Region	Scope
USA	EMC , RF/Wireless , Telecom
Canada	EMC, RF/Wireless , Telecom
Taiwan	EMC, RF, Telecom , Safety
Hong Kong	RF/Wireless ,Telecom
Australia	EMC, RF, Telecom , Safety
Korea	EMI, EMS, RF , Telecom, Safety
Japan	EMI, RF/Wireless, Telecom
Singapore	EMC , RF , Telecom
Europe	EMC, RF, Telecom , Safety



SIEMIC, Inc.

Accessing global markets

Title: RF Test Report for Smarfid -232 Leige Reader
Main Model: MI392-8N
Serial Model: N/A
To: FCC Part 15.225; 2013 ANSI C63.4; 2009

Report No.: 13020915-FCC-R1
Issue Date: December 11, 2013
Page: 3 of 37
www.siemac.com

This page has been left blank intentionally.

CONTENTS

1	EXECUTIVE SUMMARY & EUT INFORMATION	5
2	TECHNICAL DETAILS	6
3	MODIFICATION.....	7
4	TEST SUMMARY.....	8
5	MEASUREMENTS, EXAMINATION AND DERIVED RESULTS	9
	ANNEX A. TEST INSTRUMENT & METHOD	20
	ANNEX B. EUT AND TEST SETUP PHOTOGRAPHS	24
	ANNEX C. TEST SETUP AND SUPPORTING EQUIPMENT.....	32
	ANNEX D. USER MANUAL / BLOCK DIAGRAM / SCHEMATICS / PART LIST	36
	ANNEX E. DECLARATION OF SIMILARITY	37

1 EXECUTIVE SUMMARY & EUT INFORMATION

The purpose of this test programme was to demonstrate compliance of the Shanghai Smarfid Security Equipment Co.,Ltd, Smarfid -232 Leige Reader, and model: MI392-8N against the current Stipulated Standards. The Smarfid -232 Leige Reader has demonstrated compliance with the FCC Part 15.225: 2013 ANSI C63.4: 2009.

EUT Information

EUT Description	Smarfid -232 Leige Reader
Main Model	MI392-8N
Serial Model	N/A
Antenna Gain	6 dBi
Input Power	DC 12V
Classification Per Stipulated Test Standard	FCC Part 15.225: 2013 ANSI C63.4: 2009

2 TECHNICAL DETAILS

Purpose	Compliance testing of Smarfid -232 Leige Reader with stipulated standard
Applicant / Client	Shanghai Smarfid Security Equipment Co.,Ltd Room 301,4th Bldg., No.4 TongLi Road, SongJiang District,Shanghai 201615,China
Manufacturer	Shanghai Smarfid Security Equipment Co.,Ltd Room 301,4th Bldg., No.4 TongLi Road, SongJiang District,Shanghai 201615,China
Laboratory performing the tests	SIEMIC (Nanjing-China) Laboratories NO.2-1,Longcang Dadao, Yuhua Economic Development Zone, Nanjing, China Tel:+86(25)86730128/86730129 Fax:+86(25)86730127 Email: China@siemic.com.cn
Test report reference number	13020915-FCC-R1
Date EUT received	October 22, 2013
Standard applied	FCC Part 15.225: 2013 ANSI C63.4: 2009
Dates of test (from – to)	December 09 to December 10, 2013
No of Units :	#1
Equipment Category :	DXX
Trade Name :	VITTO
Model :	MI392-8N
RF Operating Frequency (ies) :	13.56MHz
Number of Channels :	1CH
Modulation :	ASK
FCC ID :	X3A-232LEGIC



SIEMIC, Inc.

Accessing global markets

Title: RF Test Report for Smarfid -232 Leige Reader
Main Model: MI392-8N
Serial Model: N/A
To: FCC Part 15.225; 2013 ANSI C63.4; 2009

Report No.:
Issue Date:
Page:

13020915-FCC-R1
December 11, 2013
7 of 37
www.siemac.com

3 MODIFICATION

NONE

4 TEST SUMMARY

The product was tested in accordance with the following specifications.
All testing has been performed according to below product classification:

Test Results Summary

Test Standard	Description	Pass/Fail
FCC Part 15.225:2013		
15.203	Antenna Requirement	Pass
15.207(a)	Conducted Emissions Voltage	Pass
15.225(a)	Fundamental Field Strength	Pass
15.225(b)	Fundamental Field Strength	Pass
15.225(c)	Fundamental Field Strength	Pass
15.225(d),15.209	Radiated Emissions	Pass
15.225(e)	Frequency Stability	Pass
15.215(c)	Occupied Bandwidth	Pass
ANSI C63.4: 2009		
PS: All measurement uncertainties are not taken into consideration for all presented test result.		

5 MEASUREMENTS, EXAMINATION AND DERIVED RESULTS

5.1 Antenna Requirement

Requirement(s): 47 CFR §15.203

An intentional radiator shall be designed to ensure that no antenna other than that furnished by the responsible party shall be used with the device.

Antenna requirement must meet at least one of the following:

- a) Antenna must be permanently attached to the device.
- b) Antenna must use a unique type of connector to attach to the device.
- c) Device must be professionally installed. Installer shall be responsible for ensuring that the correct antenna is employed with the device.

The antenna is permanently attached to the device.

5.2 Conducted Emissions Voltage

Requirement:

Frequency of emission (MHz)	Conducted limit (dB μ V)	
	Quasi-peak	Average
0.15–0.5	66 to 56*	56 to 46*
0.5–5	56	46
5–30	60	50

*Decreases with the logarithm of the frequency.

Procedures:

1. All possible modes of operation were investigated. Only the 6 worst case emissions measured, using the correct CISPR and Average detectors, are reported. All other emissions were relatively insignificant.
2. A "-ve" margin indicates a PASS as it refers to the margin present below the limit line at the particular frequency.
3. Conducted Emissions Measurement Uncertainty
 All test measurements carried out are traceable to national standards. The uncertainty of the measurement at a confidence level of approximately 95% (in the case where distributions are normal), with a coverage factor of 2, in the range 9kHz – 30MHz (Average & Quasi-peak) is ± 3.5 dB.
4. Environmental Conditions

Temperature	20°C
Relative Humidity	50%
Atmospheric Pressure	1019mbar
5. Test date : December 09, 2013
 Tested By : William Long

Test Mode:	Transmitting
-------------------	---------------------

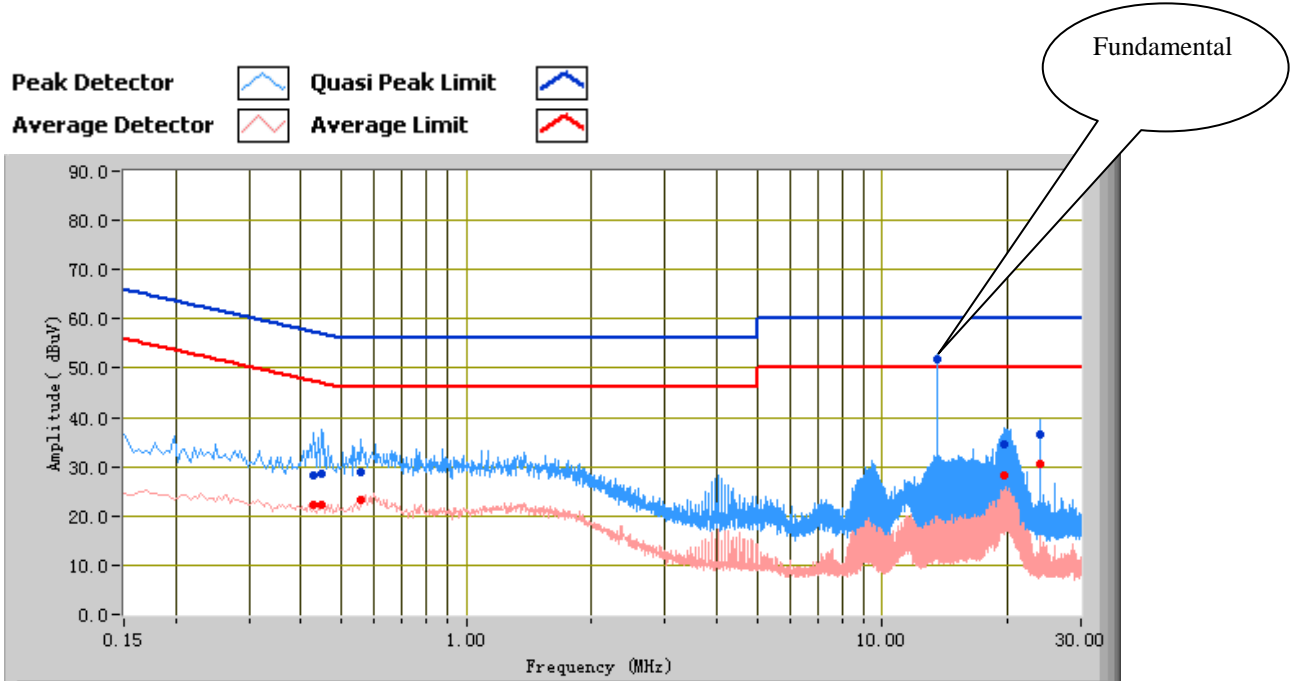

Test Data

Phase Line Plot at 120V AC, 60Hz

Frequency (MHz)	Quasi Peak (dBµV)	Limit (dBµV)	Margin (dB)	Average (dBµV)	Limit (dBµV)	Margin (dB)	Factors (dB)
13.56	51.70	60.00	-8.30	51.94	50.00	1.94	11.33
0.45	28.45	56.95	-28.50	22.23	46.95	-24.72	11.14
0.43	28.14	57.25	-29.11	22.13	47.25	-25.12	11.17
24.01	36.66	60.00	-23.34	30.40	50.00	-19.60	11.70
0.55	28.94	56.00	-27.06	23.40	46.00	-22.60	11.02
19.53	34.67	60.00	-25.33	28.13	50.00	-21.87	11.56

Antenna port connected to artificial terminal.

Test Mode:	Transmitting
-------------------	---------------------

Peak Detector  **Quasi Peak Limit** 
Average Detector  **Average Limit** 

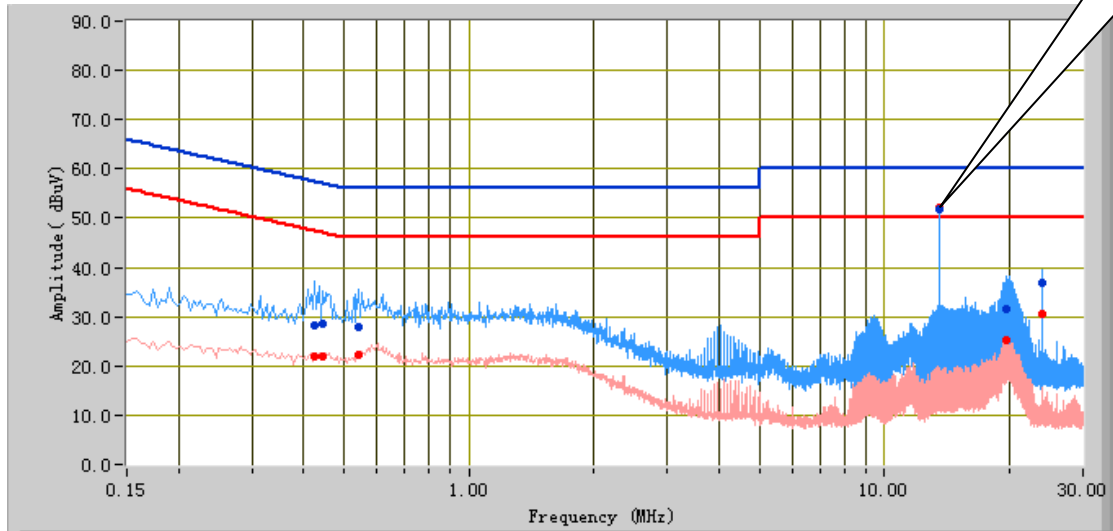

Test Data

Phase Neutral Plot at 120V AC, 60Hz

Frequency (MHz)	Quasi Peak (dBµV)	Limit (dBµV)	Margin (dB)	Average (dBµV)	Limit (dBµV)	Margin (dB)	Factors (dB)
13.56	51.74	60.00	-8.26	51.98	50.00	1.98	11.33
0.43	28.08	57.33	-29.25	22.08	47.33	-25.25	11.18
24.01	36.72	60.00	-23.28	30.45	50.00	-19.55	11.70
0.54	27.92	56.00	-28.08	22.27	46.00	-23.73	11.03
19.60	31.56	60.00	-28.44	25.14	50.00	-24.86	11.56
0.44	28.65	57.02	-28.37	22.04	47.02	-24.98	11.15

Antenna port connected to artificial terminal.

5.3 Fundamental Field Strength Test Result

1. All possible modes of operation were investigated. Only the 6 worst case emissions measured, using the correct CISPR detectors are reported. All other emissions were relatively insignificant.
2. A “-ve” margin indicates a PASS as it refers to the margin present below the limit line at the particular frequency.
3. **Radiated Emissions Measurement Uncertainty**
All test measurements carried out are traceable to national standards. The uncertainty of the measurement at a confidence level of approximately 95% (in the case where distributions are normal), with a coverage factor of 2, is +/-6dB.
4.

Environmental Conditions	Temperature	20°C
	Relative Humidity	50%
	Atmospheric Pressure	1019mbar
5. Test date : December 09, 2013
Tested By : William Long

Test Requirement:

- (a) The field strength of any emissions within the band 13.553–13.567 MHz shall not exceed 15,848 microvolts/meter at 30 meters.
- (b) Within the bands 13.410–13.553 MHz and 13.567–13.710 MHz, the field strength of any emissions shall not exceed 334 microvolts/meter at 30 meters.
- (c) Within the bands 13.110–13.410 MHz and 13.710–14.010 MHz the field strength of any emissions shall not exceed 106 microvolts/meter at 30 meters.

15.225(a), 15.225(b) and 15.225(c) Test Result:

Loop Antenna Positioned at 0 degree @3m

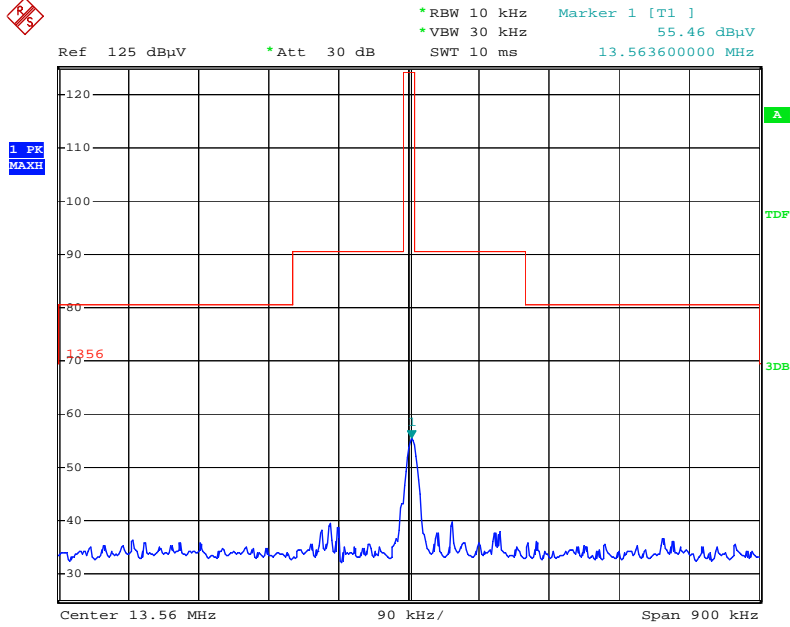

Date: 9.DEC.2013 09:27:58

Loop Antenna Positioned at 90 degree @3m

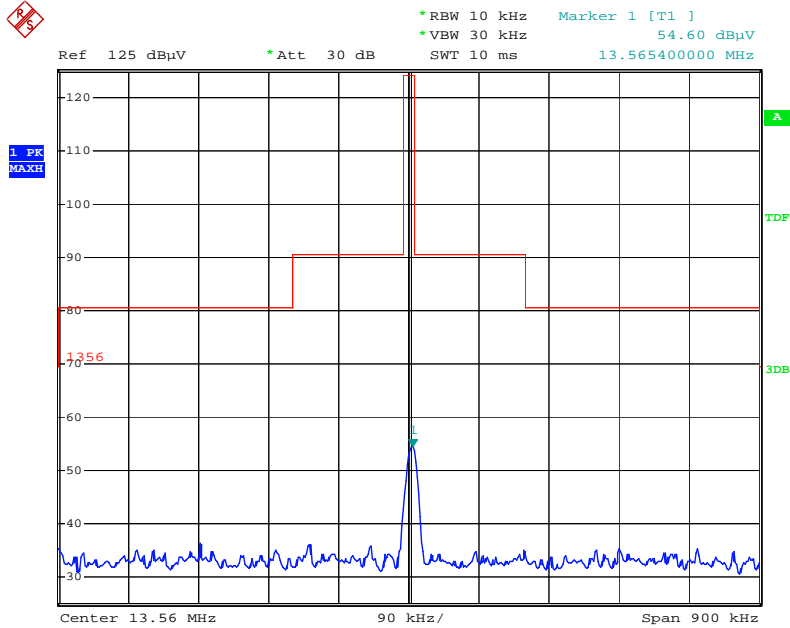

Date: 9.DEC.2013 09:29:00

5.4 Radiated Emissions

Requirement(s): 47 CFR §15.209; 47 CFR§15.225(d)

Procedures: For >30MHz, Radiated emissions were measured according to ANSIC63.4. The EUT was set to transmit at the highest output power. The EUT was set 3 meter away from the measuring antenna. The Log periodic antenna was positioned 1 meter above the ground from the centre of the antenna. The measuring bandwidth was set to 120kHz. (Note: During testing the receive antenna was raise from 1-4meters to maximize the emission from the EUT.)

The limit is converted from microvolt/meter to decibel microvolt/meter.

Sample Calculation: Corrected Amplitude=Raw Amplitude (dBuV/m)+ACF(dB)+Cable Loss(dB)-Distance Correction Factor

1. All possible modes of operation were investigated. Only the 6 worst case emissions measured, using the correct CISPR detectors are reported. All other emissions were relatively insignificant.
2. A “-ve” margin indicates a PASS as it refers to the margin present below the limit line at the particular frequency.
3. Radiated Emissions Measurement Uncertainty
All test measurements carried out are traceable to national standards. The uncertainty of the measurement at a confidence level of approximately 95% (in the case where distributions are normal), with a coverage factor of 2, is +/-6dB.
4. Environmental Conditions

Temperature	20°C
Relative Humidity	50%
Atmospheric Pressure	1019mbar
5. Test date : December 10, 2013
Tested By : William Long

The result: Pass

Transmit mode:

Vertical (0 degrees) & Horizontal(90 degrees) Polarity Plot at 3m

Frequency (MHz)	Quasi Peak (dBμV/m)	Azimuth	Polarity (H/V)	Height (cm)	Factors (dB)	Limit (dBμV/m)	Margin (dB)
356.8	49.25	263	V	154	-31.1	69.54	-20.29
989.99	45.88	15	H	202	-21.77	69.54	-23.66
485.25	50.13	28	H	302	-28.06	69.54	-19.41
568.8	53.6	45	V	155	-26.64	69.54	-15.94
253.4	48.05	262	V	130	-34.2	69.54	-21.49
428.69	47.33	351	H	201	-29.37	69.54	-22.21

Note: Emissions from 9kHz to 1MHz is very low under transmit mode so test data is not presented in this report

Test Mode:	Transmitting
-------------------	---------------------

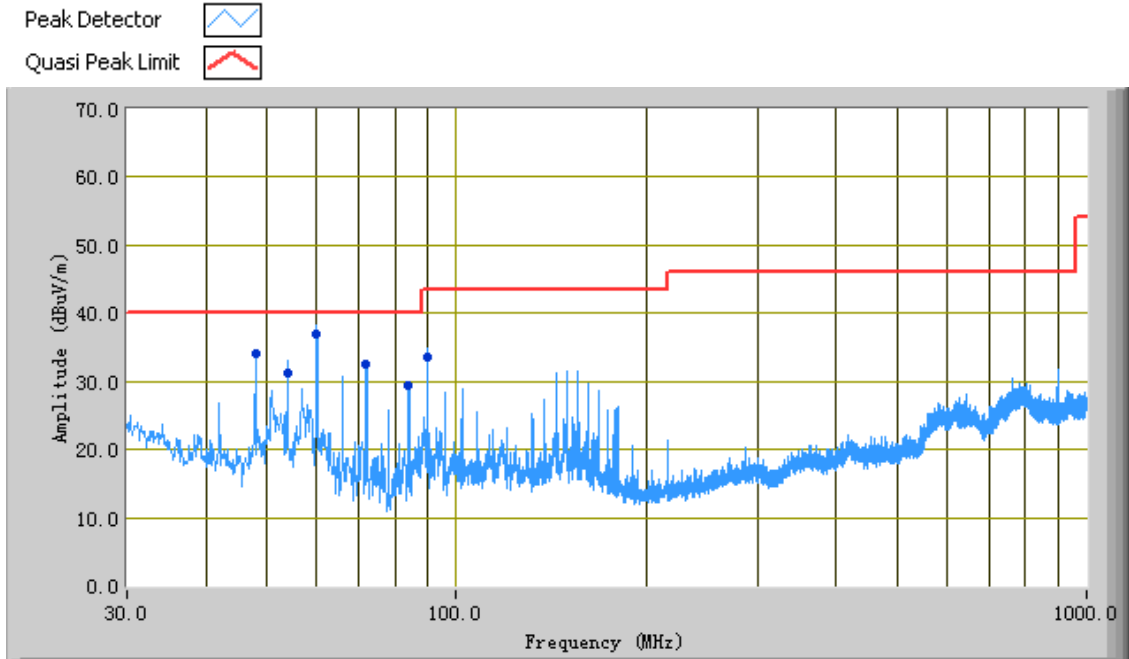

Test Data

Vertical & Horizontal Polarity Plot at 3m

Frequency (MHz)	Quasi Peak (dBµV/m)	Azimuth	Polarity (H/V)	Height (cm)	Factors (dB)	Limit (dBµV/m)	Margin (dB)
60.03	36.95	87.00	V	125.00	-38.81	40.00	-3.05
48.02	34.12	166.00	V	111.00	-31.85	40.00	-5.88
54.03	31.22	115.00	V	110.00	-35.28	40.00	-8.78
90.04	33.54	166.00	H	200.00	-38.09	43.50	-9.96
72.03	32.55	151.00	H	389.00	-37.85	40.00	-7.45
84.02	29.37	177.00	H	260.00	-37.96	40.00	-10.63

Note: Testing measured to beyond the tenth harmonic of the highest fundamental frequency and comply with FCC rule.

5.5 Frequency Stability

Requirement(s): 47 CFR §15.225(e)

Procedures: Frequency Stability was measured according to 47 CFR§2.1055. Measurement was taken with spectrum analyzer. The spectrum analyzer bandwidth and span was set to read in hertz. A voltmeter was used to monitor when varying the voltage.

Limit: $\pm 0.01\%$ of 13.56MHz=1356Hz

- | | | | |
|----|-------------------------------|----------------------|----------|
| 1. | Environmental Conditions | Temperature | 20°C |
| | | Relative Humidity | 50% |
| | | Atmospheric Pressure | 1019mbar |
| 2. | Test date : December 09, 2013 | | |
| | Tested By : William Long | | |

The result: Pass

Frequency Stability versus Temperature: The Frequency tolerance of the carrier signal shall be maintained within $\pm 0.01\%$ of the operating frequency over a temperature variation of -10°C to +50°C at normal supply voltage.

Reference Frequency: 13.56MHz at -20°C to +50°C DC 12V

Temperature (°C)	Measured Freq. (MHz)	Freq. Drift (Hz)	Freq. Deviation (Limit: 0.01%)	Pass/Fail
50	13.5607	700	<0.01	Pass
40	13.5607	700	<0.01	Pass
30	13.5605	500	<0.01	Pass
20	Reference			
10	13.5607	700	<0.01	Pass
0	13.5606	600	<0.01	Pass
-10	13.5607	700	<0.01	Pass

Frequency Stability versus Input Voltage: The frequency tolerance of the carrier signal shall be maintained within $\pm 0.01\%$, the frequency of the transmitter was measured at 85% and at 115% of the rated power supply voltage at 20°C environmental temperature.

Carrier Frequency: 13.56MHz at 20°C at DC 12V

Measured Voltage $\pm 15\%$ of nominal(DC)	Measured Freq. (MHz)	Freq. Drift (Hz)	Freq. Deviation (Limit: 0.01%)	Pass/Fail
10.2	13.5606	600	<0.01	Pass
13.8	13.5607	700	<0.01	Pass

5.6 Occupied Bandwidth

Requirement(s): 47 CFR§15.215(e)

Procedures: Occupied Bandwidth was measured according to 47 CFR§2.1049. Measurement was taken with spectrum analyzer. The spectrum analyzer bandwidth and span was set to read in hertz.

1. All possible modes of operation were investigated. Only the 6 worst case emissions measured, using the correct CISPR detectors are reported. All other emissions were relatively insignificant.
2. A “-ve” margin indicates a PASS as it refers to the margin present below the limit line at the particular frequency.
3. Radiated Emissions Measurement Uncertainty
 All test measurements carried out are traceable to national standards. The uncertainty of the measurement at a confidence level of approximately 95% (in the case where distributions are normal), with a coverage factor of 2, is +/-6dB.
4. Environmental Conditions

Temperature	20°C
Relative Humidity	50%
Atmospheric Pressure	1019mbar
5. Test date :December 09, 2013
 Tested By : William Long

Test Result: Pass

Frequency (MHz)	20dB BW (kHz)
13.56	1.88

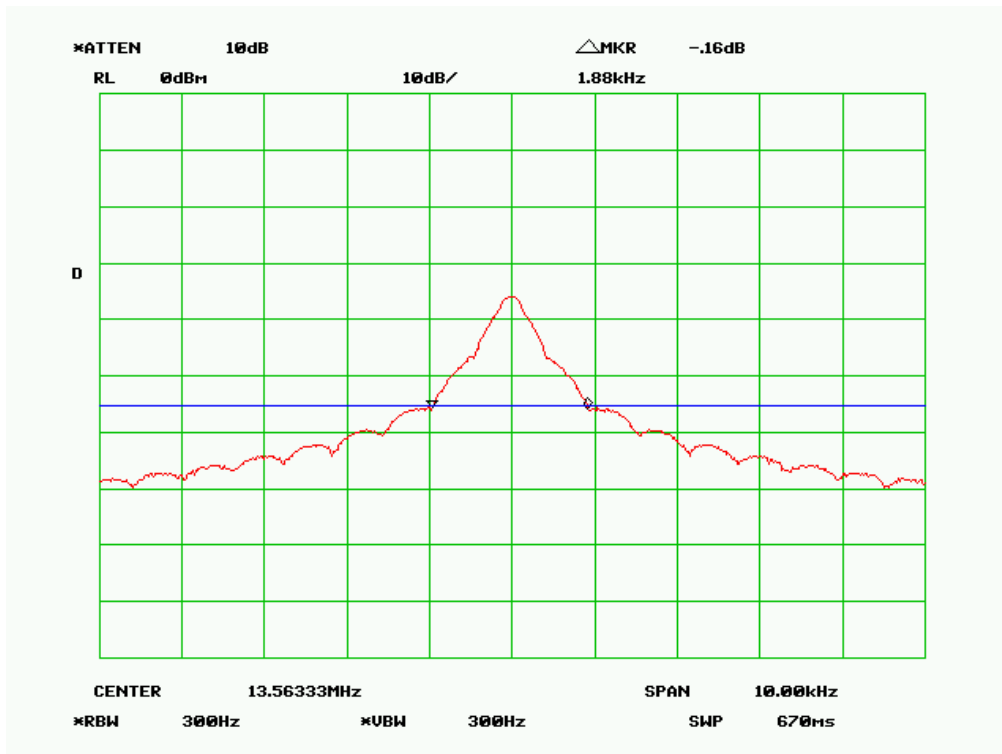

Annex A. TEST INSTRUMENT & METHOD

Annex A.i. TEST INSTRUMENTATION & GENERAL PROCEDURES

Instrument	Model	Serial #	Calibration Date	Calibration Due Date
AC Line Conducted Emissions				
R&S EMI Test Receiver	ESPI3	101216	09/27/2013	09/26/2014
ROHDE&SCHWARZ V-LISN	ESH3-Z5	838979/005	09/27/2013	09/26/2014
Com-Power Transient Limiter	LIT-153	531021	09/27/2013	09/26/2014
SIEMIC Labview Conducted Emissions software	V1.0	N/A	N/A	N/A
Radiated Emissions				
R&S EMI Receiver	ESPI3	101216	09/27/2013	09/26/2014
Antenna (30MHz~6GHz)	JB6	A121411	06/27/2013	03/26/2014
Hp Agilent Pre-Amplifier	8447F	1937A01160	10/27/2013	10/26/2014
EMCO Passive Loop Antenna	6509	9909-1469	10/18/2013	10/17/2014
Pro.Temp.&Humi.Chamber	MHP-150-1C	MHA090510A	11/03/2013	11/02/2014
SIEMIC Labview Radiated Emissions software	V1.0	N/A	N/A	N/A

Annex A.ii. CONDUCTED EMISSIONS TEST DESCRIPTION

Test Set-up

1. The EUT and supporting equipment were set up in accordance with the requirements of the standard on top of a 1.5m x 1m x 0.8m high, non-metallic table, as shown in Annex B.
2. The power supply for the EUT was fed through a 50Ω/50μH EUT LISN, connected to filtered mains.
3. The RF OUT of the EUT LISN was connected to the EMI test receiver via a low-loss coaxial cable.
4. All other supporting equipments were powered separately from another main supply.

Test Method

1. The EUT was switched on and allowed to warm up to its normal operating condition.
2. A scan was made on the NEUTRAL line (for AC mains) or Earth line (for DC power) over the required frequency range using an EMI test receiver.
3. High peaks, relative to the limit line, were then selected.
4. The EMI test receiver was then tuned to the selected frequencies and the necessary measurements made with a receiver bandwidth setting of 10 KHz. For FCC tests, only Quasi-peak measurements were made; while for CISPR/EN tests, both Quasi-peak and Average measurements were made.
5. Steps 2 to 4 were then repeated for the LIVE line (for AC mains) or DC line (for DC power).

Sample Calculation Example

At 20 MHz limit = 250 μV = 47.96 dBμV

Transducer factor of LISN, pulse limiter & cable loss at 20 MHz = 11.20 dB

Q-P reading obtained directly from EMI Receiver = 40.00 dBμV
(Calibrated for system losses)

Therefore, Q-P margin = 47.96 – 40.00 = 7.96 i.e. **7.96 dB below limit**

Annex A. iii. RADIATED EMISSIONS TEST DESCRIPTION

EUT Characterisation

EUT characterisation, over the frequency range from 30MHz to 10th Harmonic , was done in order to minimise radiated emissions testing time while still maintaining high confidence in the test results.

The EUT was placed in the chamber, at a height of about 0.8m on a turntable. Its radiated emissions frequency profile was observed, using a spectrum analyzer /receiver with the appropriate broadband antenna placed 3m away from the EUT. Radiated emissions from the EUT were maximised by rotating the turntable manually, changing the antenna polarisation and manipulating the EUT cables while observing the frequency profile on the spectrum analyzer / receiver. Frequency points at which maximum emissions occurred, clock frequencies and operating frequencies were then noted for the formal radiated emissions test at the Open Area Test Site (OATS).

Test Set-up

1. The EUT and supporting equipment were set up in accordance with the requirements of the standard on top of a 1.5m X 1.0m X 0.8m high, non-metallic table.
2. The filtered power supply for the EUT and supporting equipment were tapped from the appropriate power sockets located on the turntable.
3. The relevant broadband antenna was set at the required test distance away from the EUT and supporting equipment boundary.

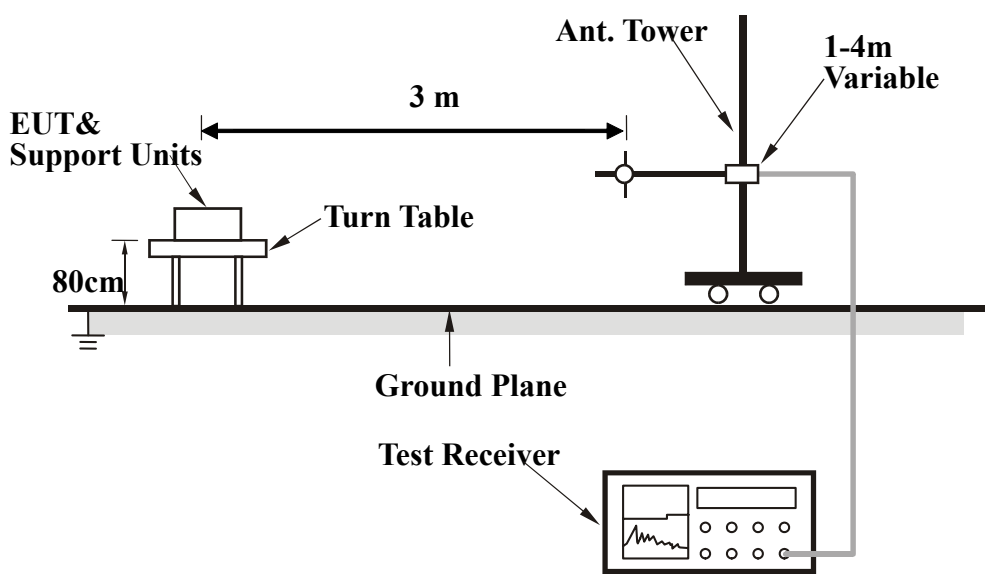

Test Method

The following procedure was performed to determine the maximum emission axis of EUT:

1. With the receiving antenna is H polarization, rotate the EUT in turns with three orthogonal axes to determine the axis of maximum emission.
2. With the receiving antenna is V polarization, rotate the EUT in turns with three orthogonal axes to determine the axis of maximum emission.
3. Compare the results derived from above two steps. So, the axis of maximum emission from EUT was determined and the configuration was used to perform the final measurement.

Final Radiated Emission Measurement

1. Setup the configuration according to figure 1. Turn on EUT and make sure that it is in normal function.
2. For emission frequencies measured below 1 GHz, a pre-scan is performed in a shielded chamber to determine the accurate frequencies of higher emissions will be checked on a open test site. As the same purpose, for emission frequencies measured above 1 GHz, a pre-scan also be performed with a 1 meter measuring distance before final test.
3. For emission frequencies measured below and above 1 GHz, set the spectrum analyzer on a 100 kHz and 1 MHz resolution bandwidth respectively for each frequency measured in step 2.
4. The search antenna is to be raised and lowered over a range from 1 to 4 meters in horizontally polarized orientation. Position the highness when the highest value is indicated on spectrum analyzer, then change the orientation of EUT on test table over a range from 0 ° to 360 ° with a speed as slow as possible, and keep the azimuth that highest emission is indicated on the spectrum analyzer. Vary the antenna position again and record the highest value as a final reading.
5. Repeat step 4 until all frequencies need to be measured were complete.
6. Repeat step 5 with search antenna in vertical polarized orientations.

During the radiated emission test, the Spectrum Analyzer was set with the following configurations:

Frequency Band (MHz)	Function	Resolution bandwidth	Video Bandwidth
30 to 1000	Peak	100 kHz	100 kHz
Above 1000	Peak	1 MHz	1 MHz
	Average	1 MHz	10 Hz

Sample Calculation Example

The field strength is calculated by adding the Antenna Factor and Cable Factor, and subtracting the Amplifier Gain (if any) from the measured reading. For the limit is employed average value, therefore the peak value can be transferred to average value by subtracting the duty factor. The basic equation with a sample calculation is as follows:

$$\text{Peak} = \text{Reading} + \text{Corrected Factor}$$

where

$$\text{Corr. Factor} = \text{Antenna Factor} + \text{Cable Factor} - \text{Amplifier Gain (if any)}$$

And the average value is

$$\text{Average} = \text{Peak Value} + \text{Duty Factor or}$$

$$\text{Set RBW} = 1\text{MHz, VBW} = 10\text{Hz.}$$

Note:

If the measured frequencies are fall in the restricted frequency band, the limit employed must be quasi peak value when frequencies are below or equal to 1 GHz. And the measuring instrument is set to quasi peak detector function.

Annex B. EUT AND TEST SETUP PHOTOGRAPHS

Annex B.i. Photograph 1: EUT External Photo

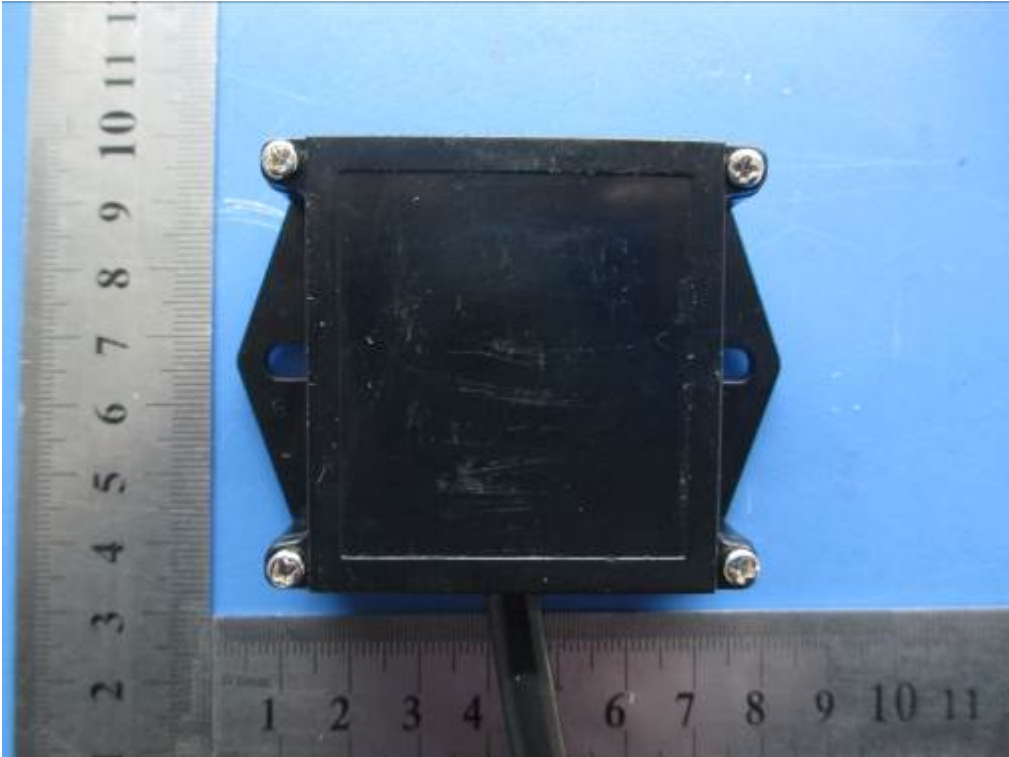

EUT - Top View

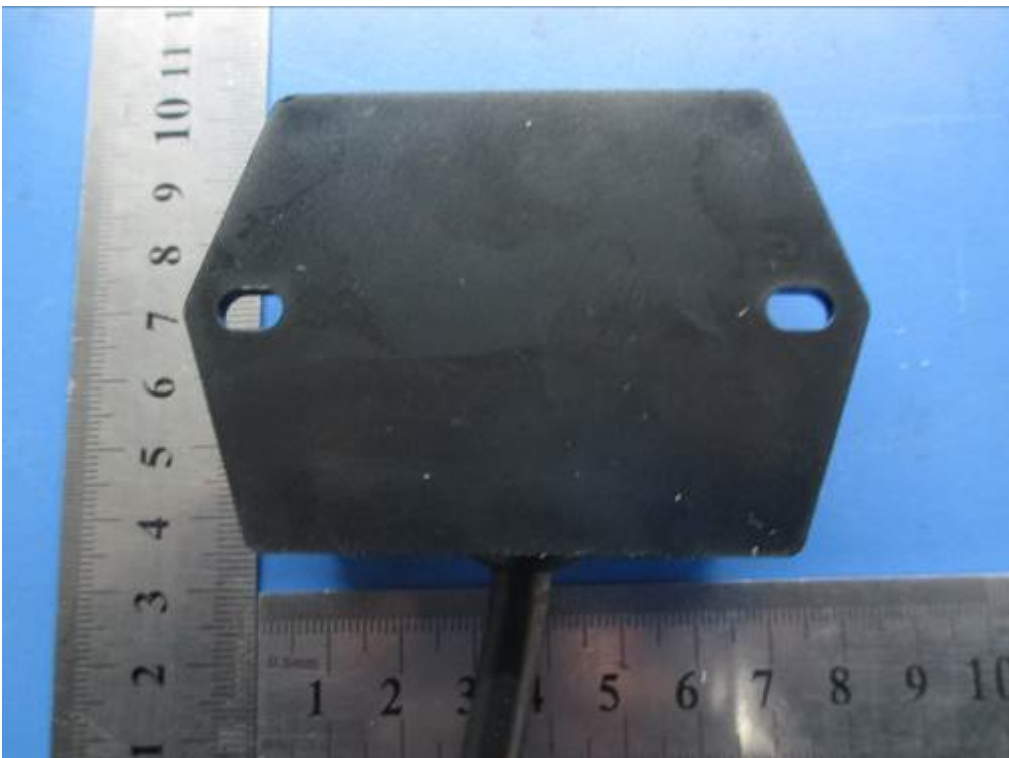

EUT - Bottom View



EUT – Front View

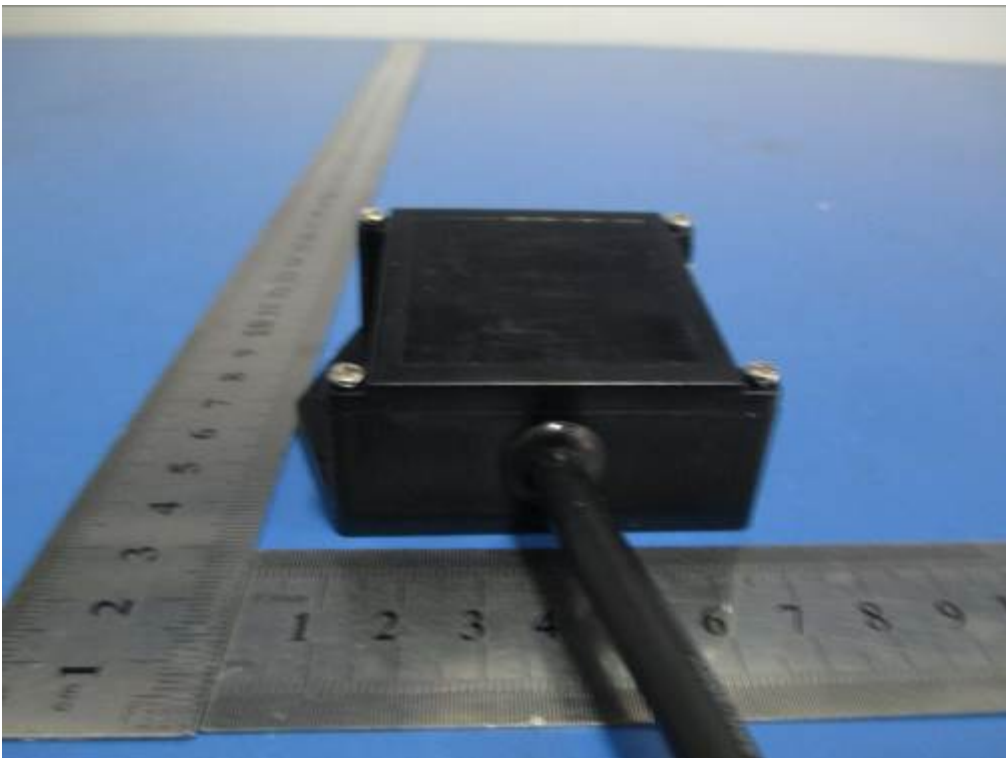

EUT - Rear View



EUT - Left View

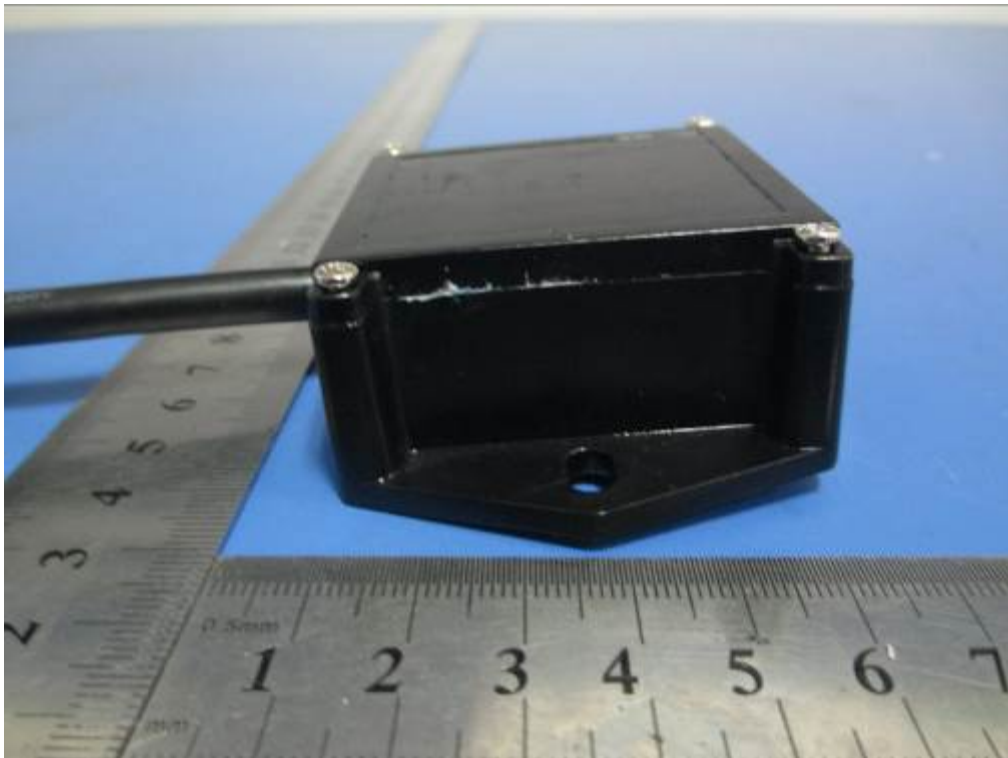

EUT - Right View

Annex B.ii. Photograph 2: EUT Internal Photo

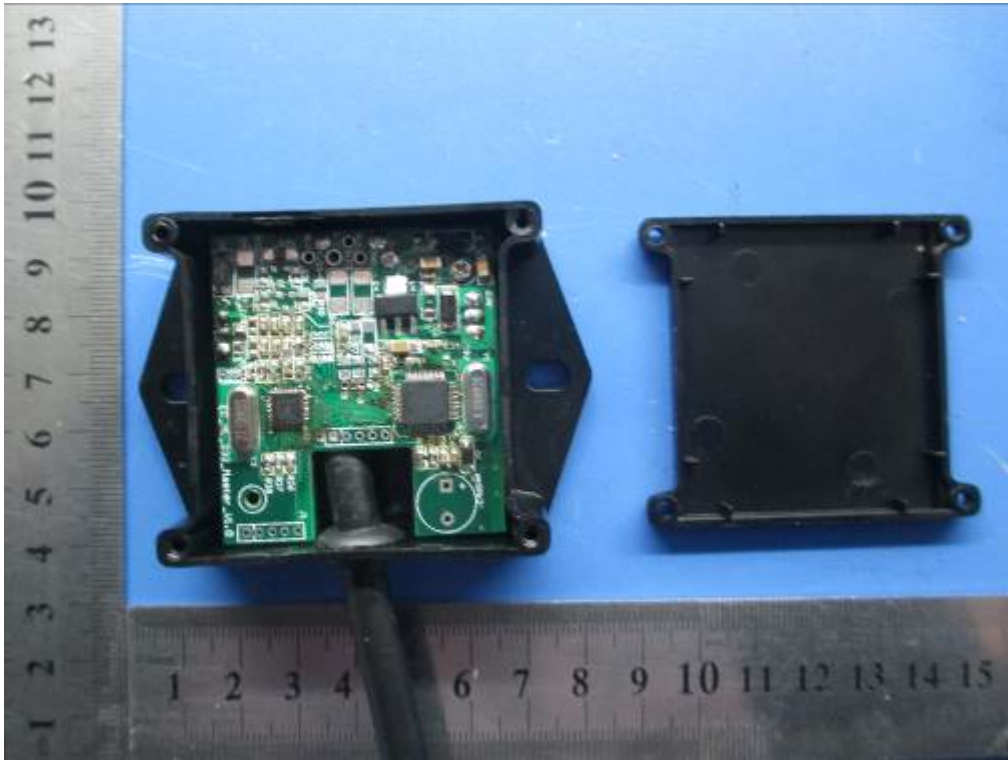

Cover Off – Front View 1

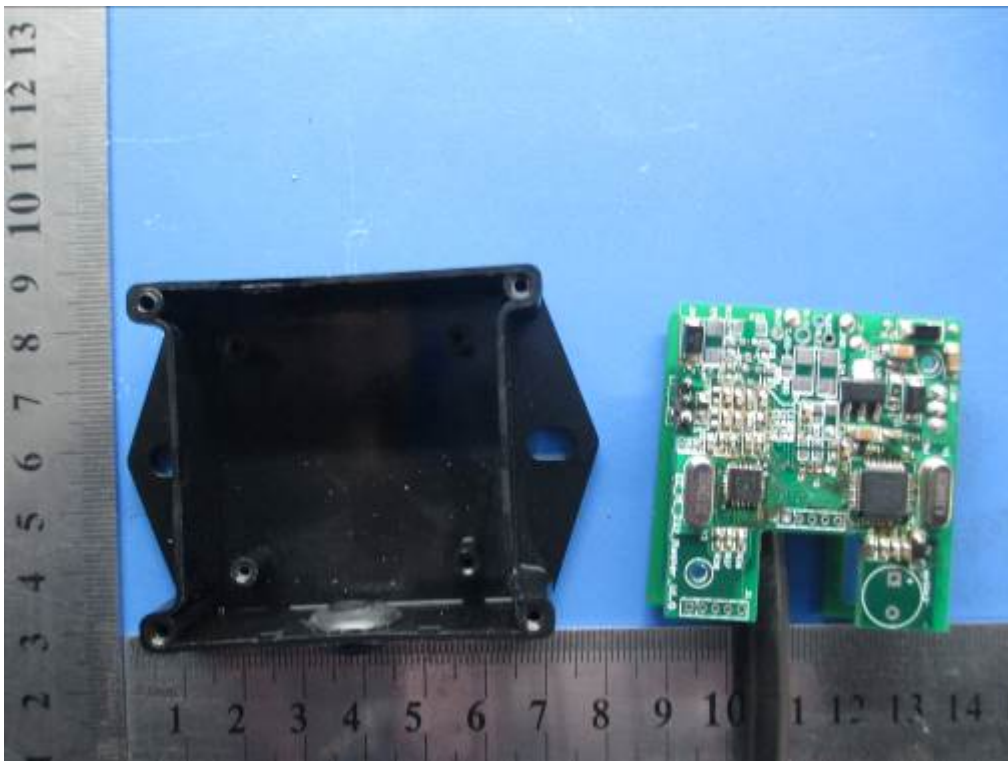

Cover Off – Front View 2

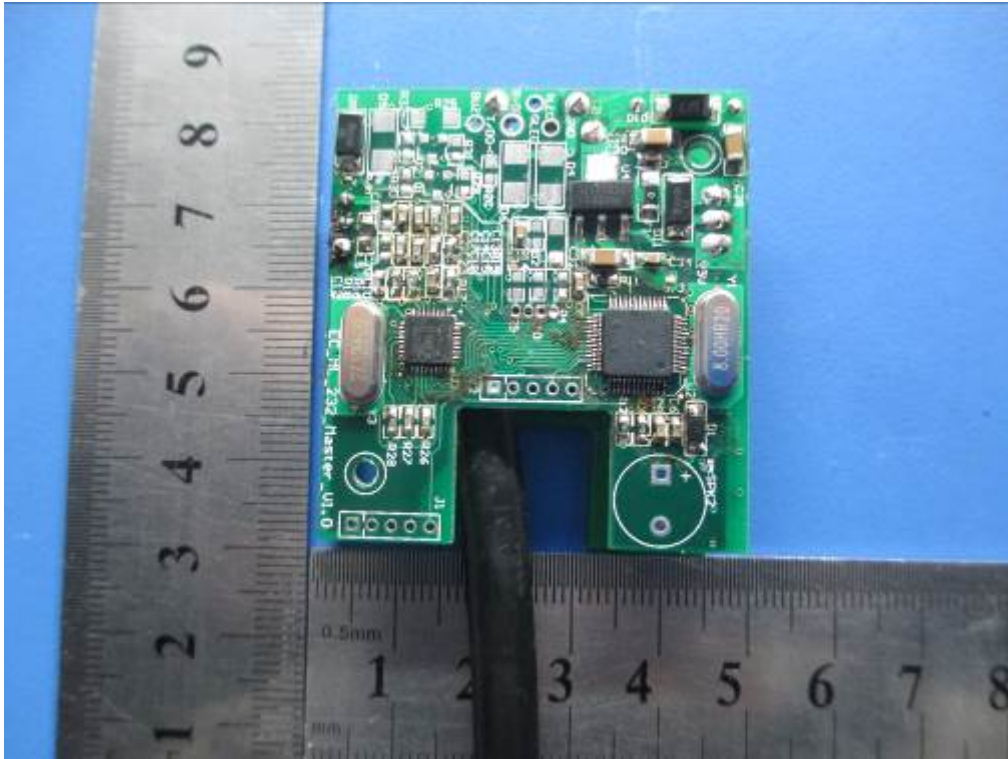

PCB - Top View

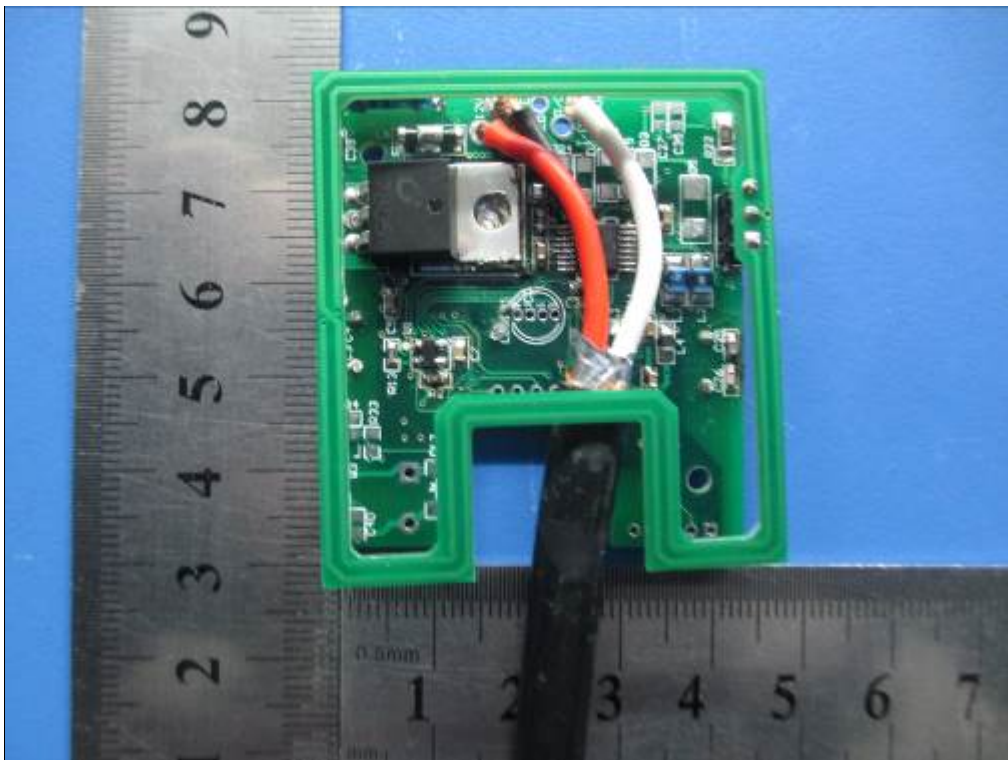

PCB - Bottom View

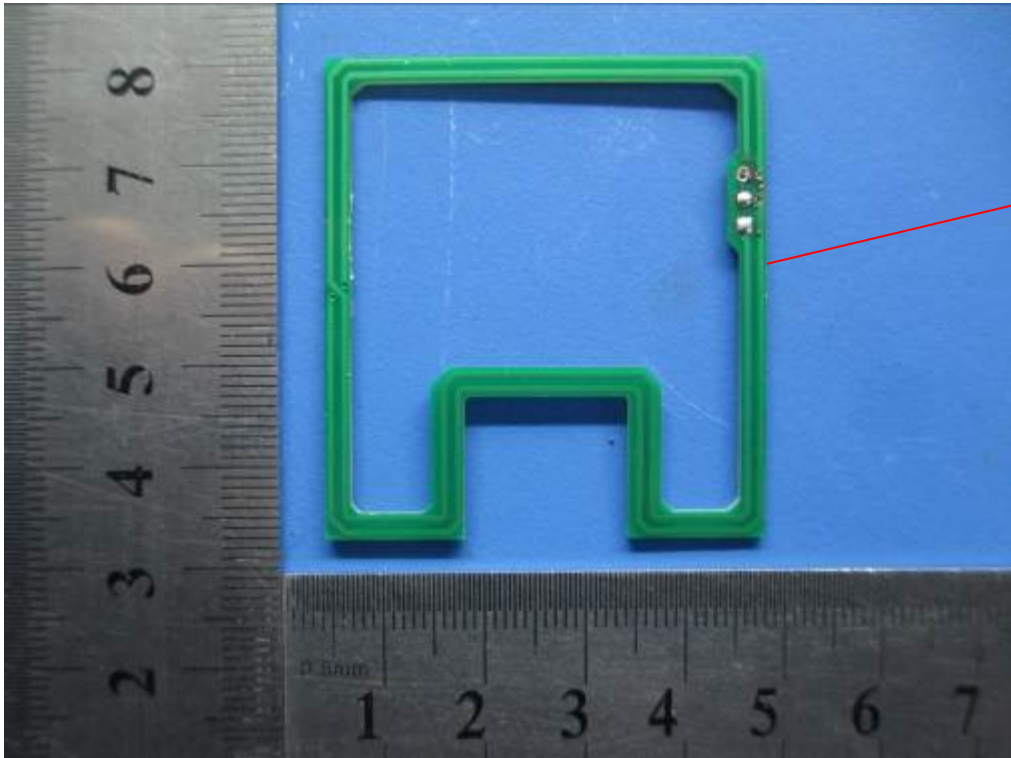

Antenna

Antenna – Front View

Annex B.iii. Photograph: Test Setup Photo



Conducted Emission Test Setup Front View



Conducted Emission Test Setup Side View



Front View of Radiated Emissions Test Setup below 30MHz

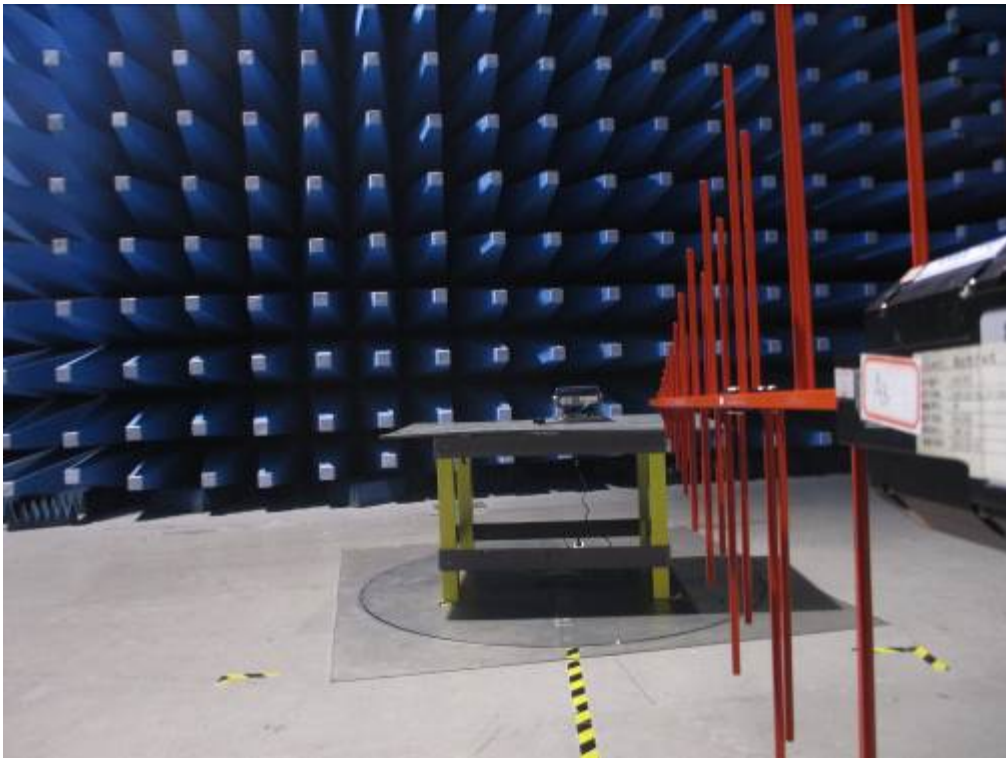

Front View of Radiated Emissions Test Setup (30MHz-1GHz)

Annex C. TEST SETUP AND SUPPORTING EQUIPMENT

EUT TEST CONDITIONS

Annex C. i. SUPPORTING EQUIPMENT DESCRIPTION

The following is a description of supporting equipment and details of cables used with the EUT.

Manufacturer	Equipment Description (Including Brand Name)	Model	Calibration Due Date
BK PRECISION	DC Power Supply	1786B	10/27/2014

Block Configuration Diagram for Conducted Emissions

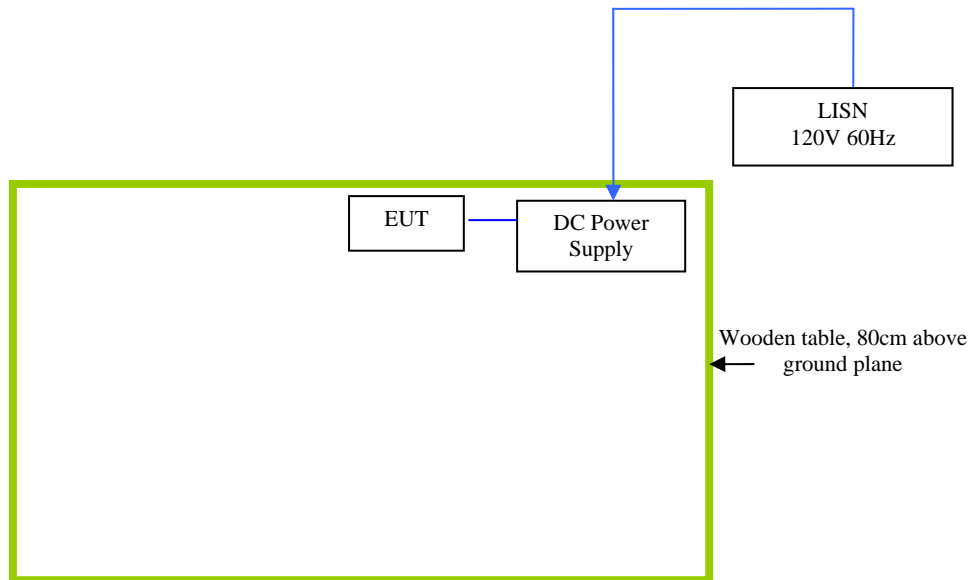

Block Configuration Diagram for Radiated Emissions

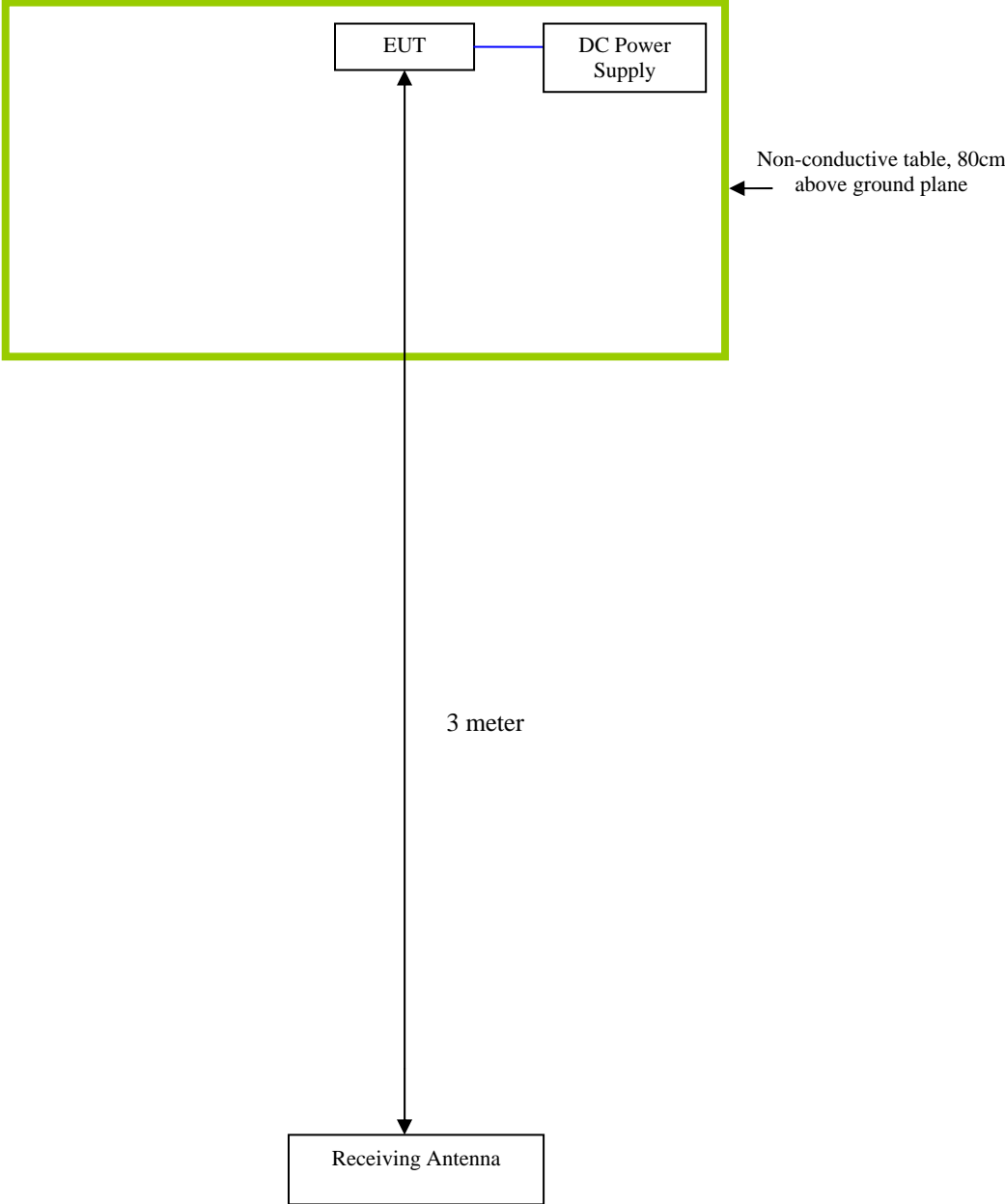

Annex C.ii. EUT OPERATING CONDITIONS

The following is the description of how the EUT is exercised during testing.

Test	Description Of Operation
Emissions Testing	The EUT was continuously transmitting to stimulate the worst case.

Annex D. USER MANUAL / BLOCK DIAGRAM / SCHEMATICS / PART LIST

Please see attachment

Annex E. DECLARATION OF SIMILARITY

N/A