

Shanghai Smarfid Security Equipment Co.,Ltd

smarfid-232 HID and EM reader

Main Model: EM-1916-N
Serial Model: HR392H-8N

December 06, 2013



Report No.: 13020916-FCC-E

(This report supersedes NONE)



Modifications made to the product : None

This Test Report is Issued Under the Authority of:

		
William Long Compliance Engineer	Alex Liu Technical Manager	

This test report may be reproduced in full only.
Test result presented in this test report is applicable to the representative sample only.

EMC Test Report

To: FCC Part 15 Subpart C: 2013, ANSI C63.4: 2009

SIEMIC, INC.
Accessing global markets

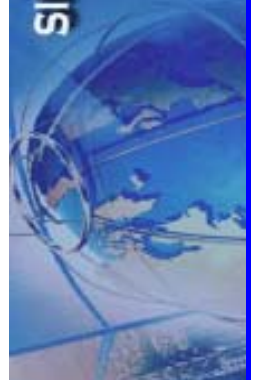

Laboratory Introduction

SIEMIC, headquartered in the heart of Silicon Valley, with superior facilities in US and Asia, is one of the leading independent testing and certification facilities providing customers with one-stop shop services for Compliance Testing and Global Certifications.



In addition to [testing](#) and [certification](#), SIEMIC provides initial design reviews and [compliance management](#) through out a project. Our extensive experience with [China](#), [Asia Pacific](#), [North America](#), [European](#), and [international](#) compliance requirements, assures the fastest, most cost effective way to attain regulatory compliance for the [global markets](#).

Accreditations for Conformity Assessment

Country/Region	Scope
USA	EMC , RF/Wireless , Telecom
Canada	EMC, RF/Wireless , Telecom
Taiwan	EMC, RF, Telecom , Safety
Hong Kong	RF/Wireless ,Telecom
Australia	EMC, RF, Telecom , Safety
Korea	EMI, EMS, RF , Telecom, Safety
Japan	EMI, RF/Wireless, Telecom
Singapore	EMC , RF , Telecom
Europe	EMC, RF, Telecom , Safety



SIEMIC, INC.

Accessing global markets

Title: EMC Test Report for smarfid-232 HID and EM reader
Main Model: EM-1916-N
Serial Model: HR392H-8N
To: FCC Part 15 Subpart C: 2013 , ANSI C63.4:2009

Report No.: 13020916-FCC-E
Issue Date: December 06, 2013
Page: 3 of 33
www.siemic.com.cn

This page has been left blank intentionally.



CONTENTS

1	EXECUTIVE SUMMARY & EUT INFORMATION	5
2	TECHNICAL DETAILS.....	6
3	MODIFICATION.....	7
4	TEST SUMMARY.....	8
5	MEASUREMENTS, EXAMINATION AND DERIVED RESULTS.....	9
	ANNEX A. TEST INSTRUMENTATION & GENERAL PROCEDURES	15
	ANNEX B. EUT AND TEST SETUP PHOTOGRAPHS	20
	ANNEX C. TEST SETUP AND SUPPORTING EQUIPMENT.....	28
	ANNEX D. USER MANUAL / BLOCK DIAGRAM / SCHEMATICS / PART LIST	32
	ANNEX E. DECLARATION OF SIMILARITY	33



SIEMIC, INC.

Accessing global markets

Title: EMC Test Report for smarfid-232 HID and EM reader
Main Model: EM-1916-N
Serial Model: HR392H-8N
To: FCC Part 15 Subpart C: 2013 , ANSI C63.4:2009

Report No.: 13020916-FCC-E
Issue Date: December 06, 2013
Page: 5 of 33
www.siemic.com.cn

1 EXECUTIVE SUMMARY & EUT INFORMATION

The purpose of this test programme was to demonstrate compliance of the Shanghai Smarfid Security Equipment Co.,Ltd, smarfid-232 HID and EM reader and Model: EM-1916-N against the current Stipulated Standards. The smarfid-232 HID and EM reader has demonstrated compliance with the FCC Part 15 Subpart C: 2013, ANSI C63.4: 2009.

EUT Information

EUT Description	smarfid-232 HID and EM reader
Main Model	EM-1916-N
Serial Model	HR392H-8N
Antenna Gain	6 dBi
Input Power	12VDC
Classification Per Stipulated Test Standard	Per FCC Part 15 Subpart C: 2013, ANSI C63.4: 2009

Note: the two models have the same circuits, components, appearance and color, the difference is only for model name.



SIEMIC, INC.

Accessing global markets

Title: EMC Test Report for smarfid-232 HID and EM reader
Main Model: EM-1916-N
Serial Model: HR392H-8N
To: FCC Part 15 Subpart C: 2013 , ANSI C63.4:2009

Report No.: 13020916-FCC-E
Issue Date: December 06, 2013
Page: 6 of 33
www.siemic.com.cn

2 TECHNICAL DETAILS

Purpose	Compliance testing of smarfid-232 HID and EM reader with stipulated standards
Applicant / Client	Shanghai Smarfid Security Equipment Co.,Ltd Room 301,4th Bldg., No.4 TongLi Road, SongJiang District,Shanghai 201615,China
Manufacturer	Shanghai Smarfid Security Equipment Co.,Ltd Room 301,4th Bldg., No.4 TongLi Road, SongJiang District,Shanghai 201615,China
Laboratory performing the tests	SIEMIC (Nanjing-China) Laboratories NO.2-1,Longcang Dadao, Yuhua Economic Development Zone, Nanjing, China Tel: +86(25)86730128/86730129 Fax: +86(25)86730127 Email: China@siemic.com.cn
Test report reference number	13020916-FCC-E
Date EUT received	October 22, 2013
Standard applied	FCC Part 15 Subpart C: 2013, ANSI C63.4: 2009
Dates of test (from – to)	November 22, 2013
No of Units	#1
Equipment Category	Card Reader
Trade Name	VITTO
RF Operating Frequency (ies)	125 kHz
Number of Channels	1CH
Modulation	ASK
FCC ID	X3A-232125KHZ



SIEMIC, Inc.

Accessing global markets

Title: EMC Test Report for smarfid-232 HID and EM reader
Main Model: EM-1916-N
Serial Model: HR392H-8N
To: FCC Part 15 Subpart C: 2013 , ANSI C63.4:2009

Report No.: 13020916-FCC-E
Issue Date: December 06, 2013
Page: 7 of 33
www.siemic.com.cn

3 MODIFICATION

NONE



SIEMIC, INC.

Accessing global markets

Title: EMC Test Report for smarfid-232 HID and EM reader
Main Model: EM-1916-N
Serial Model: HR392H-8N
To: FCC Part 15 Subpart C: 2013 , ANSI C63.4:2009

Report No.: 13020916-FCC-E
Issue Date: December 06, 2013
Page: 8 of 33
www.siemic.com.cn

4 TEST SUMMARY

The product was tested in accordance with the following specifications.
All testing has been performed according to below product classification:

Test Results Summary

Emissions			
Test Standard	Description	Product Class	Pass / Fail
§ 15.207	Conducted Emissions	See Above	Pass
§ 15.209	Radiated Emissions	See Above	Pass

All measurement uncertainty is not taken into consideration for all presented test result.



5 MEASUREMENTS, EXAMINATION AND DERIVED RESULTS

5.1 § 15.207 Conducted Emissions Test Result

Note:

1. All possible modes of operation were investigated. Only the several worst case emissions measured, using the correct CISPR and Average detectors, are reported. All other emissions were relatively insignificant.
2. A "-ve" margin indicates a PASS as it refers to the margin present below the limit line at the particular frequency.
3. Conducted Emissions Measurement Uncertainty
All test measurements carried out are traceable to national standards. The uncertainty of the measurement at a confidence level of approximately 95% (in the case where distributions are normal), with a coverage factor of 2, in the range 9kHz – 30MHz (Average & Quasi-peak) is $\pm 3.86\text{dB}$.
4. Environmental Conditions

Temperature	20°C
Relative Humidity	50%
Atmospheric Pressure	1009mbar
5. Test date : November 22, 2013
Tested By : William Long

Test Result: Pass



SIEMIC, INC.

Accessing global markets

Title: EMC Test Report for smarfid-232 HID and EM reader
Main Model: EM-1916-N
Serial Model: HR392H-8N
To: FCC Part 15 Subpart C: 2013 , ANSI C63.4:2009

Report No.: 13020916-FCC-E
Issue Date: December 06, 2013
Page: 10 of 33
www.siemic.com.cn

Test Mode: Normal Working

Peak Detector  **Quasi Peak Limit** 
Average Detector  **Average Limit** 

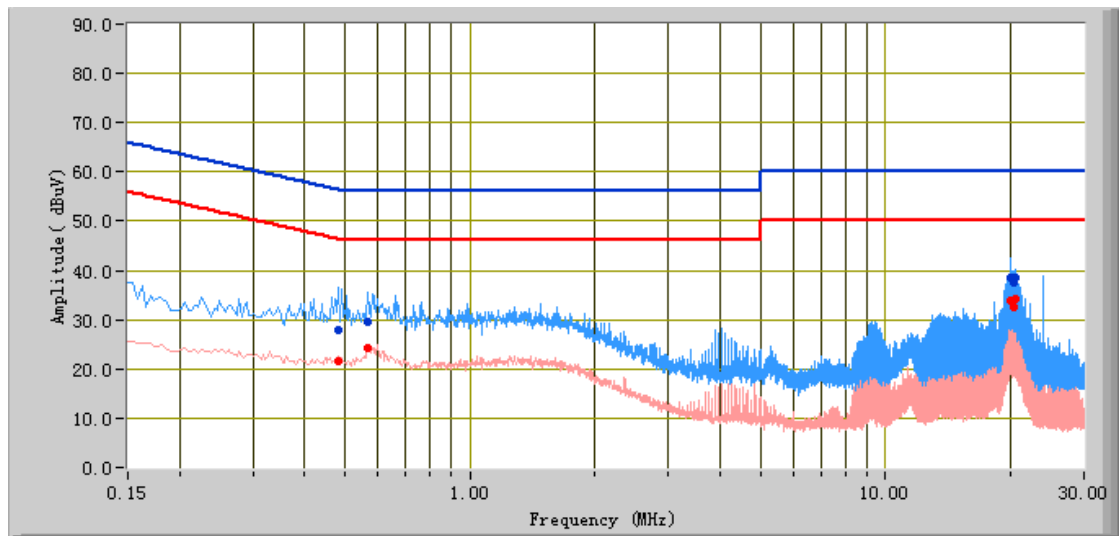

Test Data

Phase Line Plot at 120V AC, 60Hz

Frequency (MHz)	Quasi Peak (dB μ V/m)	Limit (dB μ V/m)	Margin (dB)	Average (dB μ V/m)	Limit (dB μ V/m)	Margin (dB)	Factors (dB)
19.96	38.49	60.00	-21.51	33.73	50.00	-16.27	11.58
0.48	27.88	56.30	-28.42	21.56	46.30	-24.74	11.09
20.46	38.63	60.00	-21.37	34.24	50.00	-15.76	11.59
20.17	38.26	60.00	-21.74	33.61	50.00	-16.39	11.59
20.31	37.56	60.00	-22.44	32.52	50.00	-17.48	11.59
0.57	29.59	56.00	-26.41	24.26	46.00	-21.74	11.01

Test Mode:	Normal Working
-------------------	-----------------------

Peak Detector		Quasi Peak Limit	
Average Detector		Average Limit	

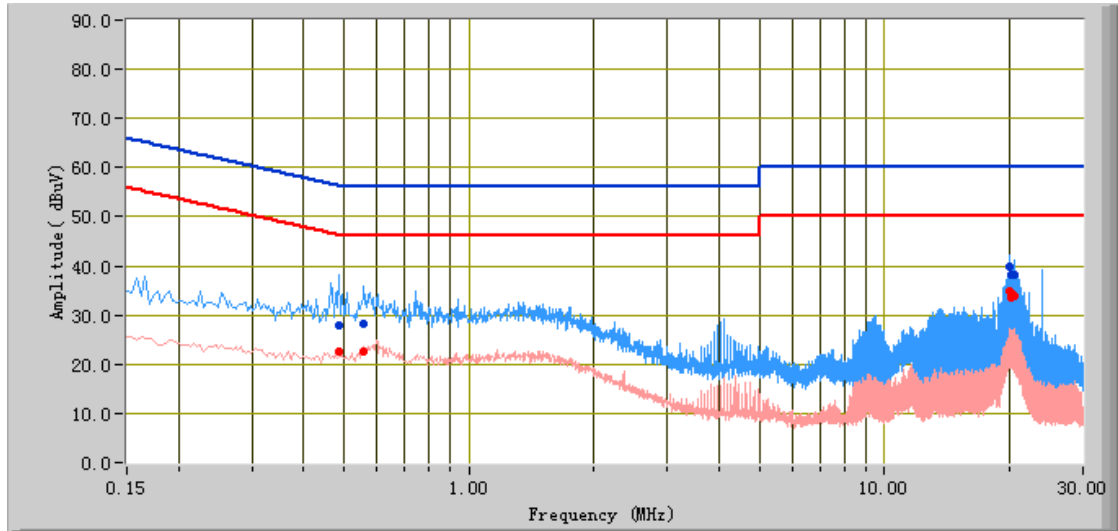

Test Data

Phase Natural Plot at 120V AC, 60Hz

Frequency (MHz)	Quasi Peak (dBµV/m)	Limit (dBµV/m)	Margin (dB)	Average (dBµV/m)	Limit (dBµV/m)	Margin (dB)	Factors (dB)
19.96	39.89	60.00	-20.11	35.03	50.00	-14.97	11.58
0.49	27.91	56.24	-28.33	22.67	46.24	-23.57	11.08
20.46	38.30	60.00	-21.70	33.89	50.00	-16.11	11.59
0.56	28.29	56.00	-27.71	22.75	46.00	-23.25	11.02
20.31	38.08	60.00	-21.92	34.08	50.00	-15.92	11.59
20.10	38.09	60.00	-21.91	33.62	50.00	-16.38	11.58



SIEMIC, INC.

Accessing global markets

Title: EMC Test Report for smarfid-232 HID and EM reader
Main Model: EM-1916-N
Serial Model: HR392H-8N
To: FCC Part 15 Subpart C: 2013 , ANSI C63.4:2009

Report No.: 13020916-FCC-E
Issue Date: December 06, 2013
Page: 13 of 33
www.siemic.com.cn

Test Mode:



Normal Working

**Below 30MHz
Vertical (0 degrees) & Horizontal(90 degrees) Polarity Plot at 3m**

Frequency (MHz)	Quasi Peak (dB μ V/m)	Azimuth	Polarity (H/V)	Height (cm)	Factors (dB)	Limit (dB μ V/m)	Margin (dB)
0.125	104.26	153	H	236	-56.36	125.7	-21.44
1.21	68.02	36	H	210	-55.15	105.9	-37.88
2.59	35.48	205	H	225	-54.28	49.5	-14.02
0.125	89.99	185	V	158	-56.36	125.7	-35.71
2.66	32.05	352	V	169	-54.27	49.5	-17.45
3.56	39.63	15	V	151	-53.42	49.5	-9.87

Test Mode:	Normal Working
-------------------	-----------------------

30MHz - 1GHz

Peak Detector 
 Quasi Peak Limit 

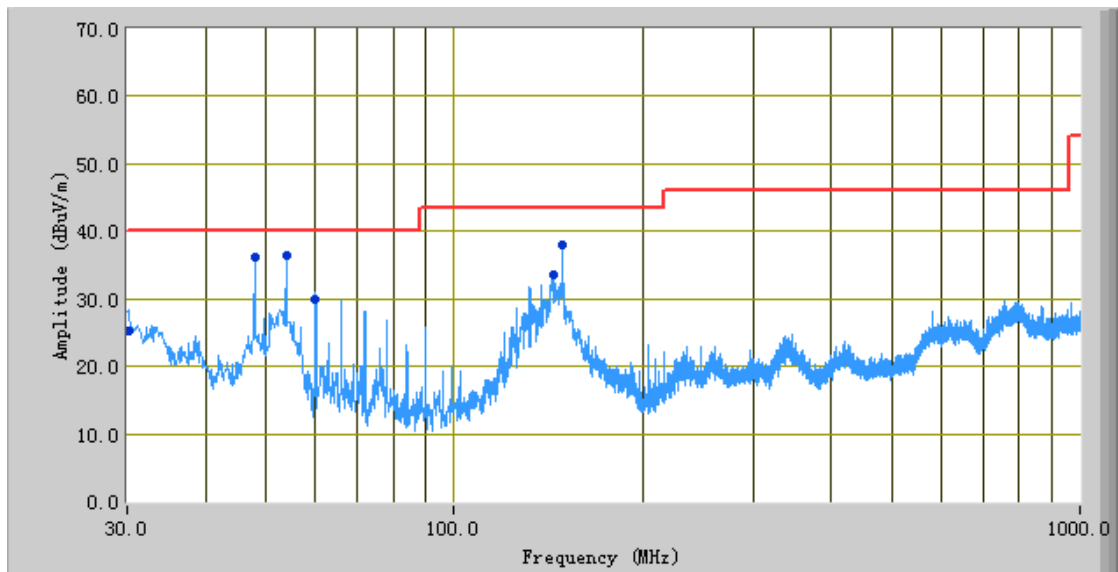

Test Data

Vertical & Horizontal Polarity Plot at 3m

Frequency (MHz)	Quasi Peak (dBµV/m)	Azimuth	Polarity (H/V)	Height (cm)	Factors (dB)	Limit (dBµV/m)	Margin (dB)
54.03	36.34	70.00	V	100.00	-35.28	40.00	-3.66
48.01	36.13	312.00	V	100.00	-31.85	40.00	-3.87
148.52	37.90	184.00	H	219.00	-31.97	43.50	-5.60
60.03	30.01	14.00	V	119.00	-38.81	40.00	-9.99
144.03	33.44	192.00	H	234.00	-32.17	43.50	-10.06
30.06	25.16	358.00	V	106.00	-21.48	40.00	-14.84

Note: The data above 1 GHz which below 20 dB to the limit was not recorded.



SIEMIC, Inc.

Accessing global markets

Title: EMC Test Report for smarfid-232 HID and EM reader
Main Model: EM-1916-N
Serial Model: HR392H-8N
To: FCC Part 15 Subpart C: 2013 , ANSI C63.4:2009

Report No.: 13020916-FCC-E
Issue Date: December 06, 2013
Page: 15 of 33
www.siemic.com.cn

Annex A. TEST INSTRUMENTATION & GENERAL PROCEDURES

Annex A.i. TEST INSTRUMENTATION

Instrument	Model	Serial #	Calibration Date	Calibration Due Date
AC Line Conducted Emissions				
R&S EMI Test Receiver	ESPI3	101216	09/27/2013	09/26/2014
ROHDE&SCHWARZ V-LISN	ESH3-Z5	838979/005	09/27/2013	09/26/2014
Com-Power Transient Limiter	LIT-153	531021	09/27/2013	09/26/2014
SIEMIC Labview Conducted Emissions software	V1.0	N/A	N/A	N/A
Radiated Emissions				
Hp Spectrum Analyzer	8563E	3821A09023	09/27/2013	09/26/2014
R&S EMI Receiver	ESPI3	101216	09/27/2013	09/26/2014
Antenna (30MHz~6GHz)	JB6	A121411	03/27/2013	03/26/2014
ETS-Lindgren Antenna (1 ~18GHz)	3115	N/A	10/09/2013	10/08/2014
A-INFOMW Antenna (1 ~18GHz)	JXTXLB-10180	J2031081120092	10/09/2013	10/08/2014
Horn Antenna (18~40GHz)	AH-840	101013	04/22/2013	04/22/2014
Microwave Pre-Amp (18~40GHz)	PA-840	181250	05/30/2013	05/29/2014
Hp Agilent Pre-Amplifier	8447F	1937A01160	10/27/2013	10/26/2014
MITEQ Pre-Amplifier (0.1 ~ 18GHz)	AMF-7D-00101800-30-10P	1451709	10/27/2013	10/26/2014
Chamber	3m	N/A	04/13/2013	04/12/2014
SIEMIC Labview Radiated Emissions software	V1.0	N/A	N/A	N/A

Annex A.ii. AC LINE CONDUCTED EMISSIONS TEST DESCRIPTION

Test Set-up

1. The EUT and supporting equipment were set up in accordance with the requirements of the standard on top of a 1.5m x 1m x 0.8m high, non-metallic table, as shown in Annex B.
2. The power supply for the EUT was fed through a 50Ω/50μH EUT LISN, connected to filtered mains.
3. The RF OUT of the EUT LISN was connected to the EMI test receiver via a low-loss coaxial cable.
4. All other supporting equipments were powered separately from another main supply.

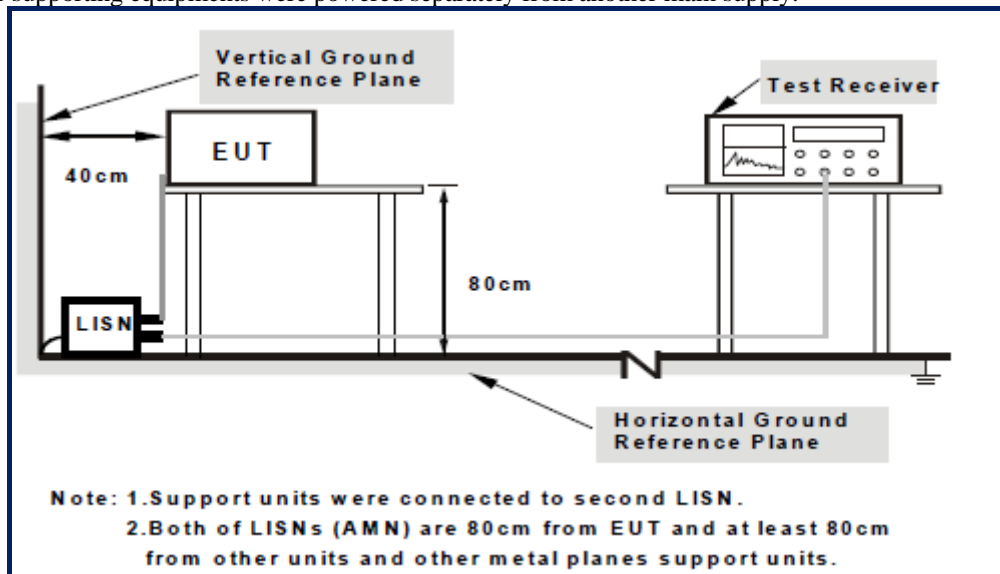

For the actual test configuration, please refer to the related item – Photographs of the Test Configuration1

Test Method

1. The EUT was switched on and allowed to warm up to its normal operating condition.
2. A scan was made on the NEUTRAL line (for AC mains) or Earth line (for DC power) over the required frequency range using an EMI test receiver.
3. High peaks, relative to the limit line, were then selected.
4. The EMI test receiver was then tuned to the selected frequencies and the necessary measurements made with a receiver bandwidth setting of 10 kHz. For FCC tests, only Quasi-peak measurements were made; while for CISPR/EN tests, both Quasi-peak and Average measurements were made.
5. Steps 2 to 4 were then repeated for the LIVE line (for AC mains) or DC line (for DC power).

Description of Conducted Emission Program

This EMC Measurement software run LabView automation software and offers a common user interface for electromagnetic interference (EMI) measurements. This software is a modern and powerful tool for controlling and monitoring EMI test receivers and EMC test systems. It guarantees reliable collection, evaluation, and documentation of measurement results. Basically, this program will run a pre-scan measurement before it proceeds with the final measurement. The pre-scan routine will run the common scan range from 150 kHz to 30 MHz; the program will first start a peak and average scan on selectable measurement time and step size. After the program complete the pre-scan, this program will perform the Quasi Peak and Average measurement, based on the pre-scan peak data reduction result.



SIEMIC, INC.

Accessing global markets

Title: EMC Test Report for smarfid-232 HID and EM reader
Main Model: EM-1916-N
Serial Model: HR392H-8N
To: FCC Part 15 Subpart C: 2013 , ANSI C63.4:2009

Report No.: 13020916-FCC-E
Issue Date: December 06, 2013
Page: 17 of 33
www.siemic.com.cn

Sample Calculation Example

At 20 MHz

limit = $250 \mu\text{V} = 47.96 \text{ dB}\mu\text{V}$

Transducer factor of LISN, pulse limiter & cable loss at 20 MHz = 11.20 dB

Q-P reading obtained directly from EMI Receiver = 40.00 dB μV
(Calibrated for system losses)

Therefore, Q-P margin = $47.96 - 40.00 = 7.96$ i.e. **7.96 dB below limit**

Annex A. iii. RADIATED EMISSIONS TEST DESCRIPTION

EUT Characterisation

EUT characterisation, over the frequency range from 30MHz to 10th Harmonic, was done in order to minimise radiated emissions testing time while still maintaining high confidence in the test results.

The EUT was placed in the chamber, at a height of about 0.8 m on a turntable. Its radiated emissions frequency profile was observed, using a spectrum analyzer /receiver with the appropriate broadband antenna placed 3m away from the EUT. Radiated emissions from the EUT were maximised by rotating the turntable manually, changing the antenna polarisation and manipulating the EUT cables while observing the frequency profile on the spectrum analyzer / receiver. Frequency points at which maximum emissions occurred; clock frequencies and operating frequencies were then noted for the formal radiated emissions test at the Open Area Test Site (OATS) or 3m EMC chamber.

Test Set-up

1. The EUT and supporting equipment were set up in accordance with the requirements of the standard on top of a 1.5mX1.0mX0.8m high, non-conductive table.
2. The filtered power supply for the EUT and supporting equipment were tapped from the appropriate power sockets located on the turntable.
3. The relevant broadband antenna was set at the required test distance away from the EUT and supporting equipment boundary.

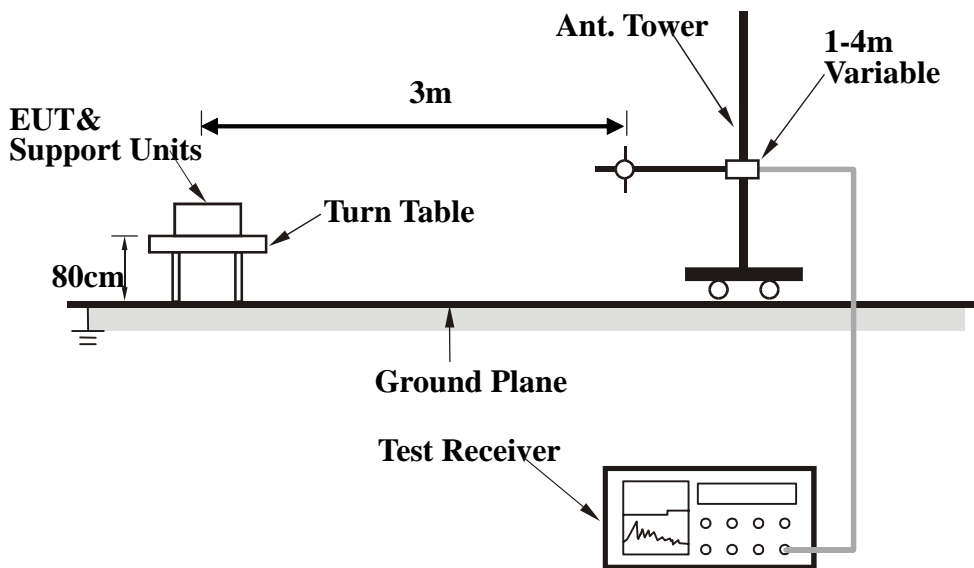

For the actual test configuration, please refer to the related item – Photographs of the Test Configuration2

Test Method

The following procedure was performed to determine the maximum emission axis of EUT:

1. With the receiving antenna is H polarization, rotate the EUT in turns with three orthogonal axes to determine the axis of maximum emission.
2. With the receiving antenna is V polarization, rotate the EUT in turns with three orthogonal axes to determine the axis of maximum emission.
3. Compare the results derived from above two steps. So, the axis of maximum emission from EUT was determined and the configuration was used to perform the final measurement.

Final Radiated Emission Measurement

1. Setup the configuration according to figure 1. Turn on EUT and make sure that it is in normal function.
2. For emission frequencies measured below 1GHz, a pre-scan is performed in a shielded chamber to determine the accurate frequencies of higher emissions will be checked on an open test site. As the same purpose, for emission frequencies measured above 1GHz, a pre-scan also be performed with a 1 meter measuring distance before final test.
3. For emission frequencies measured below and above 1GHz, set the spectrum analyzer on a 100kHz and 1MHz resolution bandwidth respectively for each frequency measured in step 2.
4. The search antenna is to be raised and lowered over a range from 1 to 4 meters in horizontally polarized orientation. Position the highness when the highest value is indicated on spectrum analyzer, then change the orientation of EUT on test table over a range from 0° to 360° with a speed as slow as possible, and keep the azimuth that highest emission is indicated on the spectrum analyzer. Vary the antenna position again and record the highest value as a final reading.
5. Repeat step 4 until all frequencies need to be measured was complete.
6. Repeat step 5 with search antenna in vertical polarized orientations.

During the radiated emission test, the Spectrum Analyzer was set with the following configurations:

Frequency Band (MHz)	Function	Resolution bandwidth	Video Bandwidth
30 to 1000	Peak	100kHz	100kHz
Above 1000	Peak	1MHz	1MHz
	Average	1MHz	10Hz

Sample Calculation Example

The field strength is calculated by adding the Antenna Factor and Cable Factor, and subtracting the Amplifier Gain (if any) from the measured reading. For the limit is employed average value, therefore the peak value can be transferred to average value by subtracting the duty factor. The basic equation with a sample calculation is as follows:

$$\text{Peak} = \text{Reading} + \text{Corrected Factor}$$

where

$$\text{Corr. Factor} = \text{Antenna Factor} + \text{Cable Factor} - \text{Amplifier Gain (if any)}$$

And the average value is

$$\text{Average} = \text{Peak Value} + \text{Duty Factor or}$$

$$\text{Set RBW} = 1\text{MHz, VBW} = 10\text{Hz.}$$

Note:

If the measured frequencies are fall in the restricted frequency band, the limit employed must be quasi peak value when frequencies are below or equal to 1GHz. And the measuring instrument is set to quasi peak detector function.



SIEMIC, INC.

Accessing global markets

Title: EMC Test Report for smarfid-232 HID and EM reader
Main Model: EM-1916-N
Serial Model: HR392H-8N
To: FCC Part 15 Subpart C: 2013 , ANSI C63.4:2009

Report No.: 13020916-FCC-E
Issue Date: December 06, 2013
Page: 20 of 33
www.siemic.com.cn

Annex B. EUT AND TEST SETUP PHOTOGRAPHS

Annex B.i. Photograph 1: EUT External Photo



EUT - Top View

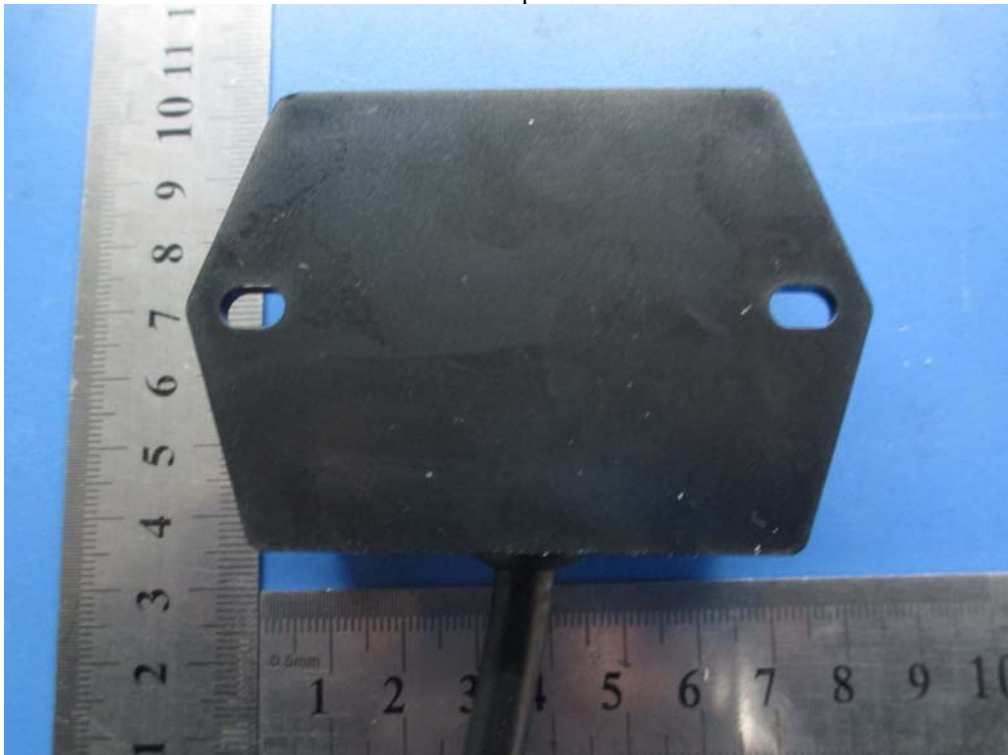

EUT - Bottom View



SIEMIC, INC.

Accessing global markets

Title: EMC Test Report for smarfid-232 HID and EM reader
Main Model: EM-1916-N
Serial Model: HR392H-8N
To: FCC Part 15 Subpart C: 2013 , ANSI C63.4:2009

Report No.: 13020916-FCC-E
Issue Date: December 06, 2013
Page: 21 of 33
www.siemic.com.cn

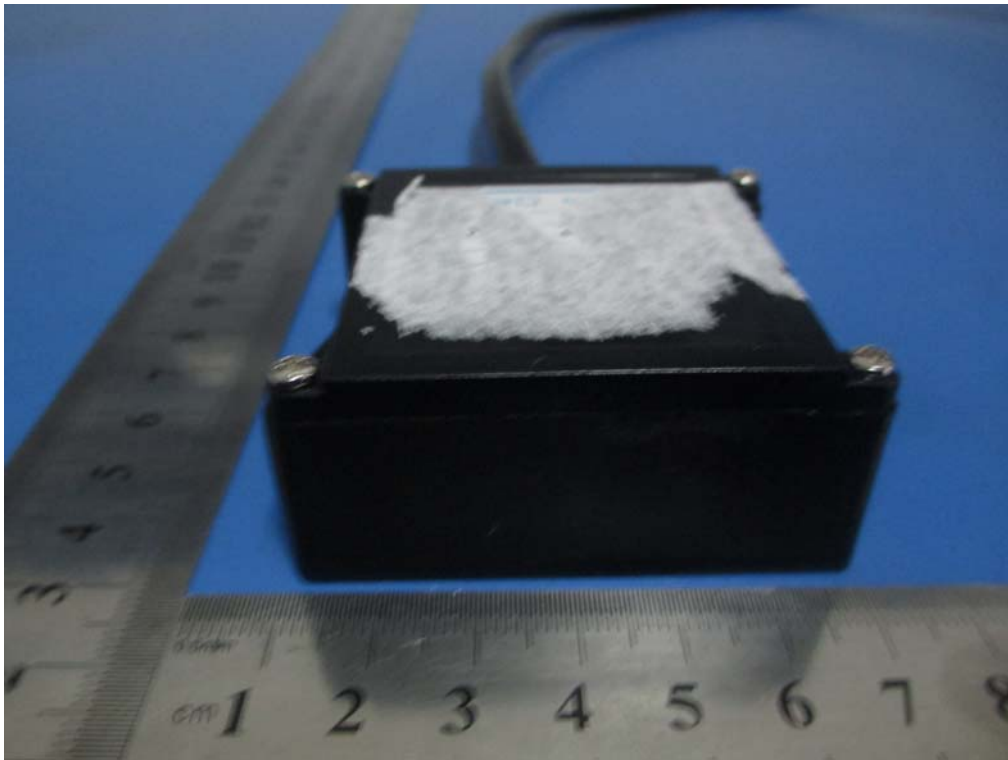

EUT – Front View



EUT - Rear View



SIEMIC, INC.

Accessing global markets

Title: EMC Test Report for smarfid-232 HID and EM reader
Main Model: EM-1916-N
Serial Model: HR392H-8N
To: FCC Part 15 Subpart C: 2013 , ANSI C63.4:2009

Report No.: 13020916-FCC-E
Issue Date: December 06, 2013
Page: 22 of 33
www.siemic.com.cn

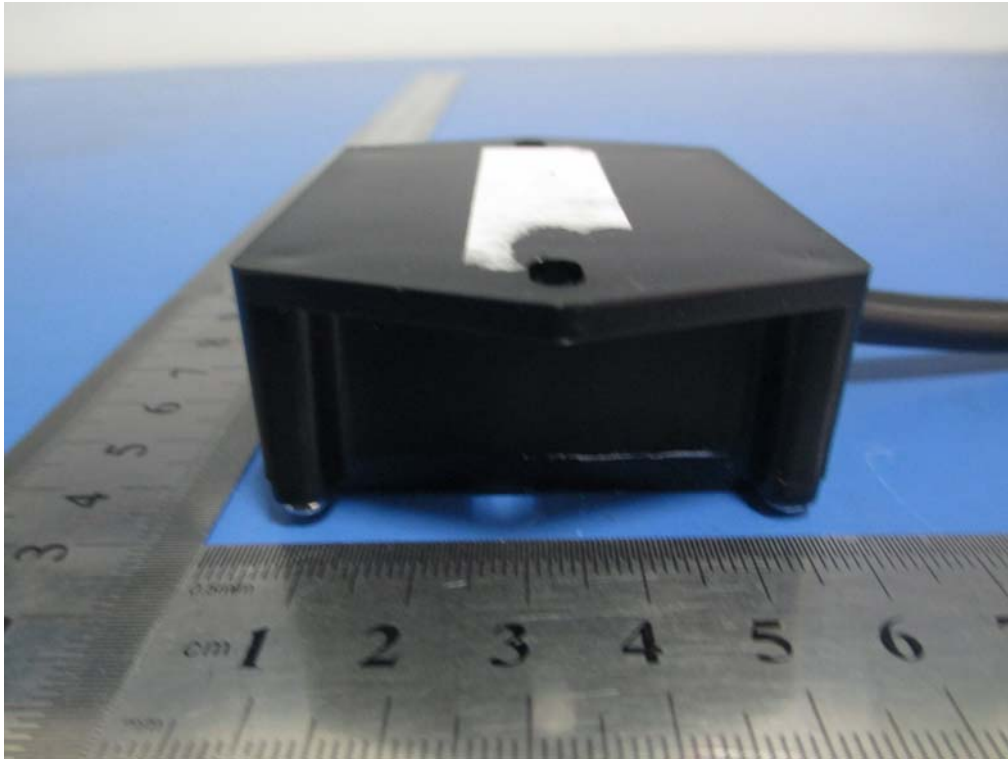

EUT - Left View

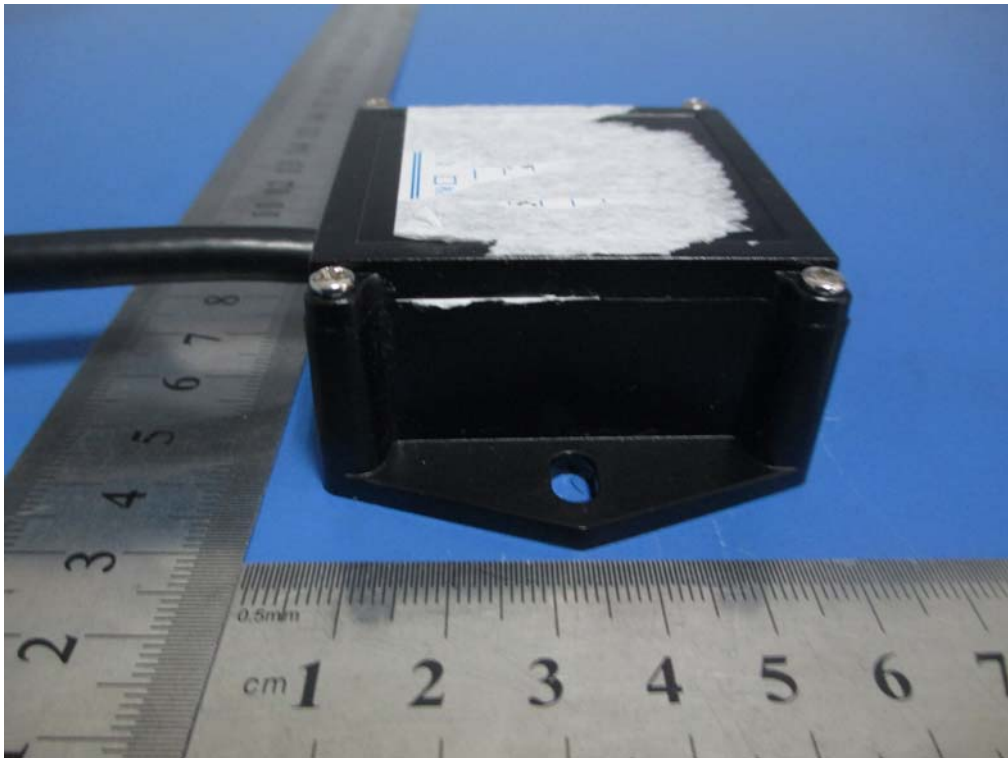

EUT - Right View

Annex B.ii. Photograph 2: EUT Internal Photo

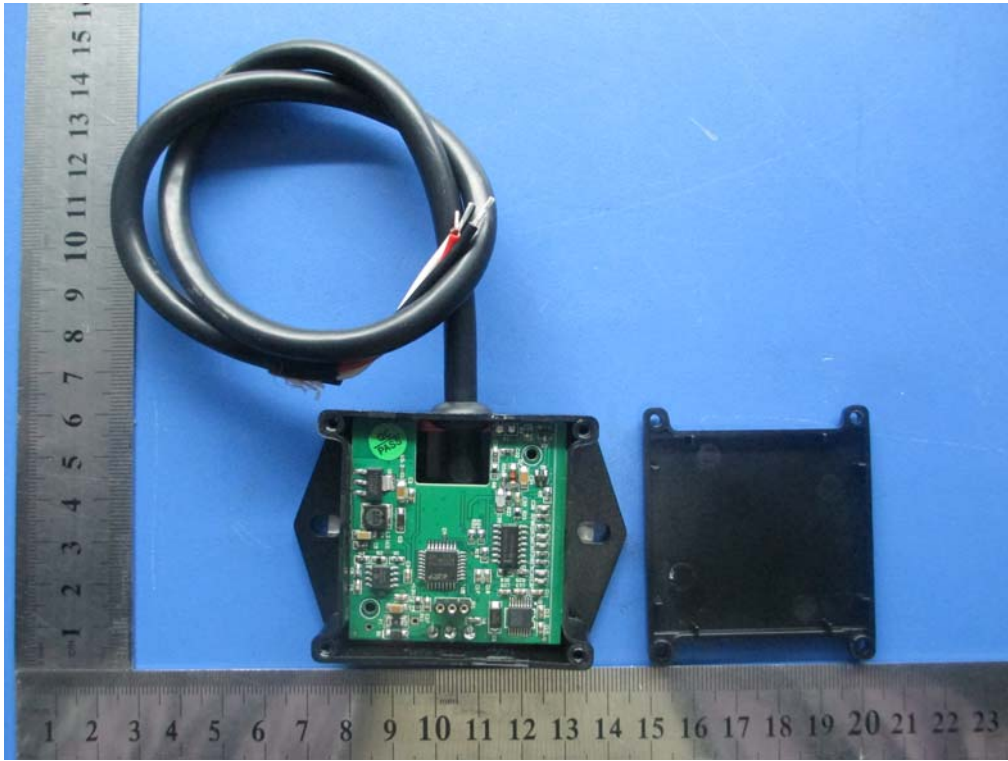

Cover Off – Front View 1

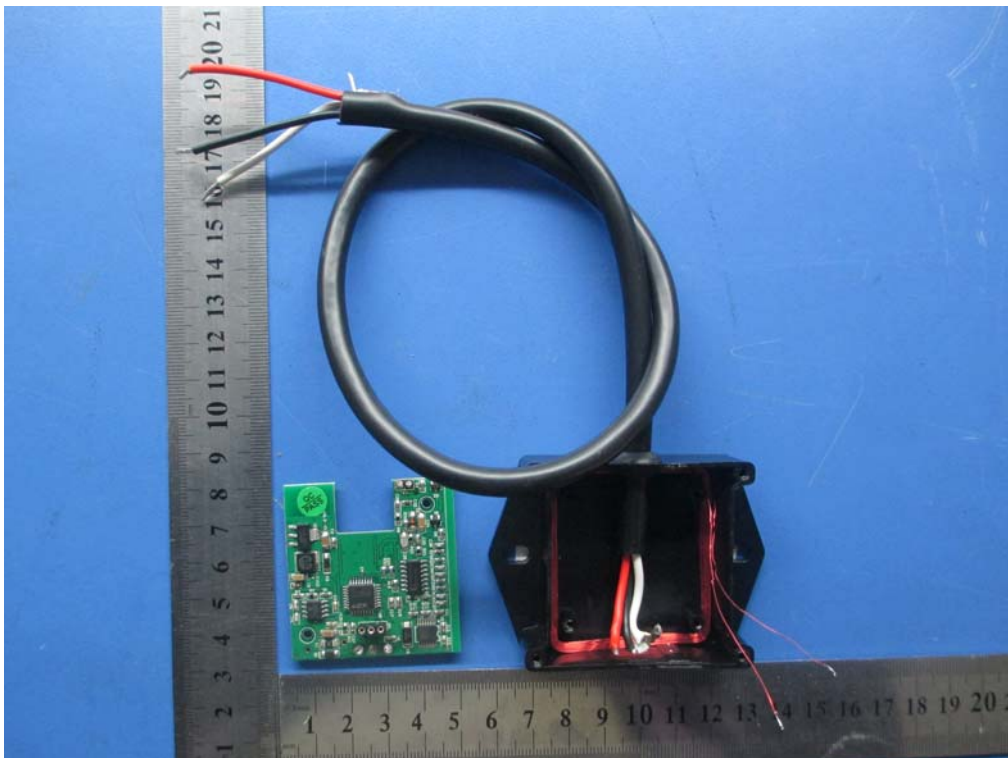

Cover Off – Front View 2

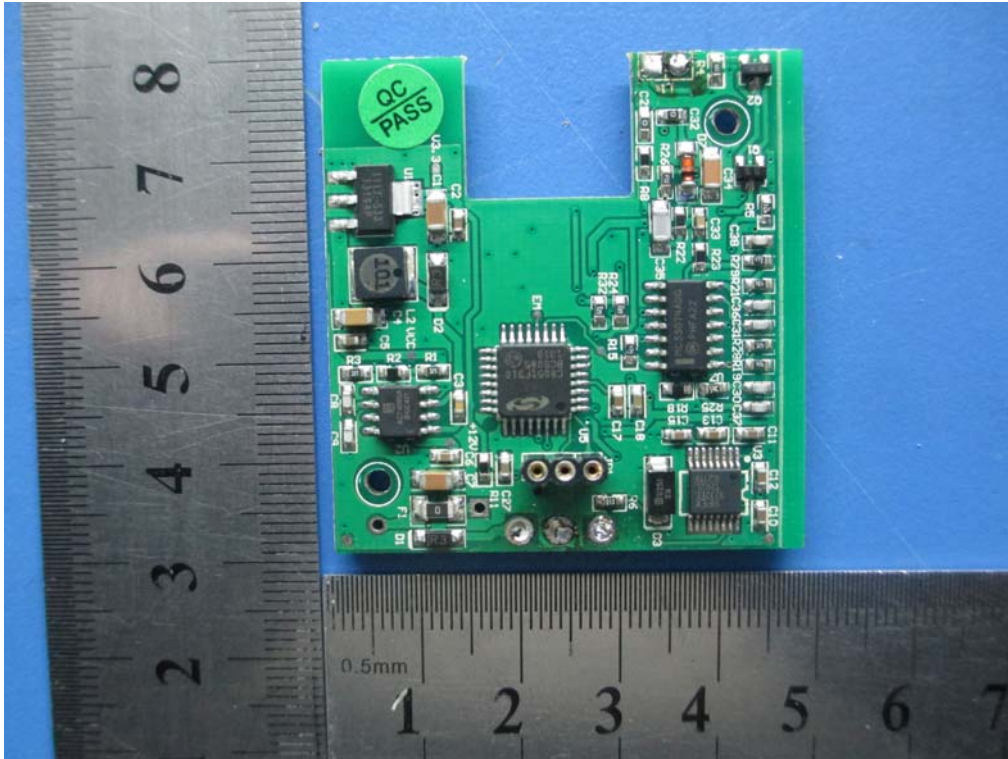

PCB - Top View

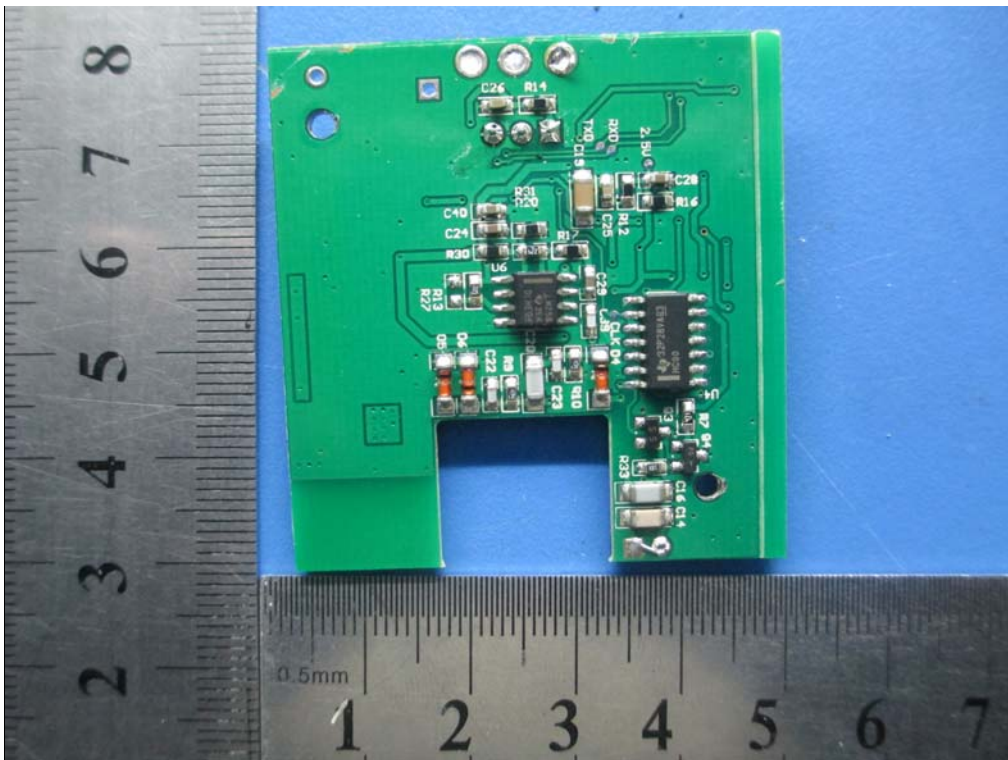

PCB - Bottom View



SIEMIC, INC.

Accessing global markets

Title: EMC Test Report for smarfid-232 HID and EM reader
Main Model: EM-1916-N
Serial Model: HR392H-8N
To: FCC Part 15 Subpart C: 2013 , ANSI C63.4:2009

Report No.: 13020916-FCC-E
Issue Date: December 06, 2013
Page: 25 of 33
www.siemic.com.cn

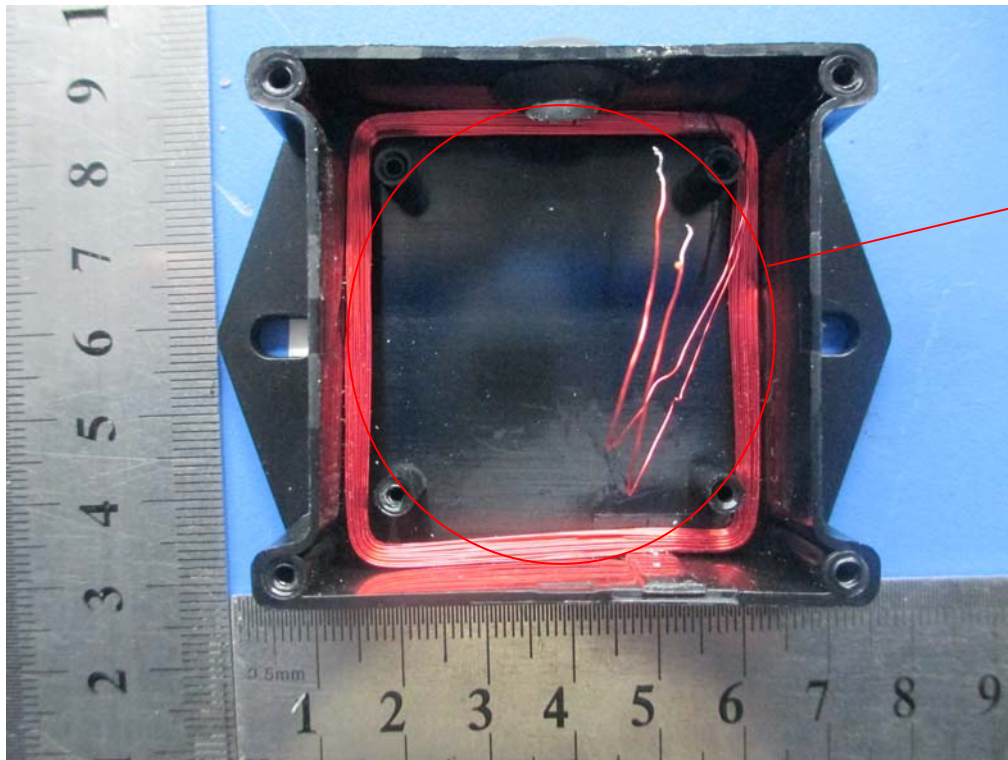

Antenna

Antenna – Front View



SIEMIC, INC.

Accessing global markets

Title: EMC Test Report for smarfid-232 HID and EM reader
Main Model: EM-1916-N
Serial Model: HR392H-8N
To: FCC Part 15 Subpart C: 2013 , ANSI C63.4:2009

Report No.: 13020916-FCC-E
Issue Date: December 06, 2013
Page: 26 of 33
www.siemic.com.cn

Annex B.iii. Photograph 3: Test Setup Photo



Conducted Emissions Test Setup Front View



Conducted Emissions Test Setup Side View



SIEMIC, INC.

Accessing global markets

Title: EMC Test Report for smarfid-232 HID and EM reader
Main Model: EM-1916-N
Serial Model: HR392H-8N
To: FCC Part 15 Subpart C: 2013 , ANSI C63.4:2009

Report No.: 13020916-FCC-E
Issue Date: December 06, 2013
Page: 27 of 33
www.siemic.com.cn

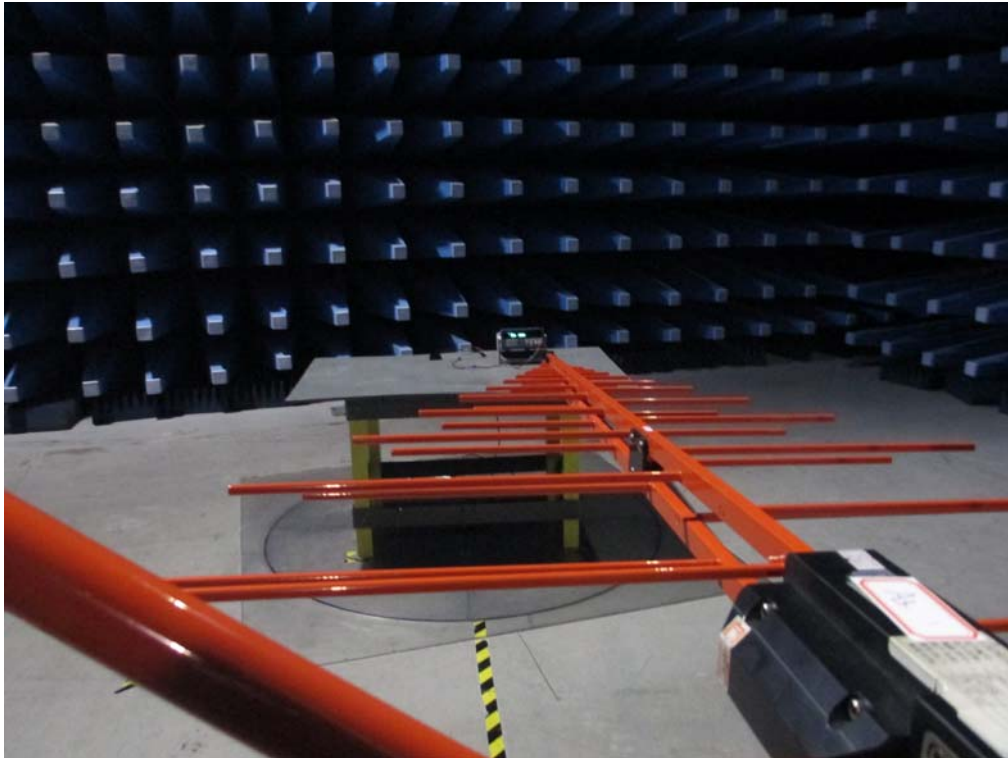

Radiated Spurious Emissions Test Setup (30MHz - 1GHz) - Front View

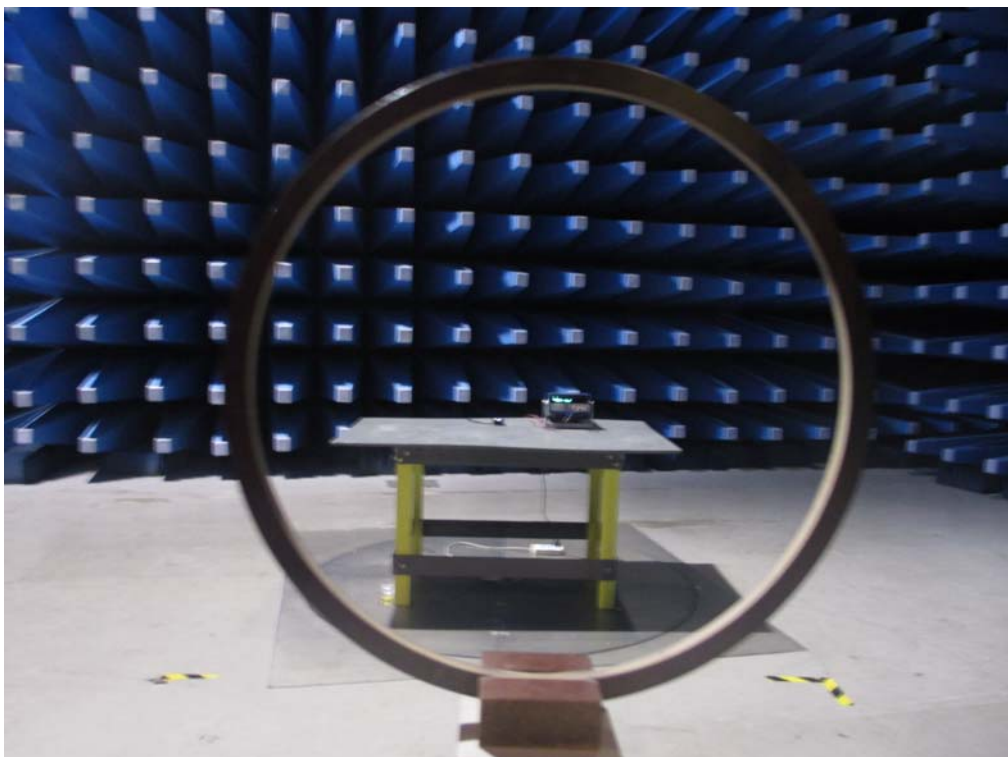

Radiated Spurious Emissions Test Setup (Below 30MHz) -Front View



SIEMIC, INC.

Accessing global markets

Title: EMC Test Report for smarfid-232 HID and EM reader
Main Model: EM-1916-N
Serial Model: HR392H-8N
To: FCC Part 15 Subpart C: 2013 , ANSI C63.4:2009

Report No.: 13020916-FCC-E
Issue Date: December 06, 2013
Page: 28 of 33
www.siemic.com.cn

Annex C. TEST SETUP AND SUPPORTING EQUIPMENT

EUT TEST CONDITIONS

Annex C. i. SUPPORTING EQUIPMENT DESCRIPTION

The following is a description of supporting equipment and details of cables used with the EUT.

Manufacturer	Equipment Description (Including Brand Name)	Model	Calibration Due Date
BK PRECISION	DC Power Supply	1786B	10/27/2014



Block Configuration Diagram for Conducted Emissions

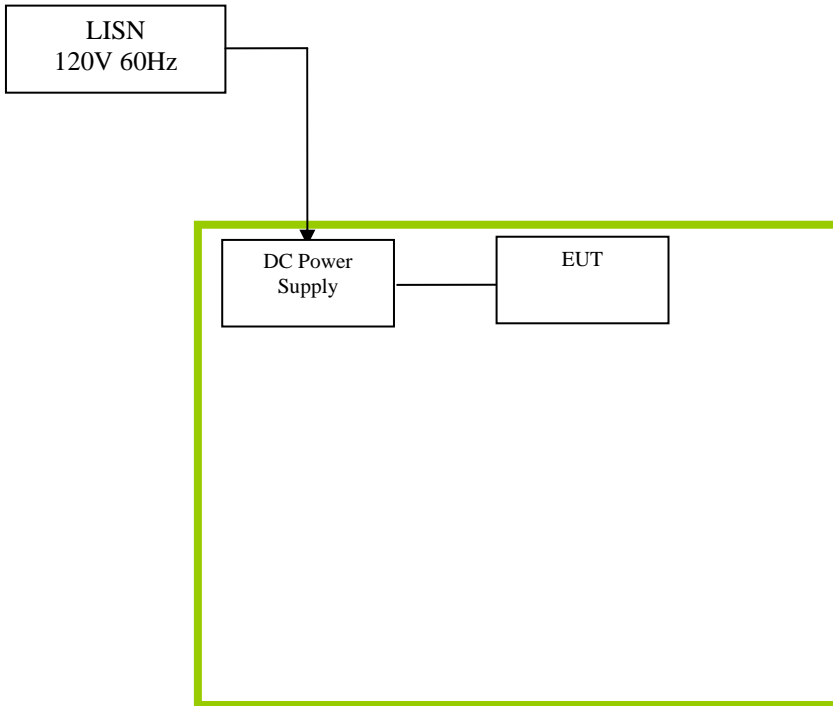



Block Configuration Diagram for Radiated Emissions

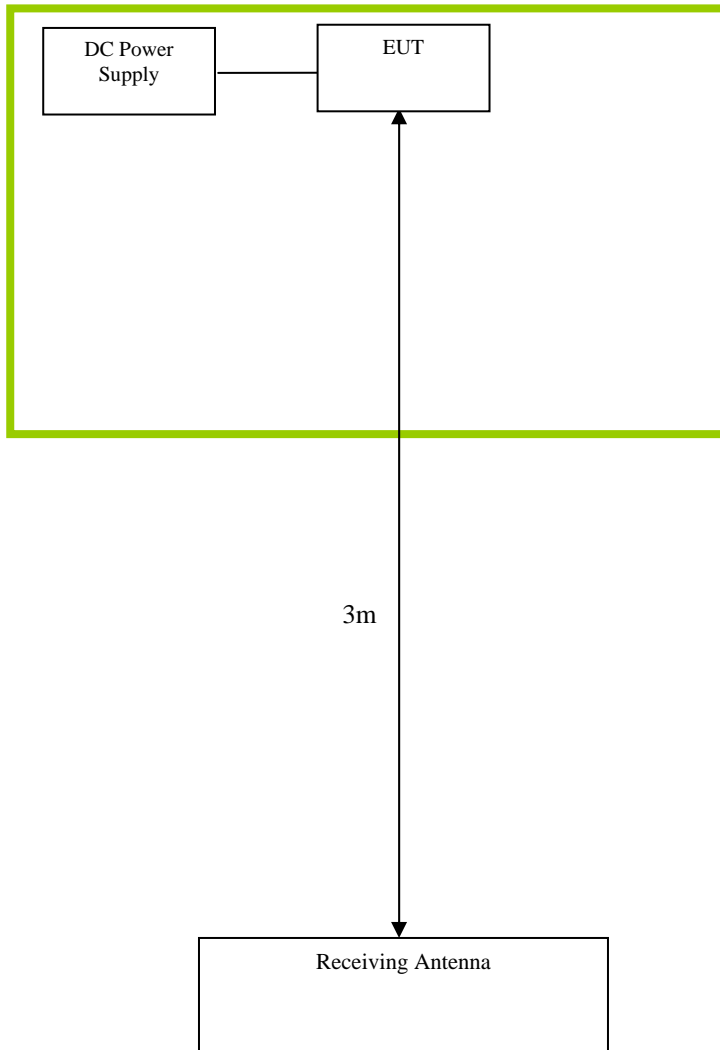



SIEMIC, INC.

Accessing global markets

Title: EMC Test Report for smarfid-232 HID and EM reader
Main Model: EM-1916-N
Serial Model: HR392H-8N
To: FCC Part 15 Subpart C: 2013 , ANSI C63.4:2009

Report No.: 13020916-FCC-E
Issue Date: December 06, 2013
Page: 31 of 33
www.siemic.com.cn

Annex C.ii. EUT OPERATING CONDITIONS

The following is the description of how the EUT is exercised during testing.

Test	Description Of Operation
Emissions	Normal Working



SIEMIC, INC.

Accessing global markets

Title: EMC Test Report for smarfid-232 HID and EM reader
Main Model: EM-1916-N
Serial Model: HR392H-8N
To: FCC Part 15 Subpart C: 2013 , ANSI C63.4:2009

Report No.: 13020916-FCC-E
Issue Date: December 06, 2013
Page: 32 of 33
www.siemic.com.cn

Annex D. USER MANUAL / BLOCK DIAGRAM / SCHEMATICS / PART LIST

Please see attachment



SIEMIC, INC.

Accessing global markets

Title: EMC Test Report for smarfid-232 HID and EM reader
Main Model: EM-1916-N
Serial Model: HR392H-8N
To: FCC Part 15 Subpart C: 2013 , ANSI C63.4:2009

Report No.: 13020916-FCC-E
Issue Date: December 06, 2013
Page: 33 of 33
www.siemic.com.cn

Annex E. DECLARATION OF SIMILARITY

SMARFID

Shanghai Smarfid Security Equipment Co., Ltd.

Add: Room 301, 4th Bldg., No.4 TongLi Road, SongJiang District, Shanghai 201615,
China

Tel: (86-21) 54260103, 54260132 ext.215 Fax: (86-21) 54260132 ext.222

To: SIEMIC (Nan Jing) Info Ltd.

Declaration letter

Dear Sir,

For our business issue and marketing requirement, we would like to list different models numbers on the CE and FCC certificates and reports, as following:

Model No.: EM-1916-N
HR392H-8N

The both models have the same Circuits, components, appearance and color.

The difference between the two models EM-1916-N and EM-1916-N are as follows:
just have different model name.

Thank you!

Signature:

Printed name/title: Linda Yang