



47 CFR PART 22 SUBPART H & 24 SUBPART E

TEST REPORT

Orca USB Dongle Data Card

Model Name: Orca USB Dongle
Trade Name: /
Report No.: SH10070018R01
FCC ID: X2U-ORCA-USBD

prepared for

VIA Telecom, Inc.
3390 Carmel Mountain Road, San Diego, CA 92121-1002, USA



Shenzhen Electronic Product Quality Testing Center
Morlab Laboratory

3/F, Electronic Testing Building, Shahe Road, Xili,
Nanshan District, Shenzhen, 518055 P. R. China

Tel: +86 755 86130398

Fax: +86 755 86130218



CTIA Authorized Test Lab
LAB CODE 20081223-00

NOTE: This test report can be duplicated completely for the legal use with the approval of the applicant, it shall not be reproduced except in full, without the written approval of Shenzhen Morlab Communications Technology Co., Ltd. Any objections should be raised to us within thirty workdays since the date of issue.



TABLE OF CONTENTS

1.	TEST RESULT CERTIFICATION	4
2.	GENERAL INFORMATION	5
2.1	Equipment under Test (EUT) Description	5
2.2	Test Standards and Results.....	6
2.3	Facilities and Accreditations.....	7
2.3.1	Facilities	7
2.3.2	Test Environment Conditions.....	7
2.4	47 CFR Part 2, Part 22H ,Part 24E Requirements.....	8
2.4.1	Conducted Related Tests	8
2.4.2	Radiated Power and Spurious Emission Tests	9
2.4.3	Frequency Stability Test.....	10
2.4.4	Test Mode.....	10
2.5	Frequencies.....	11
2.5.1	Requirement	11
2.5.2	Procedure.....	11
2.5.3	Test Results	12
2.6	Conducted RF Output Power	13
2.6.1	Requirement	13
2.6.2	Test Procedure	13
2.6.3	Test Results	14
2.6.4	Test Plots	15
2.7	Occupied Bandwidth	18
2.7.1	Occupied Bandwidth Definition	18
2.7.2	Test Procedure	18
2.7.3	Test Result.....	19
2.7.4	Test plots	20
2.8	Band-edge	23
2.8.1	Requirement	23
2.8.2	Test Description	23
2.8.3	Test Result.....	23



2.8.4	Test plots	24
2.9	Conducted Spurious Emission.....	26
2.9.1	Requirement	26
2.9.2	Test Procedure	26
2.9.3	Test Results	27
2.9.4	Test Plots	28
2.10	Transmitter Radiated Power (EIRP/ERP).....	31
2.10.1	Requirement	31
2.10.2	Test Procedure	31
2.10.3	Test Result	32
2.10.4	Test plots	33
2.11	Radiated Spurious Emission.....	36
2.11.1	Requirement	36
2.11.2	Test Procedure	36
2.11.3	Test Result and plots	37
2.11.4	Test plots	38
2.12	Frequency Stability	42
2.12.1	Frequency Stability Requirement.....	42
2.12.2	Test Procedure	42
2.12.3	Test results.....	43
3.	TEST EQUIPMENTS	44



1. Test Result Certification

Equipment under Test: Orca USB Dongle Data Card
 Trade Name: /
 Model Name: Orca USB Dongle
 FCC ID: X2U-ORCA-USBD
 Applicant: VIA Telecom, Inc.
 3390 Carmel Mountain Road, San Diego, CA 92121-1002, USA
 Manufacturer: VIA Telecom, Inc.
 3390 Carmel Mountain Road, San Diego, CA 92121-1002, USA
 Test Standards: 47 CFR Part 2
 47 CFR Part 22 Subpart H
 47 CFR Part 24 Subpart E
 Test Data(s): Aug 2, 2010 – Aug 6, 2010
 Test Result: PASS

*** We Hereby Certify That:**

The equipment under test was tested by Shenzhen Morlab Communications Technology Co., Ltd. The test data, data evaluation, test procedures and equipment configurations shown in this report were made in accordance with the requirement of related FCC rules.

The test results of this report only apply for the tested sample equipment identified above. The test report shall be invalid without all the signatures of the test engineer, the reviewer and the approver.

Tested by: Zhang Wenjie Dated: 2010.8.16
 Zhang Wenjie
 Reviewed by: Zhang Jun Dated: 2010.8.16
 Zhang Jun
 Approved by: Wei Bei Dated: 2010.8.16
 Wei Bei



2. General Information

2.1 Equipment under Test (EUT) Description

EUT Type..... :	Orca USB Dongle Data Card
Brand Name..... :	/
Model Name..... :	Orca USB Dongle
Frequency Range..... :	CDMA2000 Cellular: Tx: 824 MHz ~ 849 MHz; Rx: 869 MHz ~ 894 MHz CDMA2000 PCS: Tx: 1850 MHz ~1910 MHz; Rx: 1930 MHz ~ 1990 MHz
Max ERP/EIRP Power..... :	CDMA2000 Cellular:0.22233W for 1x RTT RC1/SO55 CDMA2000 PCS:0.23988W for 1x RTT RC1/SO55
Modulation Type..... :	OQPSK
Emission Designators..... :	1M25F9W
Hardware Version..... :	P3
Software Version..... :	8.5.16.35
Manufacturer..... :	VIA Telecom, Inc. 3390 Carmel Mountain Road, San Diego, CA 92121-1002, USA
Factory..... :	Hangzhou Manko Technology CO.,LTD. No. 77 ChunChao Road, XiaoShan Economic Development Zone, Hangzhou, Zhejiang

NOTE:

1. The EUT is a CDMA2000 1x RTT USB Dongle operating in Cellular 800MHz band and PCS1900MHz band.
2. The normal configuration for the EUT is connected with the PC via the USB port.
3. For a more detailed description, please refer to Specification or User's Manual supplied by the applicant and/or manufacturer.



2.2 Test Standards and Results

The objective of the report is to perform tests according to 47 CFR Part 2, Part 22 and Part 24 for FCC ID Certification:

No.	Identity	Document Title
1	47 CFR Part 2 (10-1-05 Edition)	Frequency Allocations and Radio Treaty Matters; General Rules and Regulations
2	47 CFR Part 22 (10-1-05 Edition)	Public Mobile Services
3	47 CFR Part 24 (10-1-05 Edition)	Personal Communications Services
4	ANSI/TIA/EIA-603-C (2004)	Land Mobile FM or PM - Communications Equipment - Measurement and Performance Standards
5	ANSI C63.4-2003	American National Standard for Methods of Measurement of Radio-Noise Emissions from Low-Voltage Electrical and Electronic Equipment in the Range of 9 kHz to 40 GHz

Test detailed items and the results are as below:

No.	Rules	Test Type	Result	Date of Test
1	§2.106 §22.905 24.229	Frequencies	PASS	08.02
2	§2.1046	Conducted RF Output Power	PASS	08.02
3	§2.1049	Occupied Bandwidth	PASS	08.02
4	§2.1057 §22.917 §24.238	Band Edge	PASS	08.02
5	§2.1051 §2.1057 §22.917	Conducted Spurious Emission at Antenna Terminal	PASS	08.02
6	§22.913 §24.232	Transmitter Radiated Power (EIPR/ERP)	PASS	08.06
7	§2.1053 §2.1057 §22.917	Radiated Spurious Emission	PASS	08.05
8	§2.1055 §22.355	Frequency Stability	PASS	08.04

2.3 Facilities and Accreditations

2.3.1 Facilities

Shenzhen Electronic Product Quality Testing Center Morlab Laboratory is a testing organization accredited by China National Accreditation Board for Laboratories (CNAS) according to ISO/IEC 17025. The accreditation certificate number is L1659.

All measurement facilities used to collect the measurement data are located at Electronic Testing Building, Shahe Road, Xili, Nanshan District, Shenzhen 518055 CHINA. The test site is constructed in conformance with the requirements of ANSI C63.7, ANSI C63.4 and CISPR Publication 22; the FCC registration number is 741109.

2.3.2 Test Environment Conditions

During the measurement, the environmental conditions were within the listed ranges:

Temperature:	20 - 25°C
Relative Humidity:	40 - 50%
Atmospheric Pressure:	96kPa

2.4 47 CFR Part 2, Part 22H ,Part 24E Requirements

2.4.1 Conducted Related Tests

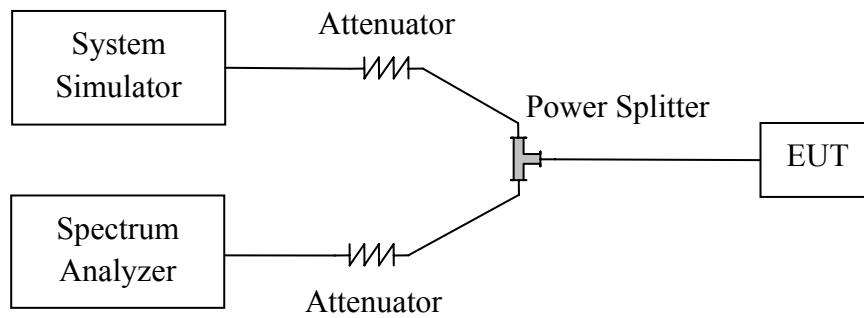

1. The EUT is coupled to the Spectrum Analyzer and the System Simulator with the suitable Attenuators through the Power Splitter; the path loss is calibrated to correct the reading.
2. The EUT is configured here as EUT + PC.
3. The EUT is commanded via the System Simulator (SS) to operate at the maximum output power . A communication link is established between the EUT and the SS.
4. The Spectrum Analyzer is set to max-peak detector function and maximum hold mode.

2.4.2 Radiated Power and Spurious Emission Tests

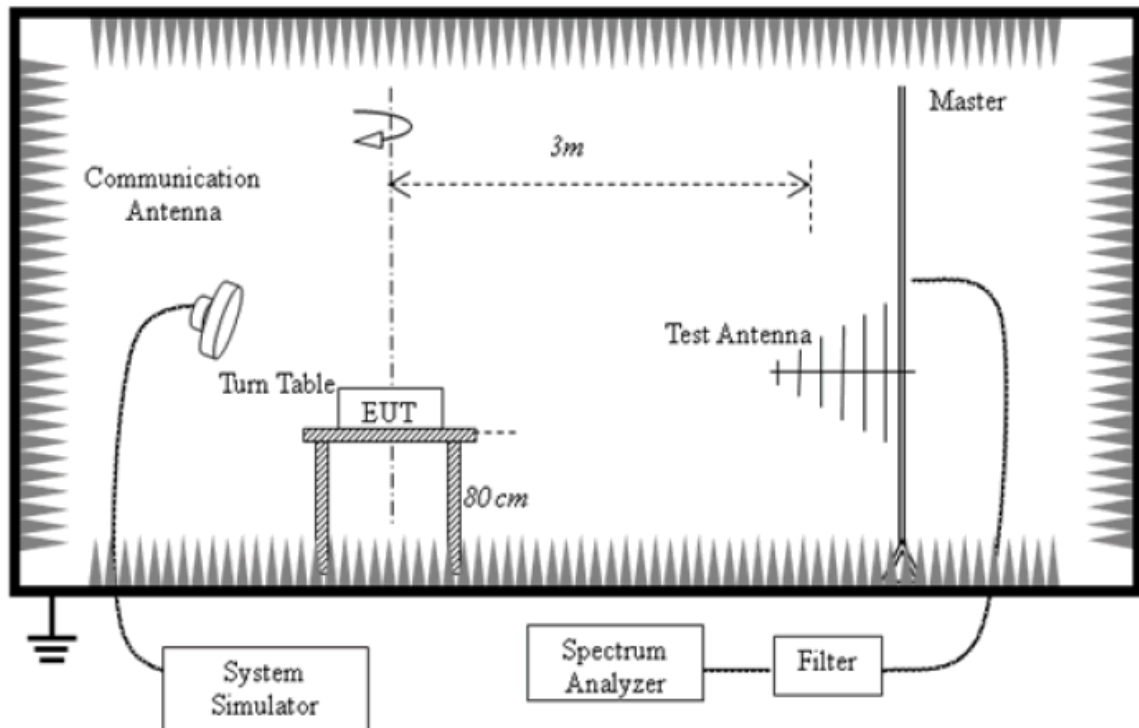

1. The test is performed in a full-Anechoic Chamber; the air loss of the site and the factors of the test system are pre-calibrated using the substitution method.
2. The EUT is configured as EUT + PC.
3. The EUT is placed on the vertical axis of a Turn Table 0.8 meters above the ground.
4. The Test Antenna is a bi-log one or a horn one, and the Test Antenna is at the same height as the EUT.
5. The EUT is commanded via the System Simulator (SS) to operate at the maximum output power. A communication link is established between the EUT and the SS.
6. The Spectrum Analyzer is set to max-peak detector function and maximum hold mode.

2.4.3 Frequency Stability Test

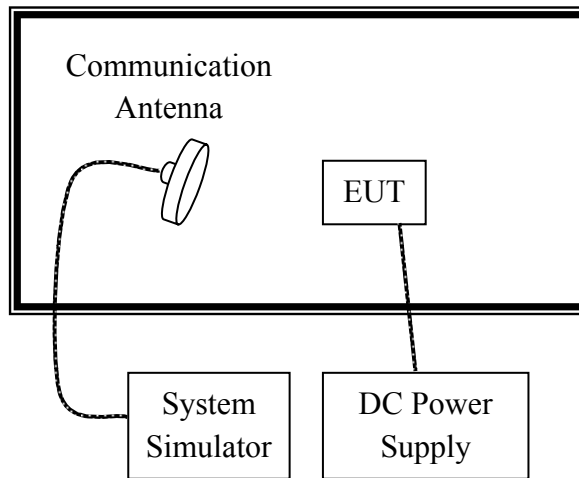

1. The test is performed in a Temperature Chamber.
2. The EUT is configured as MS + DC Power Supply.

2.4.4 Test Mode

During all testing, EUT is in link mode with base station emulator at maximum power level. The spurious emission measurements were carried out in semi-anechoic chamber with 3-meter test range, and EUT is rotated on three test planes to find out the worst emission.

Frequency range investigated for radiated emission is as follows:

1. 30 MHz to 10000 MHz for CDMA2000 Cellular
2. 30MHz to 20000 MHz for CDMA2000 PCS.

Test Modes		
Band	Radiated Test	Conducted Test
CDMA2000 Cellular	<ul style="list-style-type: none"> ■ 1xRTT Link Mode_CH1013 ■ 1xRTT Link Mode_CH384 ■ 1xRTT Link Mode_CH777 	<ul style="list-style-type: none"> ■ 1xRTT Link Mode_CH1013 ■ 1xRTT Link Mode_CH384 ■ 1xRTT Link Mode_CH777
CDMA2000 PCS	<ul style="list-style-type: none"> ■ 1xRTT Link Mode_CH25 ■ 1xRTT Link Mode_CH600 ■ 1xRTT Link Mode_CH1175 	<ul style="list-style-type: none"> ■ 1xRTT Link Mode_CH25 ■ 1xRTT Link Mode_CH600 ■ 1xRTT Link Mode_CH1175

Note:

1. For CDMA2000 Cellular, the maximum RF output power mode is 1xRTT RC1/SO55 which was used for ERP and RSE testing.
2. For CDMA2000 PCS, the maximum RF output power mode is 1xRTT RC1/SO55 which was used for EIRP and RSE testing.

2.5 Frequencies

2.5.1 Requirement

According to FCC §22.905, the frequencies blocks assignment for the Cellular Radio telephone Service are listed as below.

- (a) Channel Block A:
 - Mobile 824 - 835MHz, Base 869 - 880MHz;
 - Mobile 845 - 846.5MHz, Base 890 - 891.5MHz
- (b) Channel Block B:
 - Mobile 835 - 845 MHz, Base 880 - 890MHz;
 - Mobile 846.5 - 849 MHz, Base 891.5 - 894MHz

According to FCC section 24.229, the frequencies available in the Broadband PCS services are listed as below, in accordance with the frequency allocations table of FCC section 2.106.

- (a) The following frequency blocks are available for assignment on an MTA basis:
 - Block A: 1850 - 1865MHz paired with 1930 - 1945MHz;
 - Block B: 1870 - 1885MHz paired with 1950 - 1965MHz.
- (b) The following frequency blocks are available for assignment on a BTA basis:
 - Block C: 1895 - 1910 MHz paired with 1975 - 1990MHz;
 - Block D: 1865 - 1870 MHz paired with 1945 - 1950MHz;
 - Block E: 1885 - 1890 MHz paired with 1965 - 1970MHz;
 - Block F: 1890 - 1895 MHz paired with 1970 - 1975MHz.

2.5.2 Procedure

1. Perform test system setup as section 2.4.1.
2. The resolution bandwidth (RBW) of the Spectrum Analyzer was set to at least 1% of the emission bandwidth of the fundamental emission of the transmitter, e.g. for GSM modulated signal (here used): $RBW=VBW=3kHz$, for CDMA modulated signal: $RBW=VBW=30kHz$.
3. The lowest and the highest channel were selected to perform tests respectively. Channel No.1013(lowest) and 777(highest) for cellular band; Channel No.25(lowest) and 1175(highest) for PCS band;
4. The MS operated at the maximum output power. Set the Spectrum Analyzer suitably to capture the waveform, search peak and mark, and then record the plot.



2.5.3 Test Results

Test Mode	Channel	Frequency (MHz)	Result
CDMA 2000 1xRTT	1013 (Low)	824.70	PASS
	777 (High)	848.31	PASS
Test Mode	Channel	Frequency (MHz)	Result
CDMA 2000 1xRTT	25(Low)	1851.25	PASS
	1175(High)	1908.75	PASS

Note:

The frequencies of the lowest channel and the highest channel are measured.

2.6 Conducted RF Output Power

2.6.1 Requirement

According to FCC §2.1046 (a), for transmitters other than single sideband, independent sideband and controlled carrier radiotelephone, power output shall be measured at the RF output terminals when the transmitter is adjusted in accordance with the tune-up procedure to give the values of current and voltage on the circuit elements specified in §2.1033 (c)(8). The electrical characteristics of the radio frequency load attached to the output terminals when this test is made shall be stated.

2.6.2 Test Procedure

1. Perform test system setup as section 2.4.1 (the radio frequency load attached to the EUT antenna terminal is 50Ω).
2. The resolution bandwidth of the Spectrum Analyzer is set to be comparable to the emission bandwidth of the transmitter, e.g. for GSM modulated signal (here used): RBW=VBW=1MHz, for CDMA modulated signal: RBW=VBW=3MHz.
3. The lowest and the highest channel were selected to perform tests respectively. Channel No.1013(lowest) 384(middle)and 777(highest) for cellular band; Channel No.25(lowest) 600 (middle)and 1175(highest) for PCS band.
4. Set the frequency range of the Spectrum Analyzer suitably to capture the waveform; search peak and mark it; finally record the peak and the plot.

2.6.3 Test Results

CDMA2000 Cellular						
Test Mode	Test Status	Channel	Frequency (MHz)	Conducted power(dBm)	Conducted power(watts)	
CDMA 2000 1xRTT	RC1/SO2	1013 (Low)	824.70	23.21	0.20941	
		384 (Mid)	836.52	23.53	0.22542	
		777 (High)	848.31	23.18	0.20797	
	RC1/SO55	1013 (Low)	824.70	23.34	23.65	0.21577
		384 (Mid)	836.52	23.65	0.23174	0.22131
		777 (High)	848.31	23.45	0.22131	
	RC3/SO2	1013 (Low)	824.70	23.26	0.21184	0.21184
		384 (Mid)	836.52	23.35	0.21627	0.21627
		777 (High)	848.31	23.34	0.21577	0.21577
	RC3/SO55	1013 (Low)	824.70	23.24	0.21086	0.21086
		384 (Mid)	836.52	23.40	0.21878	0.21878
		777 (High)	848.31	23.33	0.21528	0.21528
CDMA2000 PCS						
Test Mode	Test Status	Channel	Frequency (MHz)	Conducted power(dBm)	Conducted power(watts)	
CDMA 2000 1xRTT	RC1/SO2	25 (Low)	1851.25	24.11	0.25763	
		600 (Mid)	1880.00	23.00	0.19953	
		1175 (High)	1908.75	22.75	0.18836	
	RC1/SO55	25 (Low)	1851.25	24.16	0.26062	0.19999
		600 (Mid)	1880.00	23.01	0.19999	0.19999
		1175 (High)	1908.75	22.81	0.19099	0.19099
	RC3/SO2	25 (Low)	1851.25	23.98	0.25003	0.25003
		600 (Mid)	1880.00	22.96	0.19770	0.19770
		1175 (High)	1908.75	22.74	0.18793	0.18793
	RC3/SO55	25 (Low)	1851.25	23.99	0.25061	0.25061
		600 (Mid)	1880.00	22.93	0.19634	0.19634
		1175 (High)	1908.75	22.65	0.18408	0.18408

Note:

This report only show the worst results with plots of Cellular CDMA2000 1x RTT RC1/SO55 mode and PCS CDMA2000 1x RTT RC1/SO55 mode.

2.6.4 Test Plots

1 Cellular CDMA2000 1x RTT RC1/SO55 Channel 1013

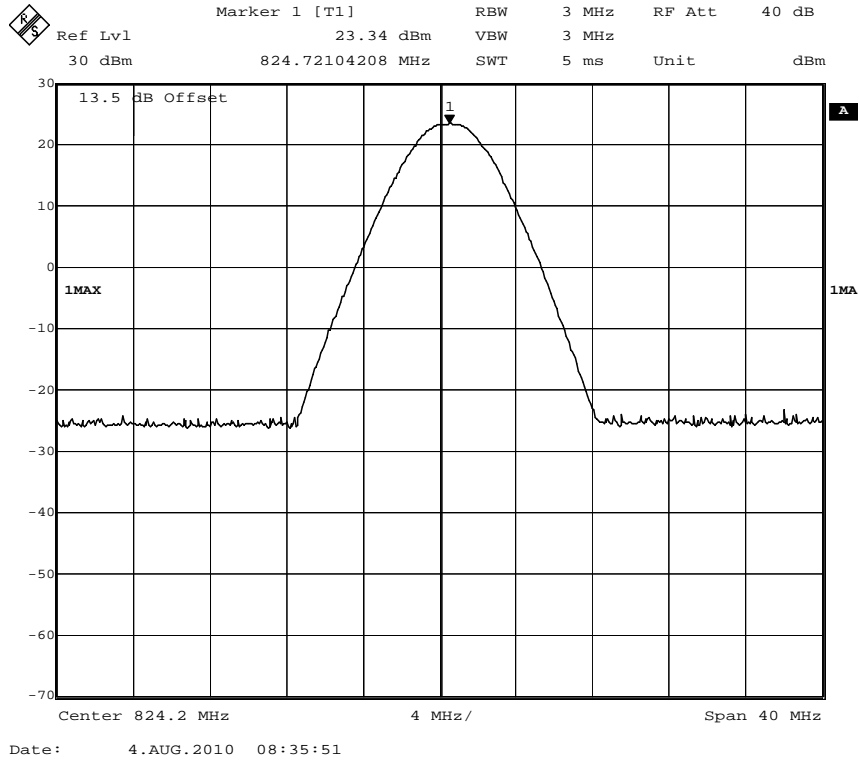

2 Cellular CDMA2000 1x RTT RC1/SO55 Channel 384

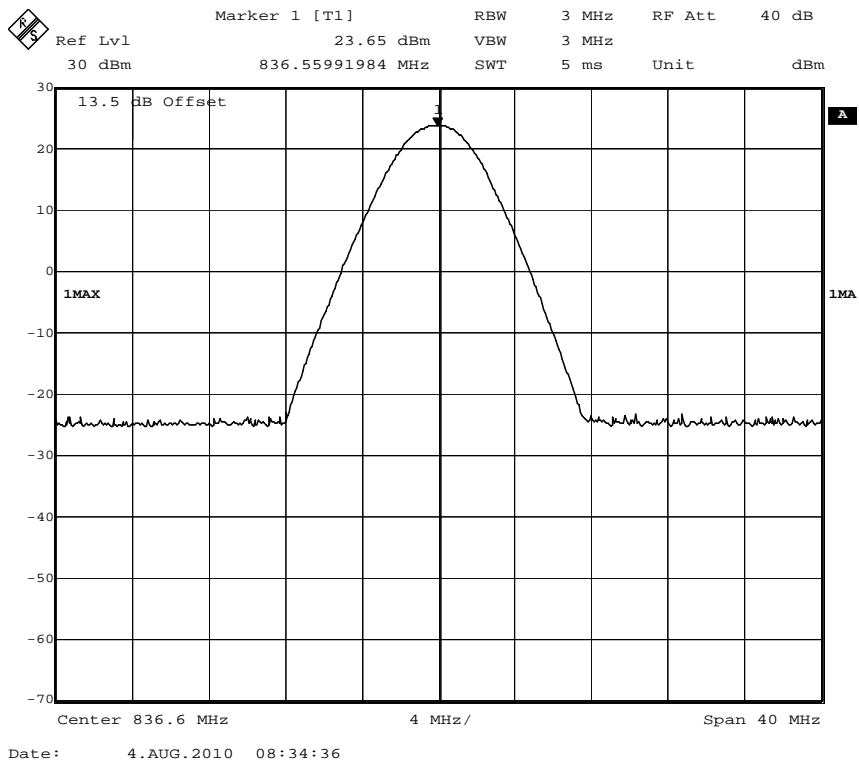

3 Cellular CDMA2000 1x RTT RC1/SO55 Channel 777

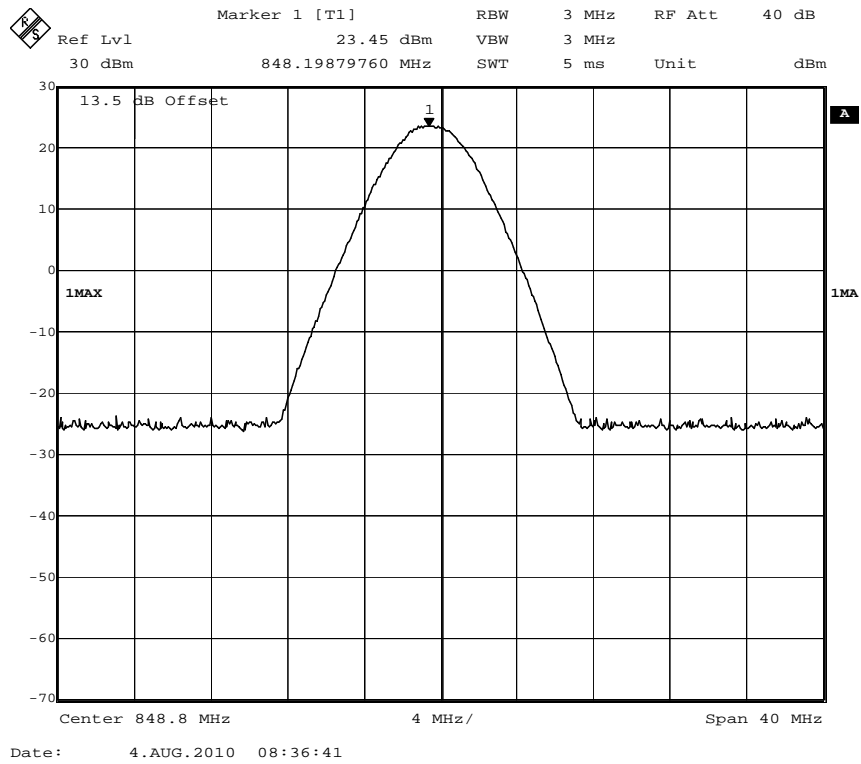

4 PCS CDMA2000 1x RTT RC1/SO55 Channel 25

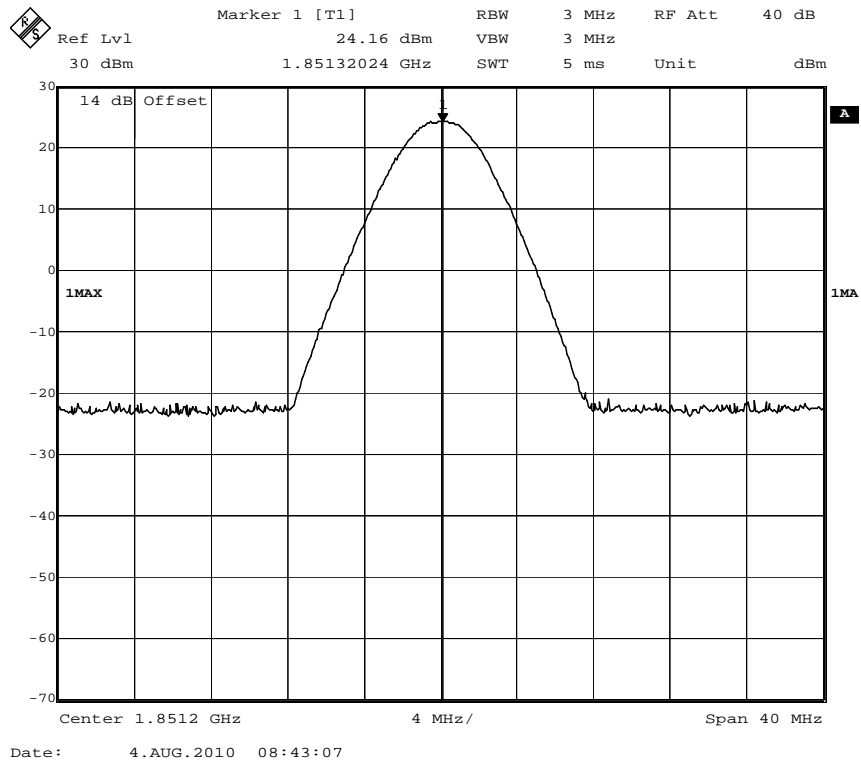

5 PCS CDMA2000 1x RTT RC1/SO55 Channel 600

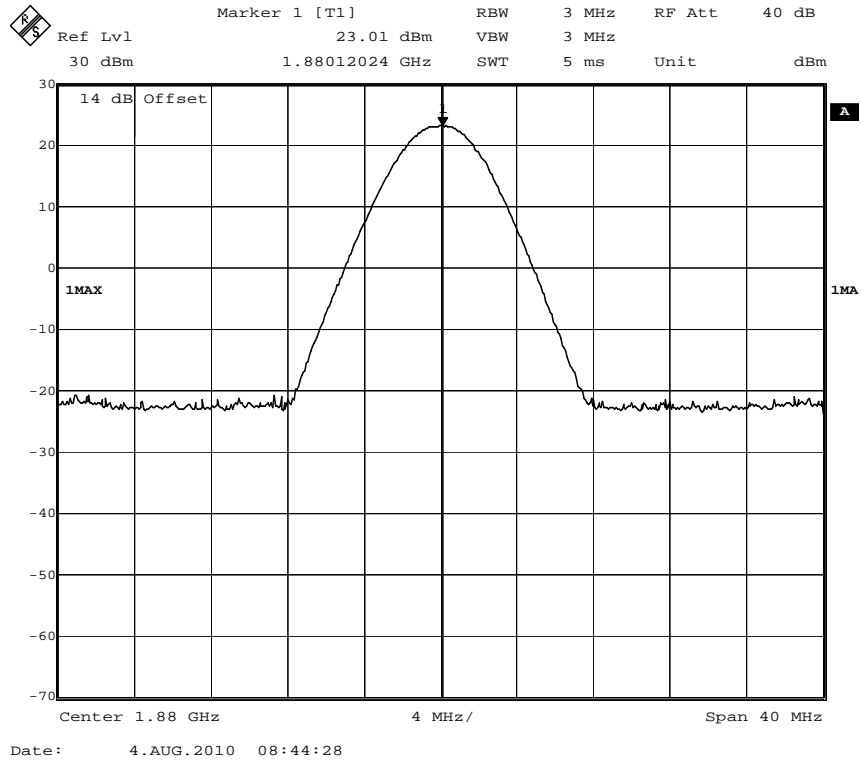

6 PCS CDMA2000 1x RTT RC1/SO55 Channel 1175

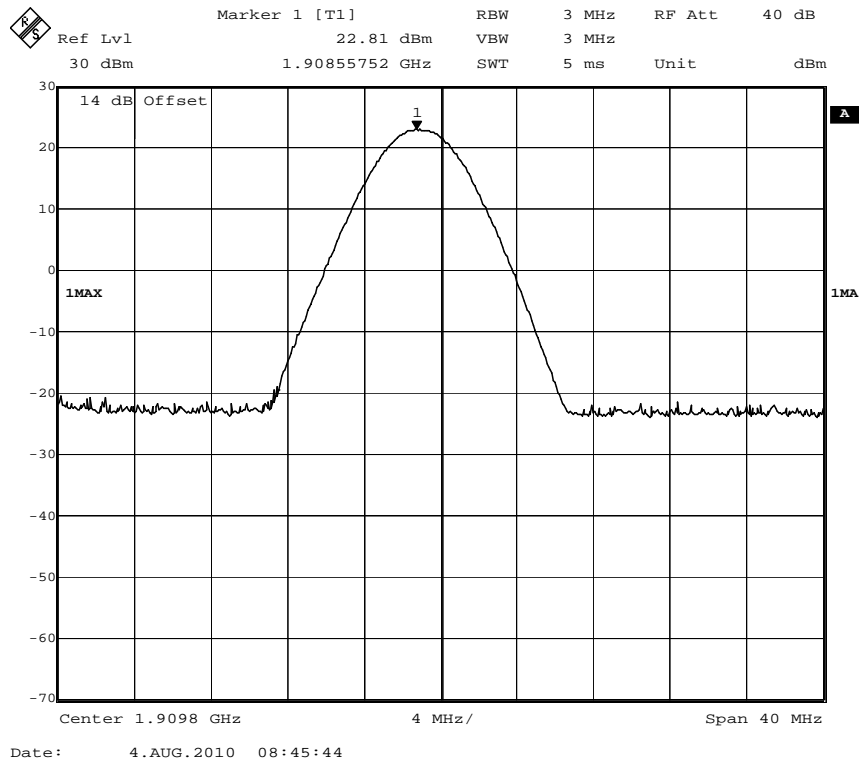

2.7 Occupied Bandwidth

2.7.1 Occupied Bandwidth Definition

According to FCC §2.1049, the occupied bandwidth is the frequency bandwidth such that, below its lower and above its upper frequency limits, the mean powers radiated are each equal to 0.5 percent of the total mean power radiated by a given emission.

Occupied bandwidth is also known as the 99% emission bandwidth. The emission bandwidth is defined as the width of the signal between two points, one below the carrier center frequency and one above the carrier center frequency, outside of which all emissions are attenuated at least 26dB below the transmitter power.

2.7.2 Test Procedure

- 1 Perform test system setup as section 2.4.1 (the radio frequency load attached to the EUT antenna terminal is 50Ω).
- 2 The resolution bandwidth of the Spectrum Analyzer is set to be comparable to the emission bandwidth of the transmitter, for CDMA modulated signal: $RBW=VBW=30KHz$.
- 3 The lowest and the highest channel were selected to perform tests respectively. Channel No.1013(lowest) 384(middle)and 777(highest) for cellular band;. Channel No.25(lowest) 600 (middle)and 1175(highest) for PCS band.
- 4 Set the frequency range of the Spectrum Analyzer suitably to capture the waveform; search peak and mark it; finally record the peak and the plot.

2.7.3 Test Result

CDMA2000 Cellular				
Test Mode	Channel	Measured Bandwidth (MHz)	Result	Plots
CDMA 2000 1xRTT	1013 (Low)	1.3947	Pass	1
	384 (Mid)	1.3887	Pass	2
	777 (High)	1.3827	Pass	3
CDMA2000 PCS				
Test Mode	Channel	Measured Bandwidth (MHz)	Result	Plots
CDMA 2000 1xRTT	25 (Low)	1.3887	Pass	4
	600 (Mid)	1.4068	Pass	5
	1175 (High)	1.4008	Pass	6

2.7.4 Test plots

1 Cellular CDMA2000 1x RTT RC1/SO55 Channel 1013

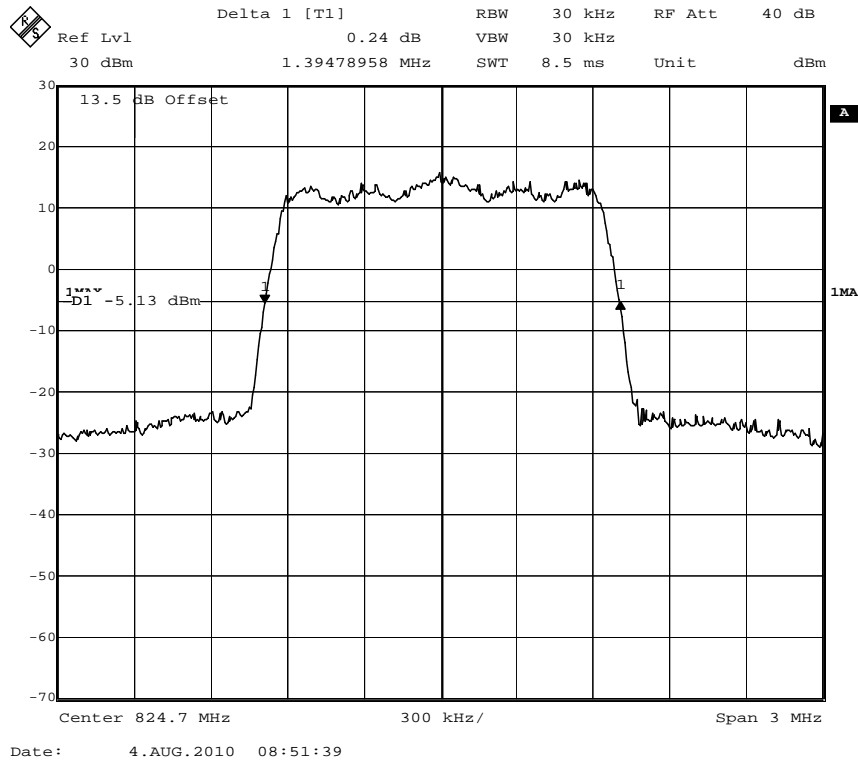

2 Cellular CDMA2000 1x RTT RC1/SO55 Channel 384

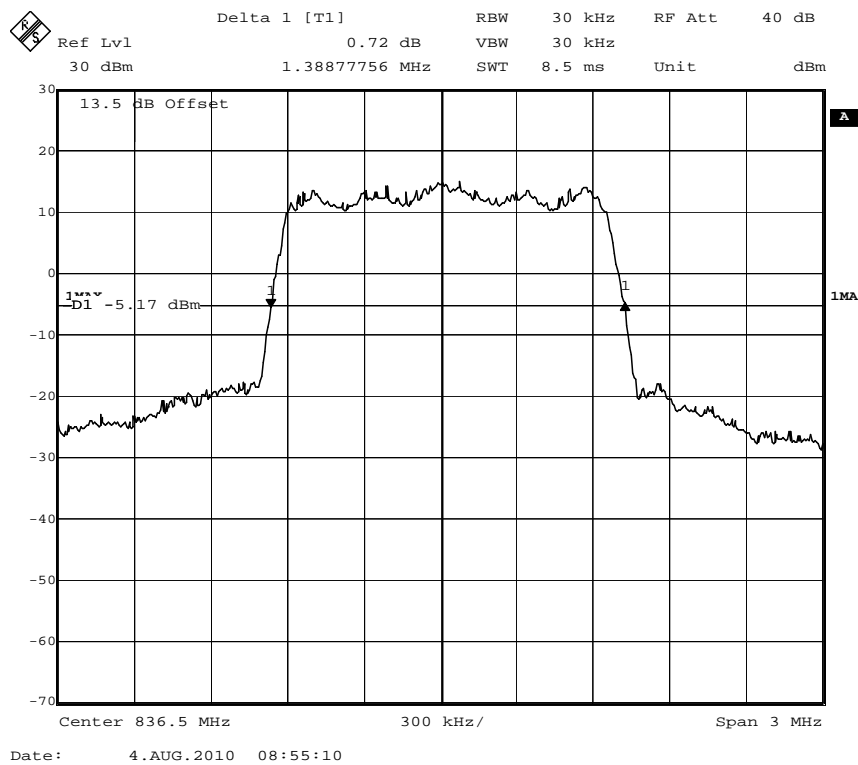

3 Cellular CDMA2000 1x RTT RC1/SO55 Channel 777

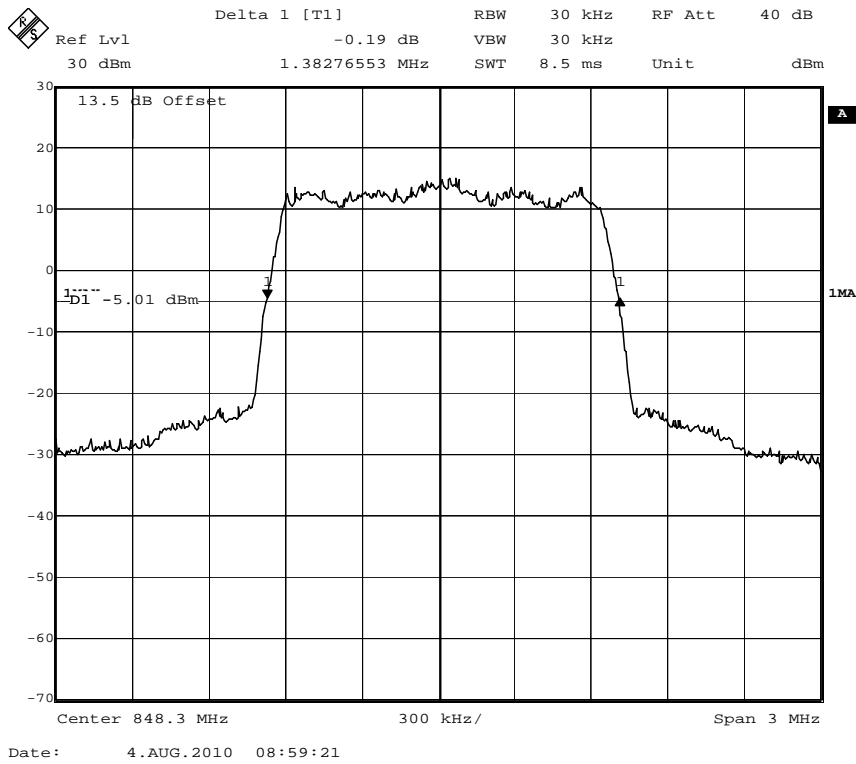

4 PCS CDMA2000 1x RTT RC1/SO55 Channel 25

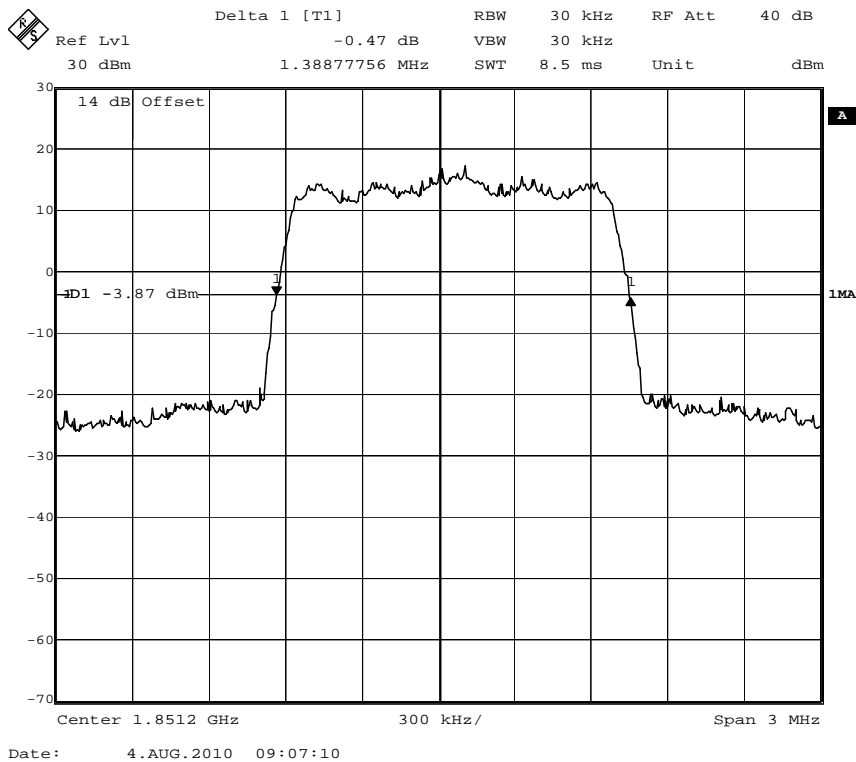

5 PCS CDMA2000 1x RTT RC1/SO55 Channel 600

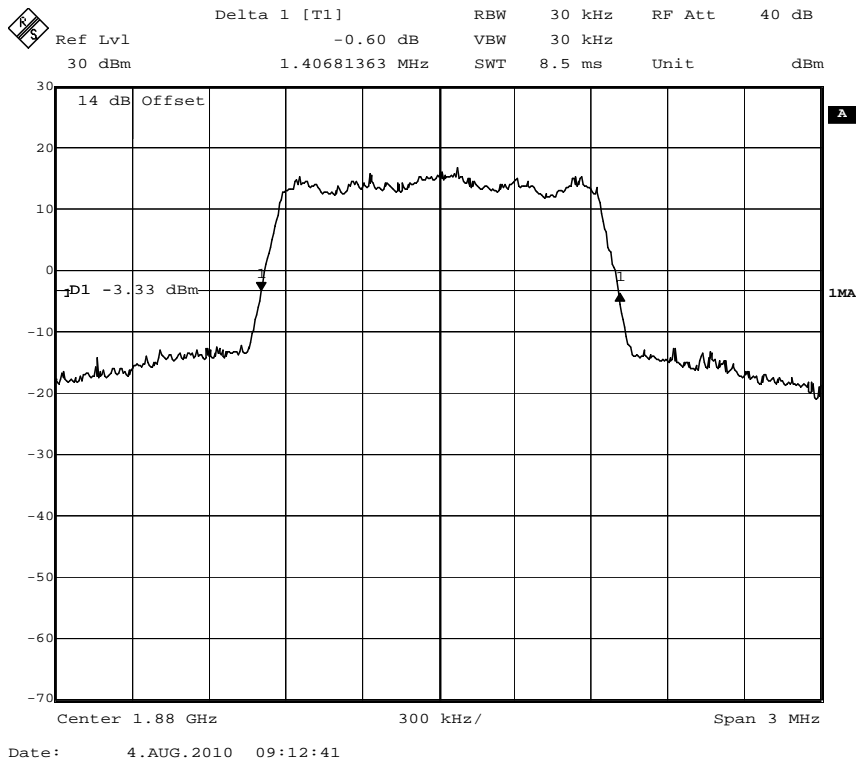

6 PCS CDMA2000 1x RTT RC1/SO55 Channel 1175

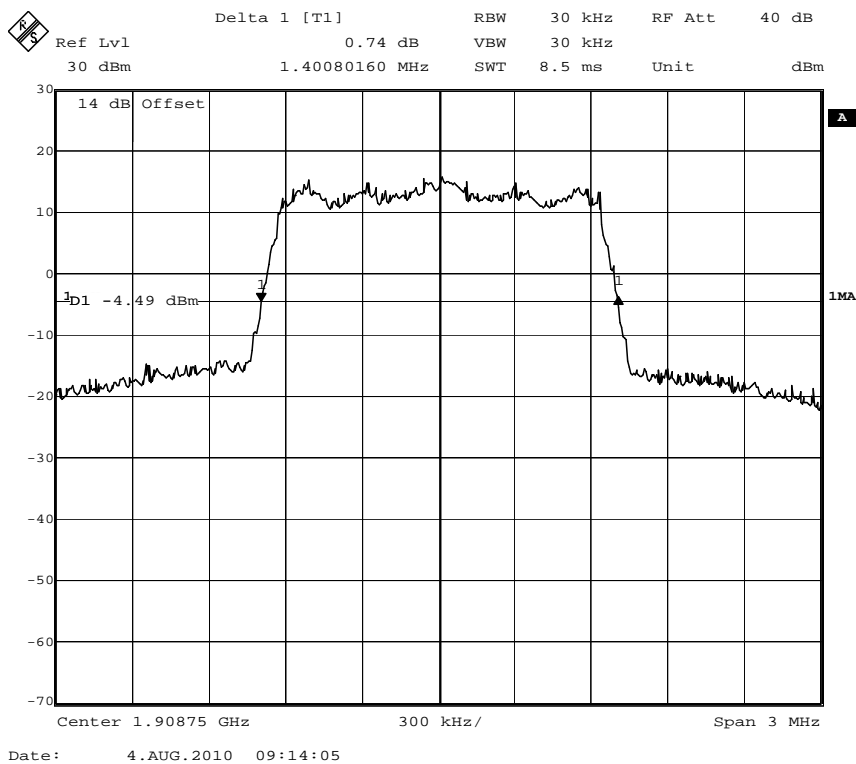



2.8 Band-edge

2.8.1 Requirement

According to FCC section 22.717(b) and FCC section 24.235(b), in the 1MHz bands immediately outside and adjacent to the frequency block a resolution bandwidth of at least one percent of the emission bandwidth (26dB emission bandwidth) of the fundamental emission of the transmitter may be employed.

2.8.2 Test Description

See section 2.4.1 of this report.

2.8.3 Test Result

The lowest and highest channels are tested to verify the band edge emissions.

CDMA2000 Cellular				
Test Mode	Channel	Frequency(MHz)	Result	Plots
CDMA 2000 1xRTT	1013 (Low)	824.70	Pass	1
	777 (High)	848.31	Pass	2
CDMA2000 PCS				
Test Mode	Channel	Frequency(MHz)	Result	Plots
CDMA 2000 1xRTT	25(Low)	1851.25	Pass	3
	1175(High)	1908.75	Pass	4

2.8.4 Test plots

1 Cellular CDMA2000 1x RTT RC1/SO55 Channel 1013

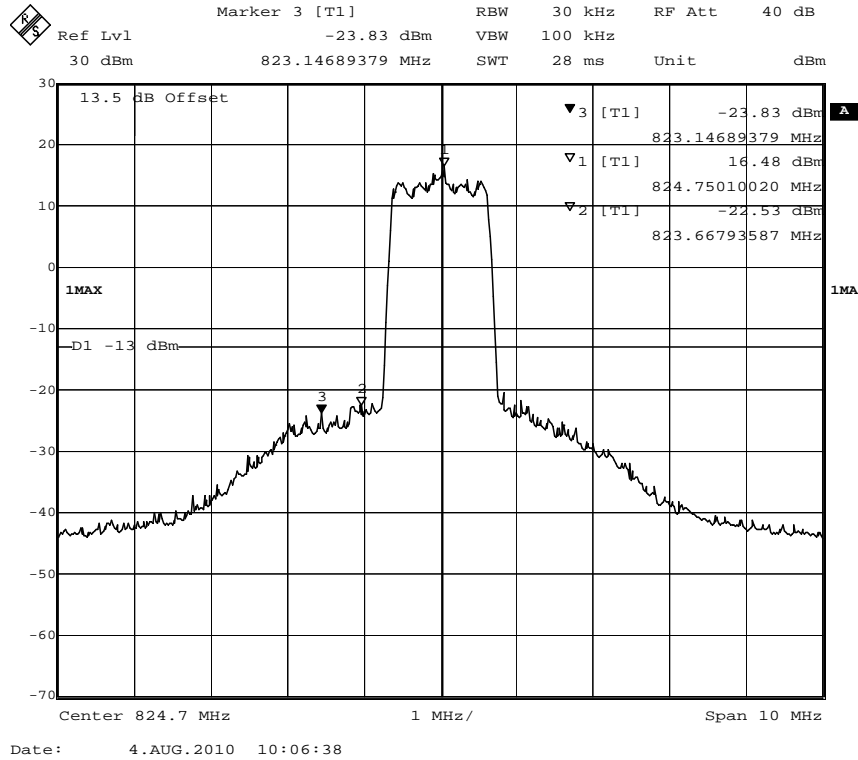

2 Cellular CDMA2000 1x RTT RC1/SO55 Channel 777

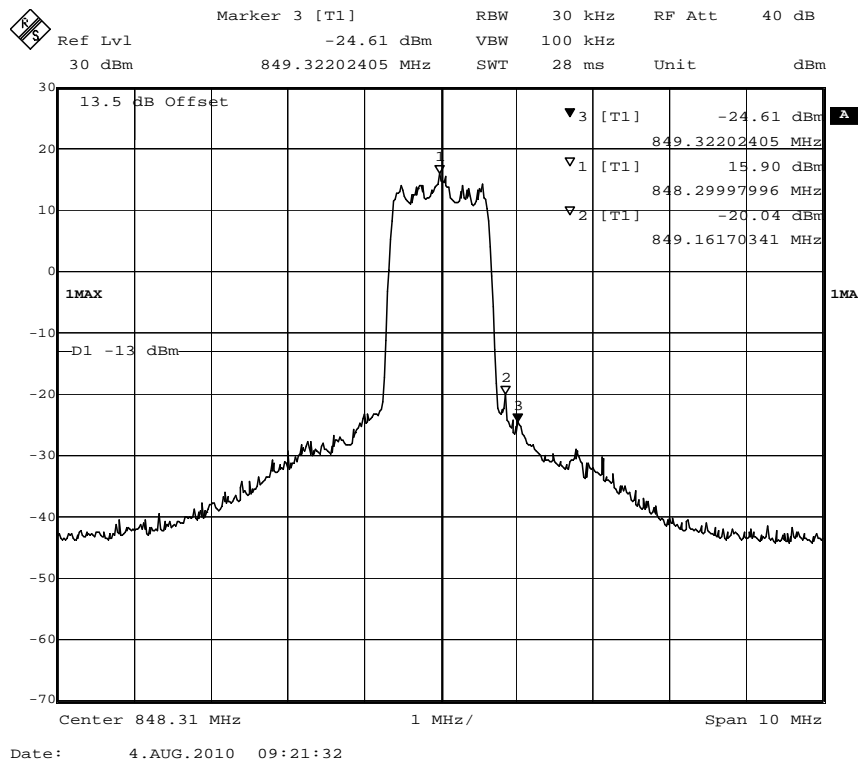



3 PCS CDMA2000 1x RTT RC1/SO55 Channel 25

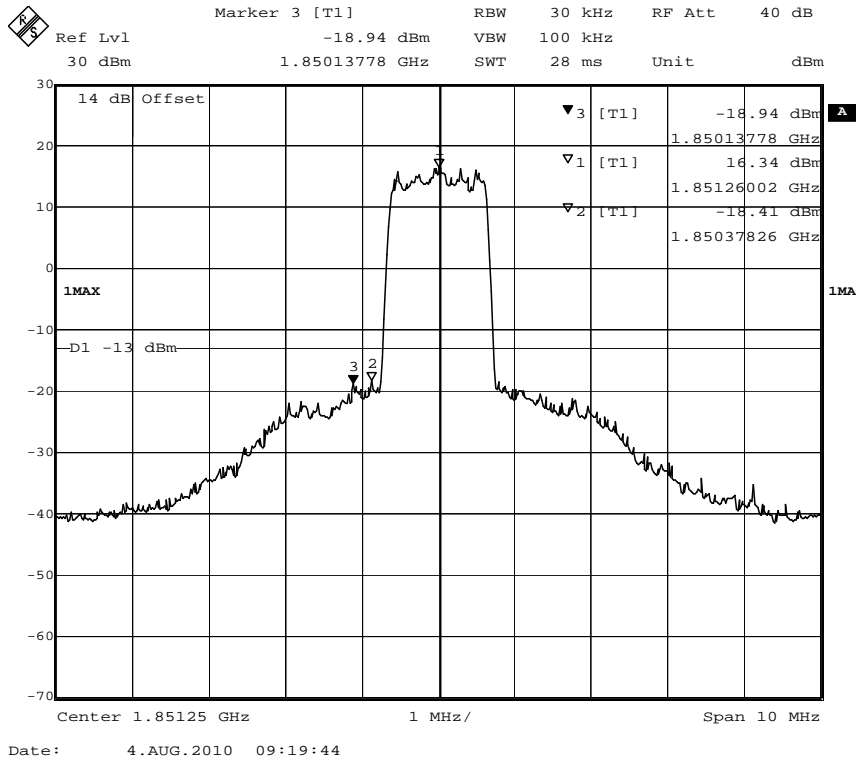

4 PCS CDMA2000 1x RTT RC1/SO55 Channel 1175

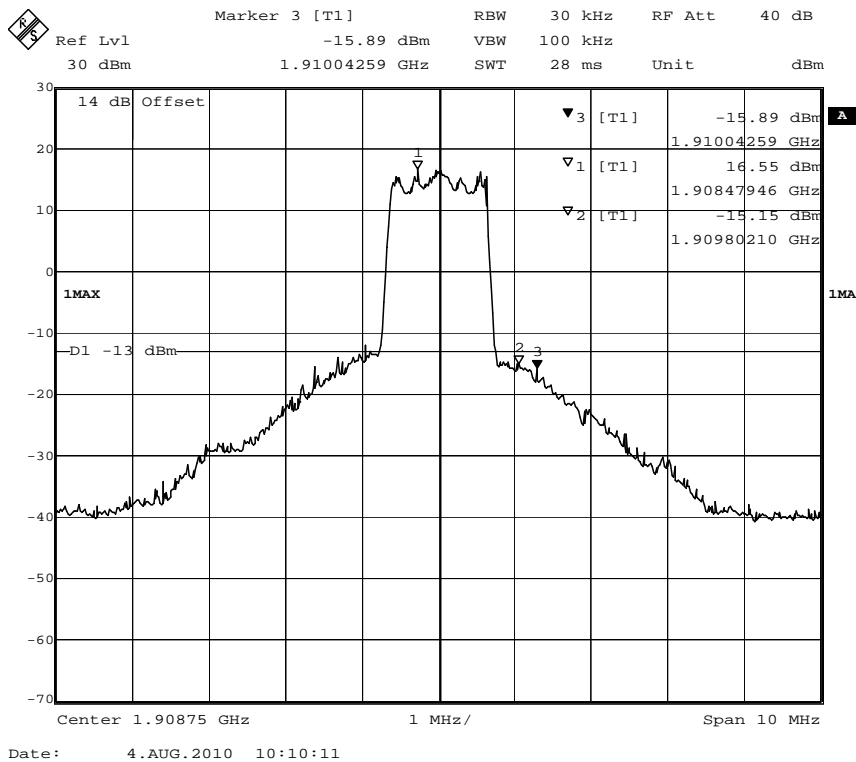

2.9 Conducted Spurious Emission

2.9.1 Requirement

According to FCC §22.917(a) and §24.238(a), the power of any emission outside of the authorized operating frequency ranges must be attenuated below the transmitting power (P) by a factor of at least $43+10*\log(P)$ dB. This calculated to be -13dBm.

According to FCC §22.917 (b) and §24.238(b), in the 1MHz bands immediately outside and adjacent to the frequency block a resolution bandwidth of at least one percent of the emission bandwidth of the fundamental emission of the transmitter may be employed. Thus the 26dB emission bandwidth is measurement for showing compliance at the band-edge.

2.9.2 Test Procedure

1. Perform test system setup as section 2.4.1.
2. Make a limit line whose value is -13dBm on the Spectrum Analyzer.
3. The lowest and the highest channel were selected to perform tests respectively. Channel No.1013(lowest) 384(middle)and 777(highest) for cellular band; Channel No.25(lowest) 600 (middle)and 1175(highest) for PCS band.
4. Set the RBW of the Spectrum Analyzer to 1MHz, and the measuring frequency range from 9kHz to 10th harmonic of the fundamental frequency (here used 26.5GHz); mark the fundamental frequency and the harmonics thereof; finally record the harmonics and the plot. Note, the measuring frequency range can be divided into several parts to perform tests.
5. In the 1MHz bands immediately outside and adjacent to the frequency black, the RBW of the Spectrum Analyzer was set to at least one percent of the emission bandwidth of the fundamental emission of the transmitter, e.g. for GSM modulated signal (here used): RBW=3kHz, for CDMA modulated signal: RBW=1MHz.
6. Set the frequency range of the Spectrum Analyzer suitably to capture the waveform; search peak and mark it; finally record the peak and the plot.



2.9.3 Test Results

CDMA2000 Cellular				
Test Mode	Channel	Measured Max. Spurious Emission (dBm)	Result	Plots
CDMA 2000 1xRTT	1013 (Low)	-37.24	Pass	1
	384 (Mid)	-36.47	Pass	2
	777 (High)	-36.53	Pass	3
CDMA2000 PCS				
Test Mode	Channel	Measured Max. Spurious Emission (dBm)	Result	Plots
CDMA 2000 1xRTT	25(Low)	-29.98	Pass	4
	600 (Mid)	-30.66	Pass	5
	1175(High)	-29.04	Pass	6

2.9.4 Test Plots

1 Cellular CDMA2000 1x RTT RC1/SO55 Channel 1013

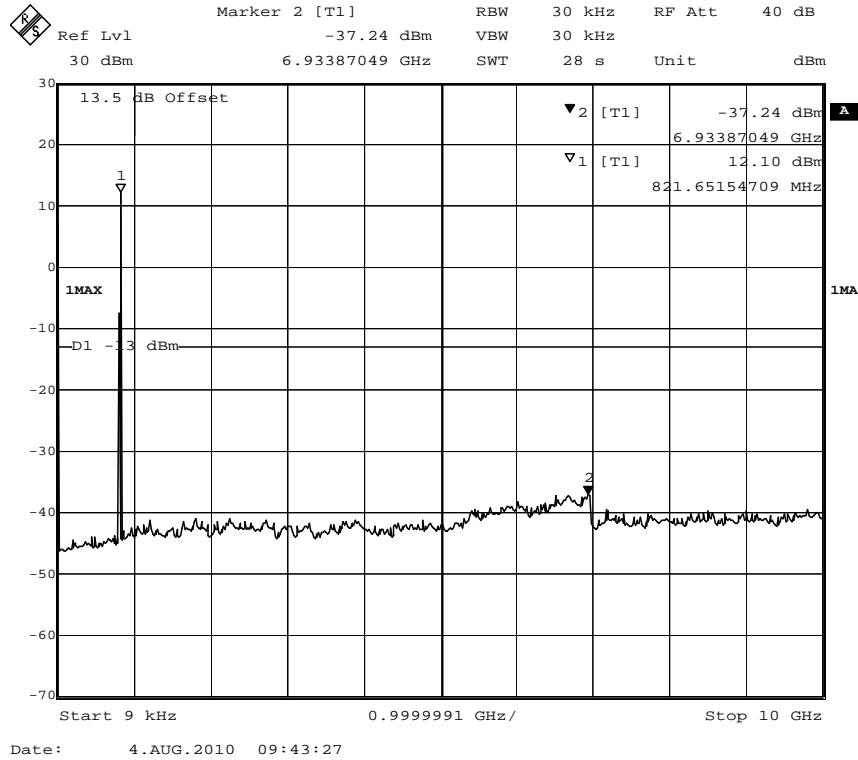

2 Cellular CDMA2000 1x RTT RC1/SO55 Channel 384

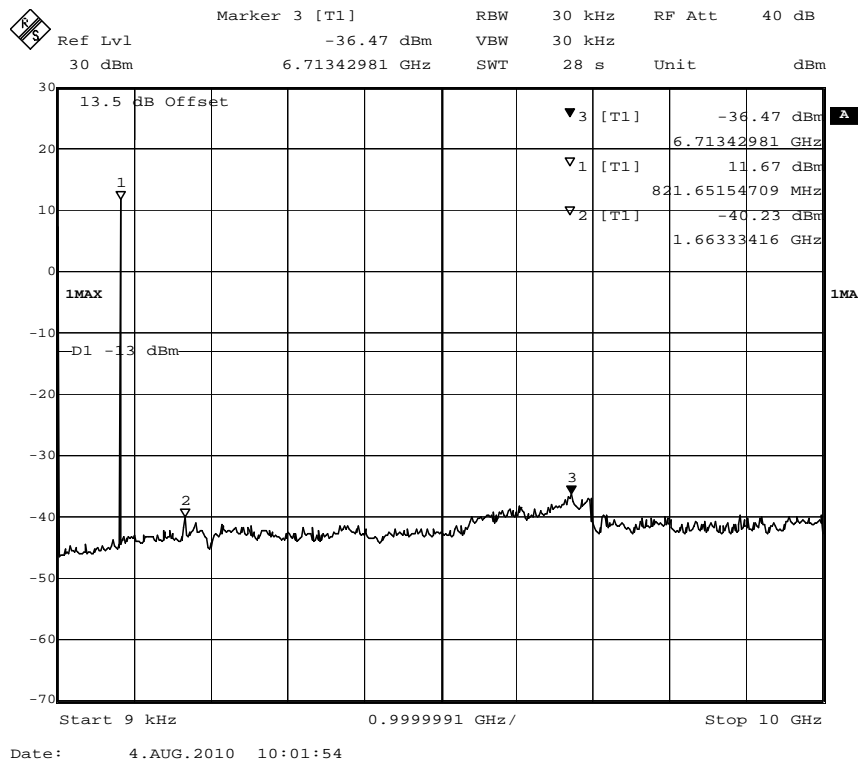

3 Cellular CDMA2000 1x RTT RC1/SO55 Channel 777

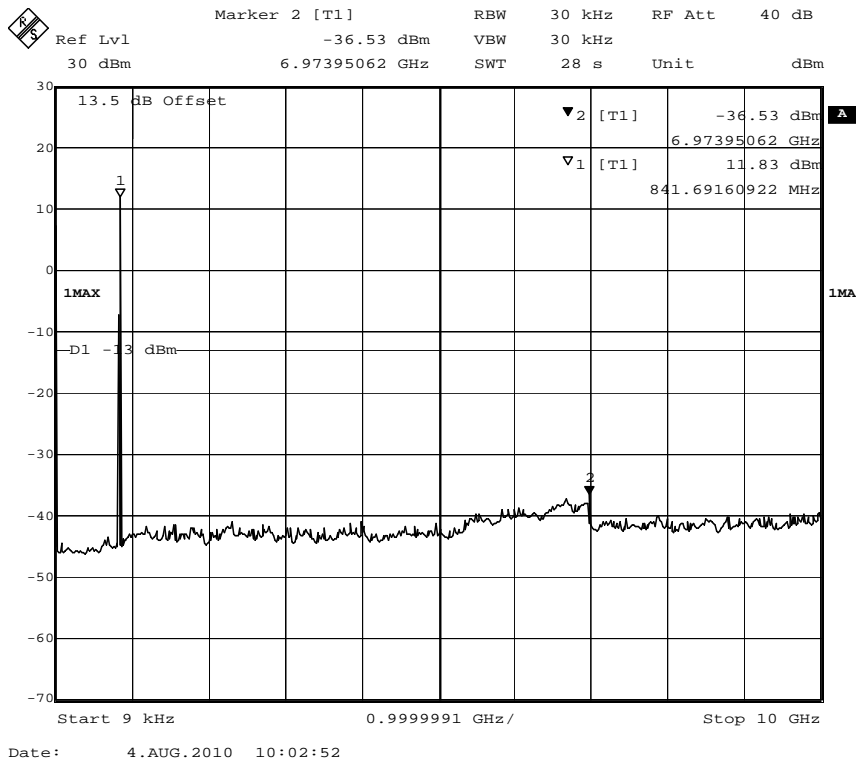

4 PCS CDMA2000 1x RTT RC1/SO55 Channel 25

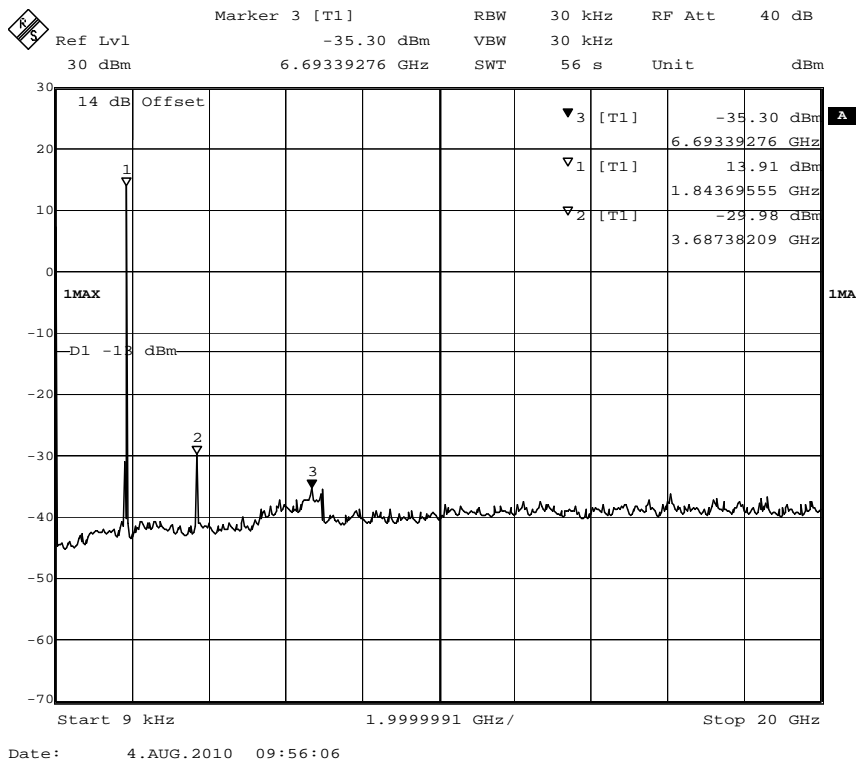

5 PCS CDMA2000 1x RTT RC1/SO55 Channel 600

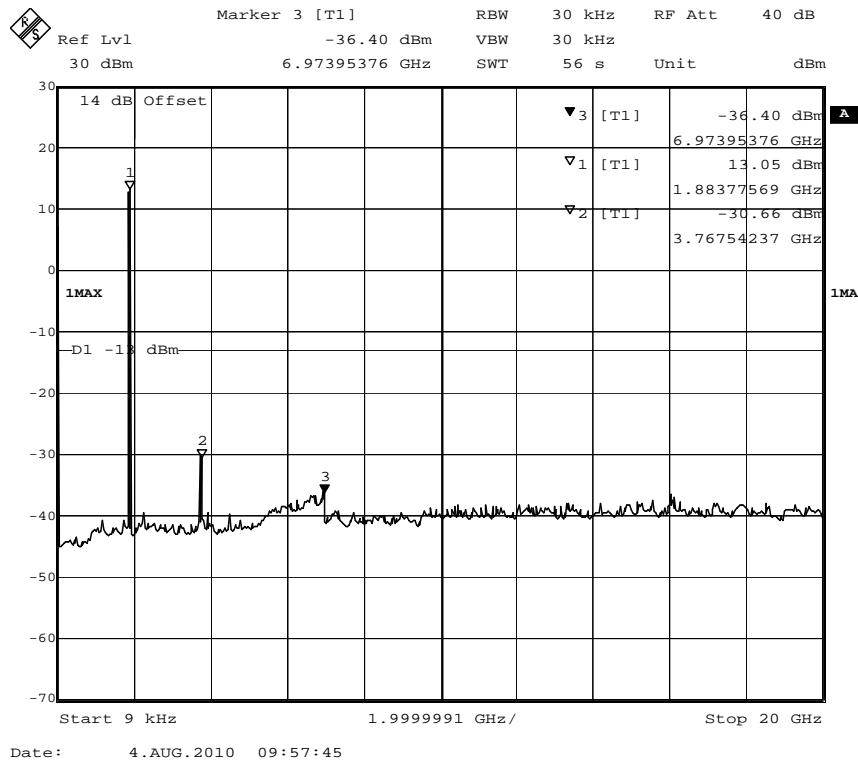

6 PCS CDMA2000 1x RTT RC1/SO55 Channel 1175

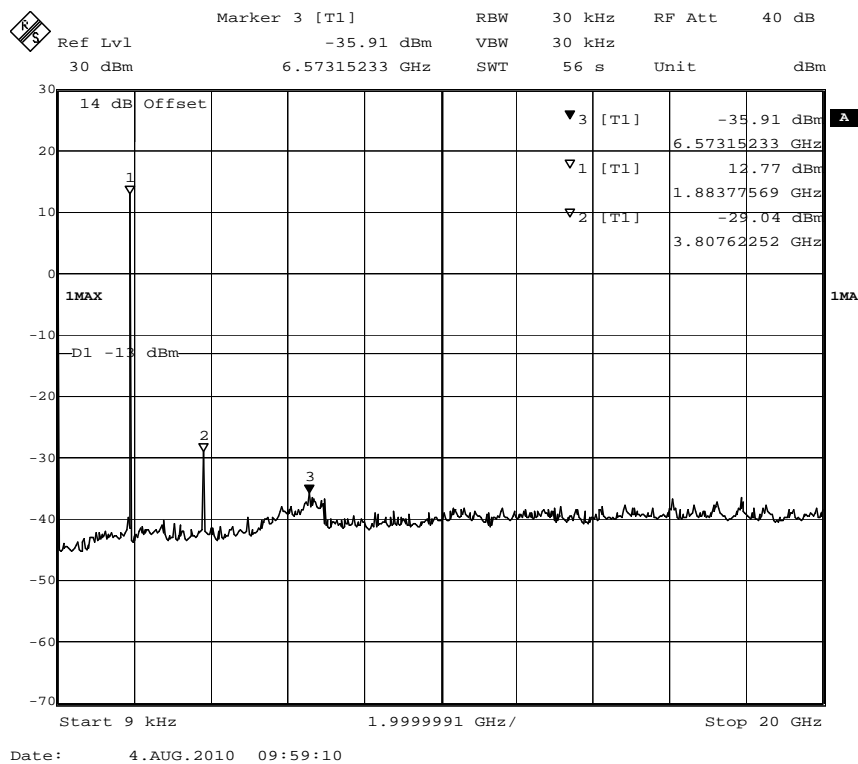

2.10 Transmitter Radiated Power (EIRP/ERP)

2.10.1 Requirement

According to FCC §22.913, the ERP of Cellular mobile transmitters must not exceed 7 Watts (38.5dBm).

2.10.2 Test Procedure

1. Perform test system setup as section 2.4.2.
2. The resolution bandwidth of the Spectrum Analyzer is set to be comparable to the emission bandwidth of the transmitter, e.g. for GSM modulated signal (here used): RBW=VBW=1MHz, for CDMA modulated signal: RBW=VBW=3MHz.
3. The lowest and the highest channel were selected to perform tests respectively. Channel No.1013(lowest) 384(middle)and 777(highest) for cellular band; Channel No.25(lowest) 600 (middle)and 1175(highest) for PCS band.
4. Employ the bi-log Test Antenna as the test system receiving antenna; set the polarization of the Test Antenna to be the same as that of the EUT transmitting antenna.
5. Set the frequency range of the Spectrum Analyzer suitably to capture the waveform; actuate the Turn Table to turn from 0 degrees to 360 degrees to find the maximum reading via the Spectrum Analyzer, mark the peak; finally record the peak and the plot.
6. Set the frequency range of the Spectrum Analyzer suitably to capture the waveform; search peak and mark it; finally record the peak and the plot.

2.10.3 Test Result

CDMA2000 Cellular					
Test Mode	Channel	Measured ERP		Result	Plots
		dBm	Watts		
CDMA 2000 1xRTT	1013 (Low)	23.22	0.20989	Pass	1
	384 (Mid)	23.47	0.22233	Pass	2
	777 (High)	23.35	0.21627	Pass	3
CDMA2000 PCS					
Test Mode	Channel	Measured ERP		Result	Plots
		dBm	Watts		
CDMA 2000 1xRTT	25(Low)	23.80	0.23988	Pass	4
	600 (Mid)	22.47	0.17660	Pass	5
	1175(High)	22.27	0.16866	Pass	6

2.10.4 Test plots

1 Cellular CDMA2000 1x RTT RC1/SO55 Channel 1013

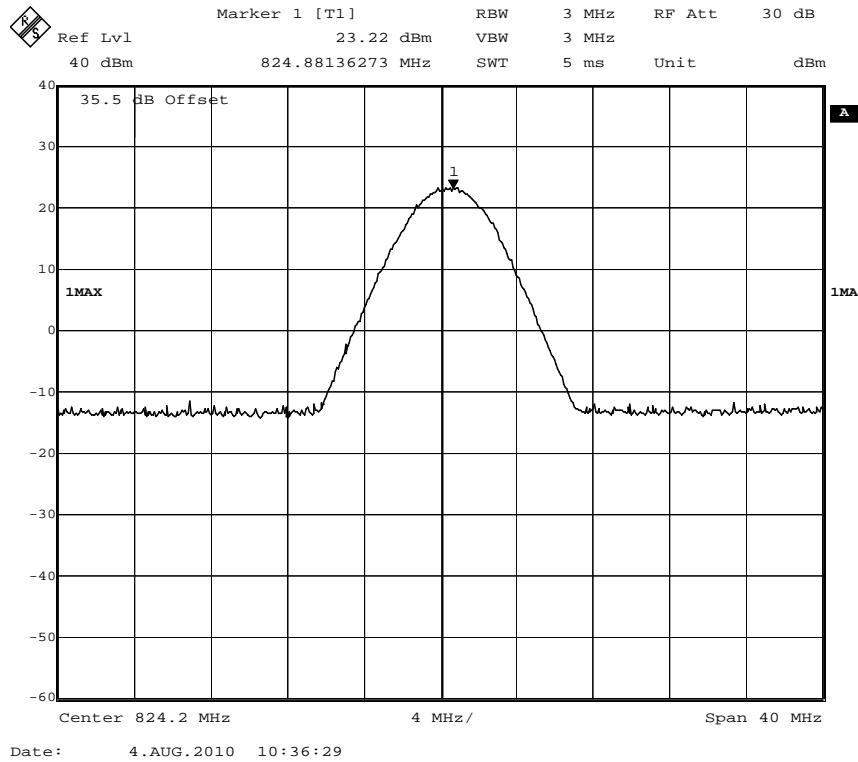

2 Cellular CDMA2000 1x RTT RC1/SO55 Channel 384

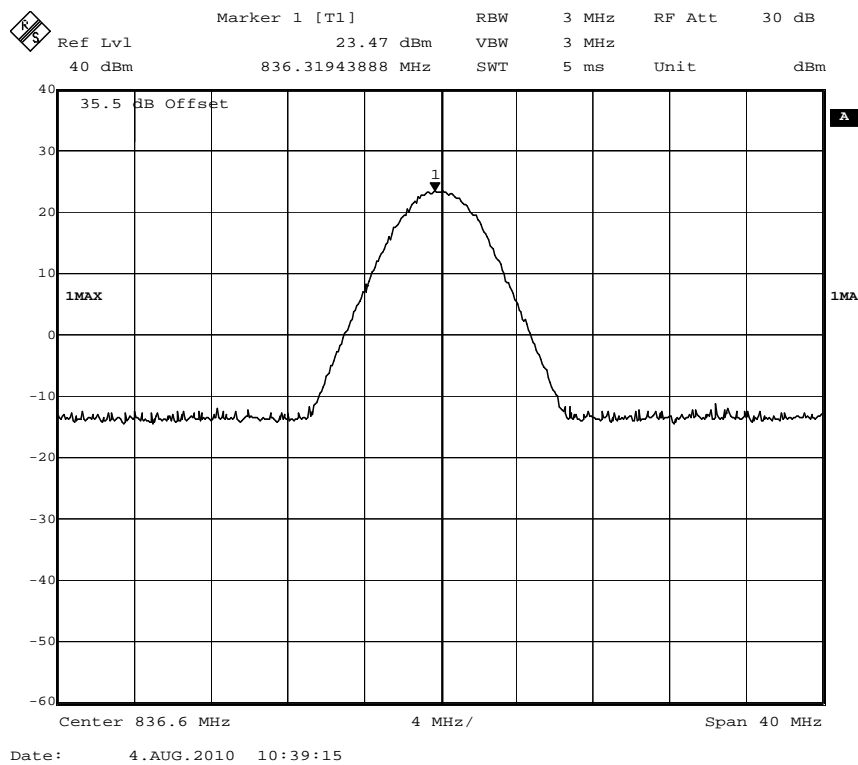

3 Cellular CDMA2000 1x RTT RC1/SO55 Channel 777

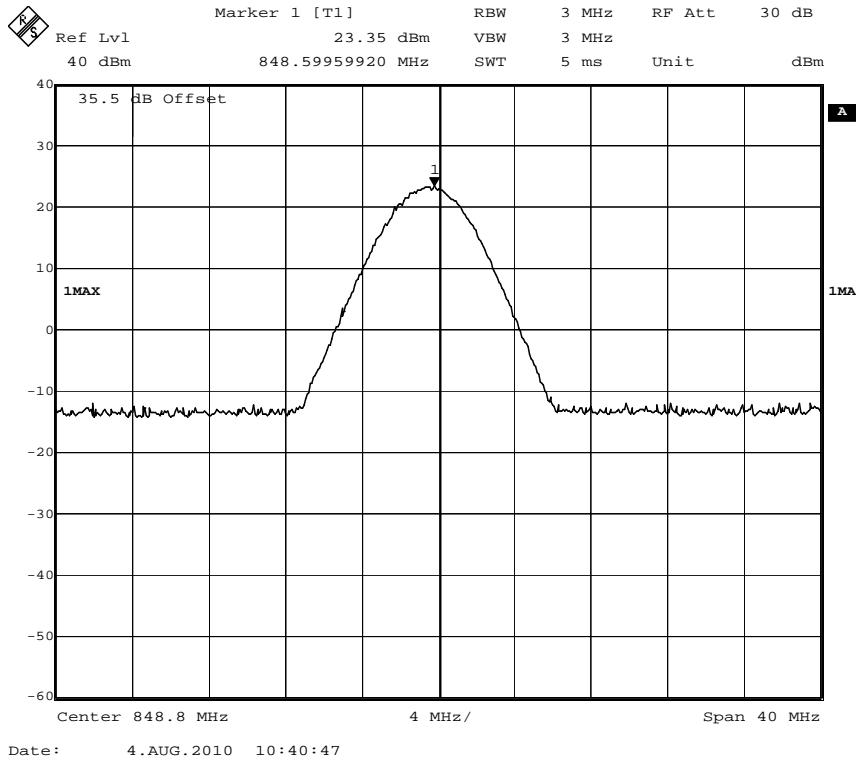

4 PCS CDMA2000 1x RTT RC1/SO55 Channel 25

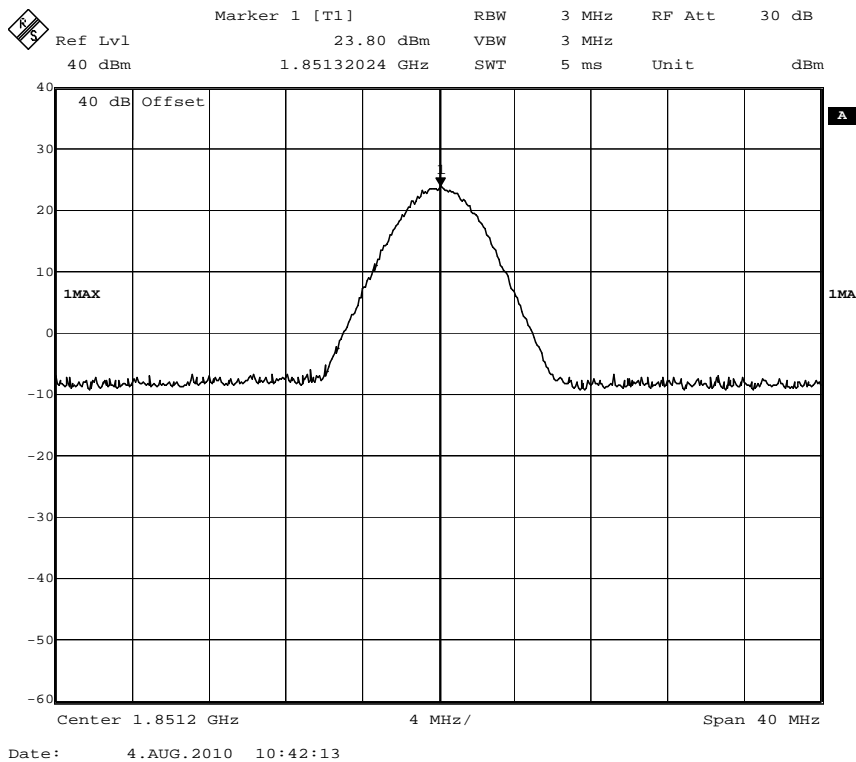

5 PCS CDMA2000 1x RTT RC1/SO55 Channel 600

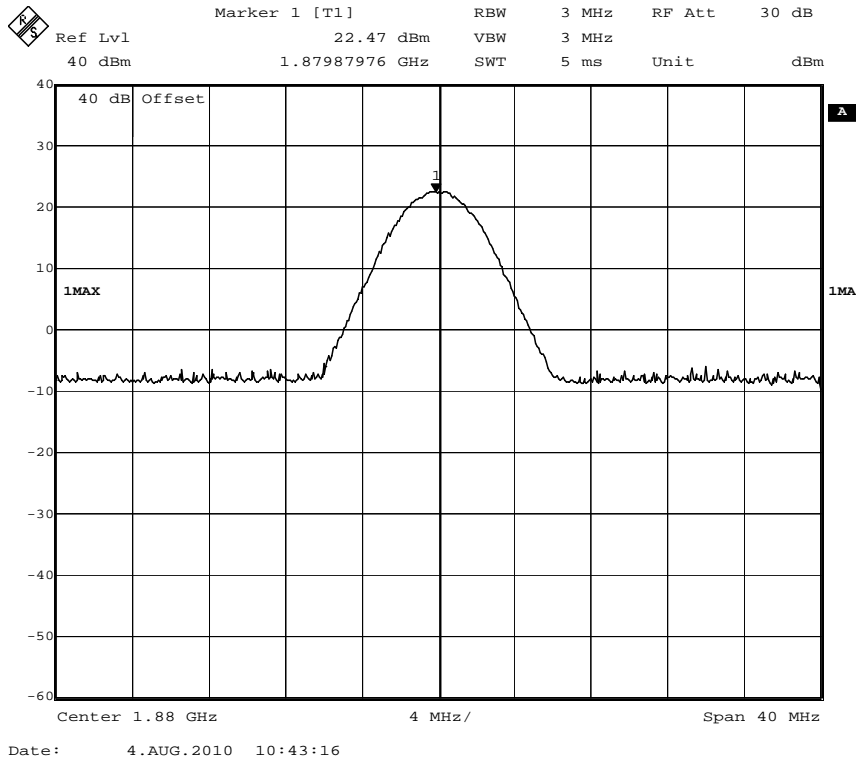

6 PCS CDMA2000 1x RTT RC1/SO55 Channel 1175

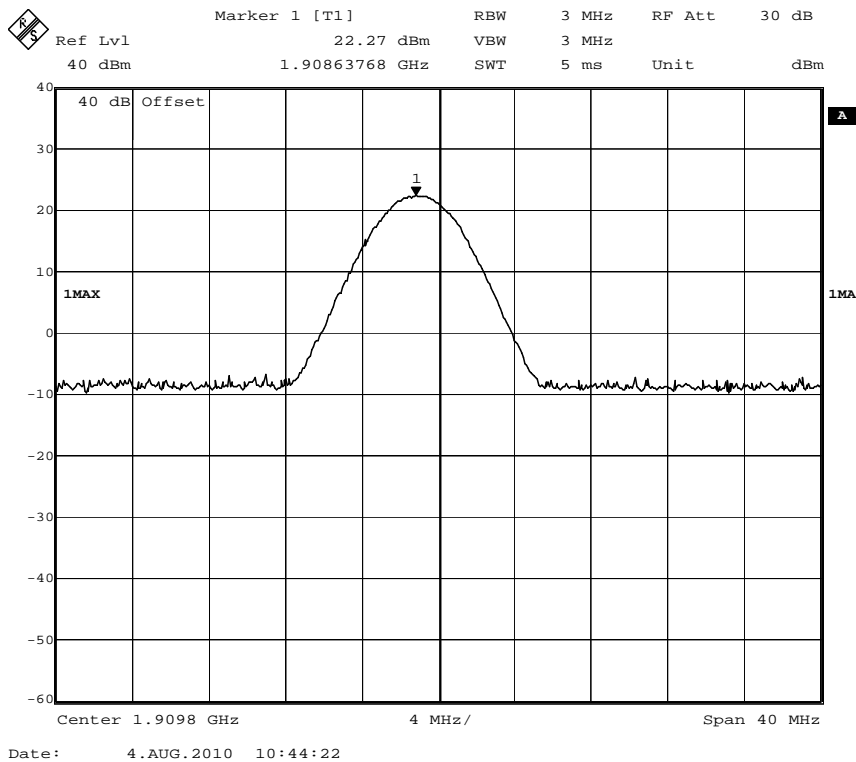

2.11 Radiated Spurious Emission

2.11.1 Requirement

According to FCC §22.917(a) and §24.238(a), ANSI / TIA /EIA-603-C-2004, the power of any emission outside of the authorized operating frequency ranges must be attenuated below the transmitting power (P) by a factor of at least $43+10*\log(P)$ dB. This calculated to be -13dBm.

2.11.2 Test Procedure

1. Perform test system setup as section 2.4.2
2. Make a limit line whose value is -13dBm on the Spectrum Analyzer, and set the RBW of the Spectrum Analyzer to 1MHz.
3. The two worst case channel were selected to perform tests respectively.
4. Employ the bi-log Test Antenna as the test system receiving antenna and set the frequency range of the Spectrum Analyzer from 30MHz to 3GHz.
5. The measurement is performed with the Test Antenna at both horizontal and vertical polarization respectively. Set the polarization of the Test Antenna to be horizontal.
6. Actuate the Turn Table to turn from 0 degrees to 360 degrees to find the maximum reading via the Spectrum Analyzer, mark the fundamental frequency and the harmonics thereof, after then record the harmonics and the plot.
7. Set the polarization of the Test Antenna to be vertical, then repeat step 6.
8. Employ the horn Test Antenna as the test system receiving antenna and set the frequency range of the Spectrum Analyzer from 3GHz to 10th harmonic of the fundamental frequency, then repeat step 5 to 7.
9. Set the frequency range of the Spectrum Analyzer suitably to capture the waveform; search peak and mark it; finally record the peak and the plot.

2.11.3 Test Result and plots

Test Mode	Frequency (GHz)	Max Spurious Emission (dBm)	Polarity	Limit (dBm)	Result
Cellular CDMA 2000 1xRTT	1.6736250	-40.383	H	-13	Pass
	2.5106250	-44.389	H	-13	Pass
	4.0167500	-45.894	H	-13	Pass
	5.8577500	-45.558	H	-13	Pass
	8.3655000	-42.245	H	-13	Pass
	1.6732500	-32.952	V	-13	Pass
	2.5100625	-43.185	V	-13	Pass
	3.9983750	-44.165	V	-13	Pass
	5.5978750	-44.732	V	-13	Pass
	6.6933750	-44.639	V	-13	Pass
Test Mode	Frequency (GHz)	Max Spurious Emission (dBm)	Polarity	Limit (dBm)	Result
PCS CDMA 2000 1xRTT	1.59993750	-58.885	H	-13	Pass
	4.00125000	-50.397	H	-13	Pass
	7.10625000	-47.903	H	-13	Pass
	16.93125000	-37.223	H	-13	Pass
	1.60050000	-54.994	V	-13	Pass
	4.01250000	-48.229	V	-13	Pass
	5.61187500	-49.119	V	-13	Pass
	14.45250000	-35.900	V	-13	Pass

2.11.4 Test plots

1 Cellular CDMA2000 1x RTT RC1/SO55(Horizontal)

MORLAB-RSE-FCC-CDMA800 30M-3G

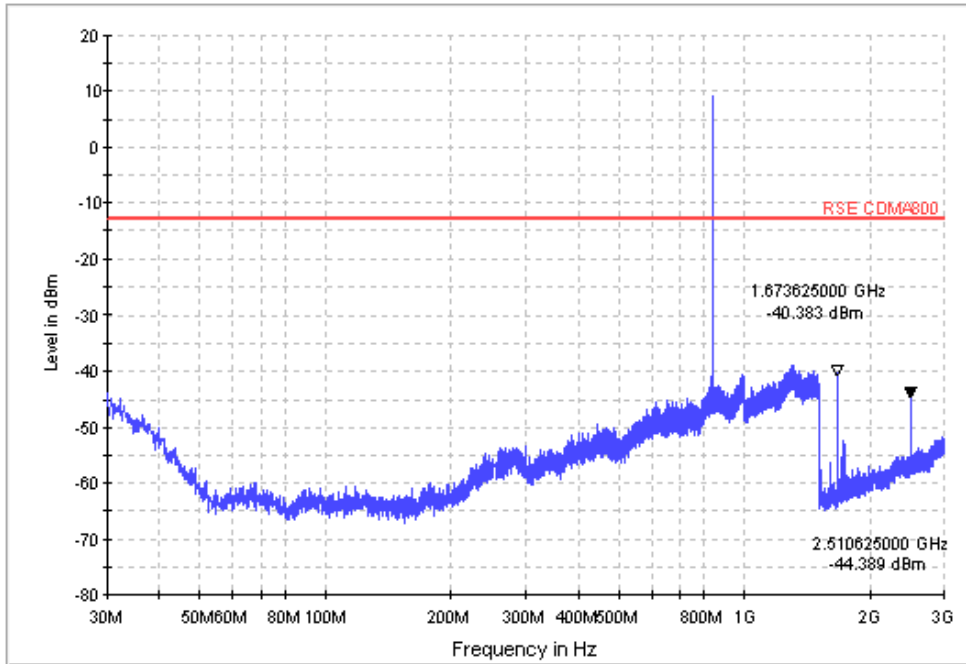

MORLAB-RSE-FCC-CDMA800 3G-10G

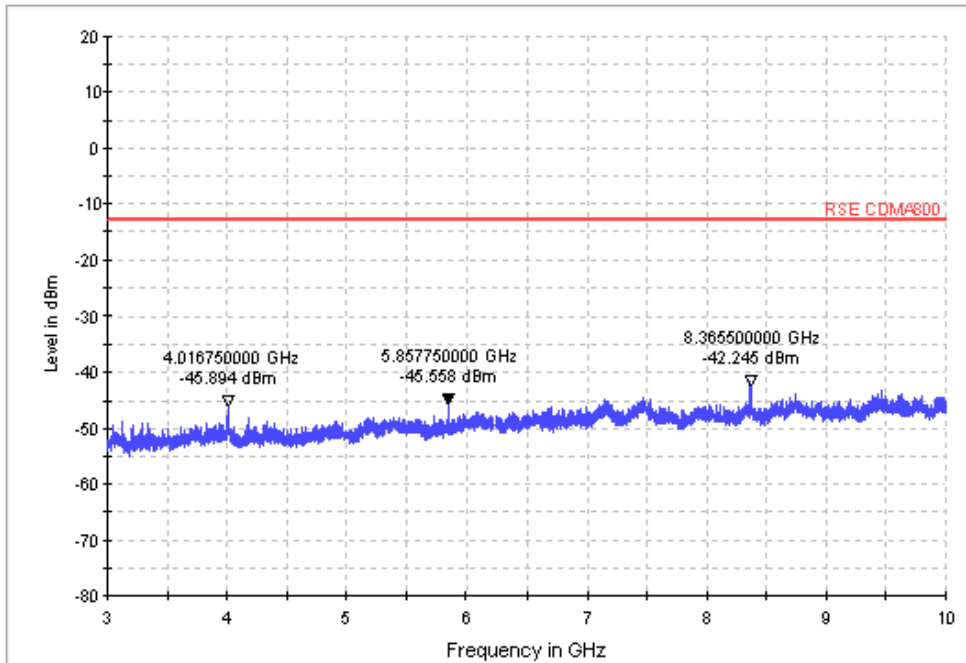

2 Cellular CDMA2000 1x RTT RC1/SO55 (Vertical)

MORLAB-RSE-FCC-CDMA800 30M-3G

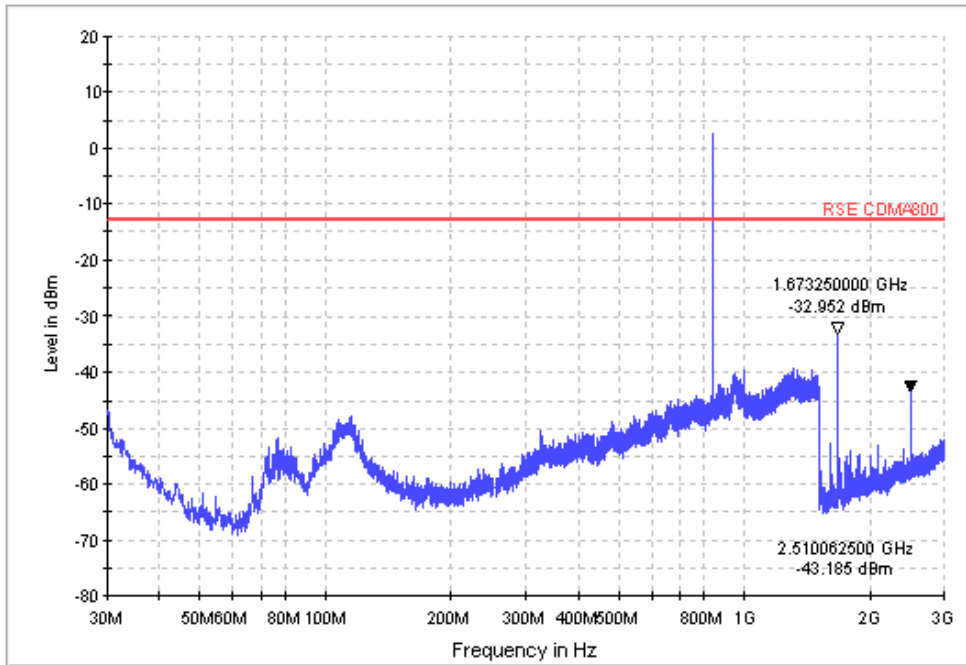

MORLAB-RSE-FCC-CDMA800 3G-10G

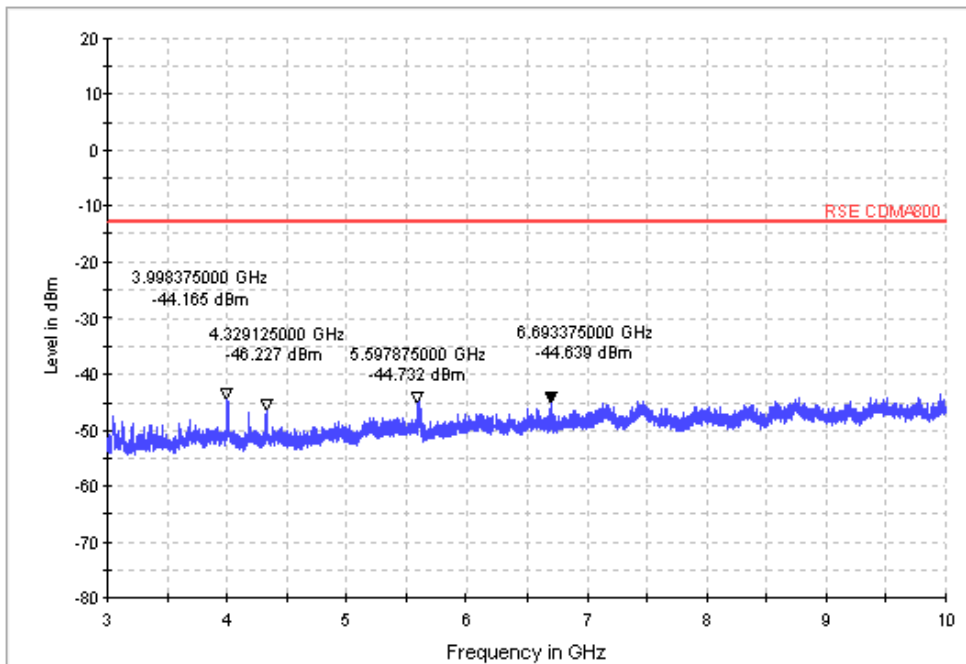

3 PCS CDMA2000 1x RTT RC1/SO55 (Horizontal)

MORLAB-RSE-FCC-CDMA1900 30M-3G

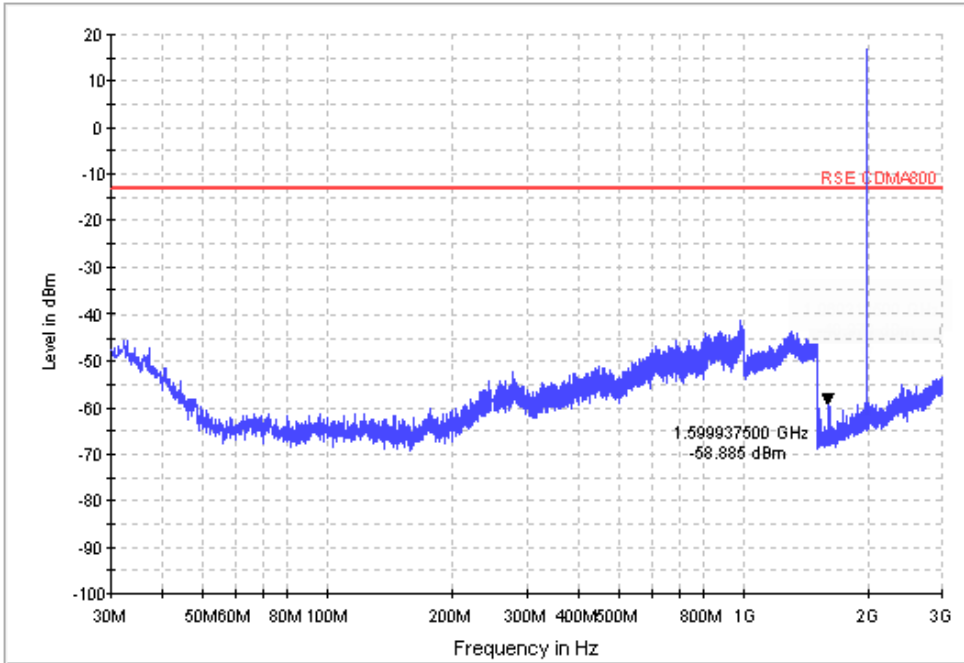

MORLAB-RSE-FCC-CDMA1900 3G-18G

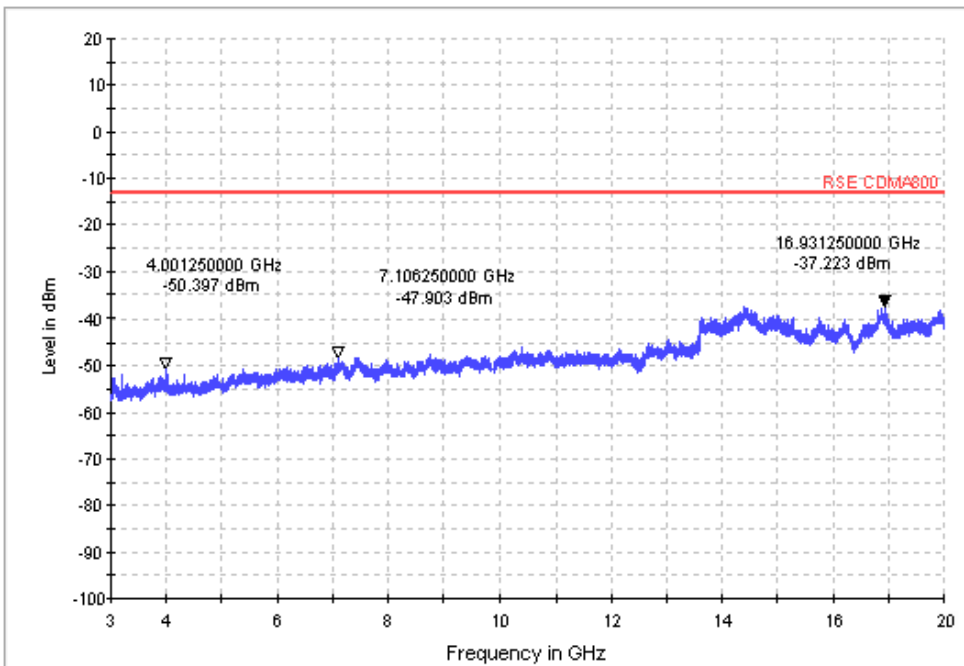

4 PCS CDMA2000 1x RTT RC1/SO55 (Vertical)

MORLAB-RSE-FCC-CDMA1900 30M-3G

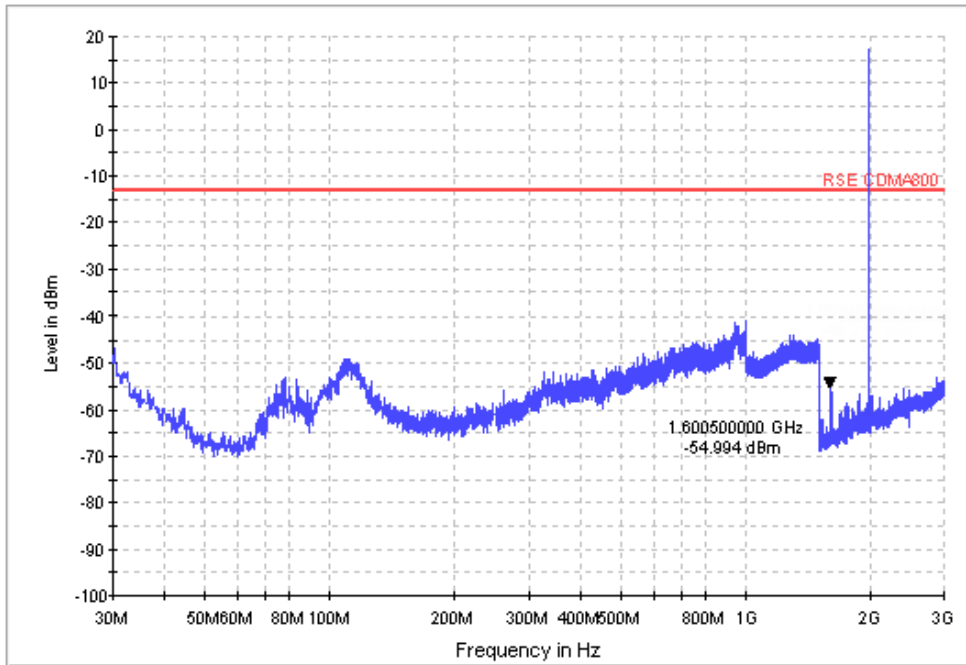

MORLAB-RSE-FCC-CDMA1900 3G-18G

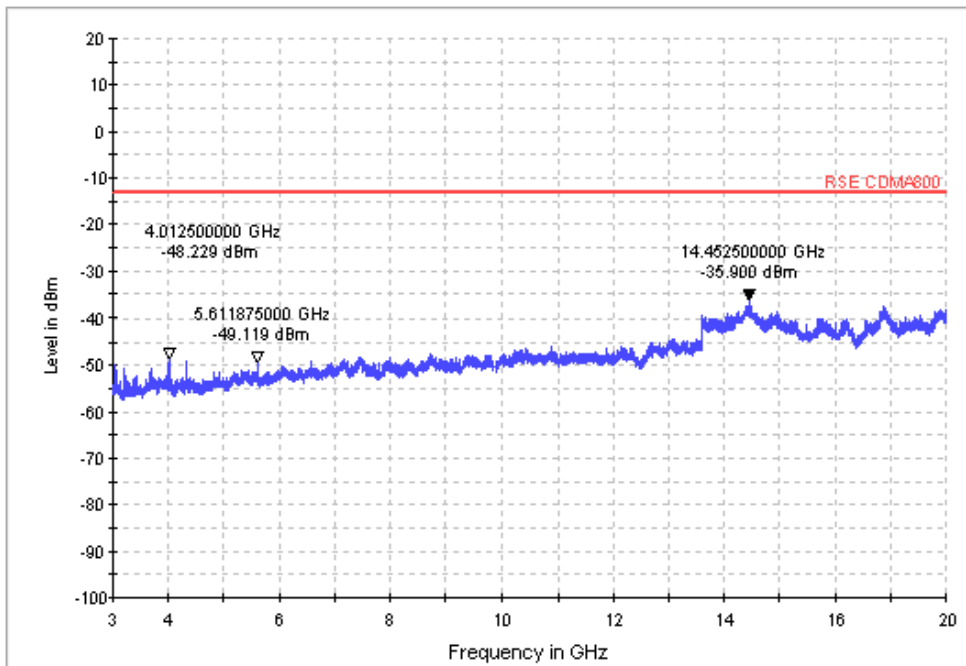

2.12 Frequency Stability

2.12.1 Frequency Stability Requirement

According to FCC §22.355, the frequency stability shall be sufficient to ensure that the fundamental emission stays within the authorized frequency block.

According to FCC §2.1055, the test conditions are:

- (a) Temperature:
The temperature is varied from -30°C to $+50^{\circ}\text{C}$ at intervals of not more than 10°C .
- (b) Primary Supply Voltage:
For hand carried battery powered equipment, the primary supply voltage is reduced to the battery operating end point which shall be specified by the manufacture. The supply voltage shall be measured at the input to the cable normally provided with the equipment, or at the power supply terminals if cables are not normally provided.

2.12.2 Test Procedure

1. Perform test system setup as section 2.4.3.
2. Set the voltage of the DC Power Supply to normal supply voltage (here used 3.3V) and the temperature of the Temperature Chamber to vary from -30°C to $+50^{\circ}\text{C}$ at intervals of 10°C .
3. At each temperature level, the EUT is powered off and kept in the Temperature Chamber for two hours. After sufficient stabilization, turn on the EUT, command it via the System Simulator (SS) to operate at the maximum output power i.e. A communication link is established between the EUT and the SS.
4. The frequency deviation is measured (directly read from the SS, which can report the parameter) within three minutes.
5. Set the frequency range of the Spectrum Analyzer suitably to capture the waveform; search peak and mark it; finally record the peak and the plot.
6. Adjust the temperature of the Temperature Chamber as specified in step 2, then repeat step 3 to 7.
7. Set the voltage of the DC Power Supply to high extreme supply voltage (here used 3.6V) and the temperature of the Temperature Chamber to normal (here used $+25^{\circ}\text{C}$), then repeat step 3 to 8.
8. Set the voltage of the DC Power Supply to low extreme supply voltage (here used 3.0V) and the temperature of the Temperature Chamber to normal (here used $+25^{\circ}\text{C}$), then repeat step 3 to 8.



2.12.3 Test results

Band & Channel	Mode	Voltage (Volt)	Temperature (°C)	Dev. Freq. (Hz)	Deviation (ppm)	Limit (ppm)	Result
CDMA2000 Cellular CH384	1x RTT RC1/SO55	3.3	-30	-4	0.00	2.5	PASS
			-20	-2	0.00		
			-10	+1	0.00		
			0	+2	0.00		
			+10	-3	0.00		
			+20	+1	0.00		
			+30	-8	0.00		
			+40	-4	0.00		
			+50	-4	0.00		
		3.6	+25	-2	0.00		
3.0	+25	+5	0.00				
CDMA2000 PCS CH600	1x RTT RC1/SO55	3.3	-30	+5	0.00	2.5	PASS
			-20	+2	0.00		
			-10	+3	0.00		
			0	-4	0.00		
			+10	+1	0.00		
			+20	+7	0.00		
			+30	-2	0.00		
			+40	+3	0.00		
			+50	-2	0.00		
		3.6	+25	+1	0.00		
3.0	+25	-2	0.00				

3. Test Equipments

Description	Manufacturer	Model	Serial No.	Cal. Date	Cal. Due
System Simulator	Rohde&Schwarz	CMU200	105571	2009.11	1year
System Simulator	Anritsu	MT8820A	BE07218	2009.10	1year
System Simulator	Agilent	E5515C	GB46040102	2009.10	1year
Spectrum Analyzer	Rohde&Schwarz	FSU26	/	2009.09	1year
Spectrum Analyzer	Rohde&Schwarz	FSP30	101020	2009.10	1year
<i>EMI Test Receiver</i>	Rohde&Schwarz	<i>ESCI3</i>	<i>100666</i>	2009.10	1year
<i>Bi-Log Antenna</i>	Rohde&Schwarz	<i>HL562</i>	<i>100385</i>	2009.10	1year
<i>Horn Antenna</i>	Rohde&Schwarz	<i>HF906</i>	<i>100565</i>	2009.10	1year
Power Splitter	Weinschel	1506A	NW521	(n.a.)	(n.a.)
Power Splitter	HP	11667B	00164	(n.a.)	(n.a.)
Attenuator 1	Resnet	20dB	(n.a.)	(n.a.)	(n.a.)
Attenuator 2	Resnet	3dB	(n.a.)	(n.a.)	(n.a.)
<i>Anechoic Chamber</i>	<i>ETS</i>	<i>9m*6m*6m</i>	<i>(n.a.)</i>	<i>(n.a.)</i>	<i>(n.a.)</i>
<i>Turn Table</i>	<i>ETS·LINDGREN</i>	<i>2188</i>	<i>(n.a.)</i>	<i>(n.a.)</i>	<i>(n.a.)</i>
<i>Antenna Tower</i>	<i>ETS·LINDGREN</i>	<i>2175</i>	<i>(n.a.)</i>	<i>(n.a.)</i>	<i>(n.a.)</i>
<i>Personal Computer</i>	<i>Lenovo</i>	<i>(n.a.)</i>	<i>(n.a.)</i>	<i>(n.a.)</i>	<i>(n.a.)</i>
<i>EMC Software</i>	Rohde&Schwarz	<i>EMC32</i>	<i>(n.a.)</i>	<i>(n.a.)</i>	<i>(n.a.)</i>

NOTE:

- Equipments listed above have been calibrated and are in the period of validation.

** END OF REPORT **