



Shenzhen Certification Technology Service Co., Ltd
2F, Building B, East Area of Nanchang Second Industrial
Zone, Gushu 2nd Road, Bao'an District, Shenzhen
518126, P.R. China.

TEST REPORT

FCC ID: X2NBL-MP01

Applicant : Shenzhen Bilian Electronic Limited
Address : No 268, Fuqian Rd, Jutang Community, Guanlan Town, Baoan District,
Shenzhen, 518110, PRC

Equipment under Test (EUT):

Name : 11N 150M WIRELESS Router
Model : BL-MP01
Standards : FCC PART 15, SUBPART C : 2010 (Section 15.247)

Report No. : STE120222153
Date of Test : March 1-7, 2012
Date of Issue : March 8, 2012

Test Result :	PASS *
----------------------	---------------

* In the configuration tested, the EUT complied with the standards specified above

Authorized Signature

(Mark Zhu)
General Manager

The manufacture should ensure that all the products in series production are in conformity with the product sample detailed in this report.

If the product in this report is used in any configuration other than that detailed in the report, the manufacturer must ensure the new system complies with all relevant standards. Any mention of Shenzhen Certification Technology Service Co., Ltd. Or test done by Shenzhen Certification Technology Service Co., Ltd. Approvals in connection with, distribution or use of the product described in this report must be approved by Shenzhen Certification Technology Service Co., Ltd. Approvals in writing.

TABLE OF CONTENT

Description	Page
1 General Information-----	4
1.1 Description of Device (EUT) -----	4
1.2 Description of Test Facility -----	5
2 EMC Equipment List-----	5
3 Test Procedure -----	6
4 Summary of Measurement-----	7
4.1 Summary of test result -----	7
4.2 Test mode-----	8
5 Spurious Emission -----	9
5.1 Conducted Spurious Emission -----	9
5.1.1 Test limit -----	9
5.1.2 Method of measurement-----	9
5.1.3 Test Setup -----	9
5.1.4 Test Results-----	9
5.2 Radiation Emission-----	19
5.2.1 Radiation Emission Limits(15.209)-----	19
5.2.2 Test Setup -----	19
5.2.3 Test Procedure -----	21
5.2.4 Test Equipment Setting For emission test.est Result-----	21
5.2.5 Test Condition -----	21
5.2.6 Test Result -----	21
6 POWER LINE CONDUCTED EMISSION-----	32
6.1 Conducted Emission Limits(15.209&249)-----	32
6.2 Test Setup -----	32
6.3 Test Procedure -----	33
6.4 Test Resluts-----	33
7 Peak Power-----	35
7.1 Test limit -----	35
7.2 Test Procedure -----	35
7.3 Test Setup -----	35
7.4 Test Results-----	35
8 PEAK POWER SPECTRAL DENSITY-----	36
8.1 Test limit -----	36
8.1.1 Please refer section15.247. -----	36
8.2 Method of measurement-----	36
8.3 Test Setup -----	36
8.4 Test Results-----	36
9 6dB Bandwidth-----	42
9.1 Test limit -----	42
9.2 Method of measurement-----	42
9.3 Test Setup -----	42
9.4 Test Results-----	42

10	NUMBER OF HOPPING FREQUENCY	48
10.1	Test limit	48
10.2	Method of measurement	48
10.3	Test Setup	48
10.4	Test Results	48
11	DWELL TIME	49
11.1	Test limit	49
11.2	Method of measurement	49
11.3	Test Setup	49
11.4	Test Results	49
12	Band Edge Check	50
12.1	Test limit	50
12.2	Test Procedure	50
12.3	Test Setup	50
12.4	Test Result	50
13	Antenna Requirement	75
13.1	Standard Requirement	75
13.2	Antenna Connected Construction	75
13.3	Result	75
14	Photographs of Test Setup	76
15	Photographs of EUT	79

1 General Information

1.1 Description of Device (EUT)

Trade Name : B-LINK

EUT : 11N 150M WIRELESS Router

Model No. : BL-MP01

Type of Antenna : Integral Antenna

Antenna Specification : 2.5dBi

Operation Frequency : 2412~2462MHZ

Channel number : 11
IEEE 802.11b: DSSS(CCK,DQPSK,DBPSK)

Modulation type : IEEE 802.11g: OFDM(64QAM, 16QAM, QPSK, BPSK)
IEEE 802.11n :OFDM(64QAM, 16QAM, QPSK, BPSK)

Power Supply : DC 5V from PC

Rated PF
output Power : 11.25 dBm

Applicant : Shenzhen Bilian Electronic Limited

Address : No 268, Fuqian Rd, Jutang Community, Guanlan Town,
Baoan District, Shenzhen, 518110, Prc

Manufacturer : Shenzhen Bilian Electronic Limited

Address : No 268, Fuqian Rd, Jutang Community, Guanlan Town,
Baoan District, Shenzhen, 518110, Prc

1.2 Description of Test Facility

Shenzhen Certification Technology Service Co.,Ltd.
 2F, Building B, East Area of Nanchang Second Industrial Zone,
 Gushu 2nd Road, Bao'an District, Shenzhen 518126, P.R. China
 FCC Registered No.:197647

2 EMC Equipment List

Equipment	Manufacture	Model No.	Serial No.	Last cal.	Cal Interval
3m Semi-Anechoic	ETS-LINDGREN	N/A	SEL0017	06/06/2011	1Year
Spectrum analyzer	Agilent	E4443A	MY46185649	06/06/2011	1Year
Receiver	R&S	ESCI	100492	04/06/2011	1Year
Receiver	R&S	ESCI	101202	04/06/2011	1Year
Bilog Antenna	Sunol	JB3	A121206	04/06/2011	1Year
Horn Antenna	EMCO	3115	640201028-06	04/06/2011	1Year
Power Meter	Anritsu	ML2487A	6K00001491	02/23/2012	1Year
ETS Horn Antenna	ETS	3160	SEL0076	12/08/2011	1Year
Active Loop Antenna	Beijing Daze	ZN30900A	SEL0097	06/06/2011	1Year
Cable	Resenberger	N/A	No.1	04/06/2011	1Year
Cable	SCHWARZBECK	N/A	No.2	04/06/2011	1Year
Cable	SCHWARZBECK	N/A	No.3	04/06/2011	1Year
Pre-amplifier	R&S	AFS42-00101 800-25-S-42	SEL0081	04/06/2011	1Year
Pre-amplifier	R&S	AFS33-18002650 -30-8P-44	SEL0080	04/06/2011	1Year

3 Test Procedure

POWER LINE CONDUCTED INTERFERENCE: The test procedure used was ANSI Standard C63.4-2003 using a 50 μ H LISN. Both Lines were observed. The bandwidth of the receiver was 10kHz with an appropriate sweep speed. The ambient temperature of the EUT was 25°C with a humidity of 58%.

RADIATION INTERFERENCE: The test procedure used was ANSI Standard C63.4-2003 using a ANRITSU spectrum analyzer with a pre-selector. The analyzer was calibrated in dB above a micro volt at the output of the antenna. The resolution bandwidth was 100kHz and the video bandwidth was 300 kHz up to 1 GHz and 1 MHz with a video BW of 3MHz above 1 GHz. The ambient temperature of the EUT was 25°C with a humidity of 58%.

FORMULA OF CONVERSION FACTORS: The Field Strength at 3m was established by adding the meter reading of the spectrum analyzer (which is set to read in units of dBuV) to the antenna correction factor supplied by the antenna manufacturer and cable loss. The antenna correction factors and cable loss are stated in terms of dB. The gain of the Pre-selector was accounted for in the Spectrum Analyzer Meter Reading.

Example:

Freq (MHz) METER READING + ACF + CABLE = FS

33.20 dBuV + 10.36 dB + 0.9 dB= 44.46 dBuV/m @ 3m

ANSI STANDARD C63.4-2003 10.1.7 MEASUREMENT PROCEDURES: The EUT was placed on a table 80 cm high and with dimensions of 1m by 1.5m. The EUT was placed in the center of the table (1.5m side). The table used for radiated measurements is capable of continuous rotation. When an emission was found, the table was rotated to produce the maximum signal strength. At this point, the antenna was raised and lowered from 1m to 4m. The antenna was placed in both the horizontal and vertical planes. The situation was similar for the conducted measurement except that the table did not rotate. The EUT was setup as described in ANSI Standard C63.4-2003 10.1.7 with the EUT 40 cm from the vertical ground wall.

4 Summary of Measurement

4.1 Summary of test result

Test Item	Test Requirement	Standard Paragraph	Result
Spurious Emission	FCC PART 15 : 2010	Section 15.247&15.209	Compliance
Conduction Emission	FCC PART 15: 2010	Section 15.207	Compliance
6dB Bandwidth Test	FCC PART 15:2010	Section 15.247	Compliance
Peak Power	FCC PART 15:2010	Section 15.247	Compliance
Power Density	FCC PART 15:2010	Section 15.247	Compliance
Number Channel	FCC PART 15:2010	Section 15.247	Not applicable
Dwell Time	FCC PART 15:2010	Section 15.247	Not applicable
Band Edge	FCC PART 15:2010	Section 15.247	Compliance
Antenna Requirement	FCC PART 15 : 2010	Section 15.203	Compliance

Note:The EUT has been tested as an independent unit. And Continual Transmitting in maximum power (The netbook be used during Test)

4.2 Test mode

Tested mode, channel, and data rate information			
Mode	data rate (Mbps)(see Note)	Channel	Frequency (MHz)
IEEE 802.11b	11	Low :CH1	2412
	11	Middle: CH6	2437
	11	High: CH11	2462
IEEE 802.11g	6	Low :CH1	2412
	6	Middle: CH6	2437
	6	High: CH11	2462
IEEE 802.11n	6.5	Low :CH1	2412
	6.5	Middle: CH6	2437
	6.5	High: CH11	2462

Note: According exploratory test, EUT will have maximum output power in those data rate. so those data rate were used for all test.

5 Spurious Emission

5.1 Conducted Spurious Emission

5.1.1 Test limit

Please refer section 15.247.

In any 100 kHz bandwidth outside the frequency band in which the spread spectrum or digitally modulated intentional radiator is operating, the radio frequency power that is produced by the intentional radiator shall be at least 20 dB below that in the 100 kHz bandwidth within the band that contains the highest level of the desired power, based on either an RF conducted or a radiated measurement. Attenuation below the general limits specified in Section 15.209(a) is not required. In addition, radiated emissions which fall in the restricted bands, as defined in Section 15.205(a), must also comply with the radiated emission limits specified in Section 15.209(a) (see Section 15.205(c)).

5.1.2 Method of measurement

Conducted RF measurements of the transmitter output were made to confirm that the EUT antenna port conducted emissions meet the specified limit and to identify any spurious signals that require further investigation or measurements on the radiated emissions site.

The transmitter output is connected to the spectrum analyzer. The resolution bandwidth is set to 100 KHz. The video bandwidth is set to 100 KHz.

Measurements are made over the 30MHz to 26GHz range with the transmitter set to the lowest, middle, and highest channels.

5.1.3 Test Setup

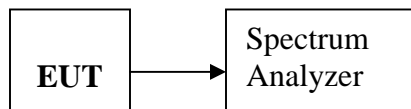

5.1.4 Test Results

PASS.

Detailed information please see the following page.

IEEE 802.11b:

CH Low : 30MHz-2.6.5GHz

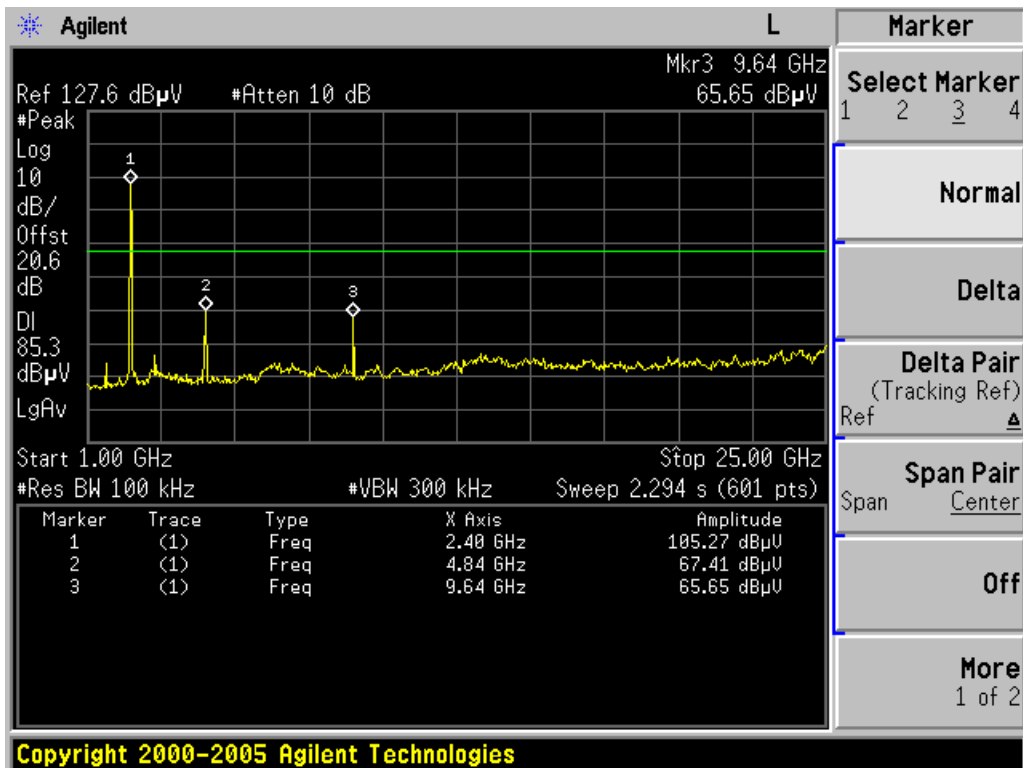
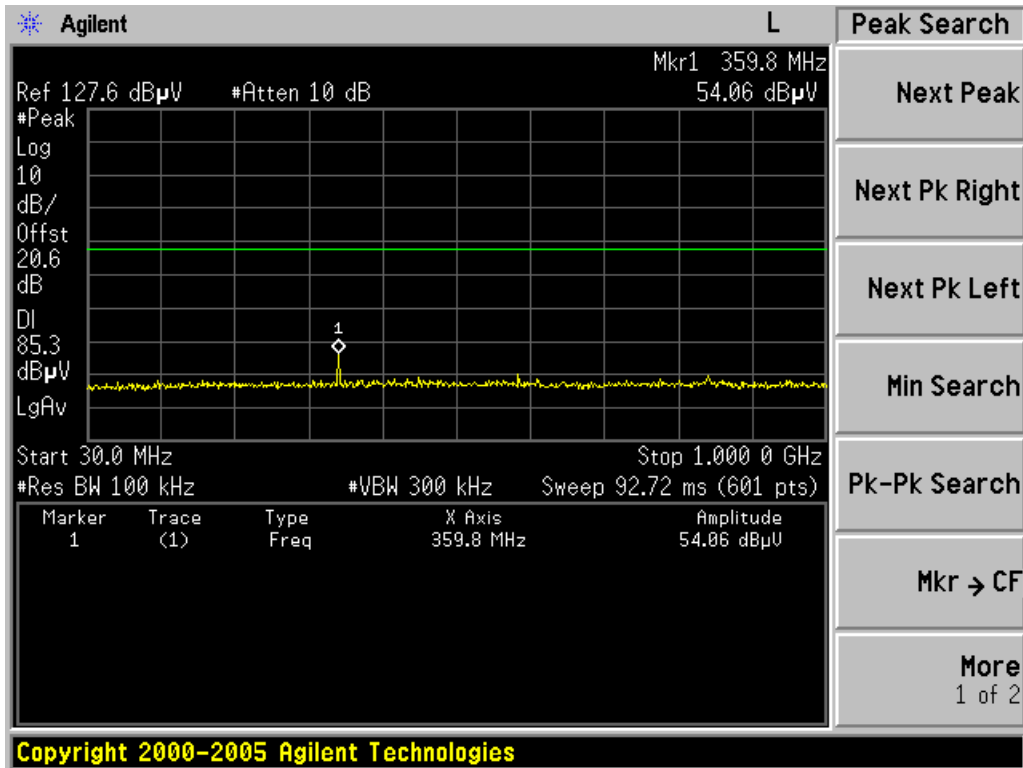

CH Mid : 30MHz-2.6.5GHz

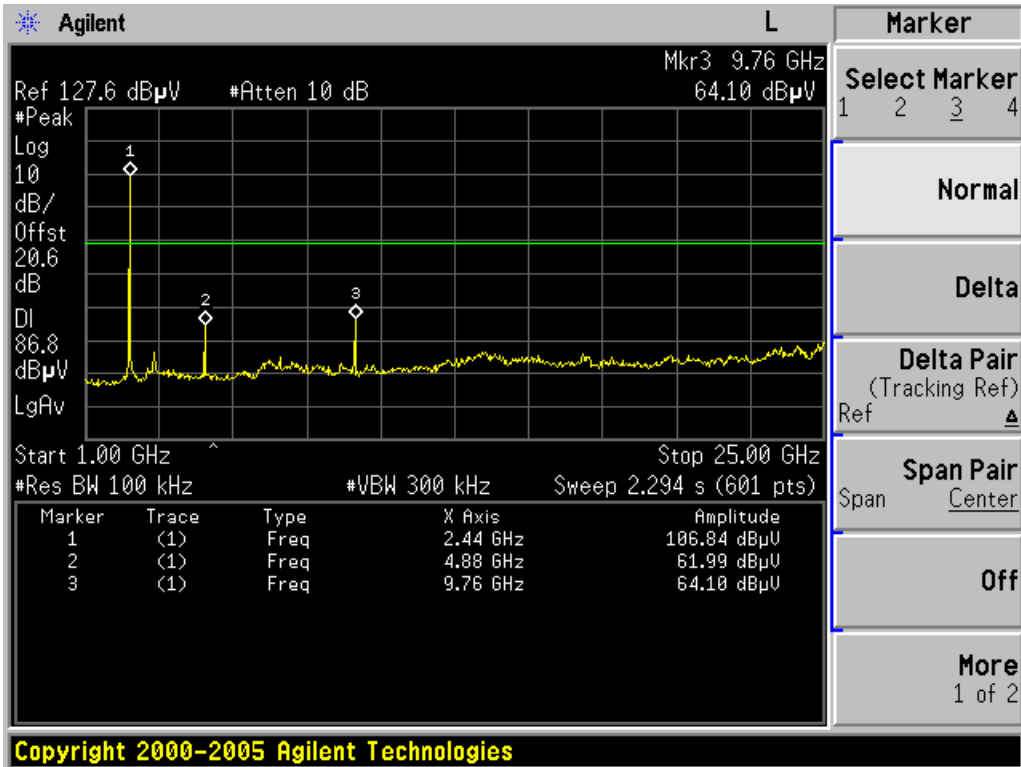
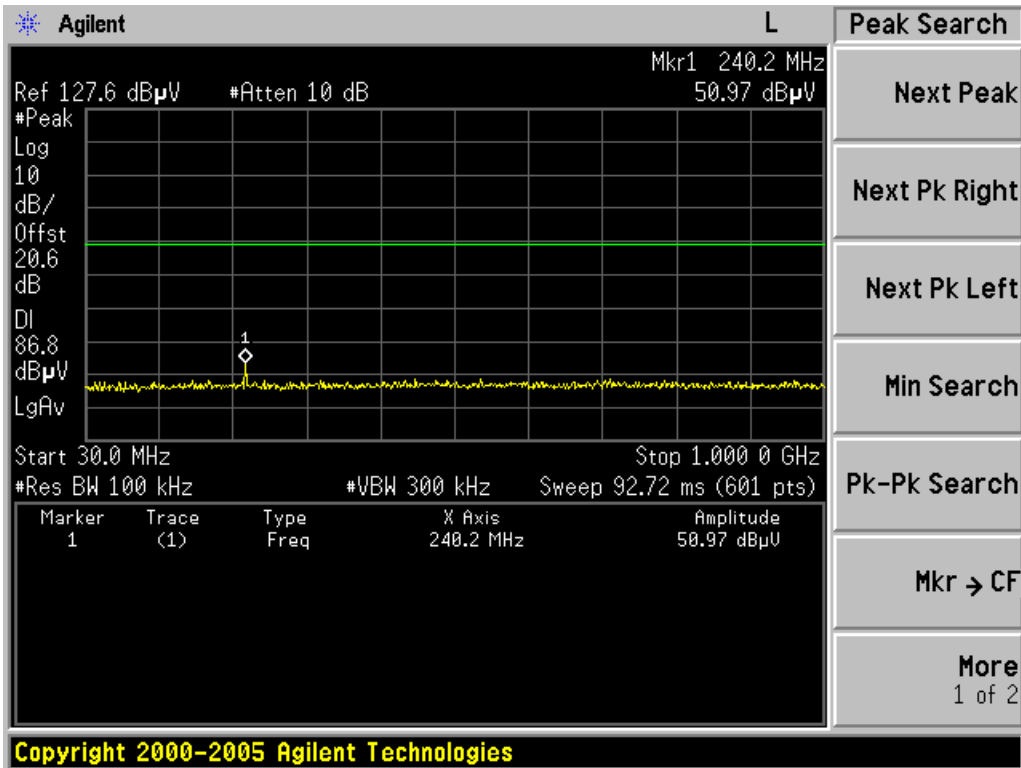

CH High : 30MHz-2.6.5GHz

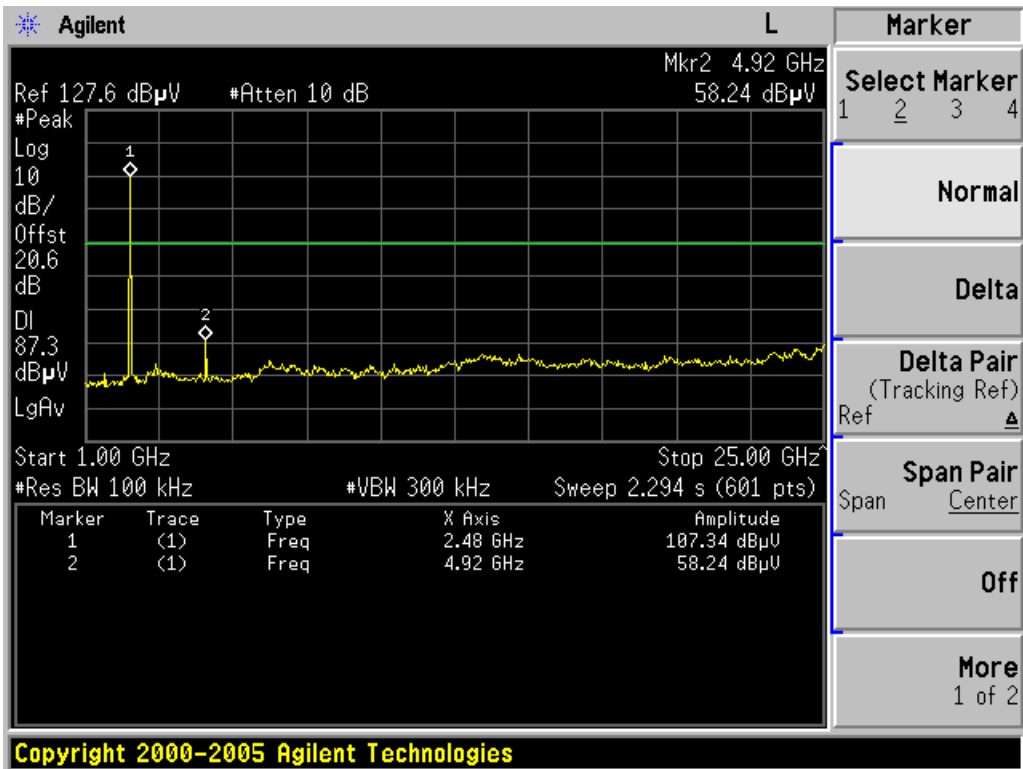
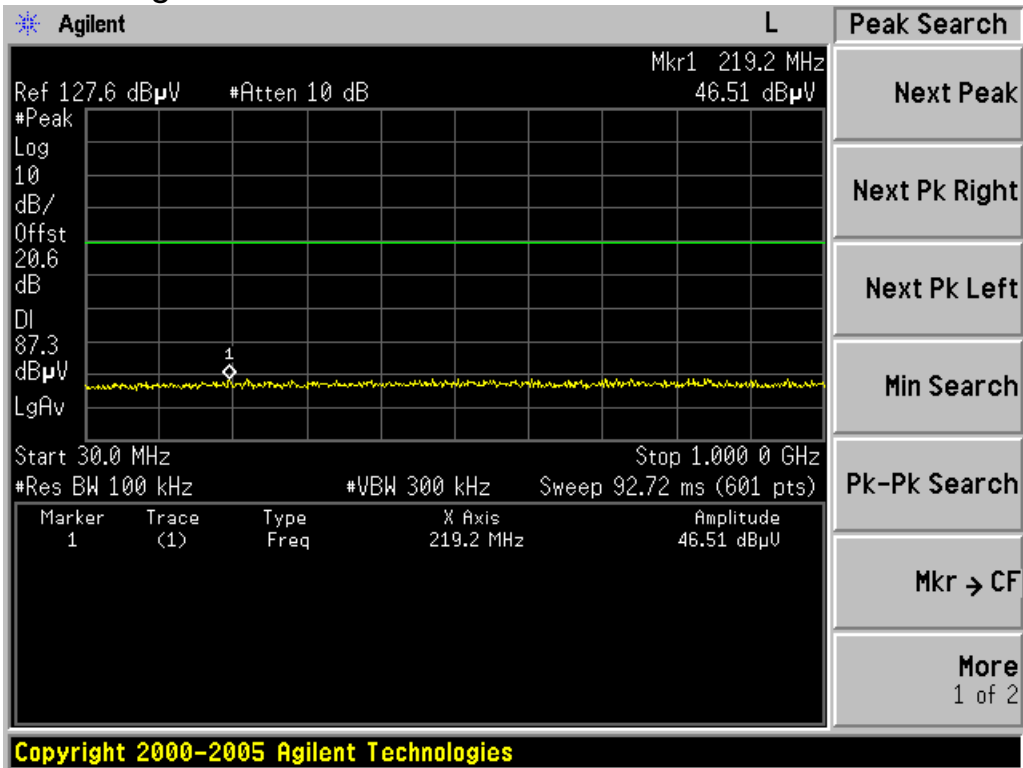

IEEE 802.11g:

CH Low : 30MHz-2.6.5GHz

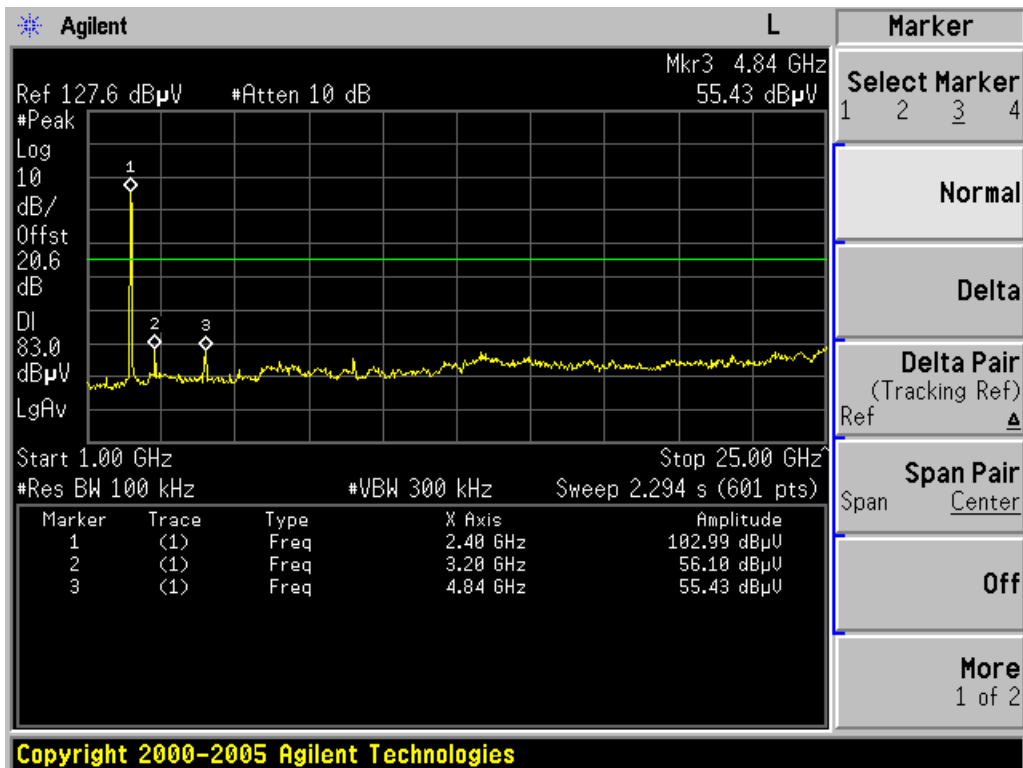
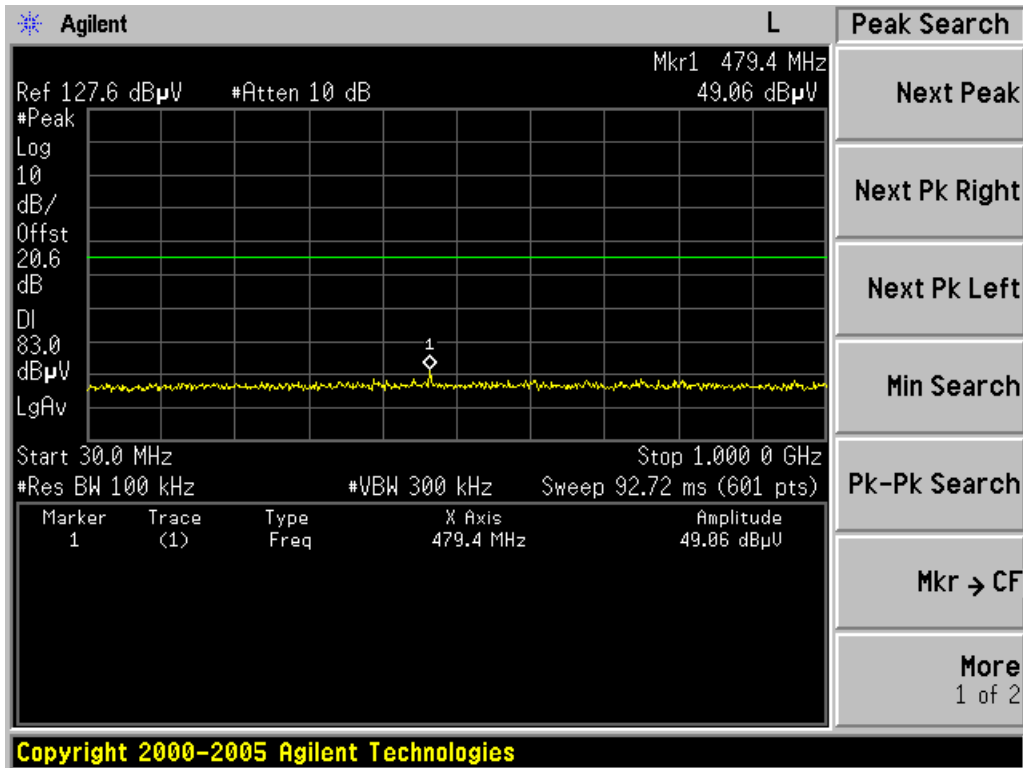

CH Mid : 30MHz-2.6.5GHz

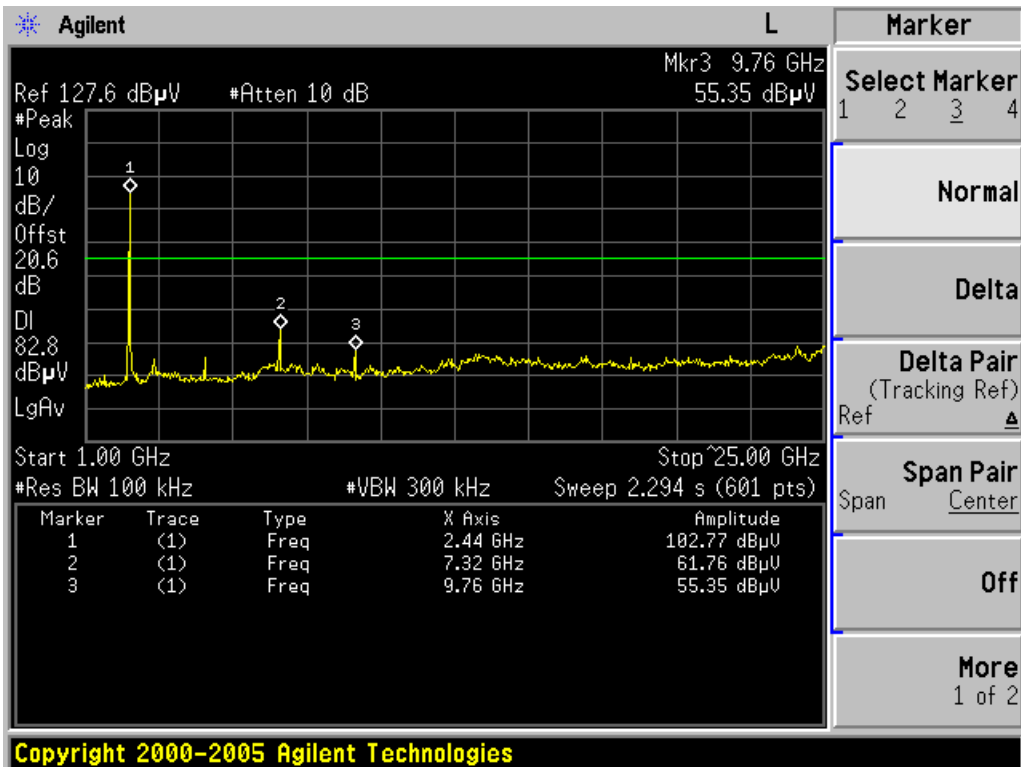
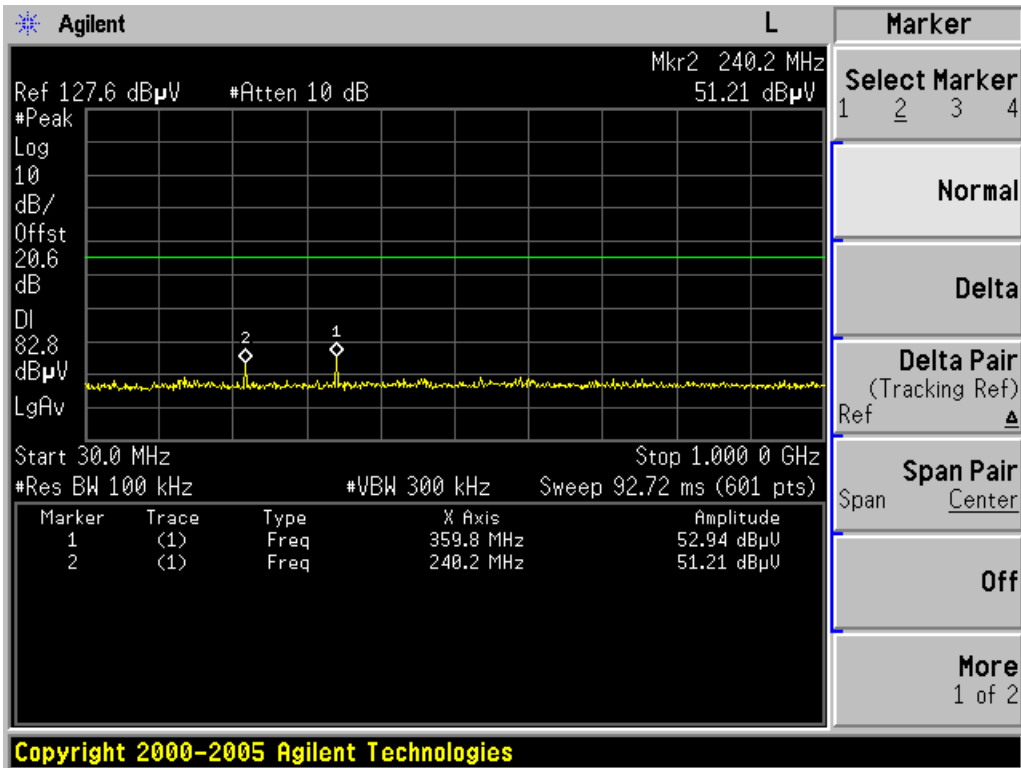

CH High : 30MHz-2.6.5GHz

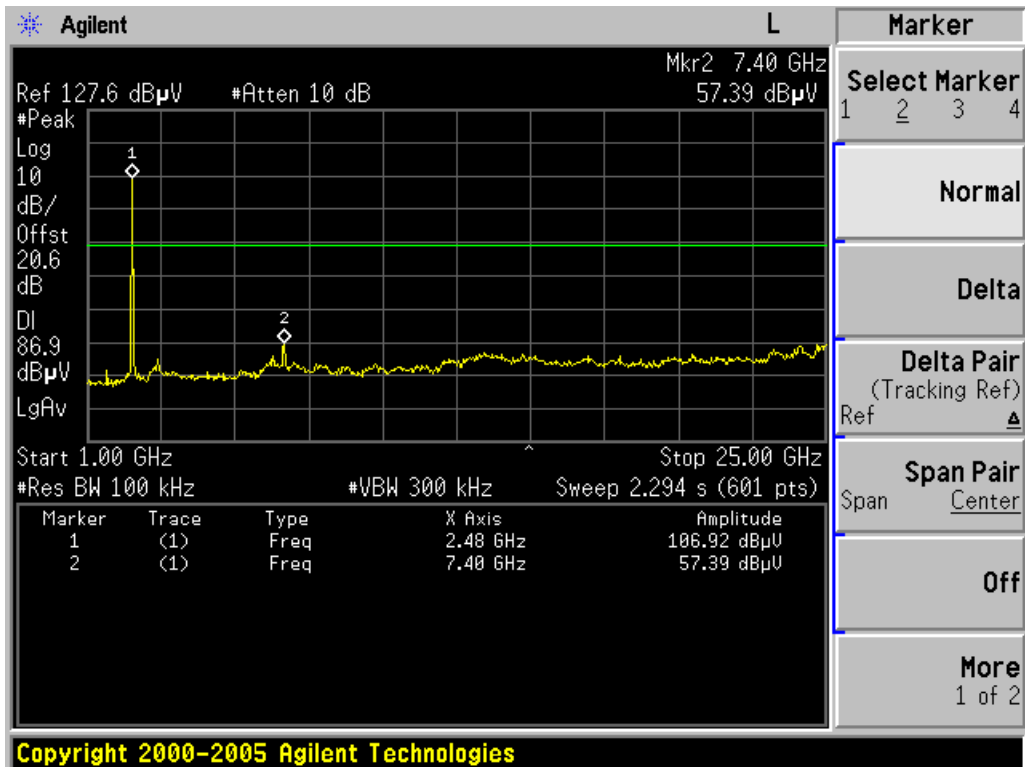
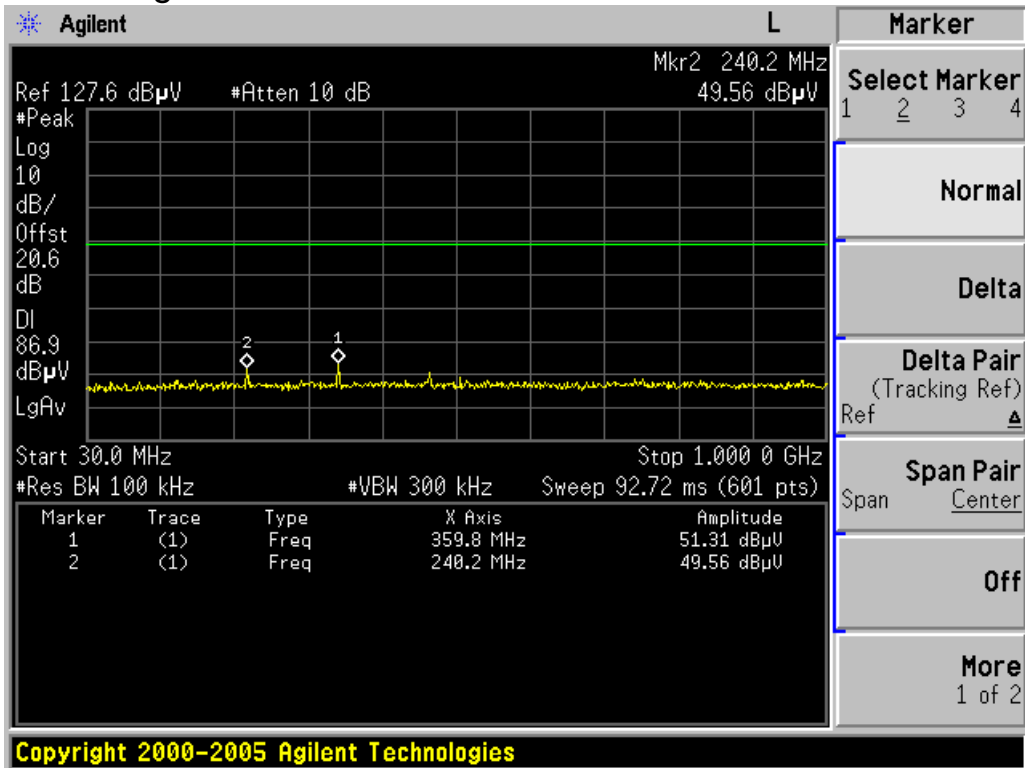

IEEE 802.11n:

CH Low : 30MHz-2.6.5GHz

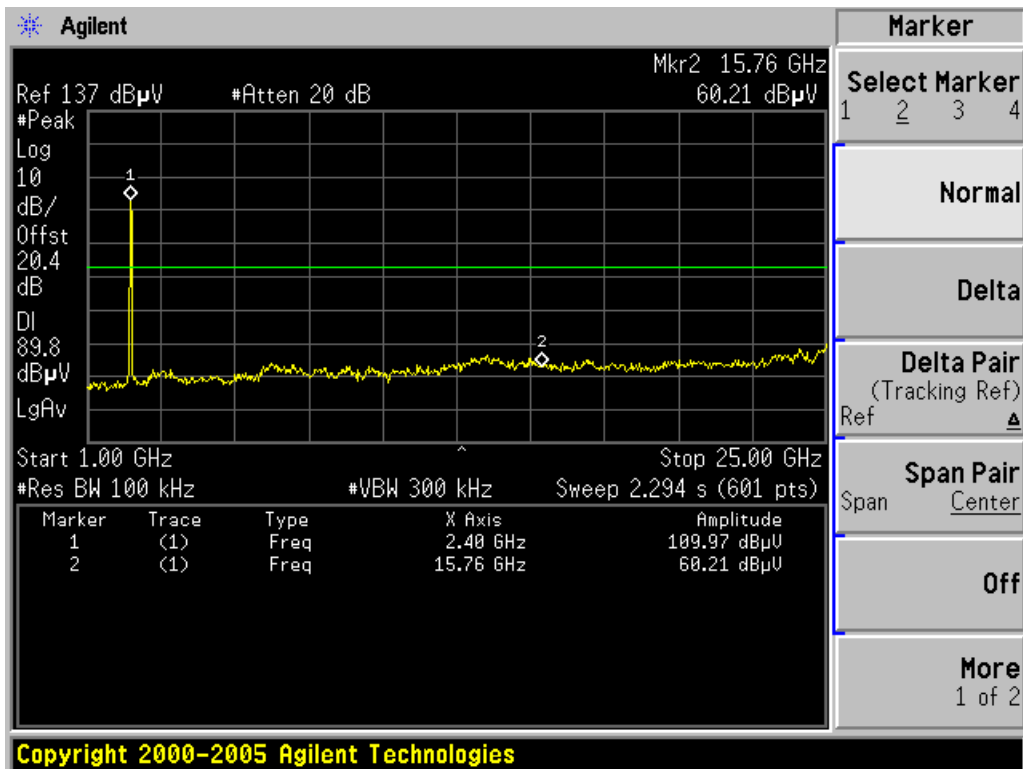
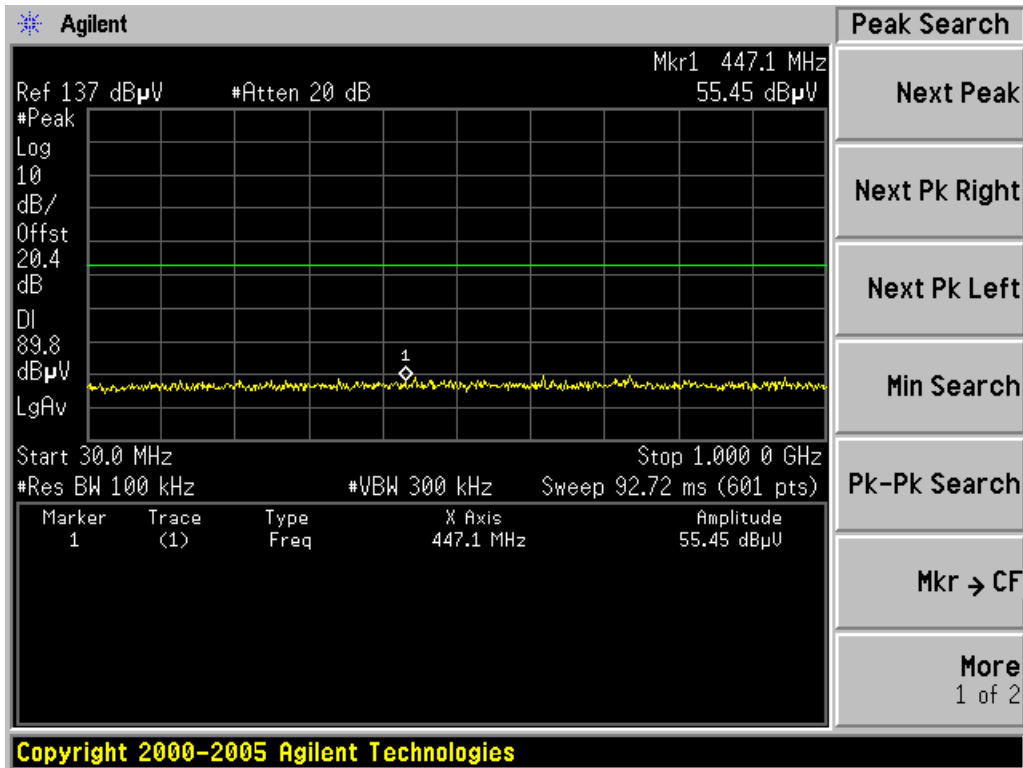

CH Mid : 30MHz-2.6.5GHz

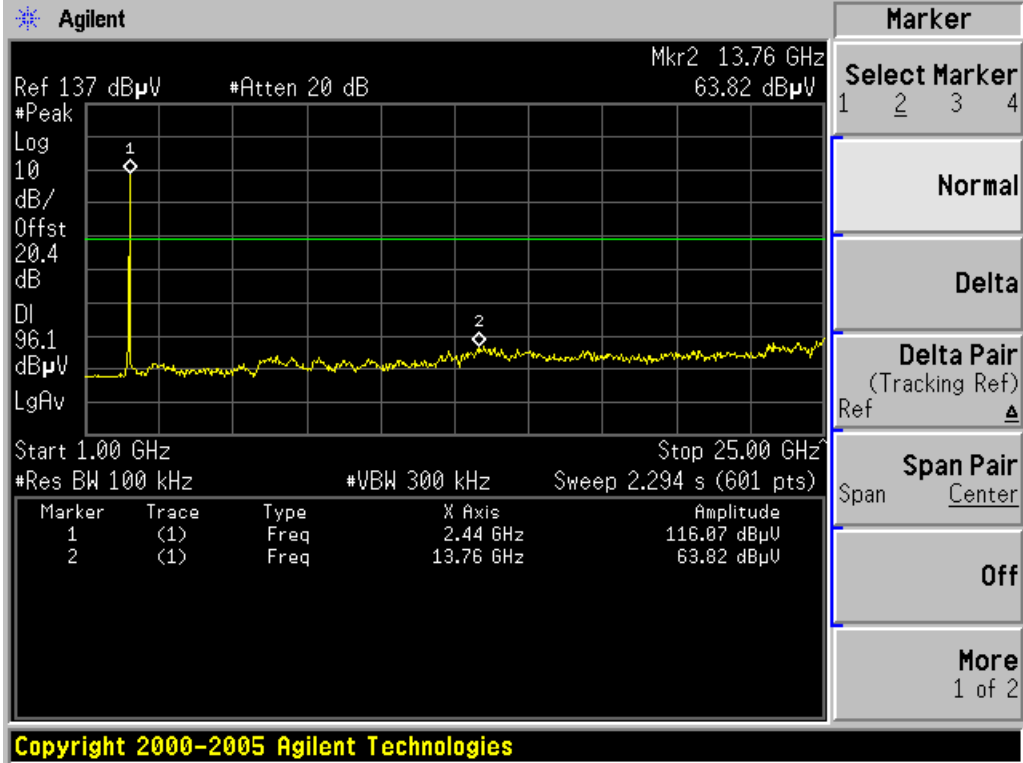
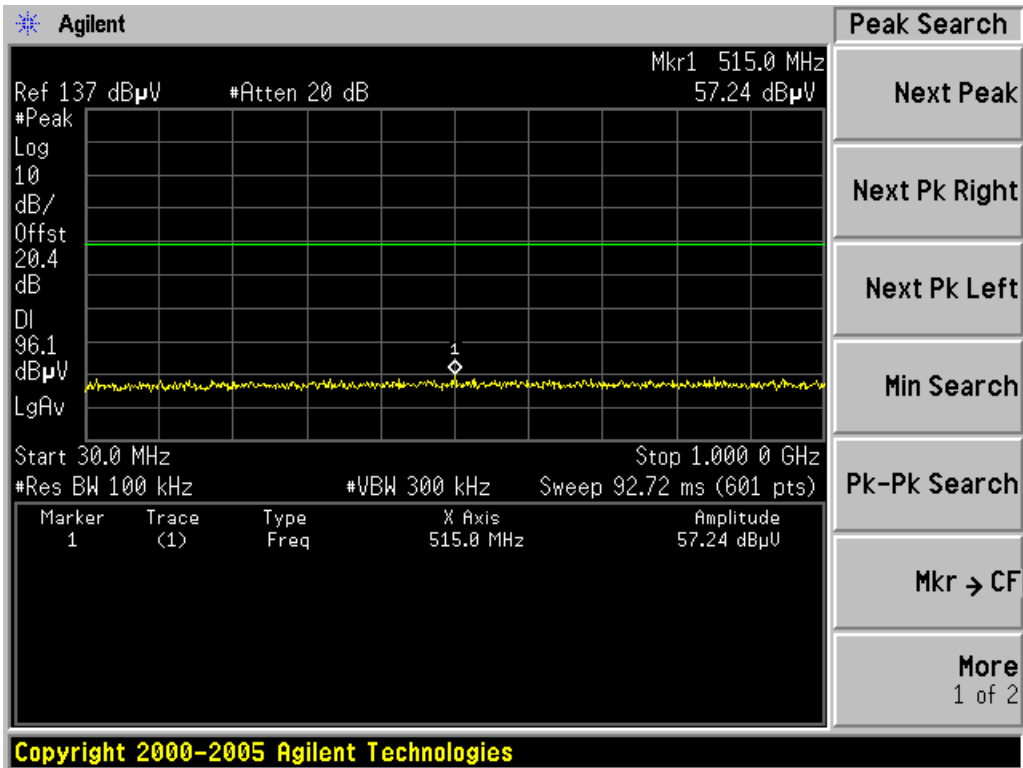

CH High : 30MHz-2.6.5GHz

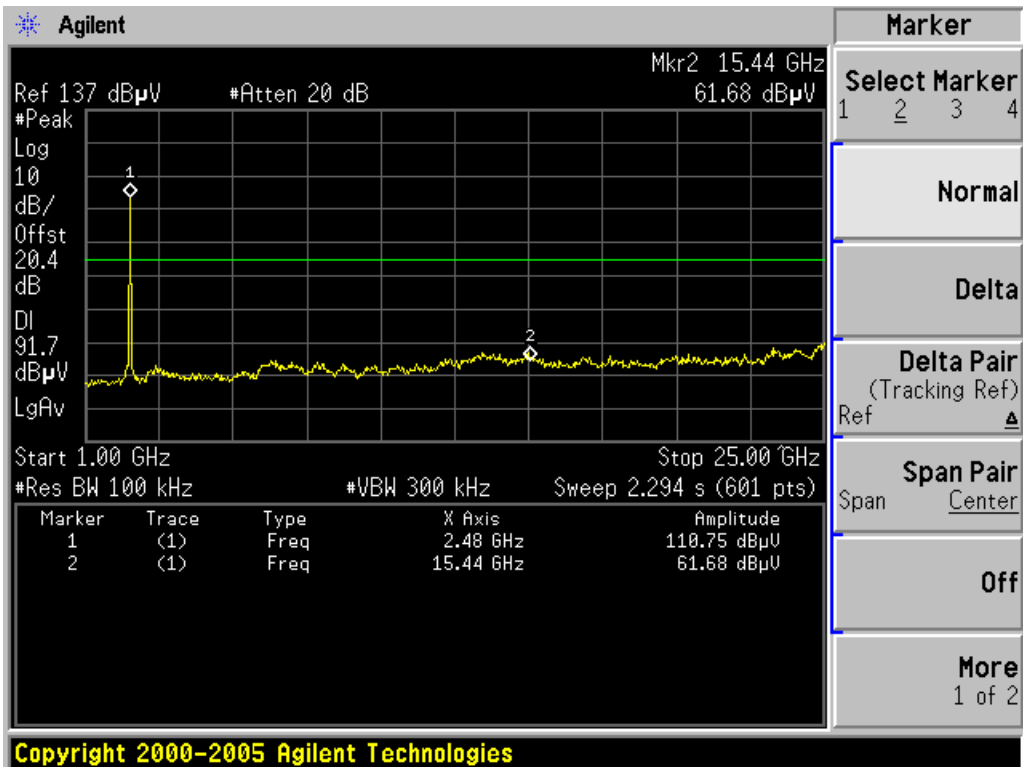
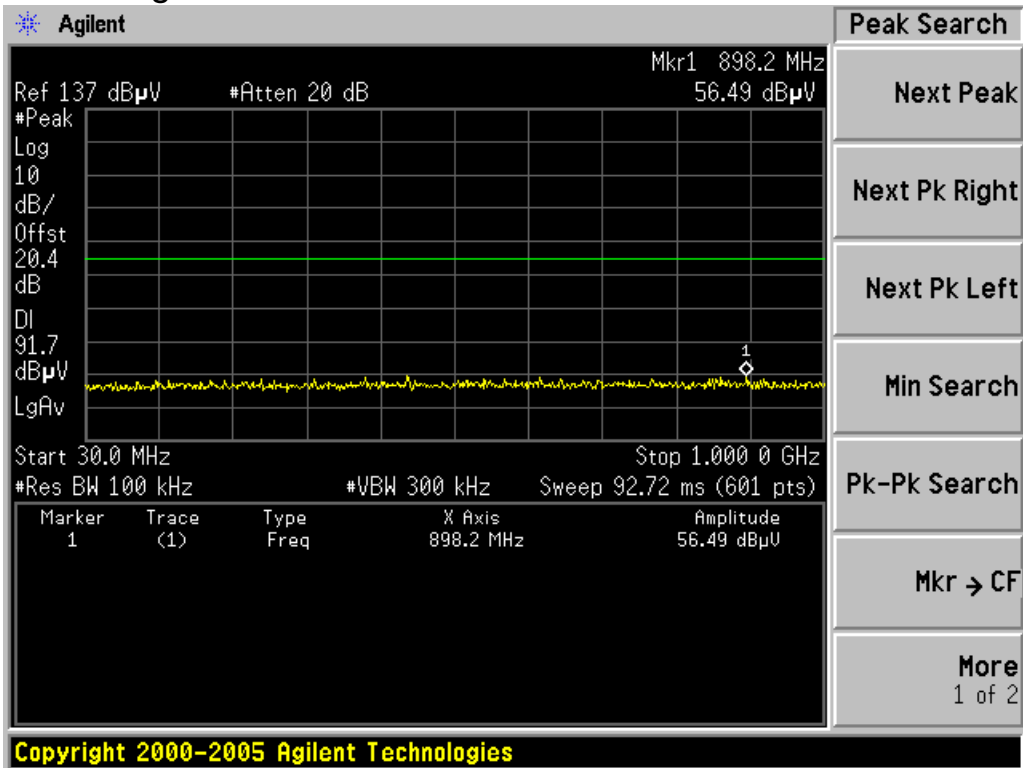

5.2 Radiation Emission

5.2.1 Radiation Emission Limits(15.209)

Frequencies (MHz)	Field Strength (micorvolts/meter)	Measurement Distance (meters)
0.009~0.490	2400/F(KHz)	300
0.490~1.705	24000/F(KHz)	30
1.705~30.0	30	30
30~88	100	3
88~216	150	3
216~960	200	3
Above 960	500	3

Harmonic emissions limits comply with below 54 dBuV/m at 3m. Other emissions radiated outside of the specified frequency bands, except for harmonics, shall be attenuated by at least 50 dB below the level of the fundamental or comply with the radiated emissions limits specified in section 15.209(a) limit in the table below has to be followed.

NOTE:

- a) The tighter limit applies at the band edges.
- b) Emission Level(dB uV/m)=20log Emission Level(Uv/m)

5.2.2 Test Setup

See the next page

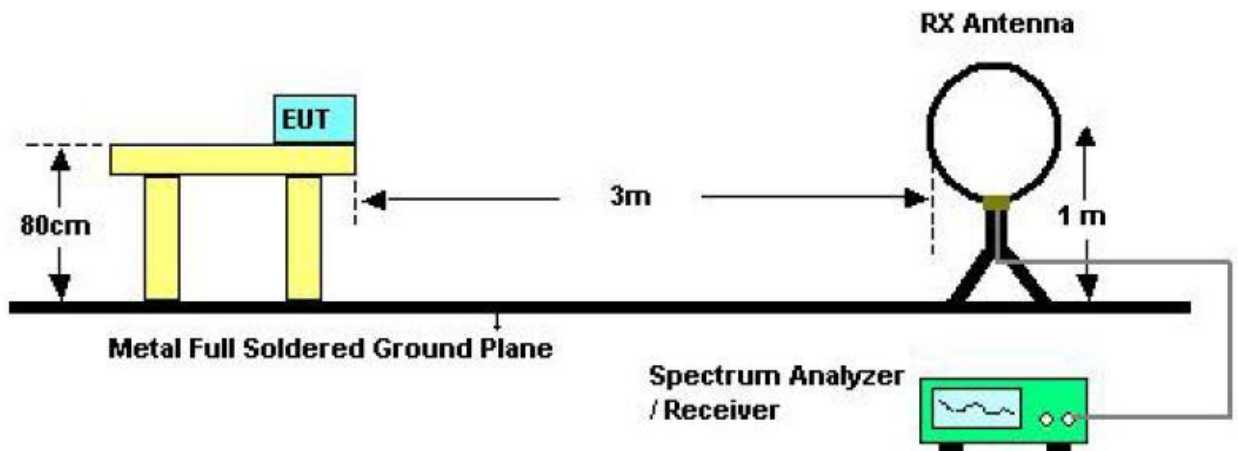

Below 30MHz Test Setup

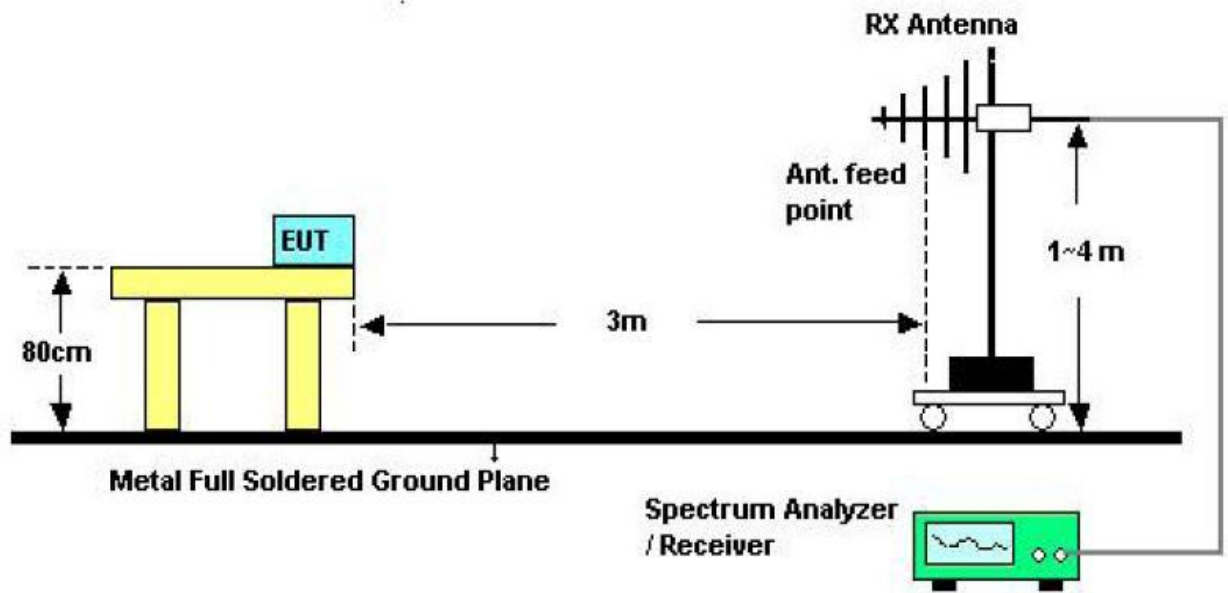

Above 30MHz Test Setup

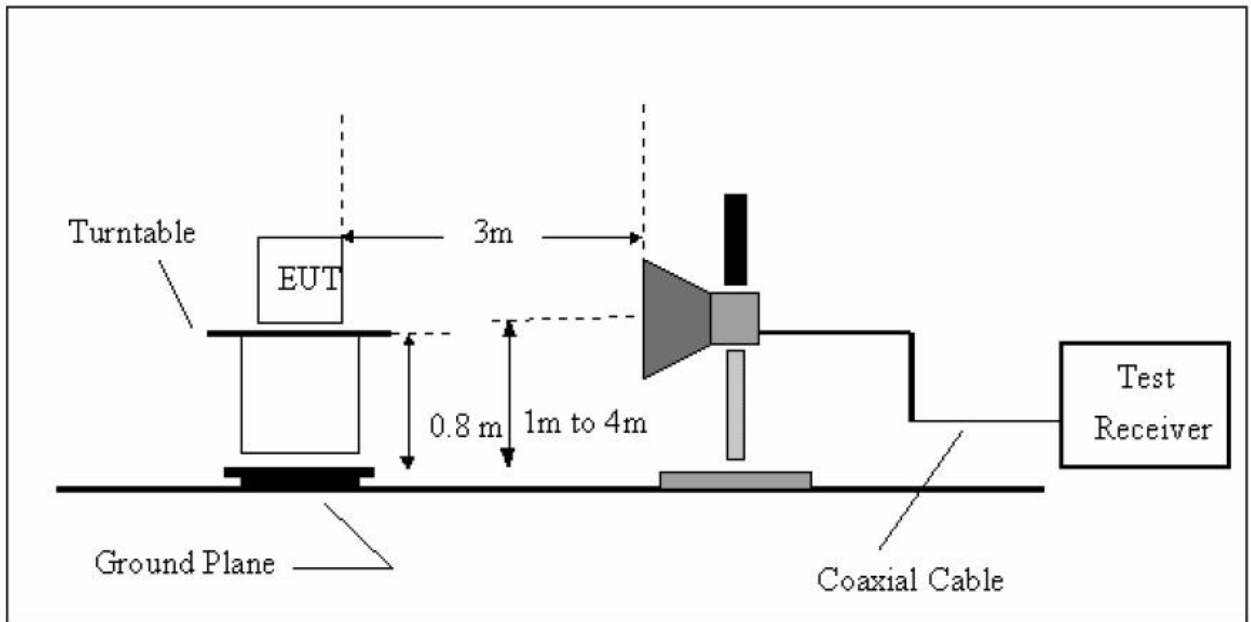

Above 1GHZ Test Setup

5.2.3 Test Procedure

- a) The measuring distance of 3m shall be used for measurements at frequency up to 1GHZ and above 1GHZ, The EUT was placed on a rotating 0.8 m high above ground,The table was rotated 360 degrees to determine the position of the highest radiation
- b) The Test antenna shall vary between 1m and 4m,Both Horizontal and Vertical antenna are set ot make measurement.
- c) The initial step in collecting conducted emission data is a spectrum analyzer Peak detector mode pre-scanning the measurement frequency range.Significent Peaks are then marked.and then Qusia Peak Detector mode remeasured
- d) If Peak value comply with QP limit Below 1GHZ.The EUT deemed to comply with QP limit.But the Peak value and average value both need to comply with applicable limit above 1GHZ.
- e) For the actual test configuration,please see the test setup photo.

5.2.4 Test Equipment Setting For emission test.est Result

9KHZ~150KHZ	RBW 200HZ	VBW1KHZ
150KHZ~30MHZ	RBW 9KHZ	VBW 30KHZ
30MHZ~1GHZ	RBW 120KHZ	VBW 300KHZ
Above 1GHZ	RBW 1MHZ	VBW 3MHZ

5.2.5 Test Condition

Continual Transmitting in maximum power.

5.2.6 Test Result

Detailed information please see the following page.

EUT	11N 150M WIRELESS Router	Model Name	BL-MP01
Temperature	26°C	Relative Humidity	56%
Pressure	960hPa	Test voltage	DC 5V supply by PC
Test Mode	TX		

Freq. (MHz)	Ant.Pol. H/V	Detector Mode (PK/OP)	Reading (dBuV)	Factor (dB)	Actual FS (dBuV/m)	Limits 3m (dBuV/m)	Margin (dBuV/m)
120.21	V	Peak	53.01	-13.67	39.34	43.50	-4.16
359.80	V	Peak	52.55	-11.02	41.53	46.00	-4.47
480.08	V	Peak	49.22	-8.42	40.80	46.00	-5.20
600.36	V	Peak	45.01	-6.30	38.71	46.00	-7.29
720.64	V	Peak	43.98	-4.37	39.61	46.00	-6.39
960.23	V	Peak	44.30	-1.52	42.78	54.00	-11.22

EUT	11N 150M WIRELESS Router	Model Name	BL-MP01
Temperature	26°C	Relative Humidity	56%
Pressure	960hPa	Test voltage	DC 5V supply by PC
Test Mode	TX		

Freq. (MHz)	Ant.Pol. H/V	Detector Mode (PK/OP)	Reading (dBuV)	Factor (dB)	Actual FS (dBuV/m)	Limits 3m (dBuV/m)	Margin (dBuV/m)
119.24	H	Peak	53.02	-13.85	39.17	43.50	-4.33
359.80	H	Peak	53.75	-11.02	42.73	46.00	-3.27
600.36	H	Peak	47.22	-6.30	40.92	46.00	-5.08
720.64	H	Peak	46.07	-4.37	41.70	46.00	-4.30
840.92	H	Peak	44.52	-3.04	41.48	46.00	-4.52
960.23	H	Peak	43.03	-1.52	41.51	54.00	-12.49

Notes: Above is Below 1GHZ test data

IEEE 802.11b

EUT	11N 150M WIRELESS Router	Model Name	BL-MP01
Temperature	26°C	Relative Humidity	56%
Pressure	960hPa	Test voltage	DC 5V supply by PC
Test Mode	TX Low		

Freq. (MHz)	Ant. Pol H/V	Peak Reading (dBuV)	AV Reading (dBuV)	Ant. / CL CF (dB)	Actual Fs		Peak Limit (dBuV/m)	AV Limit (dBuV/m)	Margin (dB)	Remark
					Peak (dBuV/m)	AV (dBuV/m)				
1436	V	51.11	---	-10.29	40.82	---	74.00	54.00	-13.18	Peak
1724	V	51.81	---	-9.53	42.28	---	74.00	54.00	-11.72	Peak
1843	V	53.48	---	-9.16	44.32	---	74.00	54.00	-9.68	Peak
4823	V	46.05	---	0.64	46.69	---	74.00	54.00	-7.31	Peak
N/A										

EUT	11N 150M WIRELESS Router	Model Name	BL-MP01
Temperature	26°C	Relative Humidity	56%
Pressure	960hPa	Test voltage	DC 5V supply by PC
Test Mode	TX Low		

Freq. (MHz)	Ant. Pol H/V	Peak Reading (dBuV)	AV Reading (dBuV)	Ant. / CL CF (dB)	Actual Fs		Peak Limit (dBuV/m)	AV Limit (dBuV/m)	Margin (dB)	Remark
					Peak (dBuV/m)	AV (dBuV/m)				
1165	H	54.14	---	-11.73	42.41	---	74.00	54.00	-11.59	Peak
2128	H	49.72	---	-8.36	41.36	---	74.00	54.00	-12.64	Peak
3047	H	47.98	---	-5.81	42.17	---	74.00	54.00	-11.83	Peak
4823	H	43.50	---	0.64	44.14	---	74.00	54.00	-9.86	Peak
N/A										

Notes: AV Means AV detector test data, Peak Means Peak detector test data.
Emissions attenuated more than 20 dB below the permissible value are not reported.

EUT	11N 150M WIRELESS Router	Model Name	BL-MP01
Temperature	26°C	Relative Humidity	56%
Pressure	960hPa	Test voltage	DC 5V supply by PC
Test Mode	TX Mid		

Freq. (MHz)	Ant. Pol H/V	Peak Reading (dBuV)	AV Reading (dBuV)	Ant. / CL CF (dB)	Actual Fs		Peak Limit (dBuV/m)	AV Limit (dBuV/m)	Margin (dB)	Remark
					Peak (dBuV/m)	AV (dBuV/m)				
1437	V	52.45	---	-10.29	42.16	---	74.00	54.00	-11.84	Peak
1853	V	52.28	---	-9.04	43.24	---	74.00	54.00	-10.76	Peak
2962	V	47.60	---	-5.95	41.65	---	74.00	54.00	-12.35	Peak
4871	V	44.68	---	0.76	45.44	---	74.00	54.00	-8.56	Peak

EUT	11N 150M WIRELESS Router	Model Name	BL-MP01
Temperature	26°C	Relative Humidity	56%
Pressure	960hPa	Test voltage	DC 5V supply by PC
Test Mode	TX Mid		

Freq. (MHz)	Ant. Pol H/V	Peak Reading (dBuV)	AV Reading (dBuV)	Ant. / CL CF (dB)	Actual Fs		Peak Limit (dBuV/m)	AV Limit (dBuV/m)	Margin (dB)	Remark
					Peak (dBuV/m)	AV (dBuV/m)				
1356	H	52.64	---	-10.43	42.21	---	74.00	54.00	-11.79	Peak
1729	H	52.95	---	-9.53	43.42	---	74.00	54.00	-10.58	Peak
3463	H	47.32	---	-4.95	42.37	---	74.00	54.00	-11.63	Peak
4871	H	43.56	---	0.76	44.32	---	74.00	54.00	-9.68	Peak

Notes: AV Means AV detector test data, Peak Means Peak detector test data.
Emissions attenuated more than 20 dB below the permissible value are not reported.

EUT	11N 150M WIRELESS Router	Model Name	BL-MP01
Temperature	26°C	Relative Humidity	56%
Pressure	960hPa	Test voltage	DC 5V supply by PC
Test Mode	TX High		

Freq. (MHz)	Ant. Pol H/V	Peak Reading (dBuV)	AV Reading (dBuV)	Ant. / CL CF (dB)	Actual Fs		Peak Limit (dBuV/m)	AV Limit (dBuV/m)	Margin (dB)	Remark
					Peak (dBuV/m)	AV (dBuV/m)				
1162	V	54.79	---	-11.73	43.06	---	74.00	54.00	-10.94	Peak
1937	V	51.58	---	-8.86	42.72	---	74.00	54.00	-11.28	Peak
3053	V	47.21	---	-5.74	41.47	---	74.00	54.00	-12.53	Peak
4922	V	45.66	---	0.87	46.53	---	74.00	54.00	-7.47	Peak

EUT	11N 150M WIRELESS Router	Model Name	BL-MP01
Temperature	26°C	Relative Humidity	56%
Pressure	960hPa	Test voltage	DC 5V supply by PC
Test Mode	TX High		

Freq. (MHz)	Ant. Pol H/V	Peak Reading (dBuV)	AV Reading (dBuV)	Ant. / CL CF (dB)	Actual Fs		Peak Limit (dBuV/m)	AV Limit (dBuV/m)	Margin (dB)	Remark
					Peak (dBuV/m)	AV (dBuV/m)				
1943	H	51.03	---	-8.86	42.17	---	74.00	54.00	-11.83	Peak
3156	H	46.99	---	-5.52	41.47	---	74.00	54.00	-12.53	Peak
3682	H	47.97	---	-4.38	43.59	---	74.00	54.00	-10.41	Peak
4922	H	43.71	---	0.87	44.58	---	74.00	54.00	-9.42	Peak

Notes: AV Means AV detector test data, Peak Means Peak detector test data.
Emissions attenuated more than 20 dB below the permissible value are not reported.

IEEE 802.11 g:

EUT	11N 150M WIRELESS Router	Model Name	BL-MP01
Temperature	26°C	Relative Humidity	56%
Pressure	960hPa	Test voltage	DC 5V supply by PC
Test Mode	TX Low		

Freq. (MHz)	Ant. Pol H/V	Peak Reading (dBuV)	AV Reading (dBuV)	Ant. / CL CF (dB)	Actual Fs		Peak Limit (dBuV/m)	AV Limit (dBuV/m)	Margin (dB)	Remark
					Peak (dBuV/m)	AV (dBuV/m)				
1462	V	52.43	---	-10.27	42.16	---	74.00	54.00	-11.84	Peak
1869	V	49.35	---	-9.04	40.31	---	74.00	54.00	-13.69	Peak
2057	V	51.51	---	-8.49	43.02	---	74.00	54.00	-10.98	Peak
4823	V	43.71	---	0.64	44.35	---	74.00	54.00	-9.65	Peak
N/A										

EUT	11N 150M WIRELESS Router	Model Name	BL-MP01
Temperature	26°C	Relative Humidity	56%
Pressure	960hPa	Test voltage	DC 5V supply by PC
Test Mode	TX Low		

Freq. (MHz)	Ant. Pol H/V	Peak Reading (dBuV)	AV Reading (dBuV)	Ant. / CL CF (dB)	Actual Fs		Peak Limit (dBuV/m)	AV Limit (dBuV/m)	Margin (dB)	Remark
					Peak (dBuV/m)	AV (dBuV/m)				
1371	H	52.86	---	-10.43	42.43	---	74.00	54.00	-11.57	Peak
2854	H	47.44	---	-5.87	41.57	---	74.00	54.00	-12.43	Peak
2985	H	48.59	---	-5.86	42.73	---	74.00	54.00	-11.27	Peak
4823	H	42.82	---	0.64	43.46	---	74.00	54.00	-10.54	Peak
N/A										

Notes: AV Means AV detector test data, Peak Means Peak detector test data.
Emissions attenuated more than 20 dB below the permissible value are not reported.

EUT	11N 150M WIRELESS Router	Model Name	BL-MP01
Temperature	26°C	Relative Humidity	56%
Pressure	960hPa	Test voltage	DC 5V supply by PC
Test Mode	TX Mid		

Freq. (MHz)	Ant. Pol H/V	Peak Reading (dBuV)	AV Reading (dBuV)	Ant. / CL CF (dB)	Actual Fs		Peak Limit (dBuV/m)	AV Limit (dBuV/m)	Margin (dB)	Remark
					Peak (dBuV/m)	AV (dBuV/m)				
1464	V	52.46	---	-10.27	42.19	---	74.00	54.00	-11.81	Peak
1728	V	50.84	---	-9.53	41.31	---	74.00	54.00	-12.69	Peak
1940	V	51.49	---	-8.86	42.63	---	74.00	54.00	-11.37	Peak
4871	V	44.70	---	0.76	45.46	---	74.00	54.00	-8.54	Peak

EUT	11N 150M WIRELESS Router	Model Name	BL-MP01
Temperature	26°C	Relative Humidity	56%
Pressure	960hPa	Test voltage	DC 5V supply by PC
Test Mode	TX Mid		

Freq. (MHz)	Ant. Pol H/V	Peak Reading (dBuV)	AV Reading (dBuV)	Ant. / CL CF (dB)	Actual Fs		Peak Limit (dBuV/m)	AV Limit (dBuV/m)	Margin (dB)	Remark
					Peak (dBuV/m)	AV (dBuV/m)				
1385	H	51.62	---	-10.43	41.19	---	74.00	54.00	-12.81	Peak
1621	H	53.08	---	-9.84	43.24	---	74.00	54.00	-10.76	Peak
3736	H	46.66	---	-4.24	42.42	---	74.00	54.00	-11.58	Peak
4871	H	45.55	---	0.76	46.31	---	74.00	54.00	-7.69	Peak

Notes: AV Means AV detector test data, Peak Means Peak detector test data.
Emissions attenuated more than 20 dB below the permissible value are not reported.

EUT	11N 150M WIRELESS Router	Model Name	BL-MP01
Temperature	26°C	Relative Humidity	56%
Pressure	960hPa	Test voltage	DC 5V supply by PC
Test Mode	TX High		

Freq. (MHz)	Ant. Pol H/V	Peak Reading (dBuV)	AV Reading (dBuV)	Ant. / CL CF (dB)	Actual Fs		Peak Limit (dBuV/m)	AV Limit (dBuV/m)	Margin (dB)	Remark
					Peak (dBuV/m)	AV (dBuV/m)				
1488	V	52.30	---	-10.27	42.03	---	74.00	54.00	-11.97	Peak
2953	V	49.10	---	-5.86	43.24	---	74.00	54.00	-10.76	Peak
3761	V	45.58	---	-4.07	41.51	---	74.00	54.00	-12.49	Peak
4922	V	44.48	---	0.87	45.35	---	74.00	54.00	-8.65	Peak

EUT	11N 150M WIRELESS Router	Model Name	BL-MP01
Temperature	26°C	Relative Humidity	56%
Pressure	960hPa	Test voltage	DC 5V supply by PC
Test Mode	TX High		

Freq. (MHz)	Ant. Pol H/V	Peak Reading (dBuV)	AV Reading (dBuV)	Ant. / CL CF (dB)	Actual Fs		Peak Limit (dBuV/m)	AV Limit (dBuV/m)	Margin (dB)	Remark
					Peak (dBuV/m)	AV (dBuV/m)				
1859	H	50.80	---	-9.04	41.76	---	74.00	54.00	-12.24	Peak
3046	H	48.13	---	-5.81	42.32	---	74.00	54.00	-11.68	Peak
4234	H	45.58	---	-2.31	43.27	---	74.00	54.00	-10.73	Peak
4922	H	45.17	---	0.87	46.04	---	74.00	54.00	-7.96	Peak

Notes: AV Means AV detector test data, Peak Means Peak detector test data.
Emissions attenuated more than 20 dB below the permissible value are not reported.

IEEE 802.11n

EUT	11N 150M WIRELESS Router	Model Name	BL-MP01
Temperature	26°C	Relative Humidity	56%
Pressure	960hPa	Test voltage	DC 5V supply by PC
Test Mode	TX Low		

Freq. (MHz)	Ant. Pol H/V	Peak Reading (dBuV)	AV Reading (dBuV)	Ant. / CL CF (dB)	Actual Fs		Peak Limit (dBuV/m)	AV Limit (dBuV/m)	Margin (dB)	Remark
					Peak (dBuV/m)	AV (dBuV/m)				
1821	V	51.62	---	-9.16	42.46	---	74.00	54.00	-11.54	Peak
2037	V	49.72	---	-8.58	41.14	---	74.00	54.00	-12.86	Peak
3459	V	47.56	---	-4.95	42.61	---	74.00	54.00	-11.39	Peak
4823	V	45.08	---	0.64	45.72	---	74.00	54.00	-8.28	Peak
N/A										

EUT	11N 150M WIRELESS Router	Model Name	BL-MP01
Temperature	26°C	Relative Humidity	56%
Pressure	960hPa	Test voltage	DC 5V supply by PC
Test Mode	TX Low		

Freq. (MHz)	Ant. Pol H/V	Peak Reading (dBuV)	AV Reading (dBuV)	Ant. / CL CF (dB)	Actual Fs		Peak Limit (dBuV/m)	AV Limit (dBuV/m)	Margin (dB)	Remark
					Peak (dBuV/m)	AV (dBuV/m)				
1432	H	53.92	---	-10.29	43.63	---	74.00	54.00	-10.37	Peak
1649	H	51.69	---	-9.84	41.85	---	74.00	54.00	-12.15	Peak
2853	H	48.14	---	-5.87	42.27	---	74.00	54.00	-11.73	Peak
4823	H	43.74	---	0.64	44.38	---	74.00	54.00	-9.62	Peak
N/A										

Notes: AV Means AV detector test data, Peak Means Peak detector test data.
Emissions attenuated more than 20 dB below the permissible value are not reported.

EUT	11N 150M WIRELESS Router	Model Name	BL-MP01
Temperature	26°C	Relative Humidity	56%
Pressure	960hPa	Test voltage	DC 5V supply by PC
Test Mode	TX Mid		

Freq. (MHz)	Ant. Pol H/V	Peak Reading (dBuV)	AV Reading (dBuV)	Ant. / CL CF (dB)	Actual Fs		Peak Limit (dBuV/m)	AV Limit (dBuV/m)	Margin (dB)	Remark
					Peak (dBuV/m)	AV (dBuV/m)				
1194	V	56.09	---	-11.73	44.36	---	74.00	54.00	-9.64	Peak
1963	V	49.77	---	-8.64	41.13	---	74.00	54.00	-12.87	Peak
3572	V	47.23	---	-4.76	42.47	---	74.00	54.00	-11.53	Peak
4871	V	42.75	---	0.76	43.51	---	74.00	54.00	-10.49	Peak

EUT	11N 150M WIRELESS Router	Model Name	BL-MP01
Temperature	26°C	Relative Humidity	56%
Pressure	960hPa	Test voltage	DC 5V supply by PC
Test Mode	TX Mid		

Freq. (MHz)	Ant. Pol H/V	Peak Reading (dBuV)	AV Reading (dBuV)	Ant. / CL CF (dB)	Actual Fs		Peak Limit (dBuV/m)	AV Limit (dBuV/m)	Margin (dB)	Remark
					Peak (dBuV/m)	AV (dBuV/m)				
1736	H	51.85	---	-9.53	42.32	---	74.00	54.00	-11.68	Peak
2684	H	48.23	---	-6.94	41.29	---	74.00	54.00	-12.71	Peak
3511	H	47.41	---	-4.87	42.54	---	74.00	54.00	-11.46	Peak
4871	H	43.67	---	0.76	44.43	---	74.00	54.00	-9.57	Peak

Notes: AV Means AV detector test data, Peak Means Peak detector test data.
Emissions attenuated more than 20 dB below the permissible value are not reported.

EUT	11N 150M WIRELESS Router	Model Name	BL-MP01
Temperature	26°C	Relative Humidity	56%
Pressure	960hPa	Test voltage	DC 5V supply by PC
Test Mode	TX High		

Freq. (MHz)	Ant. Pol H/V	Peak Reading (dBuV)	AV Reading (dBuV)	Ant. / CL CF (dB)	Actual Fs		Peak Limit (dBuV/m)	AV Limit (dBuV/m)	Margin (dB)	Remark
					Peak (dBuV/m)	AV (dBuV/m)				
1324	V	52.53	---	-10.84	41.69	---	74.00	54.00	-12.31	Peak
1762	V	51.54	---	-9.27	42.27	---	74.00	54.00	-11.73	Peak
2028	V	50.89	---	-8.58	42.31	---	74.00	54.00	-11.69	Peak
4922	V	42.61	---	0.87	43.48	---	74.00	54.00	-10.52	Peak

EUT	11N 150M WIRELESS Router	Model Name	BL-MP01
Temperature	26°C	Relative Humidity	56%
Pressure	960hPa	Test voltage	DC 5V supply by PC
Test Mode	TX High		

Freq. (MHz)	Ant. Pol H/V	Peak Reading (dBuV)	AV Reading (dBuV)	Ant. / CL CF (dB)	Actual Fs		Peak Limit (dBuV/m)	AV Limit (dBuV/m)	Margin (dB)	Remark
					Peak (dBuV/m)	AV (dBuV/m)				
1937	H	50.24	---	-8.86	41.38	---	74.00	54.00	-12.62	Peak
3426	H	48.73	---	-5.09	43.64	---	74.00	54.00	-10.36	Peak
4158	H	46.74	---	-2.48	44.26	---	74.00	54.00	-9.74	Peak
4922	H	43.07	---	0.87	43.94	---	74.00	54.00	-10.06	Peak

Notes: AV Means AV detector test data, Peak Means Peak detector test data.
Emissions attenuated more than 20 dB below the permissible value are not reported.

6 POWER LINE CONDUCTED EMISSION

6.1 Conducted Emission Limits(15.209&249)

Frequency MHz	Limits dB(μ V)	
	Quasi-peak Level	Average Level
0.15 -0.50	66 -56*	56 - 46*
0.50 -5.00	56	46
5.00 -30.00	60	50

- Notes: 1. *Decreasing linearly with logarithm of frequency.
 2. The lower limit shall apply at the transition frequencies.
 3. The limit decreases in line with the logarithm of the frequency in the rang of 0.15 to 0.50 MHz.

6.2 Test Setup

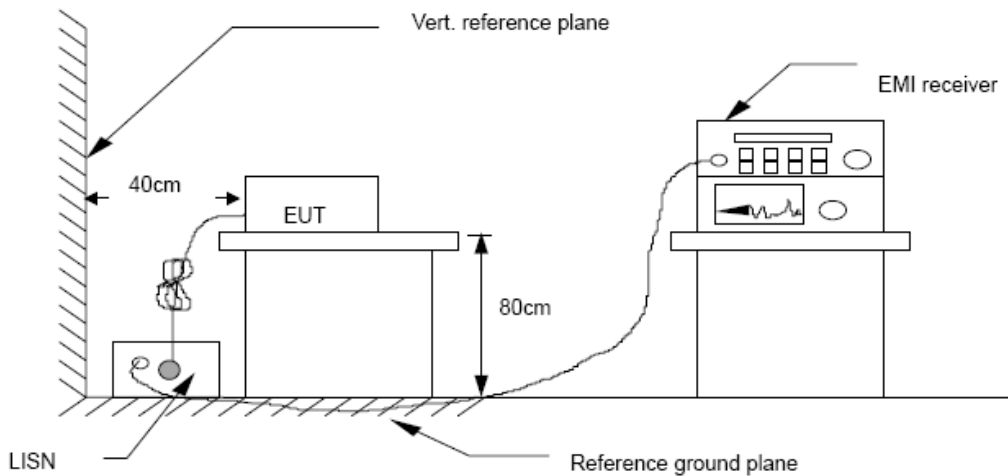

6.3 Test Procedure

The EUT is put on the plane 0.8m high above the ground by insulating support and is connected to the power mains through a line impedance stabilization network (L.I.S.N.). This provides a 50ohm coupling impedance for the EUT system. Please refer the block diagram of the test setup and photographs. Both sides of AC lines are checked to find out the maximum conducted emission. In order to find the maximum emission levels, the relative positions of equipment and all of the interface cables shall be changed according to ANSI C63.4-2003 on Conducted Emission Measurement.

The bandwidth of test receiver (R & S ESCS30) is set at 9 kHz.

6.4 Test Results

PASS

Detailed information please see the following page.

EUT	11N 150M WIRELESS Router	Model Name	BL-MP01
Temperature	25°C	Relative Humidity	58%
Pressure	960hPa	Test voltage	DC 5V supply by PC
Test Mode	Noraml		

FREQ MHz	PEAK dBuV	Q.P. See Peak dBuV	AVG See Peak dBuV	Q.P. Limit dBuV	AVG Limit dBuV	Q.P. Margin dBuV	AVG Margin dBuV	NOTE
0.21	17.72	---	---	63.32	53.32	-45.60	-35.60	L1
2.49	24.88	---	---	56.00	46.00	-31.12	-21.12	L1
4.29	32.34	---	---	56.00	46.00	-23.66	-13.66	L1
5.03	28.95	---	---	60.00	50.00	-31.05	-21.05	L1
8.64	31.89	---	---	60.00	50.00	-28.11	-18.11	L1
12.25	31.41	---	---	60.00	50.00	-28.59	-18.59	L1
0.21	22.84	---	---	63.23	53.23	-40.39	-30.39	L2
1.59	12.05	---	---	56.00	46.00	-43.95	-33.95	L2
3.22	31.79	---	---	56.00	46.00	-24.21	-14.21	L2
4.01	34.08	---	---	56.00	46.00	-21.92	-11.92	L2
8.82	30.98	---	---	60.00	50.00	-29.02	-19.02	L2
12.25	28.52	---	---	60.00	50.00	-31.48	-21.48	L2

Note: L1=Line One (Live Line) /L2= Line Two (Neutral Line)
 PEAK greater than QP greater than AVG

7 Peak Power

7.1 Test limit

Please refer section 15.247.

Regulation 15.247(b) The limit of Maximum Peak Output Power Measurement is 1W(30dBm)

7.2 Test Procedure

The transmitter output is connected to the RF Power Meter. The RF Power Meter is set to the peak power detection.

7.3 Test Setup

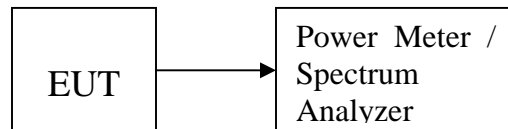

7.4 Test Results

Channel	Frequency (MHz)	Reading Power (dBm)	Factor (dB)	Out put Power (dBm)	Out put Power (W)	Limit (W)	Result
IEEE 802.11b:							
Mid	2412	8.21	2.50	10.71	0.01178	1	PASS
High	2437	8.58	2.50	11.08	0.01282		PASS
Low	2462	8.75	2.50	11.25	0.01334		PASS
IEEE 802.11g:							
Low	2412	8.13	2.50	10.63	0.01156	1	PASS
Mid	2437	8.26	2.50	10.76	0.01191		PASS
High	2462	8.74	2.50	11.24	0.01331		PASS
IEEE 802.11n:							
Low	2412	8.52	2.50	11.02	0.01265	1	PASS
Mid	2437	8.37	2.50	10.87	0.01221		PASS
High	2462	8.24	2.50	10.74	0.01185		PASS

8 PEAK POWER SPECTRAL DENSITY

8.1 Test limit

8.1.1 Please refer section 15.247.

8.1.2 For direct sequence systems, the peak power spectral density conducted from the intentional radiator to the antenna shall not be greater than 8dBm in any 3kHz band during any time interval of continuous transmission.

8.1.3 The direct sequence operating of the hybrid system, with the frequency hopping operation turned off, shall comply with the power density requirements of paragraph (d) of this section.

8.2 Method of measurement

8.2.1 Place the EUT on the table and set it in transmitting mode.

8.2.2 Remove the antenna from the EUT and then connect a low loss RF cable from the antenna port to the spectrum analyzer.

8.2.3 Set the spectrum analyzer as RBW = 3kHz, VBW = 10kHz, Span = 300kHz, Sweep=100s.

8.2.4 Record the max. reading.

8.2.5 Repeat the above procedure until the measurements for all frequencies are completed.

8.3 Test Setup

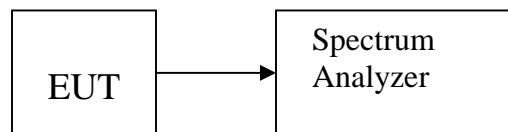

8.4 Test Results

PASS.

Detailed information please see the following page.

IEEE 802.11b:

CH Low :

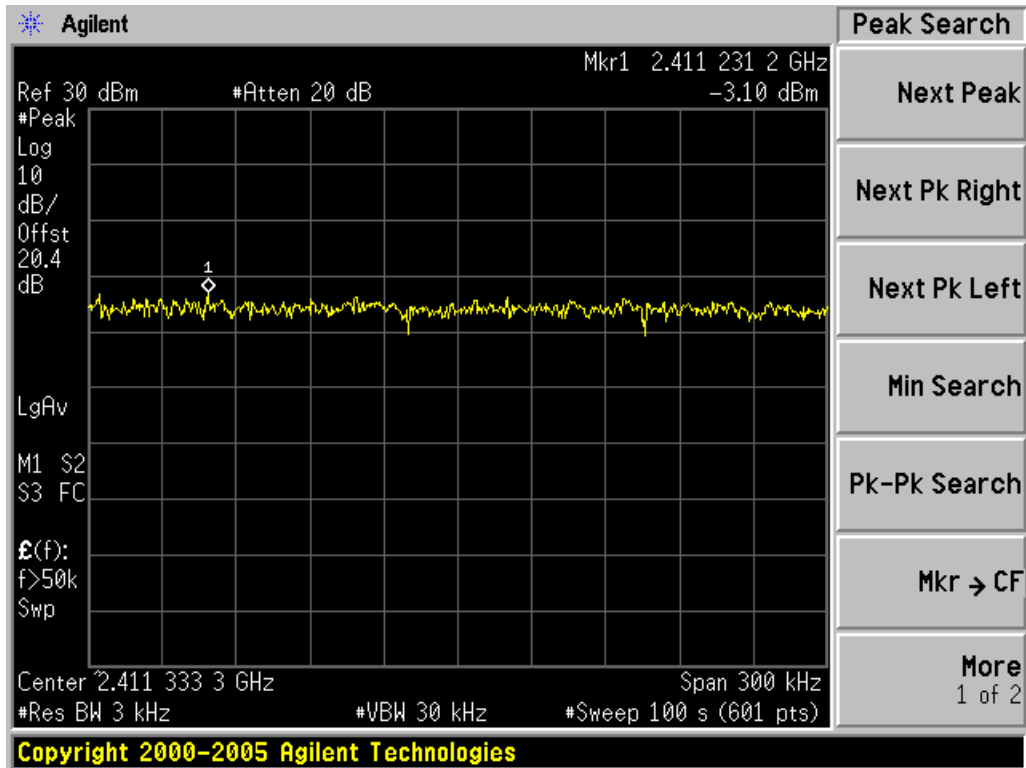

CH Mid :

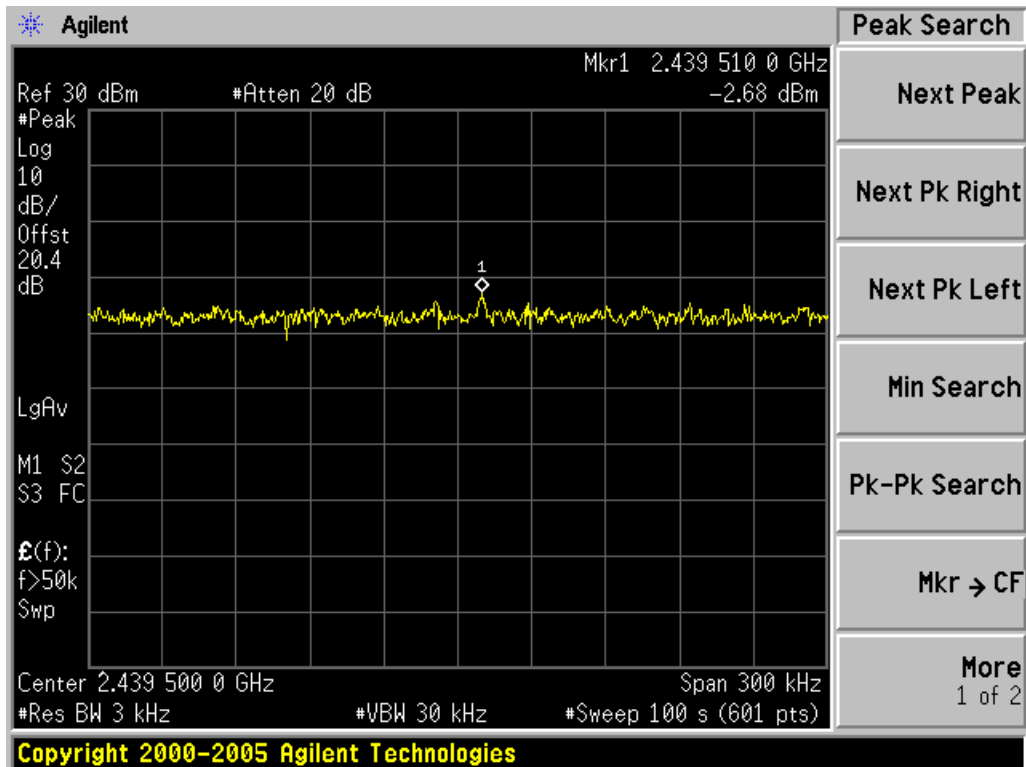

CH High :

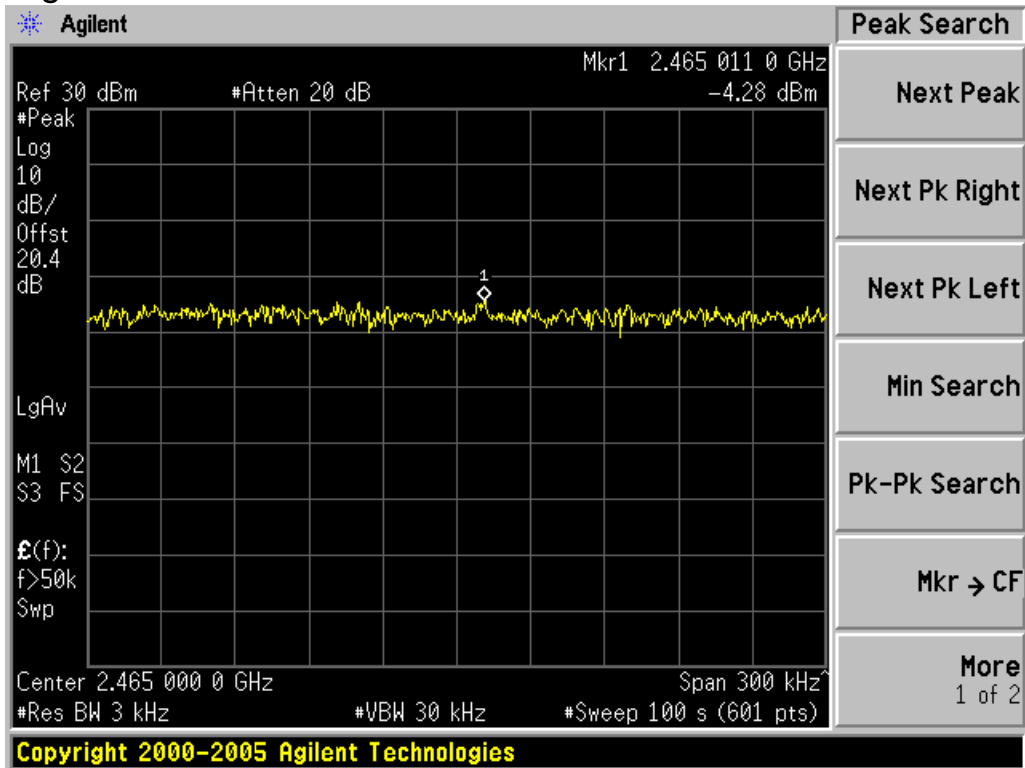

IEEE 802.11g:

CH Low :

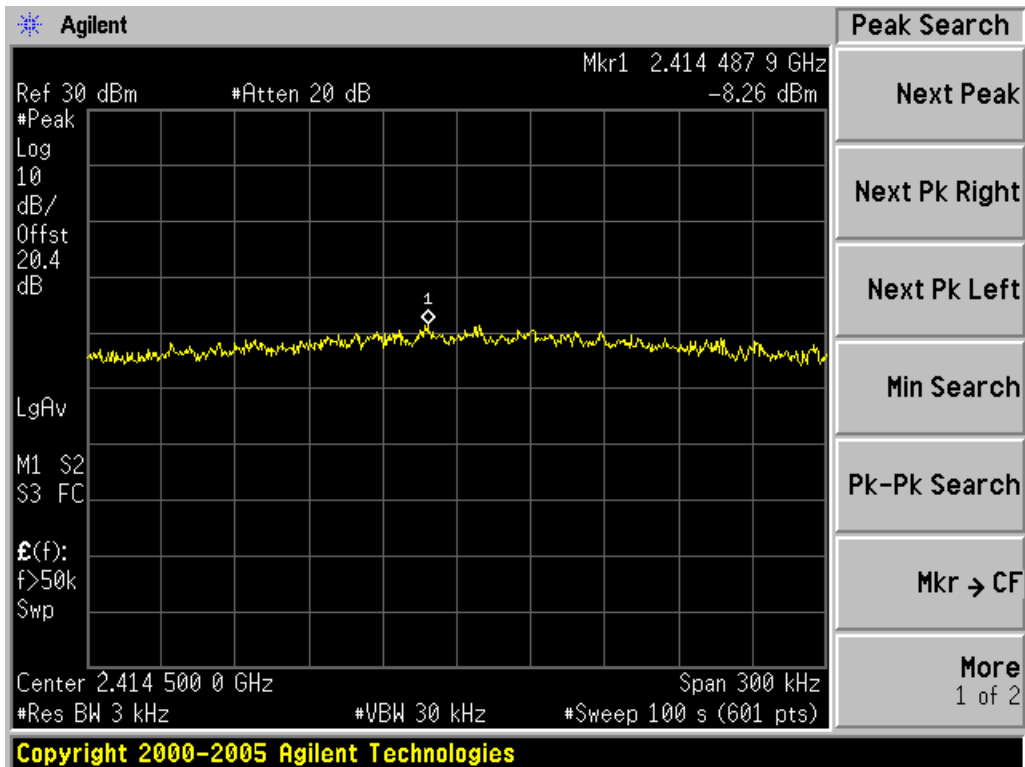

CH Mid :

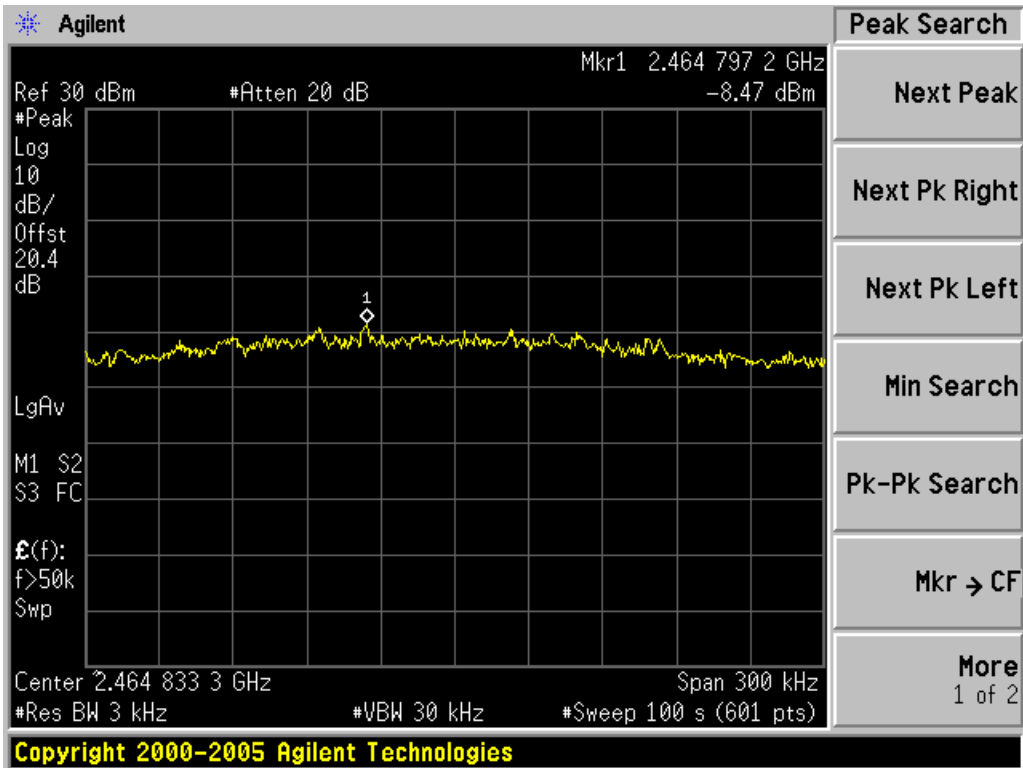

CH High :

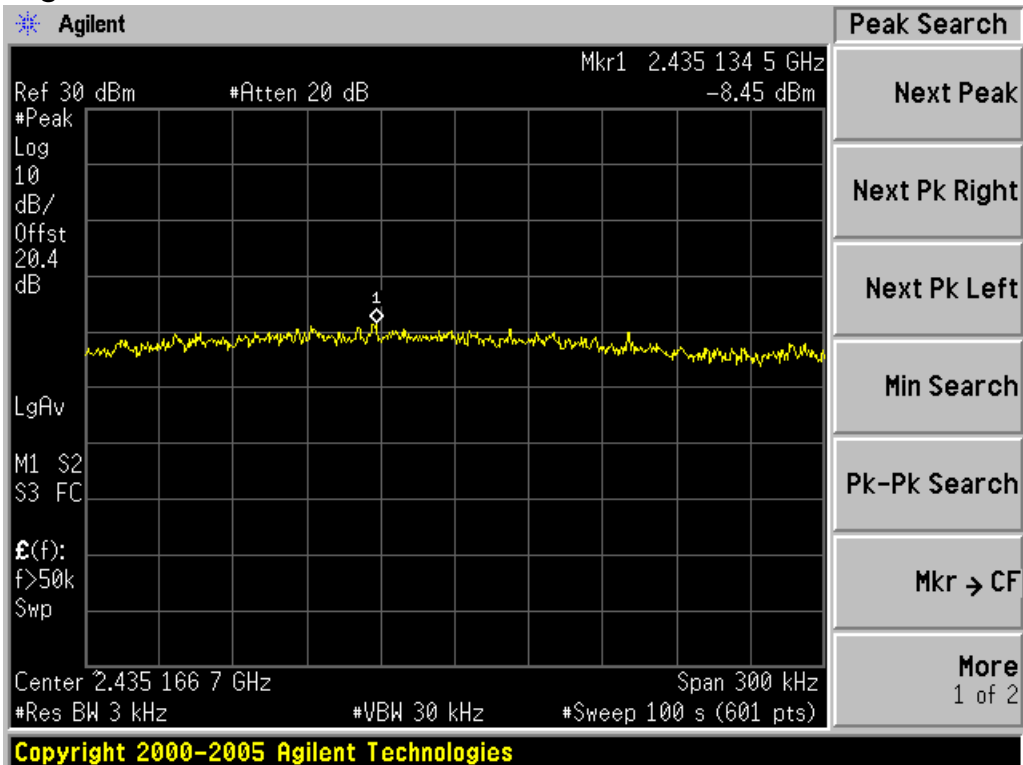

IEEE 802.11n:

CH Low :

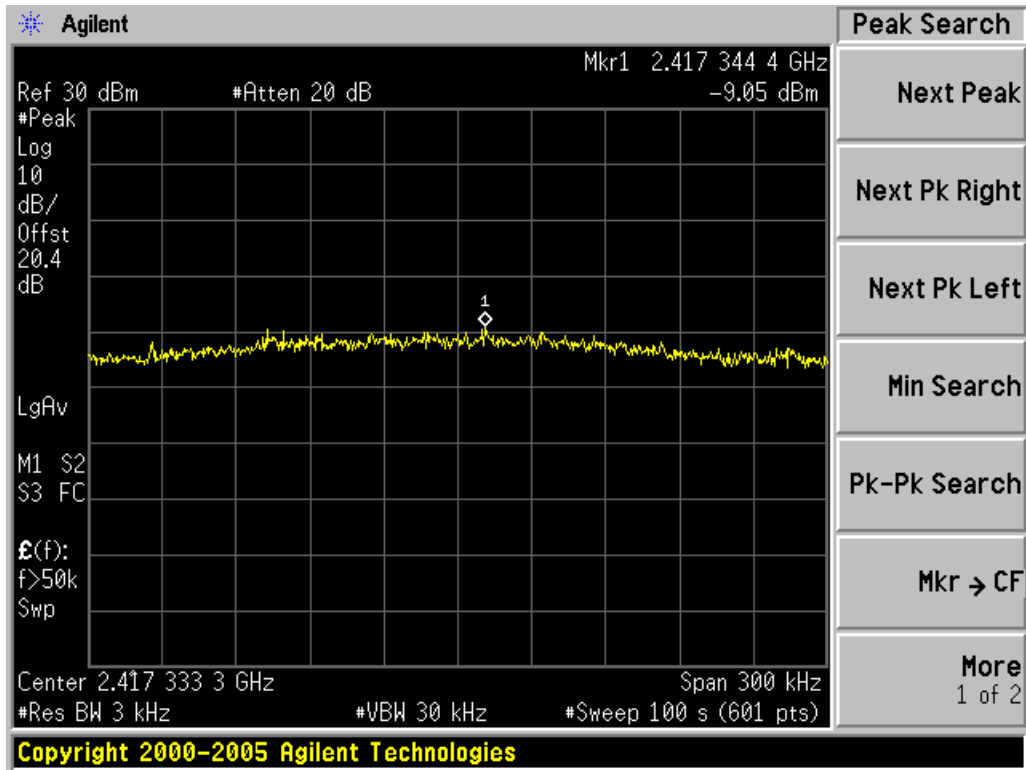

CH Mid :

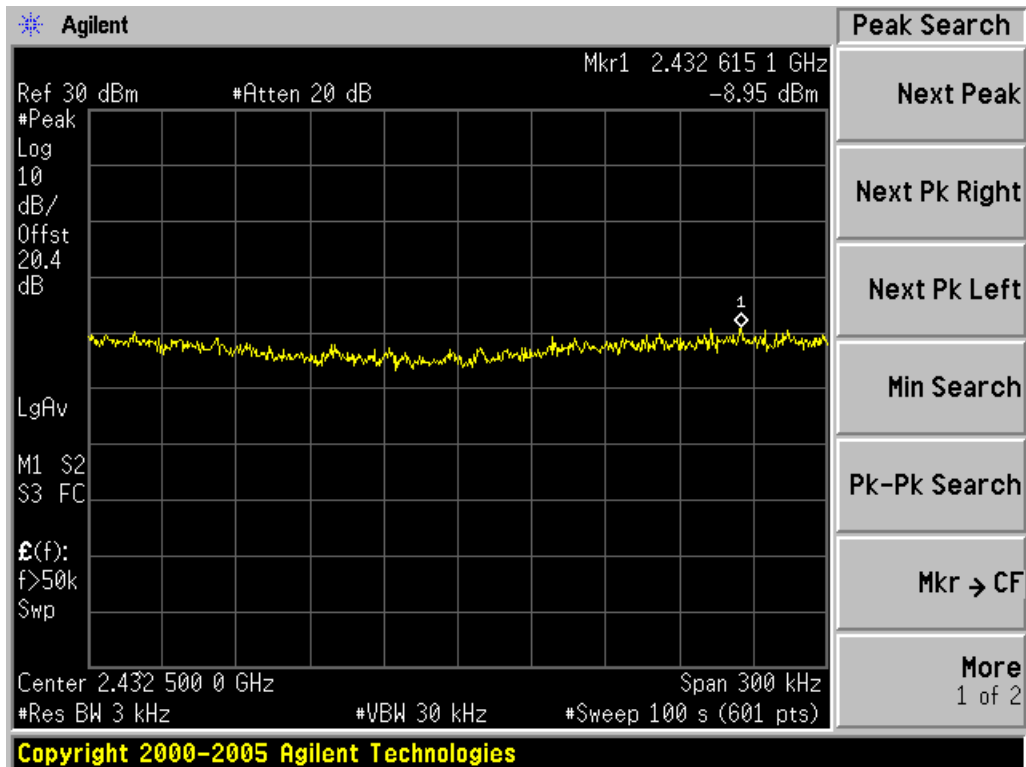

CH High :

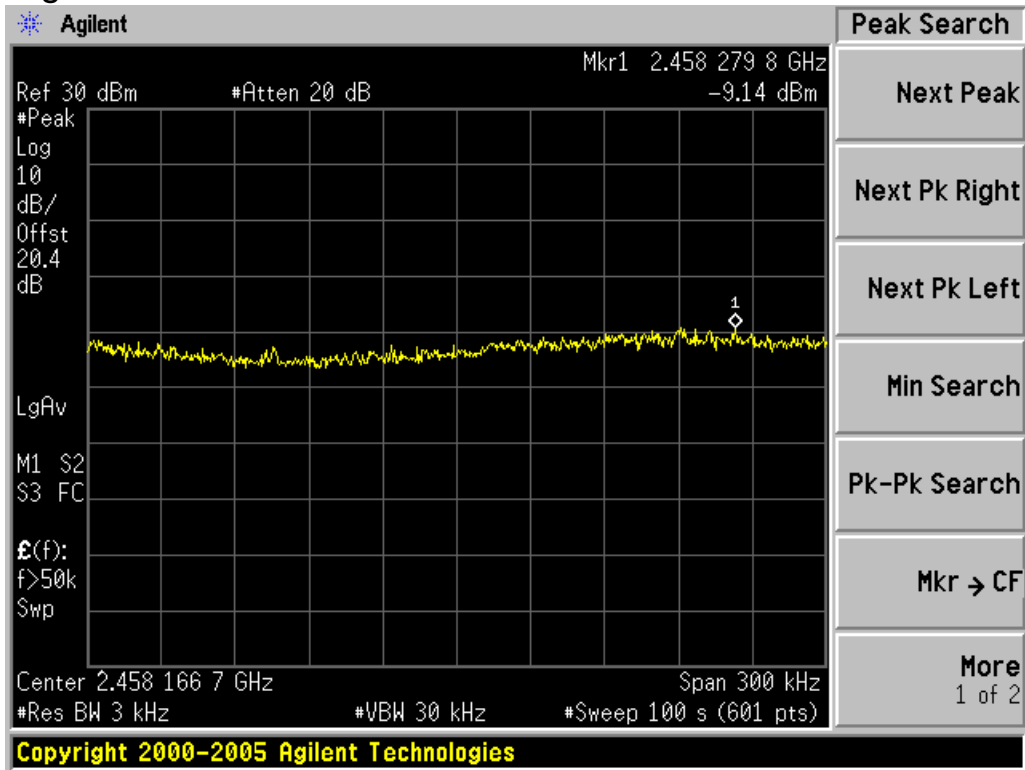

9 6dB Bandwidth

9.1 Test limit

Please refer section 15.247

For direct sequence systems, the minimum 6dB bandwidth shall be at least 500kHz.

9.2 Method of measurement

a) The bandwidth is measured at an amplitude level reduced 20dB from the reference level. The reference level is the level of the highest amplitude signal observed from the transmitter at the fundamental frequency. Once the reference level is established, the equipment is conditioned with typical modulating signal to produce the worst-case (i.e. the widest) bandwidth.

b) The test receiver RBW set 100KHZ, VBW set 100KHZ, Sweep time set auto.

9.3 Test Setup

Same as 7.3

9.4 Test Results

PASS.

Detailed information please see the following page.

IEEE 802.11b:

CH Low :

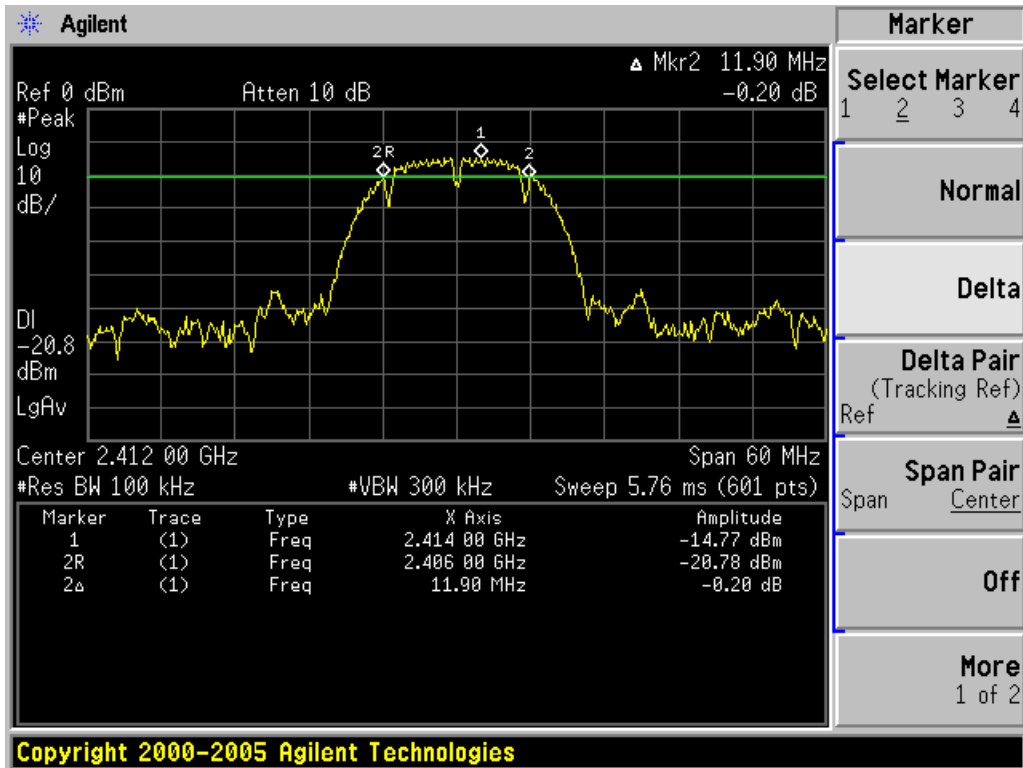

CH Mid :

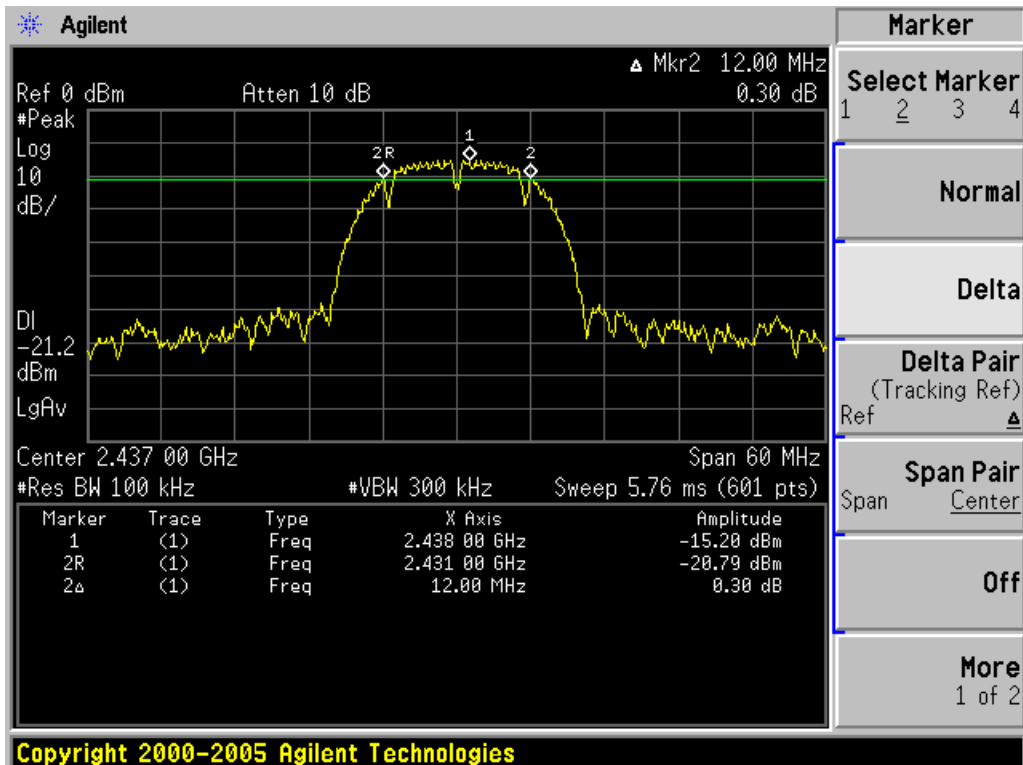

CH High :

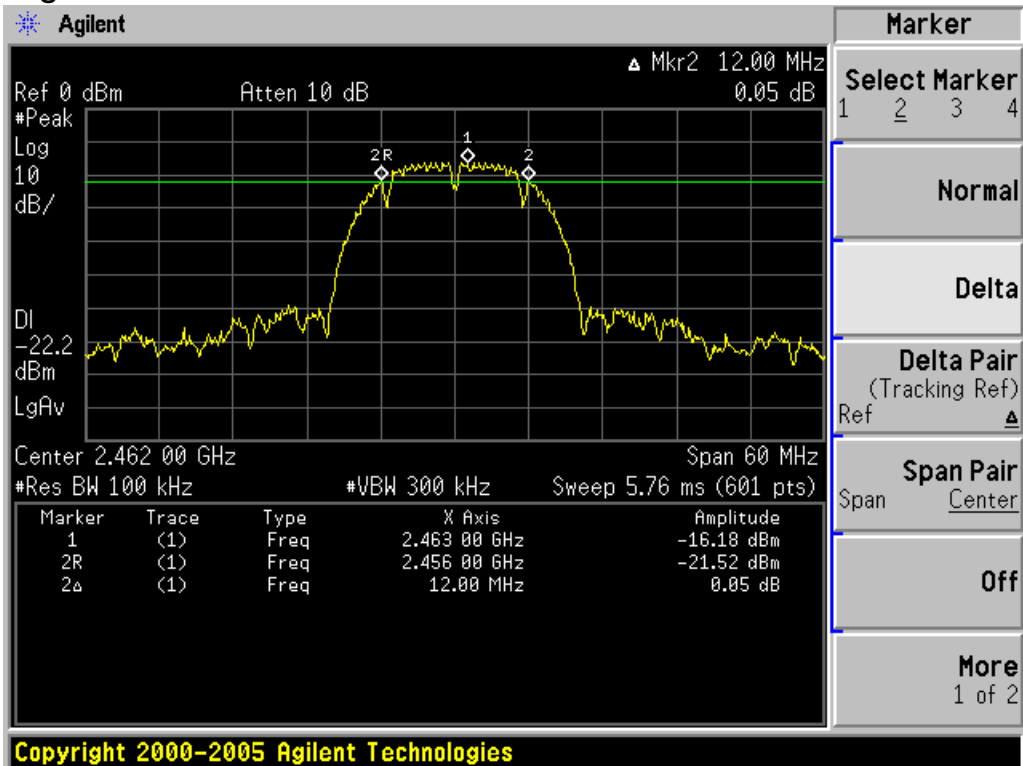

IEEE 802.11g:

CH Low :

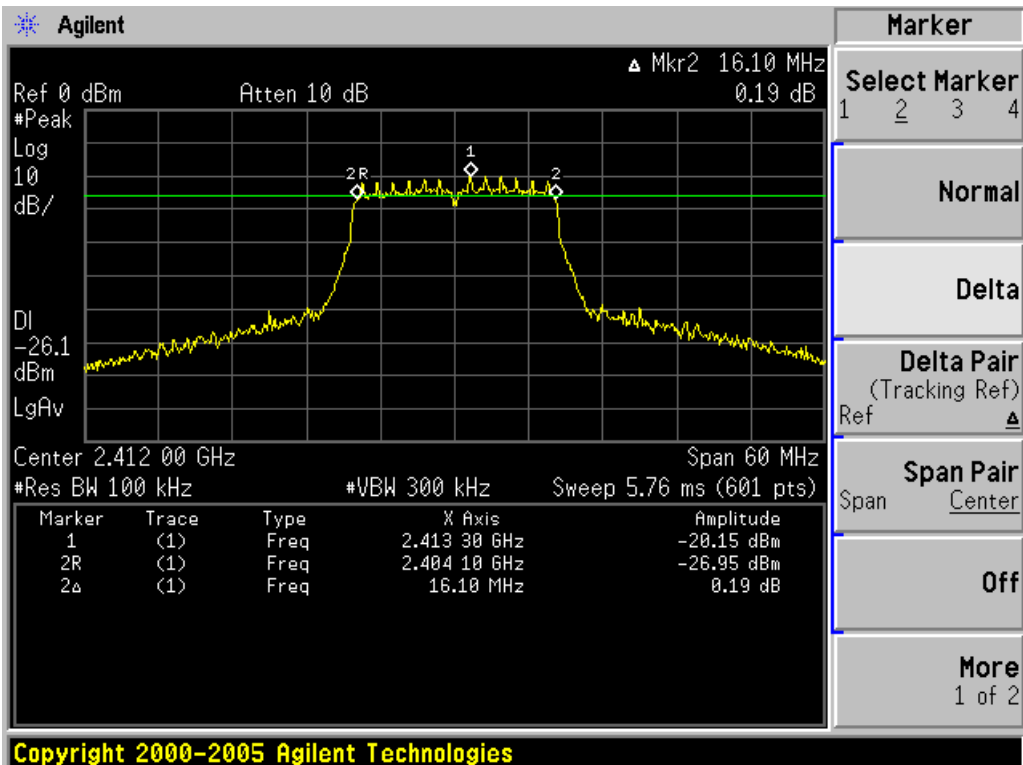

CH Mid :

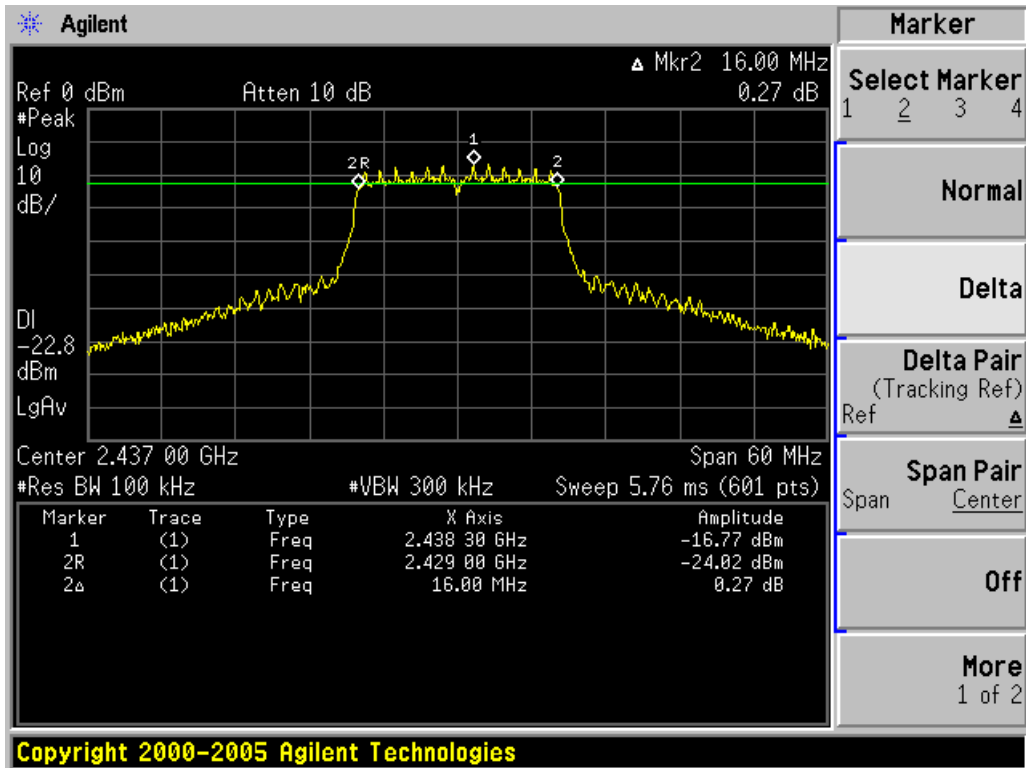

CH High :

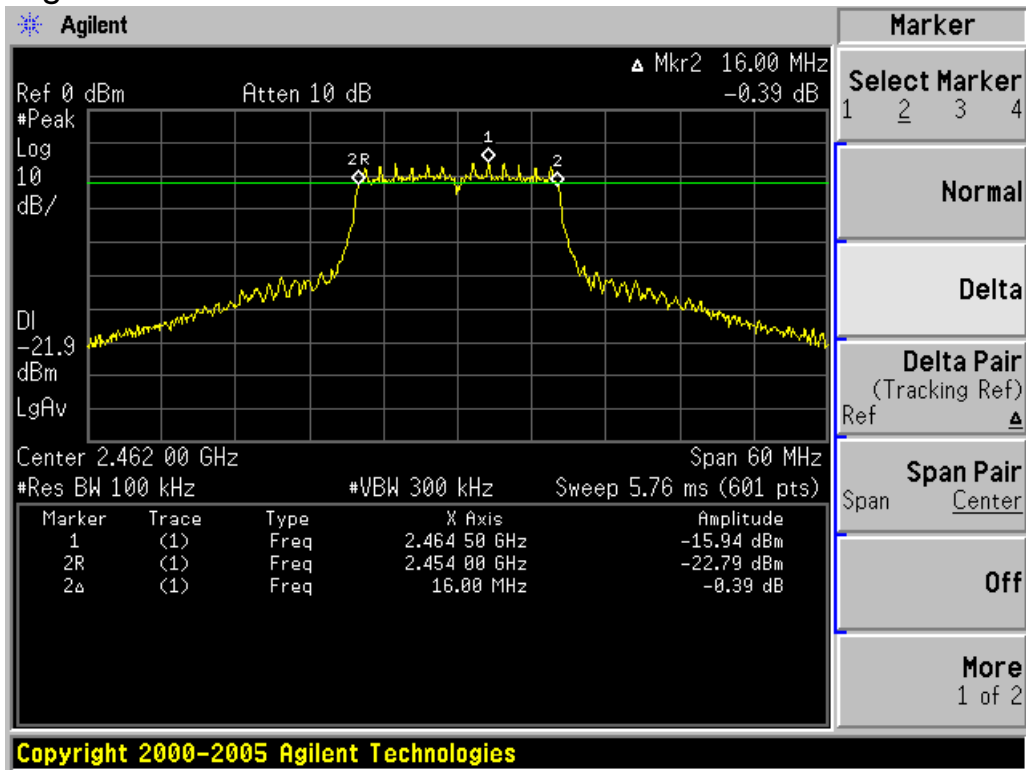

IEEE 802.11g:

CH Low :

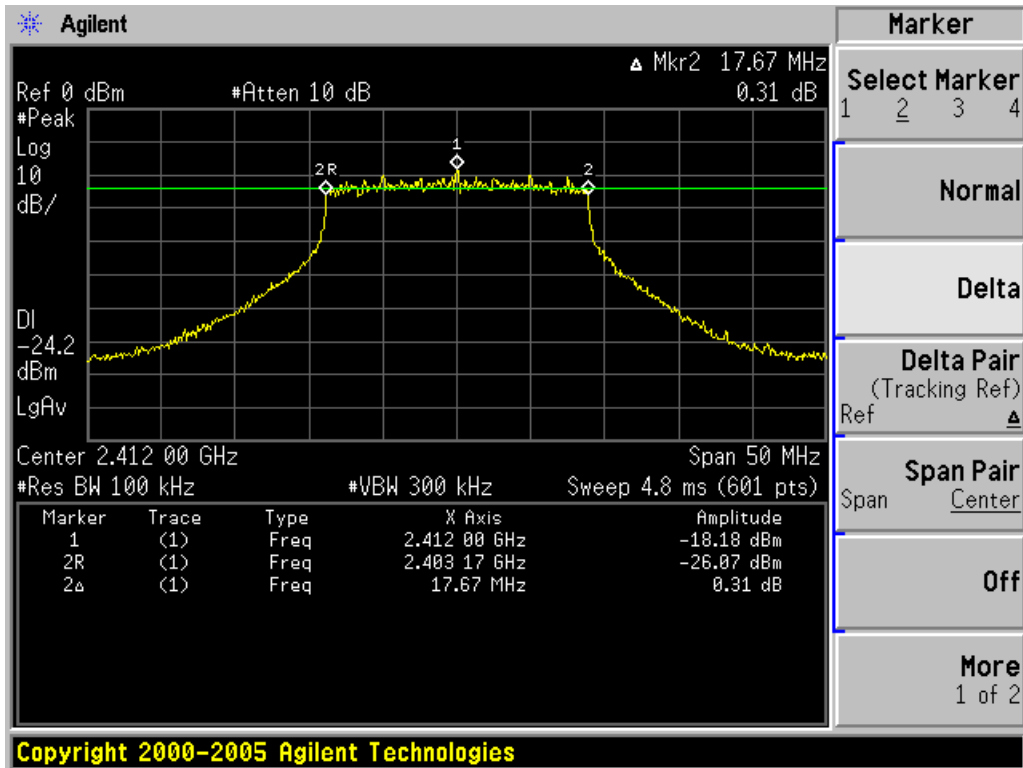

CH Mid :

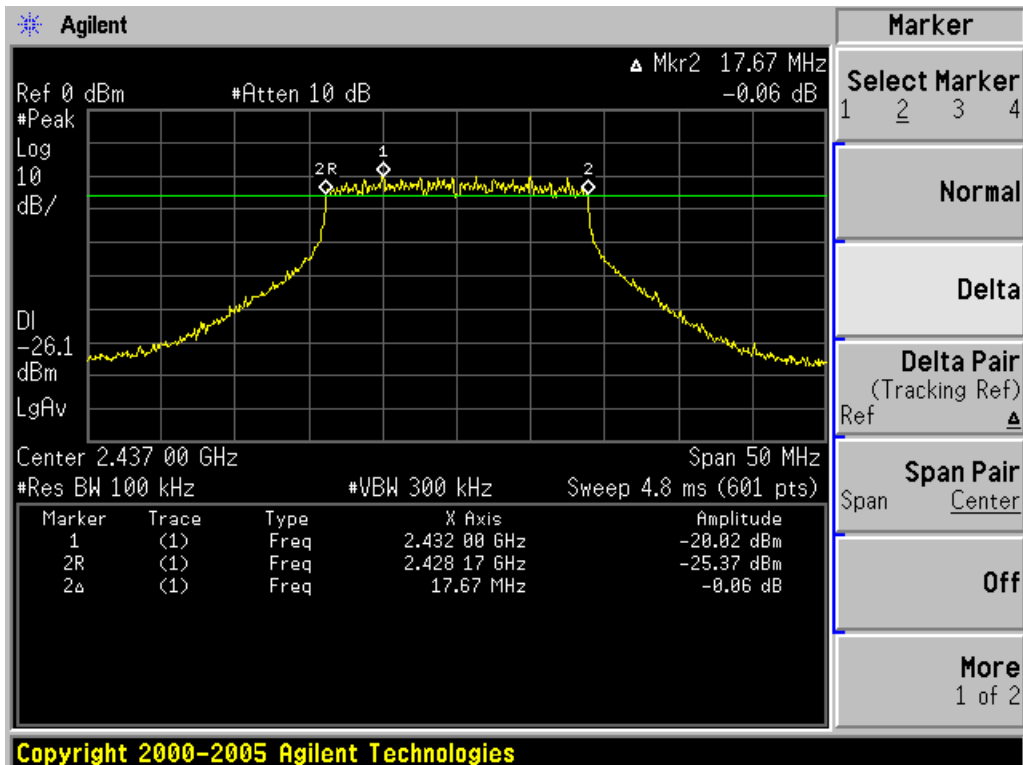

CH High :

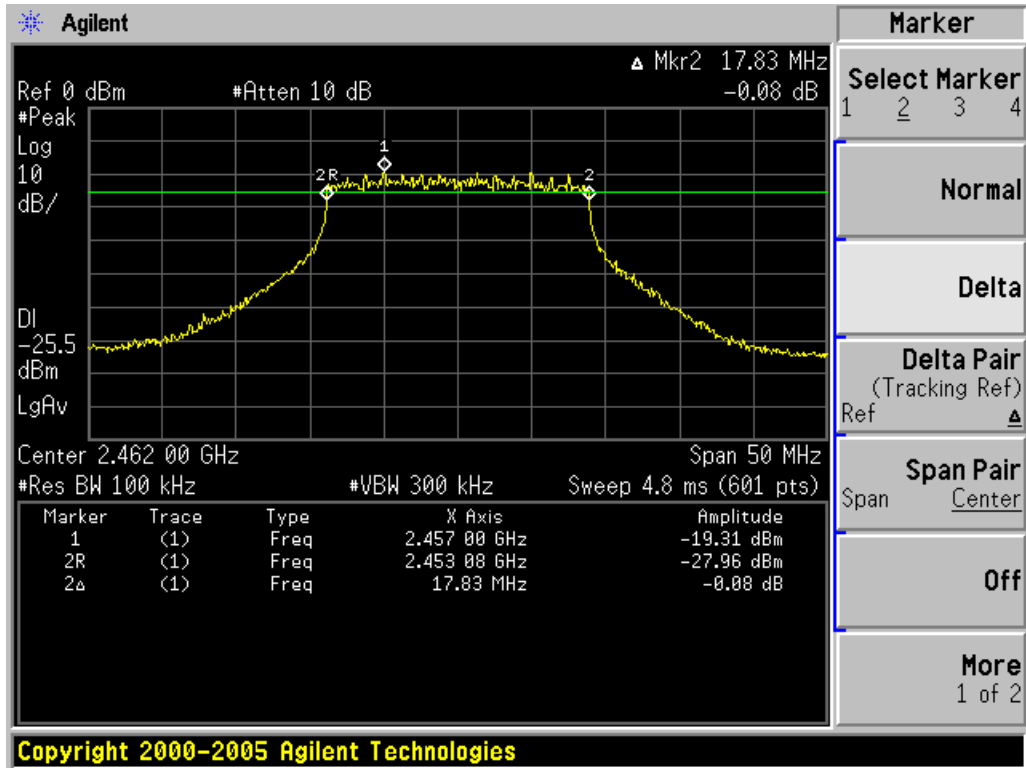

10NUMBER OF HOPPING FREQUENCY

10.1 Test limit

Please refer section15.247

According to § 15.247(a)(1)(ii), Frequency hopping systems operating in the 2400MHz-2483.5 MHz bands shall use at least 15 hopping frequencies.

10.2 Method of measurement

10.2.1. Place the EUT on the table and set it in transmitting mode.

10.2.2. Remove the antenna from the EUT and then connect a low loss RF cable from the antenna port to the spectrum analyzer.

10.2.3. Set spectrum analyzer Start=2400MHz, Stop = 2441.5MHz, Sweep = 1ms and Start=2441.5MHz, Stop = 2483.5MHz, Sweep = 1ms.

10.2.4. Set the spectrum analyzer as RBW, VBW=510kHz,

10.2.5. Max hold, view and count how many channel in the band.

10.3 Test Setup

Same as 7.3

10.4 Test Results

The test is not applicable

11 DWELL TIME

11.1 Test limit

Please refer section 15.247

According to §15.247(a)(1)(iii), Frequency hopping systems operating in the 2400MHz-2483.5 MHz. The average time of occupancy on any frequency shall not greater than 0.4 s within period of 0.4 seconds multiplied by the number of hopping channel employed.

11.2 Method of measurement

- 11.2.1. Place the EUT on the table and set it in transmitting mode.
- 11.2.2. Remove the antenna from the EUT and then connect a low loss RF cable from the antenna port to the spectrum analyzer.
- 11.2.3. Set center frequency of spectrum analyzer = operating frequency.
- 11.2.4. Set the spectrum analyzer as RBW, VBW=1MHz, Span = 0Hz, Sweep = auto.
- 11.2.5. Repeat above procedures until all frequency measured were complete.

11.3 Test Setup

Same as 7.3

11.4 Test Results

The test is not applicable

12 Band Edge Check

12.1 Test limit

Please refer section 15.247

All the lower and upper band-edges emissions appearing within 2310MHz to 2390MHz and 2483.5MHz to 2500MHz restricted frequency bands shall not exceed the limits shown in 15.209, all the other emissions outside operation frequency band 2400MHz to 2483.5MHz shall be at least 20dB below the fundamental emissions, or comply with 15.209 limits.

12.2 Test Procedure

12.2.1 Put the EUT on a 0.8m high table, power on the EUT. Emissions were scanned and measured rotating the EUT to 360 degrees, Find the maximum Emission

12.2.2 Check the spurious emissions out of band.

12.2.3 RBW, VBW Setting, please see the following test plot.

12.3 Test Setup

Same as 5.2.2.

12.4 Test Result

PASS.

Detailed information please see the following page.

IEEE 802.11b:

CH LOW :

Detector mode: Peak

Polarity: Horizontal

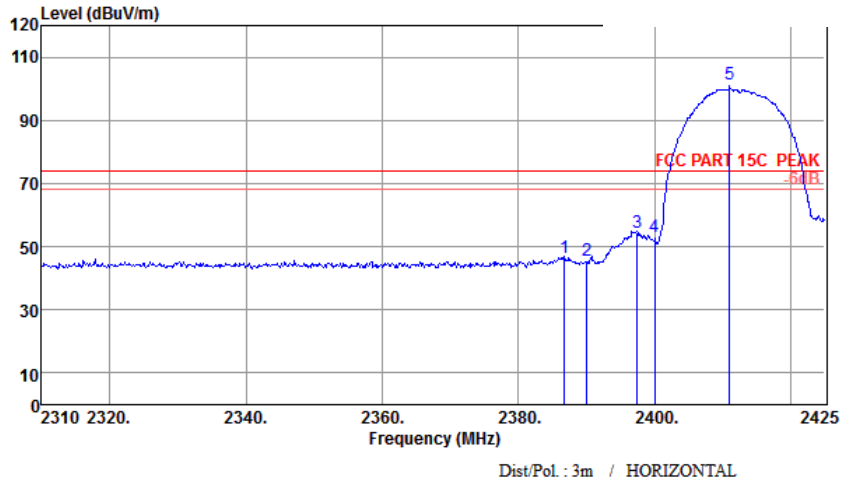

No	Freq. (MHz)	Read Level (dBuV/m)	Ant. Factor (dB)	Preamp Factor (dB)	Cable Loss (dB)	Result (dBuV/m)	Limit (dBuV/m)	Margin (dB)	Remark
1	2386.71	44.96	29.44	36.62	8.67	46.45	74.00	27.55	Peak
2	2390.00	44.25	29.44	36.62	8.67	45.74	74.00	28.26	Peak
3	2397.40	52.91	29.44	36.62	8.72	54.45	74.00	19.55	Peak
4	2400.00	51.73	29.44	36.62	8.72	53.27	74.00	20.73	Peak
5	2410.97	99.93	29.45	36.62	8.72	101.48	74.00	-27.48	Peak

Remarks: 1. Result = RD Level + Antenna Factor + Cable loss - Preamp Factor
 2. If Peak Result comply with Peak limit,AV Result is deemed to comply with AV limit

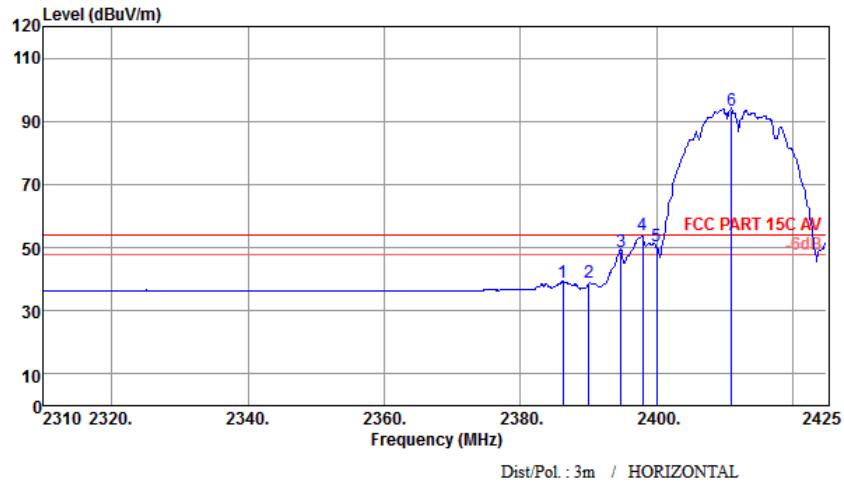

No	Freq. (MHz)	Read Level (dBuV/m)	Ant. Factor (dB)	Preamp Factor (dB)	Cable Loss (dB)	Result (dBuV/m)	Limit (dBuV/m)	Margin (dB)	Remark
1	2386.25	37.27	29.44	36.62	8.67	38.76	54.00	15.24	Average
2	2390.00	37.52	29.44	36.62	8.67	39.01	54.00	14.99	Average
3	2394.76	47.31	29.44	36.62	8.67	48.80	54.00	5.20	Average
4	2397.98	52.45	29.44	36.62	8.72	53.99	54.00	0.01	Average
5	2400.00	48.90	29.44	36.62	8.72	50.44	54.00	3.56	Average
6	2410.97	92.01	29.45	36.62	8.72	93.56	54.00	-39.56	Average

Remarks: 1. Result = RD Level + Antenna Factor + Cable loss - Preamp Factor
 2. If Peak Result comply with Peak limit,AV Result is deemed to comply with AV limit

CH High :

Detector mode: Peak

Polarity: Horizontal

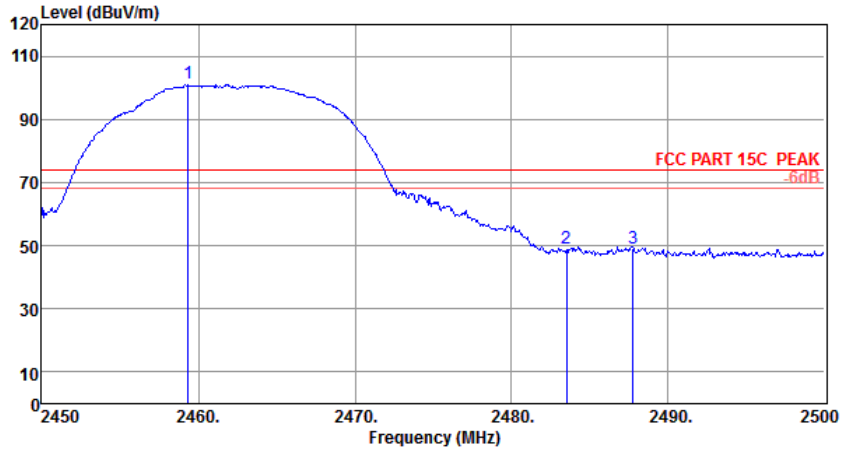

Dist/Pol : 3m / HORIZONTAL

No	Freq. (MHz)	Read Level (dBuV/m)	Ant. Factor (dB)	Preamp Factor (dB)	Cable Loss (dB)	Result (dBuV/m)	Limit (dBuV/m)	Margin (dB)	Remark
1	2459.35	99.59	29.48	36.61	8.82	101.28	74.00	-27.28	Peak
2	2483.50	47.30	29.49	36.60	8.87	49.06	74.00	24.94	Peak
3	2487.75	47.23	29.50	36.60	8.87	49.00	74.00	25.00	Peak

Remarks: 1. Result = RD Level + Antenna Factor + Cable loss - Preamp Factor
 2. If Peak Result comply with Peak limit,AV Result is deemed to comply with AV limit

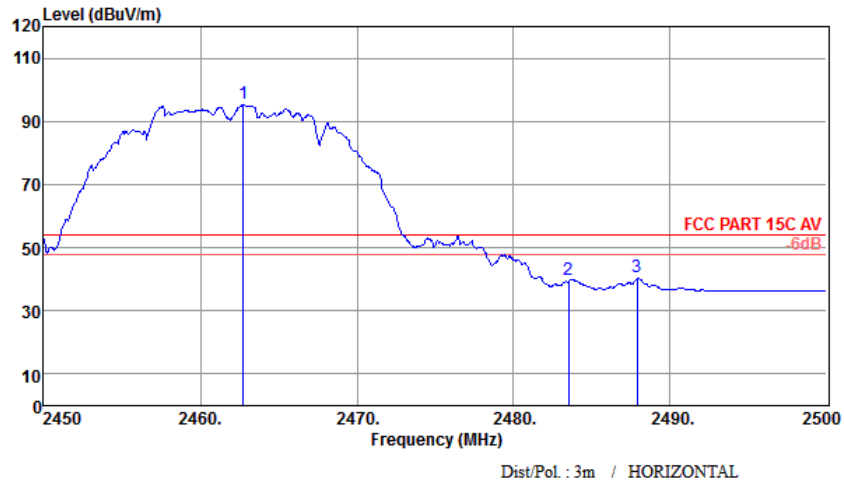

No	Freq. (MHz)	Read Level (dBuV/m)	Ant. Factor (dB)	Preamp Factor (dB)	Cable Loss (dB)	Result (dBuV/m)	Limit (dBuV/m)	Margin (dB)	Remark
1	2462.75	93.78	29.48	36.61	8.82	95.47	54.00	-41.47	Average
2	2483.50	38.00	29.49	36.60	8.87	39.76	54.00	14.24	Average
3	2487.90	38.77	29.50	36.60	8.87	40.54	54.00	13.46	Average

Remarks: 1. Result = RD Level + Antenna Factor + Cable loss - Preamp Factor
 2. If Peak Result comply with Peak limit,AV Result is deemed to comply with AV limit

CH LOW :

Detector mode: Peak

Polarity: Vertical

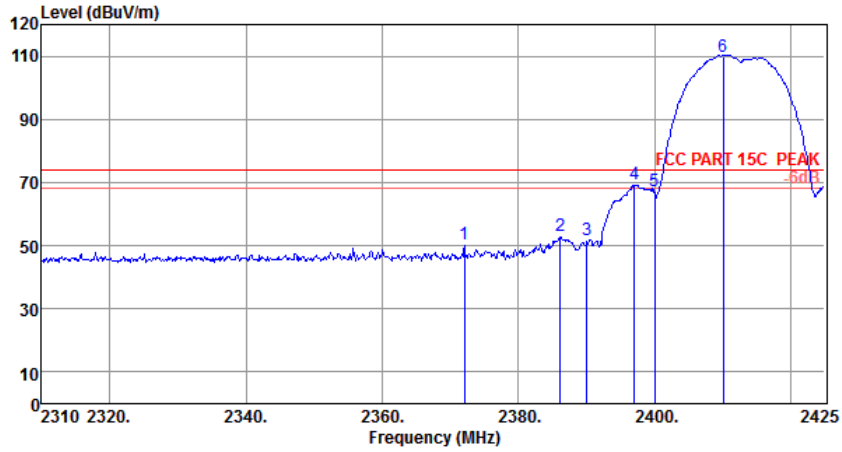

No	Freq. (MHz)	Read Level (dBuV/m)	Ant. Factor (dB)	Preamp Factor (dB)	Cable Loss (dB)	Result (dBuV/m)	Limit (dBuV/m)	Margin (dB)	Remark
1	2372.10	49.16	29.43	36.62	8.67	50.64	74.00	23.36	Peak
2	2386.13	51.64	29.44	36.62	8.67	53.13	74.00	20.87	Peak
3	2390.00	50.44	29.44	36.62	8.67	51.93	74.00	22.07	Peak
4	2397.06	68.19	29.44	36.62	8.72	69.73	74.00	4.27	Peak
5	2400.00	65.72	29.44	36.62	8.72	67.26	74.00	6.74	Peak
6	2410.05	108.20	29.45	36.62	8.72	109.75	74.00	-35.75	Peak

Remarks: 1. Result = RD Level + Antenna Factor + Cable loss - Preamp Factor
 2. If Peak Result comply with Peak limit,AV Result is deemed to comply with AV limit

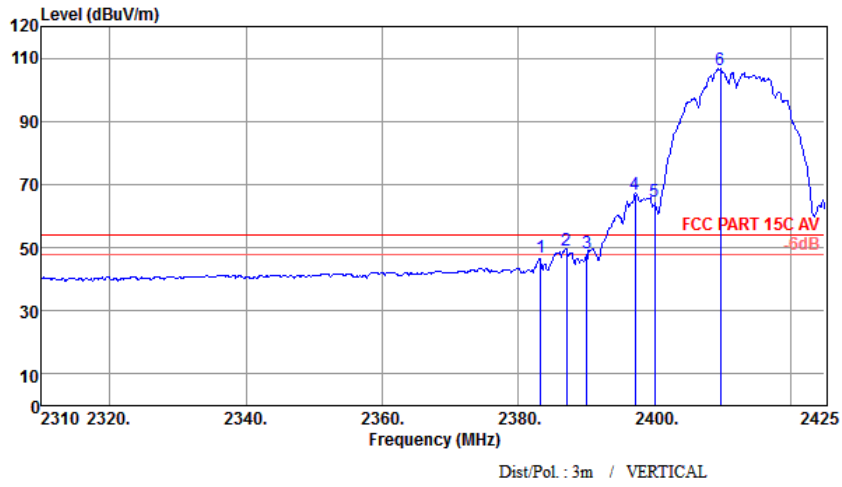

No	Freq. (MHz)	Read Level (dBuV/m)	Ant. Factor (dB)	Preamp Factor (dB)	Cable Loss (dB)	Result (dBuV/m)	Limit (dBuV/m)	Margin (dB)	Remark
1	2383.26	45.42	29.43	36.62	8.67	46.90	54.00	7.10	Average
2	2387.05	47.64	29.44	36.62	8.67	49.13	54.00	4.87	Average
3	2390.00	46.83	29.44	36.62	8.67	48.32	54.00	5.68	Average
4	2397.17	65.20	29.44	36.62	8.72	66.74	54.00	-12.74	Average
5	2400.00	63.11	29.44	36.62	8.72	64.65	54.00	-10.65	Average
6	2409.71	104.56	29.45	36.62	8.72	106.11	54.00	-52.11	Average

Remarks: 1. Result = RD Level + Antenna Factor + Cable loss - Preamp Factor
 2. If Peak Result comply with Peak limit,AV Result is deemed to comply with AV limit

CH High :

Detector mode: Peak

Polarity: Vertical

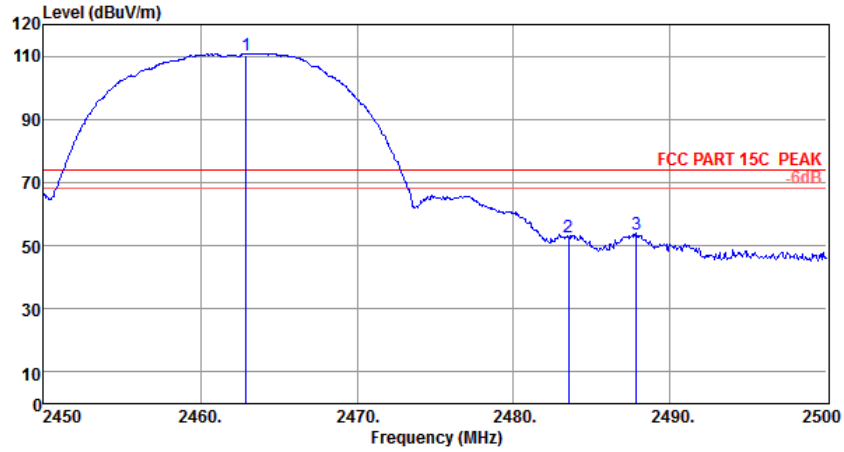

Dist/Pol : 3m / VERTICAL

No	Freq. (MHz)	Read Level (dBuV/m)	Ant. Factor (dB)	Preamp Factor (dB)	Cable Loss (dB)	Result (dBuV/m)	Limit (dBuV/m)	Margin (dB)	Remark
1	2462.90	108.63	29.48	36.61	8.82	110.32	74.00	-36.32	Peak
2	2483.50	51.13	29.49	36.60	8.87	52.89	74.00	21.11	Peak
3	2487.85	51.69	29.50	36.60	8.87	53.46	74.00	20.54	Peak

Remarks: 1. Result = RD Level + Antenna Factor + Cable loss - Preamp Factor
 2. If Peak Result comply with Peak limit,AV Result is deemed to comply with AV limit

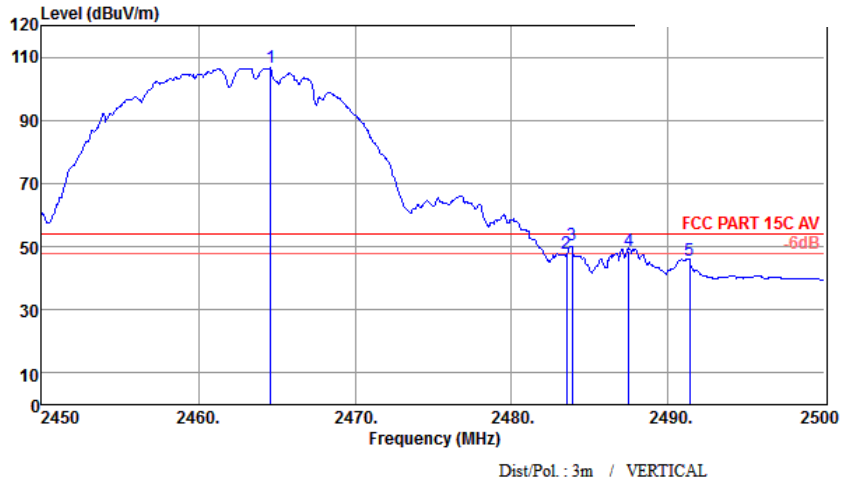

No	Freq. (MHz)	Read Level (dBuV/m)	Ant. Factor (dB)	Preamp Factor (dB)	Cable Loss (dB)	Result (dBuV/m)	Limit (dBuV/m)	Margin (dB)	Remark
1	2464.60	105.24	29.48	36.61	8.82	106.93	54.00	-52.93	Average
2	2483.50	46.11	29.49	36.60	8.87	47.87	54.00	6.13	Average
3	2483.85	48.80	29.49	36.60	8.87	50.56	54.00	3.44	Average
4	2487.50	47.15	29.50	36.60	8.87	48.92	54.00	5.08	Average
5	2491.35	43.83	29.50	36.60	8.87	45.60	54.00	8.40	Average

Remarks: 1. Result = RD Level + Antenna Factor + Cable loss - Preamp Factor
 2. If Peak Result comply with Peak limit,AV Result is deemed to comply with AV limit

IEEE 802.11g:

CH LOW :

Detector mode: Peak

Polarity: Horizontal

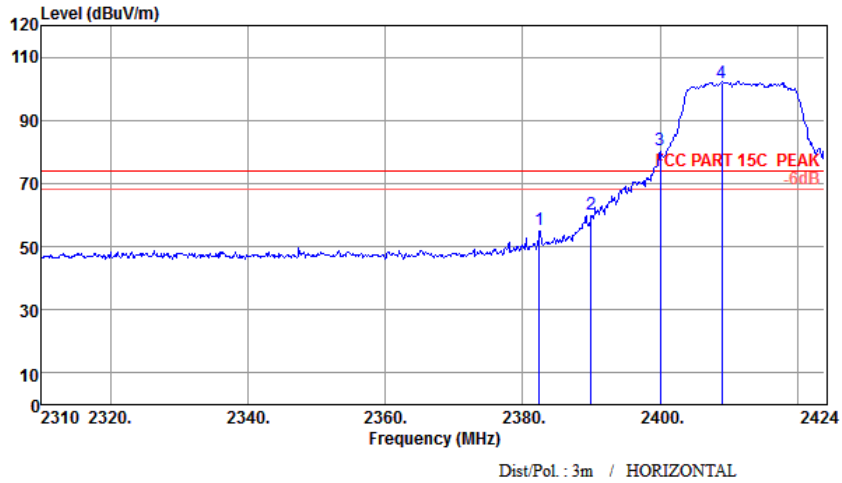

No	Freq. (MHz)	Read Level (dBuV/m)	Ant. Factor (dB)	Preamp Factor (dB)	Cable Loss (dB)	Result (dBuV/m)	Limit (dBuV/m)	Margin (dB)	Remark
1	2382.39	53.76	29.43	36.62	8.67	55.24	74.00	18.76	Peak
2	2390.00	58.68	29.44	36.62	8.67	60.17	74.00	13.83	Peak
3	2400.00	79.15	29.44	36.62	8.72	80.69	74.00	-6.69	Peak
4	2408.95	100.36	29.45	36.62	8.72	101.91	74.00	-27.91	Peak

Remarks: 1. Result = RD Level + Antenna Factor + Cable loss - Preamp Factor
 2. If Peak Result comply with Peak limit,AV Result is deemed to comply with AV limit

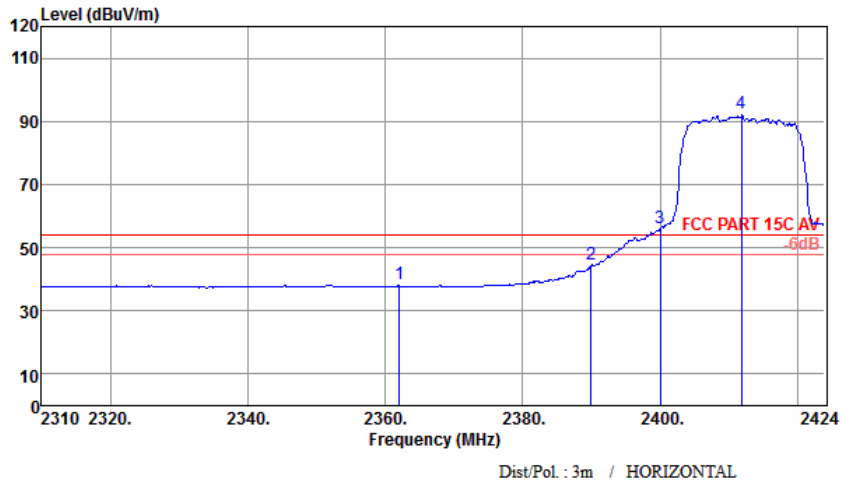

No	Freq. (MHz)	Read Level (dBuV/m)	Ant. Factor (dB)	Preamp Factor (dB)	Cable Loss (dB)	Result (dBuV/m)	Limit (dBuV/m)	Margin (dB)	Remark
1	2362.10	37.08	29.42	36.63	8.62	38.49	54.00	15.51	Average
2	2390.00	43.06	29.44	36.62	8.67	44.55	54.00	9.45	Average
3	2400.00	54.65	29.44	36.62	8.72	56.19	54.00	-2.19	Average
4	2411.80	90.78	29.45	36.62	8.72	92.33	54.00	-38.33	Average

Remarks: 1. Result = RD Level + Antenna Factor + Cable loss - Preamp Factor
 2. If Peak Result comply with Peak limit,AV Result is deemed to comply with AV limit

CH High :

Detector mode: Peak

Polarity: Horizontal

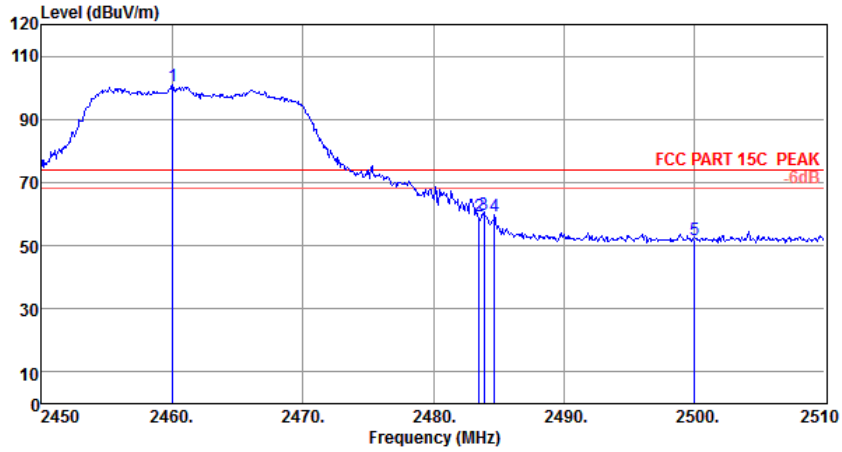

Dist/Pol : 3m / HORIZONTAL

No	Freq. (MHz)	Read Level (dBuV/m)	Ant. Factor (dB)	Preamp Factor (dB)	Cable Loss (dB)	Result (dBuV/m)	Limit (dBuV/m)	Margin (dB)	Remark
1	2460.02	98.73	29.48	36.61	8.82	100.42	74.00	-26.42	Peak
2	2483.50	57.64	29.49	36.60	8.87	59.40	74.00	14.60	Peak
3	2483.90	58.22	29.49	36.60	8.87	59.98	74.00	14.02	Peak
4	2484.68	57.51	29.49	36.60	8.87	59.27	74.00	14.73	Peak
5	2500.00	50.11	29.50	36.60	8.92	51.93	74.00	22.07	Peak

Remarks: 1. Result = RD Level + Antenna Factor + Cable loss - Preamp Factor
 2. If Peak Result comply with Peak limit,AV Result is deemed to comply with AV limit

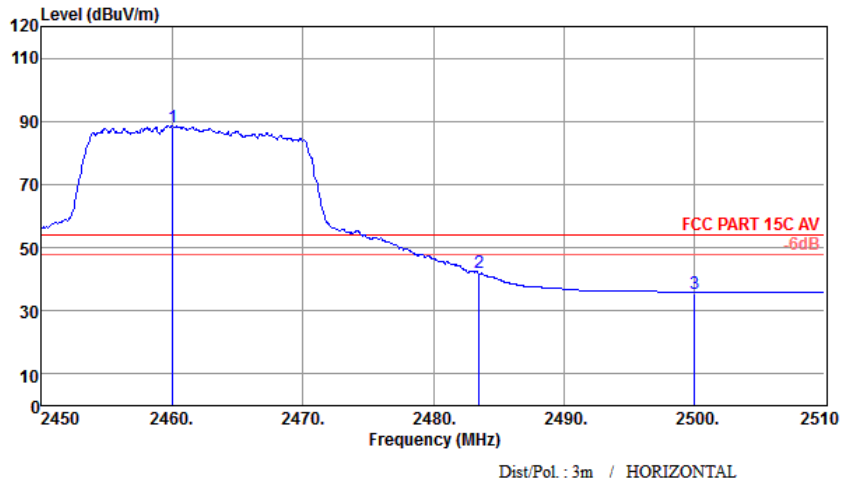

No	Freq. (MHz)	Read Level (dBuV/m)	Ant. Factor (dB)	Preamp Factor (dB)	Cable Loss (dB)	Result (dBuV/m)	Limit (dBuV/m)	Margin (dB)	Remark
1	2460.02	86.42	29.48	36.61	8.82	88.11	54.00	-34.11	Average
2	2483.50	40.43	29.49	36.60	8.87	42.19	54.00	11.81	Average
3	2500.00	33.48	29.50	36.60	8.92	35.30	54.00	18.70	Average

Remarks: 1. Result = RD Level + Antenna Factor + Cable loss - Preamp Factor
 2. If Peak Result comply with Peak limit,AV Result is deemed to comply with AV limit

CH LOW :

Detector mode: Peak

Polarity: Vertical

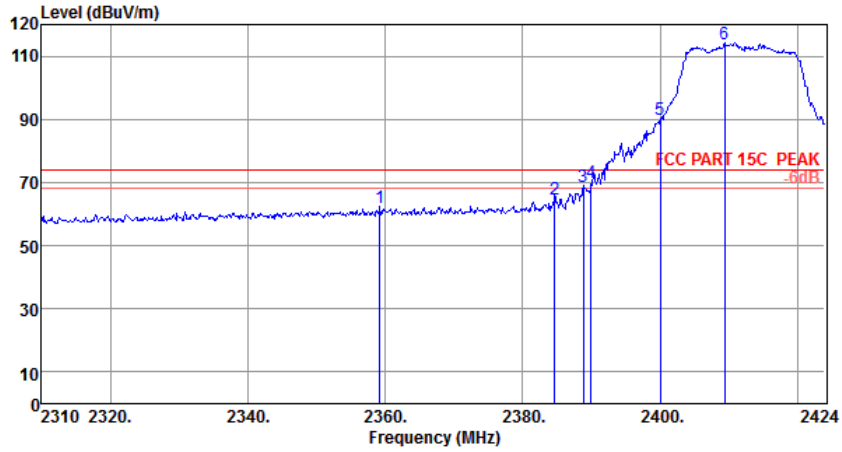

Dist/Pol : 3m / VERTICAL

No	Freq. (MHz)	Read Level (dBuV/m)	Ant. Factor (dB)	Preamp Factor (dB)	Cable Loss (dB)	Result (dBuV/m)	Limit (dBuV/m)	Margin (dB)	Remark
1	2359.25	60.52	29.42	36.63	8.62	61.93	74.00	12.07	Peak
2	2384.67	63.18	29.43	36.62	8.67	64.66	74.00	9.34	Peak
3	2388.89	67.15	29.44	36.62	8.67	68.64	74.00	5.36	Peak
4	2390.00	68.35	29.44	36.62	8.67	69.84	74.00	4.16	Peak
5	2400.00	88.24	29.44	36.62	8.72	89.78	74.00	-15.78	Peak
6	2409.41	112.09	29.45	36.62	8.72	113.64	74.00	-39.64	Peak

Remarks: 1. Result = RD Level + Antenna Factor + Cable loss - Preamp Factor
 2. If Peak Result comply with Peak limit,AV Result is deemed to comply with AV limit

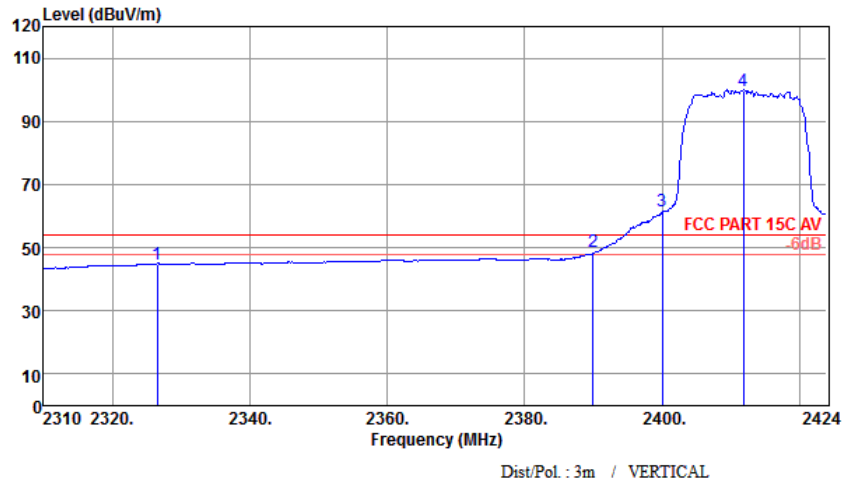

No	Freq. (MHz)	Read Level (dBuV/m)	Ant. Factor (dB)	Preamp Factor (dB)	Cable Loss (dB)	Result (dBuV/m)	Limit (dBuV/m)	Margin (dB)	Remark
1	2326.53	43.19	29.40	36.63	8.57	44.53	54.00	9.47	Average
2	2390.00	47.24	29.44	36.62	8.67	48.73	54.00	5.27	Average
3	2400.00	59.94	29.44	36.62	8.72	61.48	54.00	-7.48	Average
4	2411.80	98.09	29.45	36.62	8.72	99.64	54.00	-45.64	Average

Remarks: 1. Result = RD Level + Antenna Factor + Cable loss - Preamp Factor
 2. If Peak Result comply with Peak limit,AV Result is deemed to comply with AV limit

CH High :

Detector mode: Peak

Polarity: Vertical

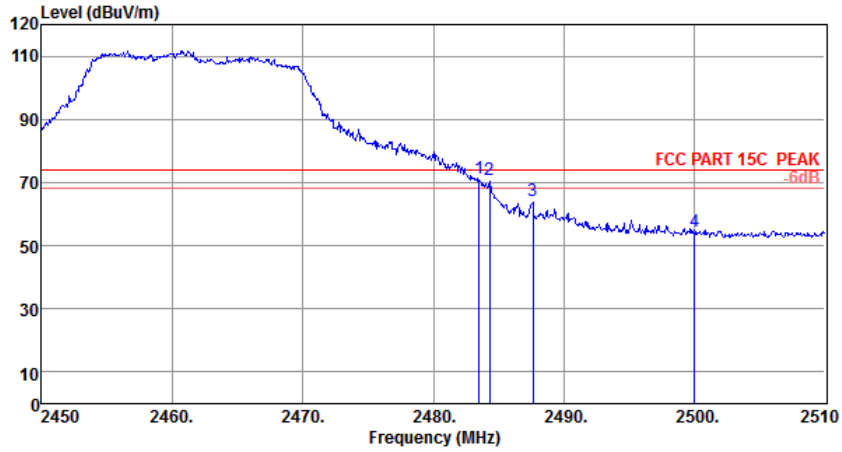

Dist/Pol: 3m / VERTICAL

No	Freq. (MHz)	Read Level (dBuV/m)	Ant. Factor (dB)	Preamp Factor (dB)	Cable Loss (dB)	Result (dBuV/m)	Limit (dBuV/m)	Margin (dB)	Remark
1	2483.50	69.34	29.49	36.60	8.87	71.10	74.00	2.90	Peak
2	2484.32	69.07	29.49	36.60	8.87	70.83	74.00	3.17	Peak
3	2487.62	62.22	29.50	36.60	8.87	63.99	74.00	10.01	Peak
4	2500.00	52.67	29.50	36.60	8.92	54.49	74.00	19.51	Peak

Remarks: 1. Result = RD Level + Antenna Factor + Cable loss - Preamp Factor
 2. If Peak Result comply with Peak limit, AV Result is deemed to comply with AV limit

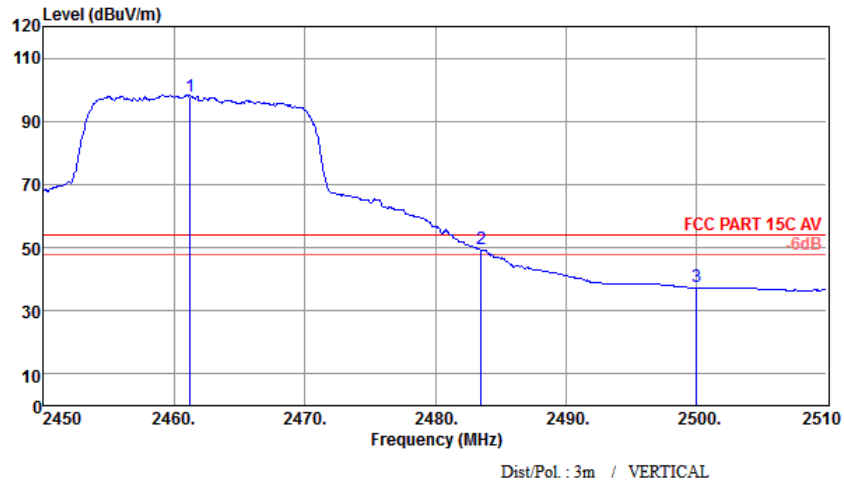

No	Freq. (MHz)	Read Level (dBuV/m)	Ant. Factor (dB)	Preamp Factor (dB)	Cable Loss (dB)	Result (dBuV/m)	Limit (dBuV/m)	Margin (dB)	Remark
1	2461.22	96.14	29.48	36.61	8.82	97.83	54.00	-43.83	Average
2	2483.50	47.94	29.49	36.60	8.87	49.70	54.00	4.30	Average
3	2500.00	35.88	29.50	36.60	8.92	37.70	54.00	16.30	Average

Remarks: 1. Result = RD Level + Antenna Factor + Cable loss - Preamp Factor
 2. If Peak Result comply with Peak limit,AV Result is deemed to comply with AV limit

IEEE 802.11n:

CH LOW :

Detector mode: Peak

Polarity: Horizontal

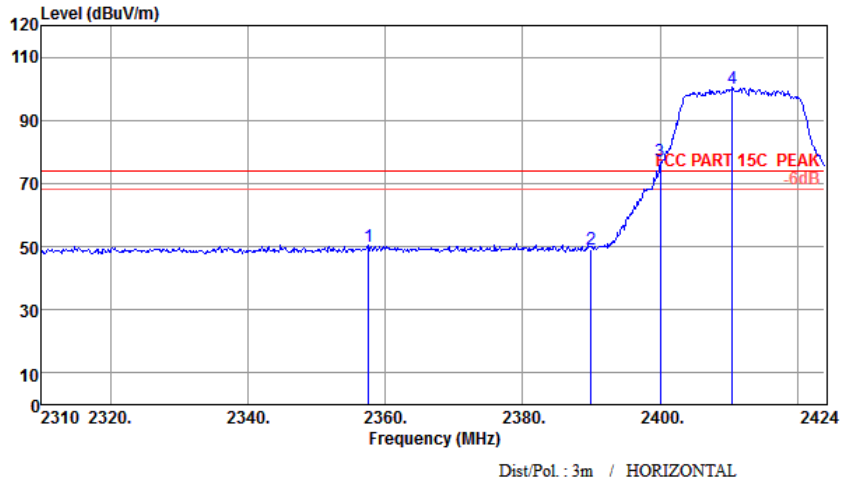

No	Freq. (MHz)	Read Level (dBuV/m)	Ant. Factor (dB)	Preamp Factor (dB)	Cable Loss (dB)	Result (dBuV/m)	Limit (dBuV/m)	Margin (dB)	Remark
1	2357.54	48.62	29.42	36.63	8.62	50.03	74.00	23.97	Peak
2	2390.00	47.78	29.44	36.62	8.67	49.27	74.00	24.73	Peak
3	2400.00	75.35	29.44	36.62	8.72	76.89	74.00	-2.89	Peak
4	2410.55	98.33	29.45	36.62	8.72	99.88	74.00	-25.88	Peak

Remarks: 1. Result = RD Level + Antenna Factor + Cable loss - Preamp Factor
 2. If Peak Result comply with Peak limit,AV Result is deemed to comply with AV limit

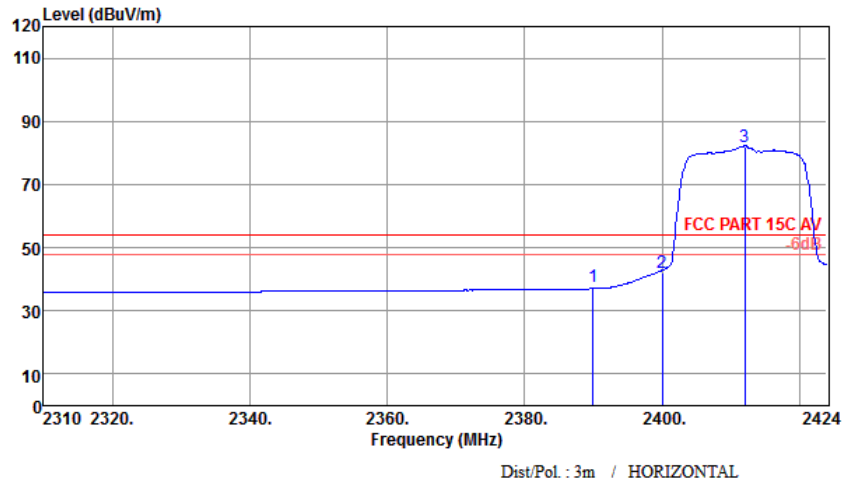

No	Freq. (MHz)	Read Level (dBuV/m)	Ant. Factor (dB)	Preamp Factor (dB)	Cable Loss (dB)	Result (dBuV/m)	Limit (dBuV/m)	Margin (dB)	Remark
1	2390.00	35.95	29.44	36.62	8.67	37.44	54.00	16.56	Average
2	2400.00	40.72	29.44	36.62	8.72	42.26	54.00	11.74	Average
3	2412.03	80.22	29.45	36.62	8.72	81.77	54.00	-27.77	Average

Remarks: 1. Result = RD Level + Antenna Factor + Cable loss - Preamp Factor
 2. If Peak Result comply with Peak limit,AV Result is deemed to comply with AV limit

CH High :

Detector mode: Peak

Polarity: Horizontal

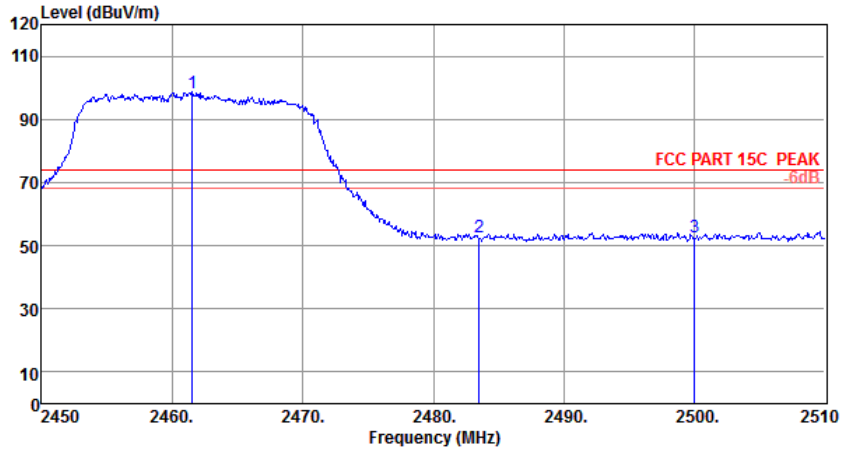

Dist/Pol : 3m / HORIZONTAL

No	Freq. (MHz)	Read Level (dBuV/m)	Ant. Factor (dB)	Preamp Factor (dB)	Cable Loss (dB)	Result (dBuV/m)	Limit (dBuV/m)	Margin (dB)	Remark
1	2461.52	96.60	29.48	36.61	8.82	98.29	74.00	-24.29	Peak
2	2483.50	50.96	29.49	36.60	8.87	52.72	74.00	21.28	Peak
3	2500.00	51.03	29.50	36.60	8.92	52.85	74.00	21.15	Peak

Remarks: 1. Result = RD Level + Antenna Factor + Cable loss - Preamp Factor
 2. If Peak Result comply with Peak limit,AV Result is deemed to comply with AV limit

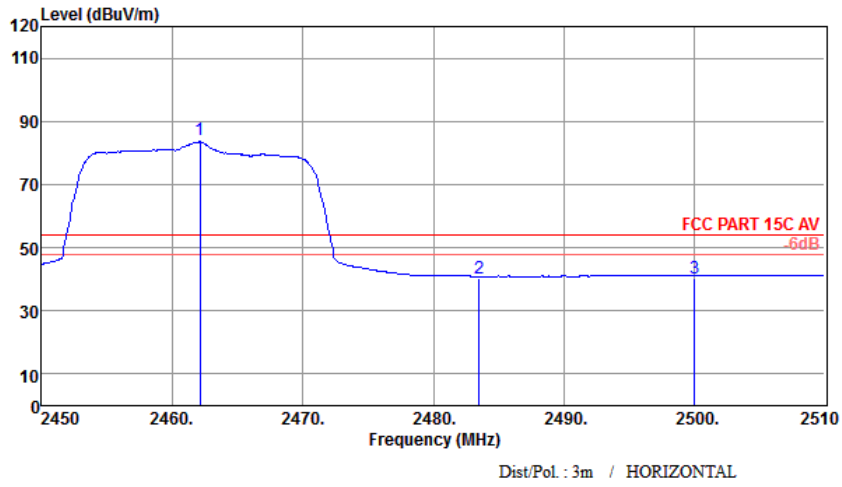

No	Freq. (MHz)	Read Level (dBuV/m)	Ant. Factor (dB)	Preamp Factor (dB)	Cable Loss (dB)	Result (dBuV/m)	Limit (dBuV/m)	Margin (dB)	Remark
1	2462.12	82.33	29.48	36.61	8.82	84.02	54.00	-30.02	Average
2	2483.50	38.58	29.49	36.60	8.87	40.34	54.00	13.66	Average
3	2500.00	38.61	29.50	36.60	8.92	40.43	54.00	13.57	Average

Remarks: 1. Result = RD Level + Antenna Factor + Cable loss - Preamp Factor
 2. If Peak Result comply with Peak limit,AV Result is deemed to comply with AV limit

CH LOW :

Detector mode: Peak

Polarity: Vertical

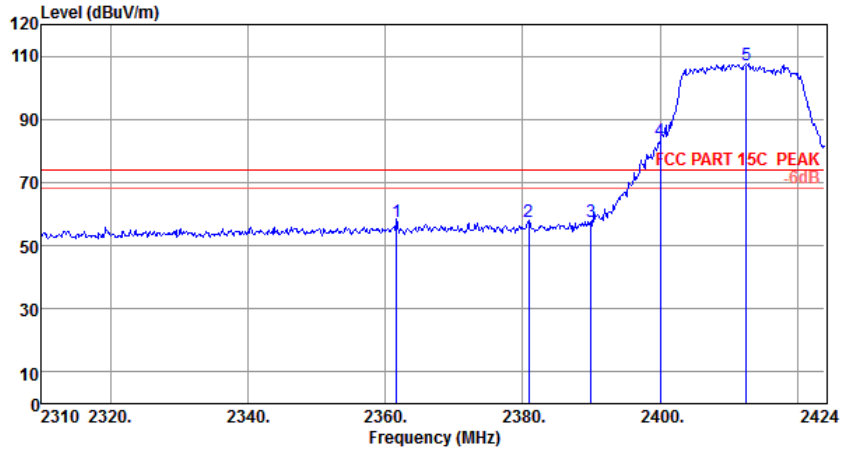

Dist/Pol : 3m / VERTICAL

No	Freq. (MHz)	Read Level (dBuV/m)	Ant. Factor (dB)	Preamp Factor (dB)	Cable Loss (dB)	Result (dBuV/m)	Limit (dBuV/m)	Margin (dB)	Remark
1	2361.64	56.34	29.42	36.63	8.62	57.75	74.00	16.25	Peak
2	2380.91	56.08	29.43	36.62	8.67	57.56	74.00	16.44	Peak
3	2390.00	56.18	29.44	36.62	8.67	57.67	74.00	16.33	Peak
4	2400.00	81.66	29.44	36.62	8.72	83.20	74.00	-9.20	Peak
5	2412.60	105.69	29.45	36.62	8.72	107.24	74.00	-33.24	Peak

Remarks: 1. Result = RD Level + Antenna Factor + Cable loss - Preamp Factor
 2. If Peak Result comply with Peak limit,AV Result is deemed to comply with AV limit

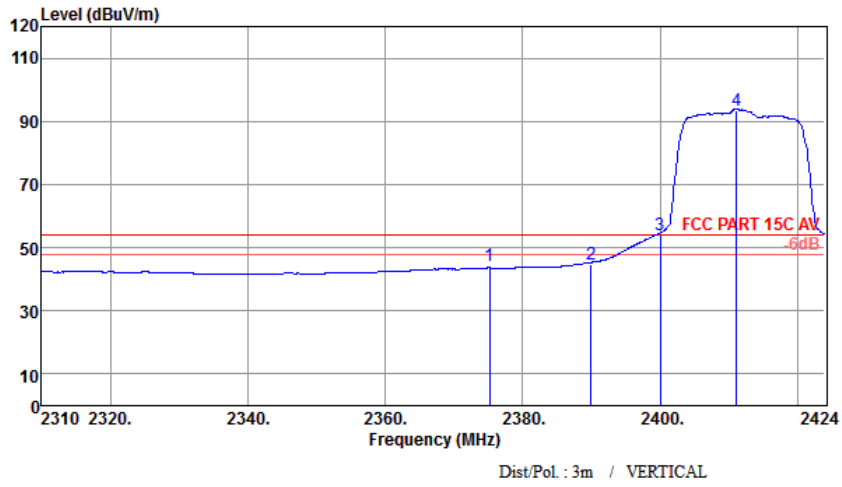

No	Freq. (MHz)	Read Level (dBuV/m)	Ant. Factor (dB)	Preamp Factor (dB)	Cable Loss (dB)	Result (dBuV/m)	Limit (dBuV/m)	Margin (dB)	Remark
1	2375.21	42.62	29.43	36.62	8.67	44.10	54.00	9.90	Average
2	2390.00	43.32	29.44	36.62	8.67	44.81	54.00	9.19	Average
3	2400.00	52.58	29.44	36.62	8.72	54.12	54.00	-0.12	Average
4	2411.12	91.87	29.45	36.62	8.72	93.42	54.00	-39.42	Average

Remarks: 1. Result = RD Level + Antenna Factor + Cable loss - Preamp Factor
 2. If Peak Result comply with Peak limit,AV Result is deemed to comply with AV limit

CH High :

Detector mode: Peak

Polarity: Vertical

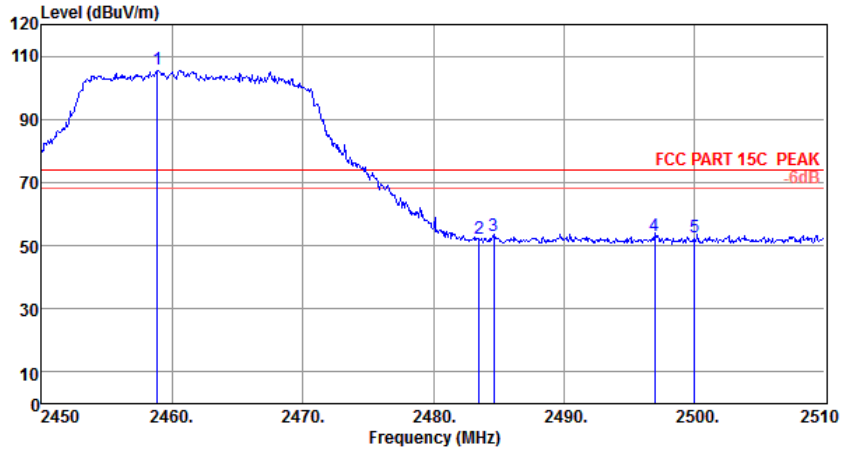

Dist/Pol: 3m / VERTICAL

No	Freq. (MHz)	Read Level (dBuV/m)	Ant. Factor (dB)	Preamp Factor (dB)	Cable Loss (dB)	Result (dBuV/m)	Limit (dBuV/m)	Margin (dB)	Remark
1	2458.88	103.99	29.48	36.61	8.82	105.68	74.00	-31.68	Peak
2	2483.50	50.70	29.49	36.60	8.87	52.46	74.00	21.54	Peak
3	2484.62	51.39	29.49	36.60	8.87	53.15	74.00	20.85	Peak
4	2496.98	51.40	29.50	36.60	8.92	53.22	74.00	20.78	Peak
5	2500.00	50.66	29.50	36.60	8.92	52.48	74.00	21.52	Peak

Remarks: 1. Result = RD Level + Antenna Factor + Cable loss - Preamp Factor
 2. If Peak Result comply with Peak limit,AV Result is deemed to comply with AV limit

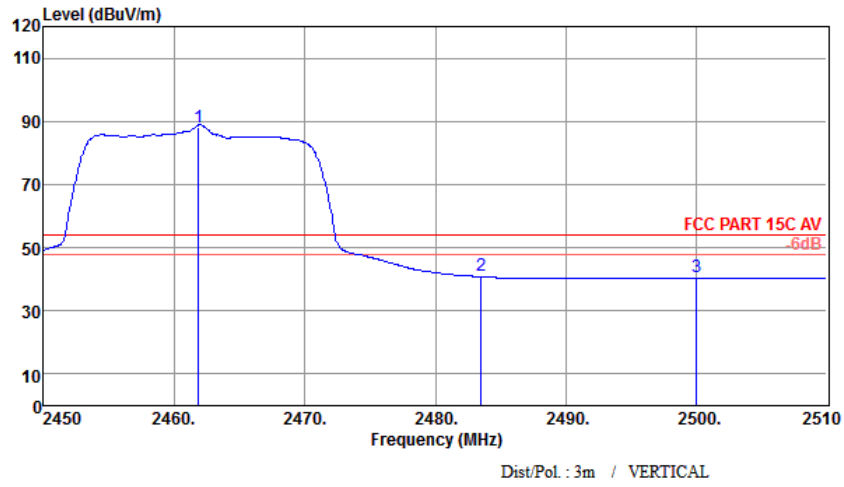

No	Freq. (MHz)	Read Level (dBuV/m)	Ant. Factor (dB)	Preamp Factor (dB)	Cable Loss (dB)	Result (dBuV/m)	Limit (dBuV/m)	Margin (dB)	Remark
1	2461.88	86.53	29.48	36.61	8.82	88.22	54.00	-34.22	Average
2	2483.50	39.43	29.49	36.60	8.87	41.19	54.00	12.81	Average
3	2500.00	38.77	29.50	36.60	8.92	40.59	54.00	13.41	Average

Remarks: 1. Result = RD Level + Antenna Factor + Cable loss - Preamp Factor
 2. If Peak Result comply with Peak limit,AV Result is deemed to comply with AV limit

13 Antenna Requirement

13.1 Standard Requirement

An intentional radiator shall be designed to ensure that no antenna other than that furnished by the responsible party shall be used with the device. The use of a permanently attached antenna or of an antenna that uses a unique coupling to the intentional radiator shall be considered sufficient to comply with the provisions of this Section. The manufacturer may design the unit so that a broken antenna can be replaced by the user, but the use of a standard antenna jack or electrical connector is prohibited.

13.2 Antenna Connected Construction

The directional gains of antenna used for transmitting is 2.5 dBi, and the antenna connector is designed with permanent attachment and no consideration of replacement. Please see EUT photo for details.

13.3 Result

The EUT antenna is integral Antenna. It comply with the standard requirement.

14 Photographs of Test Setup

Photographs-Radiated Emission Test Setup in Chamber

Below 1G

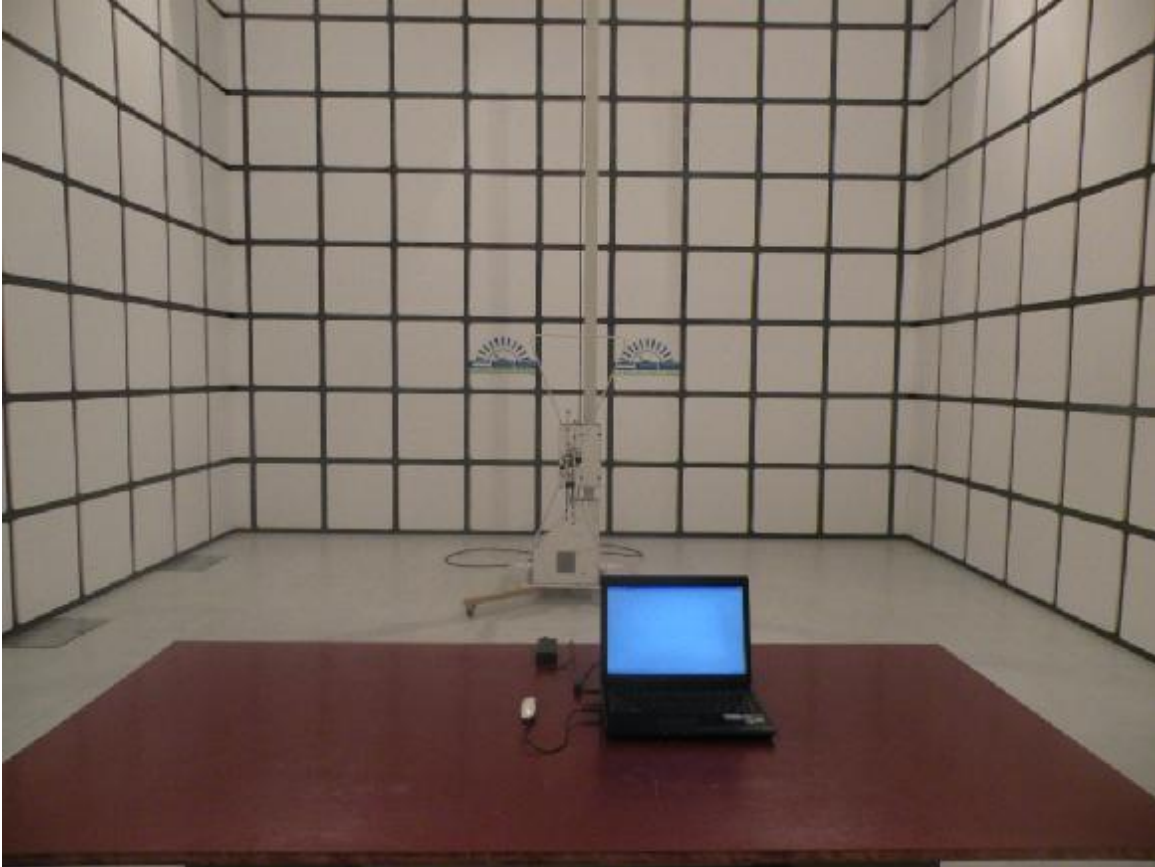

Above 1G

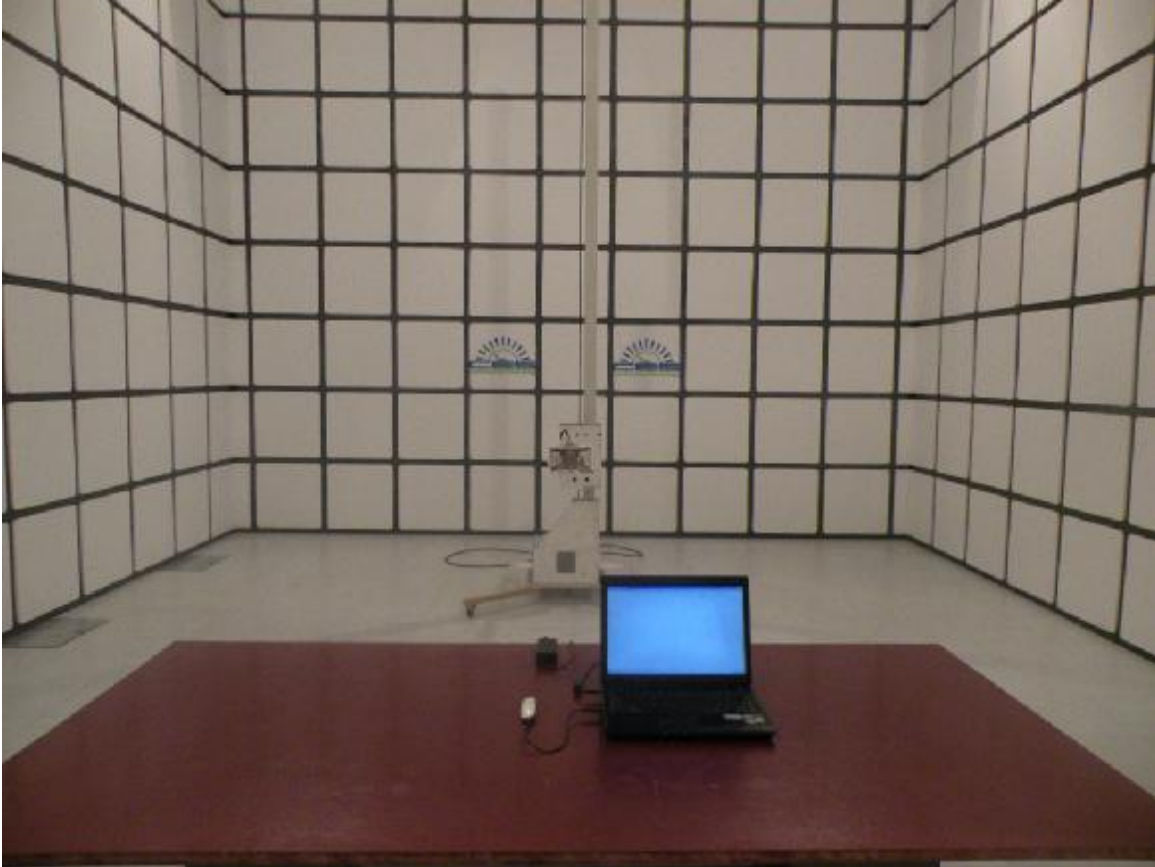

Photographs-Conducted Emission Test Setup



15 Photographs of EUT

Figure 1

Photo of EUT

Front View []

Rear View []

Full View []

Bottom View []

Left View []

Right View []

Full View []



Figure 2

Photo of EUT

Front View []

Rear View []

Top View []

Bottom View []

Left View []

Right View []

Full View []



Figure 3

Photo of EUT

Front View []

Rear View []

Top View []

Bottom View [✓]

Left View []

Right View []

Full View []



Figure 4

Photo of EUT

Front View [✓]

Rear View []

Top View []

Bottom View []

Left View []

Right View []

Internal View []



Figure 5

Photo of EUT

Front View []

Rear View []

Top View []

Bottom View []

Left View [✓]

Right View []

Internal View []



Figure 6

Photo of EUT

Front View []

Rear View [✓]

Top View []

Bottom View []

Left View []

Right View []

Internal View []



Figure 7

Photo of EUT

Front View []

Rear View []

Top View []

Bottom View []

Left View []

Right View [✓]

Internal View []



Figure 8

Photo of EUT

Front View []

Rear View []

Top View []

Bottom View []

Left View []

Right View []

Internal View [✓]

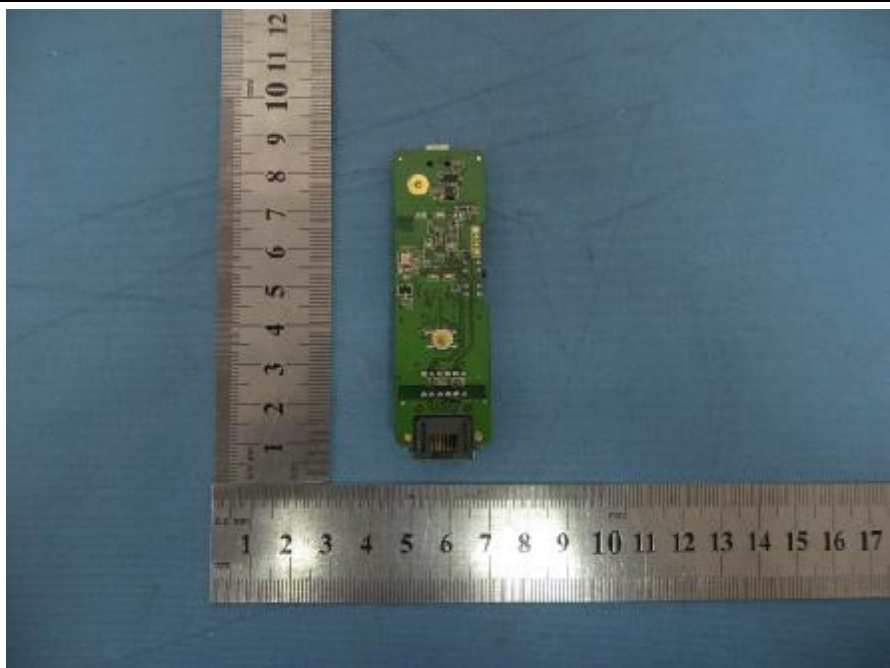

Figure 9

Photo of EUT

Front View []

Rear View []

Top View []

Bottom View []

Left View []

Right View []

Internal View [✓]

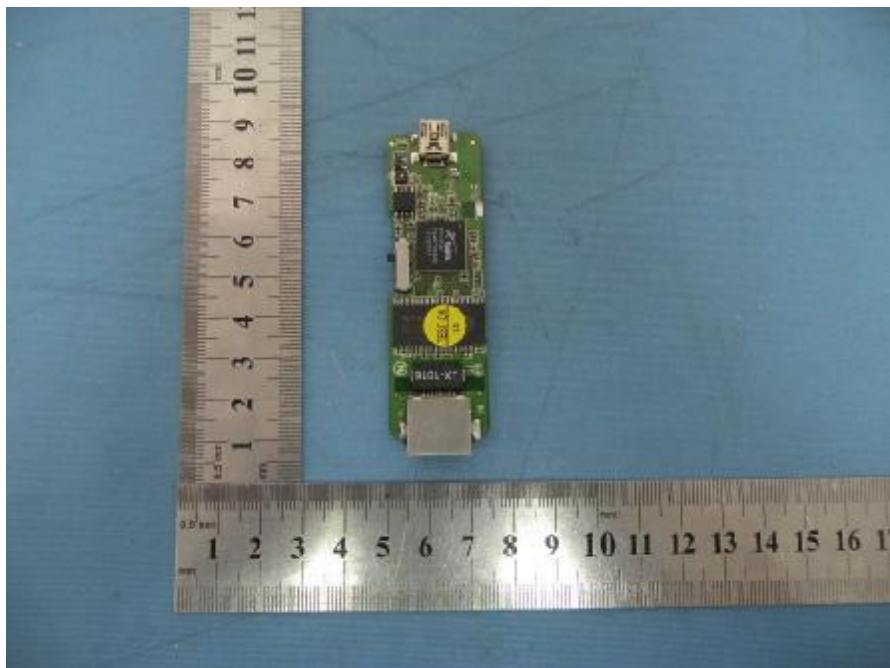

-----END OF THE REPORT-----