



www.alltekmarine.com

ALLTEK MARINE ELECTRONICS CORP.

T/886-2-2627 1599 F/886-2-2627 1600

Business@alltekmarine.com

7F, NO.605, Ruei Guang Rd., Neihu, Taipei, Taiwan 11492

CAMINO-201 → [**Class B AIS**] ←





Copyright

The entire contents of this instruction manual, including any future updates, revisions, and modifications, shall remain the property of AMEC at all times. Unauthorized copies or reproduction of this manual, either in part or whole, in any form of print and electronic media, is prohibited. The contents herein can only be used for the intended purpose of this manual.

Disclaimer

AMEC is devoted to publish and maintain this product manual. As we continue to improve our AIS products to satisfy all customers' needs, information in this document is subject to change without notice. AMEC does not make any representations or warranties (implied or otherwise) regarding the accuracy and completeness of this document and shall in no event be liable for any loss of profit or any commercial damage, including but not limited to special, incidental, consequential, or other damage.

Contact us at:

Technical Support:

(Your Local Dealer/Agent Warranty Stamp)

Sales & Marketing:

ALLTEK MARINE ELECTRONICS CO., LTD

7F, No.605, Ruei-Guang Road, Neihu, Taipei, Taiwan 114

TEL: +886 2 2627 1599

FAX: +886 2 2627 1600

www.alltekmarine.com

Version 1.52

WARNING!

FOR USERS IN THE UNITED STATES OF AMERICA ONLY

WARNING: It is a violation of the rules of the Federal Communications Commission to input an MMSI that has not been properly assigned to the end user, or to otherwise input any inaccurate data in this device.

- ★ The entry of static data into this device shall be performed by the vendor of the device or by an appropriately qualified person in the business of installing marine communications equipment on board vessels.
- ★ Instructions on how to accurately enter and confirm static data in the device can be found in Section 5.3 of this user manual.

The equipment said in this manual must only be used to which it was designed. Improper operation or installation may cause damage to the equipment or injury to personnel. AMEC will not incur any liability of equipment damage or personal injury due to improper use or installation of the equipment. It is strongly recommended to read this manual and the following safety instructions before proceeding to installation or operation.

SAFETY INSTRUCTIONS

WARNING



ELECTRICAL SHOCK HAZARD.

Do not open the case of the equipment. Only qualified personnel could work on the interior of the equipment.

TURN OFF THE POWER IMMEDIATELY IF WATER LEAKS INTO THE EQUIPMENT OR OBJECT DROPS INTO THE EQUIPMENT.

Continue operating the equipment could cause electrical shock or fire. Contact your nearest distributor for service.

DO NOT DISASSEMBLE OR MODIFY THE EQUIPMENT.

Improper disassemble or modification could cause electrical shocks, fire, or personal injury.

AVOID OPERATING THE EQUIPMENT WITH WET HANDS.

Electrical shocks could be resulted if operating with wet hands.

WARNING

TURN OFF THE POWER IMMEDIATELY IF THE EQUIPMENT IS EMMITTING SMOKE OR FIRE.

Continue operating the equipment could cause electrical shock or fire. Contact your nearest distributor for service.

EVEN THOUGH THE EQUIPMENT IS WATERPROOF, AVOID DIRECT CONTACT WITH RAIN OR SPLASHING WATER.

Electrical shock or fire could be resulted if water leaks into the equipment.

DO NOT PLACE ANY LIQUID-FILLED CONTAINER ON TOP OF THE EQUIPMENT.

Electrical shocks could be resulted if the device is contaminated with liquid.



FORWARD

Congratulations on the purchase of your new CAMINO-201 Automatic Identification System (hereinafter called "AIS"). No matter where you sail now, you can have a better control of your surrounding sea, and have an enjoyable voyage.

Camino-201 AIS is strictly tested to meet the rigorous demands of the marine environment. Unless improper use, installation, or maintenance, the equipment should function properly at its optimum.

We thank you for choosing our product and we wish you a bon voyage.



Table of Contents

- I. COPY RIGHT & DISCLAIMER
- II. WARNING & SAFETY INSTRUCTION
- III. FORWARD

	Pages
1 INTRODUCTION	1
1.1 CAMINO-201 Overview	1
1.2 Type of AIS	2
1.3 AIS Message Type	3
1.4 AIS Report Rate	3
1.5 About This Manual	4
1.6 Important Notice	4
2 INSTALLATION	5
2.1 General	5
2.1.1 Safety Instructions	5
2.1.2 Unpacking and Handling the Unit	6
2.1.3 Items in the Package	6
2.2 Installation Procedure	7
2.2.1 Installation Precautions	7
2.2.2 Step by Step Installation Instructions	8
2.2.3 Connector Pin Definition and Wiring	13
2.2.4 VHF Antenna Installation	15
2.2.5 GPS Antennas Installation	16
2.3 Antenna Cabling	16
2.4 CAMINO-201 External Connection	17
2.5 Quick Start Guide	18
3 KEYPAD OVERVIEW	22
3.1 Description of Controls	22
3.2 Turning the Power ON / OFF	23
3.3 Indicator Descriptions	24



4	HOT KEYS DESCRIPTIONS	25
4.1	SRM (Safety Related Message)	25
4.2	DISP (Display Modes Selection)	25
4.3	DIM (Dimmer for Display Brightness Control)	30
4.4	Arrow Keys	30
4.5	Menu Key	31
4.6	Menu Tree Structure	34
5	MENU KEY NAVIGATION	35
5.1	AIS Message List	35
5.1.1	Inbox (Received SRM)	35
5.1.2	Outbox (Transmitted SRM)	36
5.1.3	SRM Editing	38
5.2	AIS Target Status	39
5.2.1	Own Ship Information Settings	40
5.2.2	AIS Target List and Friend Ships	42
5.2.3	Region List and Setting	43
5.2.4	Ship Index and Individual Vessel Information	46
5.2.5	Product Version and Information	47
5.3	Ship Configuration and Setting	48
5.3.1	Own Ship Static Data (User Password Protected)	48
5.3.2	Friend Ship Editing	50
5.4	Transceiver ON / OFF Settings	52
5.5	System Configuration	53
5.5.1	Customizing System	53
5.5.2	Radar View Reference Point Setting	55
5.5.3	Factory Default Configuration (User Password Protected)	56
5.5.4	Output Port Baud Rate Settings	57
5.6	System Initialization	58
5.6.1	Password Setting	58
5.6.2	MMSI Editing	59
5.6.3	CPA/TCPA Settings (User Password Protected)	61
5.7	Dangerous Targets Information	62
6	DISPLAY MODE	63
6.1	Radar View	63
6.1.1	AIS Target Symbol Descriptions	64



6.1.2 Radar View Descriptions	66
6.2 Coastline Map Mode	69
7 APPENDIX	70
7.1 Product Specifications	70
7.2 Dimensions	73
7.3 Accessories	75
7.4 Trouble Shooting	75
7.4.1 Problem Analysis (By Status LED Indicator).....	75
7.4.2 Problem Analysis (Hardware).....	76
7.4.3 Problem Analysis (Software).....	77
8 AMEC WORLD WIDE WARRANTY	78
9 ABBREVIATIONS	81
10 INDEX	82

1 INTRODUCTION

1.1 CAMINO-201 Overview

The CAMINO-201 is a Class B AIS transponder using carrier-sense TDMA (CSTDMA) technology. It is designed to inter-operable and compatible with Class A or other Class B shipborne mobile AIS stations or any other AIS station operating on the AIS VHF data link.



CAMINO-201 AIS uses marine VHF channels with frequency set universally from 156.025 MHz to 162.025 MHz. Having CAMINO-201 AIS on board, not only can you monitor the status of the vessels in the surrounding area, but also receive the dynamic information (position, speed, SOG, and etc.), static information (ship name, MMSI, call sign, and etc.), and voyage related information (cargo type, destination, and etc.) from any vessels equipped with AIS.

CAMINO-201 AIS is one of the cutting-edge navigational aid equipment allowing real-time information exchanges within AIS network. It is also capable of integrating with other maritime systems such as Electronic Chart System (hereinafter called "ECS") for various maritime navigation applications.

CAMINO-201 is designed with 2 RF receivers and 1 RF transmitter. One of the RF receivers is time-shared between AIS and DSC. At front side, CAMINO-201 equips with 5.7" LCD display

panel and 10 functional keypads. At rear side, CAMINO-201 equips with 1 VHF antenna connector, 1 GPS antenna connector, 1 NMEA interface connector, 1 RS232 interface connector, and 1 power connector.

***NOTE:** The CAMINO-201 is an equipment to be used in protected environmental conditions. It is not intended to expose to rain or spray longer than couple minutes.

1.2 Type of AIS

There are mainly two types of AIS transponder: Class A and Class B. The intended nature of these AIS systems in navigations is different as illustrated in the following table. CAMINO-201 is a Class B AIS transponder.

Table 1-2 Type of AIS

Class A AIS	<ul style="list-style-type: none">• Transmits and receives AIS signal in SOTDMA protocols.• Intended for vessels meeting the IMO AIS carriage requirements.• It is mandatory for all commercial vessels that exceed 300 tons to be equipped with Class A AIS.
Class B AIS	<ul style="list-style-type: none">• Transmits and receives AIS signal in CSTDMA protocols.• Not necessarily in accord with IMO AIS carriage requirements.• It is not mandatory for vessels to be equipped with Class B AIS.• Suitable for recreational vessels or fishing boats, in enhancing its safety at sea.

1.3 AIS Message Type

The CAMINO-201 supports following message types.

Table 1-3 CAMINO-201 AIS message type

Type of Message	Data Details
Static Data	Maritime Mobile Service Identity number ("MMSI") Call sign and name Type of ship Length and beam GPS Antenna location
Dynamic Data	Position of the vessel Course Over Ground (hereinafter called "COG") Speed Over Ground (hereinafter called "SOG") Heading
Dynamic Reports	Speed of the ship Status of the ship
SRM	Alarm Safety

1.4 AIS Report Rate

The CAMINO-201 supports following report rate in accordance to ITU-R M.1371 and IEC 62287-1.

Table 1-4 CAMINO-201 AIS report rate

Platforms Condition	Nominal Reporting Interval
Class B Ship-borne mobile equipment not moving faster than 2 knots	3 Minutes
Class B Ship-borne mobile equipment moving faster than 2 knots	30 Seconds
Report rate by command of VTS	5 Seconds highest



1.5 About This Manual

The manual contains installation instructions and operating information for CAMINO-201. While most of the installation can be performed by the owner or the crew, a final commissioning can be done by your local agent/dealer where needed or required. AMEC and the local agent/dealer will not bear any responsibilities over any damages resulted in improper installation by unauthorized agent/dealer.

1.6 Important Notice

The intended use of the AMEC CAMINO-201 AIS is to enhance the safety of vessels at sea. However, a few points must be noted as below,

- Any AIS cannot guarantee in monitoring and receiving signals from all vessels in the surroundings unless those vessels equip with AIS device.
- It is important to note that the AIS is designed for the purpose of anti-collision and is serves as a compliment to navigation. It is not navigational equipment and does not replace any navigational system installed on board.
- Although AIS is operated automatically by itself, the owner or the crew on the vessel should still maintain a proper lookout for the surroundings. While the AIS is capable of setting alarm of Distance to Closest Point of Approach (hereinafter called “CPA”) and Time to the Closest Point of Approach (hereinafter called “TCPA”), vessel owner or the crew should be aware of the fact that there are vessels that are not equipped with AIS, and this function will not apply on these vessels.
- Incorrect data and information entered into the AIS is considered as erroneous information. Erroneous information or improper configuration will cause risk to other vessels and the own vessel when these information are transmitted. Users must be aware of this risk and make sure that all the information entered into the system is correct and up to date.

2 INSTALLATION

2.1 General

The installation information for the CAMINO-201 is sub-divided into proper steps in block diagrams for easy reference.

2.1.1 Safety Instructions

Before proceeding with installation, take note of the following safety instructions and read through this installation manual carefully.

SAFETY INSTRUCTIONS



<div style="background-color: black; color: white; text-align: center; padding: 5px;">WARNING</div> <div style="padding: 5px;">  <p>ELECTRICAL SHOCK HAZARD Do not open the case of the equipment. Only qualified personnel could work on the interior of the equipment.</p> </div> <div style="padding: 5px;"> <p>TURN OFF THE POWER BEFORE PROCEEDING WITH INSTALLATION. Proceeding with installation with the power on could cause electrical shock or fire.</p> </div> <div style="padding: 5px;"> <p>AVOID INSTALLING THE EQUIPMENT WHERE THERE IS DIRECT CONTACT WITH RAIN OR SPLASHING WATER. Electrical shock or fire could be resulted if water leaks into the equipment.</p> </div> <div style="padding: 5px;"> <p>MAKE SURE THE POWER SOURCE AND THE POWER INPUT OF THE EQUIPMENT ARE COMPATIBLE. Damage to the equipment and fire could be resulted if the power sources are not correct. Please check the correct power input on the adaptor.</p> </div>	<div style="padding: 5px;"> <p>FOLLOW THIS INSTRUCTION MANUAL TO PROCEED WITH THE INSTALLATION. AMEC and your local agent/dealer will not bear any responsibility of equipment damage or personnel injury due to improper installation.</p> </div> <div style="text-align: center; padding: 5px;">  WARNING </div> <div style="padding: 5px;"> <p>Warning Label A warning label (Figure 2-1-1) is attached underneath the equipment. Warranty of the equipment will be invalid if this label is detached or broken. AMEC and your local agent/dealer will not bear any responsibility of any damage to the equipment, or damage in related to the equipment, personnel injury, and etc. Reject the equipment if this label is detached or broken. Please contact your local agent/dealer if this label is missing.</p> </div>
<div style="display: flex; align-items: center; justify-content: center; gap: 10px;"> <div style="border: 1px solid black; border-radius: 10px; padding: 5px; display: flex; align-items: center; gap: 5px;"> <div style="text-align: center;">  Warning 注意 </div> <div style="font-size: 0.8em; line-height: 1.2;"> Name: Warning Label No Warranty if this label is detached or broken. 保固撕毀无效 </div> </div> </div>	

Figure 2-1-1 Warning label

2.1.2 Unpacking and Handling the Unit

- 1 Move and handle with cautious. Do not drop or bump.
- 2 Visual inspection should be taken on the box to see if it is intact.
- 3 Unpack the product on a flat and level surface.
- 4 Unpack the box with the “this side up” sign facing up.
- 5 Take extra caution if requiring sharp object to unpack.
- 6 After unpacked, check if all the accessories and unit are included.

2.1.3 Items in the Package

The CAMINO-201 is typically delivered with standard package as shown in Table 2-1-3. It is also illustrated in Figure 2-1-3 (except manual).

Table 2-1-3 Standard equipment list

No.	Description	Product Code	Qty	
1	CAMINO-201 Class B AIS main unit	CAMINO-201	1	
2	Manual	AIS-MNL-B201-E	1	
3	Installation Kit	Power cable, 1m (3A)	M-ACC-CAB-AL-006	1
		NMEA 0183 interface cable, 1.5m	ACC-CAB-001	1
		RS-232 interface cable, 1.2m	ACC-CAB-002	1
		Knob	ASM-KNB-AISCLB01	2
		Mounting bracket with buckle tenons	ASM-CRU-AISCLB01	1
		Washer	ACC-WHR-001	2
		Spring washer	ACC-WHR-002	2
		M8 Screws	ACC-SRW-001	4

***NOTE:**

- (1) AMEC would not be able to fully ensure overall product performance if longer cable length other than the specified length is used.
- (2) If an extension power cable is required, use large gauge cable to minimize voltage drops.

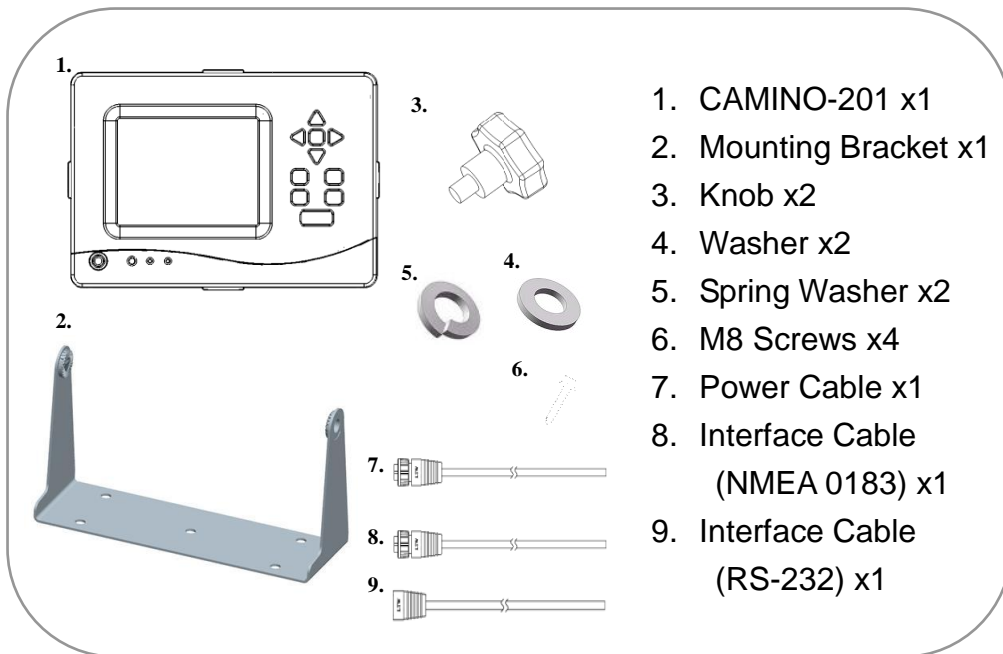

Figure 2-1-3 Package items

2.2 Installation Procedure

2.2.1 Installation Precautions

- ① Installation should proceed in a safe environment and does not have direct contact with rain or splashing water.
- ② If it is required to use a ladder to install the equipment, take extra caution and be careful of falling down.
- ③ Do not place or install the equipment beneath or near any container that filled with water or liquid.
- ④ Do not place or install the equipment where it is easily tripped, stepped on, or kicked at.
- ⑤ Do not place or install the equipment near any generator or engine.
- ⑥ When installation is completed, please remember to key in own ship's MMSI data and related information through keypad.

2.2.2 Step by Step Installation Instructions

AMEC CAMINO-201 can be installed and mounted on flat surface, or it can be hung on the ceiling or wall as shown below.

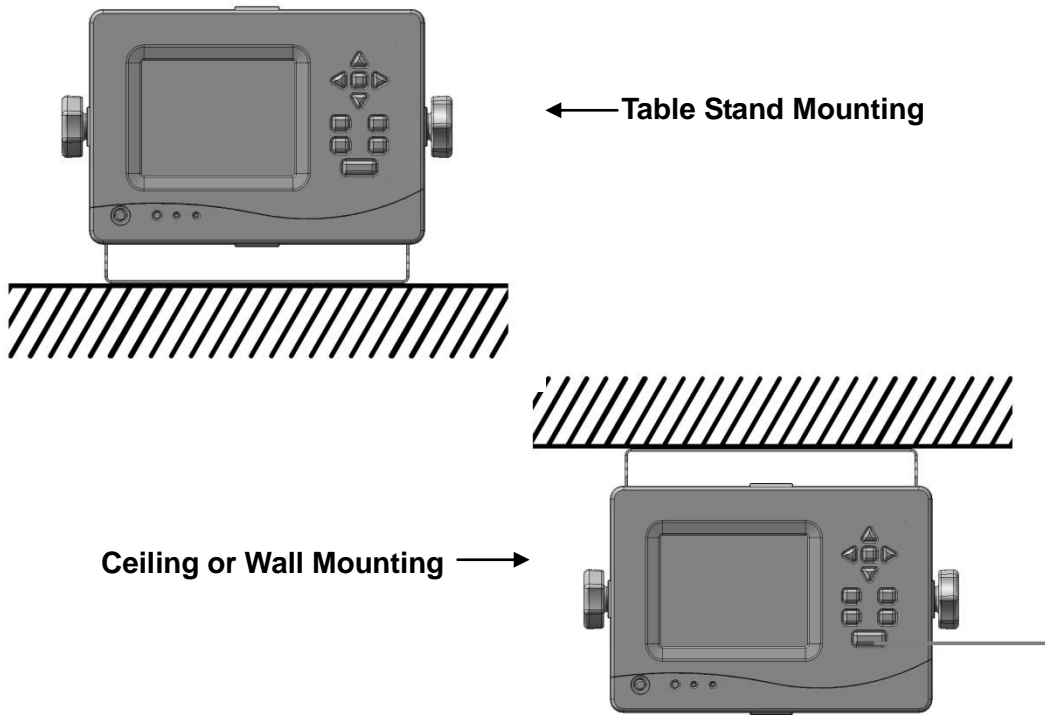
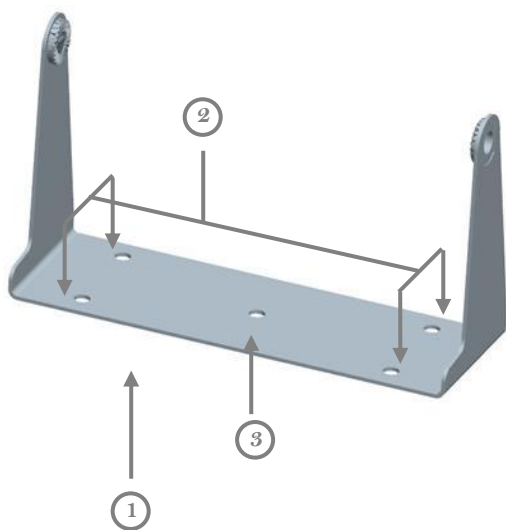

Figure 2-2-2-1 Installation overview

The installation procedure is graphically illustrated in the following steps.

I. Installation Instructions



Step 1:

Place the mounting bracket ① on the desired spot for installing the CAMINO-201 ⑥ .
(Refer to Figure 2-2-2-2)

***NOTE:**

Secure the mounting bracket ① first before mounting CAMINO-201 ⑥ .

Step 2:

Use the 4 M8 screws provided to secure the ③ at the 4 holes marked ② .

Figure 2-2-2-2 Installation instruction

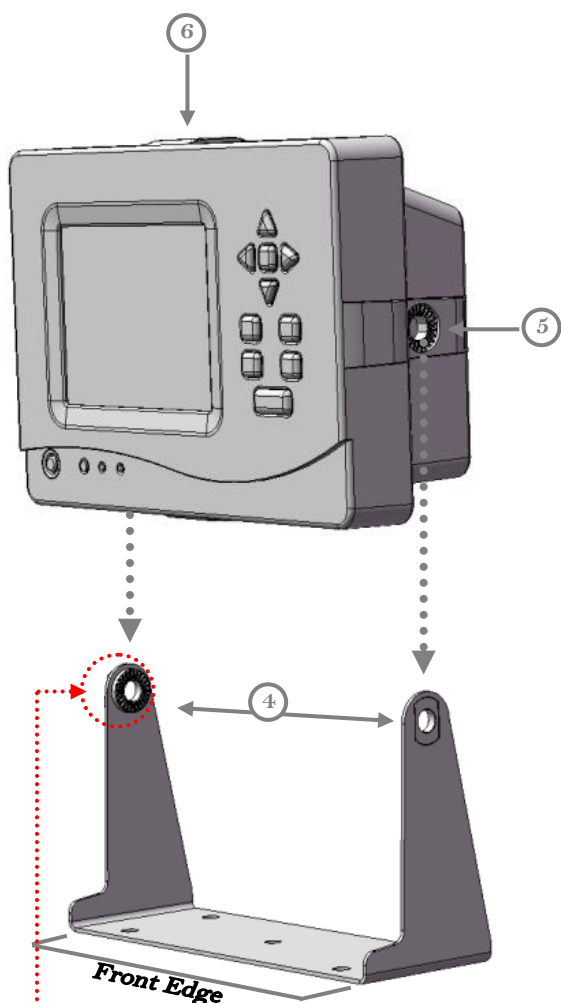

Figure 2-2-2-3 Installation instruction

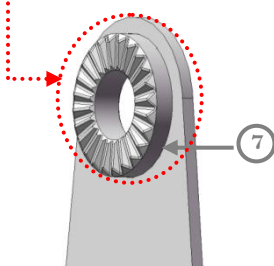

Figure 2-2-2-4 Installation instruction

Step 3:

Align the mounting bracket joint on the CAMINO-201 (5) with the body joint (6) on the mounting bracket, (4) and mount the CAMINO-201 onto the mounting bracket(Refer Figure 2-2-2-3)

Table Stand Mounting:

The Display Panel of the CAMINO-201 and the Front Edge of the mounting bracket should be on the same side.

Ceiling Mounting:

The Display Panel of the CAMINO-201 and the Back Edge of the mounting bracket should be on the same side.

Wall Mounting:

The Display Panel of the CAMINO-201 should face forward, and the front edge of the mounting bracket should face down.

***NOTE:**

For faster and easier installation, the Buckle Tenon (7) for angle adjustment has fixed on the body joint (4) .
(Refer to Figure 2-2-2-4)

II. Interface Connection

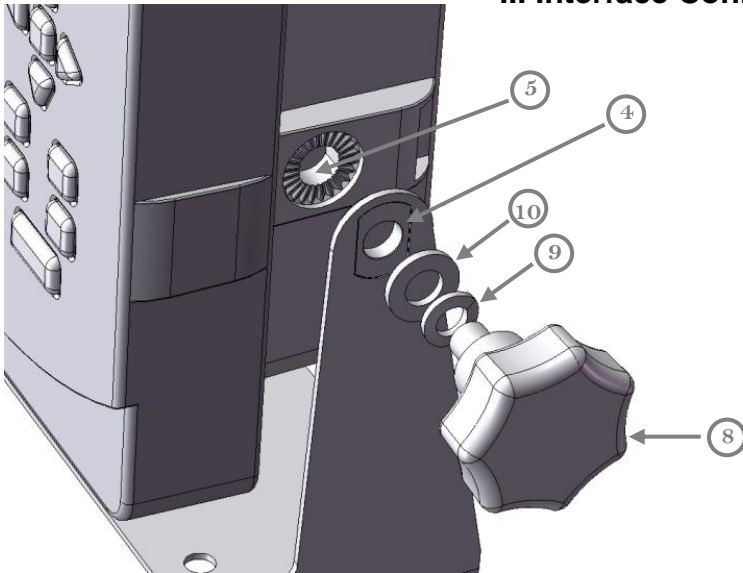

Figure 2-2-2-5 Installation instruction

Step 4:

When the mounting bracket and the CAMINO-201 are aligned, insert the knob (8) thru the Spring Washer (9), the Washer (4), then the body joint till it click on the mounting bracket joint (5) as shown in Figure 2-2-2-5.

Step 5:

- Knob (8) should be placed outside of the body joint (4) .
- Spring Washer (9) and Washer (10) should be placed outside of the body joint (4) in the order as shown in Figure 2-2-2-5.

Step 6:

Tighten up the Knob (8) to fix the angle of the CAMINO-201.
Loosen the Knob (8) to adjust the angle of the CAMINO-201
(Refer to Figure 2-2-2-5)



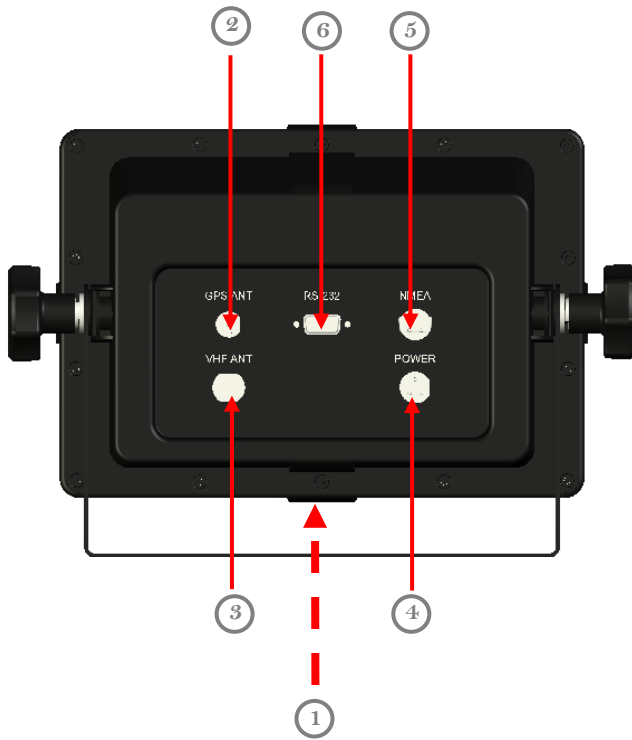

Figure 2-2-2-6 Installation instruction

Step 1:

Connect the GPS cable to the GPS ANT connector ②.*

Step 2:

Connect the VHF cable to the VHF ANT connector ③.

Step 3:

Connect other NMEA 0183 compatible system to the NMEA interface ⑤.

Step 4:

Connect the computer to the RS-232 interface ⑥ if needed.

Step 5:

Connect the Power cable to the Power connector ④.

***NOTE:** CAMINO-201 SUPPLIES ONLY 3.3V FOR GPS ANTENNA. DO NOT CONNECT A 5V GPS ANTENNA TO CAMINO-201 AS IT WOULD CAUSE SIGNIFICANT DAMAGE TO THE EQUIPMENT AND THE ANTENNA. WE RECOMMEND YOU TO USE AMEC GPS ANTENNA WITH CAMINO-201.

2.2.3 Connector Pin Definition and Wiring

2.2.3.1 Power Connector

A red wire and a black wire are included in the power cable.

Table 2-2-3-1 Power wiring details

PIN	WIRE COLOR	NAME	FUNCTION
1	Red	PWR	Positive (+), the input should be 12V / 24V DC
2	/	/	/
3	Black	GND	Power ground

2.2.3.2 NMEA 0183 Connector

The NMEA 0183 interface cable contains 12 different wires. Refer to the following table for the wiring details.

Table 2-2-3-2 NEMA 0183 wiring details

PIN	COLOR	NAME	FUNCTION
1	Brown	RXP	Positive (+); CAMINO-201 receives external NMEA 0183 device information.
2	Blue	RXN	Negative (-); CAMINO-201 receives external NMEA 0183 device information.
3	White	TXP	Positive (+); Transmit AIS information.
4	Green	TXN	Negative (-); Transmit AIS information.
5	Yellow	/	/
6	Gray	/	/
7	Pink	/	/
8	Red	/	/
9	Black	/	/
10	Orange	ALMB	Alarm output
11	Purple	ALMA	Alarm input
12	Light Green	/	/

NMEA 0183 Wiring

Refer to the following wiring method for the external NMEA device with NMEA 0183 interface or RS-422.

CAMINO-201 NMEA 0183

External NMEA device

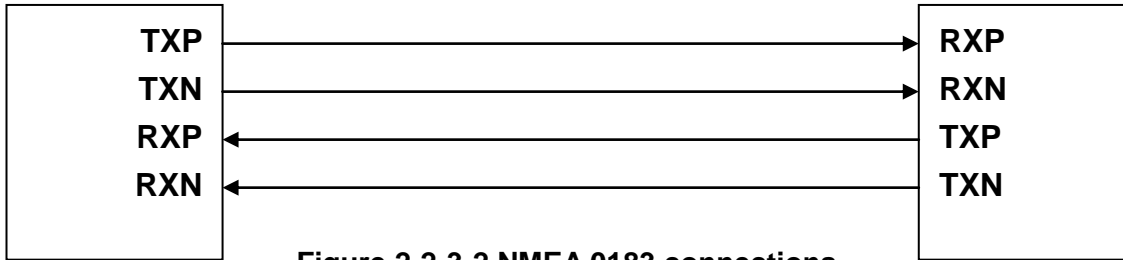

Figure 2-2-3-2 NMEA 0183 connections

***NOTE:** Please make sure the external device is fully NMEA 0183 compiled.

2.2.3.3 RS-232 Connector

RS-232 Connector contains 9 different wires. Refer to the following table for the wiring details.

Table 2-2-3-3 RS-232 wiring details

NO.	NAME	FUNCTION
1	/	/
2	RX	Receive Data
3	TX	Transmit Data
4	/	/
5	GND	Power Ground
6	/	/
7	/	/
8	/	/
9	/	/

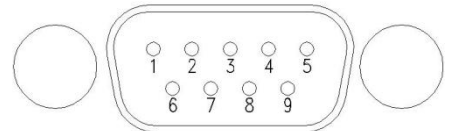

RS-232 Wiring

Refer to the following wiring method for the external RS-232 device with RS-232 interface.

CAMINO-201 RS-232

PC RS-232

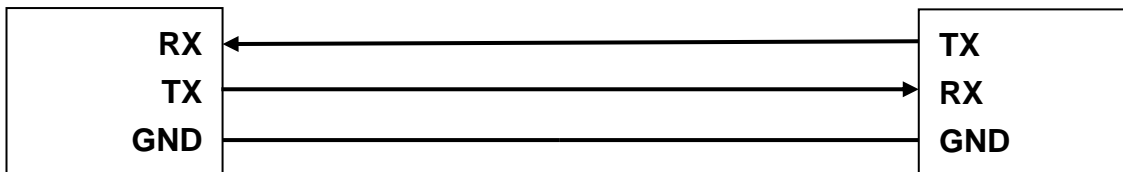

Figure 2-2-3-3 Connecting to PC via RS-232

2.2.4 VHF Antenna Installation

The quality and positioning of the antenna is the most important factor dictating AIS performance. It is recommended that a VHF antenna with omni directional vertical polarization be specifically tuned for AIS operation band. Since the range of VHF signals is largely decided by line of sight distance, AIS antenna should be placed as high as possible and at least 5 meters away from any constructions made of conductive materials.

To avoid interference, the VHF antenna location should be placed in accordance to Figure 2-2-4.

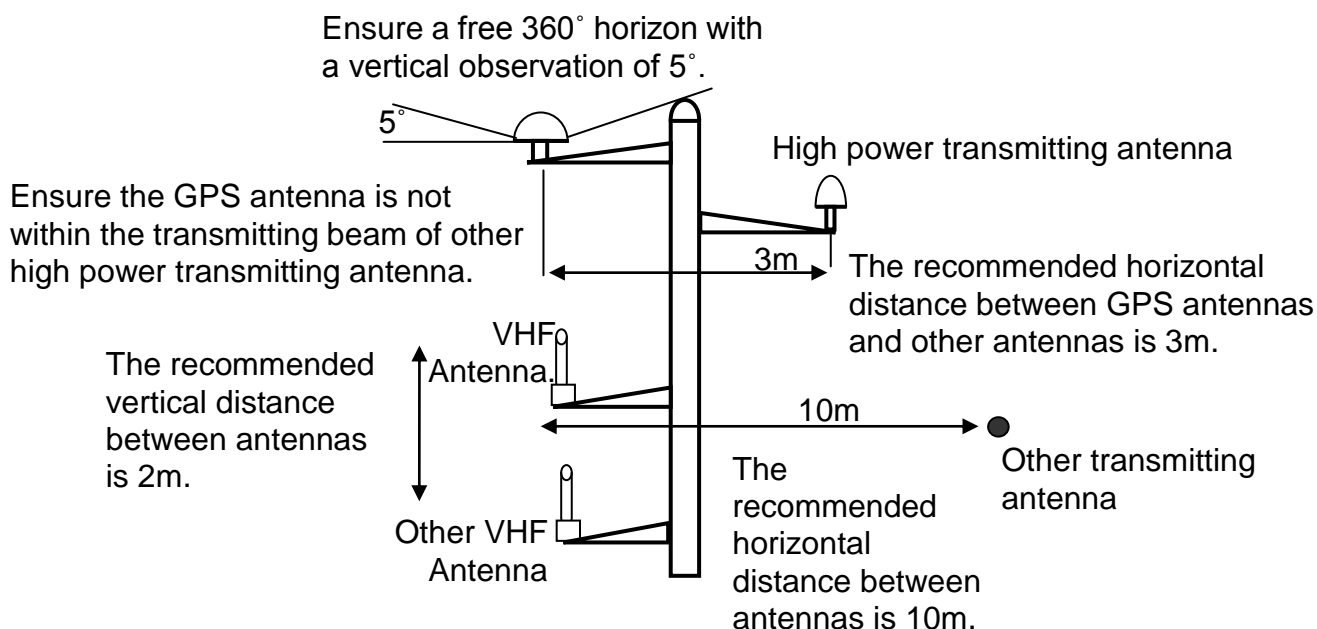

Figure 2-2-4 VHF/GPS Antenna Location

We recommend you choose AMEC AIS VHF antenna. To save space, you can also choose VHF/GPS combo antenna provided by AMEC

2.2.5 GPS Antennas Installation

The GPS antenna must be installed where it has a clear view of the sky, so that it accesses the horizon freely through 360°, with a vertical observation of 5 to 90 degrees above the horizon as illustrated in Figure 2-2-5.

GPS ANTENNA LOCATION

Enter the external and internal GPS antenna location data after installing them. Input the data in “SHIP SETTING”. Following is the GPS antenna location offset arm.

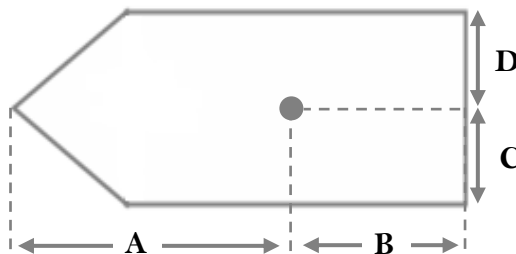

Figure 2-2-5 GPS Antenna location

We recommend you choose AMEC AIS GPS antenna. To save space, you can also choose VHF/GPS combo antenna provided by AMEC.

2.3 Antenna Cabling

When connecting the cable(s) with the CAMINO-201, take note of the following precautions.

- ① Do not bend the cable(s).
- ② Antenna cable should be kept as short as possible.
- ③ Antenna cable and connectors must be rated at 50Ω.
- ④ Connecting port of the coaxial cable should be insulated and waterproofing.
- ⑤ AIS antenna cable should be installed in separate single cable tube or channel.
- ⑥ Each antenna cable should keep a 10m safe distance with the high-power radio-transmitter lines or power cable.

2.4 CAMINO-201 External Connection

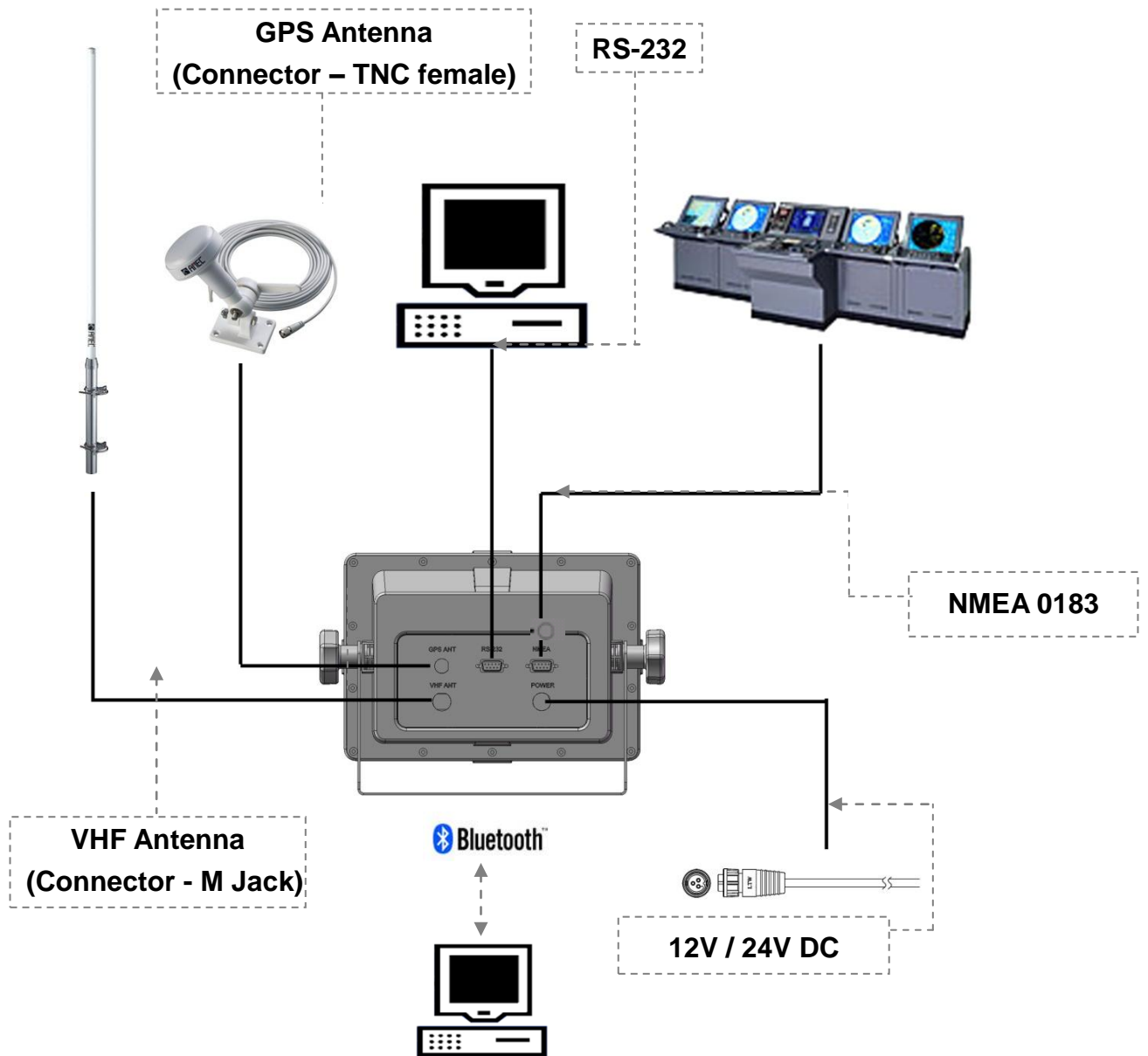

Figure 2-4 External Connection

***NOTE: Bluetooth Pairing**

Refer to the manual of your Bluetooth device for connection. AMEC's default pairing security code is "0000".

2.5 Quick Start Guide

When installation is completed, proceed to the following steps for quick start-up.

Step 1: Turn on the unit by pressing the power button.

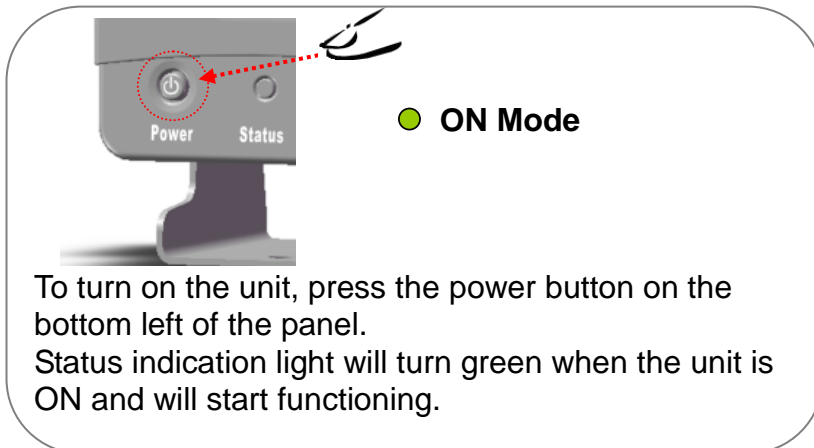

Step 2: After the unit is turned on, the system will run a self-testing as shown below,

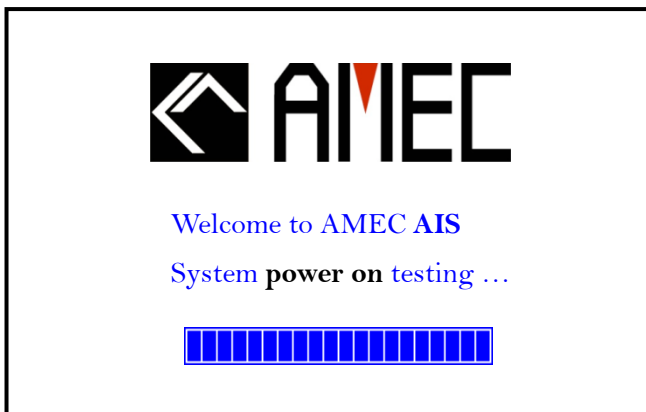

Step 3: When the self-testing is completed, **MMSI** set-up reminder screen will appear.

- Choose “**CANCEL**” if not entering the MMSI and skip to **Step 7**.
- Choose “**OK**” to enter the MMSI and proceed to **Step 4**.

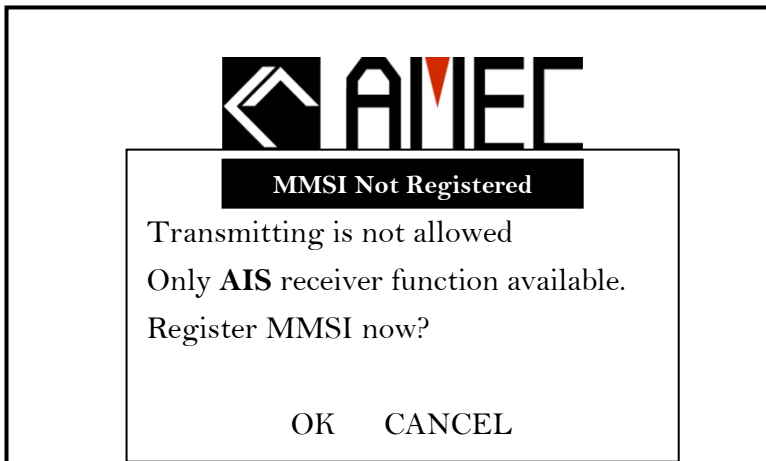

Step 4: MMSI can only be entered ONCE as regulated. A pop out window will appear to confirm this process.

- Choose “**CANCEL**” and skip to **Step 7**.
- Choose “**OK**” and the MMSI set up screen will appear as shown in **Step 5**.

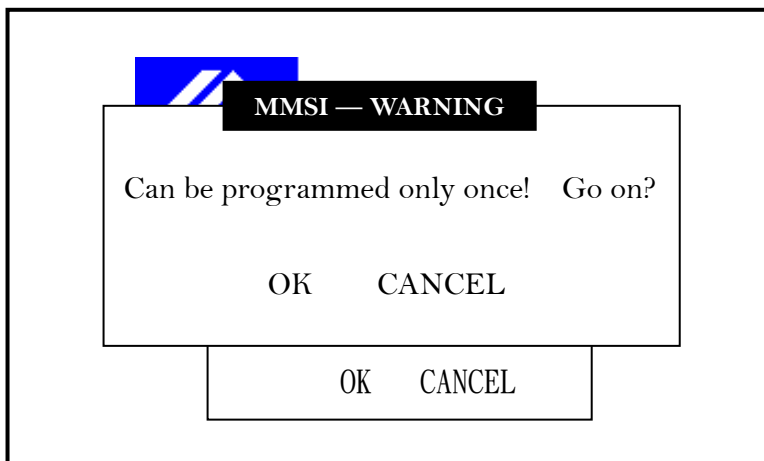

Step 5: Enter the MMSI by using the arrow keys. (Refer to section 5.4. on Arrow key instructions)

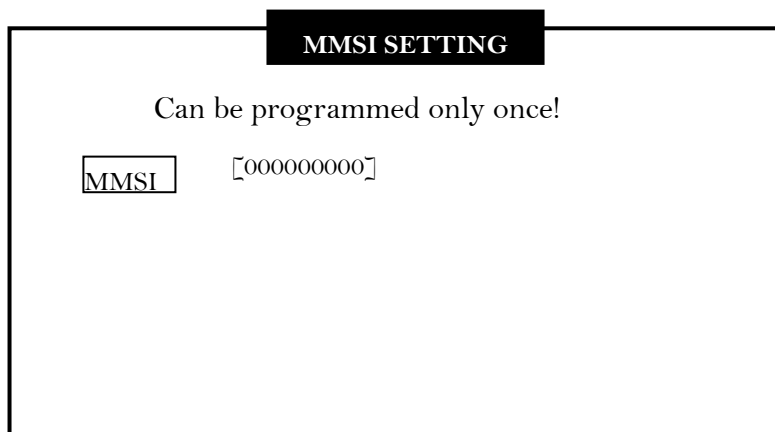

FOR USERS IN THE UNITED STATES OF AMERICA ONLY
WARNING: It is a violation of the rules of the Federal Communications Commission to input an MMSI that has not been properly assigned to the end user, or to otherwise input any inaccurate data in this device.

Step 6: When completed entering the MMSI, press the <ENT> key on the front panel and a pop out window will appear to confirm this process.

- Choose “**CANCEL**” to discard the process and NOT to store this data, and skip to **step 7**.
- Choose “**OK**” to store this data and to enter the main menu. Unit will now activate and function by broadcasting own ship’s voyage related data and receiving other ships’ AIS data.

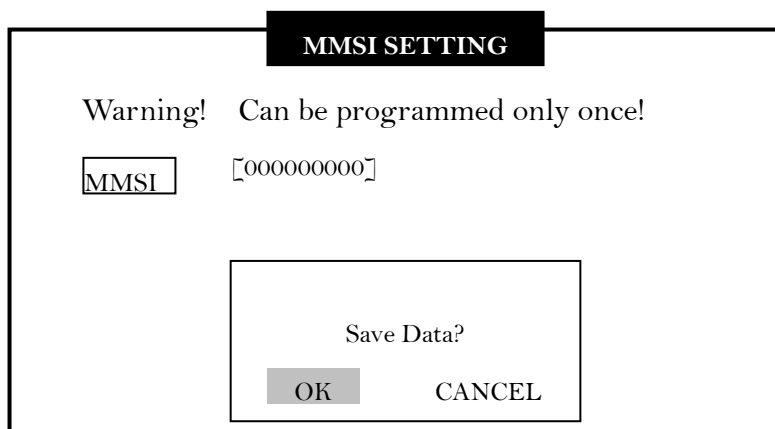

***NOTE:**

- Quick start is completed if MMSI is entered and stored in **Step 6**.
- Proceed to section **5.6.2** entering other data.

Step 7: The system automatically goes into the main display and the system starts to receive other ships' AIS broadcastings. Other ships' locations are also displayed on the radar view.

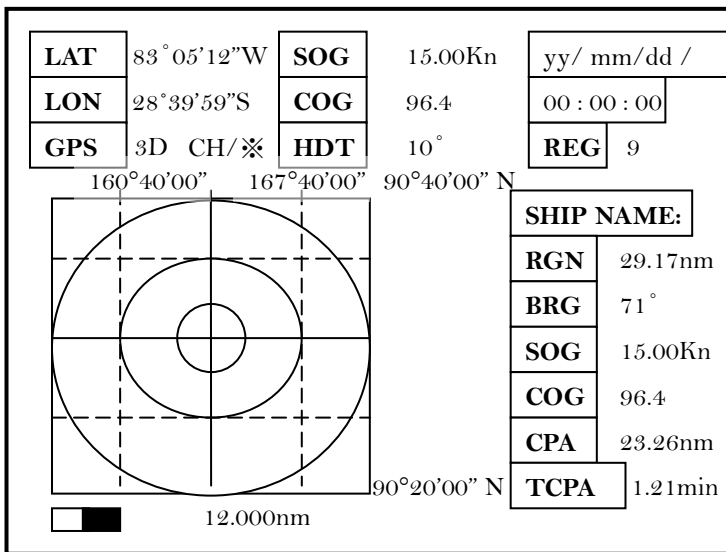

***NOTE:** As regulated, AIS cannot broadcast own ship's voyage related information before MMSI is set. The system now can only receive other ships' broadcastings.

(For the system to be fully functioning, follow the instructions in section **5.6.2**, **5.3.1**, and **5.3.2** on entering the MMSI, ship name, call sign, status, cargo type, dimension, and etc.)

3 KEYPAD OVERVIEW

3.1 Description of Controls

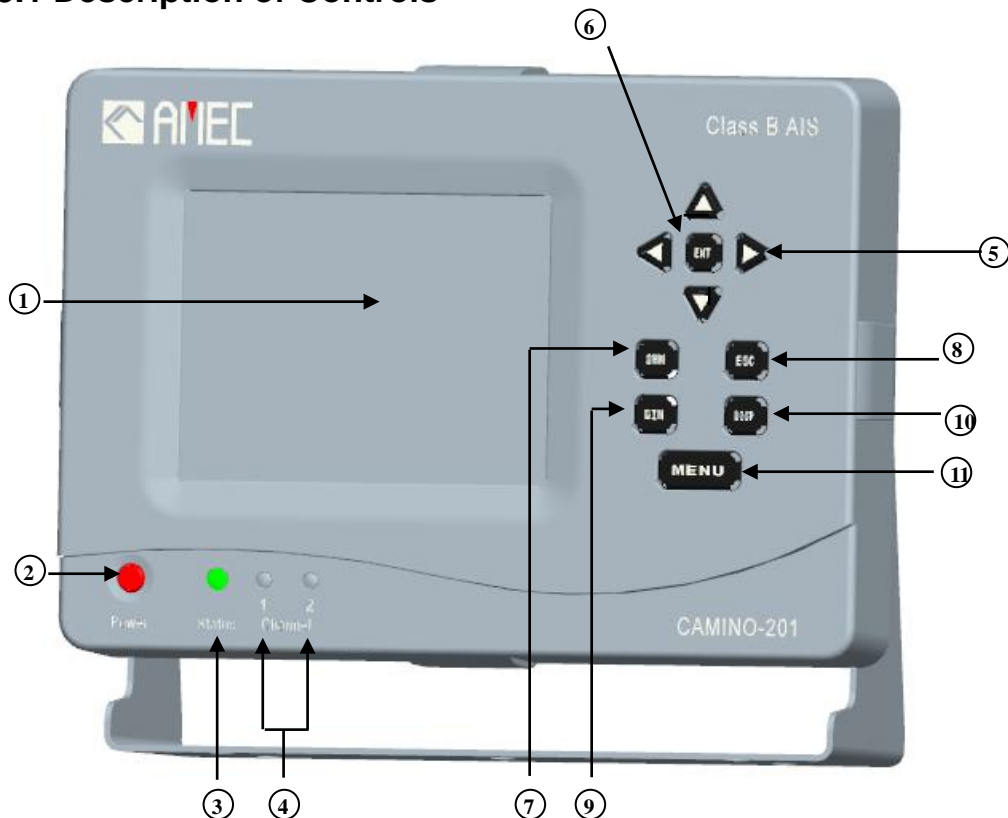

Figure 3-1 Keypad Controls

- | | |
|-------------------------|--------------------------------------|
| 1. DISPLAY PANEL | Display information |
| 2. POWER | Power ON/OFF |
| 3. Status | Status Indication Light |
| 4. CHANNEL 1/2 | Channel 1 & 2 Indication Light |
| 5. UP | Arrow Key / UP |
| DOWN | Arrow Key / DOWN |
| LEFT | Arrow Key / LEFT |
| RIGHT | Arrow Key / RIGHT |
| 6. ENT | Enter Key / Confirm Selection |
| 7. SRM | Safety Related Message |
| 8. ESC | Escape / Return to the Previous Page |
| 9. DIM | Display Brightness Adjustment |
| 10. DISP | Display Modes Selection |
| 11. MENU | Main Menu / Return to the Main Menu |

3.2 Turning the Power ON / OFF

Refer to the following instructions to turn ON or OFF CAMINO-201

TURNING THE POWER ON:

Step 1: Connect the CAMINO-201 to the power input.

Step 2: Press the power button and the status indicator will turn green from red.

Step 3: When the status indicator turns green, the unit will function automatically.

TURNING THE POWER OFF:

Step 1: When the unit is ON and functioning, press the power button will switch off the unit.

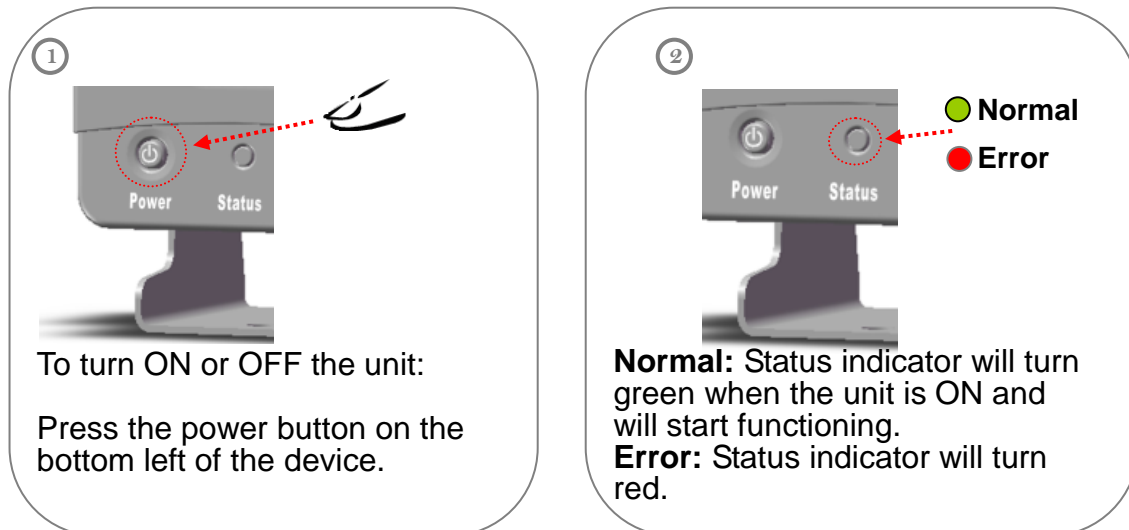

Figure 3-2 System Power ON / OFF Control

3.3 Indicator Descriptions

CAMINO-201 mainly contains two categories of LED indicators, Status Indicator and Channel Indicator. The respective meaning of each indicator is shown in the following two tables.

Table 3-3-1 Status LED Indicator

STATUS LED INDICATOR		
Color	State	Descriptions
Green	ON	Normal
Orange	ON	(1) Transmitting Not Allowed: MMSI is not set. Unit can only receive data. Unit can transmit when the MMSI is set and GPS is not in 3D positioning. (2) Tx Off Mode: The device is turned into Tx Off mode (Silent mode) by setting in the main Menu (Section 5.4)
	Flash	TX Timeout: Channel is jammed or being assigned as Quiet mode by the VTS. Only receiving is allowed. Unit can transmit when the situations resolved.
Red	ON	Power Error: Check for power connection and power voltage.
	Flash	BIIT alarm: An abnormal condition of the device is detected during BIIT (Built In Integrity Test). (*NOTE)

***NOTE:** With BIIT (Built in Integrity Test) feature, the CAMINO-201 is constantly monitoring and testing the integrity of the AIS transceiver. Should there be an abnormal condition detected in the device, the Status LED will display an alarm in flash red. Abnormal condition may include situations like following:

- GPS is unable to gain lock after 30 minutes of losing GPS track
- Background noise level exceeds allowable threshold (-77dBm)

Table 3-3-2 Channel Indicators

CHANNEL INDICATORS		
Channel	Status	Indications
1	Flash Green	Incoming data received at Channel 1.
2	Flash Green	Incoming data received at Channel 2.
1	Flash Orange	Transmitting data at Channel 1.
2	Flash Orange	Transmitting data at Channel 2.

4 HOT KEYS DESCRIPTIONS

4.1 SRM (Safety Related Message)

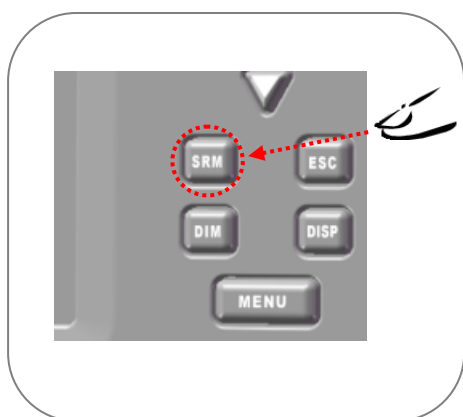

Figure 4-1 SRM

Step 1: Press the <SRM> key.

Step 2: Use the <UP> and <DOWN> keys to select safety related message.

Step 3: Press the <ENT> key to confirm and transmit the message. System will start broadcasting the SRM.

Step 4: To cancel the SRM transmission, press the <ESC> key to escape from the SRM menu.

** SRM broadcasting is only allowed to send a SRM one time in one minute.

**Detailed information please refer to section 5.1.3.

4.2 DISP (Display Modes Selection)

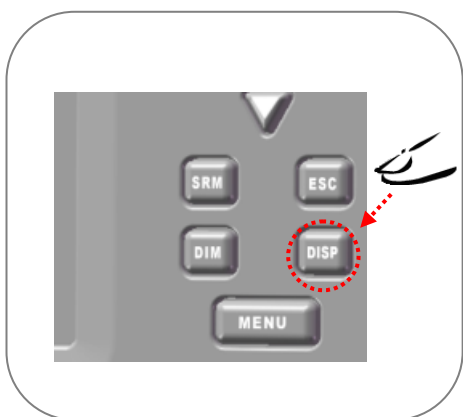

Figure 4-2 DISP

Step 1: Press the <DISP> key to switch to different display modes.

Step 2: Display modes will switch in the order as below,

- (A) Coastline Map
 - (B) Radar View
 - (C) Dangerous Target Information
 - (D) Own Ship Data
 - (E) Region Setting
- ←.....

Refer to the following descriptions for each display mode.

(A) COASTLINE MAP VIEW:

Display the coastline of the position area and the situations of the surrounding ships.

**Refer to section 6.2 for details.

(B) RADAR VIEW:

Radar view is the main display of the system, displaying own ship's information and target ships' dynamic information.

**Details refer to section 6.

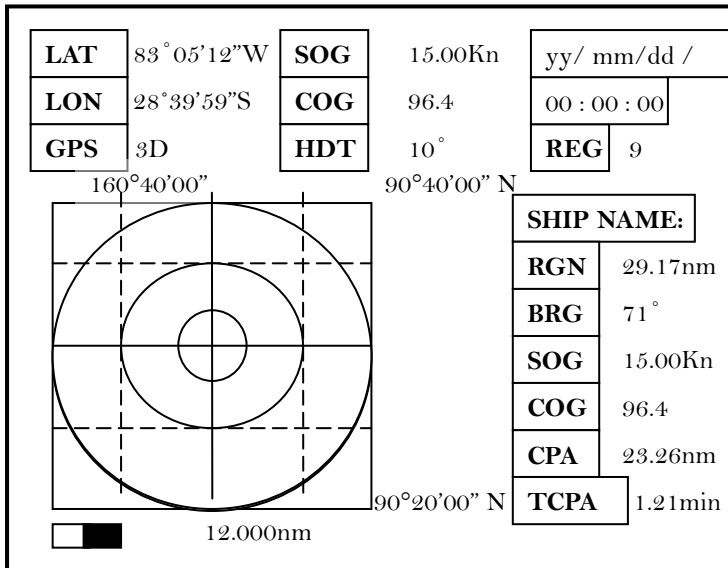

Figure 4-2-1 Radar View

(C) DANGEROUS TARGET INFORMATION:

When a target is within a certain distance to own ship, such as smaller than the preset CPA or TCPA value, this target will be considered as a dangerous target. The dangerous targets will then be listed as shown below.

DANGEROUS TARGETS				
[008]	NAME	MMSI	CPA	TCPA
1.	AMEC 001	307000123	1.36	1.31
2.	AMEC 006	307012456	0.85	1.17
3.	AMEC 014	307000045	1.17	1.21

Figure 4-2-2 Dangerous Targets

Step 1: Use the <UP> and <DOWN> keys to select a dangerous target ship.

Step 2: Press the <ENT> key on the selected target to view its detailed information.

**Refer to section 5.7 for details.

(D) OWN SHIP INFORMATION:

Own ship information includes own ship's basic, static and dynamic information.

SHIP DETAIL <1/2>			
NAME	AMEC AIS B(CS)		
CALL	N/A [CLASS B]	PA	Lo
MMSI	000000000	EPFD	Undefined
Nav.	Under way using engine.		
LON	83°05'123"W	RNG	29.17nm
LAT	28°39'60"N	BRG	71°
SOG	15.00Kn	CPA	23.26nm
COG	96.4	TCPA	1.21min
ROT	0.00	HDT	68°

Figure 4-2-3 Own ship details

SHIP			
NAME	AMEC AIS B (CS)		
CALL	N/A [CLASS B]	DRAFT	1.5m
MMSI	000000000	IMO	000000000
CARGO	DG, HS OR MP <POLUTANT A>		
TYPE	HSC		
DEST	SHANGHAI		
ETA	12/31 23:59	DTE	N/A
BEAM	3m	A: 6m	B: 4m
LENGTH	10m	C: 2m	D: 1m

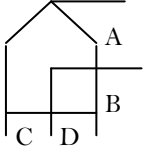

Figure 4-2-4 Own ship details

***NOTE:** Use the <ENT> key or the <LEFT> or <RIGHT> key to switch between static and dynamic information pages.

**Refer to section 5.2.1 for details.

(E) REGION SETTING:

Display all the received applicable region settings stored in the system. The region settings are broadcasting from the VTS assigning a certain channel setting in a region.

REGION SETTING LIST		
RegionNo	Source	Date/Hour
Region 1	AIS/Bro	07/05/26 14
Region 2	AIS/Adr	07/04/25 08
Region 3	AIS/Bro	07/03/13 12
Region 4	AIS/Bro	07/02/12 11
Region 5	AIS/Adr	07/02/11 23
Region 6	DSC/Adr	07/02/10 21
Region 7	DSC/Bro	07/02/09 19
Region 8	AIS/Adr	07/02/08 07
Region 9	DEFAULT	N / A

Region In Use	[Region 9]
T. Zone Status	[NO]

Figure 4-2-5 Region setting

Step 1: Use the <UP> and <DOWN> keys to select a region setting.

Step 2: Press the <ENT> key on the selected region setting to display its details.

**Refer to section 5.2.3 for details.

4.3 DIM (Dimmer for Display Brightness Control)

Press the <DIM> key to adjust the brightness of the screen. (Stepless brightness adjustment)

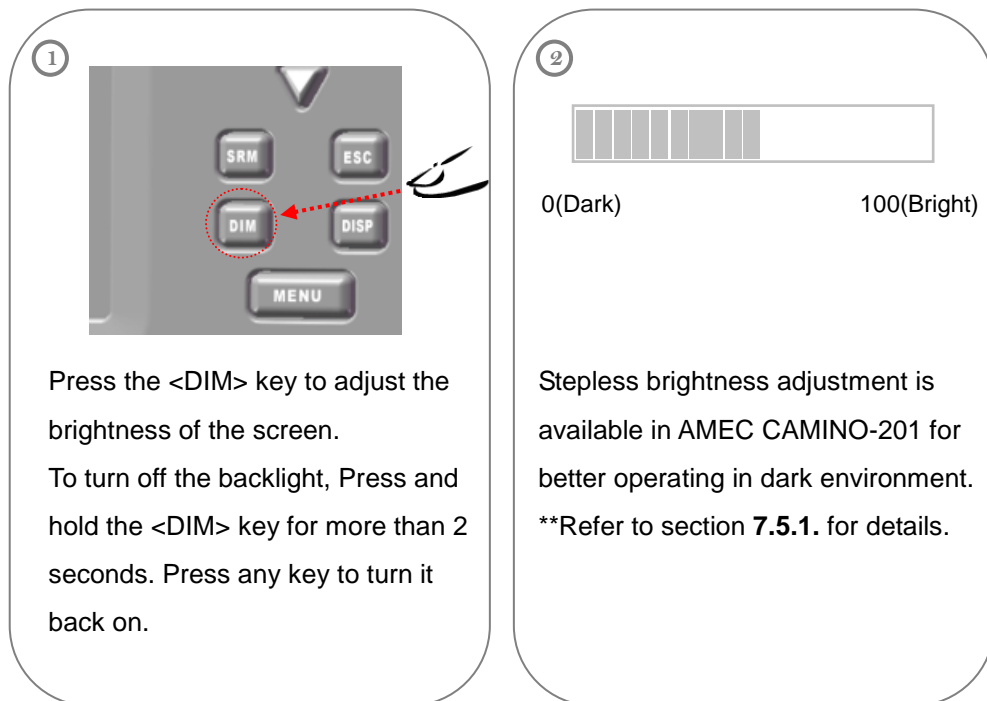

Figure 4-3 Dimmer control

4.4 Arrow Keys

<UP>, <DOWN>, <LEFT>, and <RIGHT> arrow keys can be used to select items in the menus and can also be used to input alphabets, numbers, simple signs, etc..

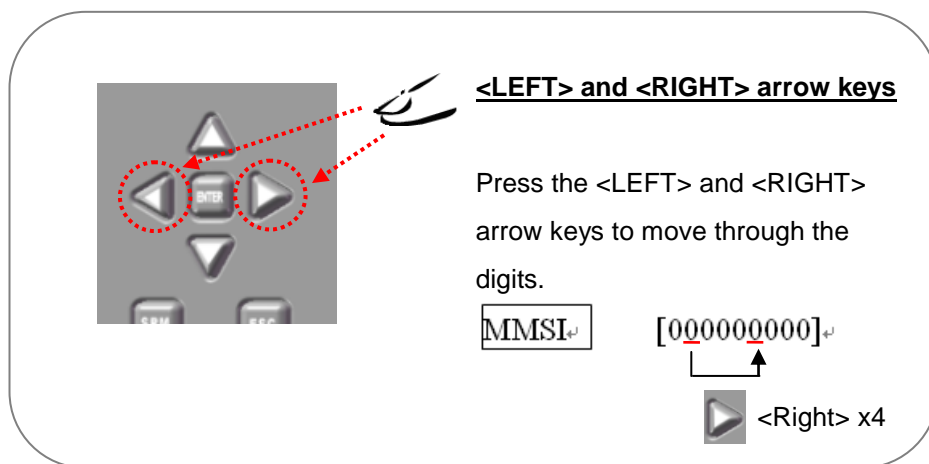

Figure 4-4-1 Arrow keys

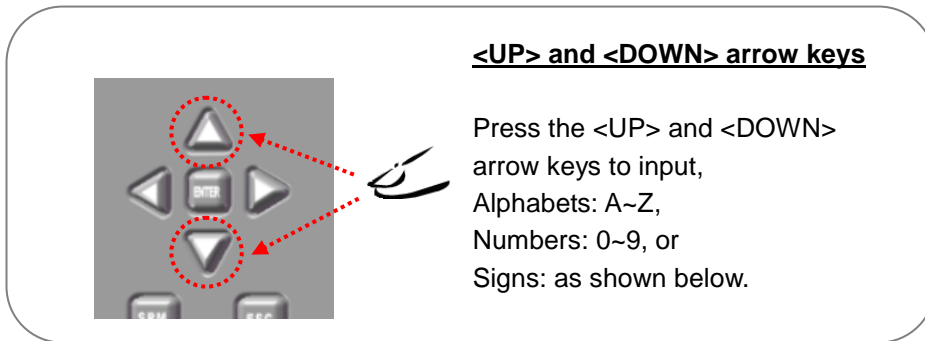

Figure 4-4-2 Arrow keys

Table 4-4 Arrow key appearing sequence

	A	B	C	D	E	F	G	H	I
J	K	L	M	N	O	P	Q	R	S
T	U	V	W	X	Y	Z	0	1	2
3	4	5	6	7	8	9	!	“	#
\$	%	&	‘	<	>	*	+	,	-
.	/	:	;	<	=	>	?	@	space

4.5 Menu Key

On the main display / radar view, press the <MENU> key to enter to main menu. Totally 6 main functions are available in the main menu.

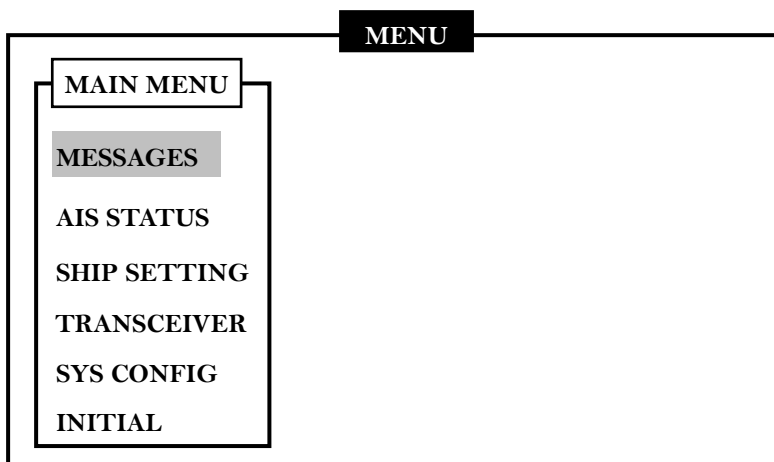

■ **MESSAGES:**

History of received and transmitted SRM is stored in the “MESSAGES” function. Up to 20 latest SRM can be stored in the “MESSAGES” function. Use the <SRM> key to access the “MESSAGES” function, or access the “MESSAGES” function from the main menu by selecting “MESSAGES” and then select type of SRM to transmit.

(Refer to section 5.1 for details)

■ **AIS STATUS:**

Display all types of voyage information from ships in the surroundings that are equipped with Class A, Class B, or other AIS systems. The voyage information includes dynamic and static information. (Refer to section 5.2 for details)

■ **SHIP SETTING:**

The following information can be set and entered in the “SHIP SETTING”,

Ship’s information:

Ship name, ship size, type of ship, and etc.

Friend ship information:

The ship that is added as a friend ship with its MMIS and ship name will be shown in the “BUDDY LIST.” (Refer to section 5.3.3 for details)

■ **TRANSCIVER:**

Turn ON or OFF the transceiver function. When the transceiver is turned OFF, the AIS system only has receiving function and operates as an AIS receiver. When the transceiver is turned ON, the AIS will have full Class B AIS function.

(Refer to section 5.4 for details)

■ **SYS CONFIG:**

System configuration includes customized set up, radar view set up, factory default setup, and desired baud rate set up. (Refer to section 5.5 for details)

■ **INITIAL:**

Initial function includes setup up for password, MMSI and CPA / TCPA.

(Refer to section 5.6 for details)

***NOTE 1:** When no operation is applied on the system for over a minute, the system will automatically return to the main display.

***NOTE 2:** A password is required to enter in order to access and change the information of the following functions.

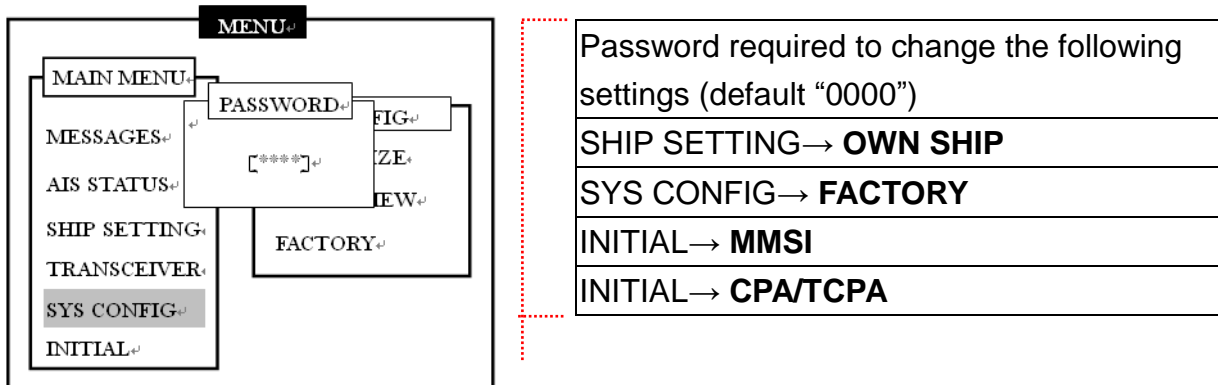

4.6 Menu Tree Structure

Table 4-6 Menu tree

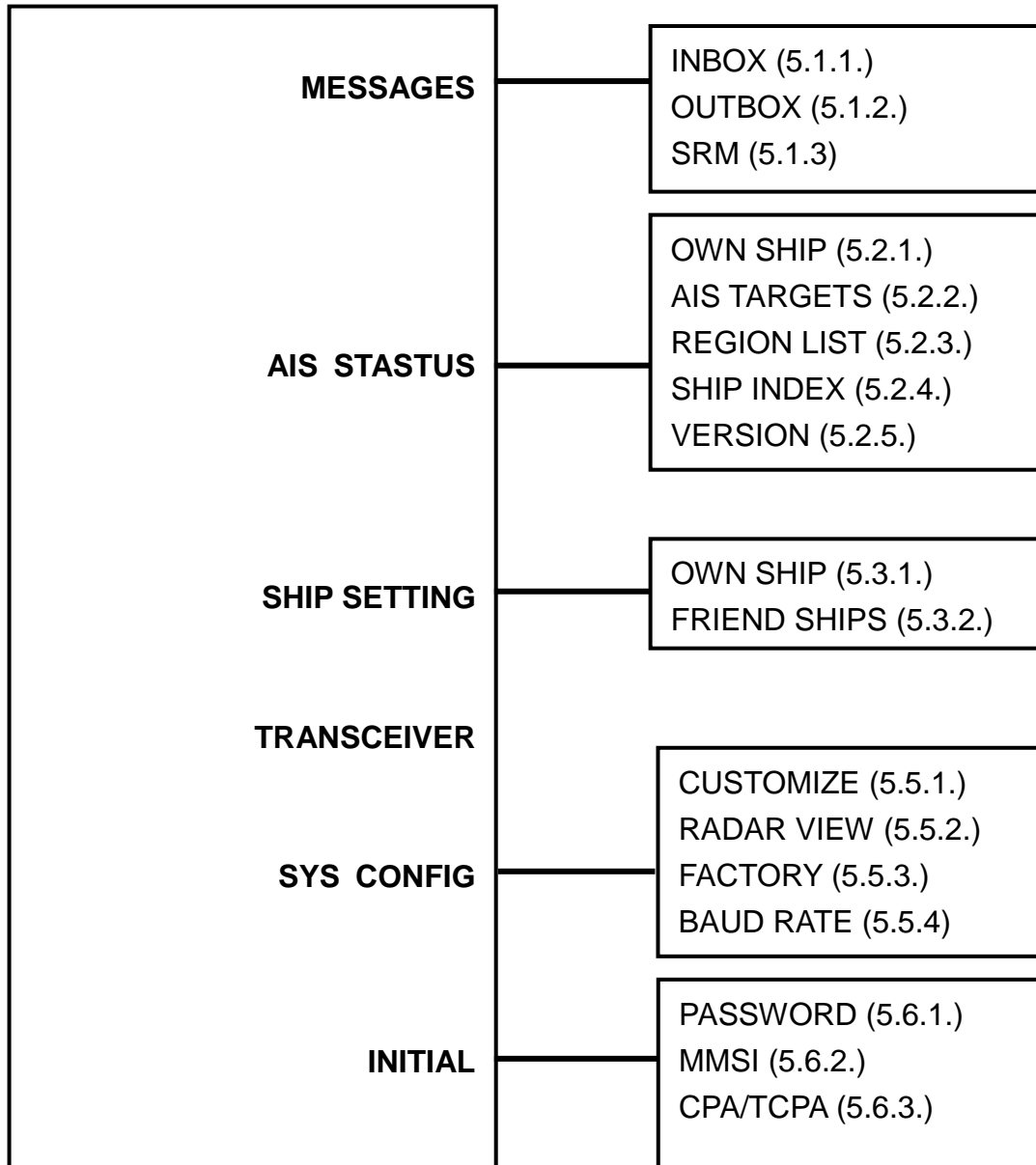

5 MENU KEY NAVIGATION

5.1 AIS Message List

Step 1: On the main display / radar view press the <MENU> key to open the main menu.

Step 2: Select the “MESSAGES” function.

Step 3: Press the <ENT> key on the “MESSAGES” function and 3 sub-menus will appear.

Step 4: Use the <UP> and <DOWN> keys to select “INBOX”, “OUTBOX”, and “SRM”.

5.1.1 Inbox (Received SRM)

Step 1: Select the “INBOX” function.

Step 2: Press the <ENT> key to access into the “INBOX” SRM list.

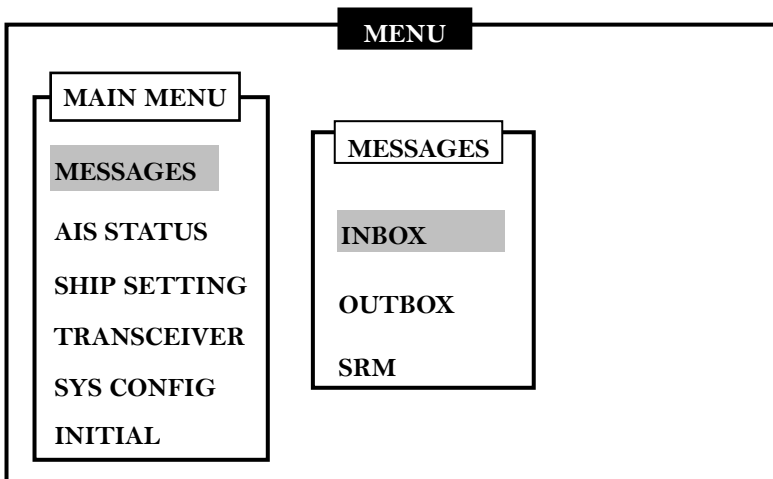

Step 3: Use the <UP> and <DOWN> keys to select the SRM.

Step 4: Press the <ENT> key to open the selected SRM.

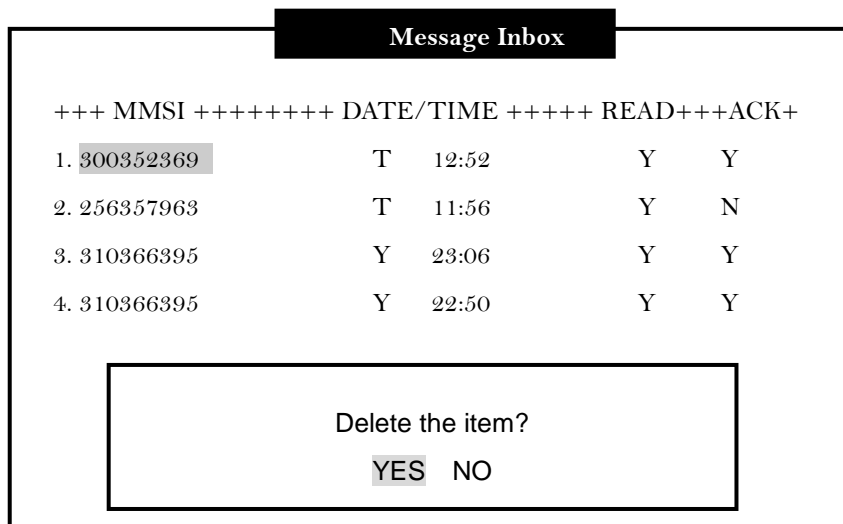

Step 5: To delete the message, press <MENU> key, and an option window will appear to confirm the selection.

Step 6: Select “YES” to delete the SRM.

Step 7: Select “NO” to cancel and return to the Inbox SRM list.

MMSI:	Maritime Mobile Service Identification
DATE/TIME:	Date and Time Received
READ:	Read Status
ACK:	Status of Acknowledgement

5.1.2 Outbox (Transmitted SRM)

Step 1: Select the “OUTBOX” function.

Step 2: Press the <ENT> key to open the “OUTBOX” SRM list.

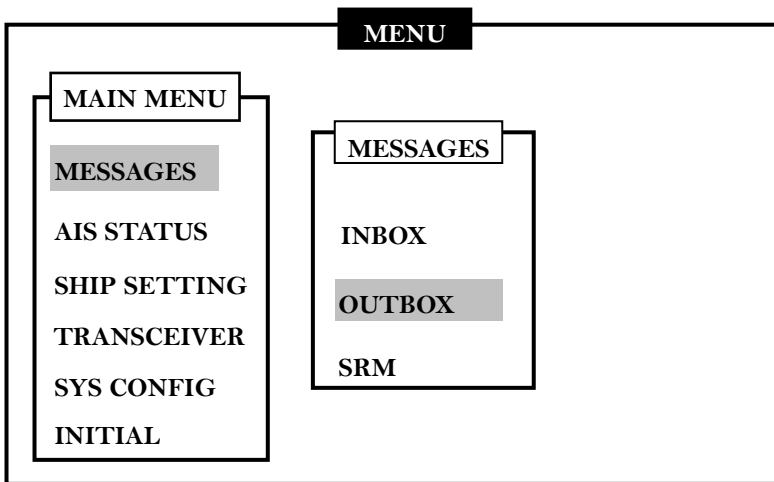

Step 3: Use the <UP> and <DOWN> keys to select the SRM.

Step 4: Press the <ENT> key to open the selected SRM.

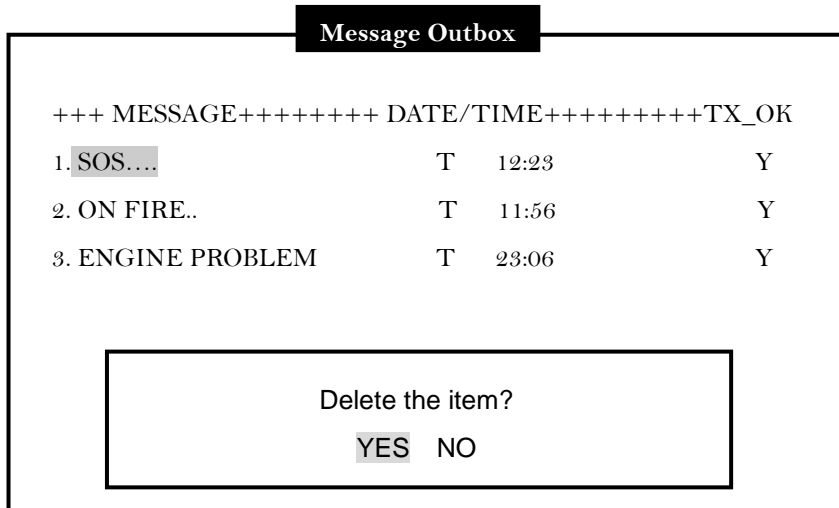

Step 5: press <MENU> key to delete the message. An option window will appear to confirm the selection.

Step 6: Select "YES" to delete the SRM.

Step 7: Select "CANCEL" to cancel and return to the outbox SRM list.

MESSAGE : Sent Message Content.
DATE/TIME : Date and Time Sent.
TX_OK : Status of Transmitting.

5.1.3 SRM Editing

Step 1: Select the "SRM" function.

Step 2: Press the <ENT> key to open the Set SRM Alarm.

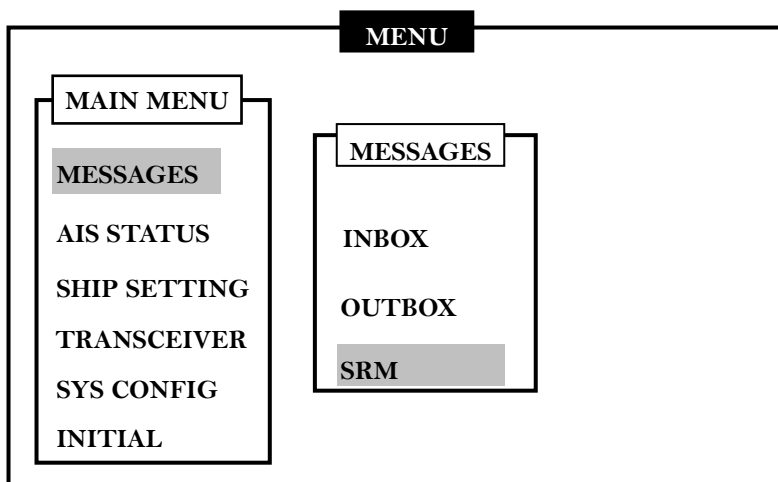

Step 3: Use the <UP> and <DOWN> keys to select the SRM.

(Refer to table 7-1 for System preset Safety Related Message.)

Step 4: Press the <ENT> key to send the selected SRM.

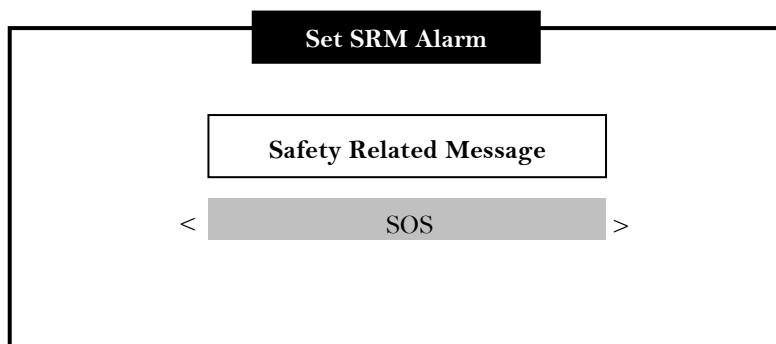

Step 5: A confirming window will appear to confirm the sending of the SRM.

Step 6: Select "CANCEL" to abort the transmitting or select "OK" to confirm and send the SRM.

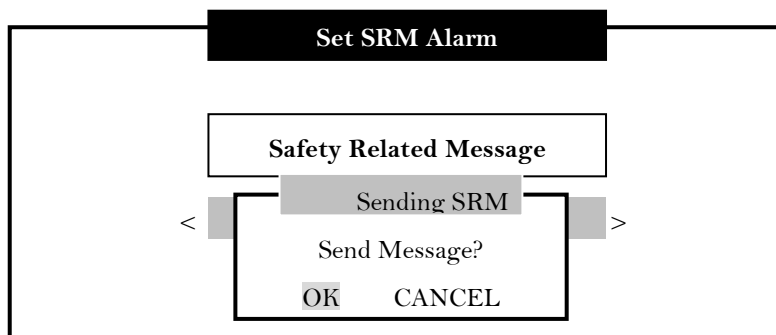

Step 7: The system will remind you that you can only send a SRM one time in one minute. Wait for one minute before sending out another SRM.

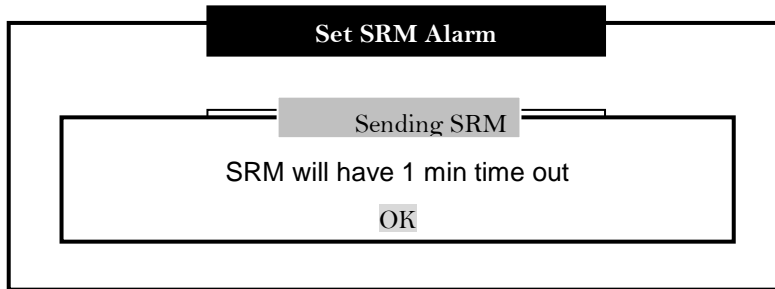

Table 5-1-3 SRM

System Preset Safety Related Message	
SOS	ON FIRE
EXPLOSION	FLOODING
COLLISION	GROUNDING
LISTING	CAPSIZING
SINKING	ADRIFTING
ROBBERY ATTACK	ENGINE TROUBLE
FUEL SHORTAGE	

5.2 AIS Target Status

Step 1: On the main display / radar view, press the <MENU> key to open the main menu.

Step 2: Select the “AIS STATUS” function.

Step 3: Press the <ENT> key on the “AIS STATUS” function and 5 sub-menus will appear.

Step 4: Use the <UP> and <DOWN> keys to select “OWN SHIP”, “AIS TARGETS”, “REGION LIST”, “SHIP INDEX” and “VERSION”.

5.2.1 Own Ship Information Settings

Step 1: Select the “OWN SHIP” function.

Step 2: Press the <ENT> key to display own ship’s dynamic and static information.

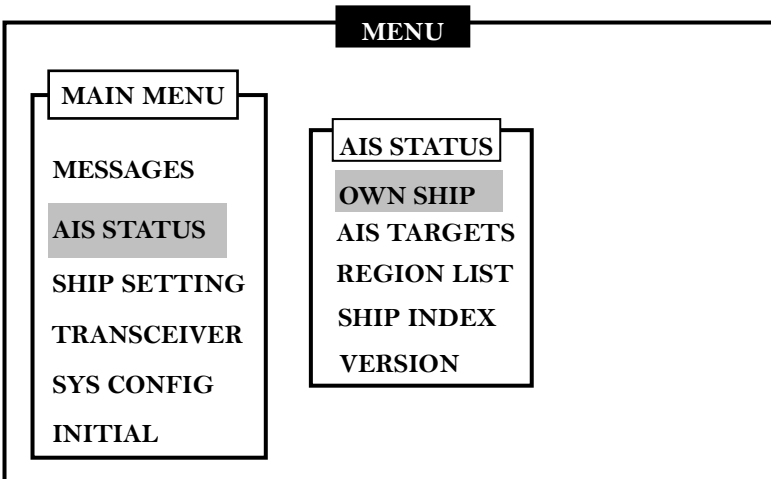

Step 3: Use the <RIGHT> key to view own ship’s static information.

Step 4: Use the <LEFT> key to view own ship’s dynamic information.

Step 5: The <ENT> key can also be used to switch between own ship’s dynamic and static information.

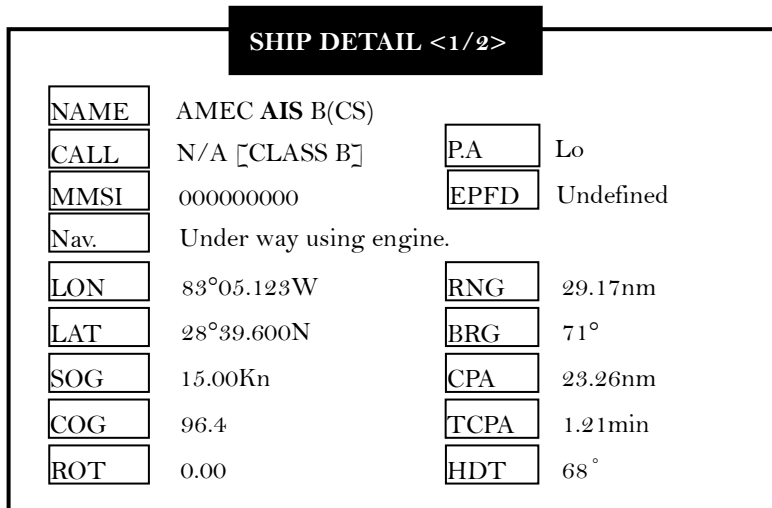

SHIP DETAIL <2/2>

NAME	AMEC AIS B (CS)		
CALL	N/A [CLASS B]	DRAFT	1.5m
MMSI	000000000	IMO	000000000
CARGO	DG, HS OR MP <POLUTANT A>		
TYPE	HSC		
DEST	SHANGHAI		
ETA	12/31 23:59	DTE	N/A
BEAM	3m	A: 6m	B: 4m
LENGTH	10m	C: 2m	D: 1m

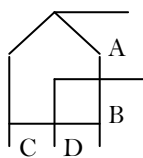

Step 6: Press the <ESC> key to return to the main menu.

Table 5-2-1 Ship details

NAME: Ship's name	CALL: Ship's Call Sign
MMSI: Maritime Mobile Service Identity	Nav.: Navigational Status
P.A.: Position Accuracy	LAT: Latitude
LON: Longitude	SOG: Speed Over Ground
TCPA: Time to Closest Point of Approach	ROT: Rate of Turn
RNG: Range between own ship and target ships.	HDT: Heading
BRG: Bearing between own ship and target ships	COG: Course Over Ground
CPA: Closest Point of Approach	DEST: Destination
ETA: Estimate Time of Arrival	CARGO: Cargo Type
EPFD: Electronic Position Fixing Device	TYPE: Ship Type
BEAM: Ship Width	LENGTH: Ship Length
DTE: Data Terminal	Draft: Ship Draft

5.2.2 AIS Target List and Friend Ships

Step 1: Select “AIS TARGETS” function.

Step 2: Press the <ENT> key to display list of received targets in the surroundings including target ships’ dynamic and static information.

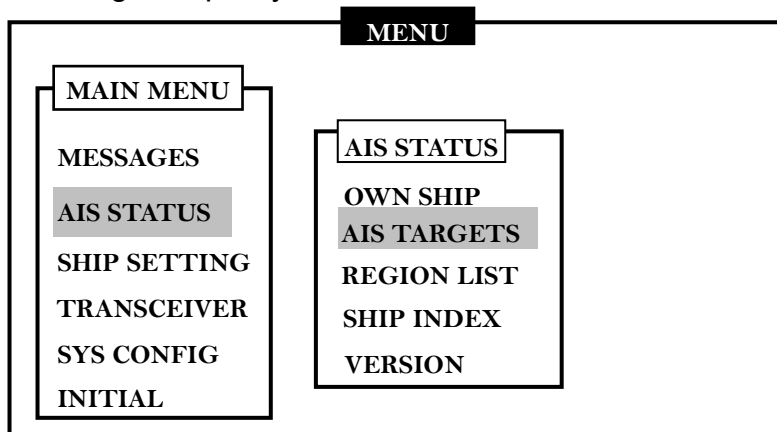

Step 3: A total number of received targets is displayed on the top left corner.

Use the <UP> and <DOWN> keys to select the target.

Step 4: Use the <LEFT> and <RIGHT> keys to scroll to the next and previous page in the target list.

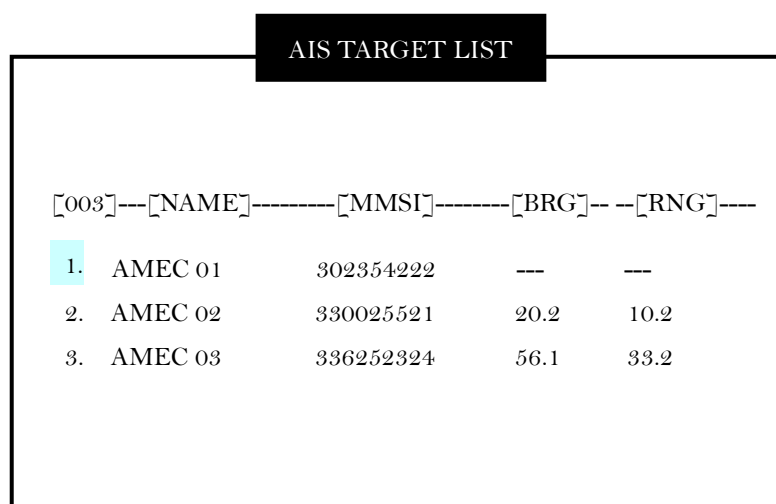

The screenshot shows the 'AIS TARGET LIST' screen. At the top is a black box labeled 'AIS TARGET LIST'. Below it is a table with the following columns: [003], [NAME], [MMSI], [BRG], and [RNG]. The table contains three rows of data:

	[003]	[NAME]	[MMSI]	[BRG]	[RNG]
1.	AMEC 01	302354222	---	---	
2.	AMEC 02	330025521	20.2	10.2	
3.	AMEC 03	336252324	56.1	33.2	

Step 5: Press the <ENT> key to open the selected target.

Step 6: Use the <RIGHT> and <LEFT> keys to view target ship’s dynamic or static information. Use the <UP> and <DOWN> keys to switch to another target ship’s dynamic and static information. (Refer to section 5.2 for details)

Step 7: Press <MENU> to assign the selected target as a “Friend Ship.”

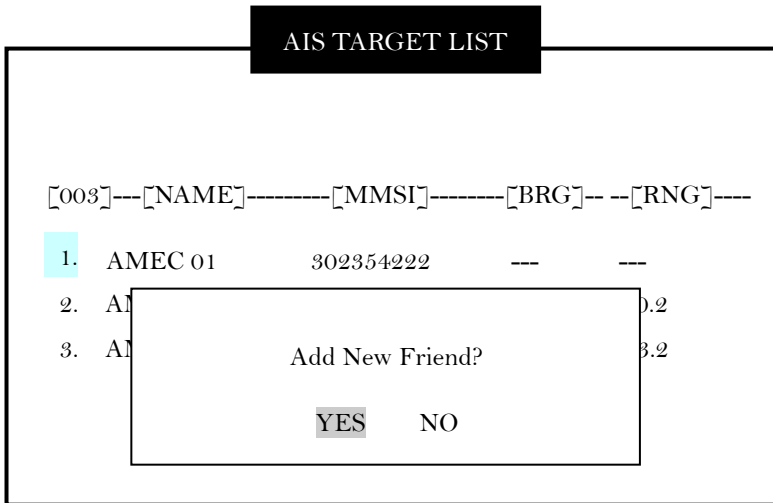

Step 8: Press the <ESC> key to return to the main menu.

5.2.3 Region List and Setting

Step 1: Select the “REGION LIST” function.

Step 2: Press the <ENT> key to display the entire region setting information.

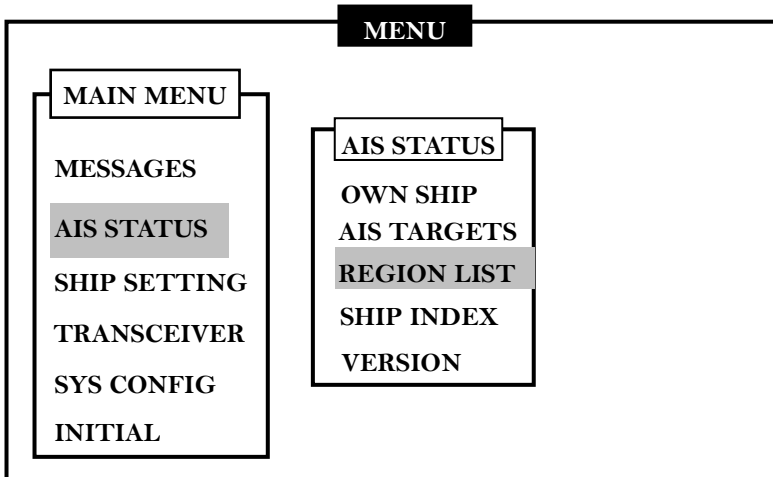

Step 3: Use the <UP> and <DOWN> key to select the region setting.

REGION SETTING LIST			
RegionNo	Source	Date/Hour	
Region 1	AIS/Bro	07/05/26	14
Region 2	AIS/Adr		
07/04/25 08	Region 3		AIS/Bro
07/03/13 12			
Region 4	AIS/Bro	07/02/12	11
Region 5	AIS/Adr	07/02/11	23
Region 6	DSC/Adr	07/02/10	21
Region 7	DSC/Bro	07/02/09	19
Region 8	AIS/Adr	07/02/08	07
Region 9	DEFAULT		N / A
<input type="text" value="Region In Use"/>	[Region 9]		
<input type="text" value="T. Zone Status"/>	[NO]		

**e.g. Region 1:

Message was received at Region 1. Received Date is 2007 / 05 / 26

Message was received from an AIS receiver hence the information source is AIS.

Message status is Broadcasting mode.

Information Source Description:

- **DSC:** Region setting from the DSC
- **AIS:** Region setting from the AIS
- **Bro:** Broadcasting mode
- **Adr:** Address

Step 4: Press the <ENT> key to open the region setting detail.

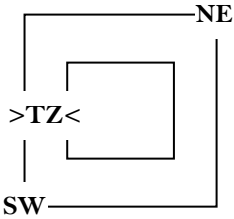
REGION [1] SETTING			
LAT (NE)	0°00'000"S		
LON (NE)	0°00'000"W		
LAT (SW)	0°00'000"S		
LON (SW)	0°00'000"W		
T. Zone (nm)	N/A	Power	Low
Channel A	2087	Band Width	25K HZ
Channel B	2088	Band Width	25K HZ
TX/RX Mode	TxA/TxB		
Addr/Broad	Broadcast		

LAT (NE): Latitude North East
LAT (SW): Latitude South West
T. Zone (nm): Transition Zone
Channel A: Channel A
Channel B: Channel B
Power: Transmit power

LON (NE): Longitude North East
LON (SW): Longitude South West
Band Width: Band width A
Band Width: Band width B
TX/RX mode: Transmit / Receive mode.
Addr/Broad: Address/Broadcast mode.

Step 5: Press the <ESC> key to return to the region setting list.

5.2.4 Ship Index and Individual Vessel Information

Step 1: Select the “SHIP INDEX” function.

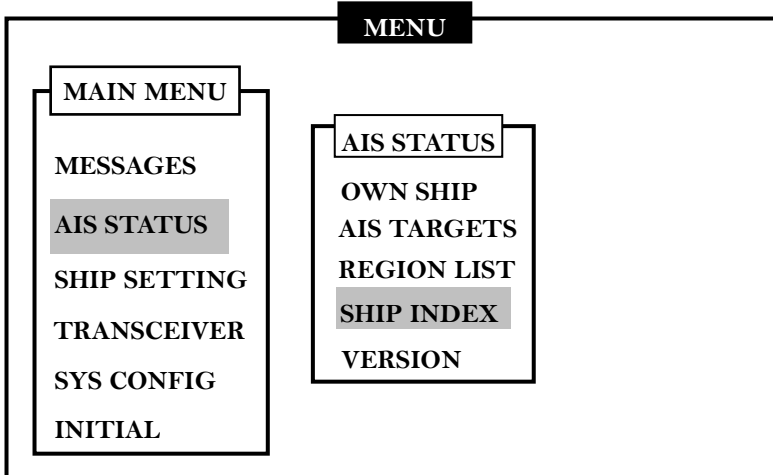

Step 2: Press the <ENT> key to display all received ship names.

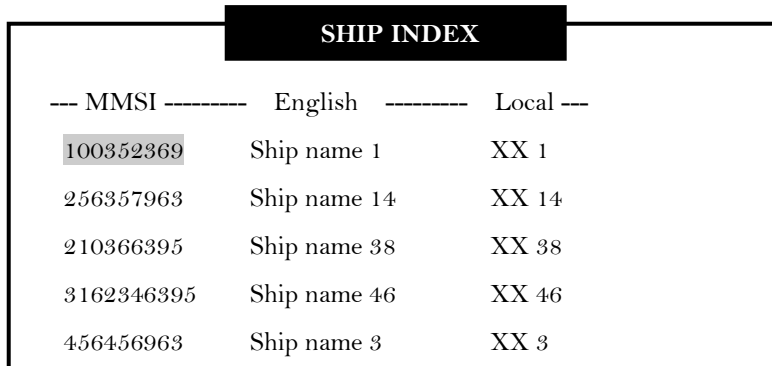

The screenshot shows a screen titled "SHIP INDEX" with a table of ship information. The table has three columns: MMSI, English, and Local. The first row is highlighted.

MMSI	English	Local
100352369	Ship name 1	XX 1
256357963	Ship name 14	XX 14
210366395	Ship name 38	XX 38
3162346395	Ship name 46	XX 46
456456963	Ship name 3	XX 3

Step 3: Use the <UP> and <DOWN> key to select the ship name.

Step 4: Press the <ENT> key to open the ship data display.

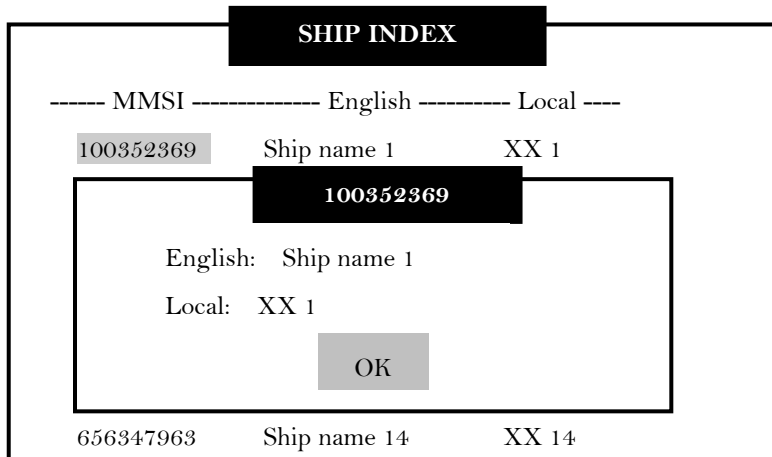

The screenshot shows the "SHIP INDEX" screen with the first row selected. A detailed view of the selected ship's data is shown in a separate window. The detailed view shows the MMSI "100352369" and the ship name "Ship name 1" in both English and Local (XX 1) languages. An "OK" button is visible at the bottom of the detailed view.

MMSI	English	Local
100352369	Ship name 1	XX 1
656347963	Ship name 14	XX 14

5.2.5 Product Version and Information

Step 1: Select the 'VERSION' function.

Step 2: Press the <ENT> key to display system's software version and related information.

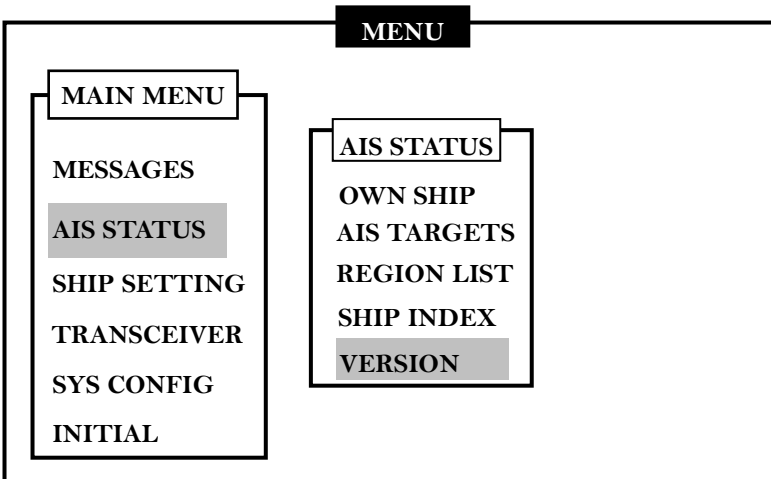

Step3: In the version page, information such as "PRODUCT", "FIRMWARE", "COMPANY", "WEBSITE" and "S/N" are displayed.

Step4: Press the <ESC> key to escape from this menu.

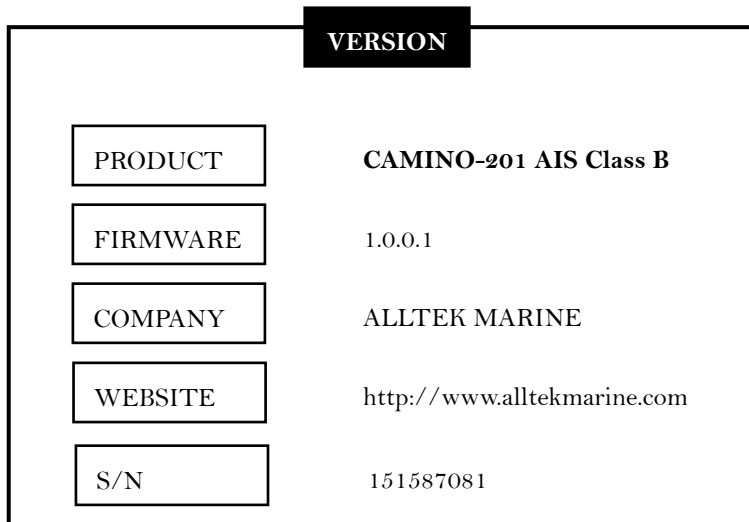

5.3 Ship Configuration and Setting

Step 1: On the main display / radar view press the <MENU> key to open the main menu.

Step 2: Select the “SHIP SETTING” function.

Step 3: Press the <ENT> key on the “SHIP SETTING” function and 3 sub-menus will appear.

Step 4: Use the <UP> and <DOWN> keys to select “OWN SHIP” and “FRIEND SHIPS”.

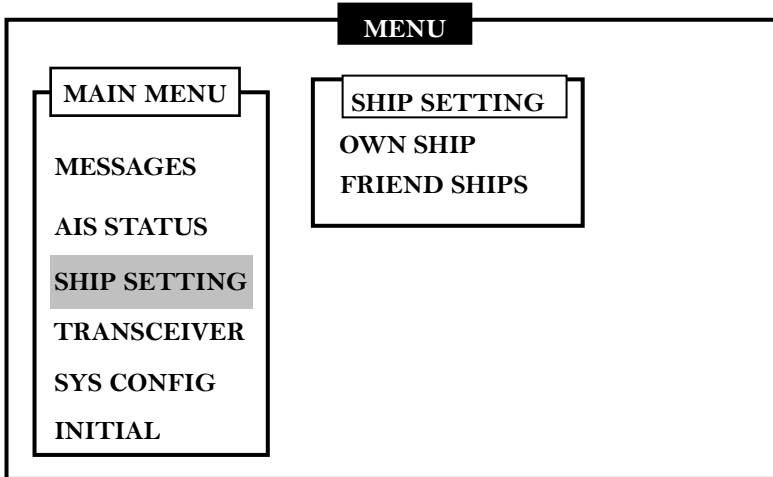

5.3.1 Own Ship Static Data (User Password Protected)

Step 1: Select the “OWN SHIP” function.

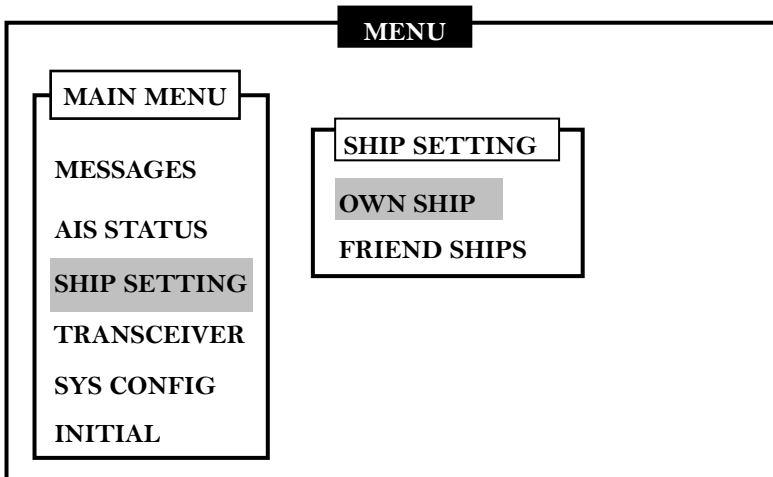

Step 2: Enter the password in the pop out window.

Step 3: The following data can be set in the “OWN SHIP” function: Own ship name, call sign, type of ship, location of the GPS antenna.

- Call sign: input only 7 digitals.
- Ship name: input only 20 digitals.

SHIP SETTING

Call Sign	[AMEC005]
Ship Name	[AMEC005 AIS B]
Ship Type	<HSC>

Antenna Position <m>

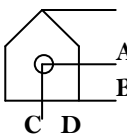

A: [000] B: [000] C: [00] D: [00]

Save Data?

YES NO

Step 4: When the set up is completed, press <ESC> or <ENT> key and a pop out window will appear to confirm and to save the set up.

Step 5: Select “YES” to save the set up, or “NO” to escape from this menu.

5.3.2 Friend Ship Editing

Step 1: Select the “FRIEND SHIPS” function.

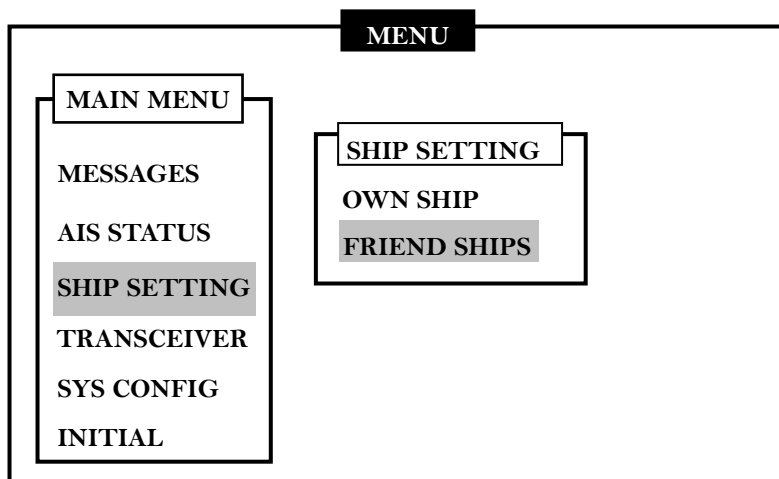

Step 2: Press the <ENT> key to display the pre-set buddy ship list.

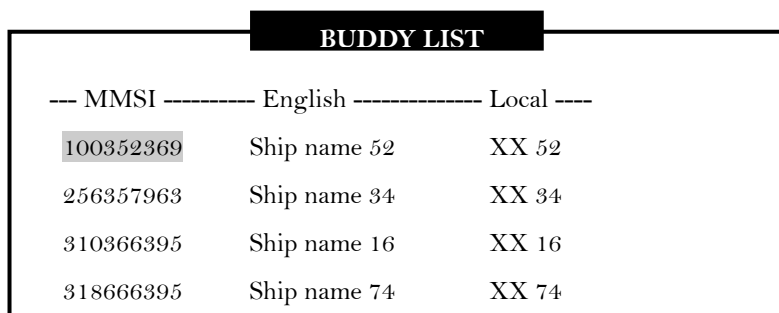

Step 3: Use the <UP> and <DOWN> key to select the friend ship.

Step 4: To delete a friend ship data, select the ship and press <MENU>, a pop out window will appear. Select “YES” to delete the set up, or “NO” to return to the BUDDY LIST.

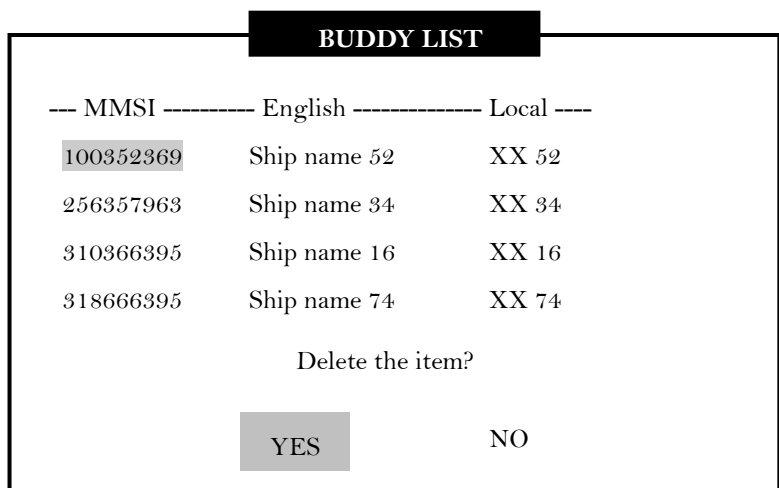

Step 5: Press the <ENT> key to open the friend ship data.

BUDDY LIST

----- MMSI ----- English ----- Local -----

100352369 Ship name 52 XX 52

100352369

English: Ship name 1

Local: XX 1

OK

5.4 Transceiver ON / OFF Settings

Step 1: On the main display / radar view, press the <MENU> key to open the main menu.

Step 2: Select the “TRANSCEIVER” function.

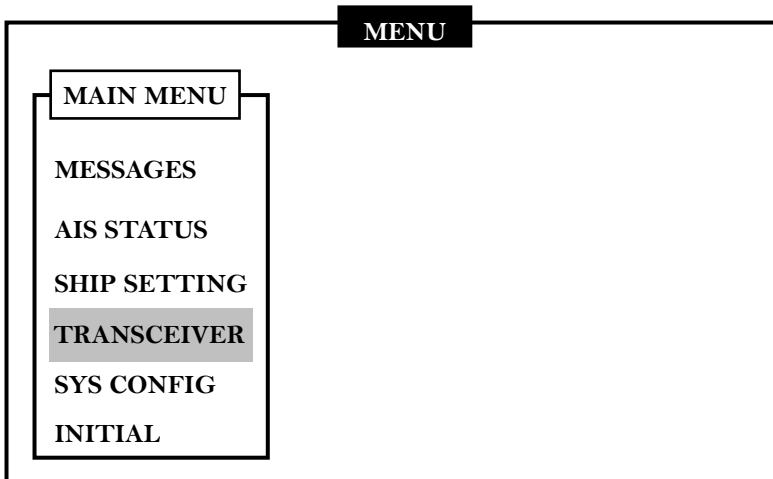

Step 3: Use the <LEFT>, <RIGHT>, <UP> or <DOWN> keys to turn ON or OFF the transceiver. Press <ENT> to proceed to the next setting.

Step 4: Use the <LEFT>, <RIGHT>, <UP> or <DOWN> keys to turn ON or OFF the DSC receiver. Press <ENT> to proceed to the next setting.

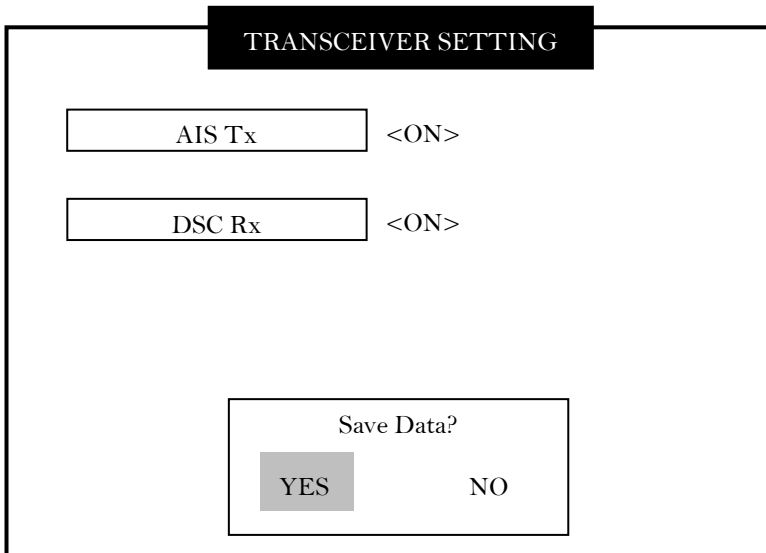

Step 5: When the set up is completed, press the <ESC> or <ENT> key and a pop out window will appear to confirm and save the settings.

Step 6: Select “YES” to confirm and save the settings, or “NO” to escape from the menu.

5.5 System Configuration

Step 1: On the main display / radar view, press the <MENU> key to open the main menu.

Step 2: Select the “SYS CONFIG” function.

Step 3: Press the <ENT> key on the “SYS CONFIG” function and 3 sub-menus will appear.

Step 4: Use the <UP> and <DOWN> keys to select “CUSTOMIZE”, “RADAR VIEW”, “FACTORY”, and “BAUD RATE.”

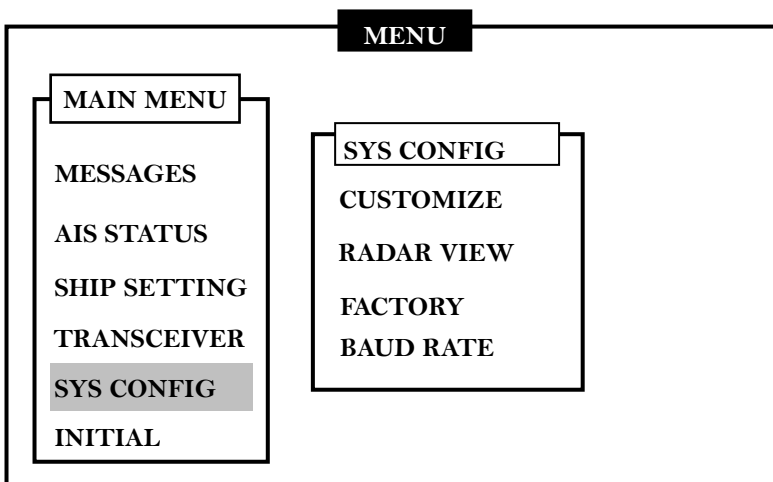

5.5.1 Customizing System

Step 1: Select the “CUSTOMIZE” function.

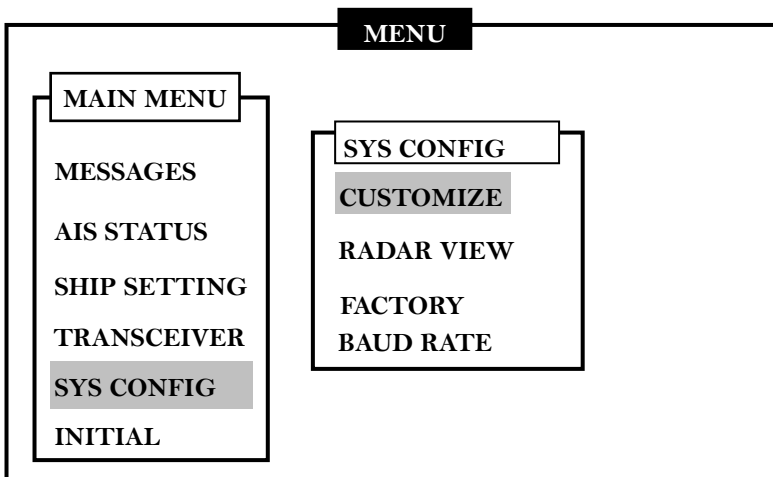

Step 2: Use the <LEFT>, <RIGHT>, <UP> or <DOWN> keys to adjust the “DIMMER LEVEL”, “KEY TIME-OUT” (1~5min), “LANGUAGE”, and “ALARM”.

Step 3: Press the <ENT> key after each setting, and to proceed to the next setting.

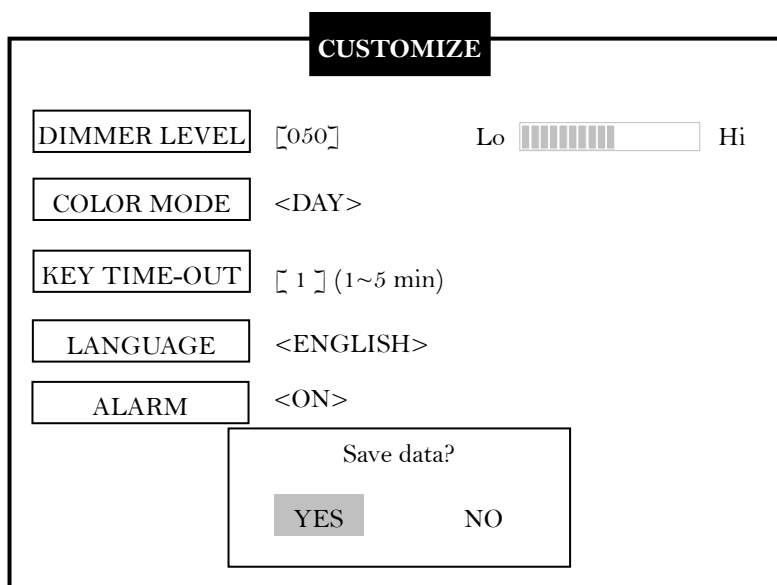

Step 4: When the set up is completed, press the <ESC> or <ENT> key and a pop out window will appear to confirm and save the settings.

Step 5: Select “YES” to confirm and save the settings, or “NO” to escape from the menu.

***NOTE 1:** Refer to section 6.4 for details on arrow keys instruction.

***NOTE 2:** You can choose Color Mode available in both Day and Night.

***NOTE 3:** Language will vary in according to different regions. Display language is available in English, Simplified Chinese and Traditional Chinese.

5.5.2 Radar View Reference Point Setting

When there is no GPS reception, manually set own ship's longitude and latitude in the "RADAR VIEW" function, the own ship's reference center position will appear in the radar plotter.

Step 1: Select the "RADAR VIEW" function.

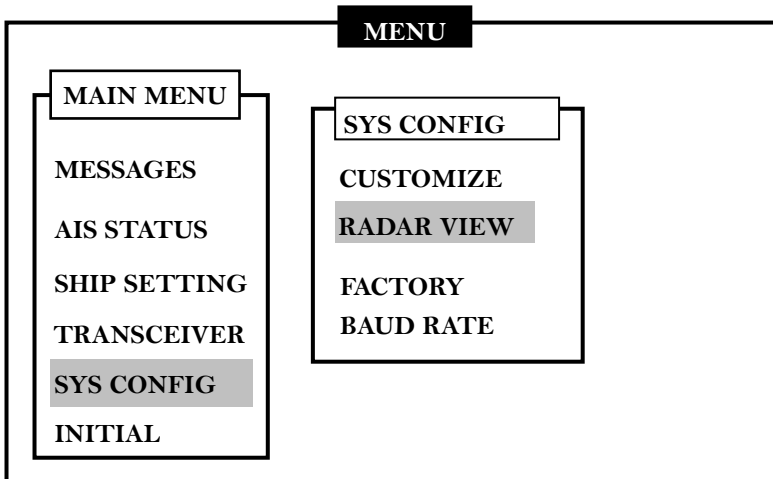

Step 2: Press the <ENT> key to display the radar view setting.

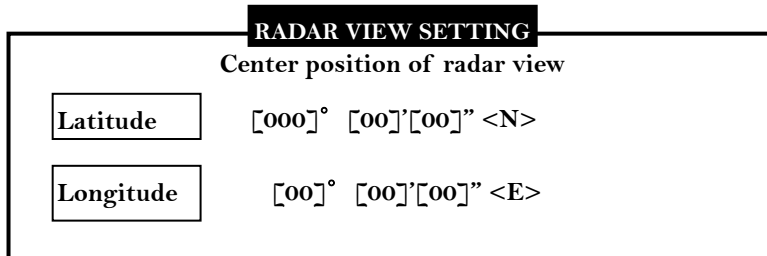

Step 3: Use the <UP> and <DOWN> keys to enter the "Longitude" and "Latitude" value. Use the <LEFT> and <RIGHT> keys to move the digit spot of "Longitude" and "Latitude".

Step 4: Press <ESC> or <ENT> key, and a pop out window will appear to confirm and save the settings.

Step 5: Select "YES" to confirm and save the settings, or "NO" to escape from the menu.

***NOTE 1:** Refer to section 5.4 for details on arrow keys instruction. .

5.5.3 Factory Default Configuration (User Password Protected)

Step 1: Select the “FACTORY” function.

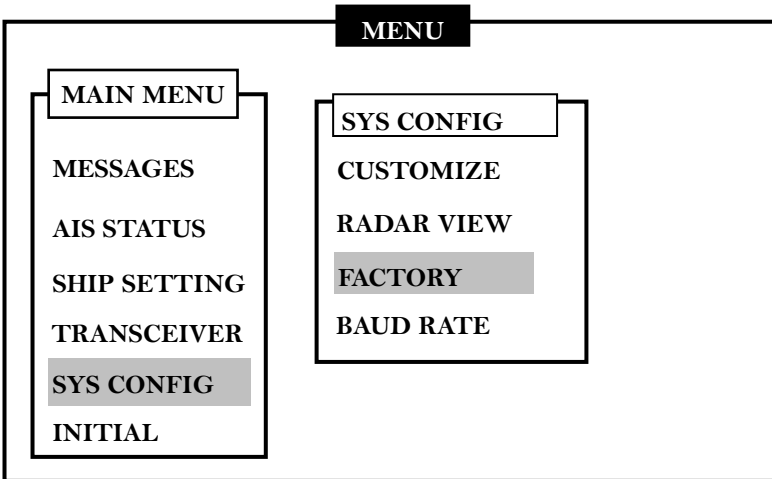

Step 2: A password is required. Enter the password in the pop out window.

Step 3: Select “OK” to confirm and to restore the factory setting. Restored factory settings include “CUSTOMIZE” and “CPA/TCPA” functions.

Step 4: Select “CANCEL” to escape from this menu.

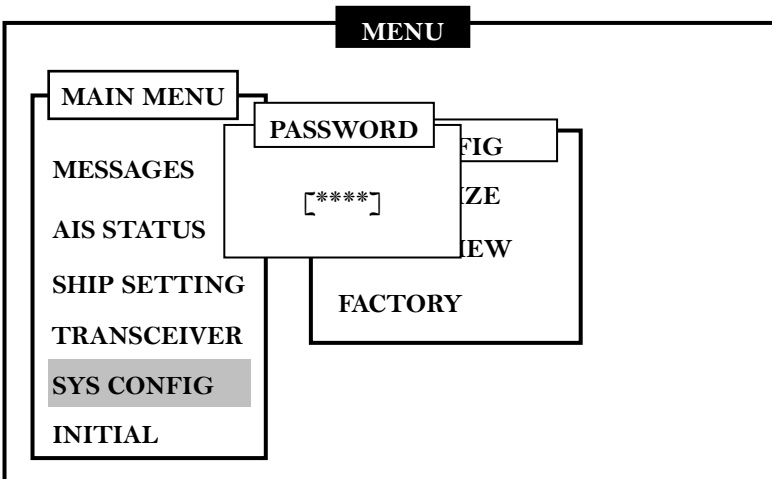

5.5.4 Output Port Baud Rate Settings

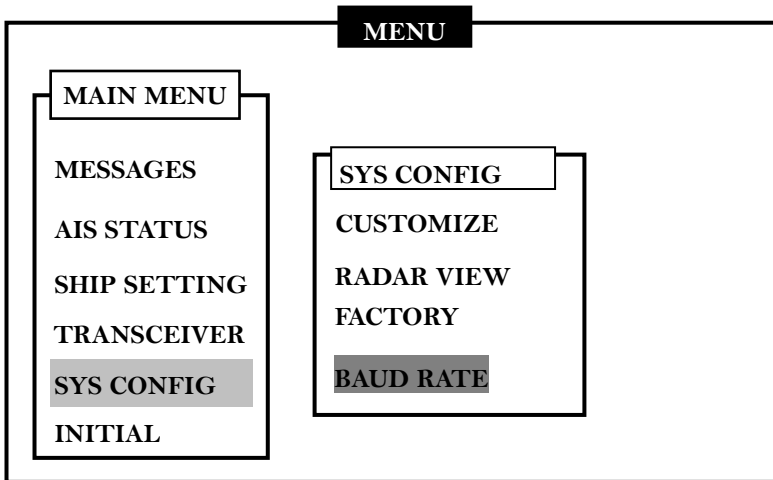

Step 1: Select BAUD RATE

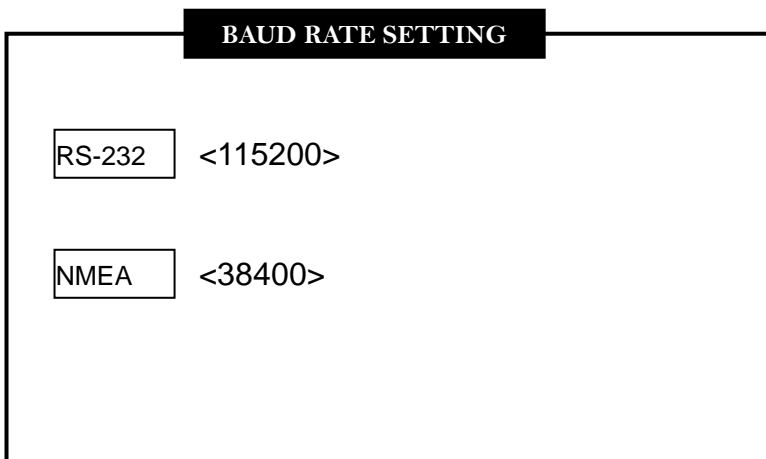

Step 2: Use <Left>, <Right>, and <ENT> to select your desired Baud Rate, the standard baud rate for RS-232 is 115200 and 38400 for NEMA. The Baud Rate may vary when you connect to other maritime electronics. Refer to the manuals of the devices.

Step 3: Press "Yes" to save the settings.

5.6 System Initialization

Step 1: On the main display / radar view, press the <MENU> key to open the main menu.

Step 2: Select the “INITIAL” function.

Step 3: Press the <ENT> key on the “INITIAL” function and 3 sub-menus will appear.

Step 4: Use the <UP> and <DOWN> keys to select “PASSWORD”, “MMSI”, and “CPA/TCPA”.

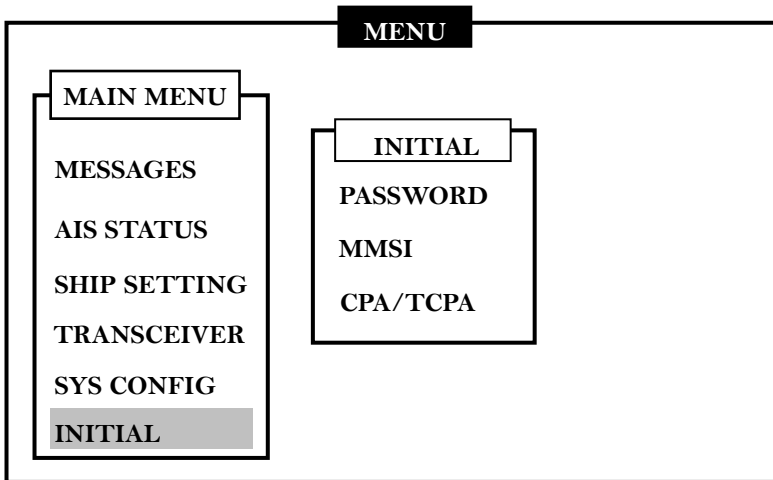

5.6.1 Password Setting

Step 1: Select the “PASSWORD” function.

Step 2: Press the <ENT> to display the password setting.

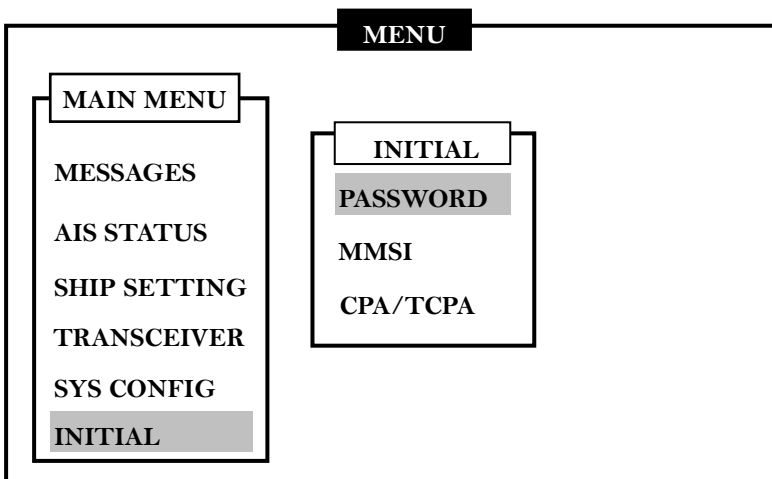

Step 3: On the password setting page, enter the “OLD Password”, “NEW Password”, and “Confirm Password”.

PASSWORD SETTING

OLD Passowrd	[*****]
NEW Password	[*****]
Confirm Password	[*****]

New password saved!

OK

Step 4: When the set up is completed, press the <ENT> key and a pop out window will appear to confirm and save the setting.

Step 5: Select “OK” to save the setting, or press <ESC> key to escape from the menu.

5.6.2 MMSI Editing

Step 1: Select the “MMSI” function.

MENU

MAIN MENU

MESSAGES

AIS STATUS

SHIP SETTING

TRANSCEIVER

SYS CONFIG

INITIAL

INITIAL

PASSWORD

MMSI

CPA/TCPA

Step 2: Enter the password in the pop out window and press <ENT> to access the MMSI setting.

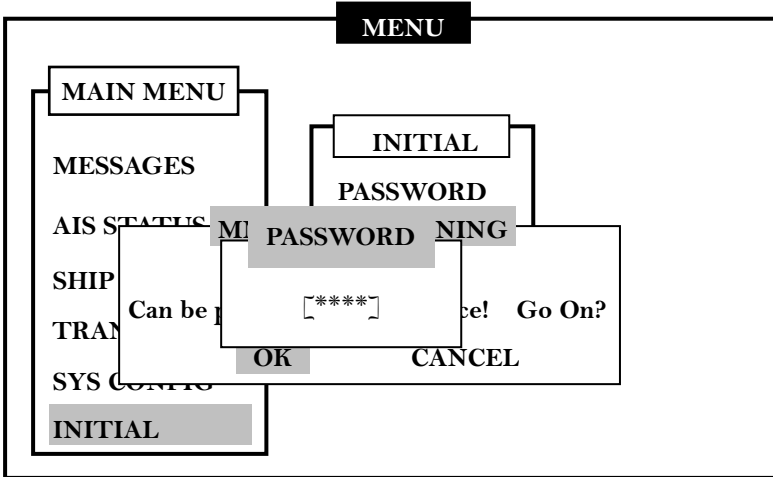

Step 3: MMSI can only be entered ONCE. A pop out window will appear to remind you.

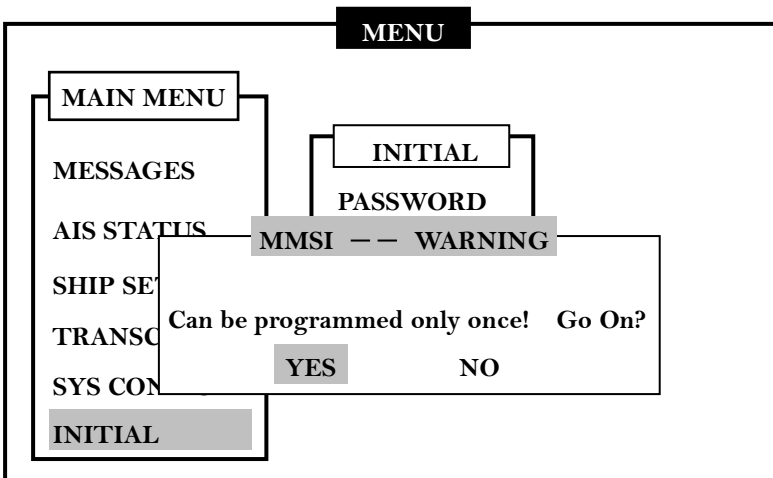

Step 4: Select "YES" to confirm and enter the MMSI. Select "NO" to escape from this menu.

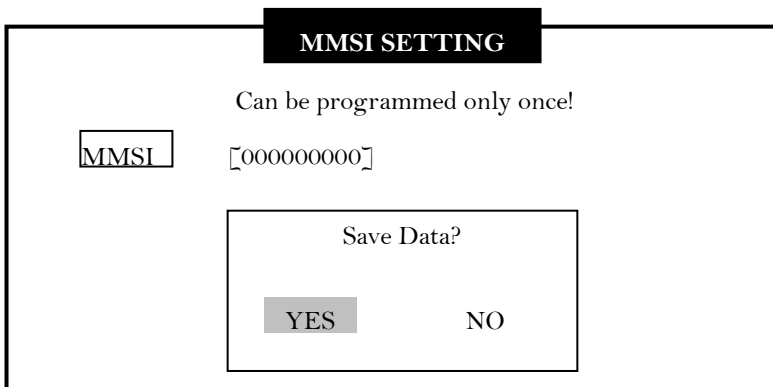

Step 5: When the set up is completed, press the <ESC> or <ENT> key and a pop out window will appear to confirm and save the setting.

Step 6: Select “YES” to confirm and save the data or “NO” to escape this menu.

***NOTE:** MMSI can only be entered ONCE. Make sure that the MMSI is correct before entering it.

5.6.3 CPA/TCPA Settings (User Password Protected)

Step 1: Select the “CPA/TCPA” function.

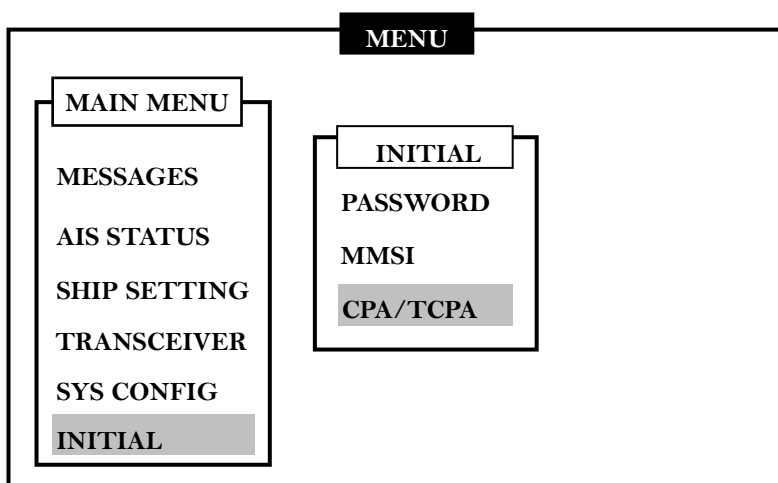

Step 2: A password is required. Enter the password in the pop out window.

Step 3: On the “CPA/TCPA” page, CPA (Closest Point of Approach) in nm and TCPA (Time to Closest Point of Approach) in minute can be set.

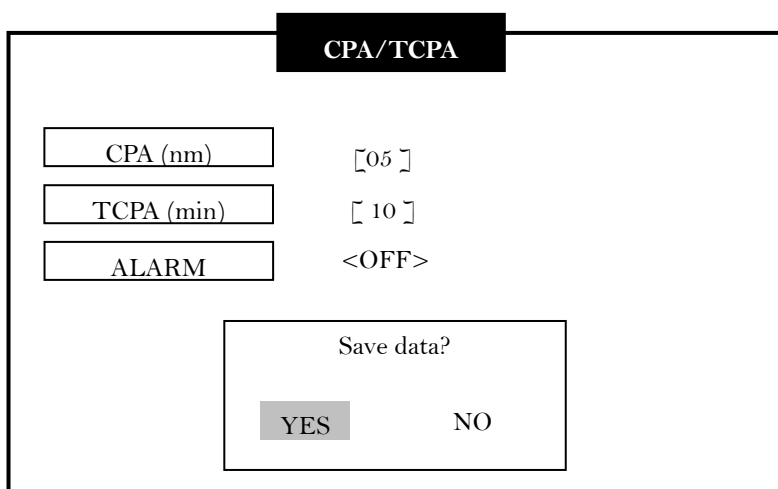

Step 4: Press the <ESC> or <ENT> key to confirm again and a pop out window will appear.

Step 5: Select “YES” to confirm and save the data or “NO” to escape this menu.

5.7 Dangerous Targets Information

Step 1: On the main display / radar view, press the <DISP> key one time to switch to the “DANGEROUS TARGETS”.

Step 2: On the dangerous targets list, the [003] on the top left corner stands for the total number of dangerous targets.

Step 3: Use the <UP> and <DOWN> keys to select the dangerous target to view.

DANGEROUS TARGETS				
[003]	NAME	MMSI	CPA	TCPA
1.	AMEC 001	307000123	1.36	1.31
2.	AMEC 006	307012456	0.85	1.17
3.	AMEC 014	307000045	1.17	1.21

Step 4: Use the <LEFT> and <RIGHT> keys to scroll to the next or previous pages.

Step 5: Press the <ENT> key on the selected dangerous target to view its ship details.
(Refer to section 7.2. for details)

6 DISPLAY MODE

6.1 Radar View

The AIS targets are displayed on your AMEC CAMINO-201's screen as shown below. These data are generated from the AIS data received from the vessels in the surrounding sea. These data have various indications and are dynamic.

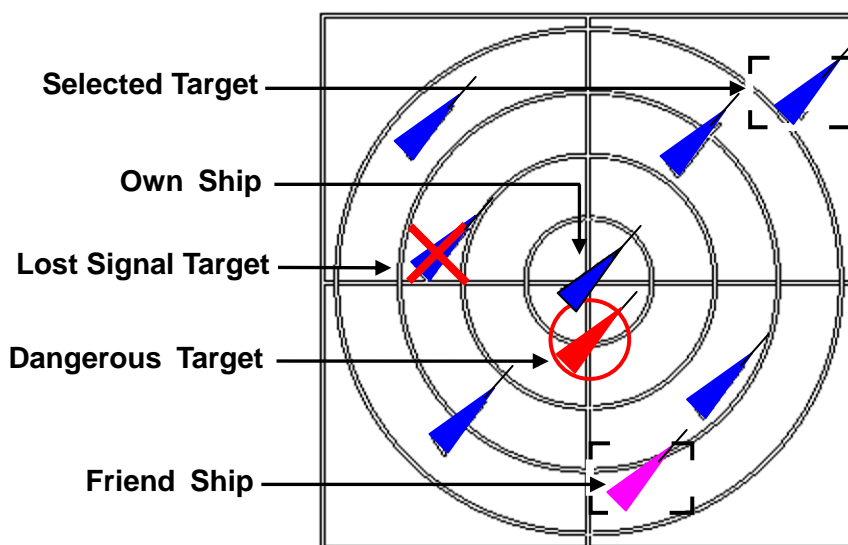

Figure 6-1 Radar View









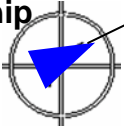

Below are some characteristics of the AIS targets:

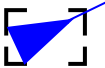
- Each AIS target is in the shape of a triangle and represents for one ship only.
- Under normal GPS reception, own ship is located in the center of the radar view.
- A maximum number of 500 AIS targets can be displayed on the radar view at one time.
- Vectors of a target can be displayed when it is an active target. The vectors are referred as a target's COG and SOG.
- The straight line extended from AIS target represents the course of the ship.

6.1.1 AIS Target Symbol Descriptions

Symbols for each AIS target displayed on the radar view is as described below,

Table 6-1-1 AIS target symbol

Own Ship 	GPS Reception: Normal / Color: Blue Under normal GPS reception, own ship is located in the center of the radar view.
AIS Target 	Color: Blue Ship equipped with AIS system in the surrounding sea will appear on the radar view as an AIS target.
Selected Target 	Color: Blue / Flashing Black Frame Use the arrow keys to select any target on the radar view. After selected, press <ENT> and the detailed information on each target can be viewed.
Dangerous Target 	Color: Red / Circled Frame When distance to a ship is smaller than CPA/TCPA, the target will be circled in RED. Use the arrow keys to select the dangerous target and to view its detailed information.
Friend Ship 	Color: Magenta If any pre-stored Friend Ship is nearby, the Friend Ship will appear in Magenta on the radar view.
Lost Signal Target 	Color: Blue / Crossed If reception of an AIS target has ceased over 10 minutes, a "X" will be displayed over it. The target will disappear from the Radar View after its reception has ceased for one hour.
AtoN (Real) 	Color: Green / Plus Sign The icon will be displayed if any AIS AtoN (Aids to Navigation) Real is in the range of reception.
AtoN (Virtual) 	Color: Green / Plus Sign and Undercut The icon will be displayed if any AIS AtoN (Aids to Navigation) Virtual is in the range of reception.
SAR 	Color: Black The icon will be displayed if any air plane is in the range of reception.
SART 	Color: Green / Cross The icon will be displayed if any SART message is sent out.

Base Station**Color: Green**

The icon will be displayed when any base station is in the range of reception.

***NOTE:** The straight line extended from AIS target represents the course of the ship.

6.1.2 Radar View Descriptions

The main display has three areas of different information the main display.

Area A: Own ship's dynamic information and time.

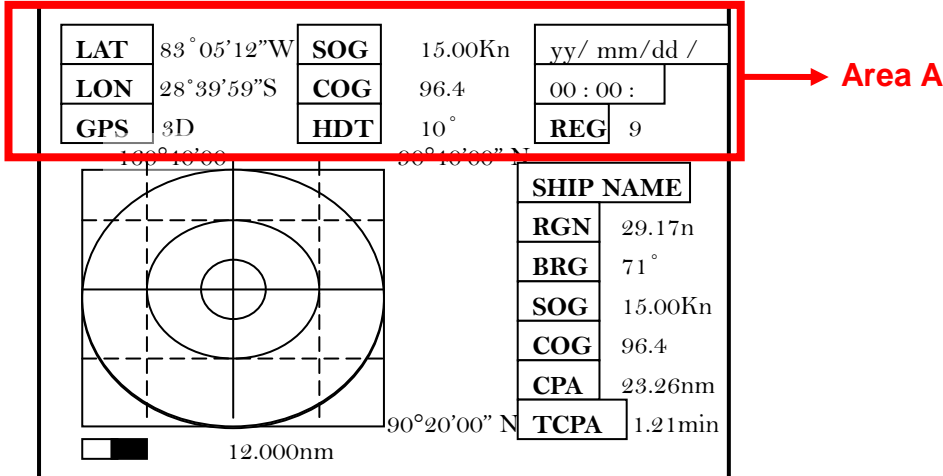

Figure 6-1-2-1 Main display

- LON: Current Longitude of own ship.
- LAT: Current Latitude of own ship.
- GPS (2D/3D \ Internal/External) : GPS related information.
- SOG: Speed over ground.
- COG: Course over ground.
- HDT: Own ship's heading.
- REG.: The current region setting. Default setting is set at 9 (high sea).
- Current Date: yy/mm/dd
- Current Time: 00:00:00 (hour : minute : second)

Area B: Selected target's dynamic information and time.

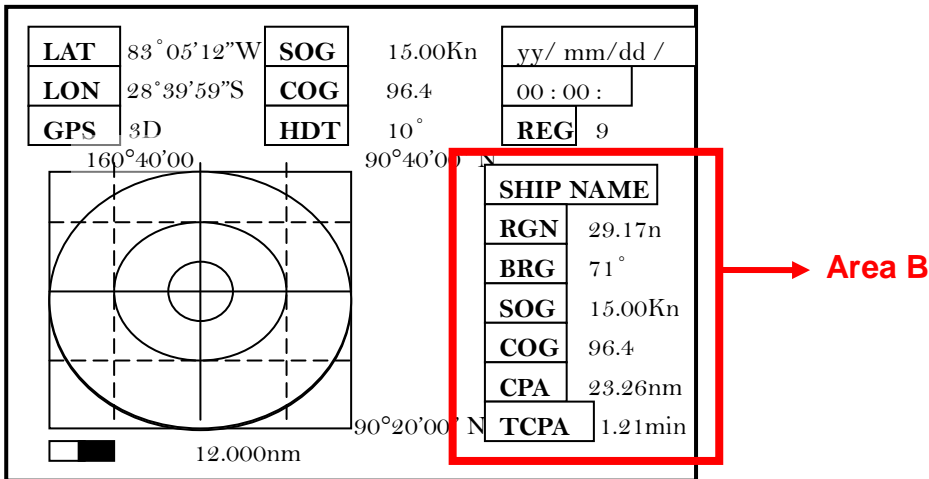

Figure 6-1-2-2 Main display

- Ship Name: Ship name of the selected target.
- RNG: Range of the selected target to own ship.
- BRG: Bearing of the selected target to own ship.
- SOG: Speed over ground of the selected target.
- COG: Course over ground of the selected target.
- CPA: Distance of Closest Point of Approach between own ship and the selected target.
- TCPA: Time to Closest Point of Approach between own ship and the selected target.

Area C: Radar View

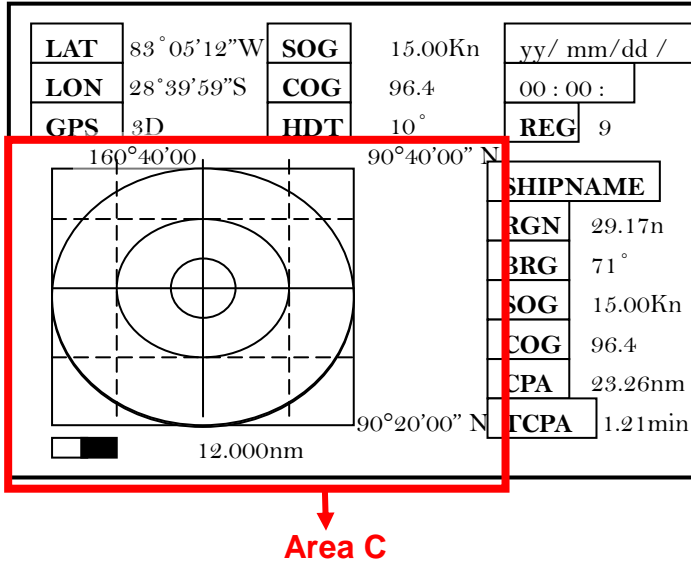

Figure 6-1-2-3 Main display

- Display own ship and target ships' status, and relations between them.
On the radar view, the vertical axis is the Longitude line and the horizontal axis is the Latitude line. Underneath the radar view is a proportional scale showing the current ratio used.
- Select target ships.
Use the <LEFT> and <RIGHT> keys to select a target ship. Selected target's dynamic information will be displayed on Area B. Press the <ENT> key to view selected target's detailed information.

***NOTE:** The arrow for selecting target ship moves from the center of the radar view.

- Scale up or down the scale ratio of the radar view.
Use the <UP> and <DOWN> keys to scale up and down the ratio of the radar view. Nine scale ratios are available: 0.05 / 0.125 / 0.25 / 0.5 / 0.75 / 1.5 / 3 / 6 / 12 nm.

6.2 Coastline Map Mode

To switch into Coastline Map Mode, press the DISP button on the right side of the panel.

Date: yy/mm/dd

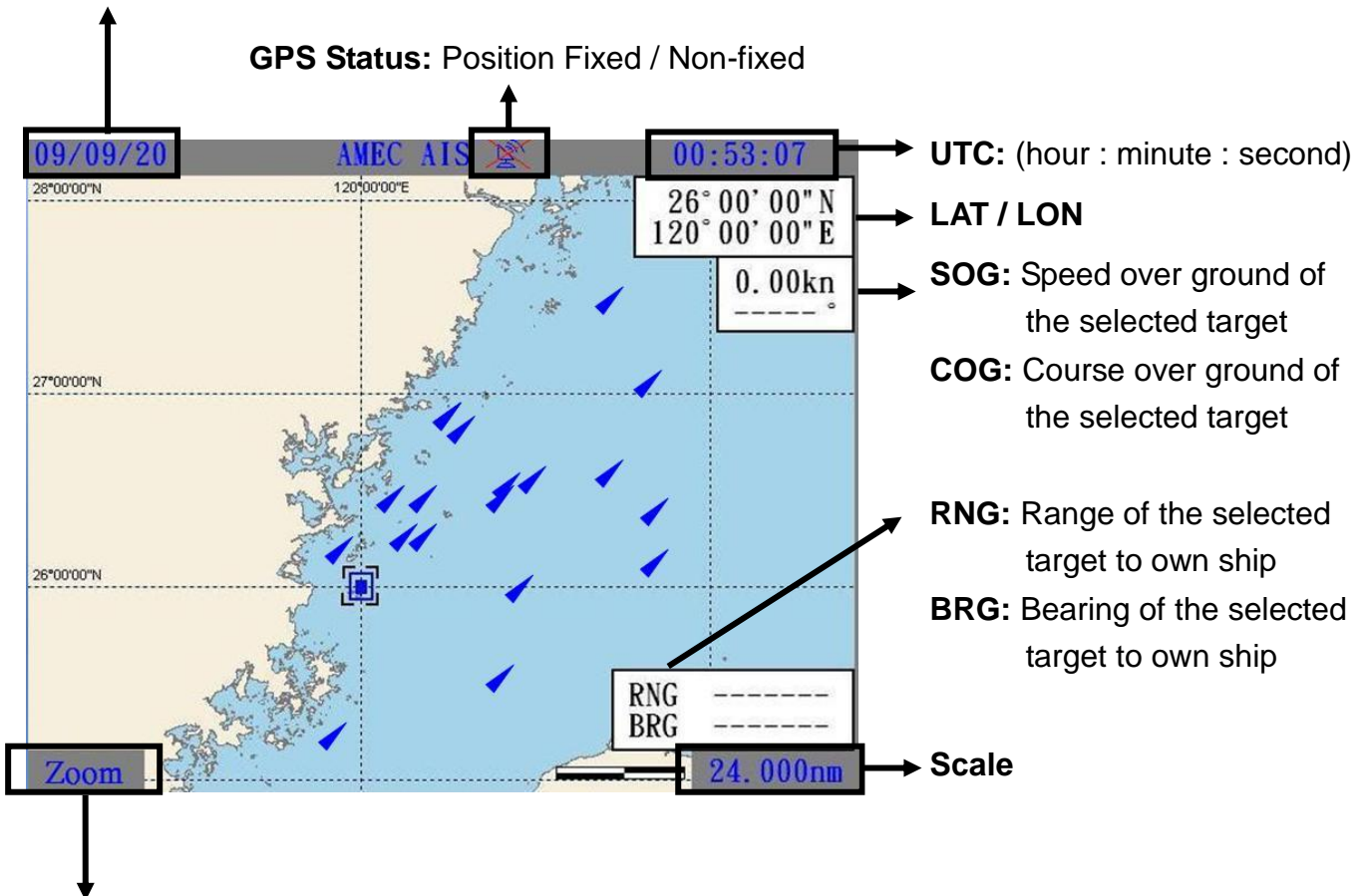

Zoom / Pan: Press and hold the <ESC> button on the right side of the panel to switch between Pan Mode and Zoom Mode.

- **Zoom:** Scale up and down the scale ratio of the Coastline Map. Use the <UP> and <DOWN> keys to zoom in and zoom out the plotter. The scale ratios are from 0.05nm to 24nm. To select a target ship, press <LEFT> and <RIGHT> keys to choose the desired target ship.
- **Pan:** Move the plotter under the Pan Mode. Use the <UP>, <DOWN>, <LEFT> and <RIGHT> keys to move the plotter up, down, left and right.

Centralize own ship: In both Zoom and Pan Mode, press <ESC> button to centralize your own ship in the plotter.

Timezone: Show the Local time and the UTC time.

- **Local time:** indicated by the color of black.
- **UTC time:** indicated by the color of blue.

7 APPENDIX

7.1 Product Specifications

STANDARDS

IEC 62287-1 (2006)
 IEC 61162-1 (2000)
 IEC 61162-2 (1998)

VHF CHANNELS

Frequency Range	156.025 MHz~162.025 MHz
Channel Bandwidth	25KHz
Number of RF Channels	2 Receivers (one time-shared between AIS/DSC) /1 Transmitter
RX_1	161.975MHz
RX_2	162.025MHz
Number of DSC Receivers	1 (CH70)
RX DSC	156.525MHz
Frequency Error	±3ppm

VHF TRANSMITTER

Power Output	2Watt (33dBm ± 1.5dB)
Modulation	GMSK/FM
Data Rate	9600bps
Transmission Spectrum	IEC 62287

VHF RECEIVER

Data Rate	9600-bps
Max. Usable Sensitivity	PER ≤20% at -107 dBm



DSC RECEIVER

Modulation	1300 Hz / 2100 Hz FSK
Data Rate	1200bps \pm 30ppm
Frequency Stability	$< \pm$ 3ppm
Spurious Response Rejection	\geq 70 dB for signal@ -104dBm;
Blocking	BER \leq 1% \geq 84dB for signal@ -104dBm;

GPS RECEIVER

Receiving Channels	12 channels
Acquisition Sensitivity	\geq -140dBm
Tracking Sensitivity	\geq -150dBm
Position Accuracy	$<$ 5 m CEP (GPS)
Output Rate	1Hz

POWER SUPPLY

Supply Voltage	12V / 24V DC
Power Consumption	Less than 10W

DISPLAY UNIT

Screen Size	5.7" Color LCD
Resolution	640 x 480
Dimmer Control	Stepless Setting
3 Indicator Lights on the Front Panel	1. Power/Status Indicator 2. Channel 1 Tx/Rx Operating Indicator 3. Channel 2 Tx/Rx Operating Indicator
10 Keypads with Backlight	1) SRM 2) DIM 3) DISP 4) MENU 5) ESC 6)~10) Arrow Keys



INTERFACES

Serial Port-1 (NMEA 0183)	IEC 61162-1/61162-2 with Relay Alarm Output
Serial Port-2	RS-232C for PC
GPS Antenna (Optional)	Female TNC Connector
VHF Antenna (Optional)	M Jack Connector
Wireless LAN	Bluetooth

BIIT ALARM SYSTEM

BIIT Message on Display/Relay Alarm Output

ENVIRONMENT

Operating Temperature	-15°C~55°C
Storage Temperature	-25°C~70°C
Operating Humidity	95%RH at 40°C
Vibration, EMI, ESD	IEC 60945
Waterproof	IPX5
Standard Magnetic Compass Safe Distance	1.20 m
Steering Magnetic Compass Safe Distance	0.70 m

PHYSICAL (with display)

Size in mm (w)	261mm
Size in mm (h)	184mm
Size in mm (d)	102mm
Weight	≤2.5kg

7.2 Dimensions

Front View

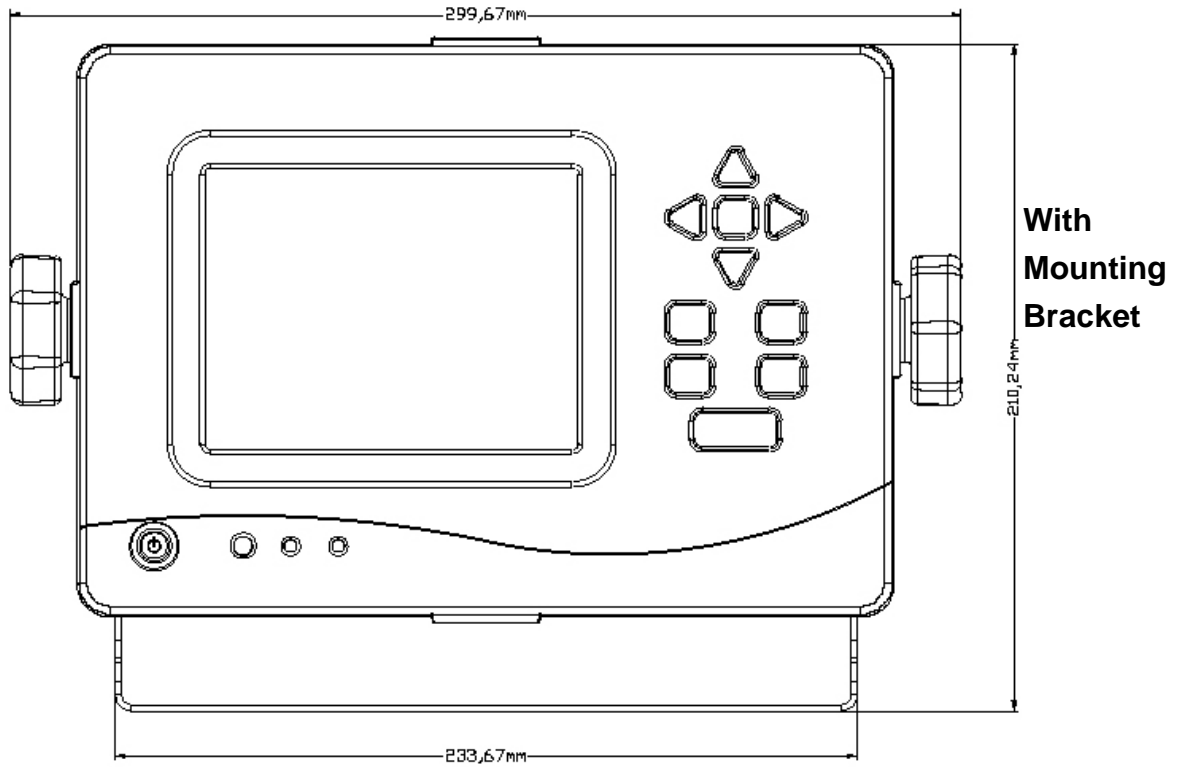

Figure 7-2-1 CAMINO-201 front view

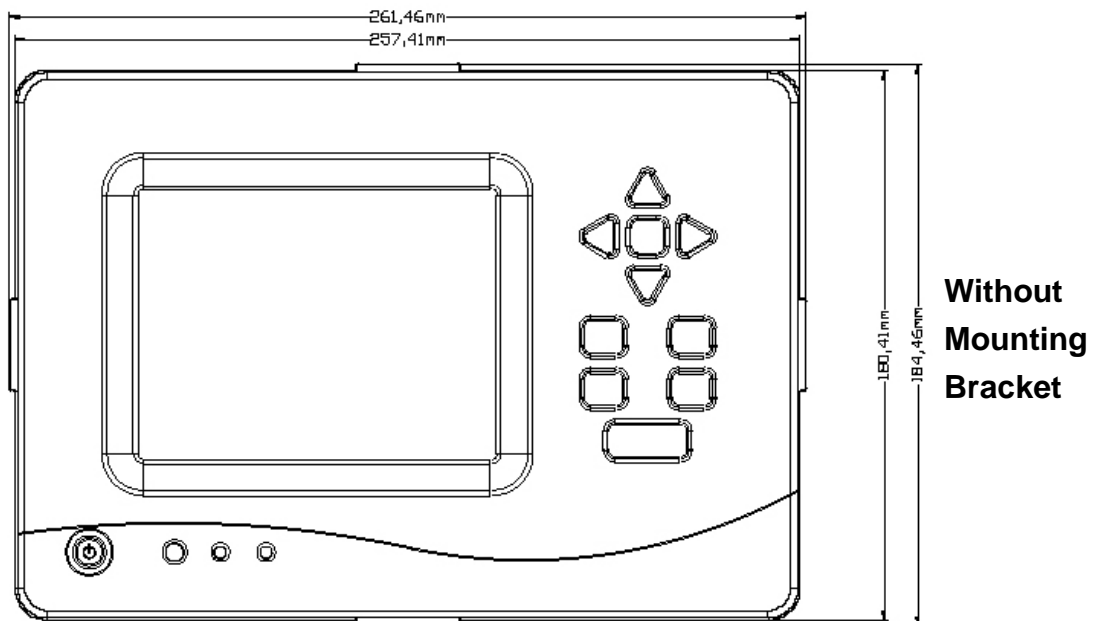

Figure 7-2-2 CAMINO-201 front view

Side View

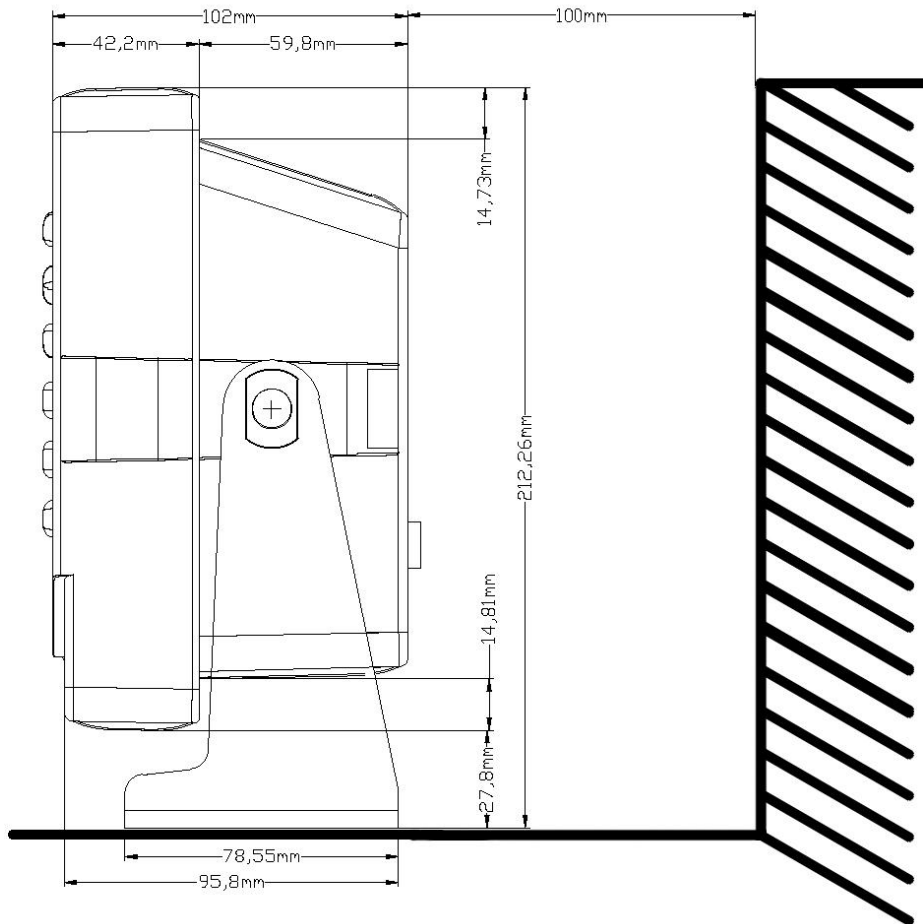

Figure 7-2-3 CAMINO-201 side view

Top View

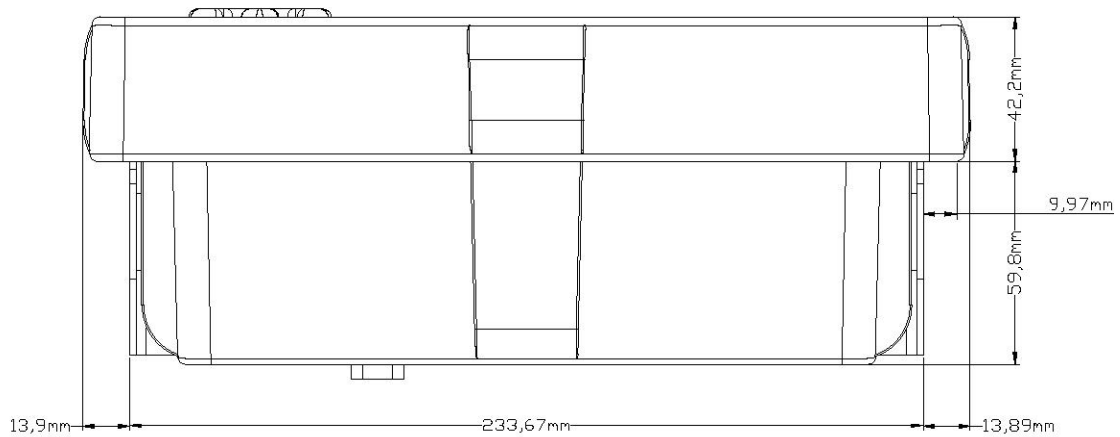

Figure 7-2-4 CAMINO-201 top view

7.3 Accessories

The following accessories are available from AMEC. Contact our local dealer/agent for more details.

Table 7-3 Accessories

Item	Description	Remark
1	VHF Antenna	Length: 1,200 mm
2	GPS Antenna	Dimension: 90.5 mm(Diameter) x 108.5 mm (H)
3	VHF/GPS Combo Antenna	Length: 1,680 mm

7.4 Trouble Shooting

7.4.1 Problem Analysis (By Status LED Indicator)

- The color of the status indication light will change in different status. You can make a general analysis base on the status described below,

Table 7-4-1 Problem analysis

STATUS LED INDICATOR			
Color	State	Indications	Descriptions
Orange	ON	Silent Mode	(1) MMSI is not set. Unit can only receive data. Unit can transmit when the MMSI is set and the GPS is not in 3D positioning. (2) Unit is in Tx Off Mode.
	Flash	TX Timeout	Channel jammed or being assigned as Quiet mode by the VTS. Only receiving is allowed. Transmit function will be allowed when the situations resolved.
Red	ON	Power Error	Check for power connection and power voltage.
	Flash	BIIT alarm	An abnormal condition of the device is detected during BIIT (Built In Integrity Test) (*NOTE 1)

***NOTE 1:**

With BIIT (Built in Integrity Test) feature, the CAMINO-201 is constantly monitoring and testing the integrity of the AIS transceiver. Should an abnormal condition be detected in the device, the Status LED will display an alarm in flash red. Abnormal condition may include situations like following:

- GPS is unable to gain lock after 30 minutes of losing GPS track
- Background noise level exceeds allowable threshold (-77dBm)

- When the status indication light is in red or orange, follow the “Descriptions” in the above table to make a general analysis.
- If the problem persists, follow the below step and restart the unit.
 1. Refer to section 3.2 to turn off the unit.
 2. Disconnect the power cord from the unit, reconnect after 1~2 minutes.
 3. Refer to section 3.2 to turn on the unit.
- If the problem still persists, contact your local agent/dealer.

7.4.2 Problem Analysis (Hardware)

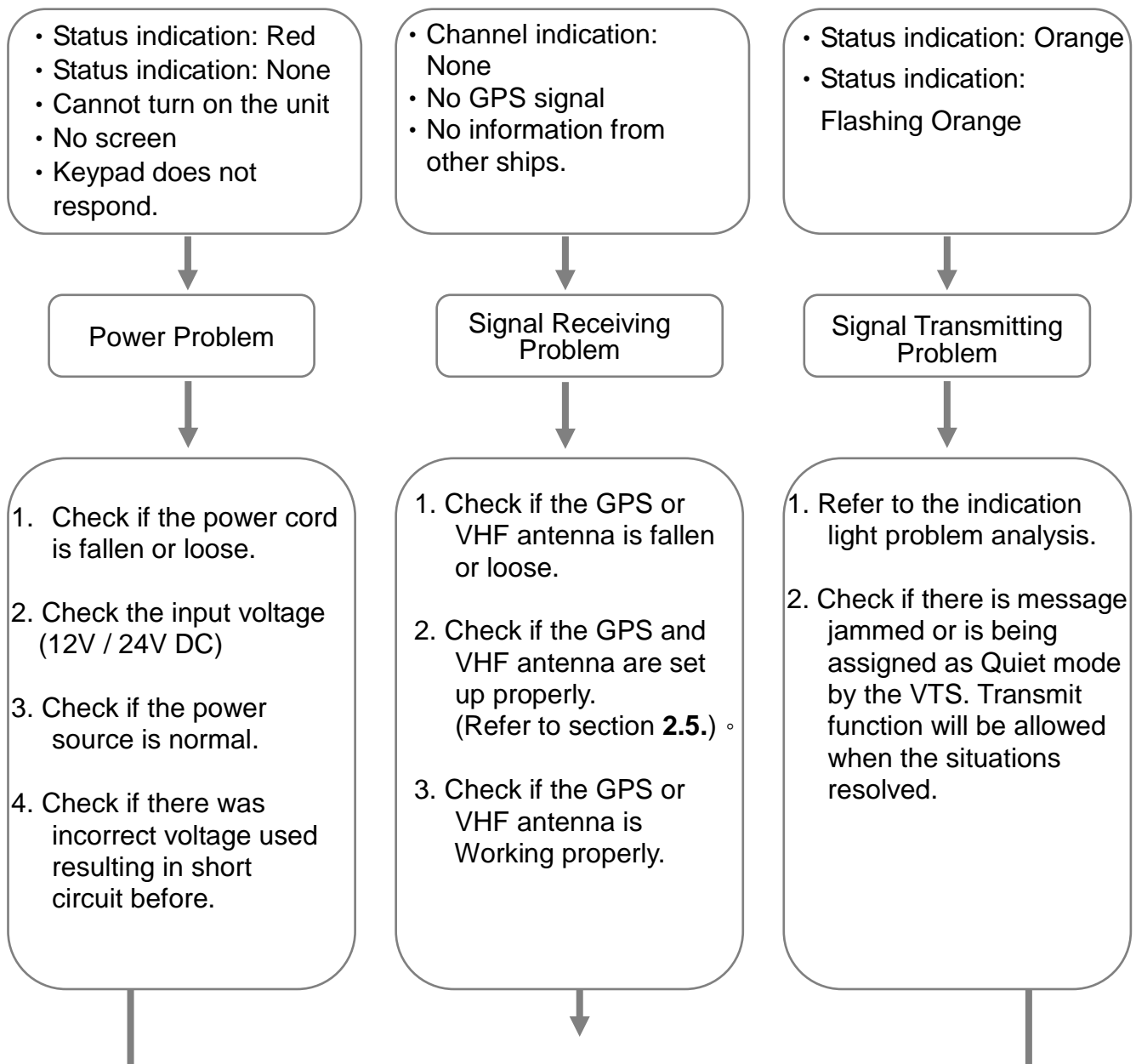

→ If the problem persists, contact your local agent/dealer. ←

7.4.3 Problem Analysis (Software)

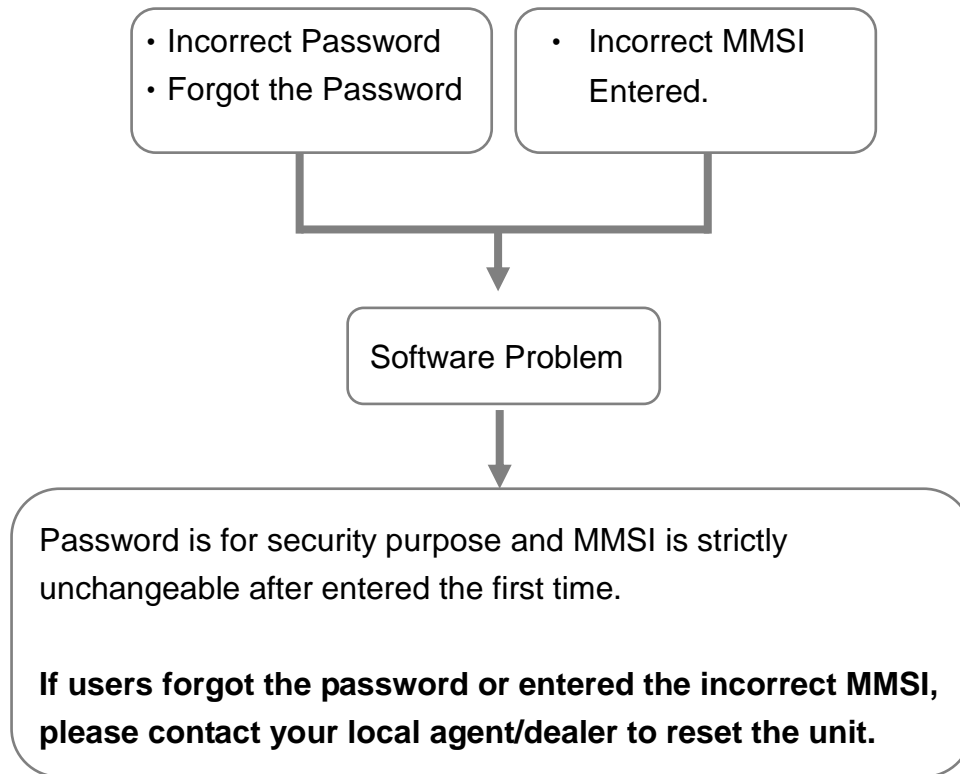



8 AMEC WORLD WIDE WARRANTY

Limited warranty

Subject to the terms, conditions and limitations set forth in this Worldwide Limited Warranty (hereinafter the “Warranty”), AMEC warrants that its products, when properly installed and used, will be free from defects in material and workmanship for a period of twelve (12) months, from the date of first purchase (the ‘Warranty Period’)

For the purposes of this warranty, ‘date of first purchase’ means the date that the product was purchased by the first retail customer, or by the institutional customer, or in the case of a product installed on a new vessel or any other marine related platform by a certified AMEC original equipment manufacturer (a ‘AMEC OEM’), the date that such vessel was purchased by the first retail customer.

AMEC will, at its sole option, repair or replace any defective products or components returned during the Warranty Period in accordance with the terms, conditions and limitations set forth below. **Such repairs or replacement will be the sole remedy of the customer under this Warranty.**

Standard Warranty Service

To qualify for standard warranty service the product must be returned to a AMEC-certified service agent (i) within the Warranty Period, and (ii) within thirty (30) days of the alleged product failure. Any products returned must be securely packaged and sent pre-paid and insured to AMEC or to a AMEC-certified service agent. All products returned must be accompanied by a copy of the original sales receipt to be eligible for standard warranty service.

Obtaining Warranty Service

A list of AMEC-certified service agents is available from AMEC Technical Support at www.alltekmarine.com

Other conditions

This Warranty is fully transferable provided that you furnish the original proof of purchase to the AMEC -certified service agent. This Warranty is void if the label bearing the serial number has been removed or defaced.



Limitation and Exclusions

In addition to any other limitations and exclusions set forth herein, AMEC is not responsible for, and this Warranty does not cover:

- Failure due to abuse, misuse, accident, unauthorized alteration, modification or repair, improper installation or operation (whether or not by a AMEC-certified service agent) or improper storage, shipping damage or corrosion;
- Costs associated with routine system checkouts, alignment/calibration, seatrials or commissioning;
- Defects or damage that result from the use of non-AMEC branded or certified products, accessories or other peripheral equipment, including without limitation housings, parts, or software;
- Aftermarket software (i.e. all software other than the original operating software sold with the products);
- Products that have been refurbished, reconditioned, or remanufactured (The foregoing does not apply to products repaired or replaced pursuant to the terms of this Warranty).
- Products that have been dismantled resulting in the broken label on the Products;
- costs associated with overtime or premium labor costs;
- differences in material, coloring or size that may exist between actual products and the pictures or descriptions of such products in our advertising, advertising literature or on the Internet;

TO THE EXTENT PERMITTED BY APPLICABLE LAW, THE FOREGOING WARRANTY IS AMEC'S SOLE WARRANTY AND IS APPLICABLE ONLY TO NEW PRODUCTS PURCHASED WORLDWIDE. THE PROVISIONS OF THIS WARRANTY ARE IN LIEU OF ANY OTHER WRITTEN WARRANTY, WHETHER EXPRESSED OR IMPLIED, WRITTEN OR ORAL, INCLUDING ANY WARRANTY OF MERCHANTABILITY OR FITNESS FOR A PARTICULAR PURPOSE.

THE LIABILITY OF AMEC TO A CUSTOMER UNDER THIS WARRANTY, WHETHER FOR BREACH OF CONTRACT, TORT, BREACH OF STATUTORY DUTY OR OTHERWISE SHALL IN NO EVENT EXCEED AN AMOUNT EQUAL TO THE TOTAL PURCHAE PRICE OF THE PRODUCT GIVING RISE TO SUCH LIABILITY AND IN NO EVENT SHALL AMEC BE LIABLE FOR SPECIAL, INCIDENTAL, CONSEQUENTIAL OR INDIRECT DAMAGES OR LOST OF GOODWILL, REPUTATION, LOSS OF OPPORTUNITY OR INFORMATION, DATA, SOFTWARE OR APPLICATIONS.



SOME JURISDICTIONS DO NOT ALLOW EXCLUSION OR LIMITATION OF INCIDENTAL OR CONSEQUENTIAL DAMAGES SO THE ABOVE LIMITATIONS OR EXCLUSIONS MAY NOT APPLY TO YOU. THIS WARRANTY GIVES YOU SPECIFIC LEGAL RIGHTS AND YOU MAY ALSO HAVE OTHER RIGHTS, WHICH VARY FROM JURISDICTION TO JURISDICTION.

This Warranty supersedes and replaces all previous Warranties.

In the event that any term or provision contained in this Warranty is found to be invalid, illegal or unenforceable by a court of competent jurisdiction, then such provision shall be deemed modified to the extent necessary to make such provision enforceable by such court, taking into account the intent of the parties.

No oral or written representations made by AMEC or any seller, reseller or distributor of the products, including employees and agents thereof, shall create any additional warranty obligations, increase the scope, or otherwise modify in any manner the terms of this Warranty.

All AMEC products sold or provided hereunder are merely aids to navigation. It is the responsibility of the user to exercise discretion and proper navigational skill independent of any AMEC product.

9 ABBREVIATIONS

AIS	Automatic Identification System
COG	Course Over Ground
CPA	Distance to Closest Point of Approach
CSTDMA	Carrier-sense Time Division Multiple Access
DSC	Digital Selective Calling
ECS	Electronic Chart System
ETA	Estimated Time of Arrival
GPS	Global Positioning System
IMO	International Maritime Organization
MMSI	Maritime Mobile Service Identity
SOG	Speed Over Ground
SRM	Safety Related Message
TCPA	Time to Closest Point of Approach
TDMA	Time Division Multiple Access
UTC	Coordinated Universal Time
VHF	Very High Frequency
VTS	Vessel Traffic Service

10 INDEX

A

alarm 3,4,13,24,38,39,54,61,72,75

accessories 6,75,79

AIS message type

-static data 3

-dynamic data 3

-dynamic reports 3

-SRM 3

AIS type of

-class A AIS 1,2,32

-class B AIS 1,2,3,6,32,47

-AIS Receiver 19,32,44

AIS target status 39

antenna

-VHF antenna 2,14,15,17,72,75,76

-GPS antenna 2,12,15,16,17,49,50,72,75

-Combo antenna 75

-installation 14,16

-antenna cabling 16

-antenna location 3,15,16

AIS report rate 3

arrow keys 20,22,30,31,54,55,64,71

B

background noise 24,75

baud rate 32,34,53,55,56,57

beam 3,15,28,41

BIIT 24,72,75

BIIT alarm 24,72,75

bluetooth pairing 17

BRG 21,26,28,40,41,42,43,66,67,68,69

C

call sign 1,3,21,41,49

carrier sensing 1,81

coastline map 25,26,69

COG 3,21,26,28,40,41,63,66,67,68,69,81

connector

-power 13,12

-NMEA 0183 13

-RS-232 14

CPA/TCPA 4,28,34,35,41,42,58,60,63,66,68,83

CSTDMA 1,2,81

D

dangerous target 27,62,64

default configuration 56

dimensions 21,73,75

DISP 22,25,62,69,71

display

-backlight 30,71

- brightness control 22,30

-dimmer control 30,71

-pan 69

-zoom 69

-radar view 26

-coastline map view 25,26

-mode selection 25

-language 54

DSC receiver 44,52,70,71

dynamic data 3

dynamic information 1,27,29,33,41,43,67,68,69

dynamic report 3

- E**
 - EPFD 42
 - ESC key 44,46,48,50,52,54,56,57,61,63,70
 - ETA 42,83
 - equipment list 7
 - external connection 18
- F**
 - factory setting 28,40,41
 - frequency range,70
 - friend ship information 32,42,50
 - friend ship list 50
 - friend ship setting 42,51
- G**
 - GPS antenna location 3,15,16
 - GPS receiver 71
- H**
 - HDT 21,26,28,40,41,66,67,68
 - heading 3,41,66
- I**
 - INBOX 35,36,38
 - Installation 5
 - Interface wiring 14
- K**
 - Keypad 2,7,22,71,76
- L**
 - LAT 21,26,28,40,41,45,66,67,68,69
 - language 54
 - LED indicator 24,75
 - LON 21,26,28,40,41,45,66,67,68,69
 - Loss target 66
- M**
 - menu key 33,36
 - menu tree 34
 - message inbox 34,35,36,38
 - message outbox 34,35,36,37,38
 - message type 3
 - MMSI 1,3,19,20,21,24,28,32,34,35,36,40,41,42,43,46,50,51,58,59,60,61,62,75,77,81
 - mounting
 - table stand mounting 8,10
 - wall mounting 8,10
- N**
 - NMEA 0183 6,7,12,13,14,17,72
- O**
 - own ship information 28,40
- P**
 - password setting 58,59
 - power consumption 71
 - power on 5,18,22,23
 - product specifications 70
 - product version 47
- Q**
 - quick start guide 18
- R**
 - radar view 21,25,26,31,32,34,35,39,48,52,53,55,56,57,58,62,63,64,66
 - received SRM 35
 - REG 21,26,66,67,68
 - Region settings 30,44
 - RNG 28,40,41,42,43,67,69
 - ROT 42

S

safety related message 22,25,38,39,81

ship configuration 48

ship detail 28,40,41

ship settings 16,31,32,33,34,35,36,38,40,42,43,46,47,
48,49,50,52,53,55,56,57,58,59,60,61

static Data 3,48

SOG 3,21,26,28,40,41,63,66,67,68,81

SRM

-editing 38

-received SRM 35

-transmitted SRM 32,36

SRM alarm 3,38,39

system configuration 32,53

T

target status 39

TCPA

4,21,26,27,28,32,33,34,40,41,56,58,59,60,61,62,64,66,67,81

transceiver ON/OFF 52

transmitted SRM 32,36

transition zone 45

trouble shooting 75,77

V

vessel information 46

vibration 72

voyage information 32

W

Warranty 5,78,79,80

Water proofing 72