

CE Test Report

Product Name	AIS Class B Transponder
Model No.	CAMINO-108, CAMINO-108W

Applicant	Alltek Marine Electronics Corp.
Address	7F, No.605, Ruei Guang Rd., Neihu, Taipei, Taiwan, 114 R.O.C.

Date of Receipt	May 06, 2013
Issued Date	Oct. 21, 2013
Report No.	135096R-RFCEP03V01
Report Version	V2.0



The Test Results relate only to the samples tested.

The test report shall not be reproduced except in full without the written approval of Quietek Corporation.

This report must not be used to claim product endorsement by TAF or any agency of the Government.

Test Report Certification

Issued Date: Oct. 21, 2013

Report No.: 135096R-RFCEP03V01



Product Name	AIS Class B Transponder
Applicant	Alltek Marine Electronics Corp.
Address	7F, No.605, Ruei Guang Rd., Neihsu, Taipei, Taiwan, 114 R.O.C.
Manufacturer	Alltek Marine Electronics Corp.
Model No.	CAMINO-108, CAMINO-108W
EUT Rated Voltage	DC 9.6~31.2V
EUT Test Voltage	DC 12/24V
Trade Name	AMEC
Applicable Standard	ETSI EN 301 843-1:V1.2.1 (2004.06) ETSI EN 301 843-2:V1.2.1 (2004.06)
Test Result	Complied

The test results relate only to the samples tested.

The test report shall not be reproduced except in full without the written approval of QuieTek Corporation.

This report must not be used to claim product endorsement by TAF or any agency of the Government.

Documented By : Jinn Chen
(Senior Adm. Specialist / Jinn Chen)

Tested By : Andy Lin
(Assistant Engineer / Andy Lin)

Approved By : [Signature]
(Manager / Vincent Lin)

TABLE OF CONTENTS

Description	Page
1. GENERAL INFORMATION	6
1.1. EUT Description.....	6
1.2. Tested System Details.....	7
1.3. EUT Test Setup Environment & Configuration of AIS System	7
1.4. Performance Check Method.....	8
1.5. EUT Operation Procedures.....	8
1.6. Test Facility	9
2. Conducted Emission.....	10
2.1. Test Equipmen	10
2.2. Test Setup	10
2.3. Limits	11
2.4. Test Procedure	11
2.5. Test Specification	12
2.6. Uncertainty	12
2.7. Test Result	12
3. Radiated Emission.....	13
3.1. Test Equipment.....	13
3.2. Test Setup	13
3.3. Limits	14
3.4. Test Procedure	14
3.5. Test Specification	15
3.6. Uncertainty	15
3.7. Test Result	15
4. Electrostatic Discharge (ESD)	16
4.1. Test Equipment.....	16
4.2. Test Setup	16
4.3. Test Level	16
4.4. Test Procedure	17
4.5. Test Specification	17
4.6. Uncertainty	17
4.7. Test Result	17
5. Radiated Susceptibility (RS).....	18
5.1. Test Equipment.....	18
5.2. Test Setup	18
5.3. Test Level	18
5.4. Test Procedure	19
5.5. Test Specification	19
5.6. Uncertainty	19
5.7. Test Result	19
6. Electrical Fast Transient/Burst (EFT/B)	20
6.1. Test Equipment.....	20
6.2. Test Setup	20
6.3. Test Level	21
6.4. Test Procedure	21
6.5. Test Specification	21
6.6. Uncertainty	21
6.7. Test Result	21
7. Conducted Susceptibility (CS).....	22
7.1. Test Equipment.....	22
7.2. Test Setup	22
7.3. Test Level	22

7.4.	Test Procedure	23
7.5.	Test Specification	24
7.6.	Uncertainty	24
7.7.	Test Result	24
8.	Power Supply Failure.....	25
8.1.	Test Setup	25
8.2.	Test Procedure	25
8.3.	Test Specification	25
8.4.	Test Result	25
9.	EMC Reduction Method During Compliance Testing	26
10.	Test Result	27
10.1.	Test Data of Conducted Emission	28
10.2.	Test Data of Radiated Emission	30
10.3.	Test Data of Electrostatic Discharge	36
10.4.	Test Data of Radiated Susceptibility	38
10.5.	Test Data of Electrical Fast Transient.....	40
10.6.	Test Data of Conducted Susceptibility	42
10.7.	Test Data of Power Supply Failure.....	44
Attachment 1:	EUT Test Setup Photographs	
Attachment 2:	EUT Detailed Photographs	

Revision History

Rev.	Issue Date	Revisions	Effect page
V1.0	August 20, 2013	Initial Issue	All
V2.0	October 21, 2013	<ol style="list-style-type: none">1) Add Revision History2) Modify section 1.2 Tested System Details3) Modify section 1.3 EUT Test Setup Environment & Configuration of AIS System4) Add section 1.4 Performance Check Method5) Modify section 1.5 EUT Operation Procedures	5, 7, 8

1. GENERAL INFORMATION

1.1. EUT Description

Product Name	AIS Class B Transponder
Trade Name	AMEC
Model No.	CAMINO-108, CAMINO-108W
Frequency Range	156.025MHz~162.025MHz
Type of Modulation	GMSK / FM
Data Rate	9600bps / per channel
Channel Separation	25KHz
Antenna Type	Dipole
Channel Control	Auto
Antenna Gain	Refer to the table "Antenna List"
VHF Cable	Shielded, 10m
GPS Cable	Shielded, 10m
Hardware	M-PCB-B108MBV1
Software	V1.2.6

Note:

1. Quietek verified the construction and function in typical operation. All the test modes were carried out with the EUT in normal operation, which was shown in this test report and defined as:

EMI Mode	Normal Operation (VHF Mode)
EMS Mode	Normal Operation (VHF Mode)

2. The Device have WLAN、GPS and VHF function, this test report is for VHF function.

1.2. Tested System Details

The types for all equipment, plus descriptions of all cables used in the tested system (including SD cards) are:

Product	Manufacturer	Model No.	Serial No.	Power Cord	
1	Notebook PC	DELL	PP04X	7607342512	Non-shielded, 1.8m
2	GPS Simulator	Agilent	E4438C	N/A	Non-shielded, 1.8m
3	AIS Transponders	AMEC	CAMINO-101 / CAMINO-701	N/A	Non-shielded, 1.8m

1.3. EUT Test Setup Environment & Configuration of AIS System

In order to do performance-check during EMC immunity tests, an equipment setup (AIS related) as shown in the following diagram is used in general.

A Satellite Simulator is used during the tests to emulate GPS signal source for the EUT.

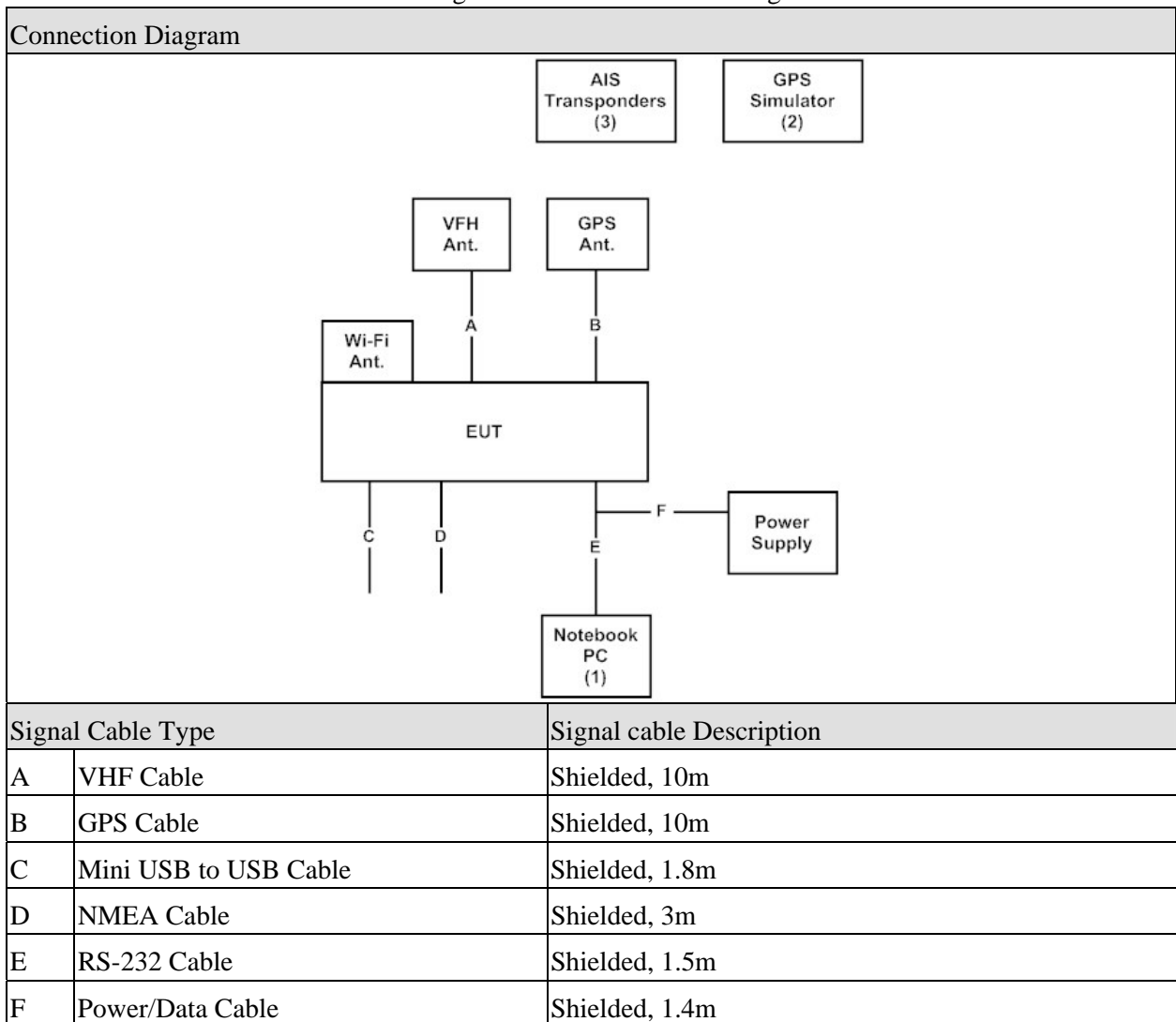

1.4. Performance Check Method

The EUT is set into autonomous mode with reporting interval of 180 seconds in the test environment in Section 1.3. Additional AIS transponders are used to monitor the content of reports and the reporting intervals of EUT. The EUT performance shall not be degraded during or after the test. A PC software tool is used in parallel to record the AIS transmitting rate and receiving rate. The data is used to check if there is any degradation of performance or loss of function.

An IEC-61162 Datalogger software is used (running on PC) to check the EUT performance during and after the test together with the additional AIS transponders.

1.5. EUT Operation Procedures

- (1) Setup the EUT and Peripherals as shown in section 1.3.
- (2) Turn on the power of all equipments.
- (3) The VHF function is used to perform the wireless data transmission.
- (4) Verify that the EUT works properly.

1.6. Test Facility

Ambient conditions in the laboratory:

Items	Test Item	Required	Actual
Temperature (°C)	IEC 61000-4-2	15-35	20
Humidity (%RH)		30-60	50
Barometric pressure (mbar)		860-1060	950-1000
Temperature (°C)	IEC 61000-4-3	15-35	23
Humidity (%RH)		25-75	50
Barometric pressure (mbar)		860-1060	950-1000
Temperature (°C)	IEC 61000-4-4	15-35	24
Humidity (%RH)		25-75	58
Barometric pressure (mbar)		860-1060	950-1000
Temperature (°C)	IEC 61000-4-5	15-35	25
Humidity (%RH)		10-75	49
Barometric pressure (mbar)		860-1060	950-1000
Temperature (°C)	IEC 61000-4-6	15-35	24
Humidity (%RH)		25-75	50
Barometric pressure (mbar)		860-1060	950-1000
Temperature (°C)	IEC 61000-4-11	15-35	25
Humidity (%RH)		25-75	49
Barometric pressure (mbar)		860-1060	950-1000

The related certificate for our laboratories about the test site and management system can be downloaded from Quietek Corporation's Web Site : <http://tw.quietek.com/modules/myalbum/>
 The address and introduction of Quietek Corporation's laboratories can be founded in our Web site : <http://www.quietek.com/>

Site Description: Accredited by TAF
 Accredited Number: 0914

Site Name: Quietek Corporation
 Site Address: No. 5-22, Ruei-Shu Valley, Ruei-Ping Tsuen,
 Lin-Kou Shiang, Taipei,
 Taiwan, R.O.C.
 TEL : 886-2-8601-3788 / FAX : 886-2-8601-3789
 E-Mail : service@quietek.com

2. Conducted Emission

2.1. Test Equipmen

	Equipment	Manufacturer	Model No. / Serial No.	Last Cal.	Remark
X	Test Receiver	R & S	ESCS 30 / 825442/018	Sep., 2012	
X	Artificial Mains Network	R & S	ENV4200 / 848411/10	Feb., 2013	Peripherals
X	LISN	R & S	ESH3-Z5 / 825562/002	Feb., 2013	EUT
	DC LISN	Schwarzbeck	8226 / 176	Mar, 2013	EUT
X	Pulse Limiter	R & S	ESH3-Z2 / 357.8810.52	Feb., 2013	
X	4-wire ISN	R & S	ENY41 / 837032/001	Feb., 2013	
X	Double 2-Wire ISN	R & S	ENY22 / 835354/008	Feb., 2013	
	No.1 Shielded Room				

Note:

1. All equipments are calibrated every one year.
2. The test instruments marked by “X” are used to measure the final test results.

2.2. Test Setup

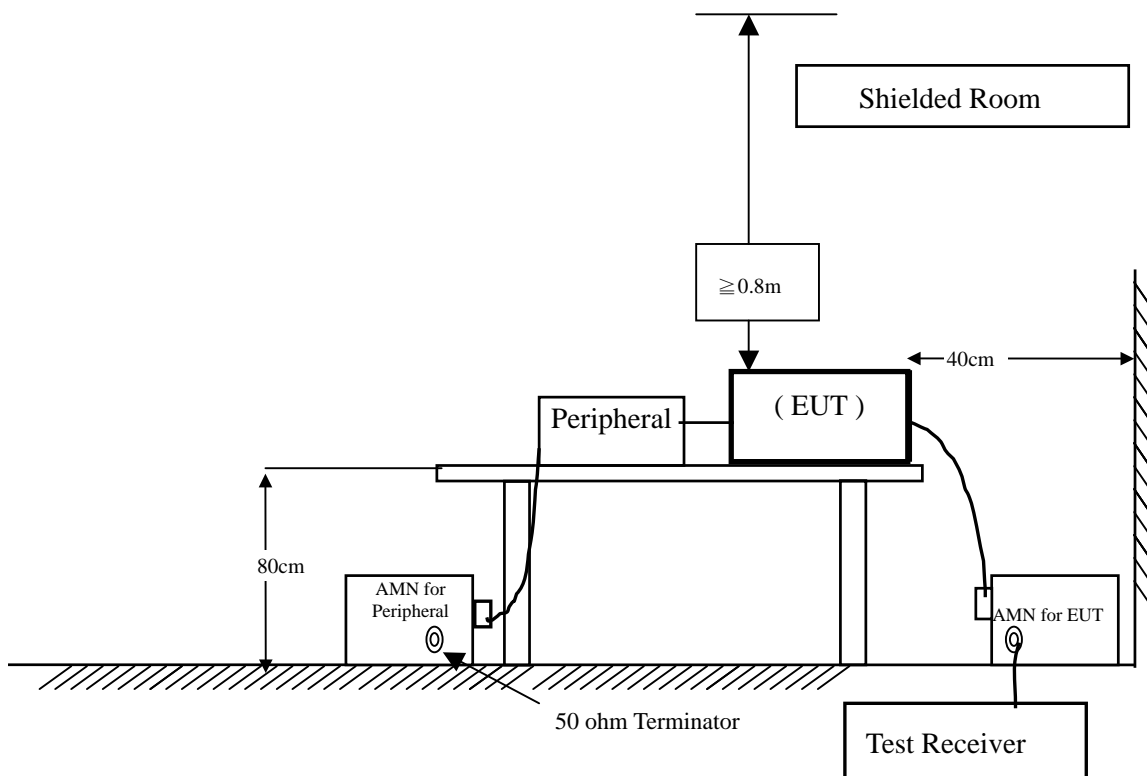

2.3. Limits

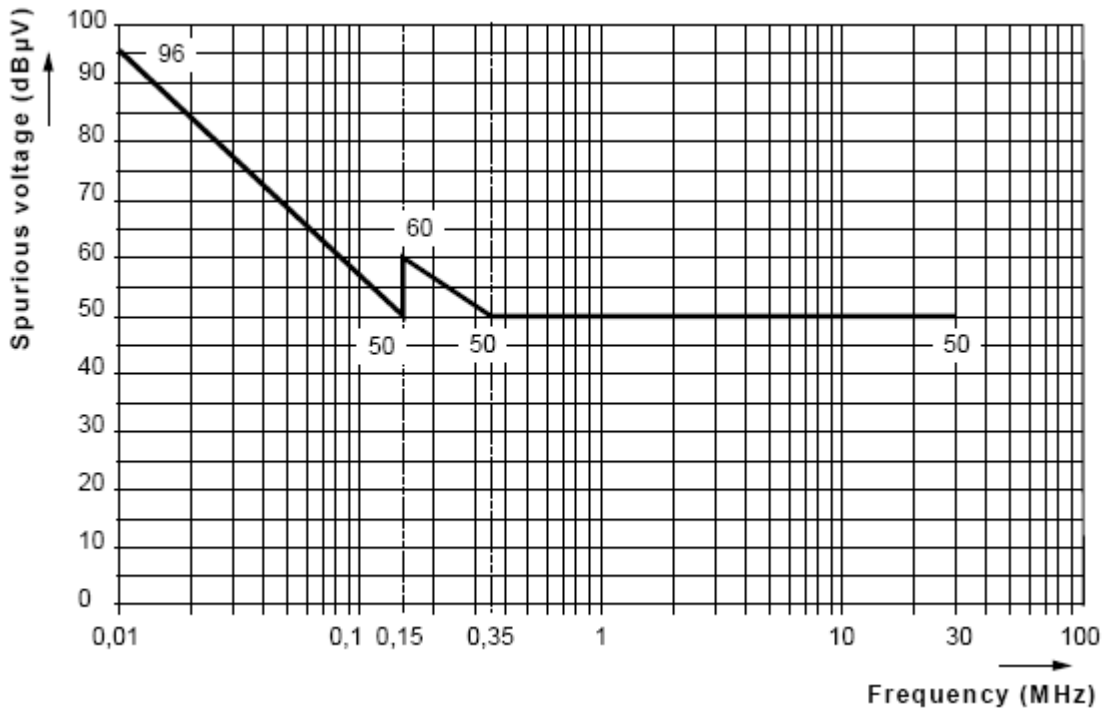

Maximum permissible level (quasi-peak) of conducted EMC emissions into the mains.

2.4. Test Procedure

The EUT and simulators are connected to the main power through a line impedance stabilization network (L.I.S.N.). This provides a 50 ohm /50uH coupling impedance for the measuring equipment. The peripheral devices are also connected to the main power through a LISN that provides a 50ohm /50uH coupling impedance with 50ohm termination. (Please refers to the block diagram of the test setup and photographs.)

Both sides of DC line are checked for maximum conducted interference. In order to find the maximum emission, the relative positions of equipment and all of the interface cables must be changed according to ETSI EN 301 843-1: V1.2.1 (2004-06) on conducted measurement.

The bandwidth of the field strength meter (R & S Test Receiver ESCS 30) is set at

- 200Hz in the frequency range 10KHz~150KHz and
- 9KHz to 10KHz in the frequency range 150KHz ~30MHz.

2.5. Test Specification

According to ETSI EN 301 843-1: V1.2.1 (2004-06)

2.6. Uncertainty

± 2.26 dB

2.7. Test Result

The emission from the EUT is below the specified limits. The worst-case emissions are shown in section 10.1.

The EUT complies the acceptance criterion and passes the test.

3. Radiated Emission

3.1. Test Equipment

The following test equipment are used during the Radiated emission test:

Test Site	Equipment	Manufacturer	Model No./Serial No.	Last Cal.
<input type="checkbox"/> Site # 1	Test Receiver	R & S	ESVS 10 / 834468/003	July, 2013
	Spectrum Analyzer	Advantest	R3162/ 00803480	May, 2013
	Pre-Amplifier	Advantest	BB525C/ 3307A01812	May, 2013
	Bilog Antenna	SCHAFFNER	CBL6112B / 2697	Nov., 2012
<input type="checkbox"/> Site # 2	Test Receiver	R & S	ESCS 30 / 836858 / 022	Nov., 2012
	Spectrum Analyzer	Advantest	R3162 / 100803466	May, 2013
	Pre-Amplifier	Advantest	BB525C/3307A01814	May, 2013
	Bilog Antenna	SCHAFFNER	CBL6112B / 2705	Oct., 2012
	Horn Antenna	ETS	3115 / 0005-6160	July, 2013
	Pre-Amplifier	QTK	QTK-AMP-01/ 0001	July, 2013
<input checked="" type="checkbox"/> Site # 3	Test Receiver	R & S	ESI 26 / 838786 / 004	May, 2013
	Spectrum Analyzer	Advantest	R3162 / 100803480	May, 2013
	Pre-Amplifier	QTK	QTK-AMP-03 / 0003	May, 2013
	Bilog Antenna	SCHAFFNER	CBL6112B / 2697	May, 2013
	Horn Antenna	ETS	3115 / 0005-6160	July, 2013
	Pre-Amplifier	QTK	QTK-AMP-01 / 0001	July, 2013
	Pre-Amplifier	QTK	AP-180C / CHM_0906076	Sep., 2012

- Note:
1. All equipments are calibrated every one year.
 2. The test instruments marked by "X" are used to measure the final test results.

3.2. Test Setup

Under 30MHz Test Setup

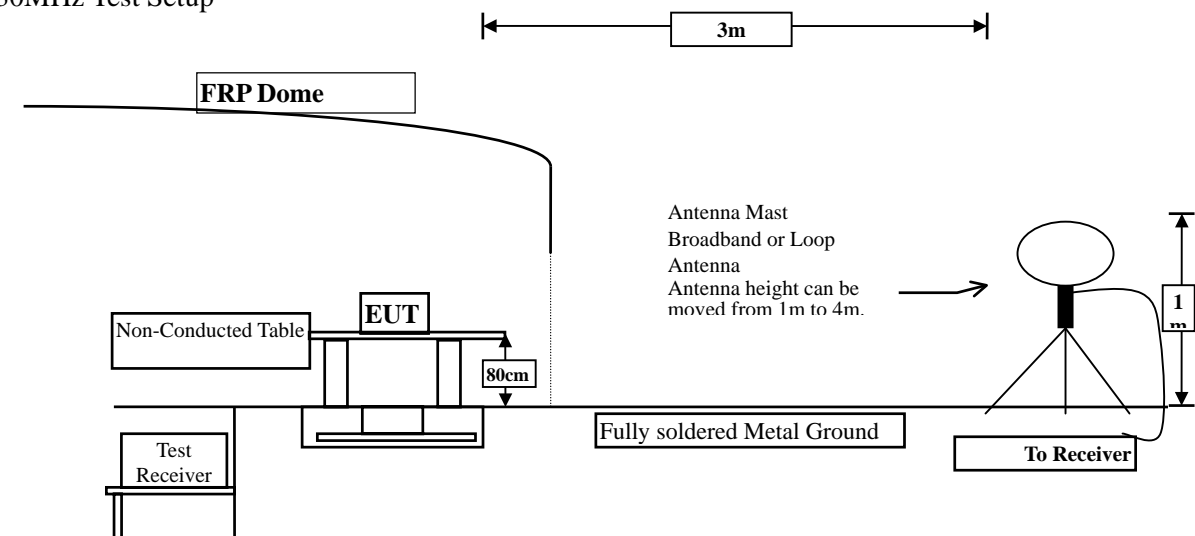

Above 30MHz Test Setup

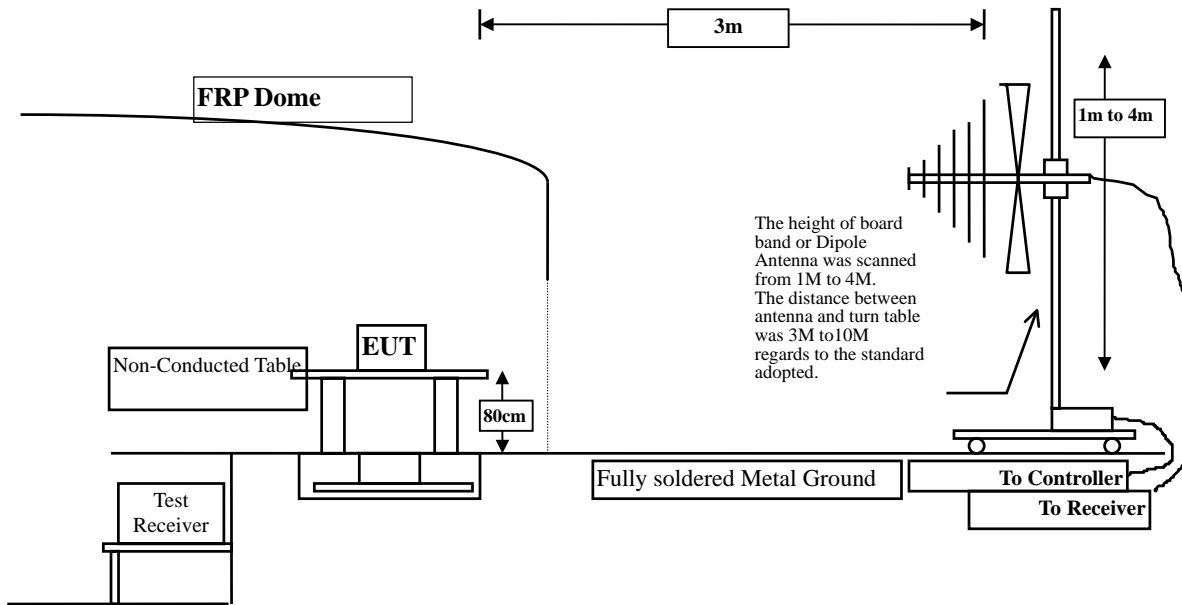

3.3. Limits

Frequency range	Limit (Quasi Peak)	Limit (Peak)	Measuring distance
150kHz to 300kHz	80dBuV/m to 52dBuV/m		3m
300kHz to 30MHz	52dBuV/m to 34dBuV/m		3m
30MHz to 1GHz	54dBuV	Not defined	3m
1GHz to 2GHz	Not defined	54dBuV	3m
156MHz to 165MHz	24dBuV/m	30dBuV	3m

3.4. Test Procedure

The EUT and its simulators are placed on a turn table which is 0.8 meter above ground. The turn table can rotate 360 degrees to determine the position of the maximum emission level. The EUT was positioned such that the distance from antenna to the EUT was 3 meters. The antenna can move up and down between 1 meter and 4 meters to find out the maximum emission level.

Both horizontal and vertical polarization of the antenna are set on measurement. In order to find the maximum emission, all of the interface cables must be manipulated according to ETSI EN 301 843-1: V1.2.1 (2004-06) on radiated measurement.

The measuring bandwidth shall be in accordance with table

Frequency range	Measuring bandwidth
30MHz to 2GHz	100kHz to 120kHz
156MHz to 165MHz	9kHz to 10kHz
150kHz to 30MHz	9kHz to 10kHz

3.5. Test Specification

According to ETSI EN 301 843-1: V1.2.1 (2004-06)

3.6. Uncertainty

± 3.8 dB

3.7. Test Result

The emission from the EUT is below the specified limits. The worst-case emissions are shown in section 10.2.

The EUT complies the acceptance criterion and passes the test.

4. Electrostatic Discharge (ESD)

4.1. Test Equipment

	Instrument	Manufacturer	Type No.	Serial No	Cal. Date
	ESD Simulator System	SCHAFFNER	NSG 438	695	May, 2013
X	ESD Simulator System	NoiseKen	TC-815R	ESS0929097	Aug, 2013
	ESD Simulator System	Thermo	MZ-15/EC/ TPC-2A	0510189/ 0510190	June, 2013
	ESD Simulator System	EM TEST	dito	V0635101749	Sep, 2012
X	Horizontal Coupling Plane (HCP)	Quietek	HCP AL50	N/A	N/A
X	Vertical Coupling Plane (VCP)	Quietek	VCP AL50	N/A	N/A

- Note: 1. All equipments are calibrated every one year.
 2. The test instruments marked by “X” are used to measure the final test results.

4.2. Test Setup

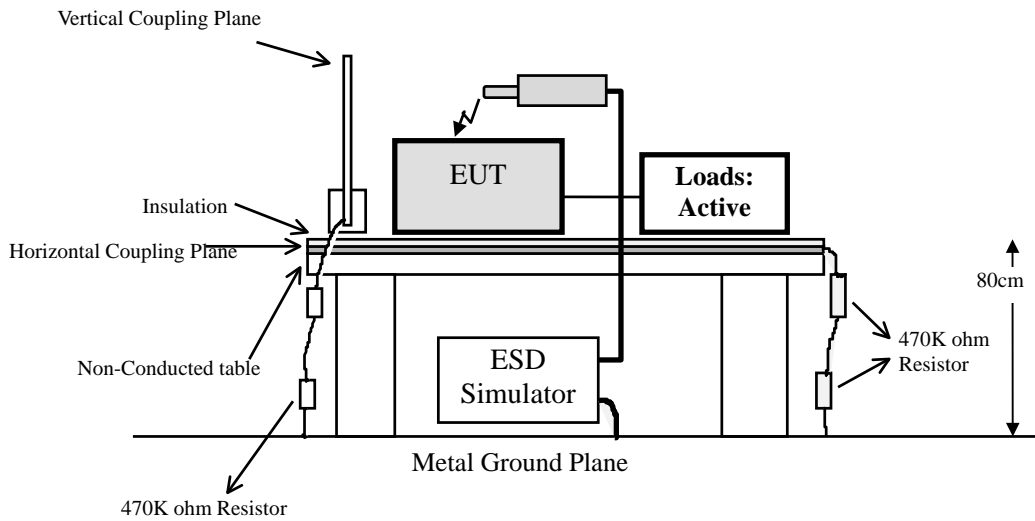

4.3. Test Level

Item	Environmental Phenomena	Units	Test Specification	Performance Criteria
Enclosure Port				
	Electrostatic Discharge	kV(Charge Voltage)	±8 (Air Discharge) ±6 (Contact Discharge)	B

4.4. Test Procedure

Direct application of discharges to the EUT:

Contact discharge was applied only to conductive surfaces of the EUT.

Air discharges were applied only to non-conductive surfaces of the EUT.

During the test, it was performed with single discharges. For the single discharge time between successive single discharges will be keep longer 1 second. It was at least ten single discharges with positive and negative at the same selected point.

The selected point, which was performed with electrostatic discharge, was marked on the red label of the EUT.

Indirect application of discharges to the EUT:

Vertical Coupling Plane (VCP):

The coupling plane, of dimensions 0.5m x 0.5m, is placed parallel to, and positioned at a distance 0.1m from, the EUT, with the Discharge Electrode touching the coupling plane.

The four faces of the EUT will be performed with electrostatic discharge. It was at least ten single discharges with positive and negative at the same selected point.

Horizontal Coupling Plane (HCP):

The coupling plane is placed under to the EUT. The generator shall be positioned vertically at a distance of 0.1m from the EUT, with the Discharge Electrode touching the coupling plane.

The four faces of the EUT will be performed with electrostatic discharge. It was at least ten single discharges with positive and negative at the same selected point.

4.5. Test Specification

According to IEC 61000-4-2 : 2008

4.6. Uncertainty

± 6.003 %

4.7. Test Result

The test result is shown in section 10.3.

The EUT complies the acceptance criterion and passes the test.

5. Radiated Susceptibility (RS)

5.1. Test Equipment

Item	Equipment	Manufacturer	Model No. / Serial No.	Last Cal.
1	Signal Generator	R & S	SML03/103330	Sep., 2012
2	Power Amplifier	Schaffner	CBA9413B/4020	N/A
3	Power Amplifier	A & R	30S1G3/309453	N/A
4	Biconilog Antenna	EMCO	3149/00071675	N/A
5	Power Meter	R & S	NRVD / 100219	Jan., 2013
6	Directional Coupler	A & R	DC6180/22735	N/A
7	Directional Coupler	A & R	DC7144A/312249	N/A
8	No.2 EMC Fully Chamber			

Note: All equipments are calibrated every one year.

5.2. Test Setup

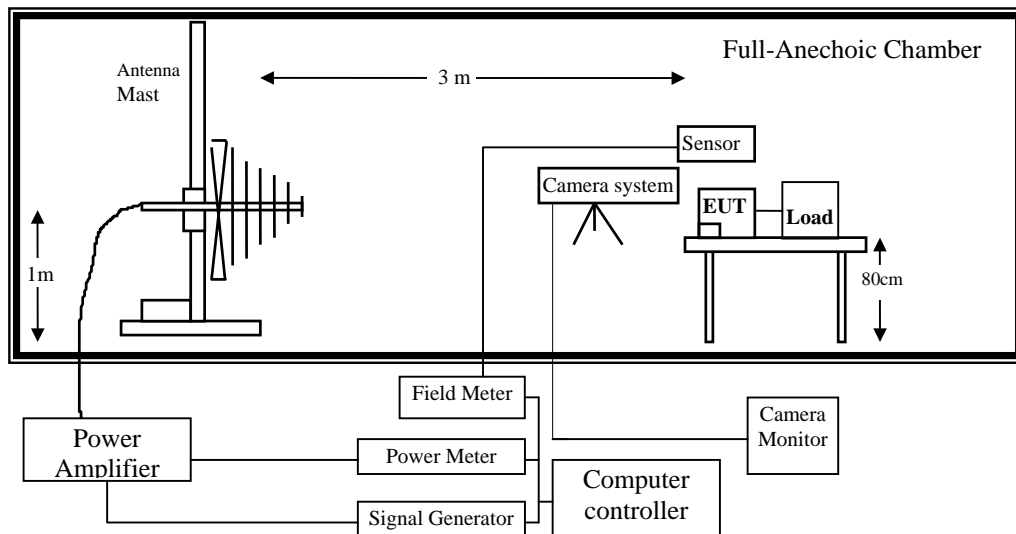

5.3. Test Level

Item	Environmental Phenomena	Units	Test Specification	Performance Criteria
Enclosure Port				
	Radio-Frequency	MHz	80-1000 1400-2000	A
	Electromagnetic Field	V/m(Un-modulated, rms)	10	
	Amplitude Modulated	% AM (400Hz)	80	

5.4. Test Procedure

The EUT and load, which are placed on a table that is 0.8 meter above ground, are placed with one coincident with the calibration plane such that the distance from antenna to the EUT was 3 meters.

Both horizontal and vertical polarization of the antenna and four sides of the EUT are set on measurement.

In order to judge the EUT performance, a CCD camera is used to monitor EUT screen.

All the scanning conditions are as follows:

Condition of Test	Remarks
1. Field Strength	10 V/m Level 2
2. Radiated Signal	AM 80% Modulated with 400Hz sinusoidal audio signal
3. Scanning Frequency	80MHz - 1000MHz, 1400MHz - 2000MHz
4. Dwell Time	3 Seconds
5. Frequency step size Δf :	1%
6. The rate of Swept of Frequency	1.5×10^{-3} decades/s

5.5. Test Specification

According to IEC 61000-4-3: 2010

5.6. Uncertainty

$\pm 6.17 \%$

5.7. Test Result

The test result is shown in section 10.4.

The EUT complies the acceptance criterion and passes the test.

6. Electrical Fast Transient/Burst (EFT/B)

6.1. Test Equipment

	Instrument	Manufacturer	Type No.	Serial No	Cal. Date
	Schaffner NSG 2050 System Mainframe	Schaffner	N/A	N/A	Jan, 2013
	EMC immunity system	Thermo	EMCPRO PLUS	0411225	Mar, 2013
X	TRANSIENT TEST SYSTEM	EMC PARTNET	TRA2000IN6	1138	Mar, 2013

- Note:
1. All equipments are calibrated every one year.
 2. The test instruments marked by "X" are used to measure the final test results.

6.2. Test Setup

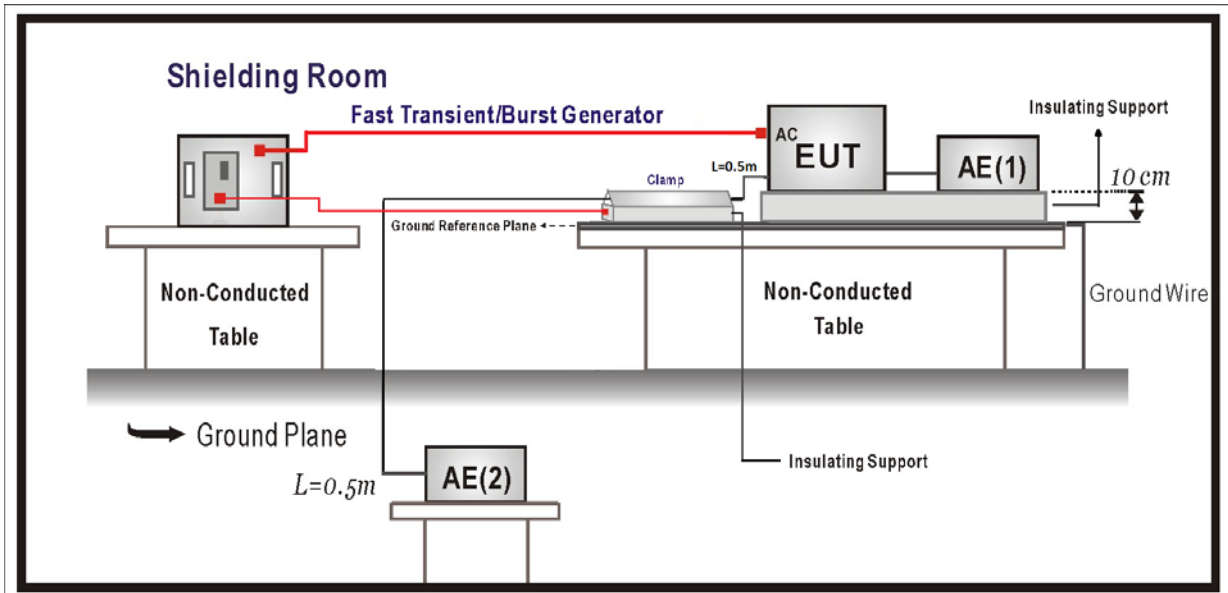

6.3. Test Level

Item	Environmental Phenomena	Units	Test Specification	Performance Criteria
Ports for signal lines and control lines				
	Fast Transients Common Mode	kV (Peak)	± 1	B
		Tr/Th ns	5/50	
		Rep. Frequency kHz	5	
Input DC Power Ports				
	Fast Transients Common Mode	kV (Peak)	± 1	B
		Tr/Th ns	5/50	
		Rep. Frequency kHz	5	
Input AC Power Ports				
	Fast Transients Common Mode	kV (Peak)	± 2	B
		Tr/Th ns	5/50	
		Rep. Frequency kHz	5	

6.4. Test Procedure

The EUT and load are placed on a table that is 0.8 meter above a metal ground plane measured 1m*1m min. and 0.65mm thick min. And projected beyond the EUT by at least 0.1m on all sides.

For Signal Ports and Telecommunication Ports:

The EFT interference signal is through a coupling clamp device couples to the signal and control lines of the EUT with burst noise for 1min.

For Input DC and AC Power Ports:

The EUT is connected to the power mains through a coupling device that directly couples the EFT interference signal.

Each of the Line and Neutral conductors is impressed with burst noise for 1 min.

The length of power cord between the coupling device and the EUT shall be 1m.

6.5. Test Specification

According to IEC 61000-4-4: 2012

6.6. Uncertainty

$\pm 8.80 \%$

6.7. Test Result

The test result is shown in section 10.5.

The EUT complies the acceptance criterion and passes the test.

7. Conducted Susceptibility (CS)

7.1. Test Equipment

Item	Equipment	Manufacturer	Model No. / Serial No.	Last Cal.
1	CS SYSTEM	SCHAFFNER	NSG 2070	March, 2013
2	CDN	SCHAFFNER	CDN M016S / 20822	Dec., 2012
3	CDN	SCHAFFNER	CDN M016S / 20823	Dec., 2012
4	FIXED PAD	SCHAFFNER	INA 2070-1 / 2115	N/A
5	EM Clamp		KEMZ 801 / 21024	March, 2013
6	No.6 Shielded Room			

Note: All equipments are calibrated every one year.

7.2. Test Setup

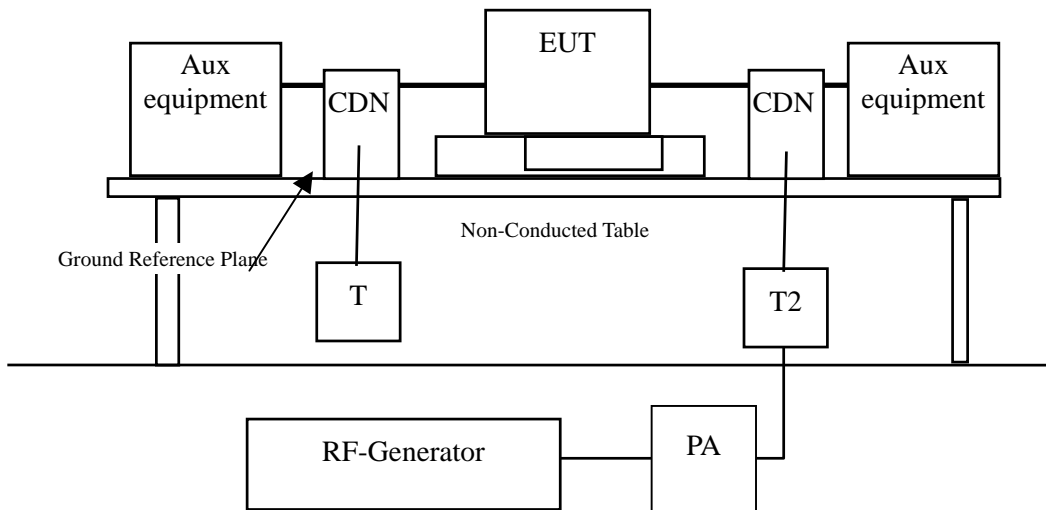

7.3. Test Level

Item	Environmental Phenomena	Units	Test Specification	Performance Criteria
AC Input and AC Output & DC Input and DC output Power Ports & Functional Earth Ports				
	Radio-Frequency	MHz	0.15-80	A
	Common Mode.	V (rms, Unmodulated)	3	
	Amplitude Modulated	% AM (1kHz)	80	
		Source Impedance Ω	150	

7.4. Test Procedure

The EUT are placed on a table that is 0.8 meter height, and a Ground reference plane on the table, EUT are placed upon table and use a 10cm insulation between the EUT and Ground reference plane.

For Signal Ports and Telecommunication Ports

The disturbance signal is through a coupling and decoupling networks (CDN) or EM-clamp device couples to the signal and Telecommunication lines of the EUT.

For Input DC and AC Power Ports

The EUT is connected to the power mains through a coupling and decoupling networks for power supply lines. And directly couples the disturbances signal into EUT.

Used CDN-M2 for two wires or CDN-M3 for three wires.

All the scanning conditions are as follows:

Condition of Test	Remarks
1. Field Strength	130dBuV(3V) Level 2
2. Radiated Signal	AM 80% Modulated with 400Hz sinusoidal audio signal
3. Scanning Frequency	0.15MHz – 80MHz
4 Dwell Time	3 Seconds
5. Frequency step size Δf :	1%
6. The rate of Swept of Frequency	1.5×10^{-3} decades/s

Additionally, a test shall be performed with a test level of 10V rms at the following frequencies;

Condition of Test	Remarks
1. Field Strength	140dBuV(10V) Level 2
2. Radiated Signal	AM 80% Modulated with 400Hz sinusoidal audio signal
3. Scanning Frequency	2MHz , 3MHz , 4MHz , 6.2MHz , 8.2MHz , 12.2MHz , 16.5MHz , 18.8MHz , 22MHz , 25MHz
4 Dwell Time	3 Seconds
5. Frequency step size Δf :	1%
6. The rate of Swept of Frequency	1.5×10^{-3} decades/s

7.5. Test Specification

According to IEC 61000-4-6 :2008

7.6. Uncertainty

$\pm 6.17 \%$

7.7. Test Result

The test result is shown in section 10.6.

The EUT complies the acceptance criterion and passes the test.

8. Power Supply Failure

8.1. Test Setup

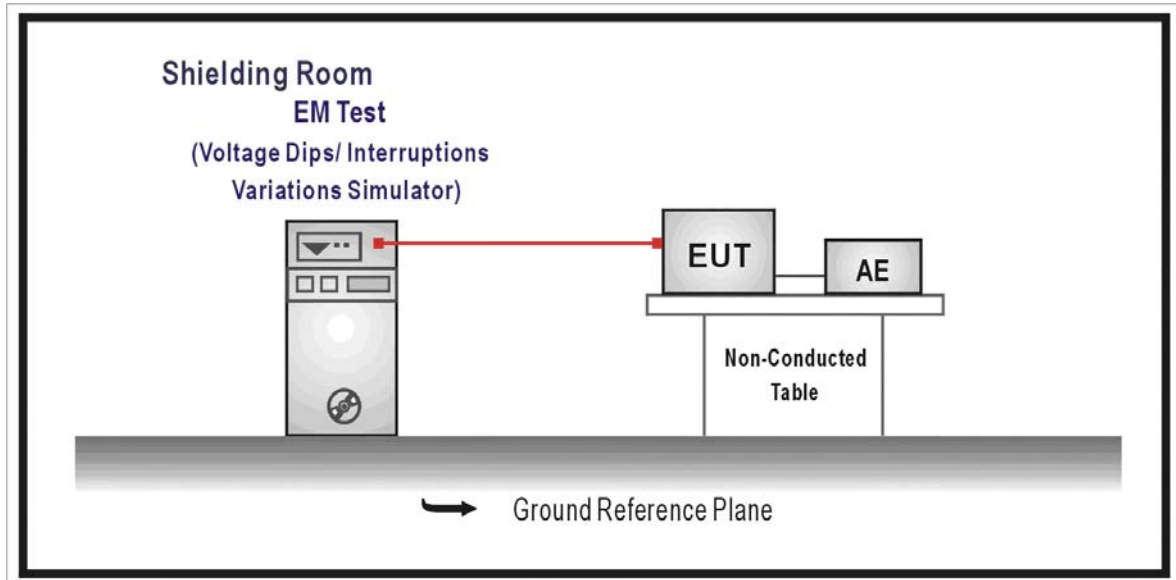

8.2. Test Procedure

The EUT and its load are placed on a table which is 0.8 meter above a metal ground plane.

The EUT shall be subjected to three breaks in power supply of duration 60 s each.

8.3. Test Specification

According to IEC 61000-4-11.

8.4. Test Result

The test result is shown in section 10.7.

The EUT complies the acceptance criterion and passes the test.

9. EMC Reduction Method During Compliance Testing

No modification was made during testing.

10. Test Result

The test results in the emission and the immunity were performed according to the requirements of measurement standard and process. Quietek Corporation is assumed full responsibility for the accuracy and completeness of these measurements. The test data of the emission is listed as below. All the tests were carried out with the EUT in normal operation, which was defined as:

EMI Mode	Normal Operation (VHF Mode)
EMS Mode	Normal Operation (VHF Mode)

10.1. Test Data of Conducted Emission

Product : AIS Class B Transponder
 Test Item : Conducted Emission
 Test Site : No.1 Shielded Room
 Test Mode : Normal Operation (VHF Mode) (DC 12V)

Frequency MHz	Correct Factor dB	Reading Level dBuV	Measurement Level dBuV	Margin dB	Limit dBuV
LINE (+)					
Quasi-Peak					
0.014	5.152	48.280	53.432	-41.252	94.684
0.058	0.526	37.090	37.616	-42.468	80.084
0.543	0.150	39.640	39.790	-10.210	50.000
5.308	0.212	34.860	35.072	-14.928	50.000
13.154	0.479	40.590	41.069	-8.931	50.000
26.787	0.900	40.530	41.430	-8.570	50.000
LINE (-)					
Quasi-Peak					
0.014	5.077	48.400	53.477	-41.207	94.684
0.060	0.510	20.710	21.220	-58.464	79.684
0.542	0.220	35.110	35.330	-14.670	50.000
5.301	0.262	34.720	34.982	-15.018	50.000
13.396	0.504	45.010	45.514	-4.486	50.000
26.435	0.850	40.030	40.880	-9.120	50.000

Note:

1. All Reading Levels are Quasi-Peak value.
2. "■" means the worst emission level.
3. Measurement Level = Reading Level + Correct Factor

Product : AIS Class B Transponder
 Test Item : Conducted Emission
 Test Site : No.1 Shielded Room
 Test Mode : Normal Operation (VHF Mode) (DC 24V)

Frequency MHz	Correct Factor dB	Reading Level dBuV	Measurement Level dBuV	Margin dB	Limit dBuV
LINE (+)					
Quasi-Peak					
0.018	4.472	49.620	54.092	-39.288	93.381
0.058	0.527	38.060	38.587	-41.517	80.105
0.543	0.150	39.640	39.790	-10.210	50.000
5.296	0.212	35.420	35.632	-14.368	50.000
13.392	0.484	43.880	44.364	-5.636	50.000
26.418	0.890	42.490	43.380	-6.620	50.000
LINE (-)					
Quasi-Peak					
0.018	4.464	46.060	50.524	-42.977	93.501
0.058	0.528	40.360	40.888	-39.196	80.084
0.543	0.220	34.860	35.080	-14.920	50.000
5.345	0.263	34.120	34.383	-15.617	50.000
13.490	0.516	45.150	45.666	-4.334	50.000
26.417	0.850	41.110	41.960	-8.040	50.000

Note:

1. All Reading Levels are Quasi-Peak value.
2. "■" means the worst emission level.
3. Measurement Level = Reading Level + Correct Factor

10.2. Test Data of Radiated Emission

Product : AIS Class B Transponder
 Test Item : General Radiated Emission
 Test Site : No.3 OATS
 Test Mode : Normal Operation (VHF Mode) (DC 12V)

Frequency MHz	Correct Factor dB	Reading Level dBuV	Measurement Level dBuV/m	Margin dB	Limit dBuV/m
(Loop Antenna)					
0.150	-3.780	30.680	26.900	-53.100	80.000
1.881	-3.962	36.850	32.888	-11.937	44.825
5.702	-3.729	29.860	26.131	-14.359	40.490
6.478	-3.590	32.960	29.370	-10.621	39.991
8.524	-3.391	25.060	21.669	-17.249	38.918
10.246	-3.256	24.860	21.604	-16.595	38.199
(Loop Antenna)					
0.929	-4.041	25.370	21.329	-26.253	47.582
2.000	-3.965	35.530	31.565	-13.020	44.585
5.808	-3.708	29.350	25.642	-14.776	40.418
6.478	-3.590	36.540	32.950	-7.041	39.991
10.496	-3.240	21.510	18.270	-19.835	38.105
21.594	-3.047	18.150	15.103	-20.183	35.285

Note:

1. All Reading Levels are Quasi-Peak value.
2. "■" means the worst emission level.
3. Measurement Level = Reading Level + Correct Factor

Product : AIS Class B Transponder
 Test Item : General Radiated Emission
 Test Site : No.3 OATS
 Test Mode : Normal Operation (VHF Mode) (DC 24V)

Frequency MHz	Correct Factor dB	Reading Level dBuV	Measurement Level dBuV/m	Margin dB	Limit dBuV/m
(Loop Antenna)					
0.150	-3.780	30.270	26.490	-53.510	80.000
0.866	-4.039	24.120	20.081	-27.775	47.856
1.941	-3.964	22.170	18.206	-26.496	44.702
6.596	-3.570	29.680	26.110	-13.810	39.921
6.980	-3.506	27.610	24.104	-15.595	39.699
19.353	-2.890	14.620	11.730	-23.983	35.713
(Loop Antenna)					
0.508	-3.933	25.560	21.627	-28.314	49.941
1.881	-3.962	36.570	32.608	-12.217	44.825
5.626	-3.741	28.550	24.808	-15.734	40.542
6.418	-3.600	36.230	32.630	-7.397	40.027
10.456	-3.242	21.970	18.728	-19.392	38.120
21.221	-3.015	17.260	14.245	-21.108	35.353

Note:

1. All Reading Levels are Quasi-Peak value.
2. "■" means the worst emission level.
3. Measurement Level = Reading Level + Correct Factor

Product : AIS Class B Transponder
 Test Item : General Radiated Emission
 Test Site : No.3 OATS
 Test Mode : Normal Operation (VHF Mode) (DC 12V)

Frequency MHz	Correct Factor dB	Reading Level dBuV	Measurement Level dBuV/m	Margin dB	Limit dBuV/m
Horizontal					
144.010	-18.317	51.330	33.013	-20.987	54.000
156.000	-18.679	41.000	22.321	-1.679	24.000
192.000	-19.259	52.300	33.041	-20.959	54.000
288.000	-14.260	54.500	40.239	-13.761	54.000
312.000	-13.339	52.300	38.962	-15.038	54.000
468.000	-8.399	43.900	35.502	-18.498	54.000
624.000	-5.362	40.140	34.777	-19.223	54.000
739.000	-3.822	46.700	42.879	-11.121	54.000
862.000	-1.660	41.400	39.740	-14.260	54.000
982.000	-0.062	42.780	42.719	-11.281	54.000
Vertical					
54.300	-22.522	57.000	34.478	-19.522	54.000
144.000	-18.316	56.000	37.684	-16.316	54.000
158.000	-18.689	41.100	22.410	-1.590	24.000
192.000	-19.259	53.000	33.741	-20.259	54.000
288.000	-14.260	53.200	38.939	-15.061	54.000
312.000	-13.339	54.500	41.162	-12.838	54.000
468.000	-8.399	52.000	43.602	-10.398	54.000
624.000	-5.362	43.000	37.637	-16.363	54.000
739.000	-3.822	49.000	45.179	-8.821	54.000
982.000	-0.062	40.000	39.939	-14.061	54.000

Note:

1. All Reading Levels are Quasi-Peak value.
2. "■" means the worst emission level.
3. Measurement Level = Reading Level + Correct Factor

Product : AIS Class B Transponder
 Test Item : General Radiated Emission
 Test Site : No.3 OATS
 Test Mode : Normal Operation (VHF Mode) (DC 24V)

Frequency MHz	Correct Factor dB	Reading Level dBuV	Measurement Level dBuV/m	Margin dB	Limit dBuV/m
Horizontal					
144.000	-18.316	51.240	32.924	-21.076	54.000
156.010	-18.679	41.250	22.571	-1.429	24.000
192.010	-19.258	52.140	32.882	-21.118	54.000
288.000	-14.260	54.470	40.209	-13.791	54.000
312.000	-13.339	52.400	39.062	-14.938	54.000
468.010	-8.397	44.000	35.602	-18.398	54.000
624.010	-5.362	40.300	34.938	-19.062	54.000
739.010	-3.822	46.600	42.779	-11.221	54.000
862.010	-1.660	40.900	39.240	-14.760	54.000
982.010	-0.060	42.690	42.629	-11.371	54.000
Vertical					
54.200	-22.498	56.990	34.492	-19.508	54.000
144.010	-18.317	56.200	37.883	-16.117	54.000
158.010	-18.689	41.300	22.610	-1.390	24.000
192.010	-19.258	52.850	33.592	-20.408	54.000
288.010	-14.260	53.310	39.050	-14.950	54.000
312.010	-13.338	54.440	41.102	-12.898	54.000
468.010	-8.397	52.400	44.002	-9.998	54.000
624.010	-5.362	43.130	37.768	-16.232	54.000
739.010	-3.822	49.100	45.279	-8.721	54.000
982.010	-0.060	40.220	40.159	-13.841	54.000

Note:

1. All Reading Levels are Quasi-Peak value.
2. "■" means the worst emission level.
3. Measurement Level = Reading Level + Correct Factor

Product : AIS Class B Transponder
 Test Item : General Radiated Emission
 Test Site : No.3 OATS
 Test Mode : Normal Operation (VHF Mode) (DC 12V)

Frequency MHz	Correct Factor dB	Reading Level dBuV	Measurement Level dBuV/m	Margin dB	Limit dBuV/m
Horizontal					
Peak Detector:					
1000.000	-6.701	51.120	44.419	-9.581	54.000
1041.000	-6.520	46.110	39.590	-14.410	54.000
1103.000	-6.148	44.290	38.142	-15.858	54.000
1328.000	-5.005	45.370	40.365	-13.635	54.000
1662.000	-3.744	48.970	45.226	-8.774	54.000
1684.000	-3.887	49.270	45.383	-8.617	54.000

Average Detector

--

Vertical

1000.000	-6.701	48.370	41.669	-12.331	54.000
1332.000	-5.090	46.680	41.590	-12.410	54.000
1498.000	-4.513	46.680	42.167	-11.833	54.000
1552.000	-4.459	48.160	43.702	-10.298	54.000
1620.000	-4.169	47.370	43.202	-10.798	54.000
1664.000	-3.698	52.330	48.632	-5.368	54.000

Average Detector

--

Note:

1. All Reading Levels are Peak value.
2. "■" means the worst emission level.
3. Measurement Level = Reading Level + Correct Factor

Product : AIS Class B Transponder
 Test Item : General Radiated Emission
 Test Site : No.3 OATS
 Test Mode : Normal Operation (VHF Mode) (DC 24V)

Frequency MHz	Correct Factor dB	Reading Level dBuV	Measurement Level dBuV/m	Margin dB	Limit dBuV/m
Horizontal					
Peak Detector:					
1000.000	-6.701	49.380	42.679	-11.321	54.000
1023.000	-6.633	45.270	38.636	-15.364	54.000
1054.000	-6.395	43.610	37.215	-16.785	54.000
1329.000	-5.027	41.670	36.644	-17.356	54.000
1664.000	-3.698	46.380	42.682	-11.318	54.000
1676.000	-3.800	45.630	41.830	-12.170	54.000
Average Detector					
--					
Vertical					
1000.000	-6.701	48.910	42.209	-11.791	54.000
1068.000	-6.520	48.520	42.000	-12.000	54.000
1500.000	-4.487	48.270	43.783	-10.217	54.000
1598.000	-4.119	49.340	45.221	-8.779	54.000
1650.000	-4.025	49.380	45.355	-8.645	54.000
1660.000	-3.791	51.600	47.809	-6.191	54.000
Average Detector					
--					

Note:

1. All Reading Levels are Peak value.
2. "■" means the worst emission level.
3. Measurement Level = Reading Level + Correct Factor

10.3. Test Data of Electrostatic Discharge

Product : AIS Class B Transponder
 Test Item : Electrostatic Discharge
 Test Site : No.3 Shielded Room
 Test Mode : Normal Operation (VHF Mode) (DC 12V)

Item	Amount of Discharge	Voltage	Required Criteria	Complied To Criteria (A, B, C)	Results
Air Discharge	10	+2kV, +4kV, +8kV	B	A	Pass
	10	-2kV, -4kV, -8kV	B	A	Pass
Contact Discharge	25	+2kV,+4kV, +6kV	B	A	Pass
	25	-2kV,-4kV, -6kV	B	A	Pass
Indirect Discharge (HCP)	25	+2kV,+4kV, +6kV	B	A	Pass
	25	-2kV,-4kV, -6kV	B	A	Pass
Indirect Discharge (VCP Front)	25	+2kV,+4kV, +6kV	B	A	Pass
	25	-2kV,-4kV, -6kV	B	A	Pass
Indirect Discharge (VCP Left)	25	+2kV,+4kV, +6kV	B	A	Pass
	25	-2kV,-4kV, -6kV	B	A	Pass
Indirect Discharge (VCP Back)	25	+2kV,+4kV, +6kV	B	A	Pass
	25	-2kV,-4kV, -6kV	B	A	Pass
Indirect Discharge (VCP Right)	25	+2kV,+4kV, +6kV	B	A	Pass
	25	-2kV,-4kV, -6kV	B	A	Pass

Note:

The testing performed is from lowest level up to the highest level as required by standard, but only highest level is shown on the report.

NR: No Requirement

- Meet criteria A: Operate as intended during and after the test
- Meet criteria B: Operate as intended after the test
- Meet criteria C: Loss/Error of function
- Additional Information
 - EUT stopped operation and could / could not be reset by operator at ____ kV.
 - No false alarms or other malfunctions were observed during or after the test.

Product : AIS Class B Transponder
 Test Item : Electrostatic Discharge
 Test Site : No.3 Shielded Room
 Test Mode : Normal Operation (VHF Mode) (DC 24V)

Item	Amount of Discharge	Voltage	Required Criteria	Complied To Criteria (A, B, C)	Results
Air Discharge	10	+2kV, +4kV, +8kV	B	A	Pass
	10	-2kV, -4kV, -8kV	B	A	Pass
Contact Discharge	25	+2kV,+4kV, +6kV	B	A	Pass
	25	-2kV,-4kV, -6kV	B	A	Pass
Indirect Discharge (HCP)	25	+2kV,+4kV, +6kV	B	A	Pass
	25	-2kV,-4kV, -6kV	B	A	Pass
Indirect Discharge (VCP Front)	25	+2kV,+4kV, +6kV	B	A	Pass
	25	-2kV,-4kV, -6kV	B	A	Pass
Indirect Discharge (VCP Left)	25	+2kV,+4kV, +6kV	B	A	Pass
	25	-2kV,-4kV, -6kV	B	A	Pass
Indirect Discharge (VCP Back)	25	+2kV,+4kV, +6kV	B	A	Pass
	25	-2kV,-4kV, -6kV	B	A	Pass
Indirect Discharge (VCP Right)	25	+2kV,+4kV, +6kV	B	A	Pass
	25	-2kV,-4kV, -6kV	B	A	Pass

Note:

The testing performed is from lowest level up to the highest level as required by standard, but only highest level is shown on the report.

NR: No Requirement

- Meet criteria A: Operate as intended during and after the test
- Meet criteria B: Operate as intended after the test
- Meet criteria C: Loss/Error of function
- Additional Information
 - EUT stopped operation and could / could not be reset by operator at ____ kV.
 - No false alarms or other malfunctions were observed during or after the test.

10.4. Test Data of Radiated Susceptibility

Product : AIS Class B Transponder
 Test Item : Radiated Susceptibility
 Test Site : No.2 EMC fully Chamber
 Test Mode : Normal Operation (VHF Mode) (DC 12V)

Frequency (MHz)	Position (Angle)	Polarity (H or V)	Field Strength (V/m)	Required Criteria	Complied To Criteria (A, B, C)	Results
80-1000	0°	H	10	A	A	Pass
80-1000	0°	V	10	A	A	Pass
80-1000	90°	H	10	A	A	Pass
80-1000	90°	V	10	A	A	Pass
80-1000	180°	H	10	A	A	Pass
80-1000	180°	V	10	A	A	Pass
80-1000	270°	H	10	A	A	Pass
80-1000	270°	V	10	A	A	Pass
1000-2000	0°	H	10	A	A	Pass
1000-2000	0°	V	10	A	A	Pass
1000-2000	90°	H	10	A	A	Pass
1000-2000	90°	V	10	A	A	Pass
1000-2000	180°	H	10	A	A	Pass
1000-2000	180°	V	10	A	A	Pass
1000-2000	270°	H	10	A	A	Pass
1000-2000	270°	V	10	A	A	Pass

Note:

- The exclusion band=center frequency±50kHz for Transmitter.

- Meet criteria A: Operate as intended during and after the test
- Meet criteria B: Operate as intended after the test
- Meet criteria C: Loss/Error of function
- Additional Information
 - There was no observable degradation in performance.
 - EUT stopped operation and could / could not be reset by operator at _____ V/m at frequency _____MHz.
 - No false alarms or other malfunctions were observed during or after the test.

Product : AIS Class B Transponder
 Test Item : Radiated Susceptibility
 Test Site : No.2 EMC fully Chamber
 Test Mode : Normal Operation (VHF Mode) (DC 24V)

Frequency (MHz)	Position (Angle)	Polarity (H or V)	Field Strength (V/m)	Required Criteria	Complied To Criteria (A, B, C)	Results
80-1000	0°	H	10	A	A	Pass
80-1000	0°	V	10	A	A	Pass
80-1000	90°	H	10	A	A	Pass
80-1000	90°	V	10	A	A	Pass
80-1000	180°	H	10	A	A	Pass
80-1000	180°	V	10	A	A	Pass
80-1000	270°	H	10	A	A	Pass
80-1000	270°	V	10	A	A	Pass
1000-2000	0°	H	10	A	A	Pass
1000-2000	0°	V	10	A	A	Pass
1000-2000	90°	H	10	A	A	Pass
1000-2000	90°	V	10	A	A	Pass
1000-2000	180°	H	10	A	A	Pass
1000-2000	180°	V	10	A	A	Pass
1000-2000	270°	H	10	A	A	Pass
1000-2000	270°	V	10	A	A	Pass

Note:

1. The exclusion band=center frequency±50kHz for Transmitter.

- Meet criteria A: Operate as intended during and after the test
- Meet criteria B: Operate as intended after the test
- Meet criteria C: Loss/Error of function
- Additional Information
 - There was no observable degradation in performance.
 - EUT stopped operation and could / could not be reset by operator at _____ V/m at frequency _____MHz.
 - No false alarms or other malfunctions were observed during or after the test.

10.5. Test Data of Electrical Fast Transient

Product : AIS Class B Transponder
 Test Item : Electrical Fast Transient
 Test Site : No.3 Shielded Room
 Test Mode : Normal Operation (VHF Mode) (DC 12V)

Inject Line	Polarity	Voltage (kV)	Inject Time (Minute)	Inject Method	Required Criteria	Complied to Criteria	Result
Power	±	2kV	3	Direct	B	A	Pass
PowerGround	±	2kV	3	Direct	B	A	Pass
Power-Power Ground	±	2kV	3	Direct	B	A	Pass
VHF	±	1kV	3	Clamp	B	A	Pass
GPS	±	1kV	3	Clamp	B	A	Pass
NMEA0183	±	1kV	3	Clamp	B	A	Pass
NMEA2000	±	1kV	3	Clamp	B	A	Pass

Note:

The testing performed is from lowest level up to the highest level as required by standard, but only highest level is shown on the report.

- Meet criteria A : Operate as intended during and after the test
- Meet criteria B : Operate as intended after the test
- Meet criteria C : Loss/Error of function
- Additional Information
 - EUT stopped operation and could / could not be reset by operator at _____ kV of Line _____.
- No false alarms or other malfunctions were observed during or after the test.

Product : AIS Class B Transponder
 Test Item : Electrical Fast Transient
 Test Site : No.3 Shielded Room
 Test Mode : Normal Operation (VHF Mode) (DC 24V)

Inject Line	Polarity	Voltage (kV)	Inject Time (Minute)	Inject Method	Required Criteria	Complied to Criteria	Result
Power	±	2kV	3	Direct	B	A	Pass
PowerGround	±	2kV	3	Direct	B	A	Pass
Power-Power Ground	±	2kV	3	Direct	B	A	Pass
VHF	±	1kV	3	Clamp	B	A	Pass
GPS	±	1kV	3	Clamp	B	A	Pass
NMEA0183	±	1kV	3	Clamp	B	A	Pass
NMEA2000	±	1kV	3	Clamp	B	A	Pass

Note:

The testing performed is from lowest level up to the highest level as required by standard, but only highest level is shown on the report.

- Meet criteria A : Operate as intended during and after the test
- Meet criteria B : Operate as intended after the test
- Meet criteria C : Loss/Error of function
- Additional Information
 - EUT stopped operation and could / could not be reset by operator at _____ kV of Line _____.
- No false alarms or other malfunctions were observed during or after the test.

10.6. Test Data of Conducted Susceptibility

Product : AIS Class B Transponder
 Test Item : Conducted Susceptibility
 Test Site : No.2 EMC fully Chamber
 Test Mode : Normal Operation (VHF Mode) (DC 12V)

Frequency Range (MHz)	Voltage Applied (dBuV(V))	Inject Method	Tested Port of EUT	Required Criteria	Performance Criteria Complied To	Result
0.15~80	130(3V)	CDN	DC 12V	A	A	PASS
2	140(10V)	CDN	DC 12V	A	A	PASS
3	140(10V)	CDN	DC 12V	A	A	PASS
4	140(10V)	CDN	DC 12V	A	A	PASS
6.2	140(10V)	CDN	DC 12V	A	A	PASS
8.2	140(10V)	CDN	DC 12V	A	A	PASS
12.6	140(10V)	CDN	DC 12V	A	A	PASS
16.3	140(10V)	CDN	DC 12V	A	A	PASS
18.8	140(10V)	CDN	DC 12V	A	A	PASS
22	140(10V)	CDN	DC 12V	A	A	PASS
25	140(10V)	CDN	DC 12V	A	A	PASS
0.15~80	130(3V)	Clamp	ANT IN	A	A	PASS
2	140(10V)	Clamp	ANT IN	A	A	PASS
3	140(10V)	Clamp	ANT IN	A	A	PASS
4	140(10V)	Clamp	ANT IN	A	A	PASS
6.2	140(10V)	Clamp	ANT IN	A	A	PASS
8.2	140(10V)	Clamp	ANT IN	A	A	PASS
12.6	140(10V)	Clamp	ANT IN	A	A	PASS
16.3	140(10V)	Clamp	ANT IN	A	A	PASS
18.8	140(10V)	Clamp	ANT IN	A	A	PASS
22	140(10V)	Clamp	ANT IN	A	A	PASS
25	140(10V)	Clamp	ANT IN	A	A	PASS

Note:

The testing performed is from lowest level up to the highest level as required by standard, but only highest level is shown on the report.

- Meet criteria A: Operate as intended during and after the test
- Meet criteria B: Operate as intended after the test
- Meet criteria C: Loss/Error of function
- Additional Information
 - EUT stopped operation and could / could not be reset by operator at _____ kV of Line _____.
 - No false alarms or other malfunctions were observed during or after the test. The acceptance criteria were met, and the EUT passed the test.

Product : AIS Class B Transponder
 Test Item : Conducted Susceptibility
 Test Site : No.2 EMC fully Chamber
 Test Mode : Normal Operation (VHF Mode) (DC 24V)

Frequency Range (MHz)	Voltage Applied (dBuV(V))	Inject Method	Tested Port of EUT	Required Criteria	Performance Criteria Complied To	Result
0.15~80	130(3V)	CDN	DC 24V	A	A	PASS
2	140(10V)	CDN	DC 24V	A	A	PASS
3	140(10V)	CDN	DC 24V	A	A	PASS
4	140(10V)	CDN	DC 24V	A	A	PASS
6.2	140(10V)	CDN	DC 24V	A	A	PASS
8.2	140(10V)	CDN	DC 24V	A	A	PASS
12.6	140(10V)	CDN	DC 24V	A	A	PASS
16.3	140(10V)	CDN	DC 24V	A	A	PASS
18.8	140(10V)	CDN	DC 24V	A	A	PASS
22	140(10V)	CDN	DC 24V	A	A	PASS
25	140(10V)	CDN	DC 24V	A	A	PASS
0.15~80	130(3V)	Clamp	ANT IN	A	A	PASS
2	140(10V)	Clamp	ANT IN	A	A	PASS
3	140(10V)	Clamp	ANT IN	A	A	PASS
4	140(10V)	Clamp	ANT IN	A	A	PASS
6.2	140(10V)	Clamp	ANT IN	A	A	PASS
8.2	140(10V)	Clamp	ANT IN	A	A	PASS
12.6	140(10V)	Clamp	ANT IN	A	A	PASS
16.3	140(10V)	Clamp	ANT IN	A	A	PASS
18.8	140(10V)	Clamp	ANT IN	A	A	PASS
22	140(10V)	Clamp	ANT IN	A	A	PASS
25	140(10V)	Clamp	ANT IN	A	A	PASS

Note:

The testing performed is from lowest level up to the highest level as required by standard, but only highest level is shown on the report.

- Meet criteria A: Operate as intended during and after the test
- Meet criteria B: Operate as intended after the test
- Meet criteria C: Loss/Error of function
- Additional Information
 - EUT stopped operation and could / could not be reset by operator at _____ kV of Line _____.
- No false alarms or other malfunctions were observed during or after the test. The acceptance criteria were met, and the EUT passed the test.

10.7. Test Data of Power Supply Failure

Product : AIS Class B Transponder
Test Item : Power Supply Failure
Test Site : No.2 EMC fully Chamber
Test Mode : Normal Operation (VHF Mode) (DC 12V)

Voltage Interruptions (DC)	Reduction (%)	Duration (s)	Test Result
	100	60	PASS

Product : AIS Class B Transponder
Test Item : Power Supply Failure
Test Site : No.2 EMC fully Chamber
Test Mode : Normal Operation (VHF Mode) (DC 24V)

Voltage Interruptions (DC)	Reduction (%)	Duration (s)	Test Result
	100	60	PASS

Attachment 1: EUT Test Setup Photographs

Attachment 1: EUT Test Setup Photographs

Front View of Conducted Test



Back View of Conducted Test



Front View of Radiated Test (Loop)

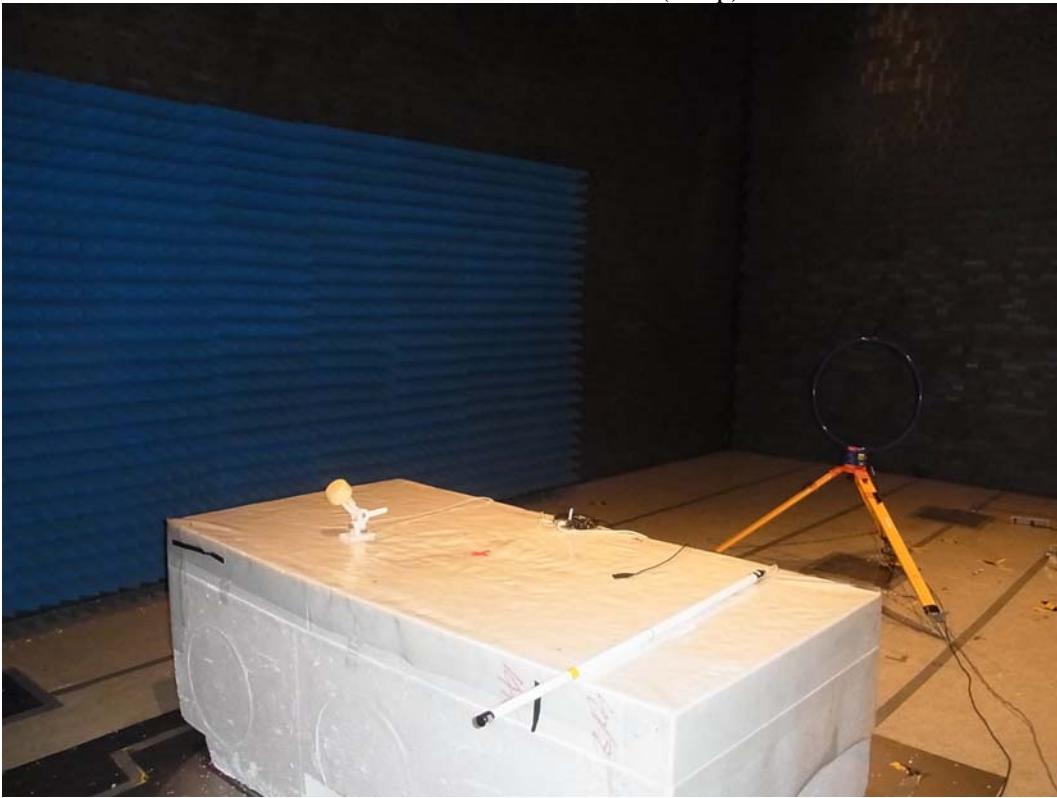

Back View of Radiated Test (Loop)



Front View of Radiated Test



Back View of Radiated Test



Front View of High Frequency Radiated Test



ESD Test Setup

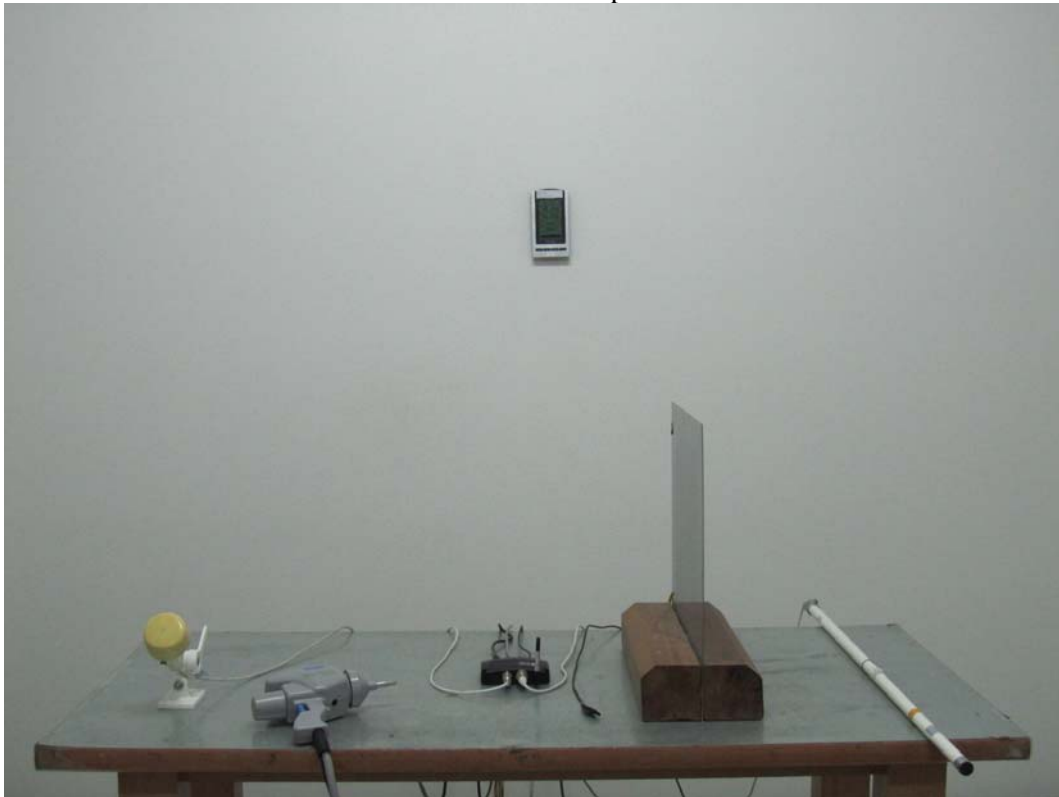

Radiated Susceptibility Test Setup



EFT/B Test Setup



EFT/B Test Setup – Clamp



Conducted Susceptibility Test Setup - Clamp



Power supply failure Test Setup



Attachment 2: EUT Detailed Photographs

Attachment 2 : EUT Detailed Photographs

(1) EUT Photo



(2) EUT Photo



(3) EUT Photo



(4) EUT Photo



(5) EUT Photo



(6) EUT Photo

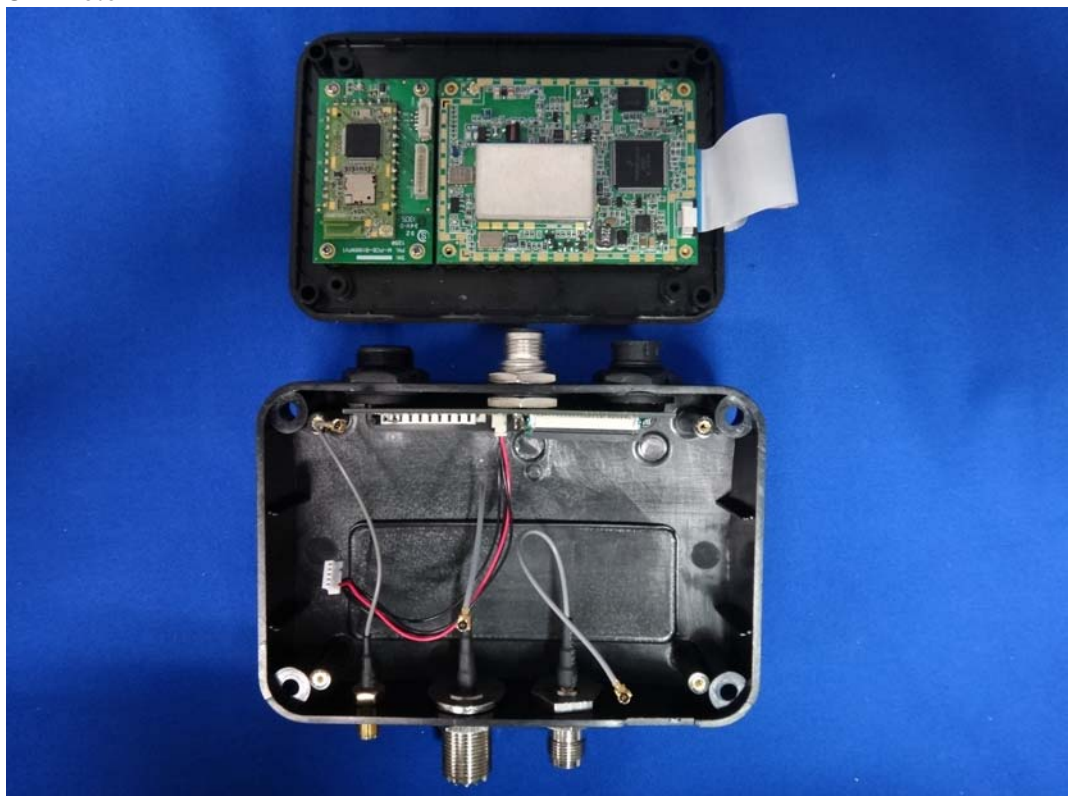

(7) EUT Photo



(8) EUT Photo



(9) EUT Photo

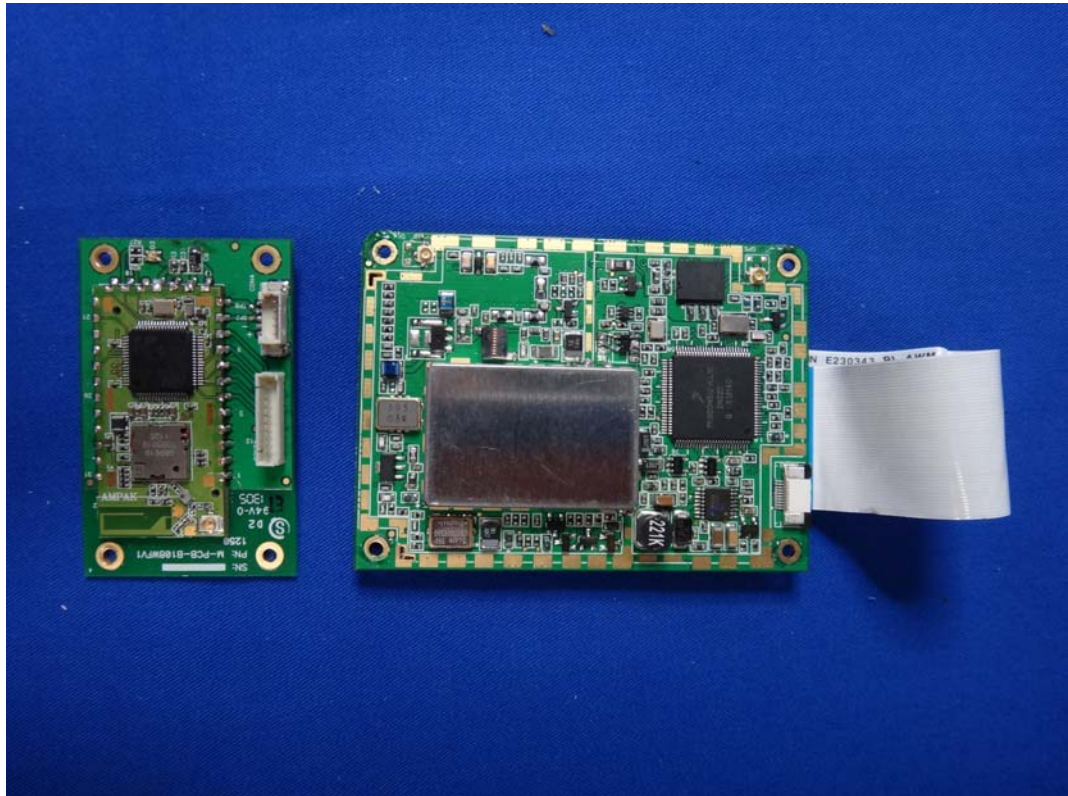

(10) EUT Photo

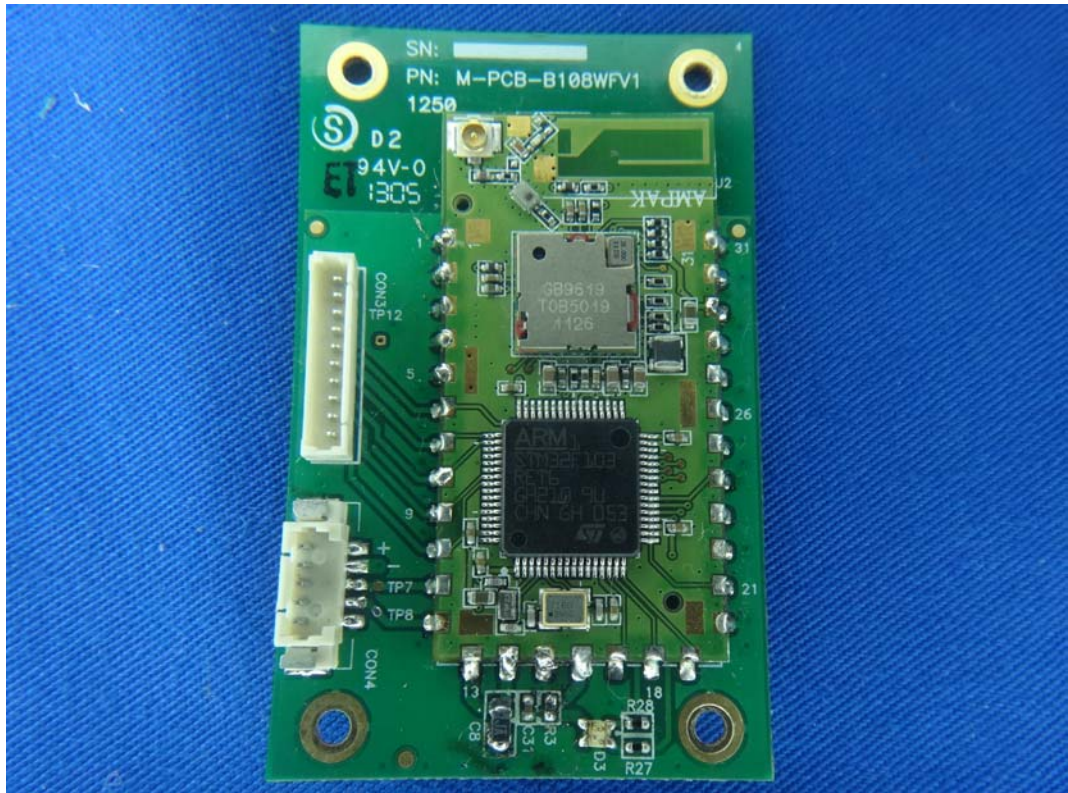

(11) EUT Photo

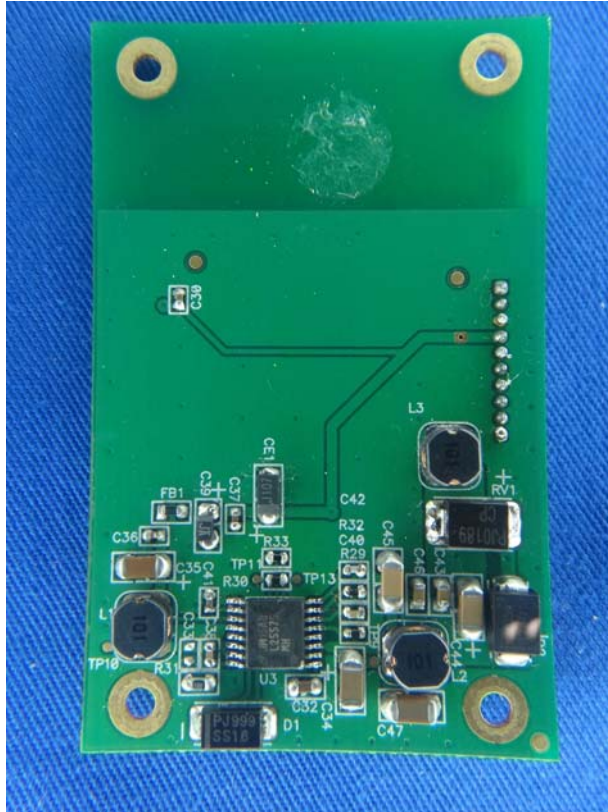

(12) EUT Photo

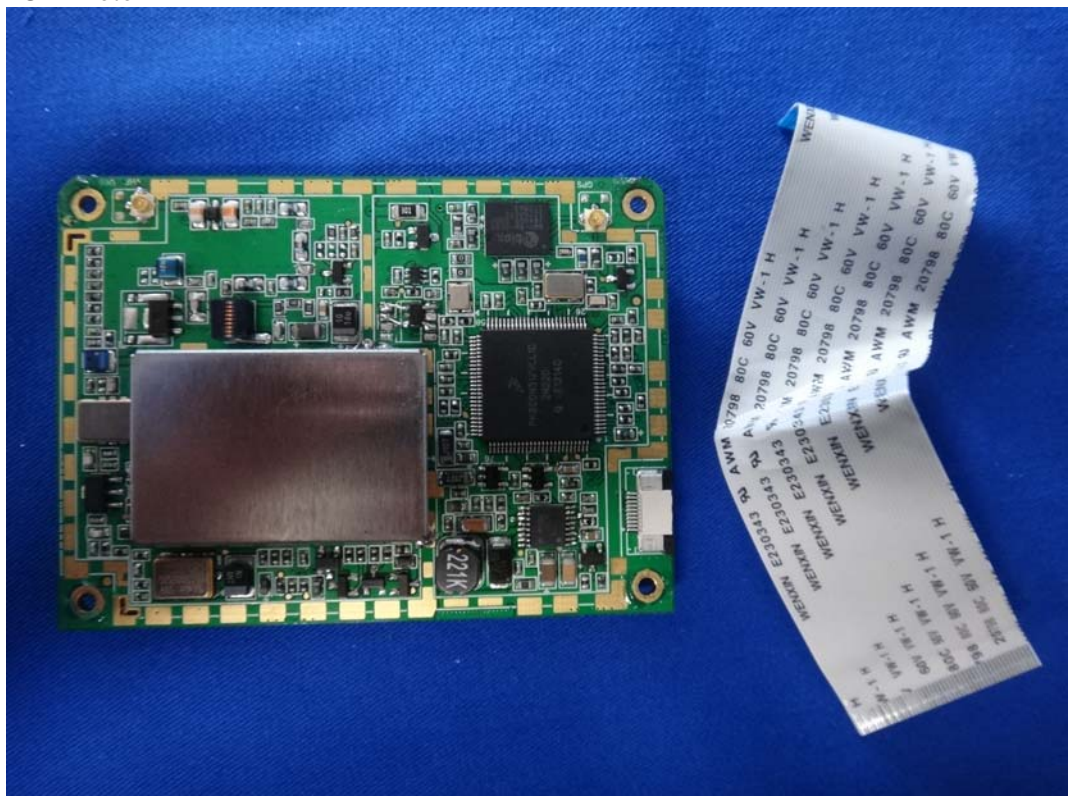

(13) EUT Photo

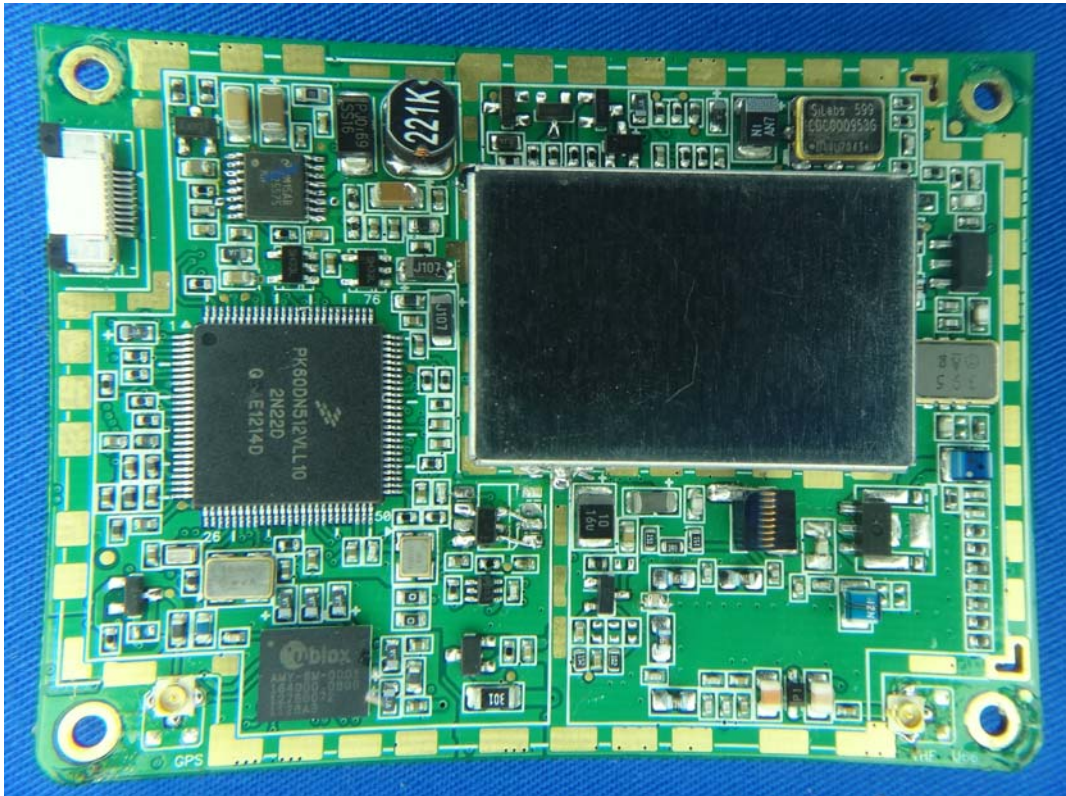

(14) EUT Photo

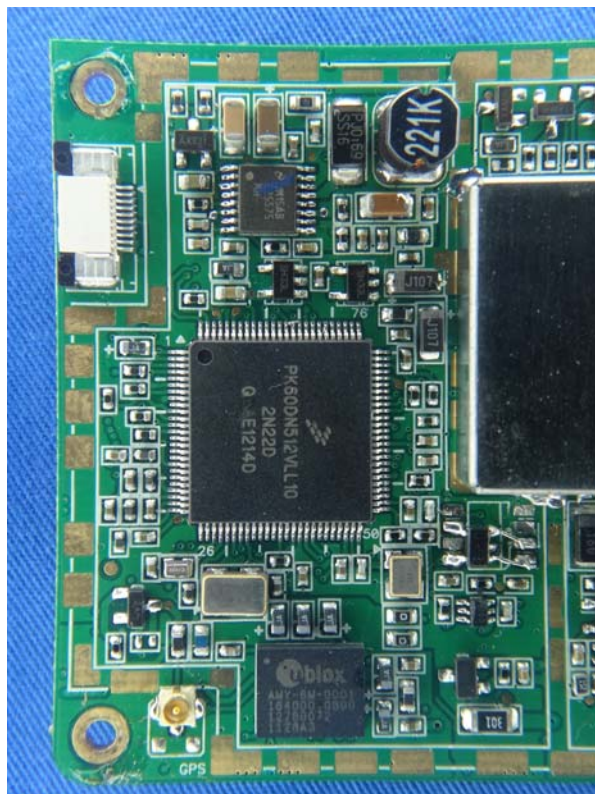

(15) EUT Photo



(16) EUT Photo

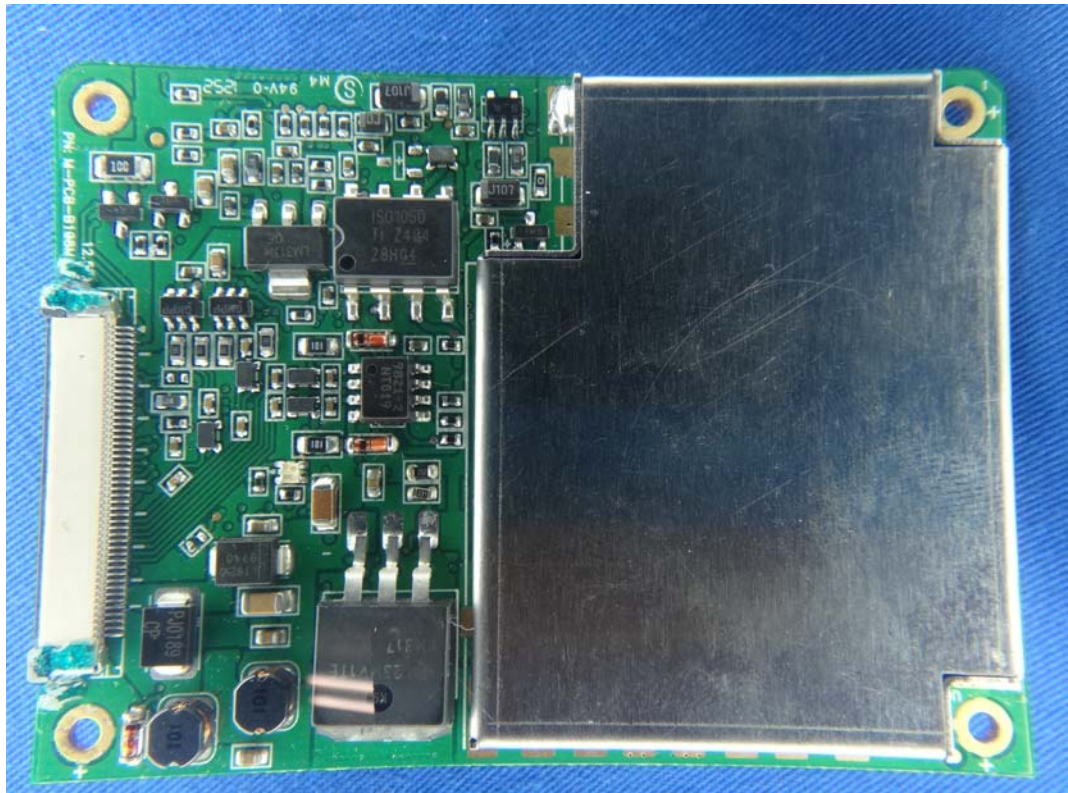

(17) EUT Photo

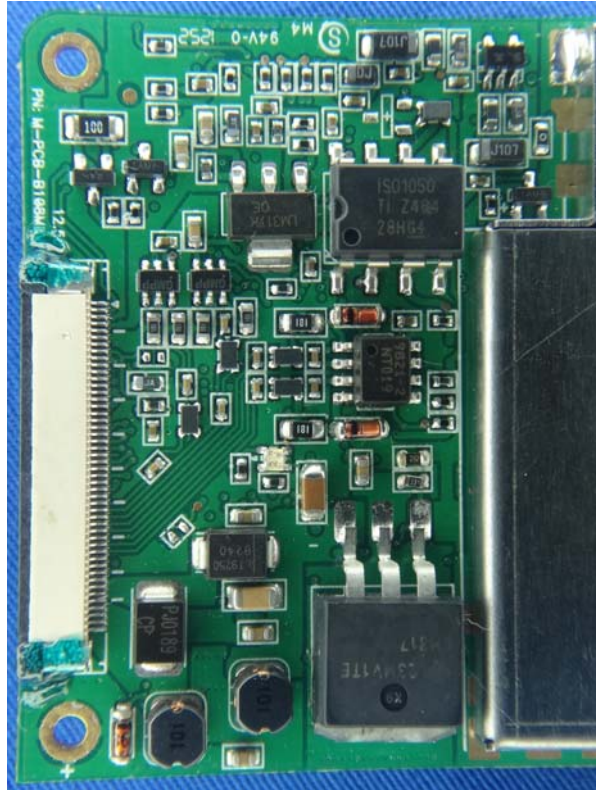

(18) EUT Photo (WLAN –ANT)



(19) EUT Photo (GPS Antenna-10m)



(20) EUT Photo (GPS Antenna-10m)



(21) EUT Photo (VHF Antenna)

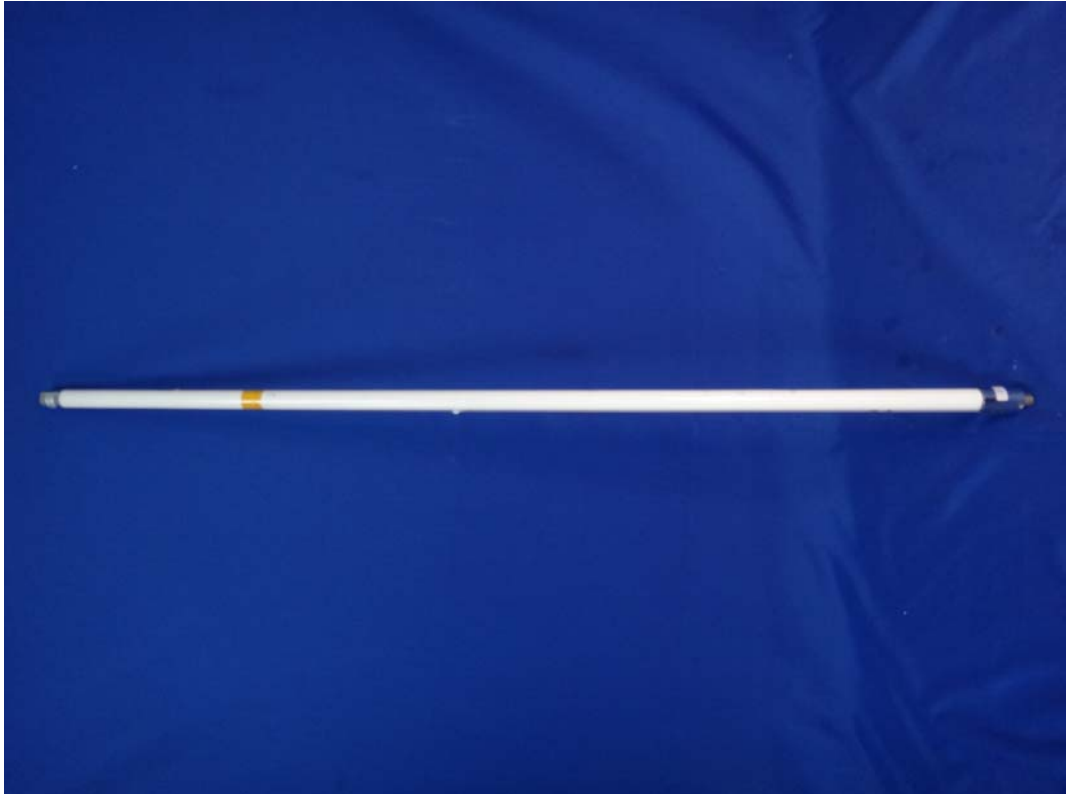

(22) EUT Photo (VHF Antenna)

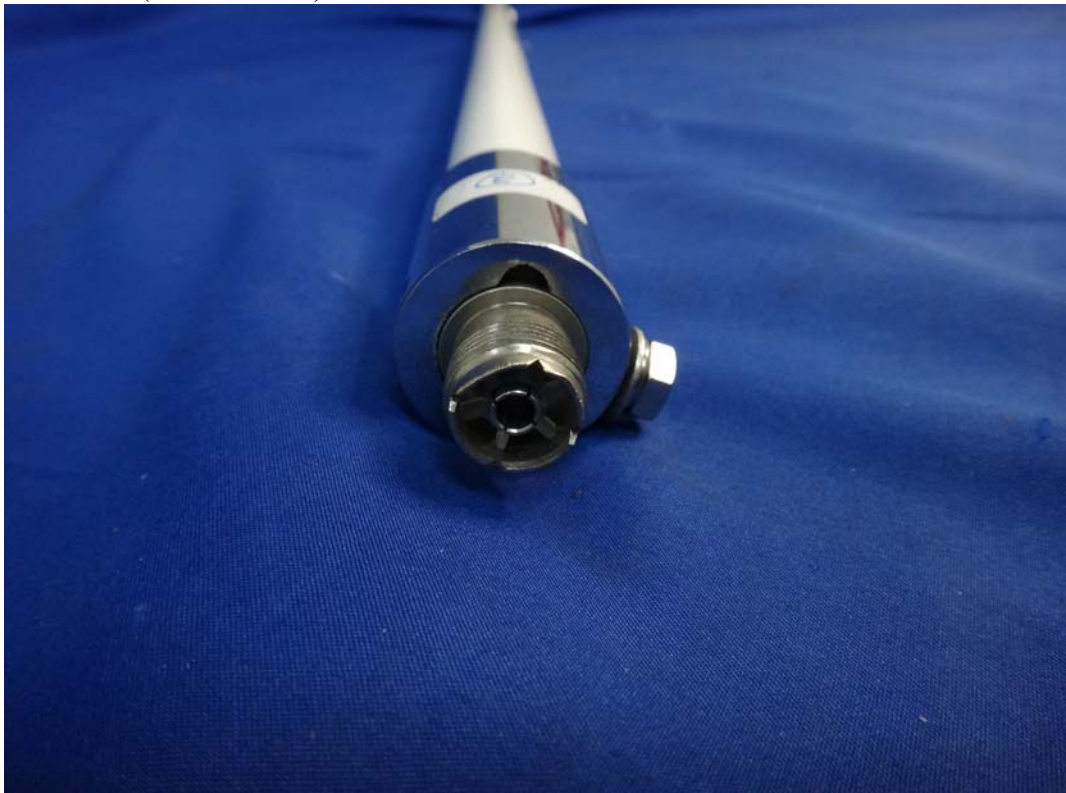

(23) EUT Photo (VHF Antenna Cable-10m)

