

CE Test Report

Product Name	AIS Class B Transponder
Model No.	CAMINO-108, CAMINO-108W

Applicant	Alltek Marine Electronics Corp.
Address	7F, No.605, Ruei Guang Rd., Neihu, Taipei, Taiwan, 114 R.O.C.

Date of Receipt	May 06, 2013
Issued Date	Oct. 21, 2013
Report No.	135096R-RFCEP71V01
Report Version	V2.0



The test results relate only to the samples tested.
The test report shall not be reproduced except in full without the written approval of Quietek Corporation.
This report must not be used to claim product endorsement by TAF or any agency of the Government.

Test Report Certification

Issued Date : Oct. 21, 2013

Report No. : 135096R-RFCEP71V01



Product Name	AIS Class B Transponder
Applicant	Alltek Marine Electronics Corp.
Address	7F, No.605, Ruei Guang Rd., Neihu, Taipei, Taiwan, 114 R.O.C.
Manufacturer	Alltek Marine Electronics Corp.
Model No.	CAMINO-108, CAMINO-108W
EUT Rated Voltage	DC 9.6~31.2V
EUT Test Voltage	DC 12/24V
Trade Name	AMEC
Applicable Standard	ETSI EN 300 440-1:V1.6.1 (2010-08) ETSI EN 300 440-2:V1.4.1 (2010-08)
Test Result	Complied

The test results relate only to the samples tested.

The test report shall not be reproduced except in full without the written approval of Quietek Corporation.

This report must not be used to claim product endorsement by TAF or any agency of the Government.

Documented By : Jinn Chen
(Senior Adm. Specialist / Jinn Chen)

Tested By : Andy Lin
(Assistant Engineer / Andy Lin)

Approved By : [Signature]
(Manager / Vincent Lin)

TABLE OF CONTENTS

Description	Page
1. General Information	5
1.1. EUT Description.....	5
1.2. Test Mode	6
1.3. Tested System Details.....	7
1.4. EUT Test Setup Environment & Configuration of AIS System	7
1.5. EUT Operation Procedures.....	8
1.6. Test Facility	9
2. Spurious radiation (Receiver)	10
2.1. Test Equipment.....	10
2.2. Test Setup	11
2.3. Test Condition	12
2.4. Limits	12
2.5. Test Procedure	12
2.6. Test Specification	12
2.7. Uncertainty	12
2.8. Test Result	13
2.9. Test Photo	17
3. Measurement Uncertainty Values.....	19
Attachment: EUT Detailed Photographs	20

Revision History

Rev.	Issue Date	Revisions	Effect page
V1.0	August 20, 2013	Initial Issue	All
V2.0	October 21, 2013	1) Add Revision History 2) Modify section 1.3 Tested System Details 3) Modify section 1.4 EUT Test Setup Environment & Configuration of AIS System 4) Modify section 1.5 EUT Operation Procedures	4, 7, 8

1. General Information

1.1. EUT Description

Product Name	AIS Class B Transponder
Trade Name	AMEC
Model No.	CAMINO-108, CAMINO-108W
Frequency Range	1575.42MHz
Antenna Type	Dielectric Patch antenna
Type of Modulation	Phase Modulation
VHF Cable	Shielded, 10m
GPS Cable	Shielded, 10m
Hardware	M-PCB-B108MBV1
Software	V1.2.6

Working Frequency of Each Channel	
Channel	Frequency
01	1575.42MHz

Note:

1. The EUT is a AIS Class B Transponder with a built-in GPS receiver at 1575.42MHz (L1).
2. The operation voltage is evaluated at both DC 12V and 24V. DC 24V is worst case, through pre-testing. Only worst case is shown in the report.
2. This device is a composite device in accordance with ETSI regulations. The EMC was measured and made a test report that the report number is 135096R-RFCEP02V01.

1.2. Test Mode

QuieTek verified the construction and function in typical operation. All the test modes were carried out with the EUT in normal operation, which was shown in this test report and defined as:

Final Test Mode
Receive Mode

1.3. Tested System Details

The types for all equipment, plus descriptions of all cables used in the tested system (including SD cards) are:

Product	Manufacturer	Model No.	Serial No.	Power Cord
1 DC 12V Battery	TRANE	12B50PE	N/A	N/A
2 DC 12V Battery	Chen Guang	66N50	N/A	N/A
3 Notebook PC	DELL	PPT	N/A	N/A
4 AIS Transponders	AMEC	CAMINO-101 / CAMINO-701	N/A	Non-shielded, 1.8m
5 GPS Simulator	Agilent	E4438C	N/A	Non-shielded, 1.8m

Signal Cable Type	Signal cable Description
A Power Cable	Non-shielded, 0.9m
B Power Cable	Non-shielded, 0.9m
C Power/Data Cable	Shielded, 1.4m
D RS232 Cable	Shielded, 1.2m
E VHF cable	Shielded, 10m
F GPS cable	Shielded, 10m

1.4. EUT Test Setup Environment & Configuration of AIS System

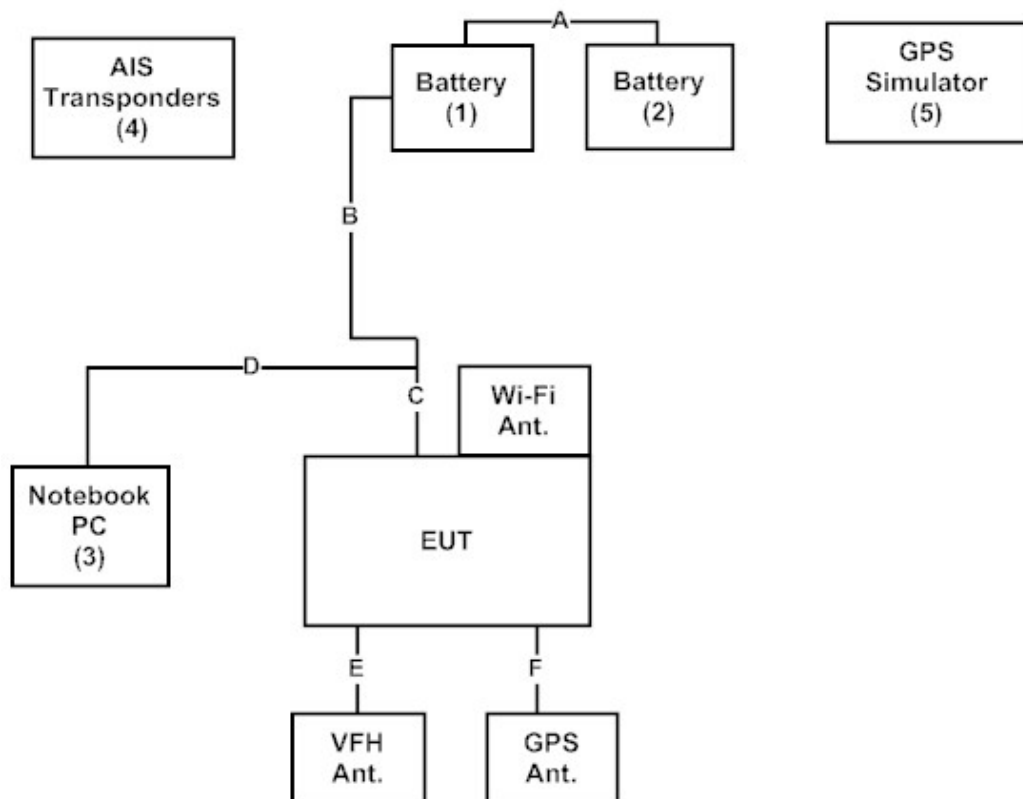

1.5. EUT Operation Procedures

1	Setup the EUT and simulators as shown in section 1.4.
2	Execute "GPS Test Software" on the Notebook PC.
3	Configure the test mode.
4	Verify that the EUT works properly.

1.6. Test Facility

Ambient conditions in the laboratory:

Items	Required	Actual
Temperature (°C)	15-35	20-35
Humidity (%RH)	25-75	50-65
Barometric pressure (mbar)	860-1060	950-1000

The related certificate for our laboratories about the test site and management system can be downloaded from Quietek Corporation's Web Site: <http://www.quietek.com/tw/ctg/cts/accreditations.htm>

The address and introduction of Quietek Corporation's laboratories can be founded in our Web site:

<http://www.quietek.com/>

Site Description: Accredited by TAF
Accredited Number: 0914

Site Name: Quietek Corporation
Site Address: No.5-22, Ruishukeng,
Linkou Dist. New Taipei City 24451,
Taiwan, R.O.C.
TEL : 886-2-8601-3788 / FAX : 886-2-8601-3789
E-Mail : service@quietek.com

2. Spurious radiation (Receiver)

2.1. Test Equipment

The following test equipment are used during the test:

Item		Equipment	Manufacturer	Model No. / Serial No.	Last Cal.
1	X	Test Receiver	R & S	ESI 26 / 838786/004	May, 2013
2	X	Spectrum Analyzer	Agilent	E4407B / US39440758	May, 2013
3	X	Bilog Antenna	SCHAFFNER	CBL6112B / 2697	May, 2013
4	X	Horn Antenna	Schwarzbeck	BBHA9120D / 305, 306	July, 2013
5		Horn Antenna	Schwarzbeck	BBHA9170 / 208, 209	July, 2013
6	X	Pre-Amplifier	QTK	QTK-AMP-01 / 0001	July, 2013
7	X	Pre-Amplifier	QTK	AP-180C / CHM_0906076	Sep., 2012
		No.3 OATS			

- Note:
1. All equipments are calibrated every one year.
 2. The test instruments marked by "X" are used to measure the final test results.

2.2. Test Setup

Under 1GHz Test Setup:

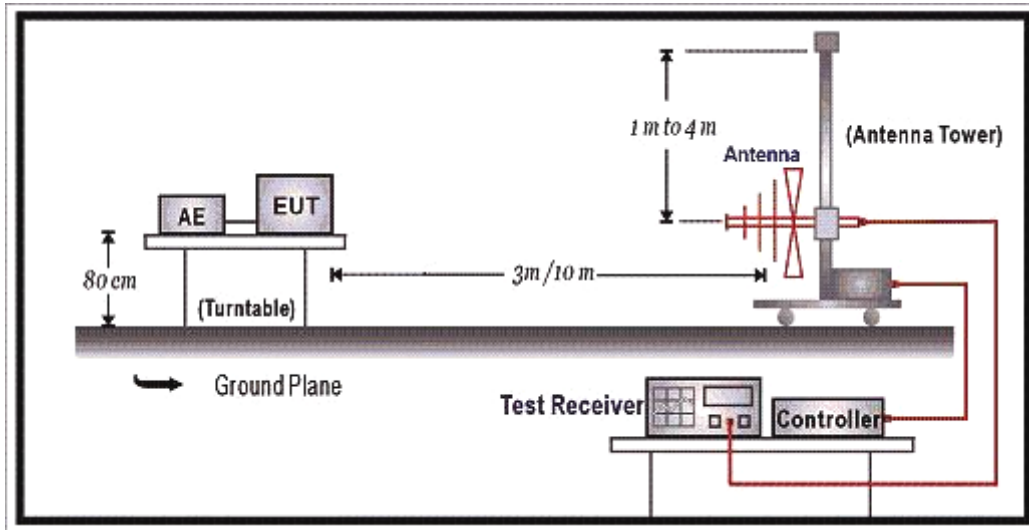

Above 1GHz Test Setup:

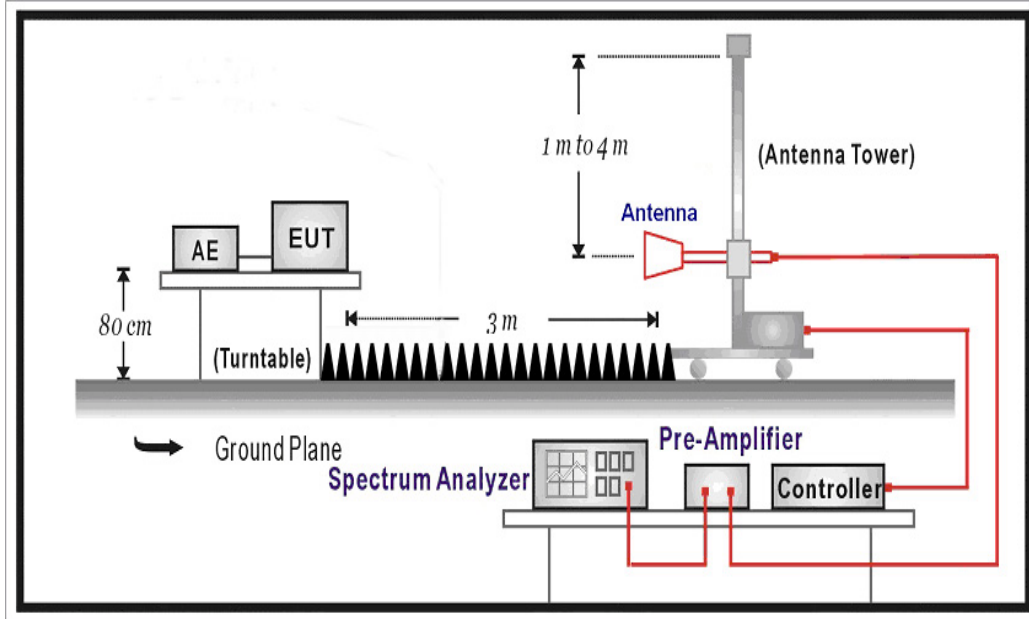

2.3. Test Condition

Standard Temperature and Humidity, Standard Test Voltage

2.4. Limits

The power of any spurious emission, radiated or conducted, shall not exceed the values given below:

- 2 nW below 1000 MHz
- 20 nW above 1000 MHz

2.5. Test Procedure

The EUT and its simulators are placed on a turn table which is 1.5 meters above ground. The turn table can rotate 360 degrees to determine the position of the maximum emission level. The EUT was positioned such that the distance from antenna to the EUT was 3 meters. The antenna can move up and down between 1 meter and 4 meters to find out the maximum emission level.

Broadband antenna (calibrated bi-log and horn antenna) are used as a receiving antenna.

Both horizontal and vertical polarization of the antenna are set on measurement. And a high frequency preamplifier were used increase the sensitivity of the measuring. In order to find the maximum emission, all of the interface cables must be manipulated according to ETSI EN 300 440-1 V1.6.1 (2010-08), ETSI EN 300 440-2 V1.4.1 (2010-08) on radiated measurement.

The additional notch filter below 1GHz was used to measure the level of harmonics radiated emission during field strength of harmonics measurement. The bandwidth setting on the field strength meter is 1 MHz.

2.6. Test Specification

According to ETSI EN 300 440-1 V1.6.1 (2010-08), ETSI EN 300 440-2 V1.4.1 (2010-08)

2.7. Uncertainty

The measurement uncertainty above 1G is defined as ± 3.9 dB
under 1G is defined as ± 3.8 dB

2.8. Test Result

Product	AIS Class B Transponder		
Test Mode	Receive Mode		
Test Condition	Spurious emissions		
Date of Test	2013/07/24	Test Site	No.3 OATS

Channel 1

Frequency (MHz)	Correction factor (dBm)	Reading Level (dBm)	Measure Level (dB)	Margin (dB)	Limit (dBm)
Peak Detector (Horizontal)					
132.820	-0.736	-59.584	-60.320	-3.320	-57.000
336.520	2.743	-64.581	-61.838	-4.838	-57.000
528.580	7.187	-69.739	-62.552	-5.552	-57.000
662.440	7.984	-71.320	-63.336	-6.336	-57.000
769.140	7.847	-73.404	-65.557	-8.557	-57.000
903.000	9.789	-73.537	-63.748	-6.748	-57.000

Note:

1. “ ” means the worst emission level.
2. Emission Level = Reading Level + Correction Factor

Product	AIS Class B Transponder		
Test Mode	Receive Mode		
Test Condition	Spurious emissions		
Date of Test	2013/07/24	Test Site	No.3 OATS

Channel 1

Frequency (MHz)	Correction factor (dBm)	Reading Level (dBm)	Measure Level (dB)	Margin (dB)	Limit (dBm)
Peak Detector (Vertical)					
175.500	-0.638	-64.350	-64.988	-7.988	-57.000
359.800	3.023	-66.634	-63.611	-6.611	-57.000
528.580	5.840	-72.612	-66.772	-9.772	-57.000
664.380	7.289	-71.876	-64.587	-7.587	-57.000
780.780	8.224	-71.108	-62.884	-5.884	-57.000
920.460	8.330	-72.194	-63.864	-6.864	-57.000

Note:

1. “ ” means the worst emission level.
2. Emission Level = Reading Level + Correction Factor

Product	AIS Class B Transponder		
Test Mode	Receive Mode		
Test Condition	Spurious emissions		
Date of Test	2013/07/24	Test Site	No.3 OATS

Channel 1

Frequency (MHz)	Correction factor (dBm)	Reading Level (dBm)	Measure Level (dB)	Margin (dB)	Limit (dBm)
Peak Detector (Horizontal)					
1060.000	7.612	-63.147	-55.535	-8.535	-47.000
1680.000	8.320	-61.629	-53.309	-6.309	-47.000
2490.000	11.654	-66.471	-54.817	-7.817	-47.000

Note:

1. “ ” means the worst emission level.
2. Emission Level = Reading Level + Correction Factor

Product	AIS Class B Transponder		
Test Mode	Receive Mode		
Test Condition	Spurious emissions		
Date of Test	2013/07/24	Test Site	No.3 OATS

Channel 1

Frequency (MHz)	Correction factor (dBm)	Reading Level (dBm)	Measure Level (dB)	Margin (dB)	Limit (dBm)
Peak Detector (Vertical)					
1200.000	7.939	-60.916	-52.977	-5.977	-47.000
1680.000	7.830	-63.202	-55.372	-8.372	-47.000
3090.000	13.574	-65.161	-51.587	-4.587	-47.000

Note:

1. “  ” means the worst emission level.
2. Emission Level = Reading Level + Correction Factor

2.9. Test Photo

Test Mode : Receive Mode

Description : Front View of Spurious emissions Test

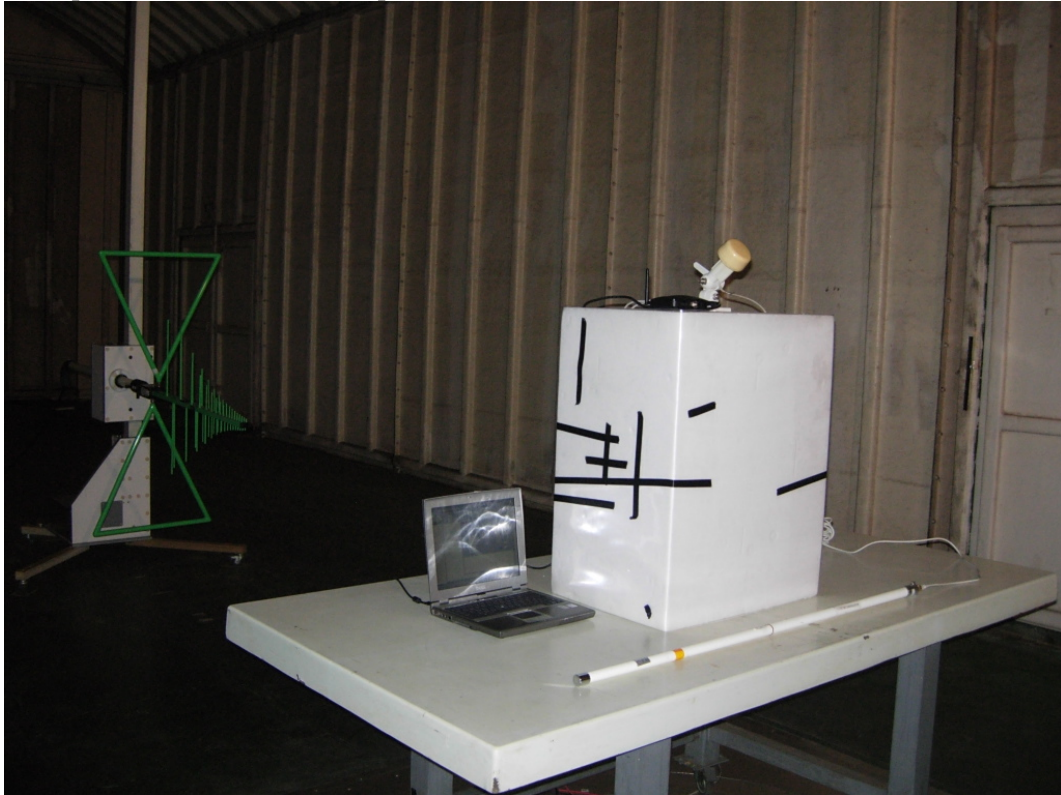

Test Mode : Receive Mode

Description : Back View of Spurious emissions Test

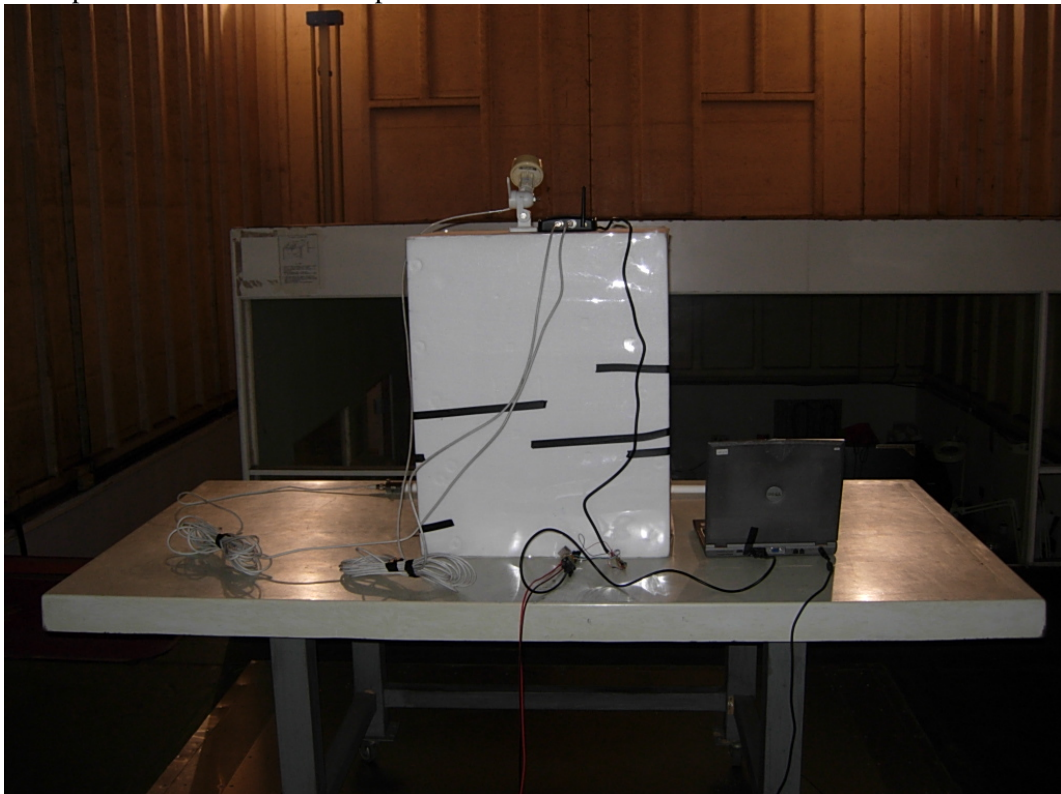

Test Mode : Receive Mode

Description : Front View of Spurious emissions Test-Horn



Test Mode : Receive Mode

Description : Back View of Spurious emissions Test-Horn

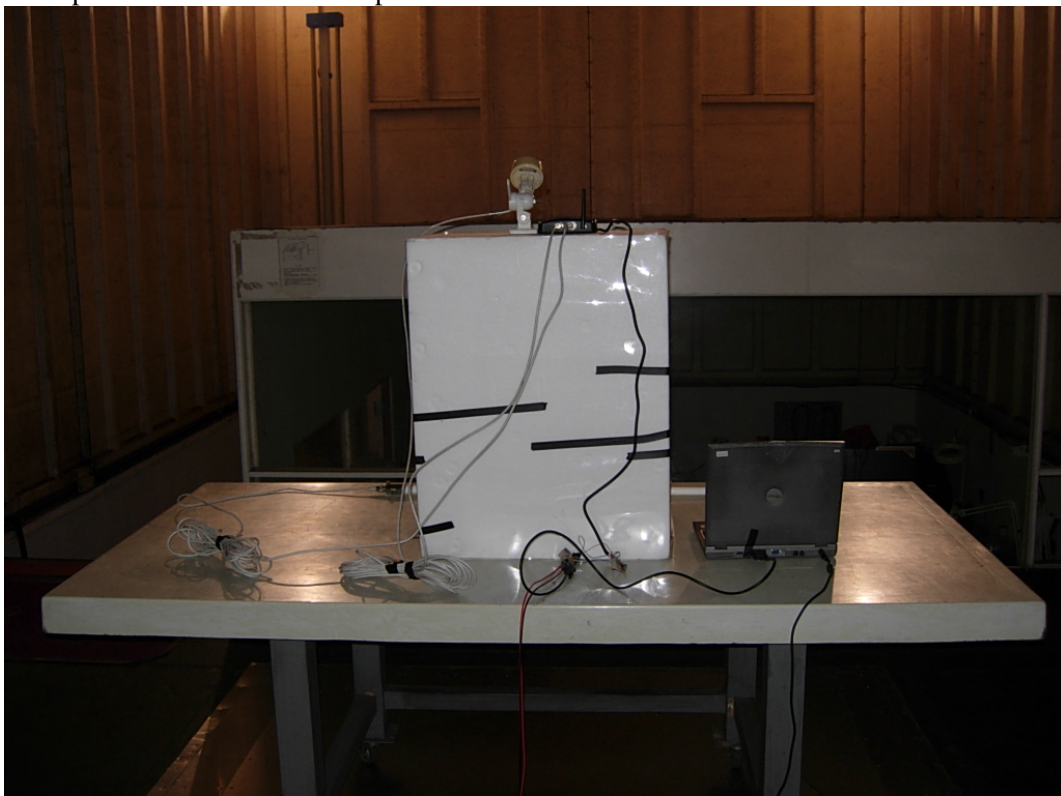

3. Measurement Uncertainty Values

The maximum values of the absolute measurement uncertainties of the measurements defined in the present document shall not exceed the values given below:

Parameters	Uncertainty
Radio frequency	$\pm 1 \times 10^{-7}$
RF power (conducted)	$\pm 2,5$ dB
Radiated emission of transmitter, valid to 26,5 GHz	± 6 dB
Radiated emission of transmitter, valid between 26,5 GHz and 66 GHz	± 8 dB
Radiated emission of receiver, valid to 26,5 GHz	± 6 dB
Radiated emission of receiver, valid between 26,5 GHz and 66 GHz	± 8 dB
Temperature	± 1 °C
Humidity	± 5 %
Voltage (DC)	± 1 %
Voltage (AC, < 10 kHz)	± 2 %
NOTE:	For radiated emissions above 26,5 GHz it may not be possible to achieve measurement uncertainties complying with the levels specified in this table. In these cases alone it is acceptable to employ the alternative interpretation procedure specified in clause 10.1.

For the test methods, according to the present document the uncertainty figures shall be calculated according to the methods described in the TR 100 028 [i.4] and shall correspond to an expansion factor (coverage factor) $k = 1,96$ or $k = 2$ (which provide confidence levels of respectively 95 % and 95,45 % in case where the distributions characterizing the actual measurement uncertainties are normal (Gaussian)).

Attachment: EUT Detailed Photographs

(1) EUT Photo



(2) EUT Photo



(3) EUT Photo



(4) EUT Photo



(5) EUT Photo



(6) EUT Photo

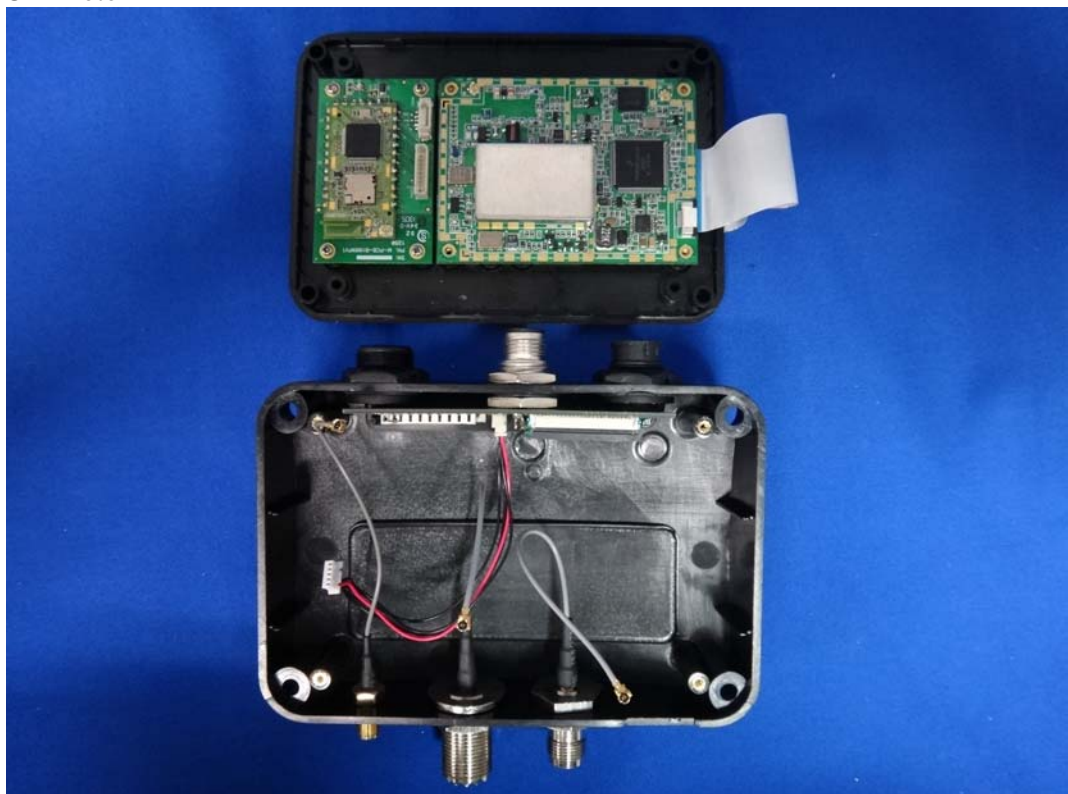

(7) EUT Photo



(8) EUT Photo



(9) EUT Photo

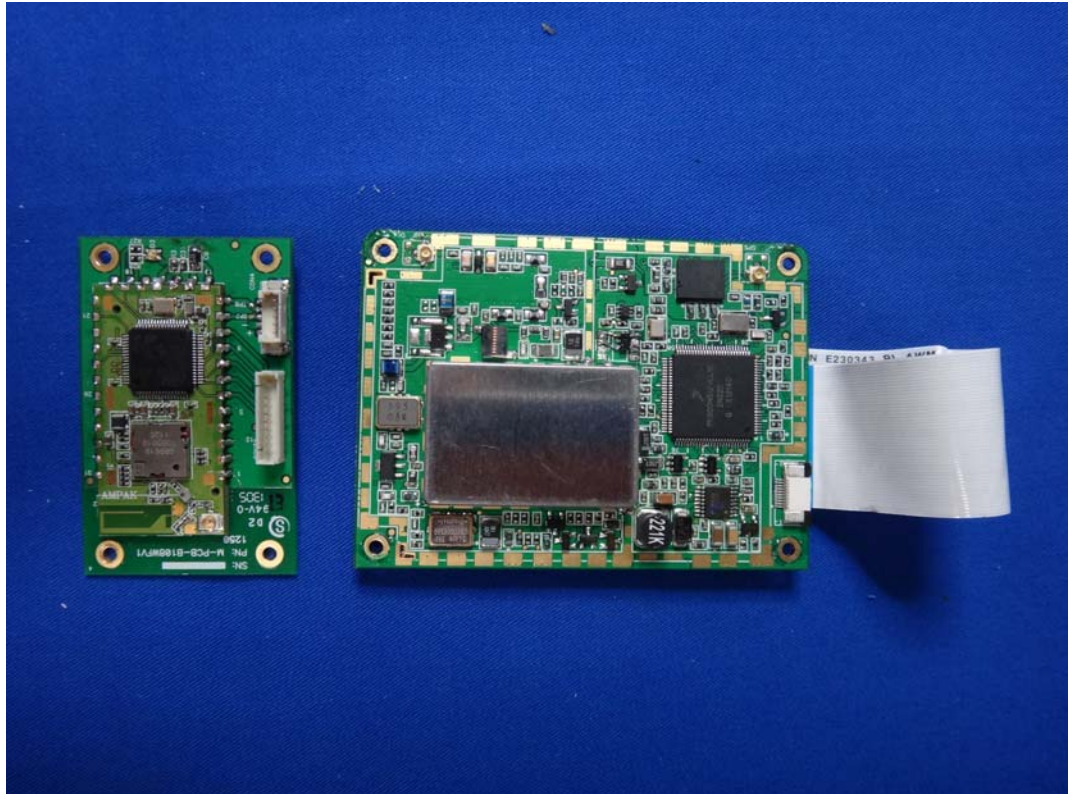

(10) EUT Photo

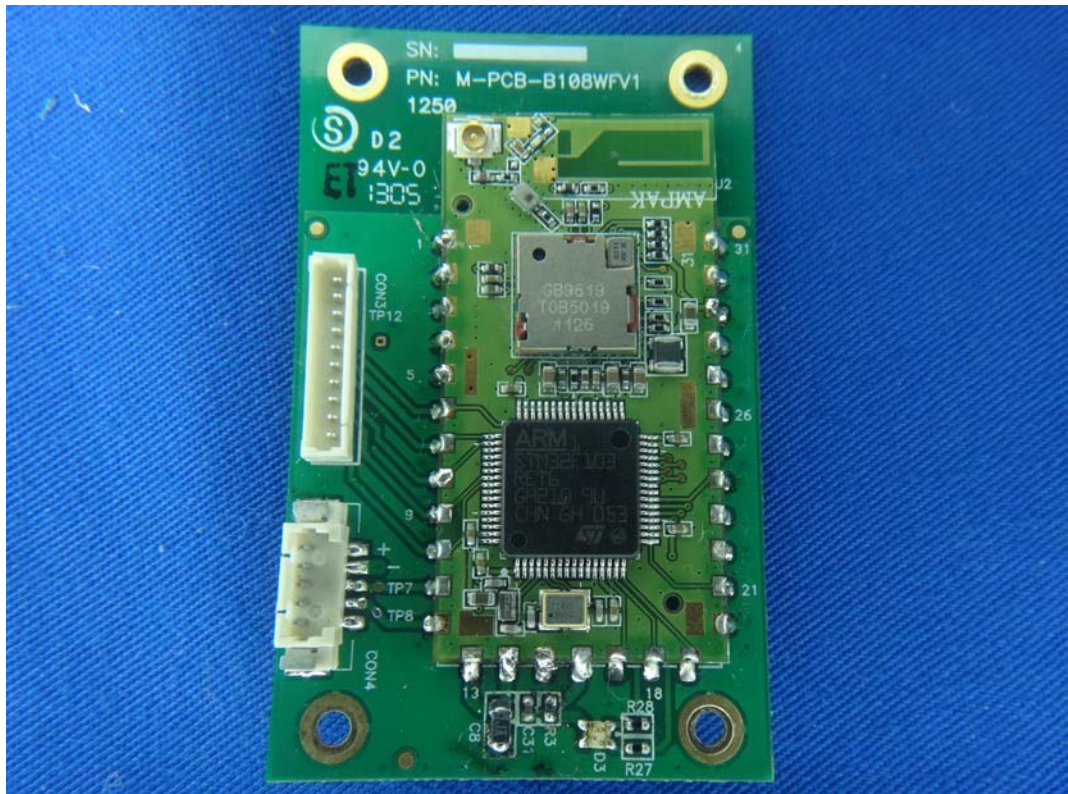

(11) EUT Photo

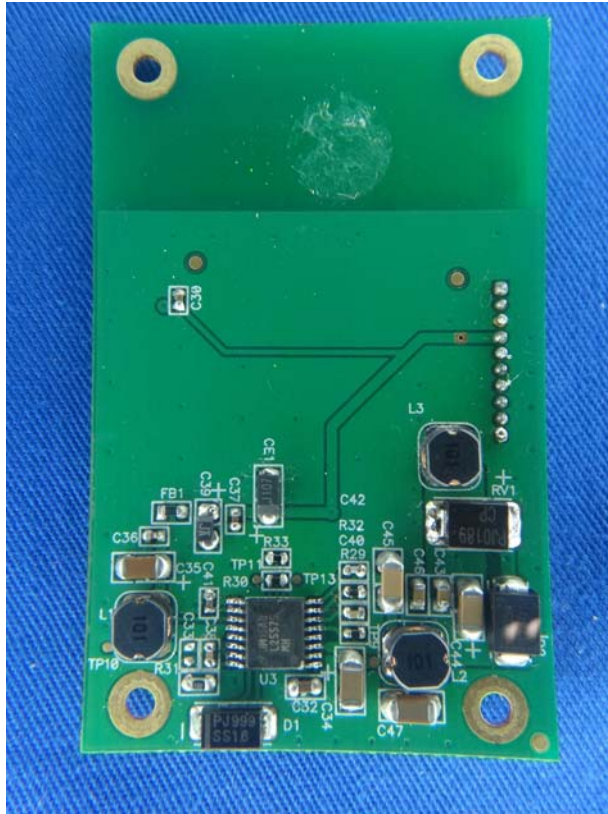

(12) EUT Photo

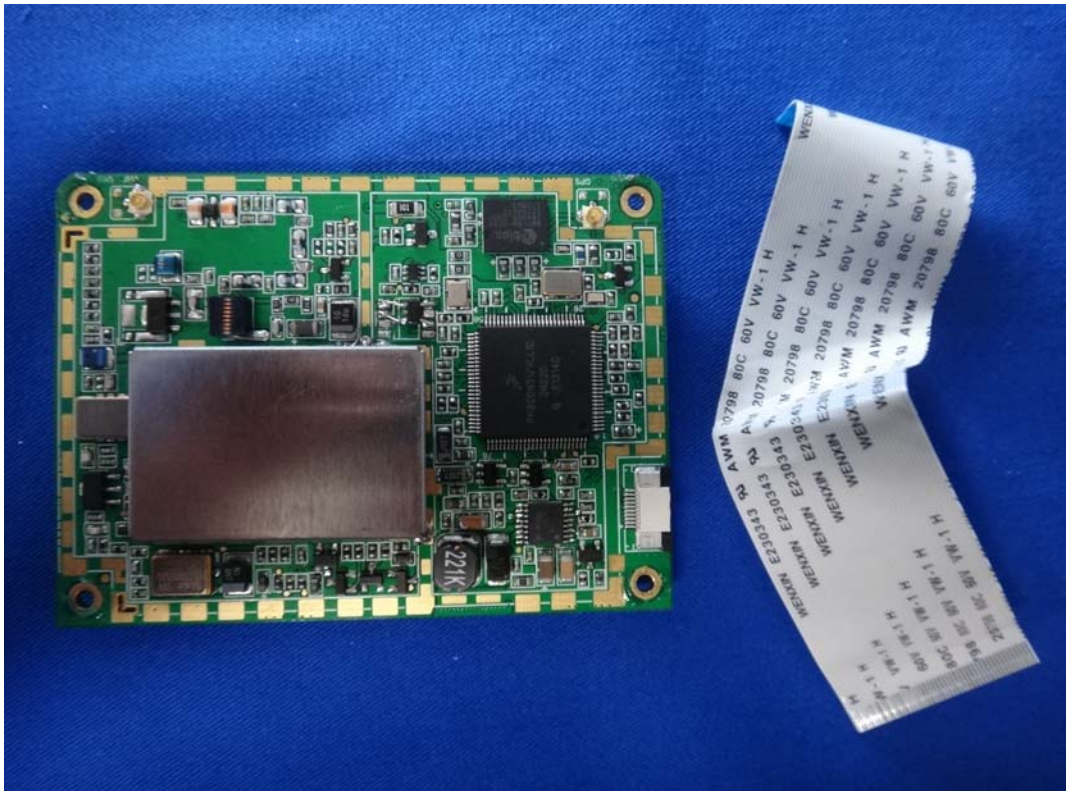

(13) EUT Photo

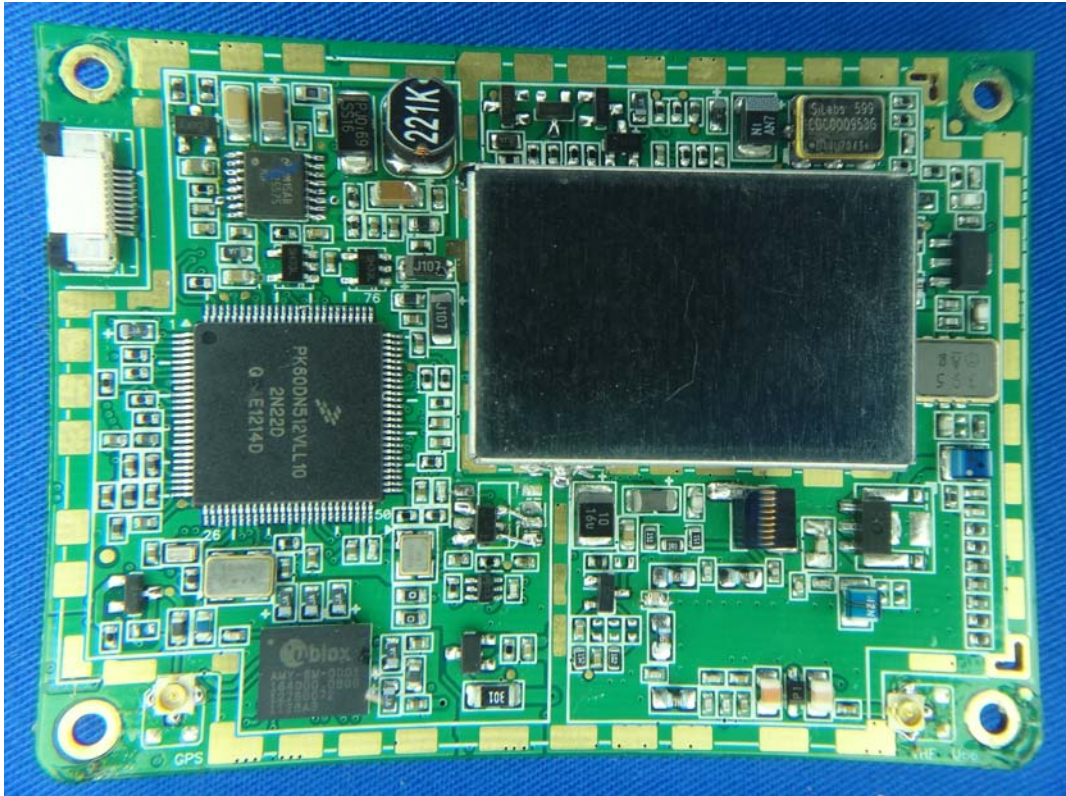

(14) EUT Photo

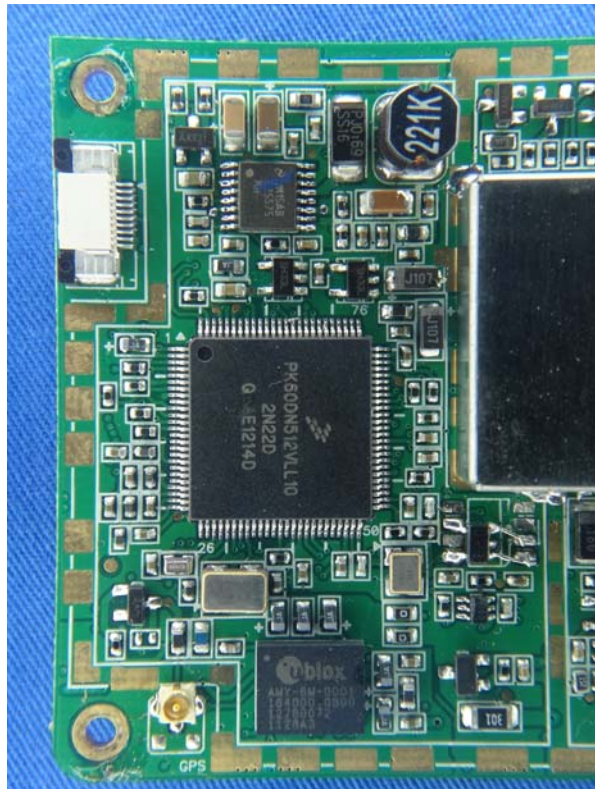

(15) EUT Photo

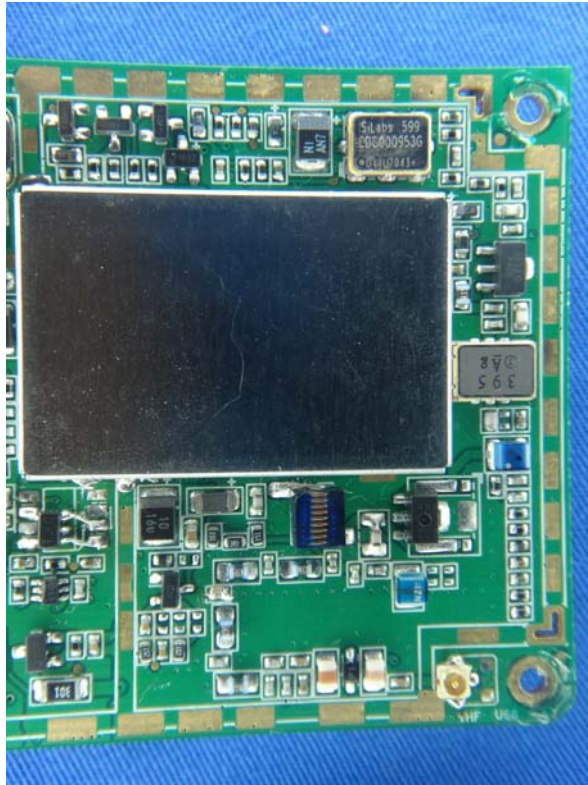

(16) EUT Photo

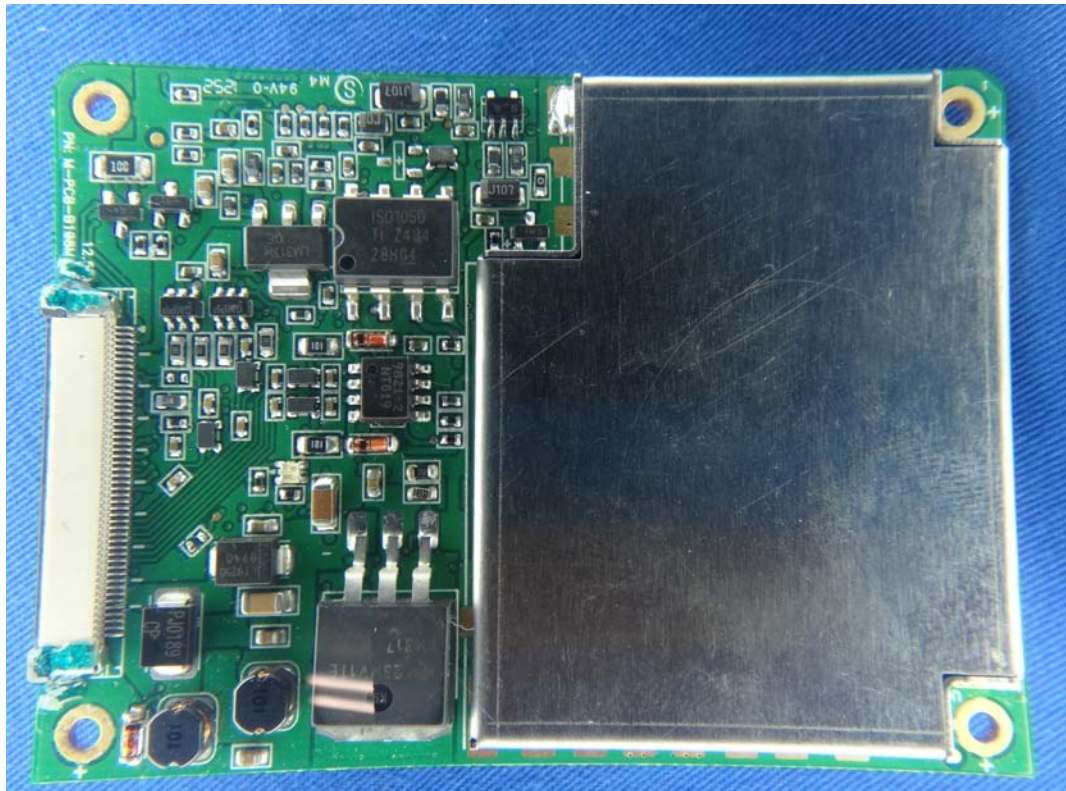

(17) EUT Photo

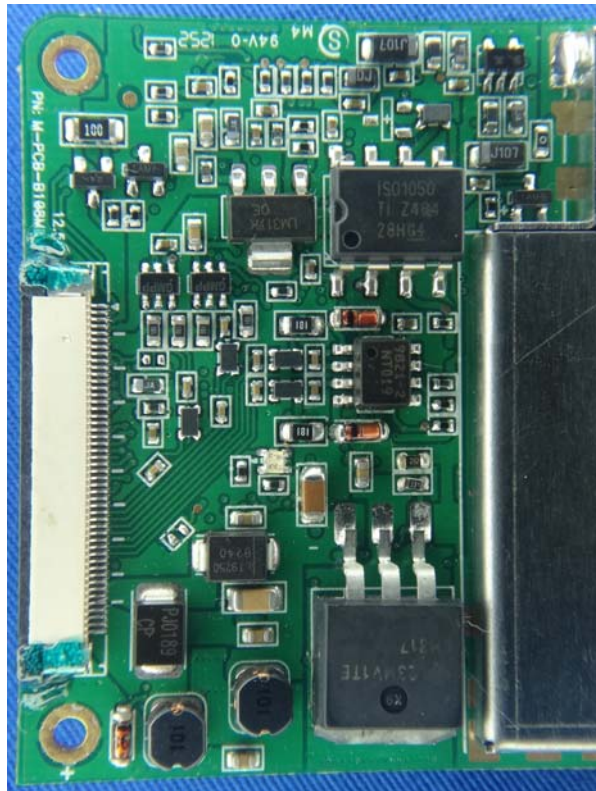

(18) EUT Photo (WLAN -ANT)



(19) EUT Photo (GPS Antenna-10m)



(20) EUT Photo (GPS Antenna-10m)



(21) EUT Photo (VHF Antenna)

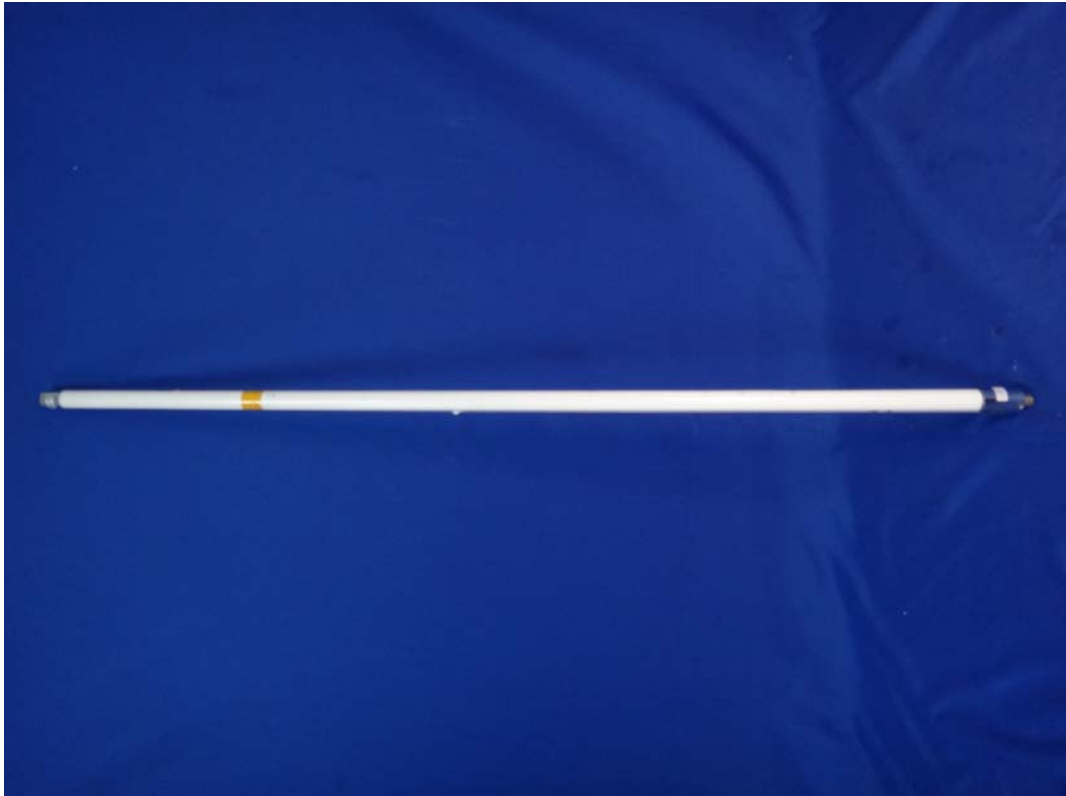

(22) EUT Photo (VHF Antenna)

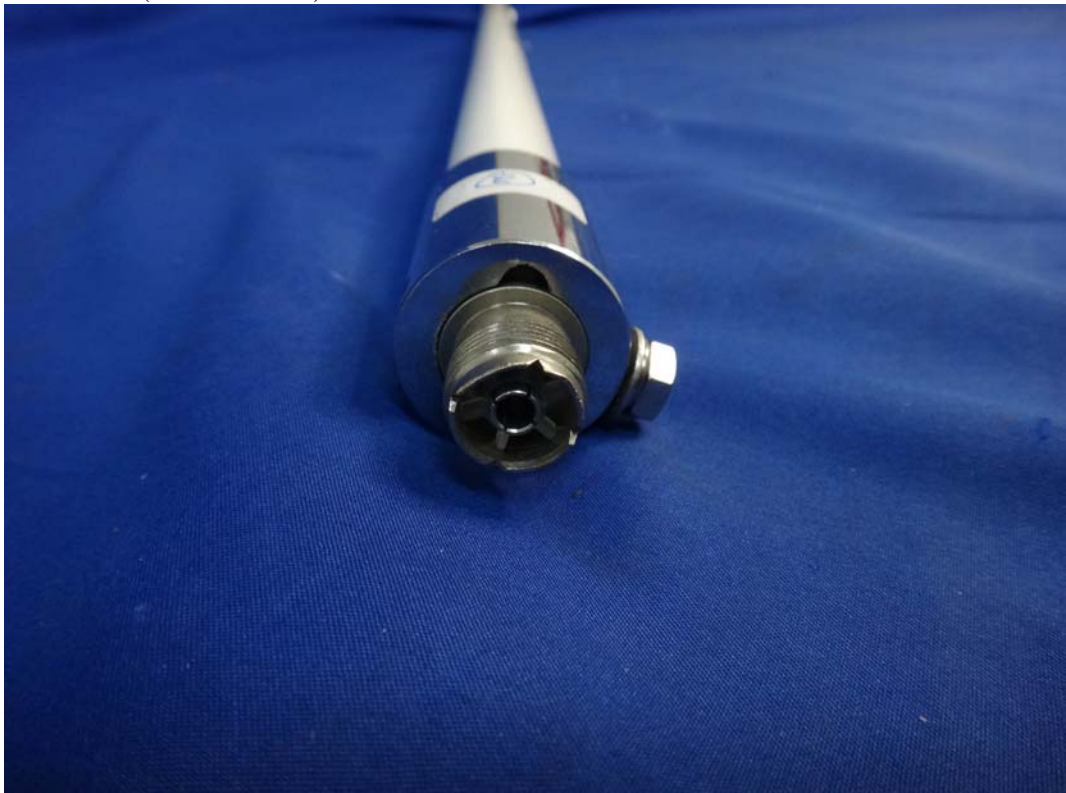

(23) EUT Photo (VHF Antenna Cable-10m)

