

FCC Test Report

Compliance with Canada Interference-Causing
Equipment Standard ICES-003

Product Name : AIS Class B Transponder
Model No. : CAMINO-108S
(CAMINO-108 with splitter)

Applicant : Alltek Marine Electronics Corp.
Address : 14F-2, No.237, Sec. 1, Datong Rd., Xizhi District,
New Taipei City, Taiwan, R.O.C.

Date of Receipt : 2020/04/24
Issued Date : 2020/05/05
Report No. : 2040663R-E3012110001
Report Version : V1.0



The test results relate only to the samples tested.
The test results shown in the test report are traceable to the national/international standard through the calibration of the equipment and evaluated measurement uncertainty herein.
This report must not be used to claim product endorsement by TAF or any agency of the government.
The test report shall not be reproduced without the written approval of DEKRA Testing and Certification Co., Ltd.
Measurement uncertainties evaluated for each testing system and associated connections are given here to provide the system information for reference. Compliance determinations do not take into account measurement uncertainties for each testing system, but are based on the results of the compliance measurement.

Test Report

Issued Date : 2020/05/05

Report No. : 2040663R-E3012110001



Product Name : AIS Class B Transponder
Applicant : Alltek Marine Electronics Corp.
Address : 14F-2, No.237, Sec. 1, Datong Rd., Xizhi District, New Taipei City,
Taiwan, R.O.C.
Manufacturer : Alltek Marine Electronics Corp.
Model No. : CAMINO-108S
(CAMINO-108 with splitter)
EUT Rated Voltage : DC 12V / 24V
EUT Test Voltage : DC 12V / 24V
Trade Name : AMEC
Applicable Standard : FCC CFR Title 47 Part 15 Subpart B: 2019 Class A
CISPR 22: 2008, ANSI C63.4: 2014
ICES-003 Issue 6: 2016 Class A
Test Result : Complied
Performed Location : DEKRA Testing and Certification Co., Ltd.
Linkou Laboratory
No. 5-22, Ruishukeng
Linkou District, New Taipei City, 24451, Taiwan
TEL:+866-2-8601-3788 / FAX:+886-2-8601-3789

Documented By : 

(Senior Adm. Specialist / Rita Huang)

Reviewed By : 

(Engineer / Shine Hsu)

Approved By : 

(Director / Vincent Lin)

Laboratory Information

We, **DEKRA Testing and Certification Co., Ltd.**, are an independent EMC and safety consultancy that was established the whole facility in our laboratories. The test facility has been accredited/accepted (audited or listed) by the following related bodies in compliance with ISO 17025, EN 45001 and specified testing scopes:

Taiwan	:	BSMI, NCC, TAF
Norway	:	DNVGL
USA	:	FCC
Japan	:	VCCI

The address and introduction of DEKRA Testing and Certification Co., Ltd. laboratories can be founded in our Web site : <http://www.dekra.com.tw>

TABLE OF CONTENTS

Description	Page
1. General Information	5
1.1. EUT Description.....	5
1.2. Mode of Operation	6
1.3. Tested System Details	7
1.4. Configuration of Tested System	8
1.5. EUT Operation Procedures	9
2. Technical Test	10
2.1. Summary of Test Result.....	10
2.2. List of Test Equipment	11
2.3. Measurement Uncertainty.....	12
2.4. Test Environment.....	13
3. Radiated Emission.....	14
3.1. Test Specification.....	14
3.2. Test Setup.....	14
3.3. Limit.....	15
3.4. Test Procedure	16
3.5. Test Result.....	17
3.6. Test Photograph	25
4. Attachment.....	28
EUT Photograph.....	28

1. General Information

1.1. EUT Description

Product Name	AIS Class B Transponder
Trade Name	AMEC
Model No.	CAMINO-108S (CAMINO-108 with splitter)
EUT Max Frequency	162.025MHz
Hardware Version	M-PCB-B108MBV11
Software Version	V1.2.8
GPS Module	u-blox EVA-M8M

Component	
VHF Radio Cable	Shielded, 1.0m
12pin Power & data Cable	Shielded, 1.0m
FM Radio Cable	Shielded, 1.3m
Mini USB to USB Cable	Shielded, 1.8m
GPS antenna with 10m Cable	Shielded, 10m

1.2. Mode of Operation

DEKRA verified the construction and function. All the test modes were carried out with the EUT in normal operation, which was shown in this test report and defined as:

Pre-Test Mode	
Mode 1: DC 12V Mode 2: DC 24V	
Final Test Mode	
Emission	Mode 1: DC 12V Mode 2: DC 24V

1.3. Tested System Details

The types of the following equipment and description of related cables used for the test setup are:

Product	Manufacturer	Model No.	Serial No.	Power Cord
1 Notebook PC	DELL	Latitude 5580	2HRD7H2	Non-Shielded, 0.8m
2 USB Mouse	Microsoft	1113	N/A	N/A
3 GPS Antenna	AMEC	GA-22	N/A	N/A
4 VHF Antenna	Tai Digiters	TENTA-11	A1K080110	N/A
5 VHF DSC Base Station Radio	NAVICOM	RT-550AIS	N/A	N/A
6 GPS Antenna	Schmarzbeck	9120D	N/A	N/A
7 GPS Generator	Agilent	E4438C	N/A	Non-Shielded, 0.8m

1.4. Configuration of Tested System

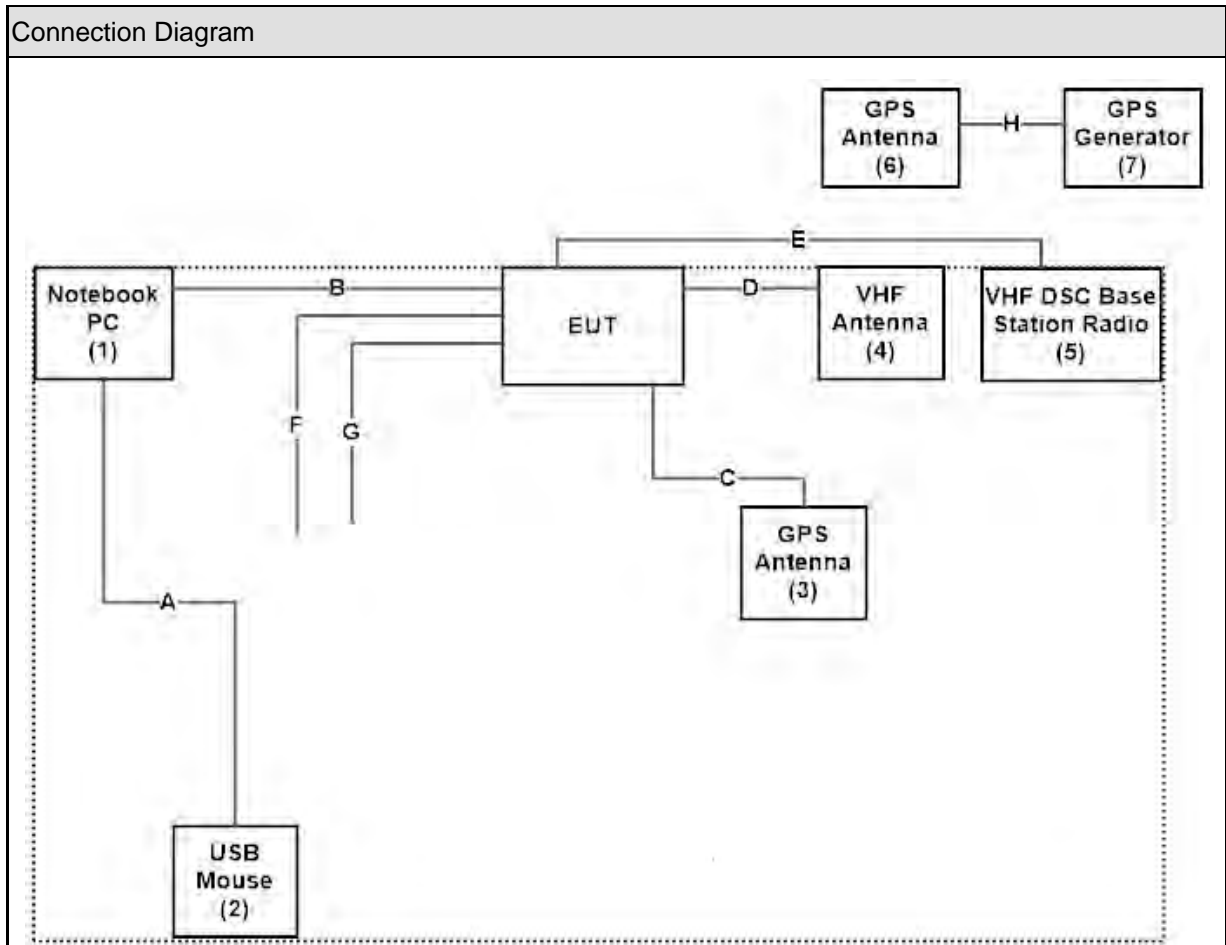

Cable Type		Cable Description
A	Mouse Cable	Shielded, 1.8m, with one ferrite core bonded
B	Mini USB to USB Cable	Shielded, 1.8m
C	GPS Antenna Cable	Shielded, 10m
D	VHF Antenna Cable	Shielded, 10m
E	VHF Radio Cable	Shielded, 1.0m
F	FM Radio Cable	Shielded, 1.3m
G	NMEA 2000 Cable	Shielded, 1.0m
H	Antenna Cable	Shielded, 3.0m

Note:

- Use Full system setup configuration determines Worst-Case Mode.
- Use 2dB law program determines Max. Cable Configuration and Worst-Case Mode.
- Radiated emission item test: Performed using the Horn Antenna 3dB Beamwidth to 3m from the EUT size sufficient to cover the procedure.
- Radiated emission item test: Performed using the Horn Antenna 3dB Beamwidth non 3m distance sufficient to cover the size of the EUT program.

1.5. EUT Operation Procedures

1	Setup the EUT and simulator as shown on 1.4.
2	Turn on the power of all equipment.
3	All the features of the EUT operation normally.
4	Start Testing.

2. Technical Test

2.1. Summary of Test Result

- No deviations from the test standards
- Deviations from the test standards as below description:

Emission			
Performed Item	Normative References	Test Performed	Deviation
Conducted Emission	FCC CFR Title 47 Part 15 Subpart B: 2019 Class A, ANSI C63.4: 2014	No	No
Radiated Emission	FCC CFR Title 47 Part 15 Subpart B: 2019 Class A, ANSI C63.4: 2014	Yes	No

Note : Test Procedure **ANSI C63.4:2014** **MP-5:1986**

2.2. List of Test Equipment

Radiated Emission / Site2

Instrument	Manufacturer	Type No.	Serial No	Cal. Date
Bilog Antenna	Schaffner Chase	CBL6112B	2921	2019/06/17
EMI Test Receiver	R&S	ESCS 30	100368	2019/10/31
Coaxial Cable	DEKRA	RG 214	LC002-RG	2019/06/12
Pre-Amplifier	Jet-Power	JPA-10M1G33	170101000330009	2019/06/12
Coaxial signal switch	Anritsu	MP59B	6200436230	2019/06/12
Site2 NSA	DEKRA	N/A	N/A	2019/06/12

Note: Test Receiver Detector: Quasipeak Bandwidth: 120kHz

Radiated Emission / CB7

Instrument	Manufacturer	Type No.	Serial No	Cal. Date
EMI Test Receiver	R&S	ESU26	100433	2019/11/11
Horn Antenna	ETS-Lindgren	3117	202723	2019/08/08
Pre-Amplifier	EMCI	EMC051845SE	980359	2019/11/08
CB7 VSWR	DEKRA	N/A	N/A	2019/06/24

2.3. Measurement Uncertainty

Radiated Emission

The measurement uncertainty is evaluated as ± 4.22 dB.

Radiated Emission Above 1GHz

The measurement uncertainty is evaluated as ± 5.08 dB.

2.4. Test Environment

Performed Item	Items	Required
Radiated Emission	Temperature (°C)	10-40
	Humidity (%RH)	10-90

3. Radiated Emission

3.1. Test Specification

According to EMC Standard : FCC Part 15 Subpart B, ANSI C63.4

3.2. Test Setup

Under 1GHz Test Setup:

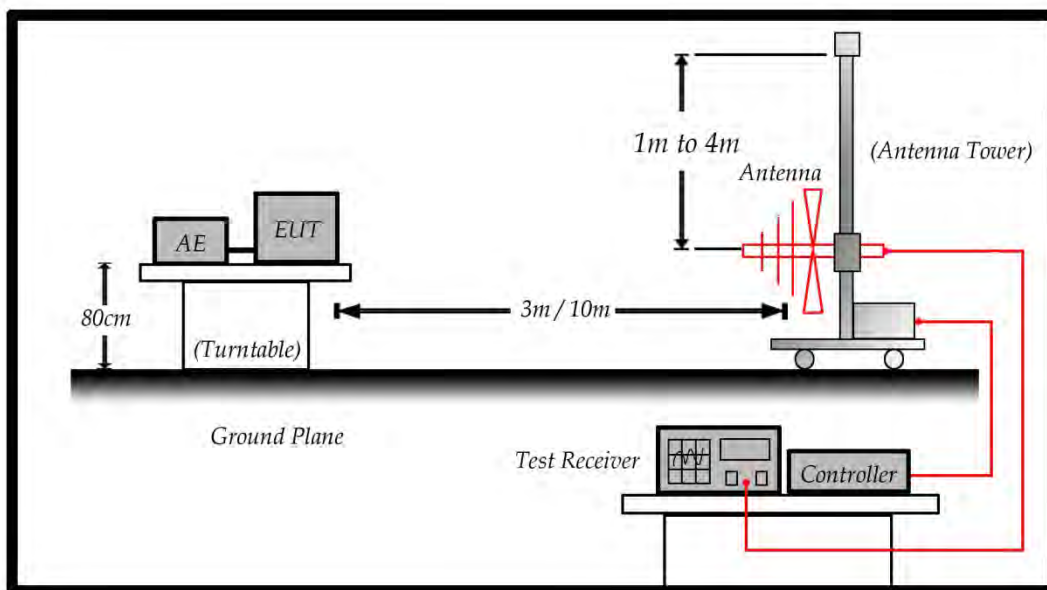

Above 1GHz Test Setup:

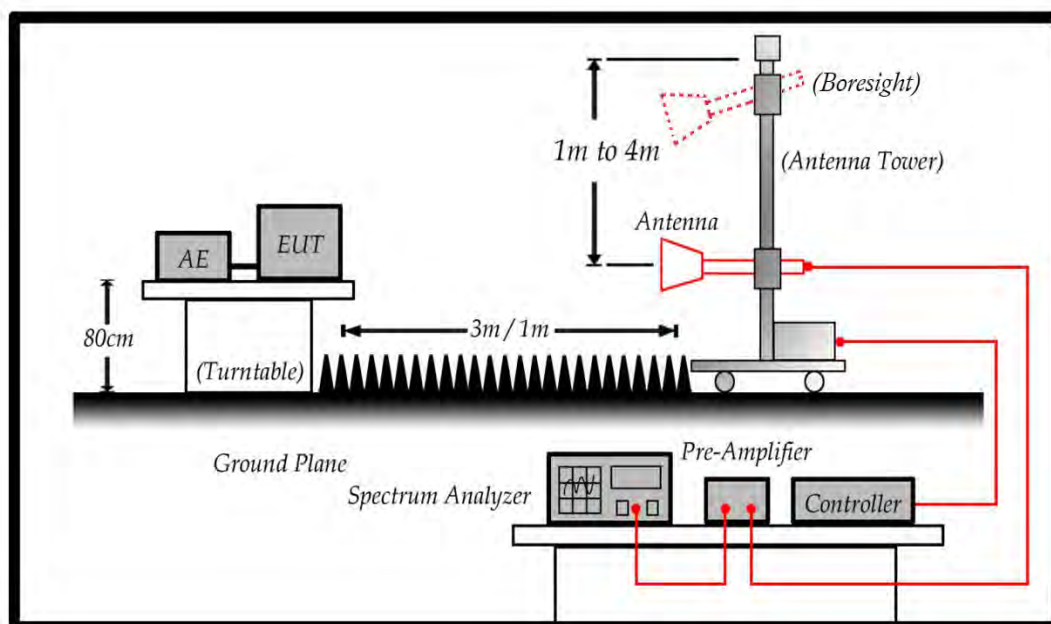

3.3. Limit

Under 1GHz test shall not exceed the following value:

Limits		
Frequency (MHz)	Distance (m)	dBuV/m
30 – 230	10	40
230 – 1000	10	47

Remark:

1. The tighter limit shall apply at the edge between two frequency bands.
2. Distance refers to the distance in meters between the measuring instrument antenna and the closed point of any part of the device or system.

Above 1GHz test shall not exceed the following value:

FCC Part 15 Subpart B Paragraph 15.109 Limits (dBuV/m)		
Frequency (MHz)	Distance(m)	dBuV/m
30-88	10	39
88-216	10	43.5
216-960	10	46.4
960-1000	10	49.5
1000 to 18000	3	59.5
Above 18000	1	69.54

Remark:

1. The tighter limit shall apply at the edge between two frequency bands.
2. Distance refers to the distance in meters between the measuring instrument antenna and the closed point of any part of the device or system.
3. RF Voltage (dBuV/m) = 20 log RF Voltage (uV/m)

3.4. Test Procedure

The EUT and its simulators are placed on a turn table which is 0.8 meter above ground.

The turn table can rotate 360 degrees to determine the position of the maximum emission level and the antenna (boresight antenna tower) can move up and down between 1 meter and 4 meters to find out the maximum emission level.

Both horizontal and vertical polarization of the antenna are set on measurement. In order to find the maximum emission, all of the interface cables must be manipulated on radiated measurement.

For an unintentional radiator, including a digital device, the spectrum shall be investigated from the lowest radio frequency signal generated or used in the device, without going below the lowest frequency for which a radiated emission limit is specified, up to the frequency shown in the following table:

Highest frequency generated or used in the device or on which the device operates or tunes (MHz)	Upper frequency of measurement range (MHz)
Below 1.705	30
1.705 – 108	1000
108 – 500	2000
500 – 1000	5000
Above 1000	5 th harmonic of the highest frequency or 40 GHz, whichever is lower

On any frequency or frequencies below or equal to 1000 MHz, the radiated limits shown are based on measuring equipment employing a quasi-peak detector function and above 1000 MHz, the radiated limits shown are based measuring equipment employing an average detector function.

When average radiated emission measurement are included emission measurement Above 1000 MHz, there also is a limit on the radio frequency emissions, as measured using instrumentation with a peak detector function, corresponding to 20 dB above the maximum permitted average limit.

For class A, the measurement distance between the EUT and antenna is 10 meters for under 1GHz and above 1GHz.

For class B, the measurement distance between the EUT and antenna is 10 meters for under 1GHz and 3 meters for above 1GHz.

The bandwidth below 1GHz setting on the field strength meter (Test Receiver) is 120 kHz and above 1GHz is 1MHz.

3.5. Test Result

Model No	CAMINO-108S	Site	SITE2
Test Voltage	DC 12V	Test Date	2020/4/30
Test Mode	Mode 1	Engineer	Stevenlee
Polarity	Horizontal	Temperature (°C)	21
Test Condition	--	Humidity (%RH)	67

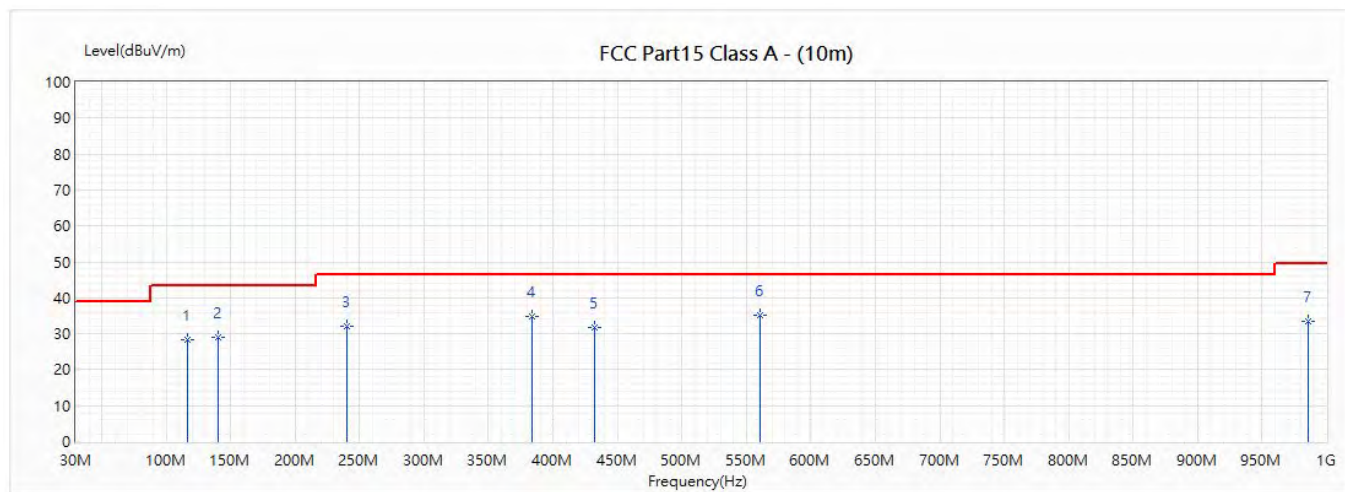

No	Frequency (MHz)	Emission Level (dBuV/m)	Limit (dBuV/m)	Margin (dB)	Reading Level (dBuV)	Correct Factor (dB/m)	Ant Pos (cm)	TT Pos (deg)	Detector Type
1	116.9	28.40	43.50	-15.10	40.50	-12.10	390	21	QP
2	140.6	28.96	43.50	-14.54	41.79	-12.83	390	-175	QP
3	240	31.97	46.40	-14.43	43.49	-11.52	390	21	QP
4	384	34.96	46.40	-11.44	41.50	-6.54	300	-72	QP
5	432	31.71	46.40	-14.69	36.80	-5.09	220	-23	QP
* 6	561.1	35.13	46.40	-11.27	36.80	-1.67	210	33	QP
7	985.4	33.34	49.50	-16.16	28.49	4.85	110	65	QP

Remark:

1. "*" means this data is the worst emission level; "!" means this data is over limit.
2. Emission Level=Reading Level + Correct Factor(Correct Factor=Ant Factor+Cable Loss-Pre Amp).
3. Margin=Emission Level-Limit.

Model No	CAMINO-108S	Site	SITE2
Test Voltage	DC 12V	Test Date	2020/4/30
Test Mode	Mode 1	Engineer	Stevenlee
Polarity	Vertical	Temperature (°C)	21
Test Condition	--	Humidity (%RH)	67

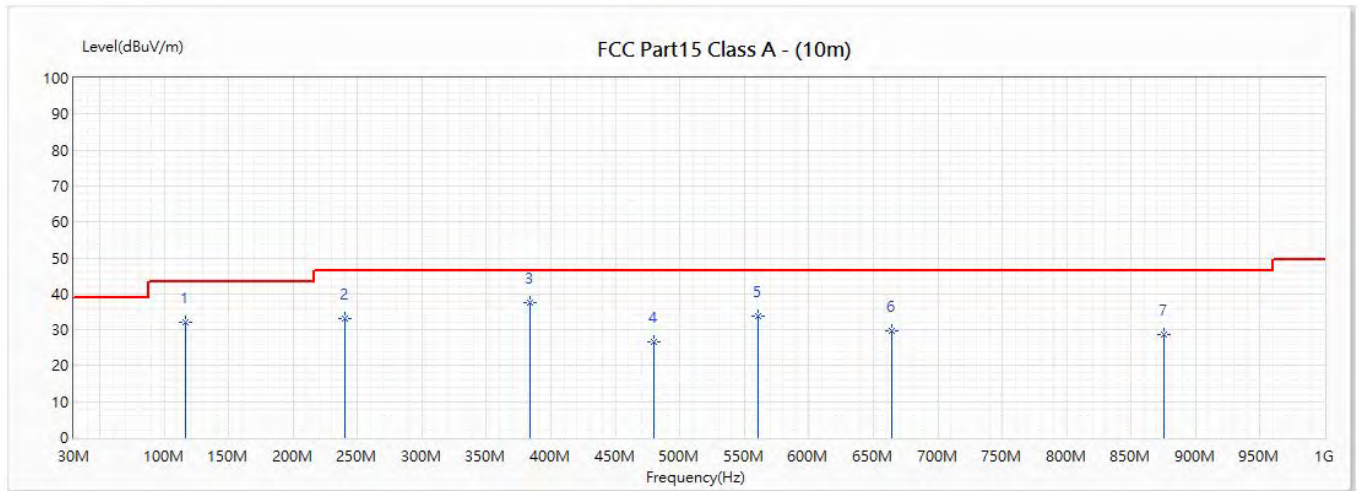

No	Frequency (MHz)	Emission Level (dBuV/m)	Limit (dBuV/m)	Margin (dB)	Reading Level (dBuV)	Correct Factor (dB/m)	Ant Pos (cm)	TT Pos (deg)	Detector Type
1	116.9	32.10	43.50	-11.40	44.20	-12.10	100	32	QP
2	240	33.27	46.40	-13.13	44.79	-11.52	100	-37	QP
* 3	384	37.66	46.40	-8.74	44.20	-6.54	100	54	QP
4	480	26.60	46.40	-19.80	30.49	-3.89	300	51	QP
5	561.1	33.73	46.40	-12.67	35.40	-1.67	300	-54	QP
6	664.6	29.81	46.40	-16.59	30.20	-0.39	250	122	QP
7	875.2	28.82	46.40	-17.58	25.80	3.02	150	134	QP

Remark:

1. "*" means this data is the worst emission level;"!" means this data is over limit.
2. Emission Level=Reading Level + Correct Factor(Correct Factor=Ant Factor+Cable Loss-Pre Amp).
3. Margin=Emission Level-Limit.

Model No	CAMINO-108S	Site	SITE2
Test Voltage	DC 24V	Test Date	2020/4/30
Test Mode	Mode 2	Engineer	Stevenlee
Polarity	Horizontal	Temperature (°C)	21
Test Condition	--	Humidity (%RH)	67

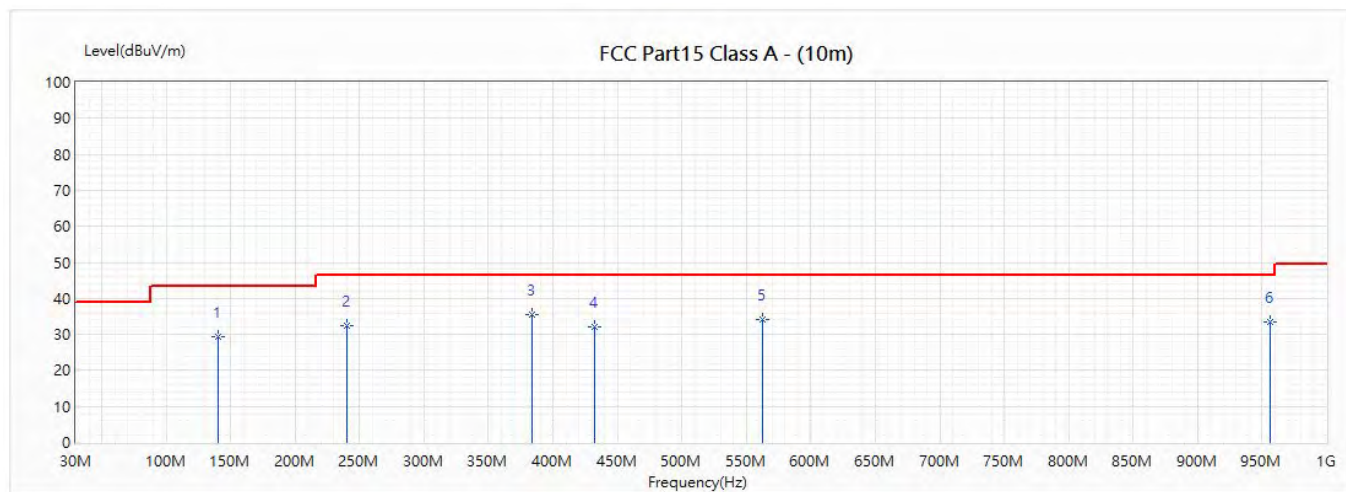

No	Frequency (MHz)	Emission Level (dBuV/m)	Limit (dBuV/m)	Margin (dB)	Reading Level (dBuV)	Correct Factor (dB/m)	Ant Pos (cm)	TT Pos (deg)	Detector Type
1	140.7	29.46	43.50	-14.04	42.30	-12.84	390	-161	QP
2	240	32.47	46.40	-13.93	43.99	-11.52	390	35	QP
* 3	384	35.36	46.40	-11.04	41.90	-6.54	300	-86	QP
4	432	32.01	46.40	-14.39	37.10	-5.09	220	-14	QP
5	562.1	34.24	46.40	-12.16	35.90	-1.66	210	46	QP
6	956	33.59	46.40	-12.81	29.20	4.39	110	58	QP

Remark:

1. "*" means this data is the worst emission level; "!" means this data is over limit.
2. Emission Level=Reading Level + Correct Factor(Correct Factor=Ant Factor+Cable Loss-Pre Amp).
3. Margin=Emission Level-Limit.

Model No	CAMINO-108S	Site	SITE2
Test Voltage	DC 24V	Test Date	2020/4/30
Test Mode	Mode 2	Engineer	Stevenlee
Polarity	Vertical	Temperature (°C)	21
Test Condition	--	Humidity (%RH)	67

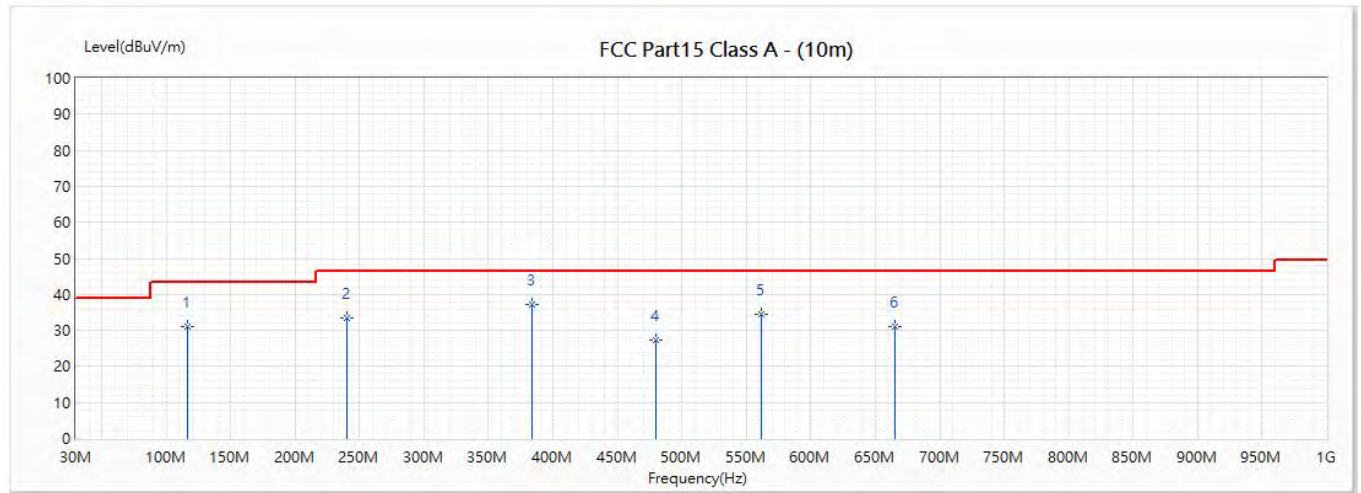

No	Frequency (MHz)	Emission Level (dBuV/m)	Limit (dBuV/m)	Margin (dB)	Reading Level (dBuV)	Correct Factor (dB/m)	Ant Pos (cm)	TT Pos (deg)	Detector Type
1	117	31.12	43.50	-12.38	43.20	-12.08	100	30	QP
2	240	33.57	46.40	-12.83	45.09	-11.52	100	-41	QP
* 3	384	37.36	46.40	-9.04	43.90	-6.54	100	62	QP
4	480	27.30	46.40	-19.10	31.19	-3.89	300	42	QP
5	561.3	34.53	46.40	-11.87	36.20	-1.67	300	-47	QP
6	664.8	30.91	46.40	-15.49	31.30	-0.39	250	131	QP

Remark:

1. "*" means this data is the worst emission level; "!" means this data is over limit.
2. Emission Level=Reading Level + Correct Factor(Correct Factor=Ant Factor+Cable Loss-Pre Amp).
3. Margin=Emission Level-Limit.

Model No	CAMINO-108S	Site	CB7
Test Voltage	DC 12V	Test Date	2020/4/27
Test Mode	Mode 1	Engineer	Sian
Polarity	Horizontal	Temperature (°C)	23.9
Test Condition	--	Humidity (%RH)	65

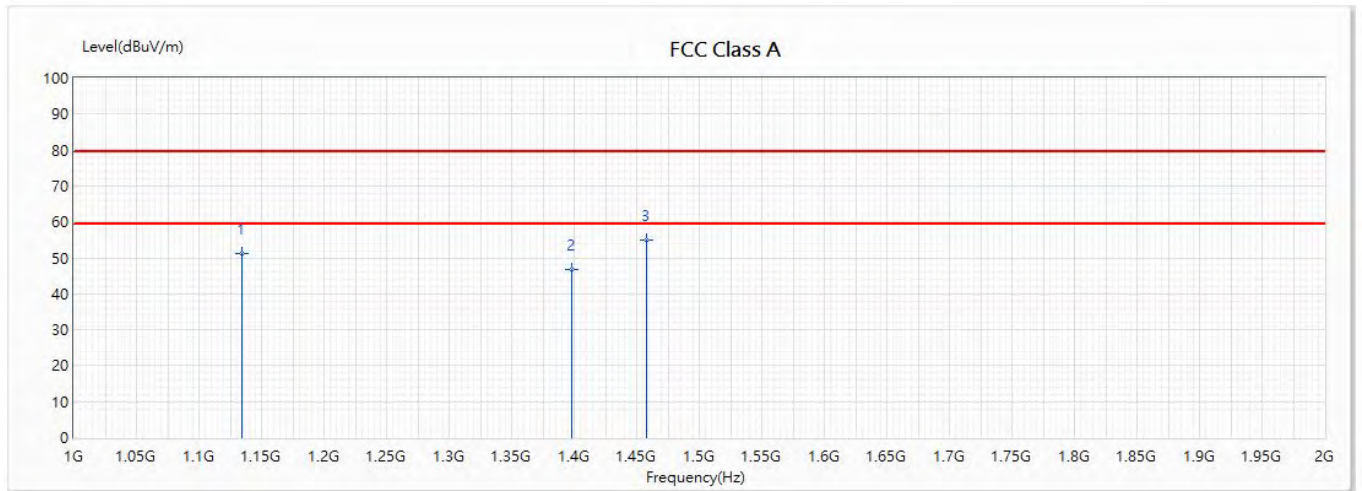

No	Frequency (MHz)	Emission Level (dBuV/m)	Limit (dBuV/m)	Margin (dB)	Reading Level (dBuV)	Correct Factor (dB/m)	Ant Pos (cm)	TT Pos (deg)	Detector Type
1	1134	51.33	79.50	-28.17	65.36	-14.03	151	-176	PK
2	1398	46.84	79.50	-32.66	60.11	-13.27	129	-46	PK
* 3	1458	54.91	79.50	-24.59	68.36	-13.45	190	-23	PK

Remark:

1. "*" means this data is the worst emission level; "!" means this data is over limit.
2. Emission Level=Reading Level + Correct Factor(Correct Factor=Ant Factor+Cable Loss-Pre Amp).
3. Margin= Emission Level-Limit.

Model No	CAMINO-108S	Site	CB7
Test Voltage	DC 12V	Test Date	2020/4/27
Test Mode	Mode 1	Engineer	Sian
Polarity	Vertical	Temperature (°C)	23.9
Test Condition	--	Humidity (%RH)	65

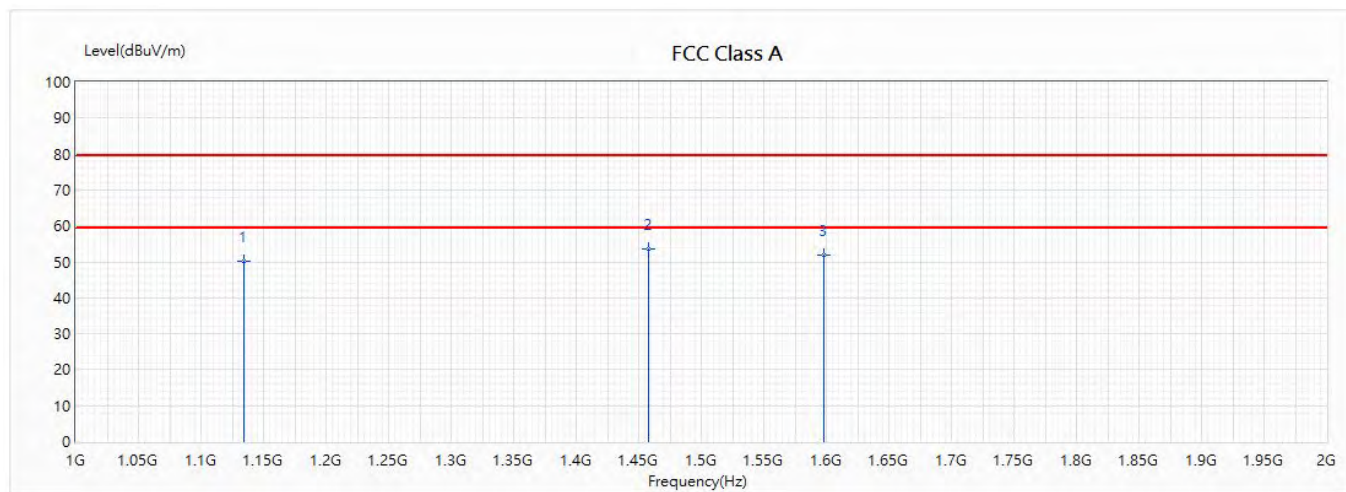

No	Frequency (MHz)	Emission Level (dBuV/m)	Limit (dBuV/m)	Margin (dB)	Reading Level (dBuV)	Correct Factor (dB/m)	Ant Pos (cm)	TT Pos (deg)	Detector Type
1	1134	50.24	79.50	-29.26	64.27	-14.03	101	20	PK
* 2	1458	53.74	79.50	-25.76	67.19	-13.45	131	-199	PK
3	1598	51.95	79.50	-27.55	64.80	-12.85	175	-38	PK

Remark:

1. "*" means this data is the worst emission level; "!" means this data is over limit.
2. Emission Level=Reading Level + Correct Factor(Correct Factor=Ant Factor+Cable Loss-Pre Amp).
3. Margin= Emission Level-Limit.

Model No	CAMINO-108S	Site	CB7
Test Voltage	DC 24V	Test Date	2020/4/27
Test Mode	Mode 2	Engineer	Sian
Polarity	Horizontal	Temperature (°C)	23.9
Test Condition	--	Humidity (%RH)	65

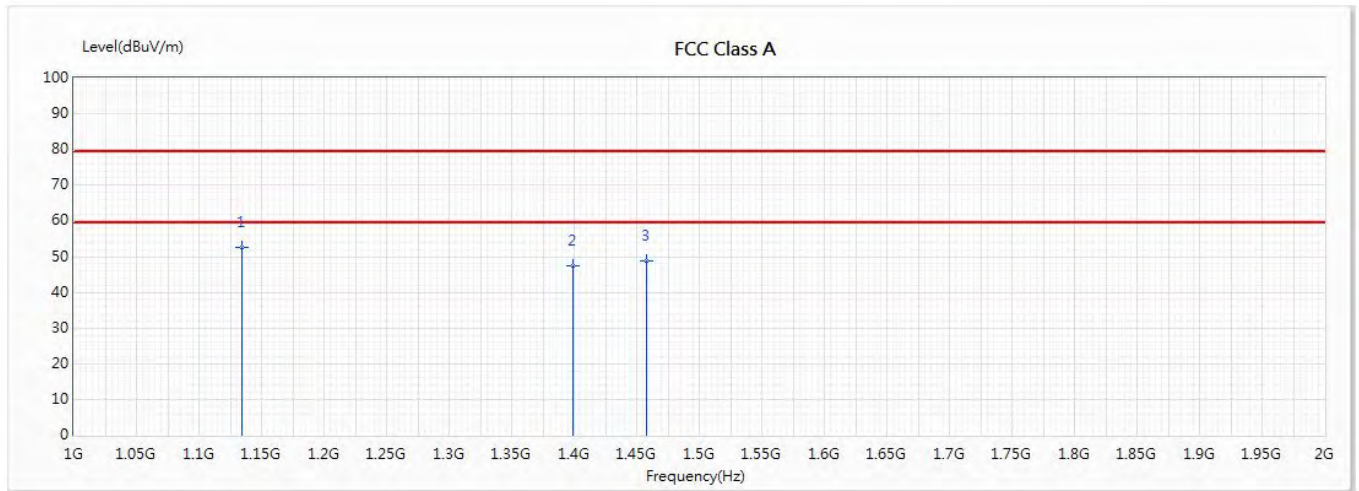

No	Frequency (MHz)	Emission Level (dBuV/m)	Limit (dBuV/m)	Margin (dB)	Reading Level (dBuV)	Correct Factor (dB/m)	Ant Pos (cm)	TT Pos (deg)	Detector Type
* 1	1134	52.62	79.50	-26.88	66.65	-14.03	-73	121	PK
2	1399	47.33	79.50	-32.17	60.59	-13.26	-73	121	PK
3	1458	48.78	79.50	-30.72	62.23	-13.45	-64	157	PK

Remark:

1. "*" means this data is the worst emission level; "!" means this data is over limit.
2. Emission Level=Reading Level + Correct Factor(Correct Factor=Ant Factor+Cable Loss-Pre Amp).
3. Margin= Emission Level-Limit.

Model No	CAMINO-108S	Site	CB7
Test Voltage	DC 24V	Test Date	2020/4/27
Test Mode	Mode 2	Engineer	Sian
Polarity	Vertical	Temperature (°C)	23.9
Test Condition	--	Humidity (%RH)	65

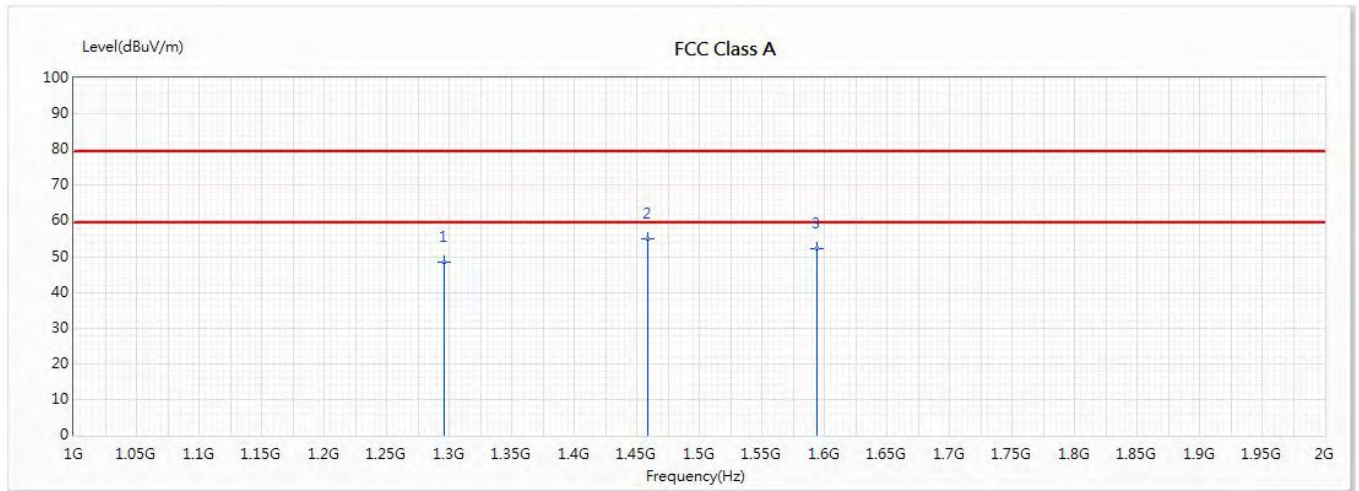

No	Frequency (MHz)	Emission Level (dBuV/m)	Limit (dBuV/m)	Margin (dB)	Reading Level (dBuV)	Correct Factor (dB/m)	Ant Pos (cm)	TT Pos (deg)	Detector Type
1	1296	48.39	79.50	-31.11	62.03	-13.64	194	61	PK
* 2	1459	55.00	79.50	-24.50	68.45	-13.45	173	194	PK
3	1594	52.40	79.50	-27.10	65.30	-12.90	125	137	PK

Remark:

1. "*" means this data is the worst emission level; "!" means this data is over limit.
2. Emission Level=Reading Level + Correct Factor(Correct Factor=Ant Factor+Cable Loss-Pre Amp).
3. Margin= Emission Level-Limit.

3.6. Test Photograph

Test Mode : Mode 1: DC 12V

Description : Front View of Radiated Test



Test Mode : Mode 1: DC 12V

Description : Back View of Radiated Test



Test Mode : Mode 1: DC 12V

Description : Front View of High Frequency Radiated Test



Test Mode : Mode 2: DC 24V

Description : Front View of Radiated Test



Test Mode : Mode 2: DC 24V

Description : Back View of Radiated Test



Test Mode : Mode 2: DC 24V

Description : Front View of High Frequency Radiated Test



4. Attachment

➤ **EUT Photograph**

(1) EUT Photo



(2) EUT Photo



(3) EUT Photo

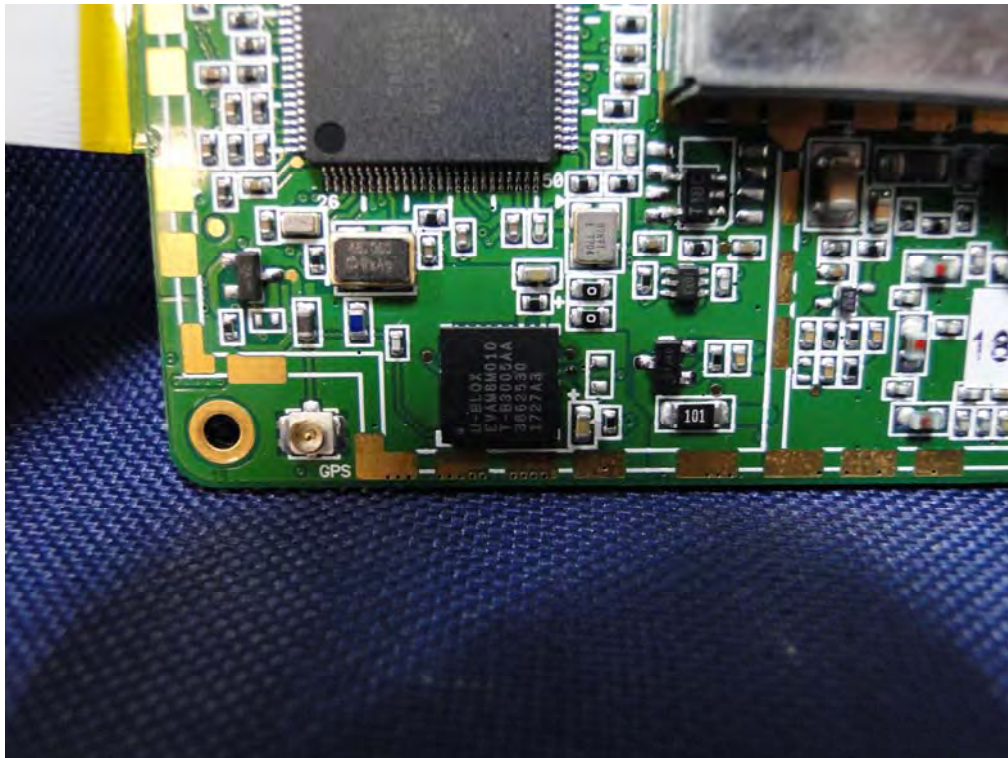

(4) EUT Photo _ VHF Radio Cable



(5) EUT Photo _ 12pin Power & data Cable



(6) EUT Photo _ FM Radio Cable



(7) EUT Photo _ Mini USB to USB Cable



(8) EUT Photo _ GPS antenna with 10m Cable

