



FCC RF Test Report

APPLICANT : Sonim Technologies, Inc.
EQUIPMENT : LTE Phone
BRAND NAME : Sonim
MODEL NAME : XP5800(PC2111)
FCC ID : WYPPC2100
STANDARD : FCC 47 CFR Part 2, and 90(S)
CLASSIFICATION : PCS Licensed Transmitter Held to Ear (PCE)

The product was received on Sep. 21, 2017 and testing was completed on Oct. 04, 2017. We, Sporton International (Kunshan) Inc., would like to declare that the tested sample has been evaluated in accordance with the procedures given in ANSI/TIA-603-E and shown compliance with the applicable technical standards.

The test results in this report apply exclusively to the tested model / sample. Without written approval of Sporton International (Kunshan) Inc., the test report shall not be reproduced except in full.



Approved by: James Huang / Manager

Sporton International (Kunshan) Inc.

**No.3-2 Ping-Xiang Rd, Kunshan Development Zone Kunshan City Jiangsu Province 215335
China**



TABLE OF CONTENTS

REVISION HISTORY.....3

SUMMARY OF TEST RESULT4

1 GENERAL DESCRIPTION5

1.1 Applicant.....5

1.2 Manufacturer5

1.3 Feature of Equipment Under Test.....5

1.4 Product Specification of Equipment Under Test6

1.5 Modification of EUT6

1.6 Maximum Frequency Tolerance, Emission Designator and Conducted Power.....6

1.7 Testing Site.....7

1.8 Applied Standards8

2 TEST CONFIGURATION OF EQUIPMENT UNDER TEST9

2.1 Test Mode.....9

2.2 Connection Diagram of Test System10

2.3 Support Unit used in test configuration and system.....10

2.4 Measurement Results Explanation Example10

2.5 Frequency List of Low/Middle/High Channels.....11

3 TEST RESULT12

3.1 Conducted Output Power Measurement.....12

3.2 99% Occupied Bandwidth and 26dB Bandwidth Measurement.....13

3.3 Emissions Mask Measurement14

3.4 Emissions Mask – Out Of Band Emissions Measurement.....16

3.5 Field Strength of Spurious Radiation Measurement18

3.6 Frequency Stability Measurement.....20

4 LIST OF MEASURING EQUIPMENT22

5 UNCERTAINTY OF EVALUATION23

APPENDIX A. TEST RESULTS OF CONDUCTED TEST

APPENDIX B. TEST RESULTS OF RADIATED TEST

APPENDIX C. SETUP PHOTOGRAPHS



SUMMARY OF TEST RESULT

Report Section	FCC Rule	Description	Limit	Result	Remark
3.1	§2.1046	Conducted Output Power	Reporting only	PASS	-
3.2	§2.1049 §90.209	Occupied Bandwidth and 26dB Bandwidth	Reporting only	PASS	-
3.3	§2.1051 §90.691	Emission masks – In-band emissions	$< 50+10\log_{10}(P[\text{Watts}])$	PASS	-
3.4	§2.1051 §90.691	Emission masks – Out of band emissions	$< 43+10\log_{10}(P[\text{Watts}])$	PASS	-
3.5	§2.1053 §90.691	Field Strength of Spurious Radiation	$< 43+10\log_{10}(P[\text{Watts}])$	PASS	Under limit 49.84 dB at 1645.74 MHz
3.6	§2.1055 §90.213	Frequency Stability for Temperature & Voltage	< 2.5 ppm	PASS	-



1 General Description

1.1 Applicant

Sonim Technologies, Inc.
1825 S. Grant St., Suite 200., San Mateo, CA, 94402

1.2 Manufacturer

Sonim Technologies (Shenzhen) Limited
2nd Floor, No. 2 Building Phase B, Daqian Industrial park, Longchang Road, 67 District, Baoan, Shenzhen, P. R. China

1.3 Feature of Equipment Under Test

Product Feature	
Equipment	LTE Phone
Brand Name	Sonim
Model Name	XP5800(PC2111)
FCC ID	WYPPC2100
EUT supports Radios application	CDMA/EV-DO/GSM/GPRS/EGPRS/WCDMA/HSPA/DC-HSDPA/HSPA+(16QAM uplink is not supported)/LTE WLAN 2.4GHz 802.11b/g/n HT20/HT40 WLAN 5GHz 802.11a/n HT20/HT40 Bluetooth v3.0 + EDR/Bluetooth v4.0 LE /Bluetooth v4.2 LE
IMEI Code	Conducted: 001080001908558/001080001908558 Radiation: 001080001911198/001080001911206
HW Version	A
SW Version	5SA.0.0-00-7.1.2-00.25.01
EUT Stage	Identical Prototype

Remark: The above EUT's information was declared by manufacturer. Please refer to the specifications or user's manual for more detailed description.



1.4 Product Specification of Equipment Under Test

Product Specification subjective to this standard	
Tx Frequency	LTE Band 26 : 814.7 ~ 823.3 MHz
Rx Frequency	LTE Band 26 : 859.7 ~ 868.3 MHz
Bandwidth	1.4MHz / 3MHz / 5MHz / 10MHz / 15MHz
Maximum Output Power to Antenna	22.98 dBm
Antenna Type	PIFA Antenna
Type of Modulation	QPSK / 16QAM

Remark: This test report recorded only product characteristics and test results of PCS Licensed Transmitter Held to Ear (PCE).

1.5 Modification of EUT

No modifications are made to the EUT during all test items.

1.6 Maximum Frequency Tolerance, Emission Designator and Conducted Power

FCC Rule	System	Type of Modulation	BW	Frequency Tolerance (ppm)	Emission Designator	Maximum Conducted power(W)
Part 90S	LTE Band 26	QPSK	1.4 MHz	-	1M09G7D	0.1726
Part 90S	LTE Band 26	16QAM	1.4 MHz	-	1M09W7D	0.1445
Part 90S	LTE Band 26	QPSK	3 MHz	-	2M73G7D	0.1694
Part 90S	LTE Band 26	16QAM	3 MHz	-	2M72W7D	0.1429
Part 90S	LTE Band 26	QPSK	5 MHz	-	4M49G7D	0.1648
Part 90S	LTE Band 26	16QAM	5 MHz	-	4M50W7D	0.1535
Part 90S	LTE Band 26	QPSK	10 MHz	0.0034 ppm	9M03G7D	0.1795
Part 90S	LTE Band 26	16QAM	10 MHz	-	8M97W7D	0.1545
Part 90S	LTE Band 26	QPSK	15 MHz	-	13M4G7D	0.1986
Part 90S	LTE Band 26	16QAM	15 MHz	-	13M4W7D	0.1730



1.7 Testing Site

Sporton Lab is accredited to ISO 17025 by National Voluntary Laboratory Accreditation Program (NVLAP code: 600155-0) and the FCC designation No is CN5013.

Test Site	Sporton International (Kunshan) Inc.	
Test Site Location	No.3-2 Ping-Xiang Rd, Kunshan Development Zone Kunshan City Jiangsu Province 215335 China TEL : +86-512-57900158 FAX : +86-512-57900958	
Test Site No.	Sporton Site No.	FCC Test Firm Registration No.
	TH01-KS	630927

Sporton Lab is accredited to ISO 17025 by National Voluntary Laboratory Accreditation Program (NVLAP code: 600156-0) and the FCC designation No is CN5019.

Test Site	Sporton International (Shenzhen) Inc.	
Test Site Location	No. 3 Bldg the third floor of south, Shahe River west, Fengzeyuan Warehouse, Nanshan District Shenzhen City Guangdong Province 518055 China TEL: +86-755-3320-2398	
Test Site No.	Sporton Site No.	FCC Test Firm Registration No.
	03CH04-SZ	577730

Note: The test site complies with ANSI C63.4 2014 requirement.



1.8 Applied Standards

According to the specifications of the manufacturer, the EUT must comply with the requirements of the following standards:

- ♦ FCC 47 CFR Part 2, 90
- ♦ ANSI/TIA-603-E
- ♦ FCC KDB 971168 D01 Power Meas. License Digital Systems v03
- ♦ FCC KDB 971168 D02 Misc Rev Approv License Devices v02

Remark:

1. All test items were verified and recorded according to the standards and without any deviation during the test.
2. This EUT has also been tested and complied with the requirements of FCC Part 15, Subpart B, recorded in a separate test report.



2 Test Configuration of Equipment Under Test

2.1 Test Mode

During all testing, EUT is in link mode with base station emulator at maximum power level. The spurious emission measurements were carried out in semi-anechoic chamber with 3-meter test range, and EUT is rotated on three test planes to find out the worst emission.

Frequency range investigated for radiated emission is 30 MHz to 10th harmonic.

Test Items	Band	Bandwidth (MHz)						Modulation		RB #			Test Channel		
		1.4	3	5	10	15	20	QPSK	16QAM	1	Half	Full	L	M	H
Max. Output Power	26	v	v	v	v	v	-	v	v	v	v	v	v	v	v
26dB and 99% Bandwidth	26	v	v	v	v	v	-	v	v			v	v	v	v
Emission masks In-band emissions	26	v	v	v	v	v	-	v	v	v		v	v		v
Emission masks - Out of band emissions	26	v	v	v	v	v	-	v	v	v			v	v	v
Frequency Stability	26				v		-	v				v		v	
Radiated Spurious Emission	26	v	v	v			-	v		v			v	v	v
	26				v			v		v				v	
Note	<ol style="list-style-type: none"> The mark "v" means that this configuration is chosen for testing The mark "-" means that this bandwidth is not supported. LTE Band26 transmit frequency for part22 rule is 824MHz-849MHz, for part90 rule is 814MHz-824MHz. ERP over 15MHz bandwidth complies the ERP limit line of part22 rule, therefore ERP of the partial frequency spectrum which falls within part 22 also complies. 														

2.2 Connection Diagram of Test System

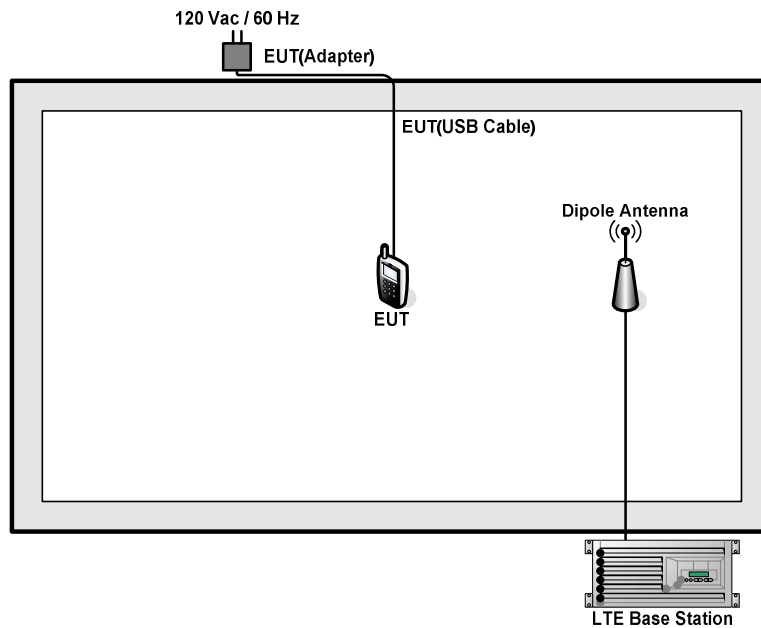

2.3 Support Unit used in test configuration and system

Item	Equipment	Trade Name	Model No.	FCC ID	Data Cable	Power Cord
1.	LTE Base Station	Anritsu	MT8820C	N/A	N/A	Unshielded, 1.8 m
2.	DC Power Supply	GW INSTRON	GPS-3030D	N/A	N/A	Unshielded, 1.8 m

2.4 Measurement Results Explanation Example

For all conducted test items:

The offset level is set in the spectrum analyzer to compensate the RF cable loss between RF conducted output port and spectrum analyzer. With the offset compensation, the spectrum analyzer reading level will be exactly the RF output level.

The spectrum analyzer offset is derived from RF cable loss.

$Offset = RF\ cable\ loss$

The following shows an offset computation example with RF cable loss 4.3dB.

Example :

$$Offset(dB) = RF\ cable\ loss(dB).$$

$$= 4.3\ (dB)$$



2.5 Frequency List of Low/Middle/High Channels

LTE Band 26 Channel and Frequency List				
BW [MHz]	Channel/Frequency(MHz)	Lowest	Middle	Highest
15	Channel	26765	-	-
	Frequency	821.5	-	-
10	Channel	-	26740	-
	Frequency	-	819	-
5	Channel	26715	26740	26765
	Frequency	816.5	819	821.5
3	Channel	26705	26740	26775
	Frequency	815.5	819	822.5
1.4	Channel	26697	26740	26783
	Frequency	814.7	819	823.3

3 Test Result

3.1 Conducted Output Power Measurement

3.1.1 Description of the Conducted Output Power Measurement

A system simulator was used to establish communication with the EUT. Its parameters were set to enforce EUT transmitting at the maximum power. The measured power in the radio frequency on the transmitter output terminals shall be reported.

3.1.2 Measuring Instruments

The measuring equipment is listed in the section 4 of this test report.

3.1.3 Test Procedures

1. The transmitter output port was connected to the system simulator.
2. Set EUT at maximum power through system simulator.
3. Select lowest, middle, and highest channels for each band and different modulation.
4. Measure and record the power level from the system simulator.

3.1.4 Test Setup

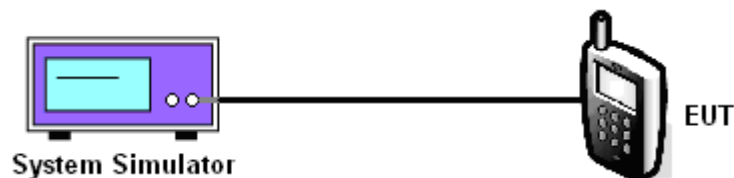

3.1.5 Test Result of Conducted Output Power

Please refer to Appendix A.

3.2 99% Occupied Bandwidth and 26dB Bandwidth Measurement

3.2.1 Description of (Occupied) Bandwidth Limitations Measurement

The 99% occupied bandwidth is the width of a frequency band such that, below the lower and above the upper frequency limits, the mean powers emitted are each equal to a specified percentage 0.5% of the total mean transmitted power.

The emission bandwidth is defined as the width of the signal between two points, located at the 2 sides of the carrier frequency, outside of which all emissions are attenuated at least 26 dB below the transmitter power.

3.2.2 Measuring Instruments

The measuring equipment is listed in the section 4 of this test report.

3.2.3 Test Procedures

1. The EUT was connected to spectrum analyzer and system simulator via a power divider.
2. The 26dB and 99% occupied bandwidth (BW) of the middle channel for the highest RF power with full RB sizes were measured.

3.2.4 Test Setup

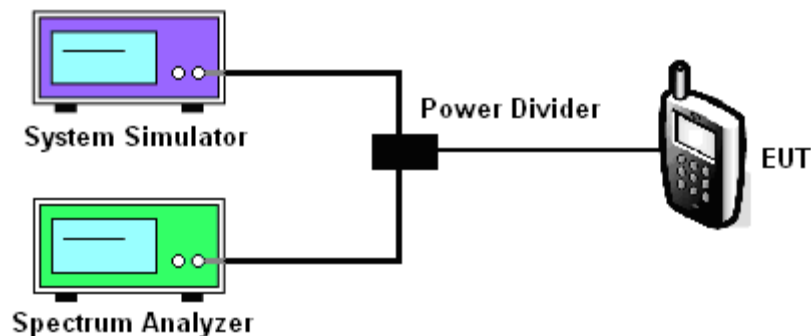

3.2.5 Test Result of 99% Occupied Bandwidth and 26dB Bandwidth

Please refer to Appendix A.



3.3 Emissions Mask Measurement

3.3.1 Description of Emissions Mask Measurement

Equipment used in this licensed to EA or non-EA systems shall comply with the emission mask provisions of FCC Part 90.691.(a)

(a) Out-of-band emission requirement shall apply only to the “outer” channels included in an EA license and to spectrum adjacent to interior channels used by incumbent licensees. The emission limits are as follows:

(1) For any frequency removed from the EA licensee's frequency block by up to and including 37.5 kHz, the power of any emission shall be attenuated below the transmitter power (P) in watts by at least $116 \text{ Log}_{10}(f/6.1)$ decibels or $50 + 10 \text{ Log}_{10}(P)$ decibels or 80 decibels, whichever is the lesser attenuation, where f is the frequency removed from the center of the outer channel in the block in kilohertz and where f is greater than 12.5 kHz.

(2) For any frequency removed from the EA licensee's frequency block greater than 37.5 kHz, the power of any emission shall be attenuated below the transmitter power (P) in watts by at least $43 + 10\text{Log}_{10}(P)$ decibels or 80 decibels, whichever is the lesser attenuation, where f is the frequency removed from the center of the outer channel in the block in kilohertz and where f is greater than 37.5 kHz.

3.3.2 Measuring Instruments

The measuring equipment is listed in the section 4 of this test report.

3.3.3 Test Procedures

1. The EUT was connected to spectrum analyzer and base station via power divider.
2. The emissions mask of low and high channels for the highest RF powers were measured.
3. The measured RBW and the VBW set 3 times of RBW are then set in spectrum analyzer, and the RBW correction factor $10\log (1\% \text{ of OBW/measured RBW})(\text{dB})$ was compensated, if required.
4. The test results were shown below plots with a correction offset factor including cable loss, insertion loss of power divider.

3.3.4 Test Setup

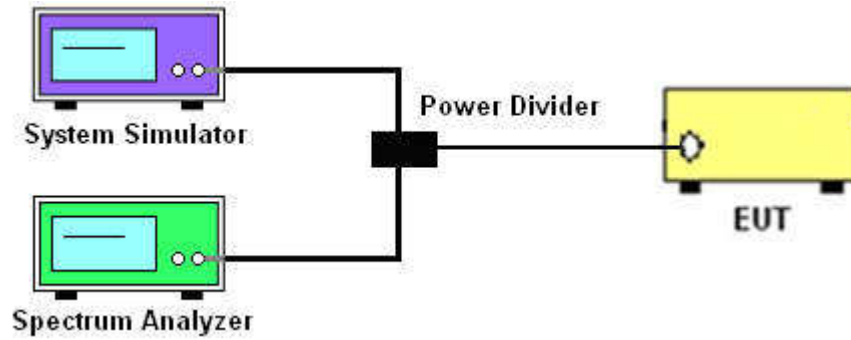

3.3.5 Test Result (Plots) of Conducted Emissions Mask

Please refer to Appendix A.



3.4 Emissions Mask – Out Of Band Emissions Measurement

3.4.1 Description of Conducted Emissions Out of band emissions measurement

The power of any emission FCC Part 90.691 (a)(2) on any frequency removed from the assigned frequency by out of the authorized bandwidth at least $43 + 10 \log (P)$ dB. It is measured by means of a calibrated spectrum analyzer and scanned from 30 MHz up to a frequency including its 10th harmonic.

3.4.2 Measuring Instruments

The measuring equipment is listed in the section 4 of this test report.

3.4.3 Test Procedures

1. The EUT was connected to spectrum analyzer and system simulator via a power divider.
2. The RF output of EUT was connected to the spectrum analyzer by RF cable and attenuator. The path loss was compensated to the results for each measurement.
3. The middle channel for the highest RF power within the transmitting frequency was measured.
4. The conducted spurious emission for the whole frequency range was taken.
5. Make the measurement with the spectrum analyzer's RBW = 1MHz, VBW = 3MHz, taking the record of maximum spurious emission.
6. The RF fundamental frequency should be excluded against the limit line in the operating frequency band.
7. The limit line is derived from $43 + 10\log(P)$ dB below the transmitter power P(Watts)
= P(W)- [43 + 10log(P)] (dB)
= [30 + 10log(P)] (dBm) - [43 + 10log(P)] (dB)
= -13dBm.

3.4.4 Test Setup

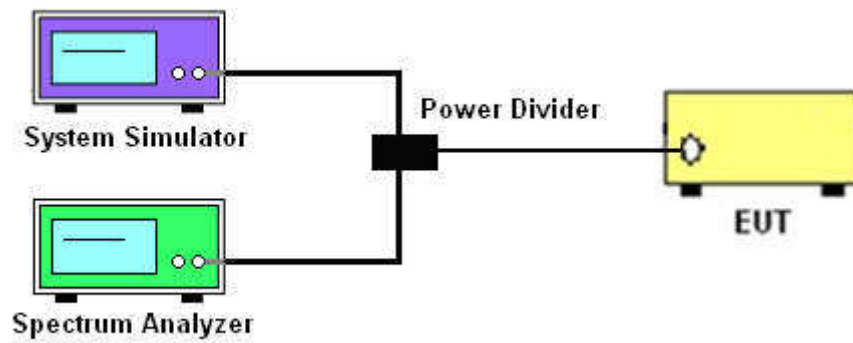

3.4.5 Test Result (Plots) of Conducted Emission

Please refer to Appendix A.



3.5 Field Strength of Spurious Radiation Measurement

3.5.1 Description of Field Strength of Spurious Radiated Measurement

The radiated spurious emission was measured by substitution method according to ANSI/TIA-603-E. The power of any emission FCC Part 90.691 on any frequency removed from the assigned frequency by more than 250 percent of the authorized bandwidth at least $43 + 10 \log (P)$ dB. The spectrum is scanned from 30 MHz up to a frequency including its 10th harmonic.

The power of any emission outside of the authorized operating frequency ranges must be attenuated below the transmitter power (P) by a factor of at least $43 + 10 \log_{10}(P[\text{Watts}])$ dB. The spectrum is scanned from 30 MHz up to a frequency including its 10th harmonic.

3.5.2 Measuring Instruments

The measuring equipment is listed in the section 4 of this test report.

3.5.3 Test Procedures

1. The EUT was placed on a turntable with 0.8 meter for frequency below 1GHz and 1.5 meter for frequency above 1GHz respectively above ground.
2. The EUT was set 3 meters from the receiving antenna, which was mounted on the antenna tower.
3. The table was rotated 360 degrees to determine the position of the highest spurious emission.
4. The height of the receiving antenna is varied between one meter and four meters to search the maximum spurious emission for both horizontal and vertical polarizations.
5. Make the measurement with the spectrum analyzer's RBW = 1MHz, VBW = 3MHz, Sweep = 500ms, Taking the record of maximum spurious emission.
6. A horn antenna was substituted in place of the EUT and was driven by a signal generator.
7. Tune the output power of signal generator to the same emission level with EUT maximum spurious emission.
8. Taking the record of output power at antenna port.
9. Repeat step 7 to step 8 for another polarization.
10. $\text{EIRP (dBm)} = \text{S.G. Power} - \text{Tx Cable Loss} + \text{Tx Antenna Gain}$
11. $\text{ERP (dBm)} = \text{EIRP} - 2.15$
12. The RF fundamental frequency should be excluded against the limit line in the operating frequency band.
13. The limit line is derived from $43 + 10 \log(P)$ dB below the transmitter power P(Watts)
 $= P(W) - [43 + 10 \log(P)]$ (dB)
 $= [30 + 10 \log(P)]$ (dBm) - $[43 + 10 \log(P)]$ (dB)
 $= -13\text{dBm}$.

3.5.4 Test Setup

For radiated test from 30MHz to 1GHz

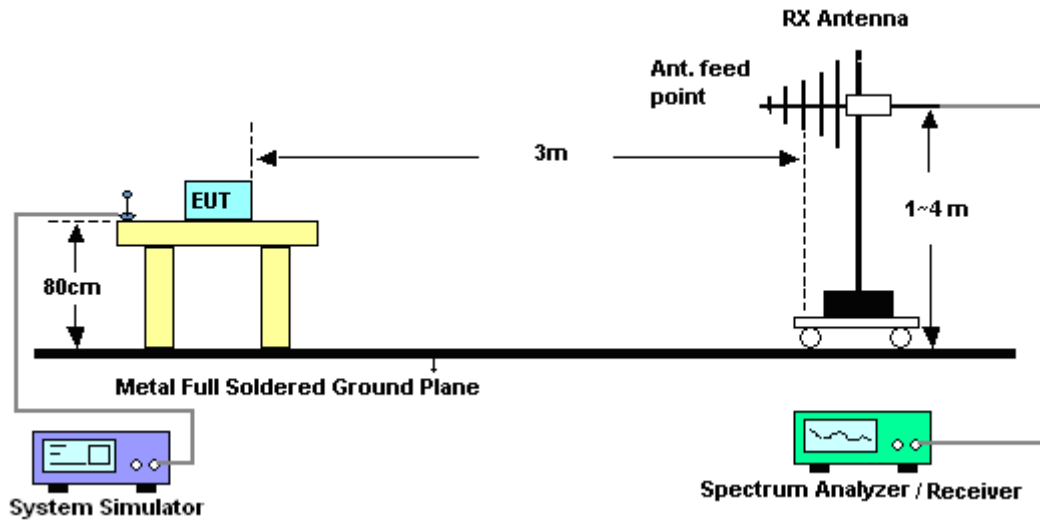

For radiated test above 1GHz

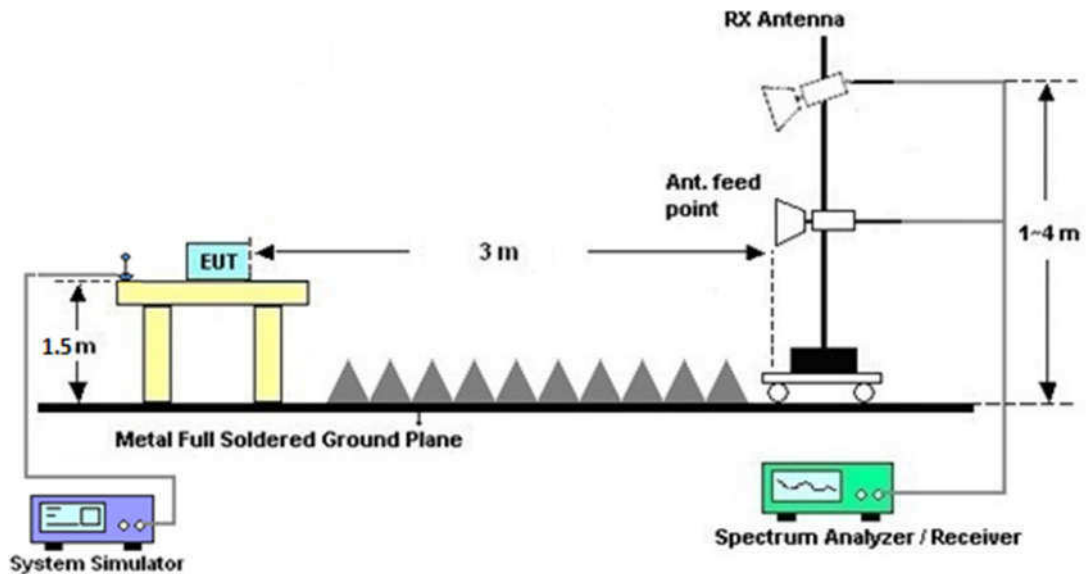

3.5.5 Test Result of Field Strength of Spurious Radiated

Please refer to Appendix B.



3.6 Frequency Stability Measurement

3.6.1 Description of Frequency Stability Measurement

The frequency stability shall be measured by variation of ambient temperature and variation of primary supply voltage to ensure that the fundamental emission stays within the authorized frequency block. The frequency stability of the transmitter shall be maintained within $\pm 0.00025\%$ ($\pm 2.5\text{ppm}$) of the center frequency according to FCC Part 90.213.

3.6.2 Measuring Instruments

The measuring equipment is listed in the section 4 of this test report.

3.6.3 Test Procedures for Temperature Variation

1. The EUT was set up in the thermal chamber and connected with the base station.
2. With power OFF, the temperature was decreased to -30°C and the EUT was stabilized for three hours. Power was applied and the maximum change in frequency was recorded within one minute.
3. With power OFF, the temperature was raised in 10°C step up to 50°C . The EUT was stabilized at each step for at least half an hour. Power was applied and the maximum frequency change was recorded within one minute.

3.6.4 Test Procedures for Voltage Variation

1. The EUT was placed in a temperature chamber at $20\pm 5^{\circ}\text{C}$ and connected with the base station.
2. The power supply voltage to the EUT was varied from BEP to 115% of the nominal value measured at the input to the EUT.
3. The variation in frequency was measured for the worst case.

3.6.5 Test Setup

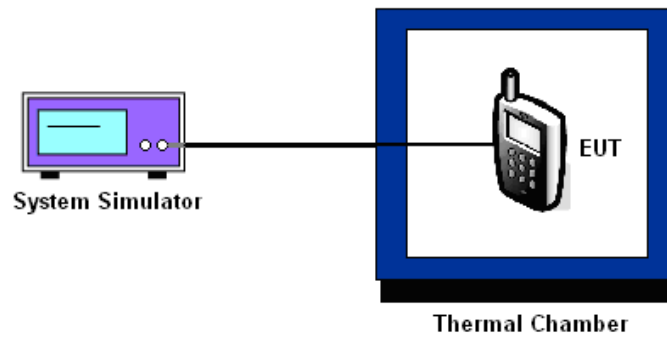

3.6.6 Test Result of Temperature Variation

Please refer to Appendix A.



4 List of Measuring Equipment

Instrument	Manufacturer	Model No.	Serial No.	Characteristics	Calibration Date	Test Date	Due Date	Remark
Spectrum Analyzer	R&S	FSV40	101040	10Hz~40GHz	Aug. 08, 2017	Aug. 18, 2017	Aug. 07, 2018	Conducted (TH01-KS)
Radio communication analyzer	Anritsu	MT8820C	6201300652	2G/3G/LTE_full band	Aug. 08, 2017	Aug. 18, 2017	Aug. 07, 2018	Conducted (TH01-KS)
Thermal Chamber	Hongzhan	LP-150U	HZ014011440	-40~+150°C	Apr.18, 2017	Aug. 18, 2017	Apr. 17, 2018	Conducted (TH01-KS)
EMI Test Receiver	R&S	ESR7	101404	9kHz~7GHz	Apr. 20, 2017	Oct. 04, 2017	Apr. 19, 2018	Radiation (03CH04-SZ)
EXA Spectrum Analyzer	KEYSIGHT	N9010A	MY55150213	10Hz~44GHz	Apr. 20, 2017	Oct. 04, 2017	Apr. 19, 2018	Radiation (03CH04-SZ)
Bilog Antenna	TeseQ	CBL6111D	41909	30MHz~1GHz	May 16, 2017	Oct. 04, 2017	May 15, 2018	Radiation (03CH04-SZ)
Double Ridge Horn Antenna	SCHWARZBECK	BBHA9120D	9120D-1474	1GHz~18GHz	Jan. 12, 2017	Oct. 04, 2017	Jan. 11, 2018	Radiation (03CH04-SZ)
Horn Antenna	SCHWARZBECK	BBHA9170	9170#679	15GHz~40GHz	May 17, 2017	Oct. 04, 2017	May 16, 2018	Radiation (03CH04-SZ)
Amplifier	Burgeon	BPA-530	102211	0.01Hz~3000MHz	Oct. 19, 2016	Oct. 04, 2017	Oct. 18, 2017	Radiation (03CH04-SZ)
HF Amplifier	MITEQ	AMF-7D-00101800-30-10P-R	1989346	1GHz~18GHz	Jul. 27, 2017	Oct. 04, 2017	Jul. 26, 2018	Radiation (03CH04-SZ)
Amplifier	Agilent Technologies	83017A	MY53270156	500MHz~26.5GHz	Apr. 20, 2017	Oct. 04, 2017	Apr. 19, 2018	Radiation (03CH04-SZ)
AC Power Source	Chroma	61601	N/A	N/A	NCR	Oct. 04, 2017	NCR	Radiation (03CH04-SZ)
Turn Table	EM	EM1000	N/A	0~360 degree	NCR	Oct. 04, 2017	NCR	Radiation (03CH04-SZ)
Antenna Mast	EM	EM1000	N/A	1 m~4 m	NCR	Oct. 04, 2017	NCR	Radiation (03CH04-SZ)

NCR: No Calibration Required



5 Uncertainty of Evaluation

Uncertainty of Radiated Emission Measurement (30 MHz ~ 1000 MHz)

Measuring Uncertainty for a Level of Confidence of 95% ($U = 2Uc(y)$)	2.8dB
---	-------

Uncertainty of Radiated Emission Measurement (1GHz ~ 18GHz)

Measuring Uncertainty for a Level of Confidence of 95% ($U = 2Uc(y)$)	3.1dB
---	-------

Uncertainty of Radiated Emission Measurement (18GHz ~ 40GHz)

Measuring Uncertainty for a Level of Confidence of 95% ($U = 2Uc(y)$)	3.9dB
---	-------



Appendix A. Test Results of Conducted Test

Conducted Output Power (Average power)

LTE Band 26 Maximum Average Power [dBm]						
BW [MHz]	RB Size	RB Offset	Mod	Lowest	Middle	Highest
15	1	0	QPSK	22.39	-	-
15	1	37		22.26		
15	1	74		22.98		
15	36	0		21.90		
15	36	20		21.57		
15	36	39		21.36		
15	75	0		21.50		
15	1	0	16-QAM	22.38		
15	1	37		21.73		
15	1	74		22.24		
15	36	0		20.70		
15	36	20		20.52		
15	36	39		20.28		
15	75	0		20.54		
10	1	0	QPSK	-	22.45	-
10	1	25			22.2	
10	1	49			22.54	
10	25	0			21.34	
10	25	12			21.31	
10	25	25			21.38	
10	50	0			21.42	
10	1	0	16-QAM		21.89	
10	1	25			21.59	
10	1	49			21.89	
10	25	0			20.33	
10	25	12			20.31	
10	25	25			20.33	
10	50	0			20.35	



LTE Band 26 Maximum Average Power [dBm]						
BW [MHz]	RB Size	RB Offset	Mod	Lowest	Middle	Highest
5	1	0	QPSK	22.15	22.17	22.04
5	1	12		22.07	22.03	22.06
5	1	24		22.1	22.11	22.16
5	12	0		21.17	21.29	21.27
5	12	7		21.26	21.27	21.18
5	12	13		21.2	21.23	21.21
5	25	0		21.22	21.27	21.23
5	1	0	16-QAM	21.56	21.83	21.31
5	1	12		21.54	21.63	21.86
5	1	24		21.36	21.65	21.68
5	12	0		20.2	20.25	20.24
5	12	7		20.24	20.32	20.25
5	12	13		20.27	20.23	20.28
5	25	0		20.32	20.25	20.19
3	1	0	QPSK	22.13	22.05	22.22
3	1	8		22.01	22.14	22.29
3	1	14		22.08	22.11	22.16
3	8	0		21.24	21.24	21.18
3	8	4		21.24	21.3	21.26
3	8	7		21.14	21.17	21.23
3	15	0		21.17	21.24	21.21
3	1	0	16-QAM	21.2	21.23	21.49
3	1	8		21.45	21.41	21.48
3	1	14		21.52	21.55	21.37
3	8	0		20.36	20.31	20.23
3	8	4		20.27	20.31	20.35
3	8	7		20.24	20.31	20.33
3	15	0		20.18	20.24	20.23



LTE Band 26 Maximum Average Power [dBm]						
BW [MHz]	RB Size	RB Offset	Mod	Lowest	Middle	Highest
1.4	1	0	QPSK	22.19	22.07	22.06
1.4	1	3		22.32	22.37	22.37
1.4	1	5		22.2	22.05	22.15
1.4	3	0		22.11	22.1	22.16
1.4	3	1		22.15	22.15	22.15
1.4	3	3		22.06	22.17	22.23
1.4	6	0		21.17	21.26	21.26
1.4	1	0	16-QAM	21.31	21.49	21.36
1.4	1	3		21.56	21.6	21.39
1.4	1	5		21.37	21.31	21.44
1.4	3	0		21.15	21.24	21.2
1.4	3	1		21.21	21.28	21.22
1.4	3	3		21.25	21.34	21.36
1.4	6	0		20.18	20.19	20.25



26dB Bandwidth

Mode	LTE Band 26 : 26dB BW(MHz)											
	1.4MHz		3MHz		5MHz		10MHz		15MHz		20MHz	
BW	QPSK	16QAM	QPSK	16QAM	QPSK	16QAM	QPSK	16QAM	QPSK	16QAM	QPSK	16QAM
Lowest CH	1.234	1.242	3.027	3.015	5.015	4.825	-	-	14.386	14.535	-	-
Middle CH	1.217	1.225	3.015	2.979	4.875	4.925	9.71	9.95	-	-	-	-
Highest CH	1.225	1.236	3.027	3.003	4.925	4.935	-	-	-	-	-	-



LTE Band 26

Lowest Channel / 1.4MHz / QPSK

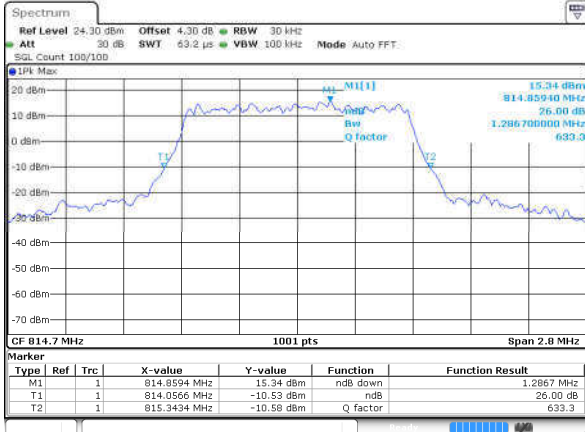

Date: 18 AUG 2017 20:08:44

Lowest Channel / 1.4MHz / 16QAM

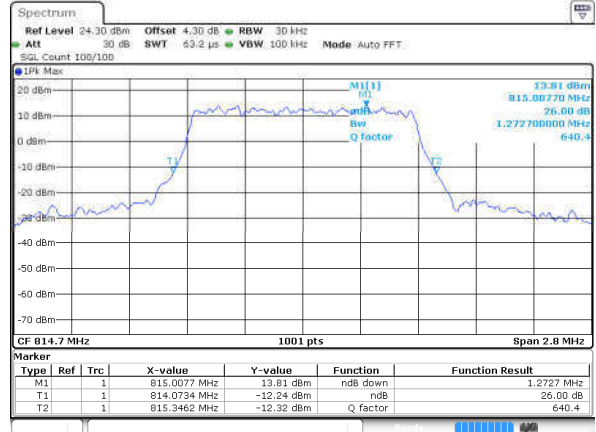

Date: 18 AUG 2017 20:09:05

Middle Channel / 1.4MHz / QPSK

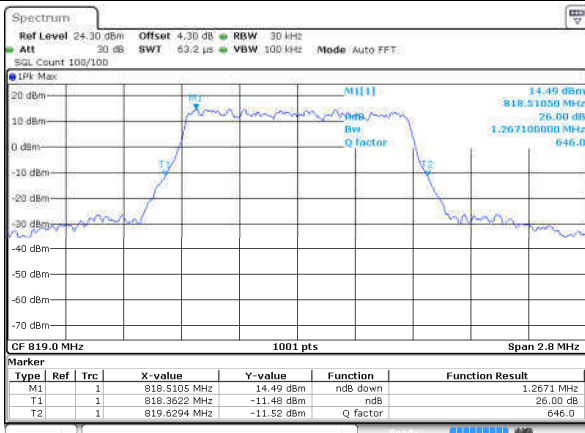

Date: 18 AUG 2017 20:10:41

Middle Channel / 1.4MHz / 16QAM

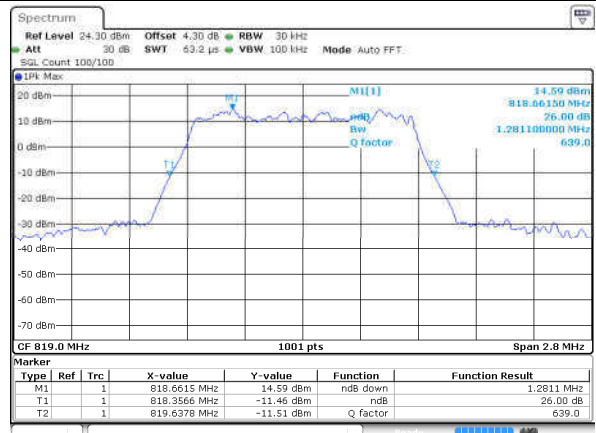

Date: 18 AUG 2017 20:10:21

Highest Channel / 1.4MHz / QPSK

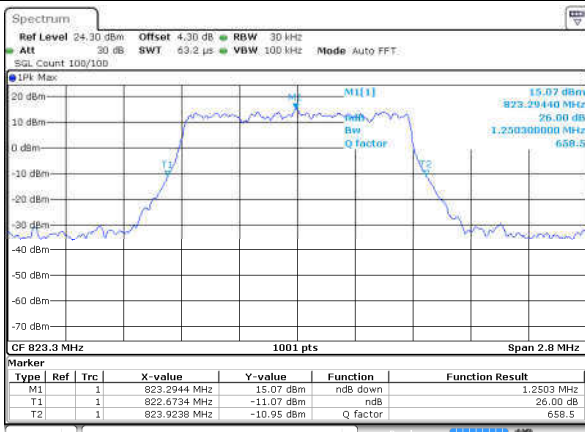

Date: 18 AUG 2017 20:11:30

Highest Channel / 1.4MHz / 16QAM

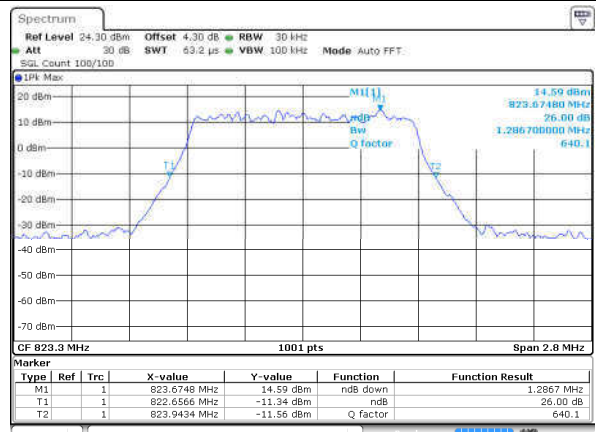

Date: 18 AUG 2017 20:11:57



LTE Band 26

Lowest Channel / 3MHz / QPSK

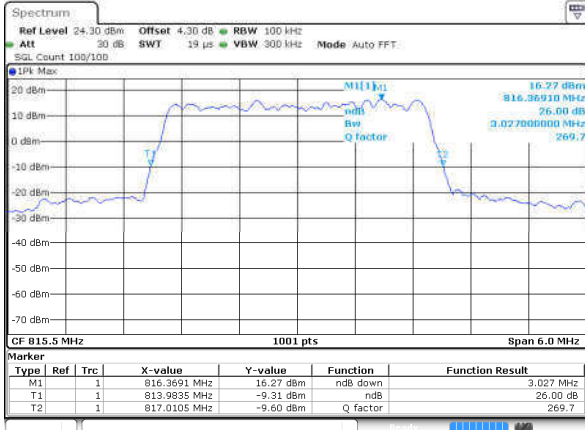

Date: 18 AUG 2017 20:16:45

Lowest Channel / 3MHz / 16QAM

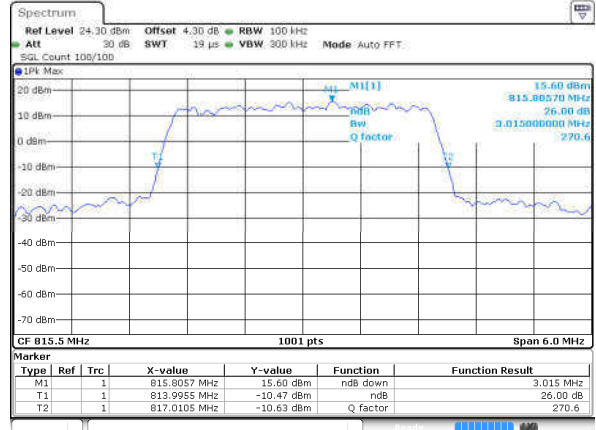

Date: 18 AUG 2017 20:16:20

Middle Channel / 3MHz / QPSK

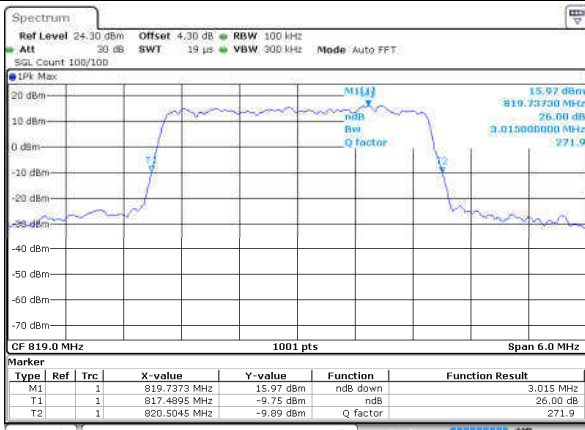

Date: 18 AUG 2017 20:17:25

Middle Channel / 3MHz / 16QAM

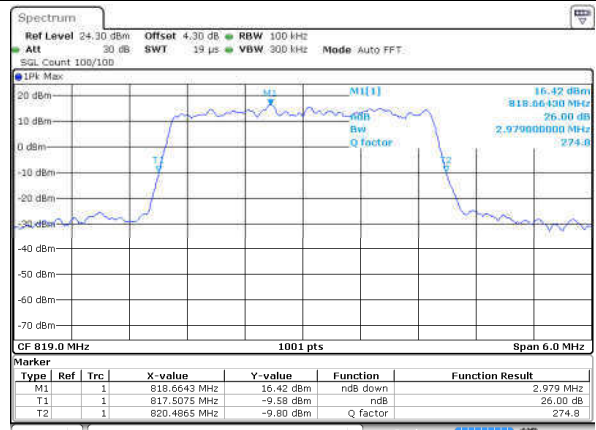

Date: 18 AUG 2017 20:17:50

Highest Channel / 3MHz / QPSK

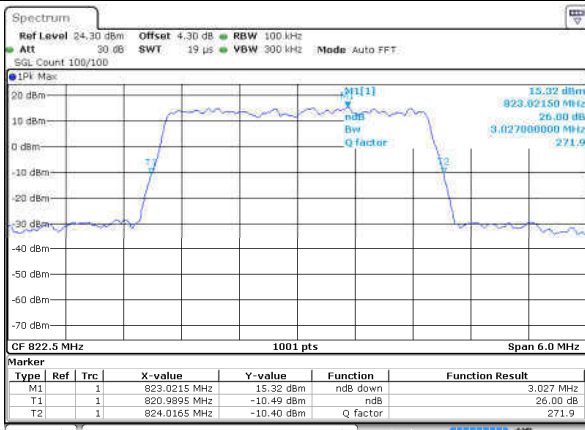

Date: 18 AUG 2017 20:19:16

Highest Channel / 3MHz / 16QAM

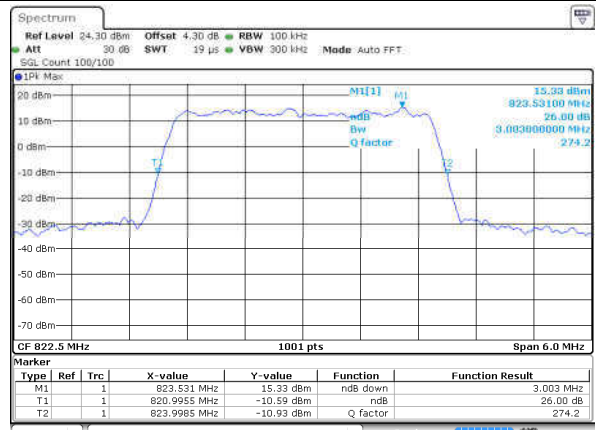

Date: 18 AUG 2017 20:18:56



LTE Band 26

Lowest Channel / 5MHz / QPSK

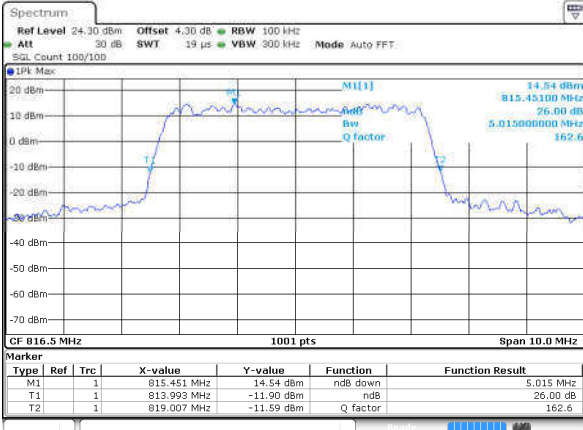

Date: 18 AUG 2017 20:19:41

Lowest Channel / 5MHz / 16QAM

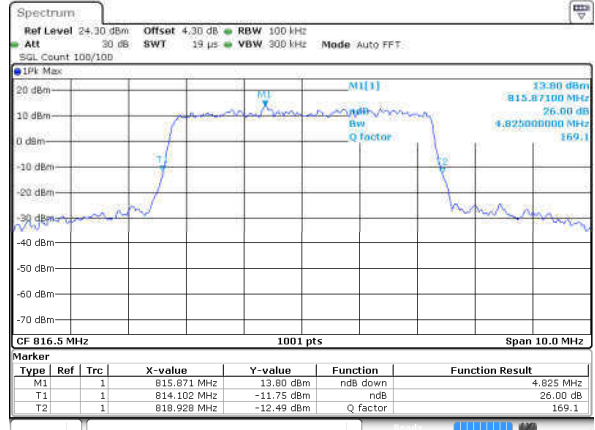

Date: 18 AUG 2017 20:20:02

Middle Channel / 5MHz / QPSK

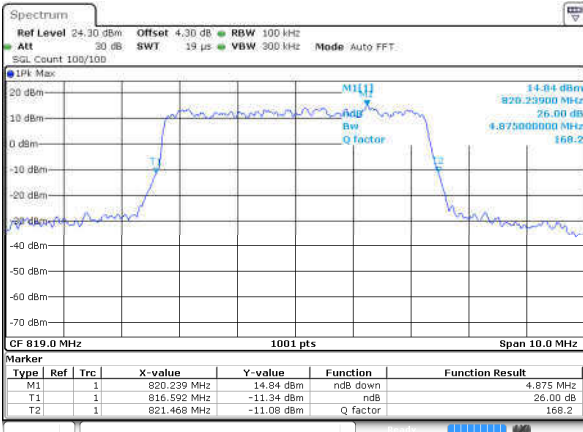

Date: 18 AUG 2017 20:21:43

Middle Channel / 5MHz / 16QAM

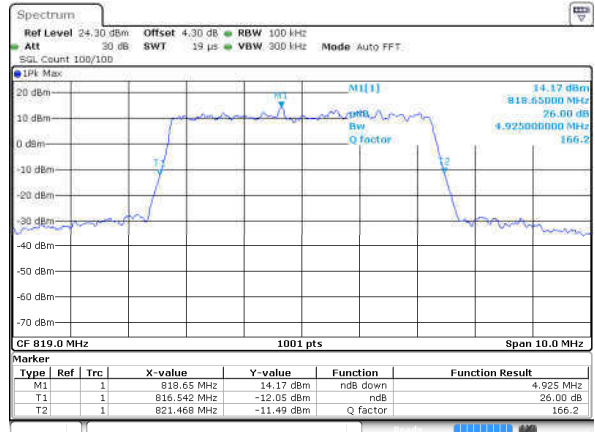

Date: 18 AUG 2017 20:21:24

Highest Channel / 5MHz / QPSK

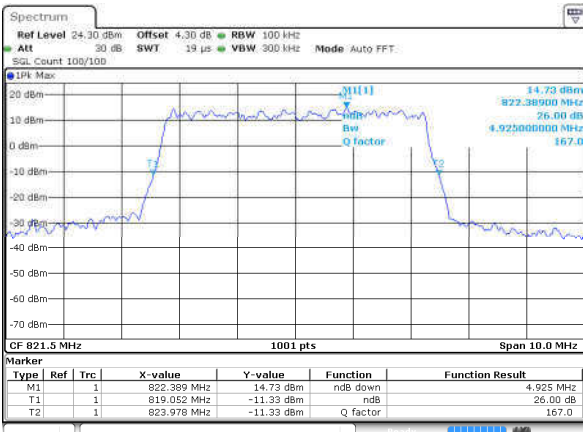

Date: 18 AUG 2017 20:22:07

Highest Channel / 5MHz / 16QAM

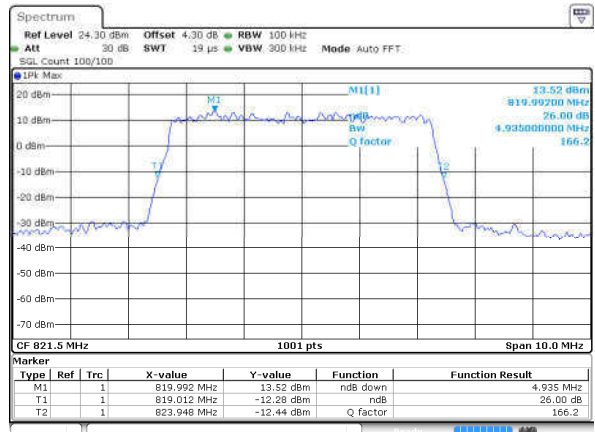

Date: 18 AUG 2017 20:22:27



LTE Band 26

Middle Channel / 10MHz / QPSK

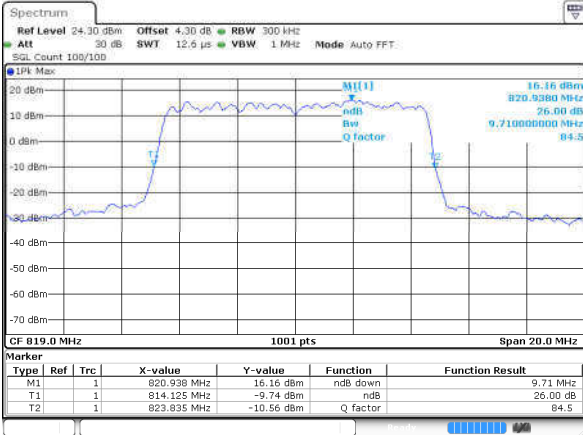

Date: 18 AUG 2017 20:23:55

Middle Channel / 10MHz / 16QAM

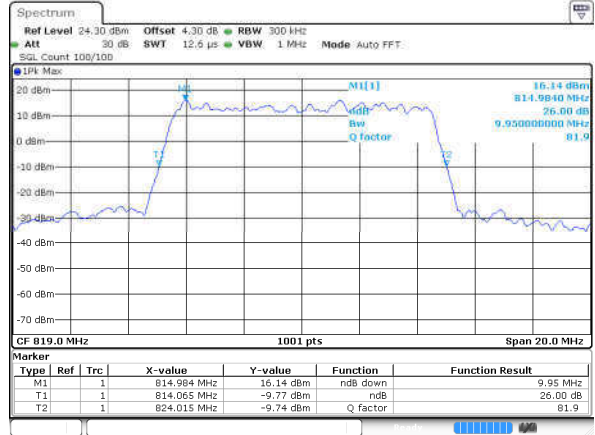

Date: 18 AUG 2017 20:23:34

Lowest Channel / 15MHz / QPSK

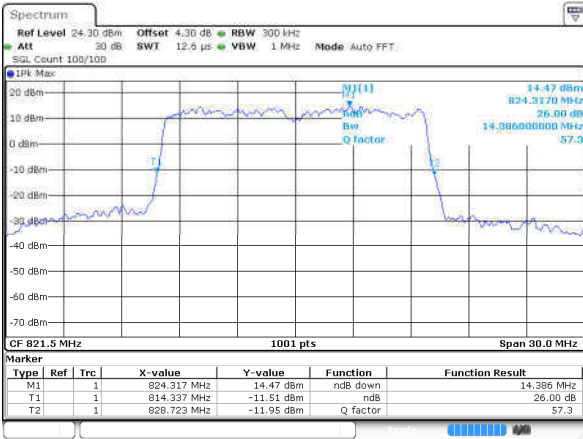

Date: 18 AUG 2017 20:24:23

Lowest Channel / 15MHz / 16QAM

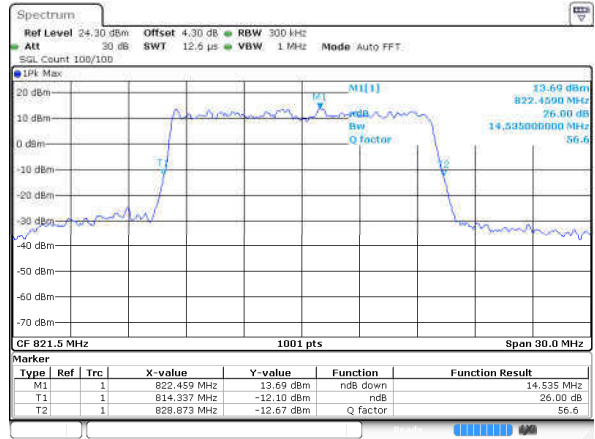

Date: 18 AUG 2017 20:24:44



Occupied Bandwidth

Mode	LTE Band 26 : 99%OBW(MHz)											
	1.4MHz		3MHz		5MHz		10MHz		15MHz		20MHz	
BW	QPSK	16QAM	QPSK	16QAM	QPSK	16QAM	QPSK	16QAM	QPSK	16QAM	QPSK	16QAM
Lowest CH	1.09	1.09	2.72	2.72	4.49	4.48	-	-	13.43	13.43	-	-
Middle CH	1.09	1.09	2.73	2.72	4.48	4.50	9.03	8.97	-	-	-	-
Highest CH	1.09	1.09	27.2	2.71	4.49	4.50	-	-	-	-	-	-



LTE Band 26

Lowest Channel / 1.4MHz / QPSK

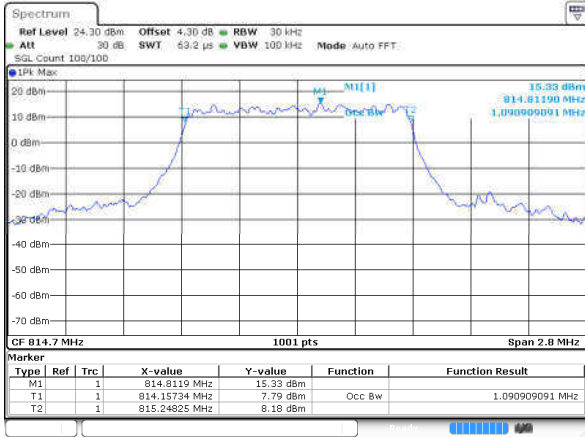

Date: 18 AUG 2017 20:08:31

Lowest Channel / 1.4MHz / 16QAM

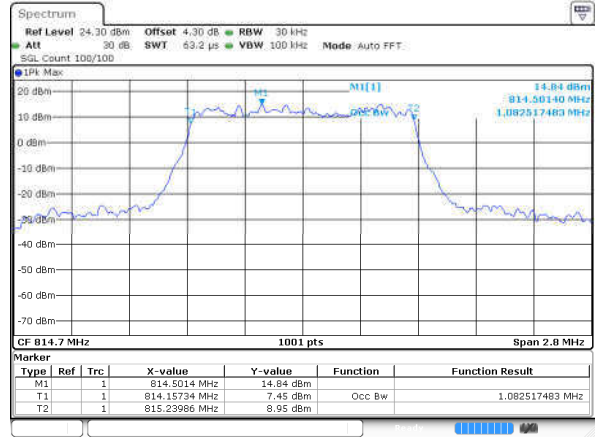

Date: 18 AUG 2017 20:08:57

Middle Channel / 1.4MHz / QPSK

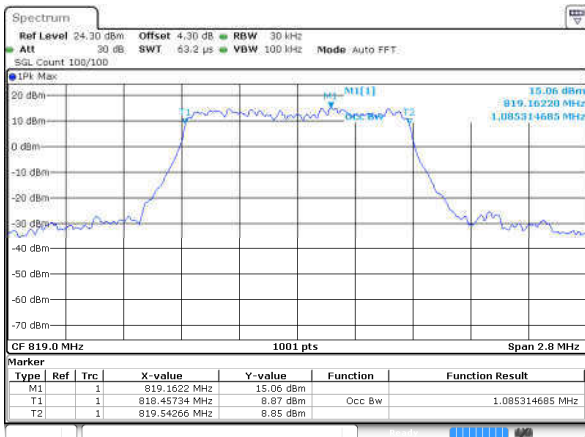

Date: 18 AUG 2017 20:10:32

Middle Channel / 1.4MHz / 16QAM

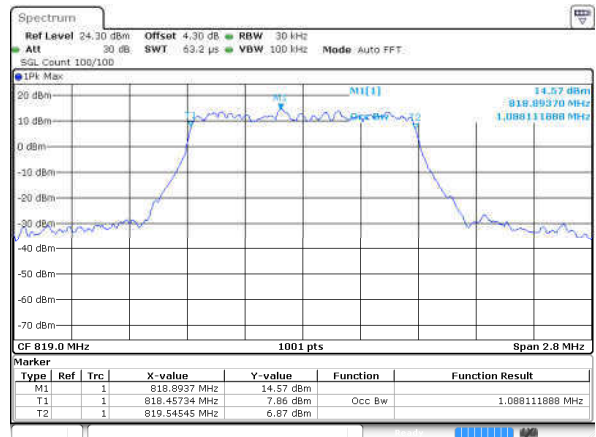

Date: 18 AUG 2017 20:10:10

Highest Channel / 1.4MHz / QPSK

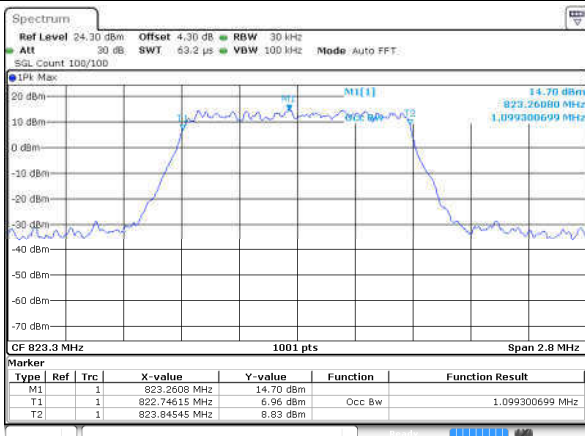

Date: 18 AUG 2017 20:11:19

Highest Channel / 1.4MHz / 16QAM

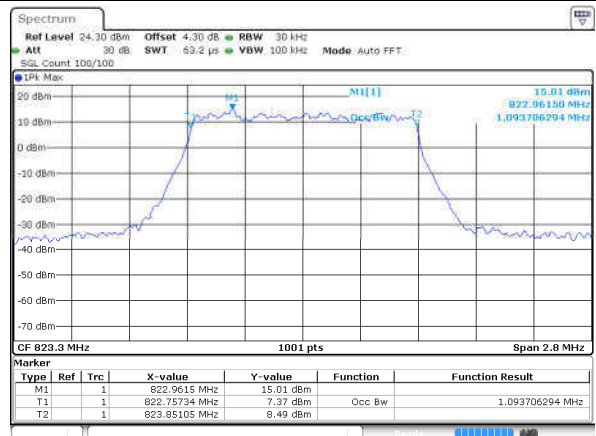

Date: 18 AUG 2017 20:11:48



LTE Band 26

Lowest Channel / 3MHz / QPSK

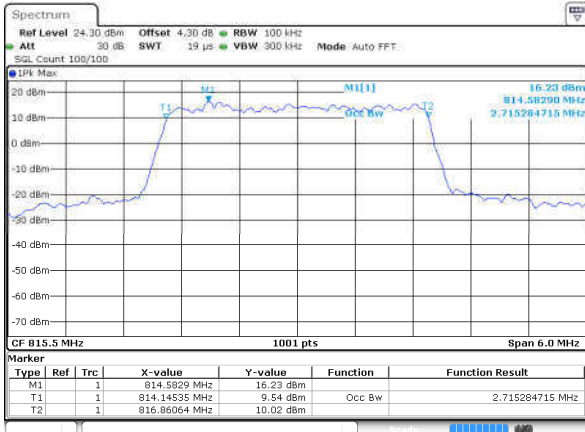

Date: 18 AUG 2017 20:16:35

Lowest Channel / 3MHz / 16QAM

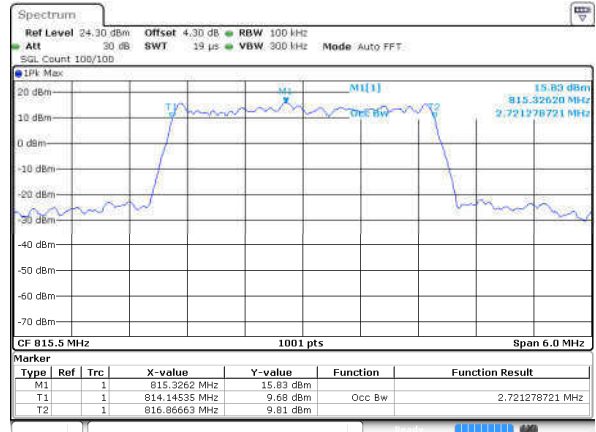

Date: 18 AUG 2017 20:16:08

Middle Channel / 3MHz / QPSK

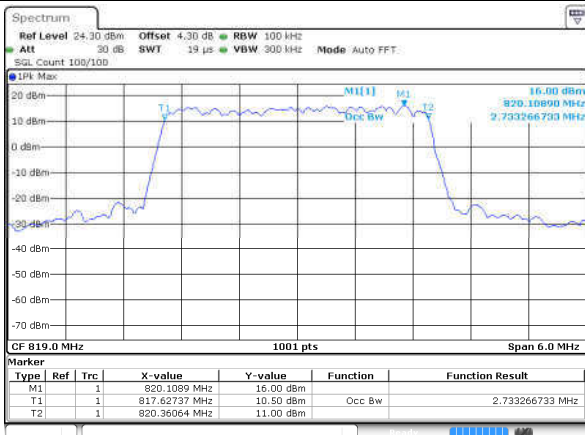

Date: 18 AUG 2017 20:17:15

Middle Channel / 3MHz / 16QAM

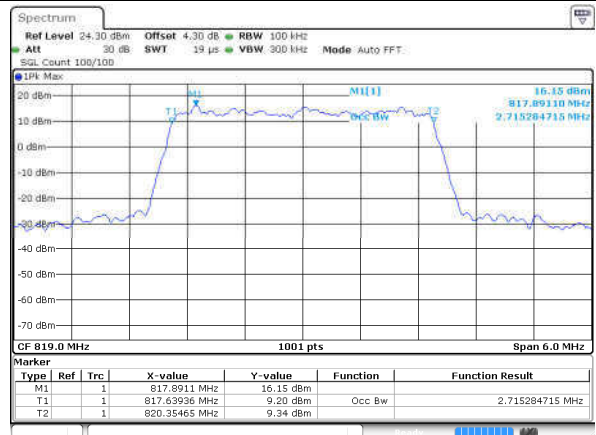

Date: 18 AUG 2017 20:17:41

Highest Channel / 3MHz / QPSK

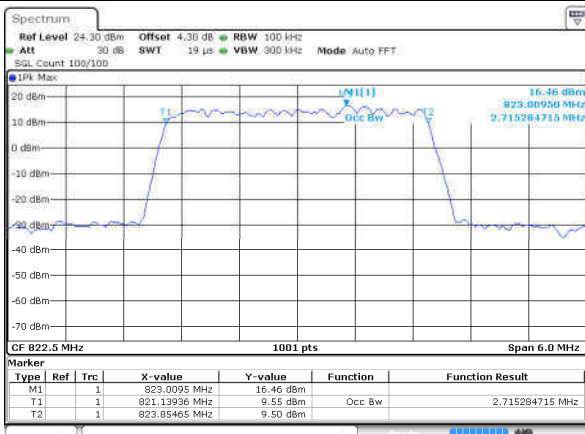

Date: 18 AUG 2017 20:19:07

Highest Channel / 3MHz / 16QAM

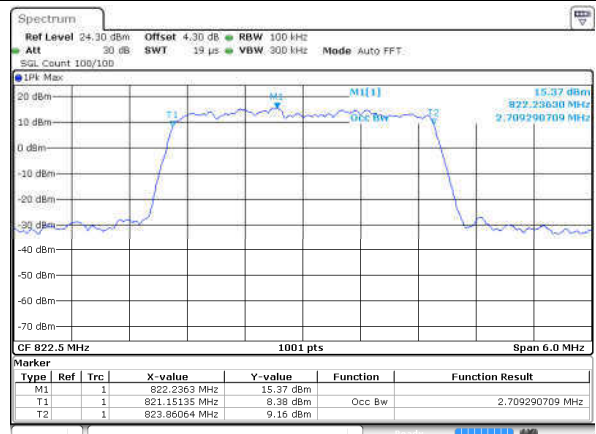

Date: 18 AUG 2017 20:18:47



LTE Band 26

Lowest Channel / 5MHz / QPSK

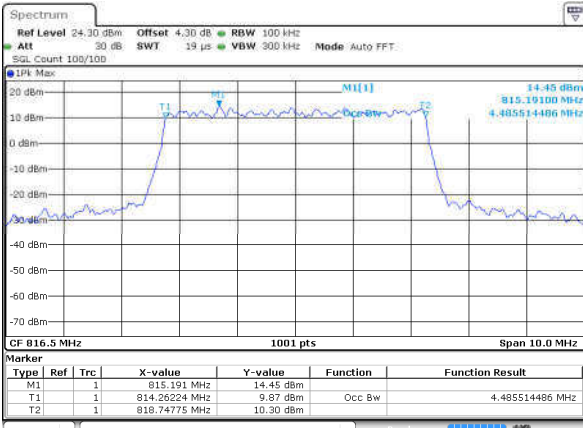

Date: 18 AUG 2017 20:19:31

Lowest Channel / 5MHz / 16QAM

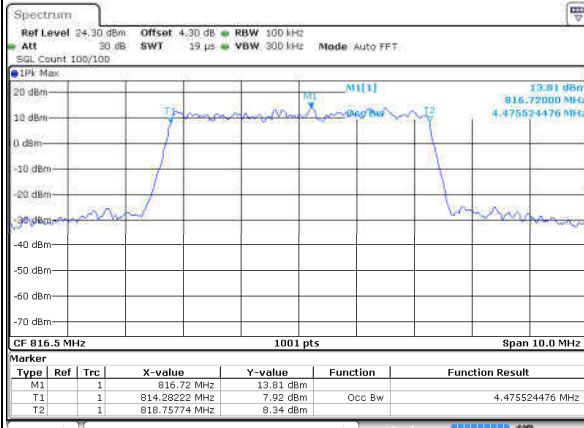

Date: 18 AUG 2017 20:19:53

Middle Channel / 5MHz / QPSK

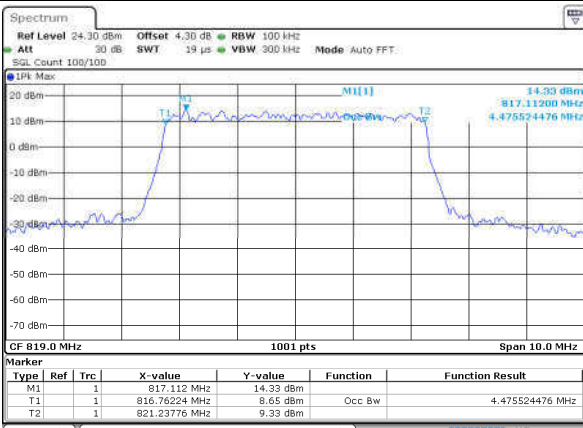

Date: 18 AUG 2017 20:21:35

Middle Channel / 5MHz / 16QAM

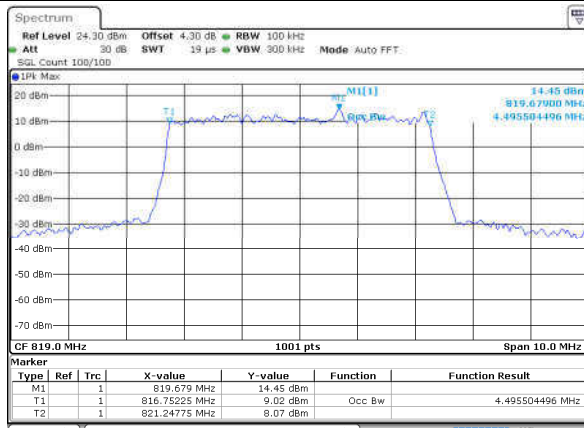

Date: 18 AUG 2017 20:21:15

Highest Channel / 5MHz / QPSK

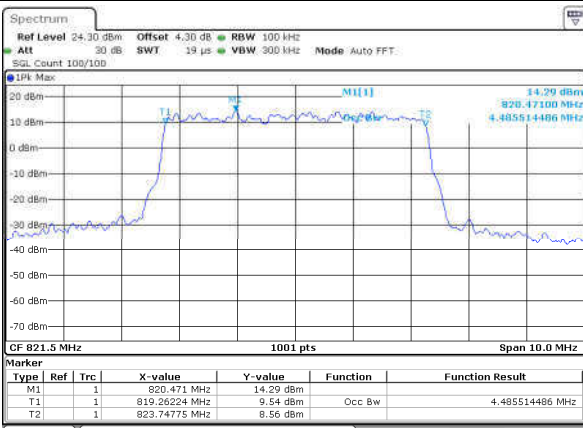

Date: 18 AUG 2017 20:21:58

Highest Channel / 5MHz / 16QAM

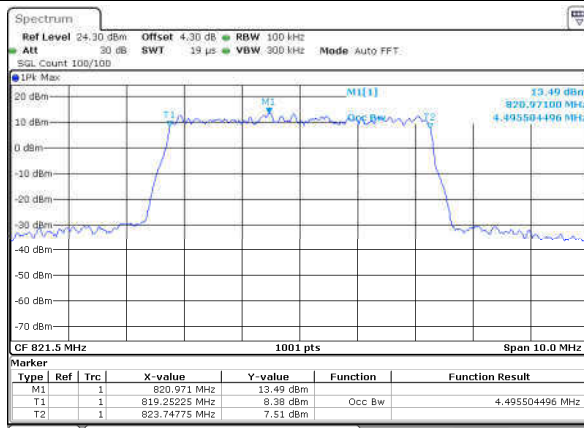

Date: 18 AUG 2017 20:22:18



LTE Band 26

Middle Channel / 10MHz / QPSK

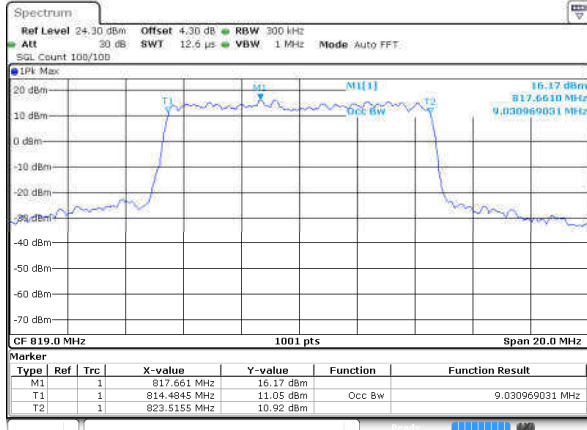

Date: 18 AUG.2017 20:23:45

Middle Channel / 10MHz / 16QAM

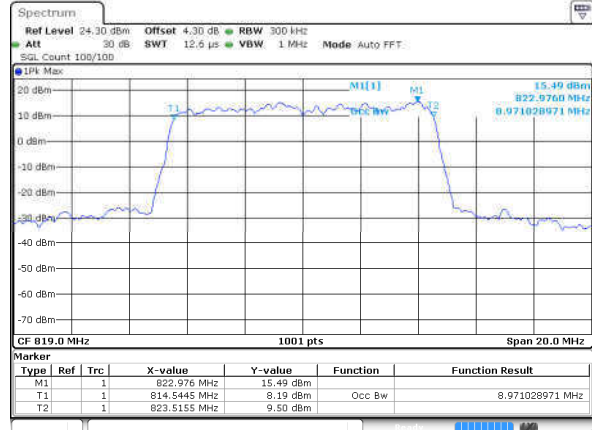

Date: 18 AUG.2017 20:23:25

LTE Band 26

Lowest Channel / 15MHz / QPSK

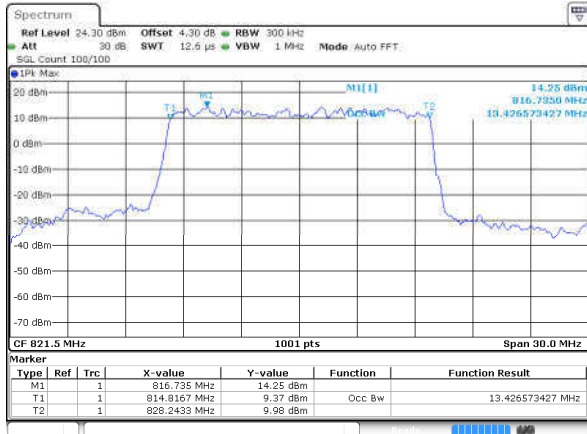

Date: 18 AUG.2017 20:24:12

Lowest Channel / 15MHz / 16QAM

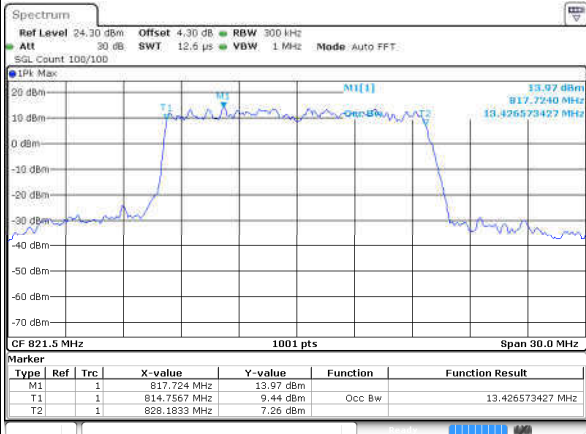

Date: 18 AUG.2017 20:24:35



Conducted Band Edge

LTE Band 26 / 1.4MHz / QPSK

Lowest Band Edge / 1RB

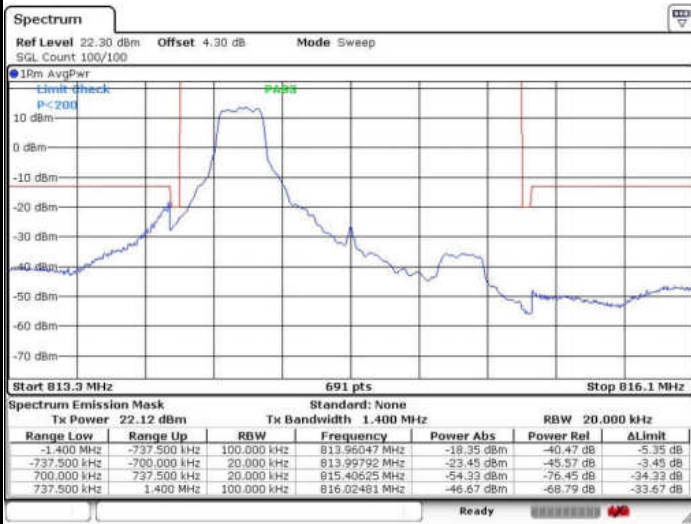

Highest Band Edge / 1RB

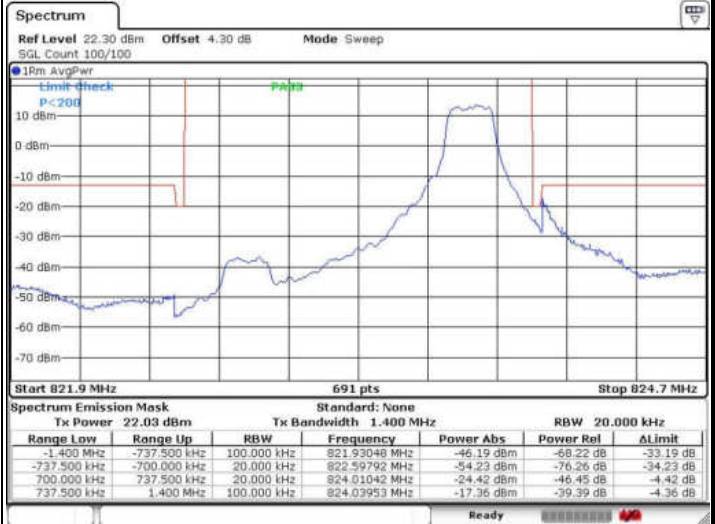

Lowest Band Edge / Full RB

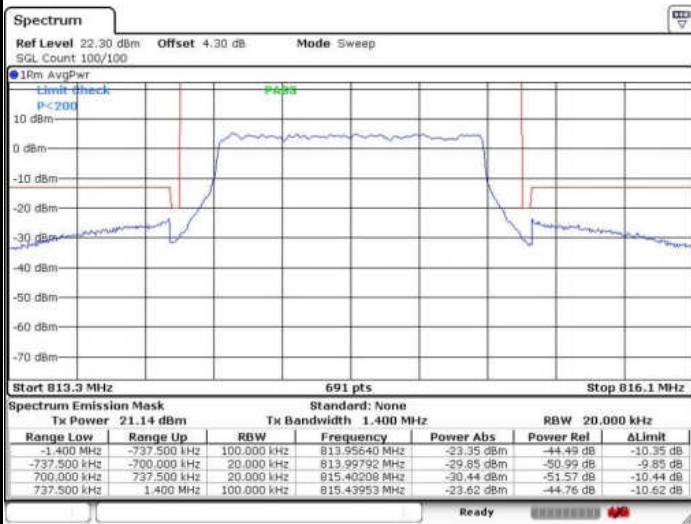

Highest Band Edge / Full RB

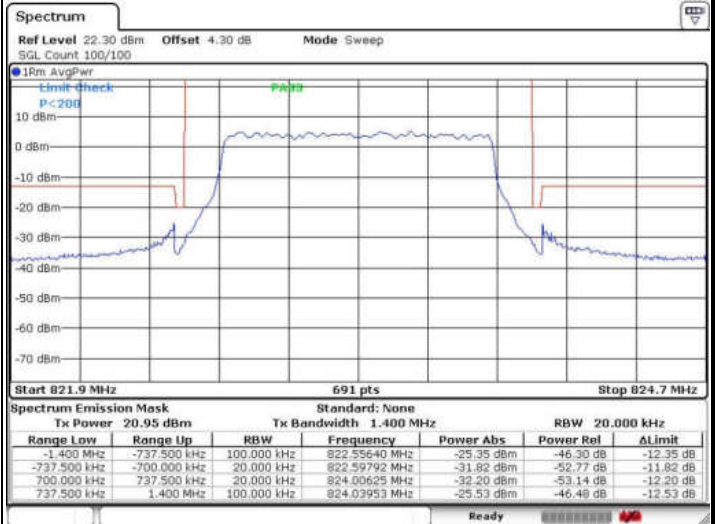



LTE Band 26 / 1.4MHz / 16QAM

Lowest Band Edge / 1 RB

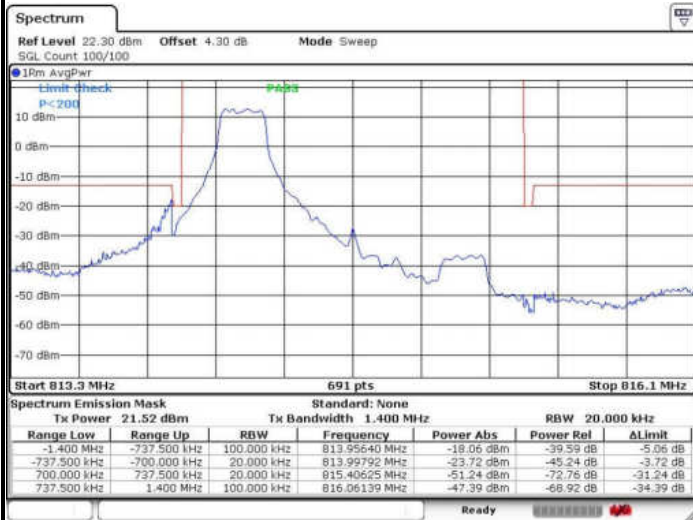

Date: 18 AUG 2017 18:49:48

Highest Band Edge / 1 RB

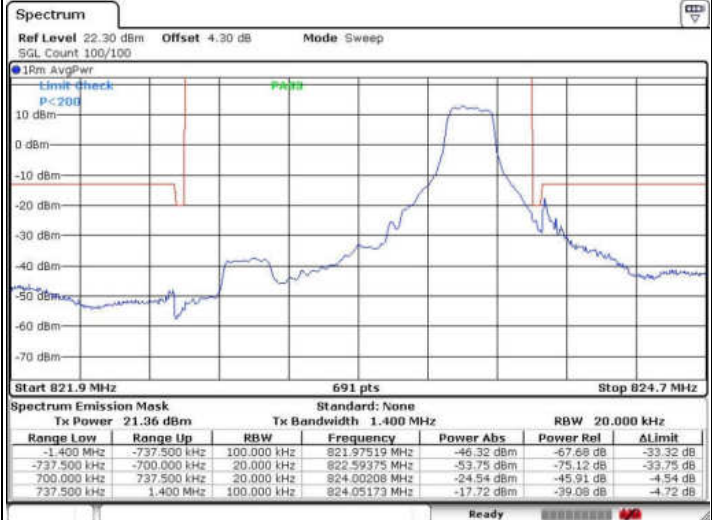

Date: 18 AUG 2017 18:55:53

Lowest Band Edge / Full RB

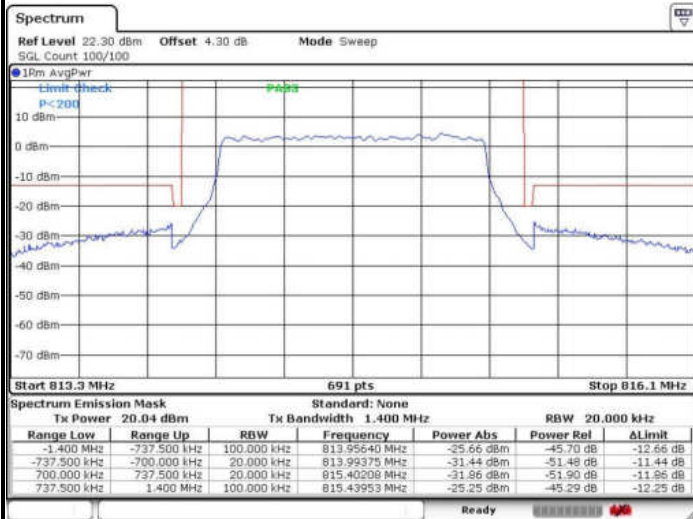

Date: 18 AUG 2017 18:49:27

Highest Band Edge / Full RB

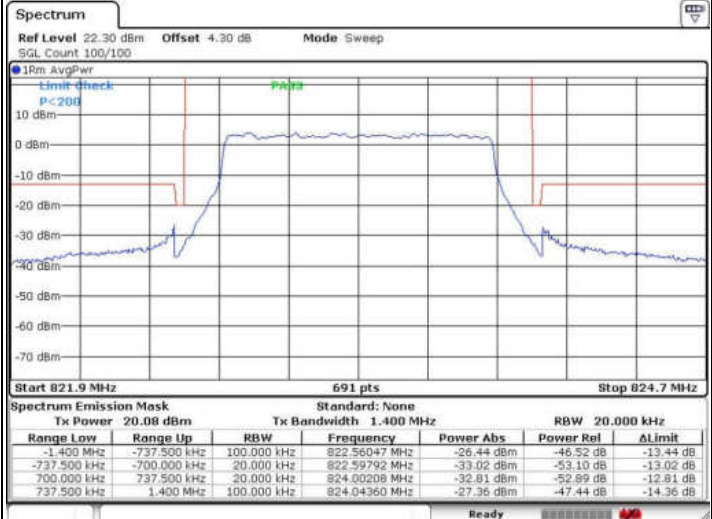

Date: 18 AUG 2017 18:57:32



LTE Band 26 / 3MHz / QPSK

Lowest Band Edge / 1RB

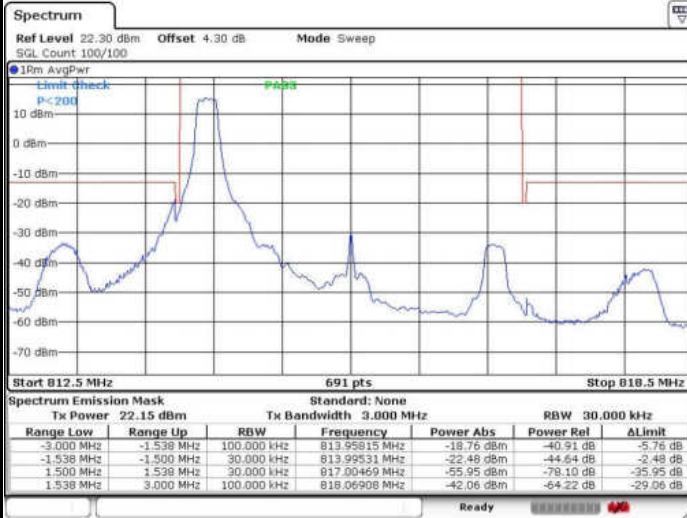

Date: 18 AUG 2017 19:12:29

Highest Band Edge / 1 RB

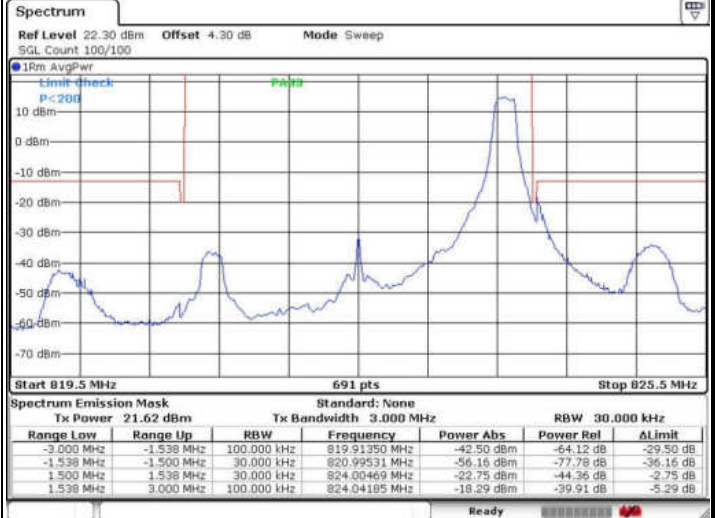

Date: 18 AUG 2017 19:17:12

Lowest Band Edge / Full RB

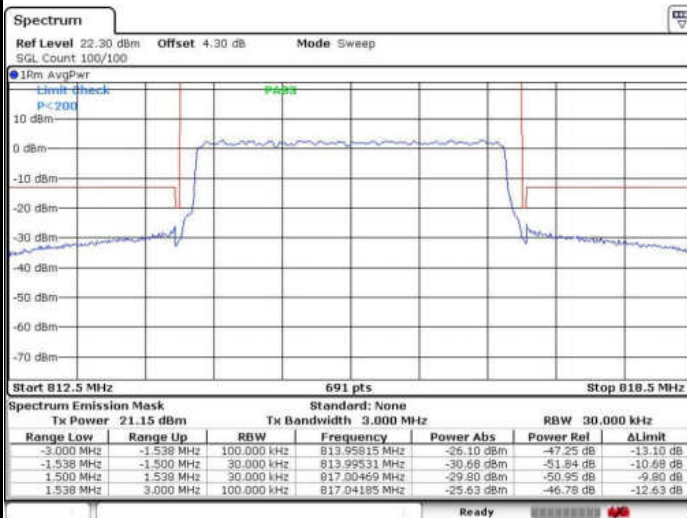

Date: 18 AUG 2017 19:12:46

Highest Band Edge / Full RB

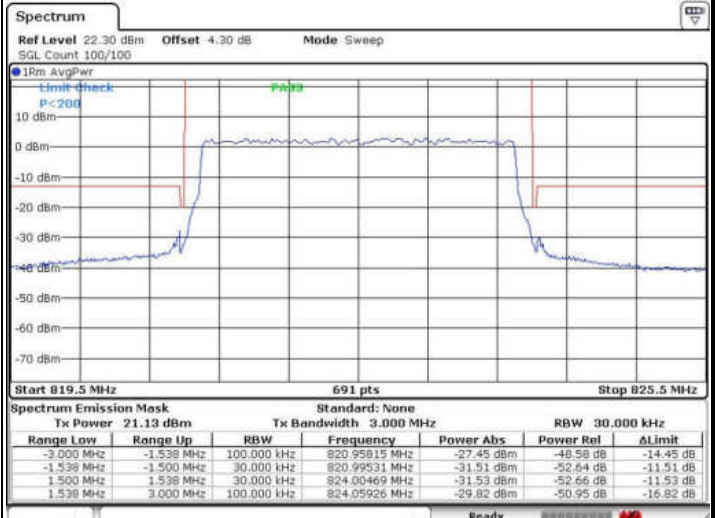

Date: 18 AUG 2017 19:16:43



LTE Band 26 / 3MHz / 16QAM

Lowest Band Edge / 1 RB

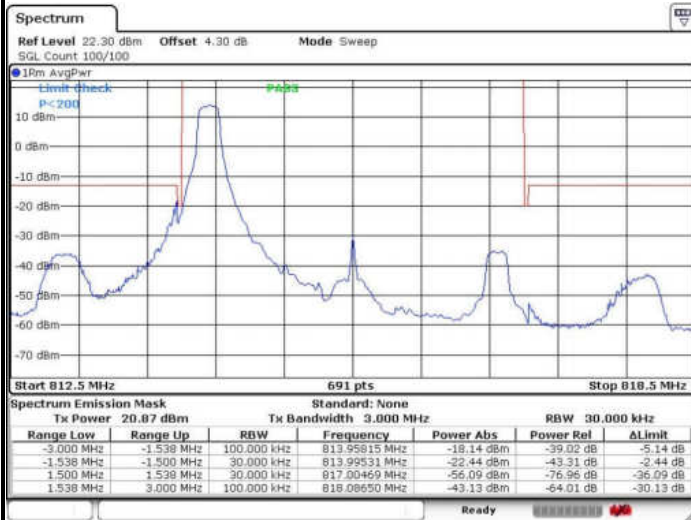

Date: 18 AUG 2017 19:12:15

Highest Band Edge / 1 RB

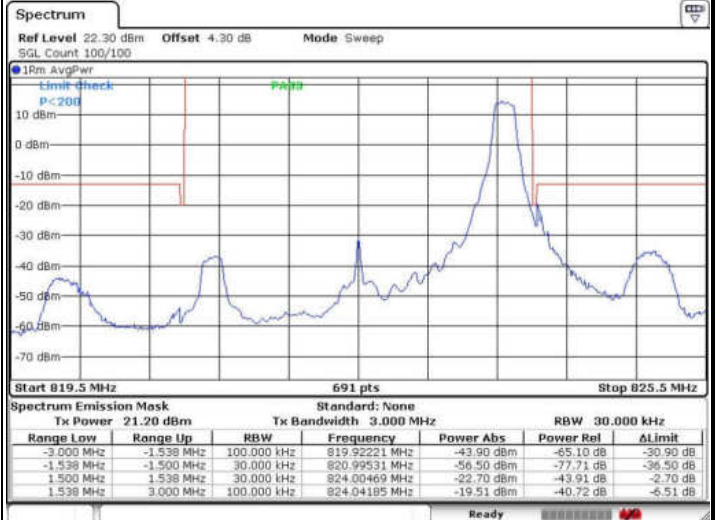

Date: 18 AUG 2017 19:18:13

Lowest Band Edge / Full RB

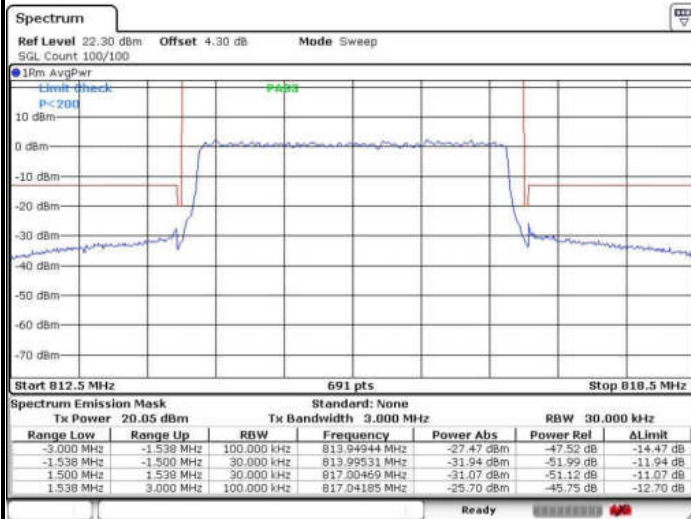

Date: 18 AUG 2017 19:13:03

Highest Band Edge / Full RB

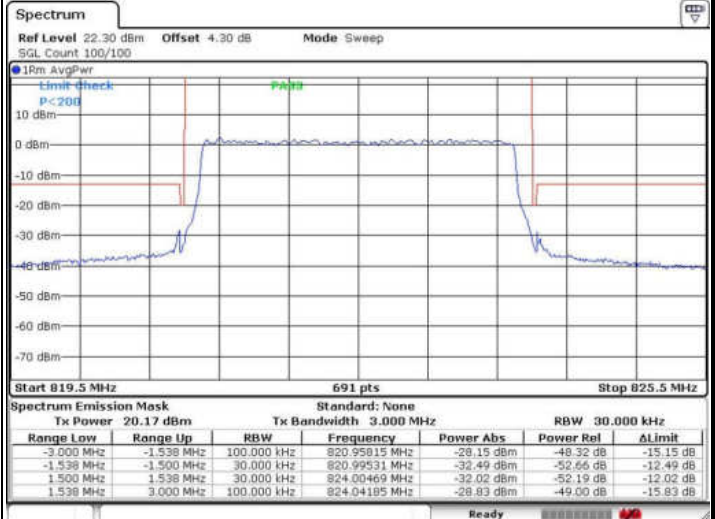

Date: 18 AUG 2017 19:16:22



LTE Band 26 / 5MHz / QPSK

Lowest Band Edge / 1 RB

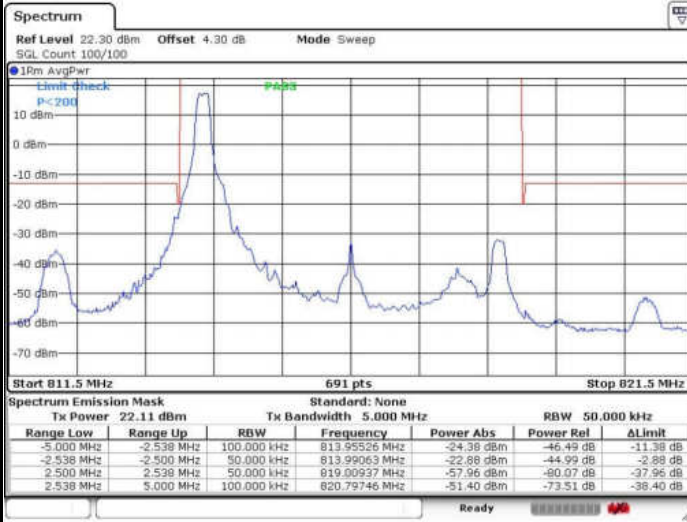

Date: 18 AUG 2017 19:22:44

Highest Band Edge / 1 RB

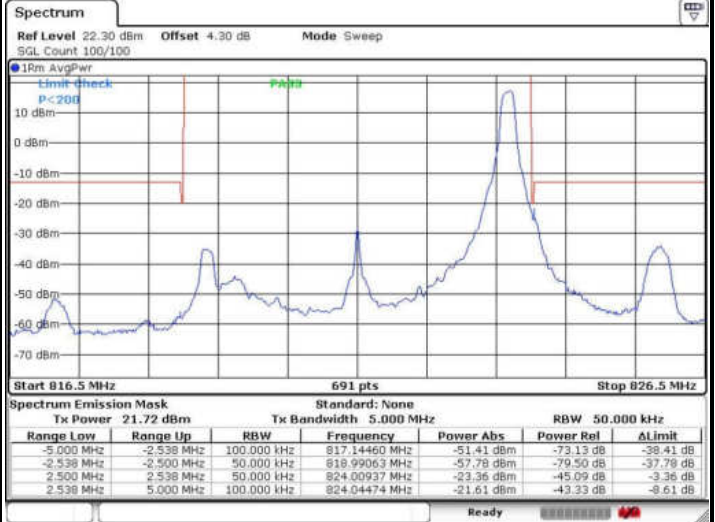

Date: 18 AUG 2017 19:28:33

Lowest Band Edge / Full RB

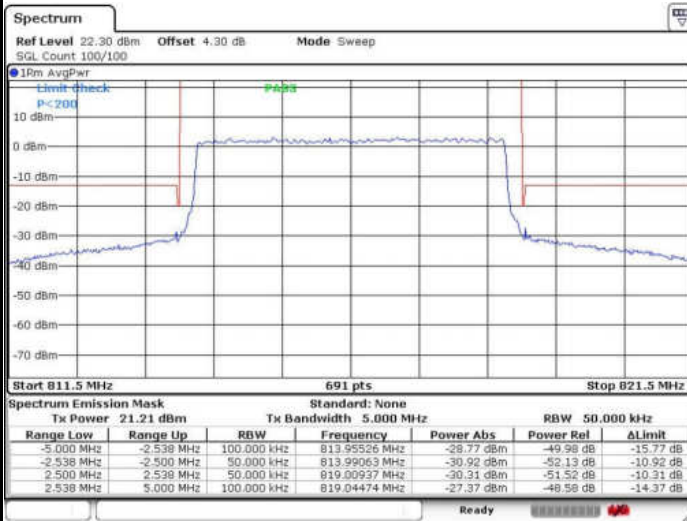

Date: 18 AUG 2017 19:25:06

Highest Band Edge / Full RB

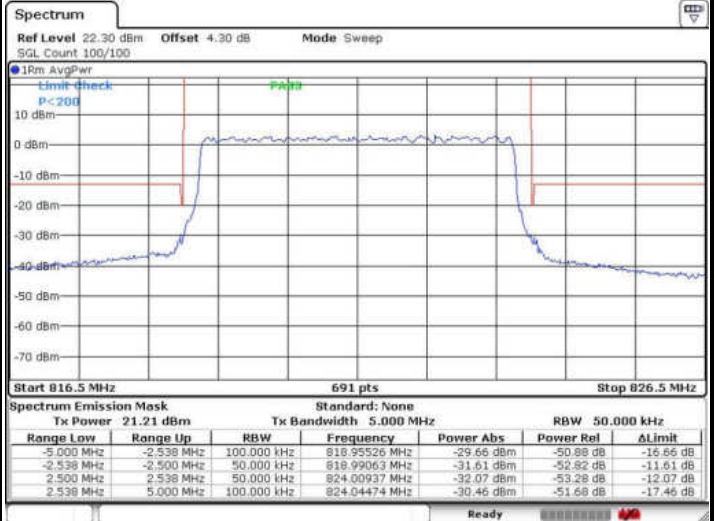

Date: 18 AUG 2017 19:26:40



LTE Band 26 / 5MHz / 16QAM

Lowest Band Edge / 1RB

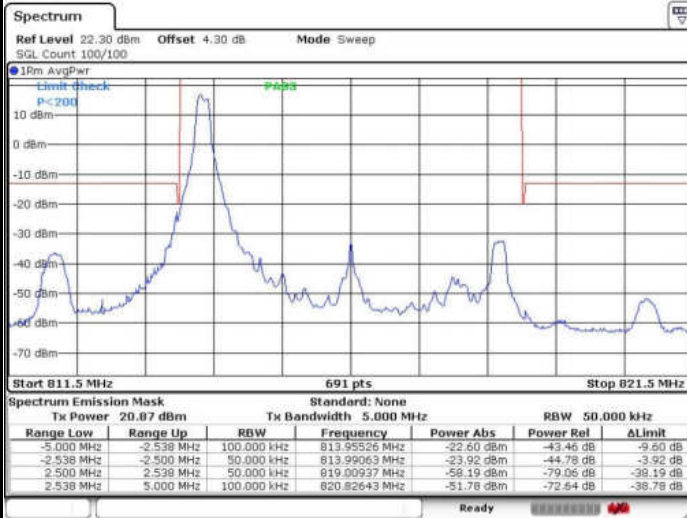

Date: 18 AUG 2017 19:23:24

Highest Band Edge / 1 RB

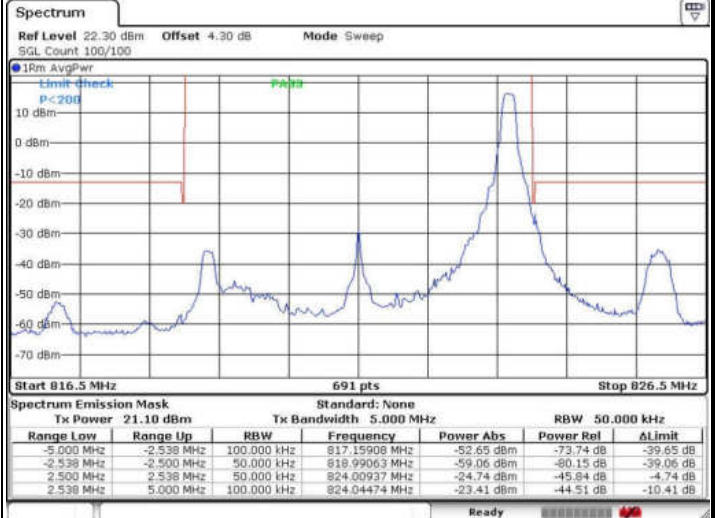

Date: 18 AUG 2017 19:28:14

Lowest Band Edge / Full RB

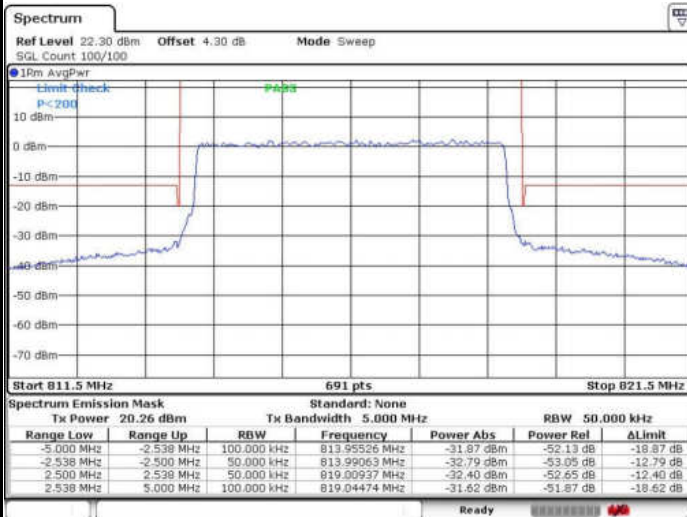

Date: 18 AUG 2017 19:24:49

Highest Band Edge / Full RB

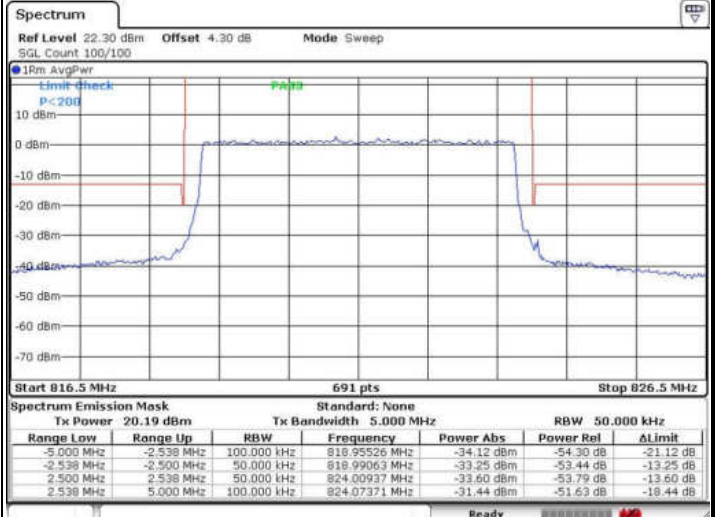

Date: 18 AUG 2017 19:27:01



LTE Band 26 / 10MHz / QPSK

Lowest Band Edge / 1 RB

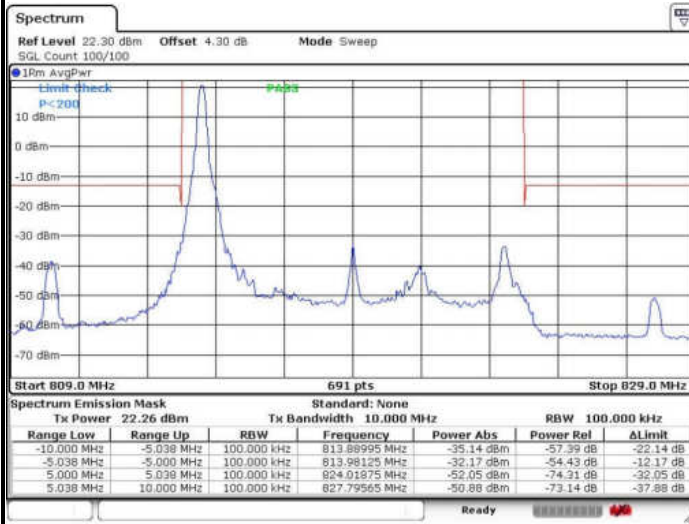

Date: 18 AUG 2017 19:30:51

Highest Band Edge / 1 RB

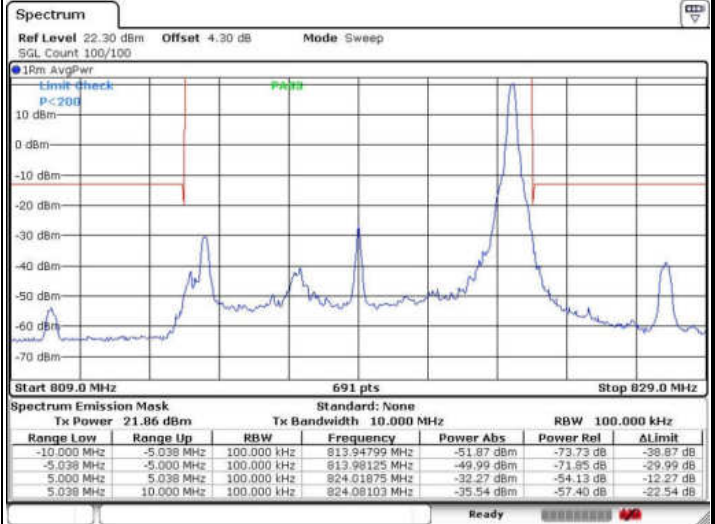

Date: 18 AUG 2017 19:33:10

Band Edge / Full RB

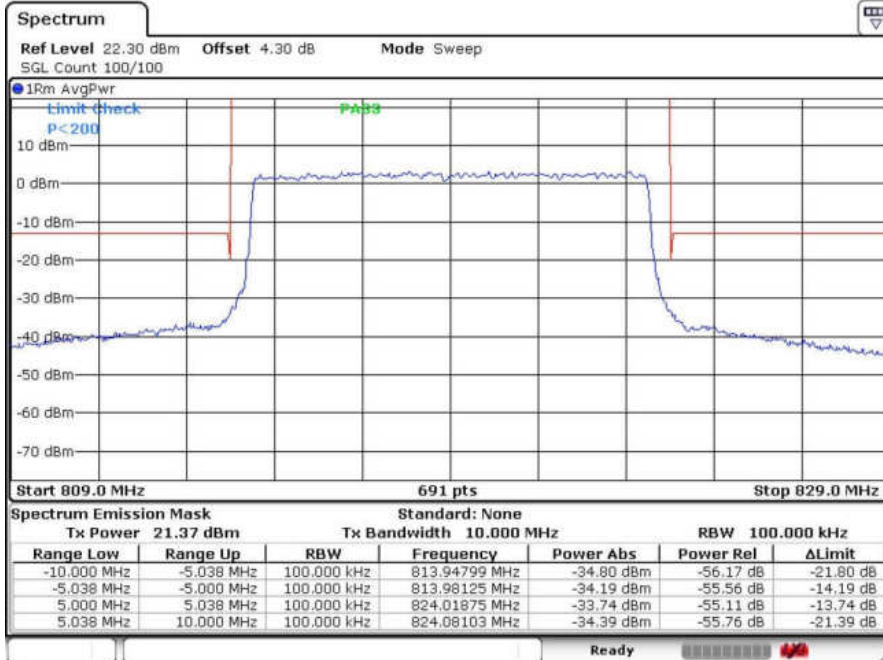

Date: 18 AUG 2017 19:33:33



LTE Band 26 / 10MHz / 16QAM

Lowest Band Edge / 1 RB

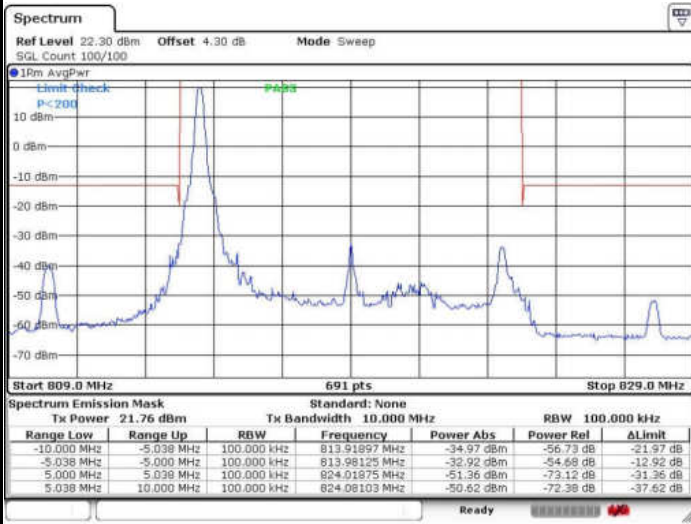

Highest Band Edge / 1 RB

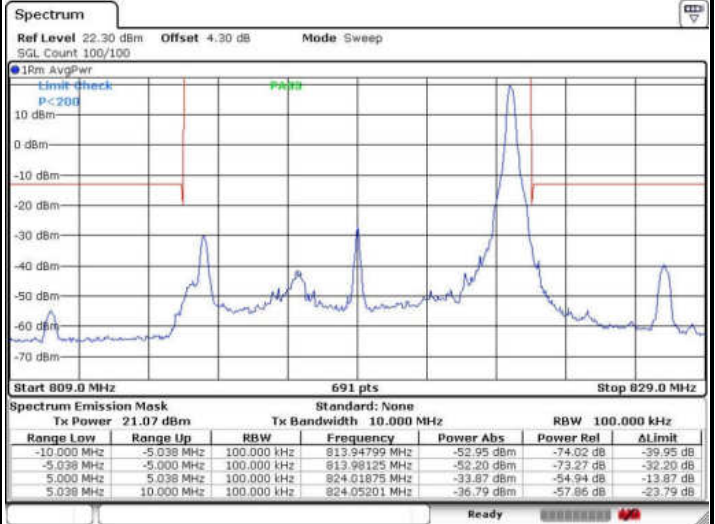

Band Edge / Full RB

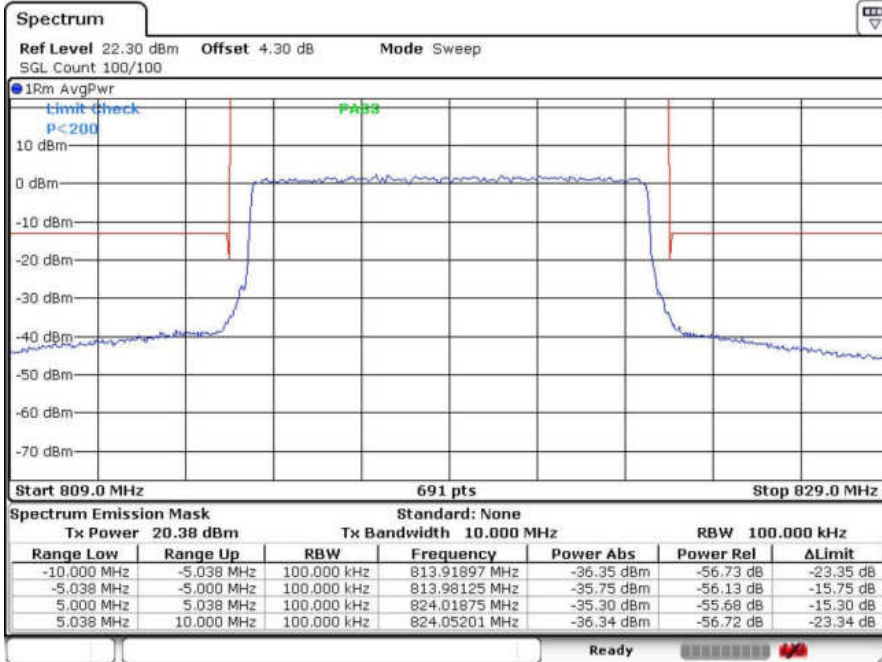



LTE Band 26 / 15MHz QPSK

Lowest Band Edge / 1 RB

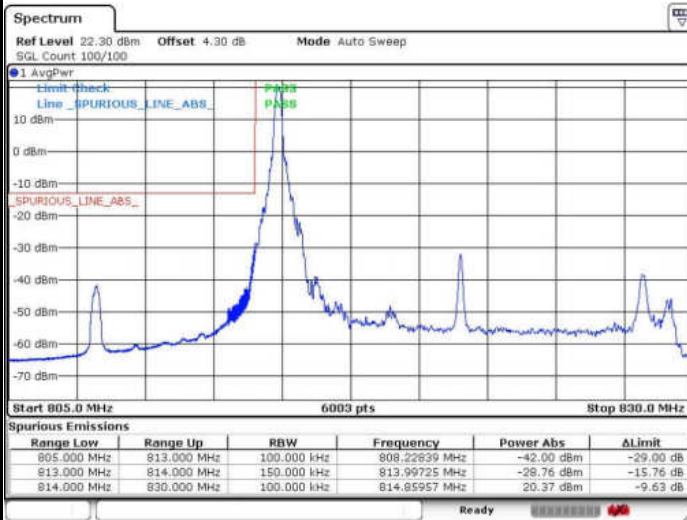

Date: 18 AUG 2017 19:50:49

Lowest Band Edge / Full RB

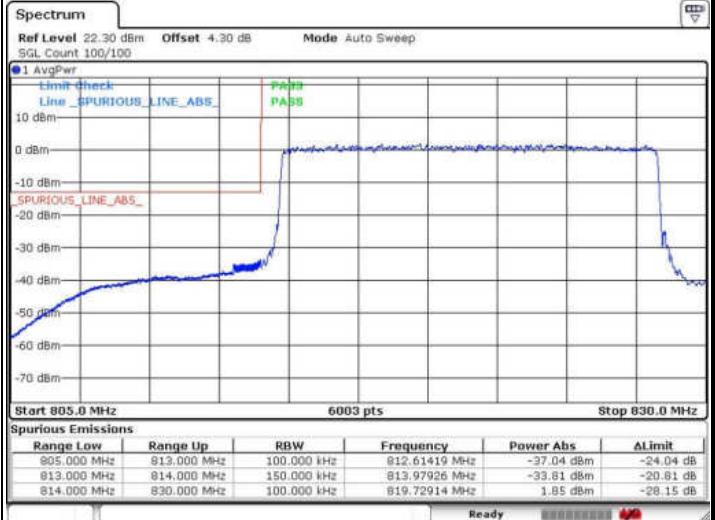

Date: 18 AUG 2017 19:48:34

LTE Band 26 / 15MHz 16QAM

Lowest Band Edge / 1 RB

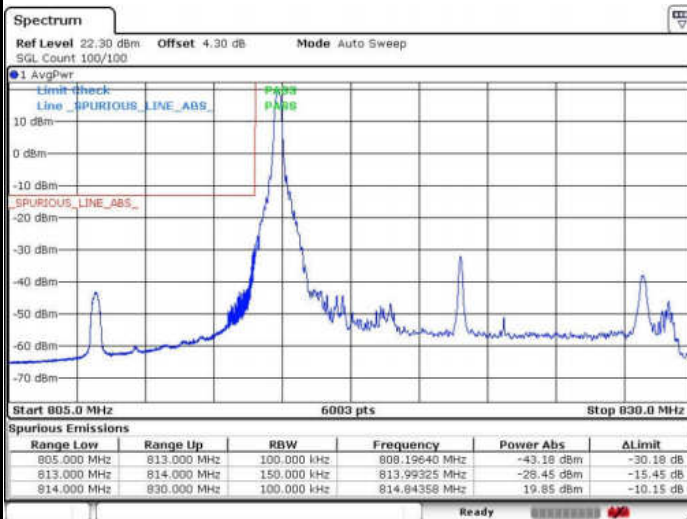

Date: 18 AUG 2017 19:50:18

Lowest Band Edge / Full RB

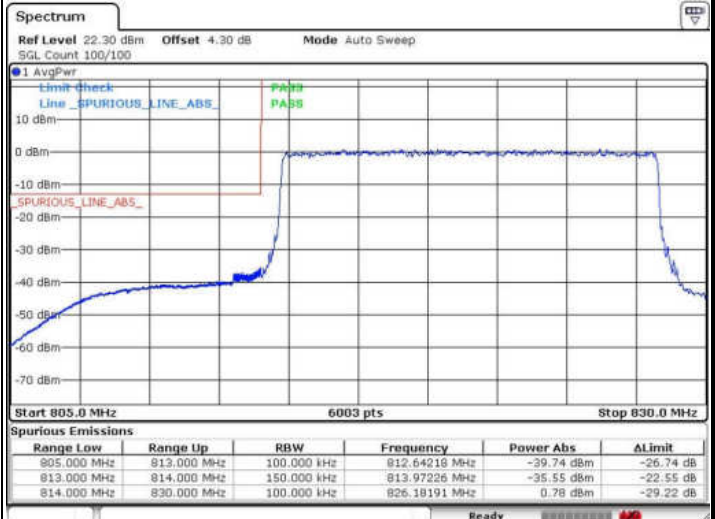

Date: 18 AUG 2017 19:47:19



Conducted Spurious Emission

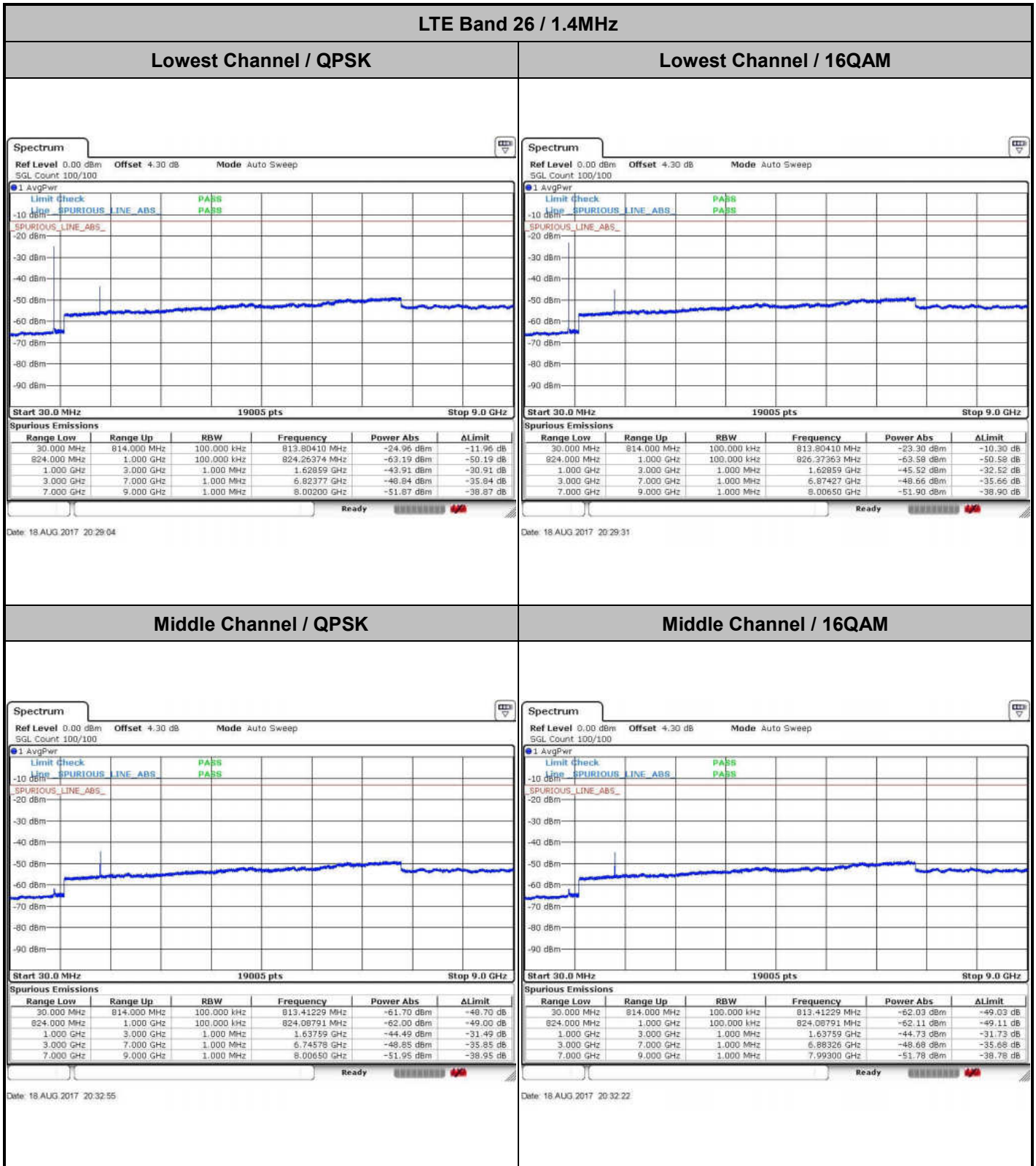



LTE Band 26 / 1.4MHz

Highest Channel / QPSK

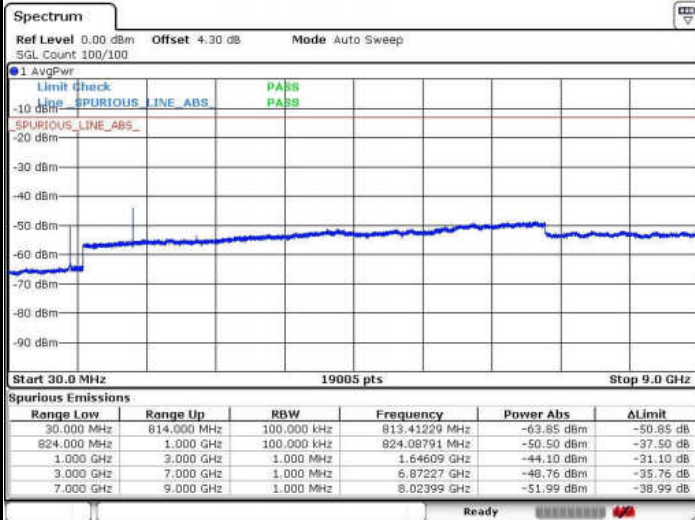

Date: 18 AUG 2017 20:33:43

Highest Channel / 16QAM

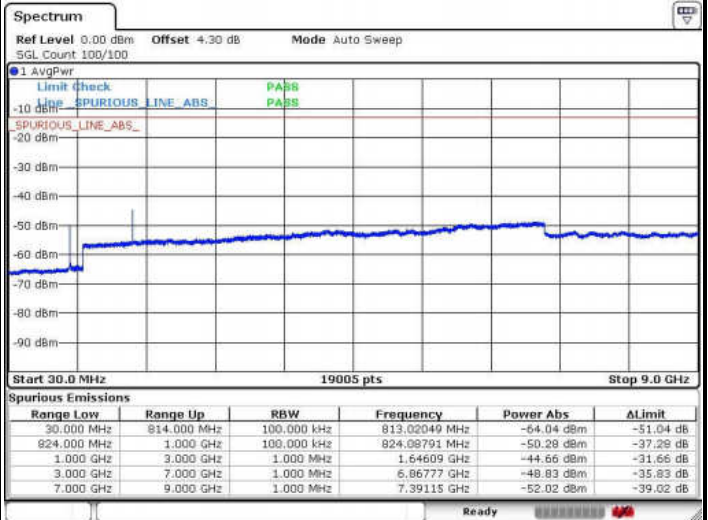

Date: 18 AUG 2017 20:34:27

LTE Band 26 / 3MHz

Lowest Channel / QPSK

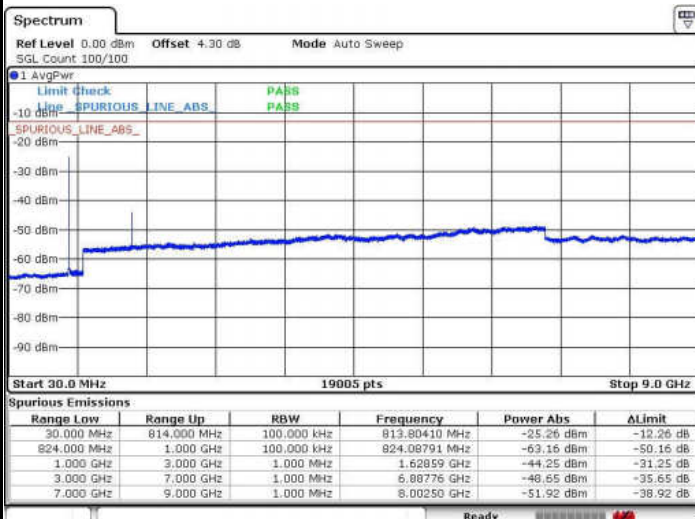

Date: 18 AUG 2017 20:41:24

Lowest Channel / 16QAM

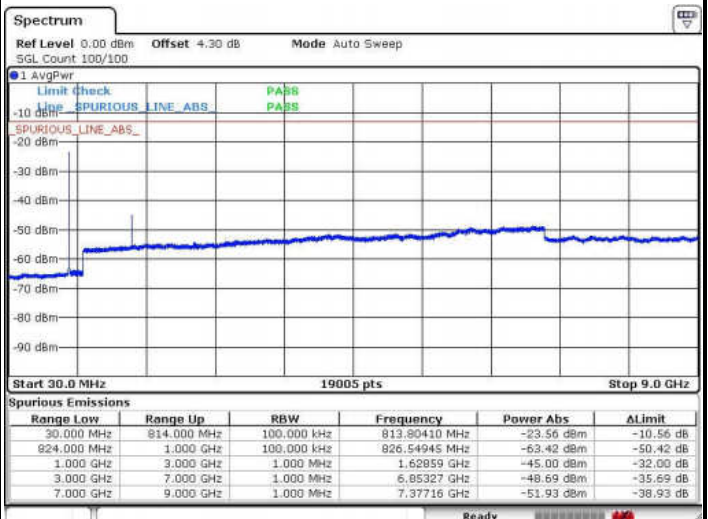

Date: 18 AUG 2017 20:40:50



LTE Band 26 / 3MHz

Middle Channel / QPSK

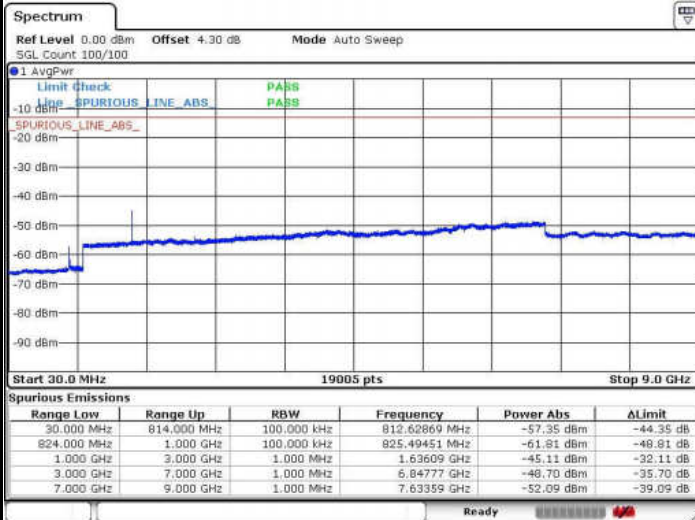

Date: 18 AUG 2017 20:42:09

Middle Channel / 16QAM

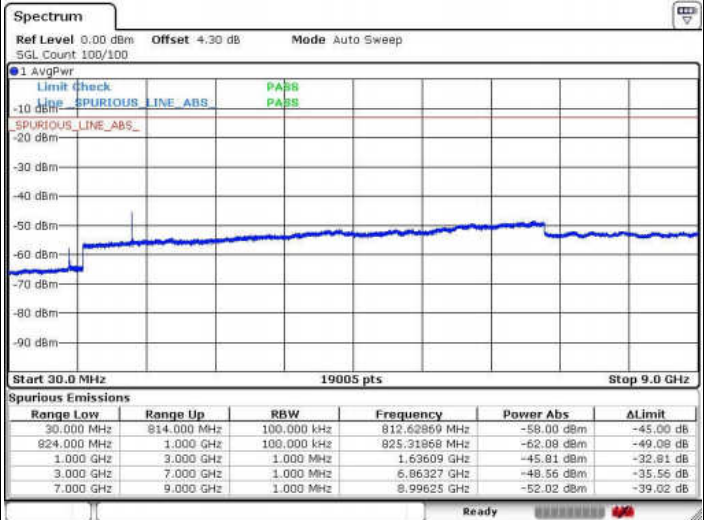

Date: 18 AUG 2017 20:42:46

Highest Channel / QPSK

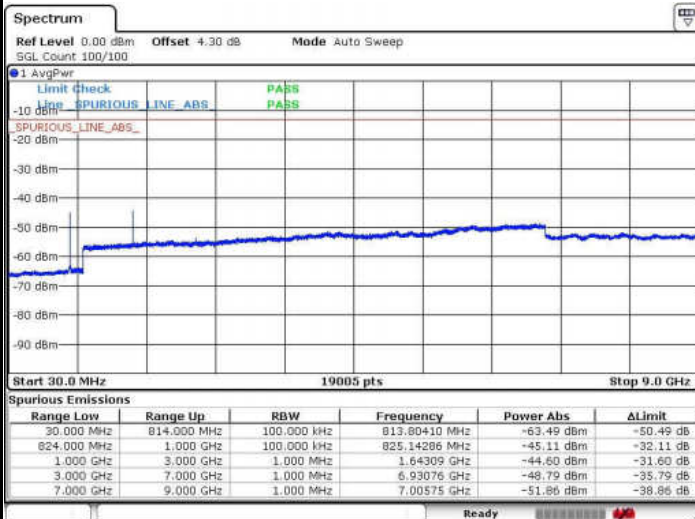

Date: 18 AUG 2017 20:44:54

Highest Channel / 16QAM

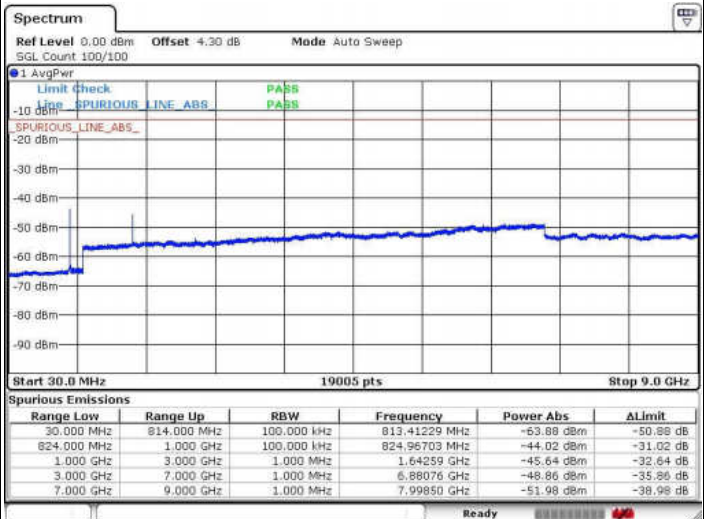

Date: 18 AUG 2017 20:44:27



LTE Band 26 / 5MHz

Lowest Channel / QPSK

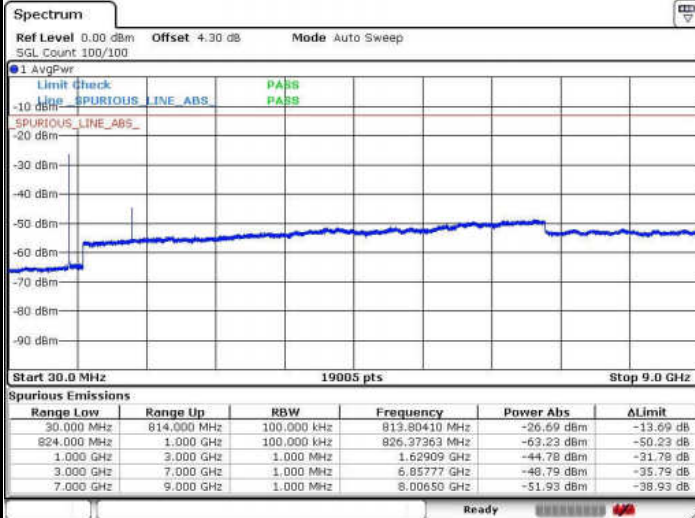

Date: 18 AUG 2017 20:46:07

Lowest Channel / 16QAM

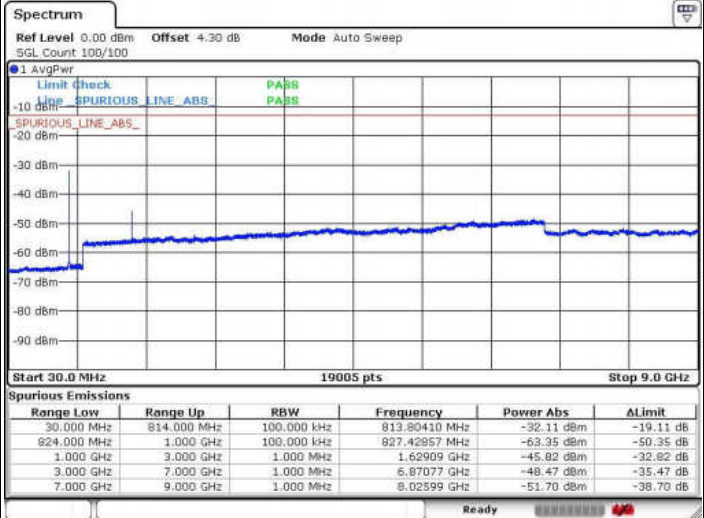

Date: 18 AUG 2017 20:46:46

Middle Channel / QPSK

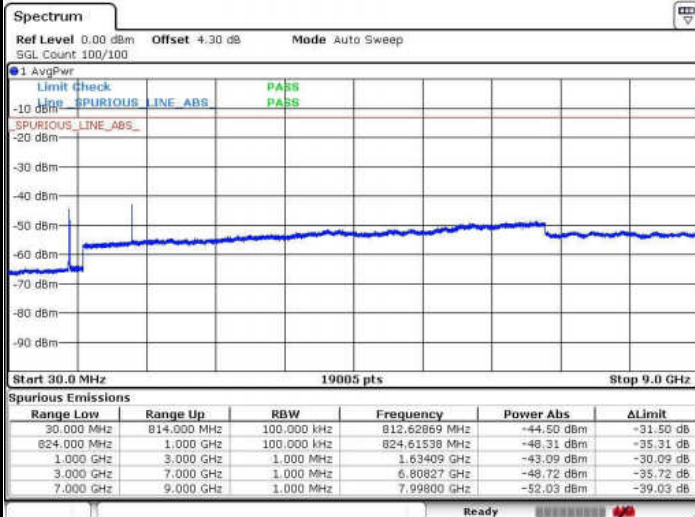

Date: 18 AUG 2017 20:49:21

Middle Channel / 16QAM

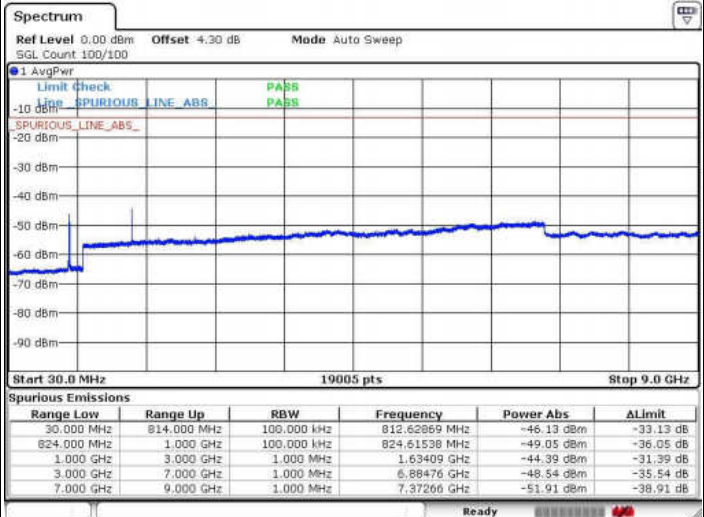

Date: 18 AUG 2017 20:48:45



LTE Band 26 / 5MHz

Highest Channel / QPSK

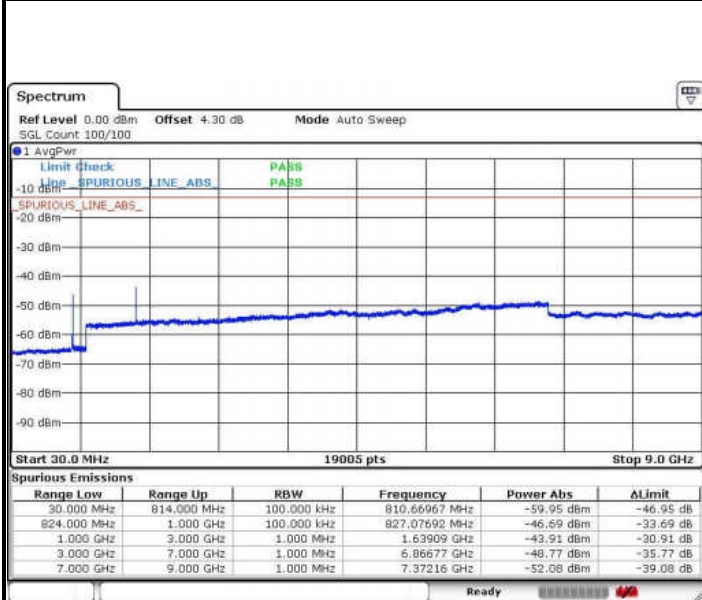

Date: 18 AUG 2017 20:50:14

Highest Channel / 16QAM

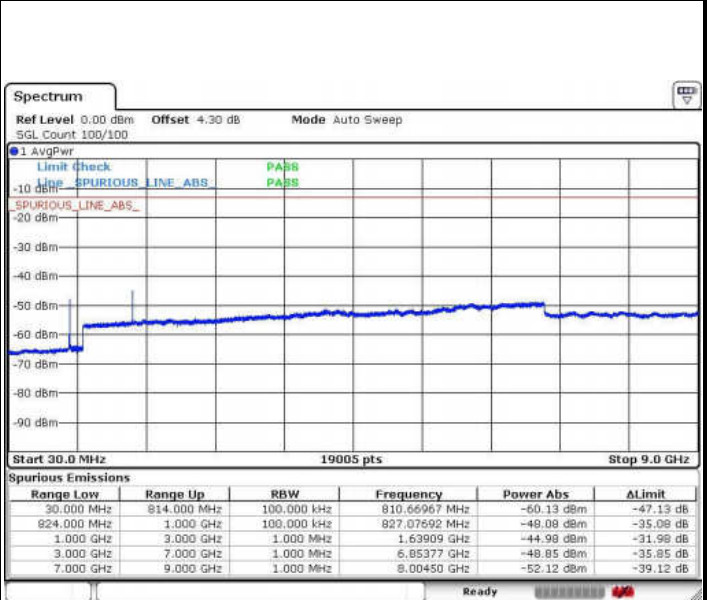

Date: 18 AUG 2017 20:50:52

LTE Band 26 / 10MHz

Middle Channel / QPSK

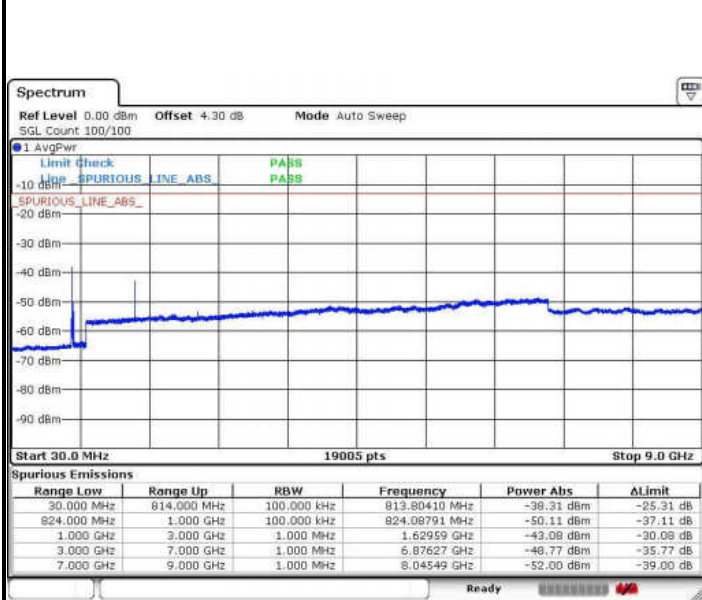

Date: 18 AUG 2017 20:56:12

Middle Channel / 16QAM

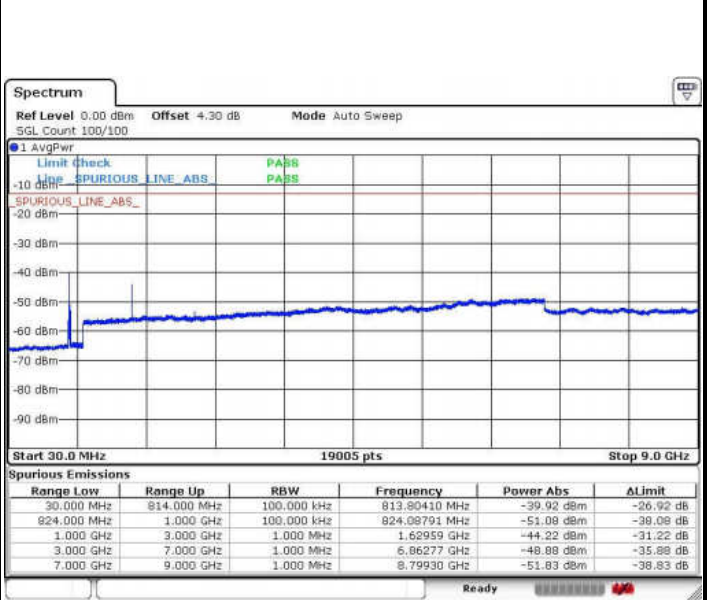

Date: 18 AUG 2017 20:55:20



Frequency Stability

Test Conditions		LTE Band 26 (QPSK) / Middle Channel	Limit
Temperature (°C)	Voltage (Volt)	BW 10MHz	Note 2.
		Deviation (ppm)	Result
50	Normal Voltage	0.0033	PASS
40	Normal Voltage	0.0027	
30	Normal Voltage	0.0023	
20(Ref.)	Normal Voltage	0.0000	
10	Normal Voltage	0.0006	
0	Normal Voltage	0.0028	
-10	Normal Voltage	0.0018	
-20	Normal Voltage	0.0021	
-30	Normal Voltage	0.0034	
20	Maximum Voltage	0.0026	
20	Normal Voltage	0.0001	
20	Battery End Point	0.0027	

Note:

1. Normal Voltage =3.7 V. ; Battery End Point (BEP) =3.5 V. ; Maximum Voltage =4.2 V.
2. Note: The frequency fundamental emissions stay within the authorized frequency block.



Appendix B. Test Results of Radiated Test

LTE Band 26 / 1.4MHz / QPSK / RB Size 1 Offset 0									
Channel	Frequency (MHz)	ERP (dBm)	Limit (dBm)	Over Limit (dB)	SPA Reading (dBm)	S.G. Power (dBm)	TX Cable loss (dB)	TX Antenna Gain (dBi)	Polarization (H/V)
Lowest	1628.14	-63.79	-13	-50.79	-71.23	-70.48	0.56	9.40	H
	2442.21	-64.46	-13	-51.46	-76.00	-72.17	0.74	10.60	H
	3256.28	-63.23	-13	-50.23	-76.78	-72.83	0.85	12.60	H
	1628.14	-63.84	-13	-50.84	-71.36	-70.53	0.56	9.40	V
	2442.21	-65.32	-13	-52.32	-76.44	-73.03	0.74	10.60	V
	3256.28	-63.14	-13	-50.14	-76.85	-72.74	0.85	12.60	V
Middle	1636.74	-65.54	-13	-52.54	-72.98	-72.23	0.56	9.40	H
	2455.11	-64.67	-13	-51.67	-76.17	-72.38	0.74	10.60	H
	3273.48	-63.55	-13	-50.55	-77.05	-73.15	0.85	12.60	H
	1636.74	-64.85	-13	-51.85	-72.37	-71.54	0.56	9.40	V
	2455.11	-65.05	-13	-52.05	-76.14	-72.76	0.74	10.60	V
	3273.48	-63.29	-13	-50.29	-76.96	-72.89	0.85	12.60	V
Highest	1645.74	-62.84	-13	-49.84	-70.17	-69.53	0.56	9.40	H
	2468.61	-64.86	-13	-51.86	-76.36	-72.57	0.74	10.60	H
	3291.48	-63.28	-13	-50.28	-76.72	-72.88	0.85	12.60	H
	1645.74	-63.94	-13	-50.94	-71.32	-70.63	0.56	9.40	V
	2468.61	-65.31	-13	-52.31	-76.40	-73.02	0.74	10.60	V
	3291.48	-63.25	-13	-50.25	-76.88	-72.85	0.85	12.60	V

Remark: Spurious emissions within 30-1000MHz were found more than 20dB below limit line.



LTE Band 26 / 3MHz / QPSK / RB Size 1 Offset 0									
Channel	Frequency (MHz)	ERP (dBm)	Limit (dBm)	Over Limit (dB)	SPA Reading (dBm)	S.G. Power (dBm)	TX Cable loss (dB)	TX Antenna Gain (dBi)	Polarization (H/V)
Lowest	1628.3	-65.57	-13	-52.57	-73.01	-72.26	0.56	9.40	H
	2442.45	-64.82	-13	-51.82	-76.36	-72.53	0.74	10.60	H
	3256.6	-62.98	-13	-49.98	-76.53	-72.58	0.85	12.60	H
	1628.3	-64.22	-13	-51.22	-71.74	-70.91	0.56	9.40	V
	2442.45	-65.11	-13	-52.11	-76.23	-72.82	0.74	10.60	V
	3256.6	-63.23	-13	-50.23	-76.94	-72.83	0.85	12.60	V
Middle	1635.3	-65.19	-13	-52.19	-72.63	-71.88	0.56	9.40	H
	2452.95	-65.00	-13	-52.00	-76.54	-72.71	0.74	10.60	H
	3270.6	-63.41	-13	-50.41	-76.91	-73.01	0.85	12.60	H
	1635.3	-63.96	-13	-50.96	-71.48	-70.65	0.56	9.40	V
	2452.95	-65.38	-13	-52.38	-76.50	-73.09	0.74	10.60	V
	3270.6	-63.04	-13	-50.04	-76.71	-72.64	0.85	12.60	V
Highest	1642.3	-64.65	-13	-51.65	-71.98	-71.34	0.56	9.40	H
	2463.45	-65.16	-13	-52.16	-76.66	-72.87	0.74	10.60	H
	3284.6	-63.49	-13	-50.49	-76.99	-73.09	0.85	12.60	H
	1642.3	-63.24	-13	-50.24	-70.62	-69.93	0.56	9.40	V
	2463.45	-65.54	-13	-52.54	-76.63	-73.25	0.74	10.60	V
	3284.6	-63.38	-13	-50.38	-77.05	-72.98	0.85	12.60	V

Remark: Spurious emissions within 30-1000MHz were found more than 20dB below limit line.



LTE Band 26 / 5MHz / QPSK / RB Size 1 Offset 0									
Channel	Frequency (MHz)	ERP (dBm)	Limit (dBm)	Over Limit (dB)	SPA Reading (dBm)	S.G. Power (dBm)	TX Cable loss (dB)	TX Antenna Gain (dBi)	Polarization (H/V)
Lowest	1628.5	-64.61	-13	-51.61	-72.05	-71.30	0.56	9.40	H
	2442.75	-64.81	-13	-51.81	-76.35	-72.52	0.74	10.60	H
	3257	-63.60	-13	-50.60	-77.15	-73.20	0.85	12.60	H
	1628.5	-63.77	-13	-50.77	-71.29	-70.46	0.56	9.40	V
	2442.75	-65.06	-13	-52.06	-76.18	-72.77	0.74	10.60	V
	3257	-63.05	-13	-50.05	-76.76	-72.65	0.85	12.60	V
Middle	1633.5	-63.52	-13	-50.52	-70.96	-70.21	0.56	9.40	H
	2450.25	-64.82	-13	-51.82	-76.36	-72.53	0.74	10.60	H
	3267	-63.16	-13	-50.16	-76.71	-72.76	0.85	12.60	H
	1633.5	-64.41	-13	-51.41	-71.93	-71.10	0.56	9.40	V
	2450.25	-65.03	-13	-52.03	-76.15	-72.74	0.74	10.60	V
	3267	-62.96	-13	-49.96	-76.67	-72.56	0.85	12.60	V
Highest	1638.5	-64.84	-13	-51.84	-72.17	-71.53	0.56	9.40	H
	2457.75	-64.96	-13	-51.96	-76.46	-72.67	0.74	10.60	H
	3277	-63.41	-13	-50.41	-76.91	-73.01	0.85	12.60	H
	1638.5	-64.66	-13	-51.66	-72.04	-71.35	0.56	9.40	V
	2457.75	-65.52	-13	-52.52	-76.61	-73.23	0.74	10.60	V
	3277	-63.36	-13	-50.36	-77.03	-72.96	0.85	12.60	V

Remark: Spurious emissions within 30-1000MHz were found more than 20dB below limit line.

LTE Band 26 / 10MHz / QPSK / RB Size 1 Offset 0									
Channel	Frequency (MHz)	ERP (dBm)	Limit (dBm)	Over Limit (dB)	SPA Reading (dBm)	S.G. Power (dBm)	TX Cable loss (dB)	TX Antenna Gain (dBi)	Polarization (H/V)
Middle	1629	-65.20	-13	-52.20	-72.64	-71.89	0.56	9.40	H
	2443.5	-64.73	-13	-51.73	-76.27	-72.44	0.74	10.60	H
	3258	-63.45	-13	-50.45	-77.00	-73.05	0.85	12.60	H
	1629	-64.35	-13	-51.35	-71.87	-71.04	0.56	9.40	V
	2443.5	-64.83	-13	-51.83	-75.95	-72.54	0.74	10.60	V
	3258	-63.13	-13	-50.13	-76.84	-72.73	0.85	12.60	V

Remark: Spurious emissions within 30-1000MHz were found more than 20dB below limit line.