

# FCC HAC (RF Emission) Test Report

Report No. : HC181019C31  
Applicant : Sonim Technologies, Inc.  
Address : 1875 S. Grant St., Suite 750., San Mateo, CA, 94402  
Product : Mobile Phone  
FCC ID : WYPPC2223  
Brand : Sonim  
Model No. : XP3800  
Standards : FCC 47 CFR Part 20.19, ANSI C63.19-2011  
KDB 285076 D01 v05, KDB 285076 D02 v03  
Sample Received Date : Oct. 19, 2018  
Date of Testing : Nov. 09, 2018  
Summary M-Rating : M3  
Lab Address : No. 47-2, 14th Ling, Chia Pau Vil., Lin Kou Dist., New Taipei City, Taiwan, R.O.C.  
Test Location : No. 19, Hwa Ya 2nd Rd, Wen Hwa Vil, Kwei Shan Dist., Taoyuan City 33383, Taiwan (R.O.C)

**CERTIFICATION:** The above equipment have been tested by **Bureau Veritas Consumer Products Services (H.K.) Ltd., Taoyuan Branch – Lin Kou Laboratories**, and found compliance with the requirement of the above standards. The test record, data evaluation & Equipment Under Test (EUT) configurations represented herein are true and accurate accounts of the measurements of the sample's HAC characteristics under the conditions specified in this report. It should not be reproduced except in full, without the written approval of our laboratory. The client should not use it to claim product certification, approval, or endorsement by TAF or any government agencies.

Prepared By :   
Gina Liu / Specialist  
Approved By :   
Gordon Lin / Assistant Manager



FCC Accredited No.: TW0003

This report is for your exclusive use. Any copying or replication of this report to or for any other person or entity, or use of our name or trademark, is permitted only with our prior written permission. This report sets forth our findings solely with respect to the test samples identified herein. The results set forth in this report are not indicative or representative of the quality or characteristics of the lot from which a test sample was taken or any similar or identical product unless specifically and expressly noted. Our report includes all of the tests requested by you and the results thereof based upon the information that you provided to us. You have 60 days from date of issuance of this report to notify us of any material error or omission caused by our negligence, provided, however, that such notice shall be in writing and shall specifically address the issue you wish to raise. A failure to raise such issue within the prescribed time shall constitute your unqualified acceptance of the completeness of this report, the tests conducted and the correctness of the report contents. Unless specific mention, the uncertainty of measurement has been explicitly taken into account to declare the compliance or non-compliance to the specification.

## Table of Contents

<b>Release Control Record .....</b>	<b>3</b>
<b>1. Summary of Maximum M-Rating .....</b>	<b>4</b>
<b>2. Description of Equipment Under Test .....</b>	<b>5</b>
<b>3. HAC RF Emission Measurement System .....</b>	<b>7</b>
3.1 SPEAG DASYS System .....	7
3.1.1 Robot.....	8
3.1.2 Probes.....	8
3.1.3 Data Acquisition Electronics (DAE) .....	9
3.1.4 Phantoms.....	9
3.1.5 Device Holder.....	9
3.1.6 RF Emission Calibration Dipoles.....	9
3.2 DASYS System Verification.....	10
3.3 EUT Measurements Reference and Plane.....	11
3.4 HAC RF Emission Measurement Procedure.....	12
3.5 Modulation Interference Factor .....	14
<b>4. HAC Measurement Evaluation.....</b>	<b>16</b>
4.1 M-Rating Category .....	16
4.2 EUT Configuration and Setting.....	16
4.3 System Verification.....	16
4.4 Maximum Target Conducted Power .....	17
4.5 Low Power Exemption Evaluation.....	19
4.6 Measured Conducted Power Results.....	20
4.7 HAC RF Emission Testing Results.....	21
<b>5. Calibration of Test Equipment.....</b>	<b>22</b>
<b>6. Measurement Uncertainty.....</b>	<b>23</b>
<b>7. Information of the Testing Laboratories.....</b>	<b>24</b>
Appendix A. Plots of System Verification	
Appendix B. Plots of HAC RF Emission Measurement	
Appendix C. Calibration Certificate for Probe and Dipole	
Appendix D. Photographs of EUT and Setup	



### Release Control Record

Report No.	Reason for Change	Date Issued
HC181019C31	Initial release	Jan. 11, 2019

### 1. Summary of Maximum M-Rating

Mode	Band	Maximum Audio Interference Level (dBV/m)	M-Rating
GSM	GSM850	40.94	M3
	GSM1900	28.94	M4
WCDMA	Band II	N/A	M4
	Band IV	N/A	M4
	Band V	N/A	M4
CDMA	BC0	37.52	M4
	BC1	22.9	M4
	BC10	36.58	M4
FDD-LTE	Band 2	N/A	M4
	Band 4	N/A	M4
	Band 5	N/A	M4
	Band 12	N/A	M4
	Band 13	N/A	M4
	Band 14	N/A	M4
	Band 25	N/A	M4
	Band 26	N/A	M4
TDD-LTE	Band 38	20.77	M4
	Band 41	23.27	M4
	<b>Summary</b>		<b>M3</b>

**Note:**

1. The HAC RF emission limit (**M-rating Category M3**) is specified in FCC 47 CFR part 20.19 and ANSI C63.19.
2. The device RF emission rating is determined by the minimum rating.

## FCC HAC (RF Emission) Test Report

### 2. Description of Equipment Under Test

<b>EUT Type</b>	Mobile Phone
<b>FCC ID</b>	WYPPC2223
<b>Brand Name</b>	Sonim
<b>Model Name</b>	XP3800
<b>Tx Frequency Bands (Unit: MHz)</b>	<b>GSM</b> GSM850 : 824.2 ~ 848.8 GSM1900 : 1850.2 ~ 1909.8 <b>WCDMA</b> Band II : 1852.4 ~ 1907.6 Band IV : 1712.4 ~ 1752.6 Band V : 826.4 ~ 846.6 <b>CDMA</b> BC0 : 824.7 ~ 848.31 BC1 : 1851.25 ~ 1908.75 BC10 : 817.9 ~ 823.1 <b>FDD-LTE</b> Band 2 : 1850.7 ~ 1909.3 (BW: 1.4M, 3M, 5M, 10M, 15M, 20M) Band 4 : 1710.7 ~ 1754.3 (BW: 1.4M, 3M, 5M, 10M, 15M, 20M) Band 5 : 824.7 ~ 848.3 (BW: 1.4M, 3M, 5M, 10M) Band 12 : 699.7 ~ 715.3 (BW: 1.4M, 3M, 5M, 10M) Band 13 : 779.5 ~ 784.5 (BW: 5M, 10M) Band 14 : 790.5 ~ 795.5 (BW: 5M, 10M) Band 25 : 1850.7 ~ 1914.3 (BW: 1.4M, 3M, 5M, 10M, 15M, 20M) Band 26 : 814.7 ~ 848.3 (BW: 1.4M, 3M, 5M, 10M, 15M) Band 66 : 1710.7 ~ 1779.3 (BW: 1.4M, 3M, 5M, 10M, 15M, 20M) <b>TDD-LTE</b> LTE Band 38 : 2572.5 ~ 2617.5 (BW: 5M, 10M, 15M, 20M) LTE Band 41 : 2498.5 ~ 2687.5 (BW: 5M, 10M, 15M, 20M) <b>WLAN</b> 2412 ~ 2462, 5180 ~ 5240, 5260 ~ 5320, 5500 ~ 5700, 5745 ~ 5825 <b>Bluetooth</b> 2402 ~ 2480
<b>Modulations Supported in Uplink</b>	GSM & GPRS : GMSK EDGE : 8PSK WCDMA : QPSK CDMA : QPSK LTE : QPSK, 16QAM, 64QAM 802.11b : DSSS 802.11a/g/n : OFDM Bluetooth : GFSK, $\pi/4$ -DQPSK, 8-DPSK
<b>Antenna Type</b>	Fixed Internal Antenna
<b>EUT Stage</b>	ENGINEERING SAMPLE

#### Note:

- The above EUT information is declared by manufacturer and for more detailed features description please refers to the manufacturer's specifications or User's Manual.

#### List of Accessory:

<b>Battery</b>	<b>Brand Name</b>	Sonim
	<b>Model Name</b>	BAT-01500-01S
	<b>Power Rating</b>	3.7Vdc, 1500mAh
	<b>Type</b>	Li-ion

# FCC HAC (RF Emission) Test Report

## Air Interface and Operational Mode:

Air Interface	Bands	Transport Type	HAC Tested	Simultaneous But Not Tested	Name of Voice Service	Power Reduction
GSM	850	VO	YES	WLAN or BT	CMRS Voice	No
	1900					No
	EGPRS	DT	No	WLAN or BT	N/A	No
WCDMA	II	VO	No <sup>(1)</sup>	WLAN or BT	CMRS Voice	No
	IV					No
	V					No
	HSPA	DT	No	WLAN or BT	N/A	No
CDMA	BC0	VO	YES	WLAN or BT	CMRS Voice	No
	BC1					No
	BC10					No
FDD-LTE	2	VD	No <sup>(1)</sup>	WLAN or BT	VoLTE	No
	4					No
	5					No
	12					No
	13					No
	14					No
	25					No
	26					No
TDD-LTE	38	VD	YES	WLAN or BT	VoLTE	No
	41					No
WLAN	2.4G	VD	No <sup>(1)</sup>	WWAN	N/A	No
	5.2G	VD	No <sup>(1)</sup>		N/A	No
	5.3G					No
	5.6G					No
	5.8G					No
Bluetooth	2.4G	DT	No	WWAN	N/A	No
<b>Transport Type</b> VO = Legacy Cellular Voice Service DT = Digital Transport Only (No Voice) VD = IP Voice Service over Digital Transport			<b>Note</b> 1. It applies the low power exemption per ANSI C63.19-2011.			

### 3. HAC RF Emission Measurement System

#### 3.1 SPEAG DASY System

DASY system consists of high precision robot, probe alignment sensor, phantom, robot controller, controlled measurement server and near-field probe. The robot includes six axes that can move to the precision position of the DASY5 software defined. The DASY software can define the area that is detected by the probe. The robot is connected to controlled box. Controlled measurement server is connected to the controlled robot box. The DAE includes amplifier, signal multiplexing, AD converter, offset measurement and surface detection. It is connected to the Electro-optical coupler (ECO). The ECO performs the conversion from the optical into digital electric signal of the DAE and transfers data to the PC.

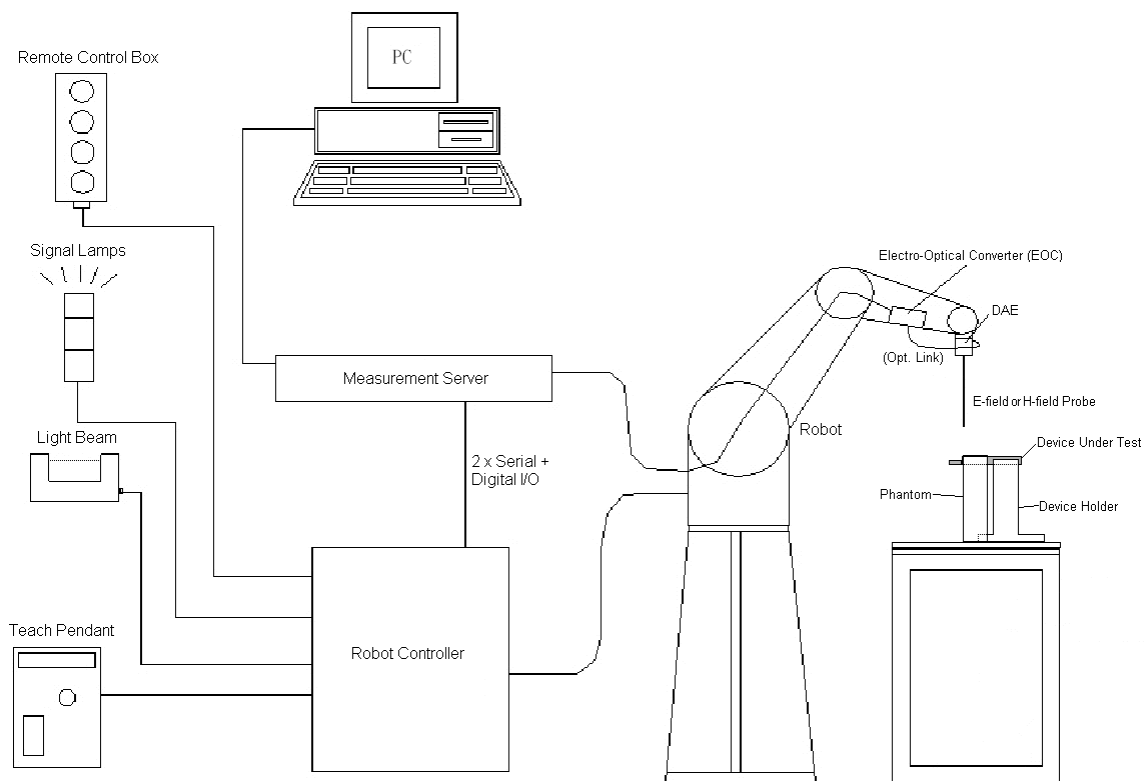

Fig-3.1 DASY System Setup

# FCC HAC (RF Emission) Test Report

## 3.1.1 Robot

The DASY system uses the high precision robots from Stäubli SA (France). For the 6-axis controller system, the robot controller version (DASY5: CS8c) from Stäubli is used. The Stäubli robot series have many features that are important for our application:

- High precision (repeatability  $\pm 0.035$  mm)
- High reliability (industrial design)
- Jerk-free straight movements
- Low ELF interference (the closed metallic construction shields against motor control fields)



**Fig-3.2 DASY5 Measurement System**

## 3.1.2 Probes

<b>Model</b>	ER3DV6	
<b>Construction</b>	One dipole parallel, two dipoles normal to probe axis Built-in shielding against static charges	
<b>Frequency</b>	40 MHz to 3 GHz Linearity: $\pm 0.2$ dB	
<b>Directivity</b>	$\pm 0.2$ dB in air (rotation around probe axis) $\pm 0.4$ dB in air (rotation normal to probe axis)	
<b>Dynamic Range</b>	2 V/m to 1000 V/m Linearity: $\pm 0.2$ dB	
<b>Dimensions</b>	Overall length: 337 mm (Tip: 16 mm) Tip diameter: 8 mm (Body: 12 mm) Distance from probe tip to dipole centers: 2.5 mm	

<b>Model</b>	EF3DV3	
<b>Construction</b>	One dipole parallel, two dipoles normal to probe axis Built-in shielding against static charges	
<b>Frequency</b>	40 MHz to 6 GHz Linearity: $\pm 0.2$ dB	
<b>Directivity</b>	$\pm 0.2$ dB in air (rotation around probe axis) $\pm 0.4$ dB in air (rotation normal to probe axis)	
<b>Dynamic Range</b>	2 V/m to 1000 V/m Linearity: $\pm 0.2$ dB	
<b>Dimensions</b>	Overall length: 337 mm (Tip: 20 mm) Tip diameter: 3.9 mm (Body: 12 mm) Distance from probe tip to dipole centers: 1.5 mm	



## FCC HAC (RF Emission) Test Report

### 3.1.3 Data Acquisition Electronics (DAE)

<b>Model</b>	DAE3, DAE4	
<b>Construction</b>	Signal amplifier, multiplexer, A/D converter and control logic. Serial optical link for communication with DASY embedded system (fully remote controlled). Two step probe touch detector for mechanical surface detection and emergency robot stop.	
<b>Measurement Range</b>	-100 to +300 mV (16 bit resolution and two range settings: 4mV, 400mV)	
<b>Input Offset Voltage</b>	< 5 $\mu$ V (with auto zero)	
<b>Input Bias Current</b>	< 50 fA	
<b>Dimensions</b>	60 x 60 x 68 mm	

### 3.1.4 Phantoms

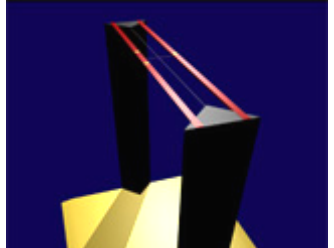
<b>Model</b>	Test Arch	
<b>Construction</b>	Enables easy and well defined positioning of the phone and validation dipoles as well as simple teaching of the robot.	
<b>Dimensions</b>	Length : 370 mm Width : 370 mm Height : 370 mm	

### 3.1.5 Device Holder

<b>Model</b>	Mounting Device	
<b>Construction</b>	The Mounting Device enables the rotation of the mounted transmitter device in spherical coordinates. Rotation point is the ear opening point. Transmitter devices can be easily and accurately positioned according to ANSI C63.19.	
<b>Material</b>	POM	

### 3.1.6 RF Emission Calibration Dipoles

<b>Model</b>	CD-Serial	
<b>Construction</b>	Free space antenna Hearing Aid susceptibility measurements according to ANSI C63.19. Validation of Hearing Aid RF setup for wireless device emission measurements according to ANSI C63.19	
<b>Frequency</b>	CD700V3 : 698 ~ 806 MHz CD835V3 : 800 ~ 960 MHz CD1880V3 : 1710 ~ 2000 MHz CD2450V3 : 2250 ~ 2650 MHz CD2600V3 : 2450 ~ 2750 MHz CD3500V3 : 3300 ~ 3950 MHz CD5500V3 : 5000 ~ 5900 MHz	
<b>Return Loss</b>	CD700V3 : > 15 dB (750 MHz > 20 dB) CD835V3 : > 15 dB (835 MHz > 25 dB) CD1880V3 : > 18 dB (1880 MHz > 20 dB) CD2450V3 : > 18 dB (2450 MHz > 25 dB) CD2600V3 : > 18 dB (2600 MHz > 20 dB) CD3500V3 : > 16 dB (3500 MHz > 20 dB) CD5500V3 : > 18 dB (5500 MHz > 20 dB)	
<b>Power Capability</b>	> 40 W continuous	

**3.2 DASY System Verification**

The system check verifies that the system operates within its specifications. It is performed before every E-field measurement. The system check uses normal measurements in the center section of the arch phantom with a matched dipole at a specified distance. The system verification setup is shown as below.

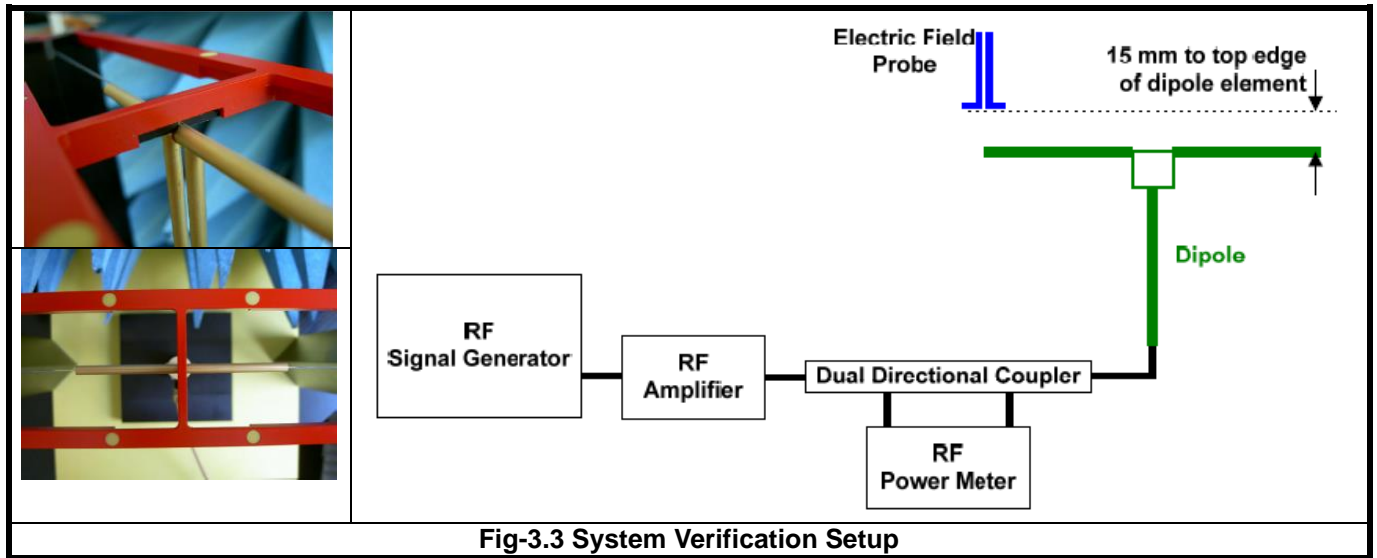

The validation dipole is placed beneath the center of arch phantom. The power meter measures the forward power at the location of the system check dipole connector. The signal generator is adjusted for the desired forward power, 100 mW (20 dBm) at the dipole connector and the RF power meter is read at that level. After connecting the cable to the dipole, the signal generator is readjusted for the same reading at RF power meter.

After system check testing, the E-field result will be compared with the reference value derived from validation dipole certificate report. The deviation of system check should be within 25 %.

The result of system verification is shown in section 4.3 of this report.

### **3.3 EUT Measurements Reference and Plane**

The EUT is mounted in the device holder. The acoustic output of the EUT will coincide with the center point of the area formed by the dielectric wire and the middle bar of the arch's top frame. Then EUT will be moved vertically upwards until it touches the frame.

Fig-3.4 and Fig-3.5 illustrate the references and reference plane that is used in the RF emissions measurement.

- (a) The grid is 50 mm by 50 mm area that is divided into nine evenly sized blocks or sub-grids.
- (b) The grid is centered on the audio frequency output transducer of the EUT.
- (c) The grid is in a reference plane, which is defined as the planar area that contains the highest point in the area of the phone that normally rests against the user's ear. It is parallel to the centerline of the receiver area of the phone and is defined by the points of the receiver-end of the EUT handset, which in normal handset use rest against the ear.
- (d) The measurement plane is parallel to and 15 mm in front of the reference plane.

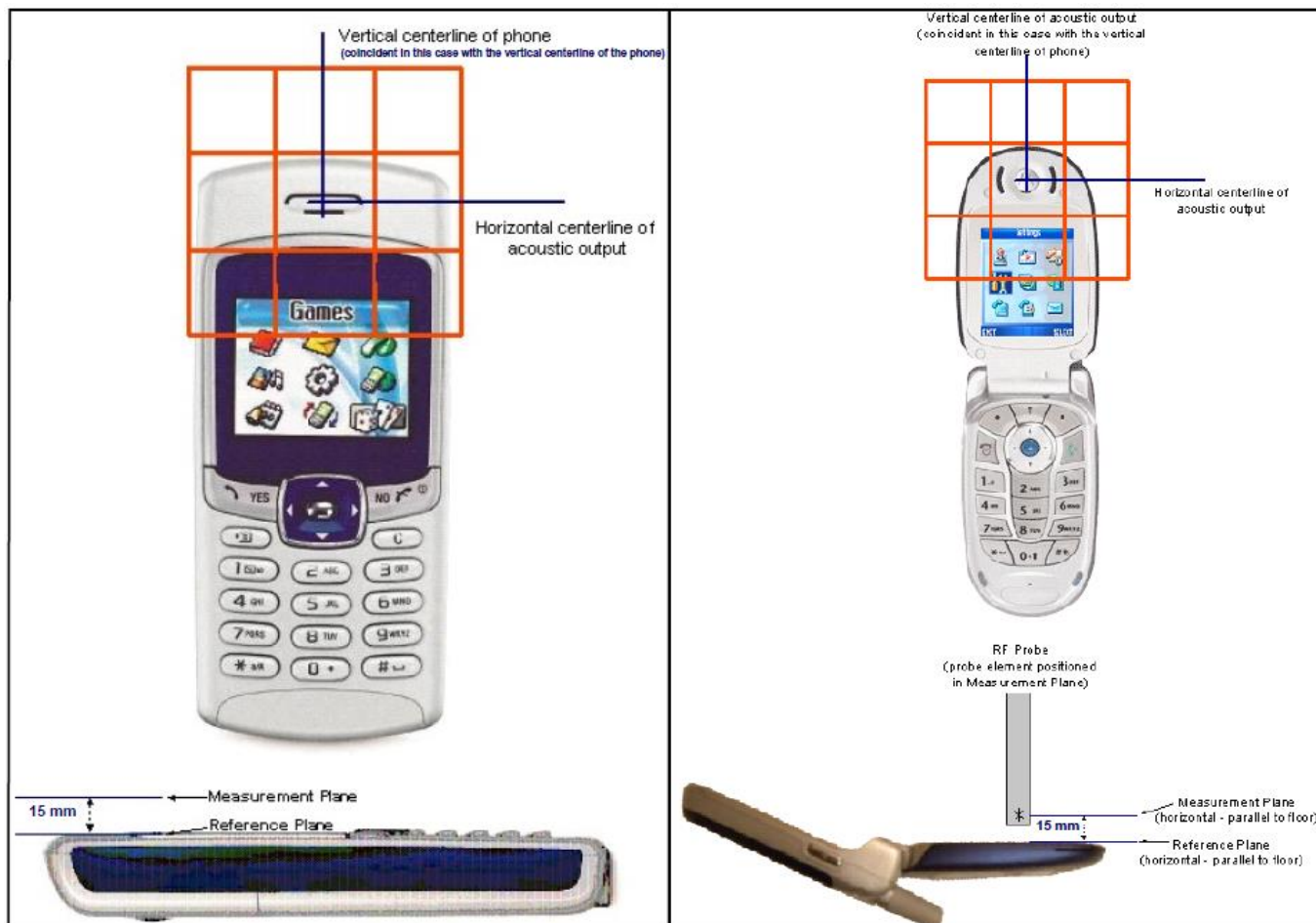

**Fig-3.4 EUT Reference and Plane**

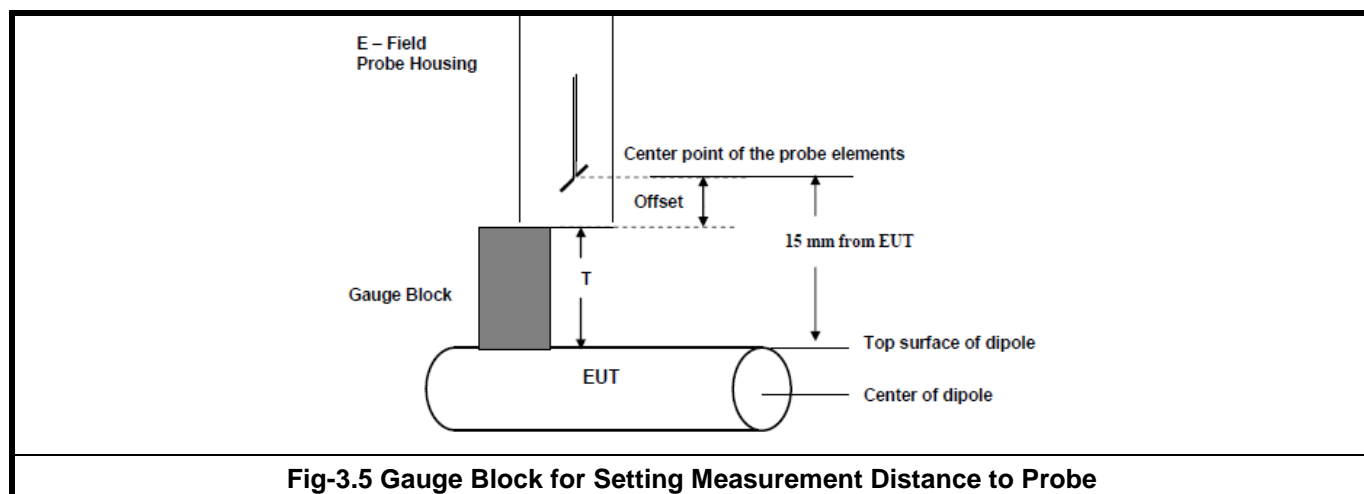

**Fig-3.5 Gauge Block for Setting Measurement Distance to Probe**

### 3.4 HAC RF Emission Measurement Procedure

The RF emissions test procedure for wireless communications device is as below.

1. Confirm the proper operation of the field probe, probe measurement system, and other instrumentation and the positioning system.
2. Position the WD in its intended test position.
3. Set the WD to transmit a fixed and repeatable combination of signal power and modulation characteristic that is representative of the worst case (highest interference potential) encountered in normal use. Transiently occurring start-up, changeover, or termination conditions, or other operations likely to occur less than 1% of the time during normal operation, may be excluded from consideration.
4. The center sub-grid shall be centered on the T-Coil mode perpendicular measurement point or the acoustic output, as appropriate. Locate the field probe at the initial test position in the 50 mm by 50 mm grid, which is contained in the measurement plane, illustrated in Fig-3.4. If the field alignment method is used, align the probe for maximum field reception.
5. Record the reading at the output of the measurement system.
6. Scan the entire 50 mm by 50 mm region in equally spaced increments and record the reading at each measurement point. The distance between measurement points shall be sufficient to assure the identification of the maximum reading.
7. Identify the five contiguous sub-grids around the center sub-grid whose maximum reading is the lowest of all available choices. This eliminates the three sub-grids with the maximum readings. Thus, the six areas to be used to determine the WD's highest emissions are identified.
8. Identify the maximum reading within the non-excluded sub-grids identified in step 7.
9. Indirect Measurement Method: The RF audio interference level in dB(V/m) is obtained by adding the MIF (in dB) to the maximum steady-state rms field-strength reading, in dB(V/m), from step 8. Use this result to determine the category rating.

10. Compare this RF audio interference level with the categories in section 4.1 and record the resulting WD category rating.
- 11 For the T-Coil mode M-rating assessment, determine whether the chosen perpendicular measurement point is contained in an included sub-grid of the first can. If so, then a second scan is not necessary. The first scan and resultant category rating may be used for the T-Coil mode M-rating. Otherwise, repeat step 1 through step 9, with the grid shifted so that it is centered on the perpendicular measurement point. Record the WD category rating.

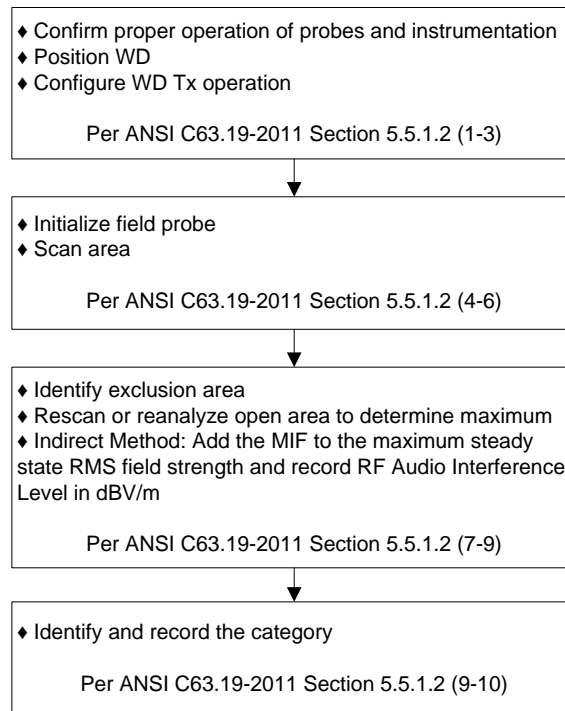

**Fig-3.6 WD Near-Field Emission Test Flowchart**

**3.5 Modulation Interference Factor**

The HAC Standard ANSI C63.19-2011 defines a new scaling using the Modulation Interference Factor (MIF) which replaces the need for the Articulation Weighting Factor (AWF) during the evaluation and is applicable to any modulation scheme.

The Modulation Interference Factor (MIF, in dB) is added to the measured average E-field (in dBV/m) and converts it to the RF audio interference potential (in dBV/m). This level considers the audible amplitude modulation components in the RF E-field. CW fields without amplitude modulation are assumed to not interfere with the hearing aid electronics. Modulations without time slots and low fluctuations at low frequencies have low MIF values, TDMA modulations with narrow transmission slots and repetition rates of few 100 Hz have high MIF values and give similar classification as ANSI C63.19-2007.

ER3D E-field probe have a bandwidth <10 kHz and can therefore not evaluate the RF envelope in the full audio band. DASY52 is therefore using the "indirect" measurement method according to ANSI C63.19-2011 which is the primary method. This near field probe read the averaged E-field. Especially for the new high peak-to-average (PAR) signal types, the probes shall be linearized by PMR calibration in order to not overestimate the field reading.

The evaluation method for the MIF is defined in ANSI C63.19-2011 section D.7. An RMS demodulated RF signal is fed to a spectral filter (similar to an A weighting filter) and forwarded to a temporal filter acting as a quasi-peak detector. The averaged output of these filtering is scaled to a 1 kHz 80% AM signal as reference. It may alternatively be determined through analysis and simulation, because it is constant and characteristic for a communication signal. DASY52 uses well-defined signals for PMR calibration. The MIF of these signals has been determined numerically. It allows a precise scaling and is therefore automatically applied.

The following table lists the MIF values evaluated by DASY manufacturer (SPEAG), and the test result will be calculated with the MIF parameter automatically. The detailed parameters for E-field probe can be found in the probe calibration report in appendix C.

UID	Reversion	Communication System Name	MIF (dB)
10021	DAC	GSM-FDD (TDMA, GMSK)	3.63
10025	DAC	EDGE-FDD (TDMA, 8PSK, TN 0)	3.75
10460	AAA	UMTS-FDD (WCDMA, AMR)	-25.43
10225	CAB	UMTS-FDD (HSPA+)	-20.39
10081	CAB	CDMA2000 (1xRTT, RC3)	-19.71
10295	AAB	CDMA2000, RC1, SO3, 1/8th Rate 25 fr.	3.26
10403	AAB	CDMA2000 (1xEV-DO, Rev. 0)	-17.67
10170	CAE	LTE-FDD (SC-FDMA, 1 RB, 20 MHz, 16-QAM)	-9.76
10172	CAG	LTE-TDD (SC-FDMA, 1 RB, 20 MHz, QPSK)	-1.62
10173	CAG	LTE-TDD (SC-FDMA, 1 RB, 20 MHz, 16-QAM)	-1.44
10174	CAG	LTE-TDD (SC-FDMA, 1 RB, 20 MHz, 64-QAM)	-1.54
10061	CAB	IEEE 802.11b WiFi 2.4 GHz (DSSS, 11 Mbps)	-2.02
10077	CAB	IEEE 802.11g WiFi 2.4 GHz (DSSS/OFDM, 54 Mbps)	0.12
10427	AAB	IEEE 802.11n (HT Greenfield, 150 Mbps, 64-QAM)	-13.44
10069	CAC	IEEE 802.11a/h WiFi 5 GHz (OFDM, 54 Mbps)	-3.15
10616	AAB	IEEE 802.11ac WiFi (40MHz, MCS0, 90pc duty cycle)	-5.57

## FCC HAC (RF Emission) Test Report

---

The MIF measurement uncertainty listed in following table is estimated by SPEAG.

MIF (dB)	MIF Measurement Uncertainty (dB)
-7 to +5	0.2
-13 to +11	0.5
> -20	1.0

**4. HAC Measurement Evaluation**

**4.1 M-Rating Category**

The HAC Standard ANSI C63.19-2011 represents performance requirements for acceptable interoperability of hearing aids with wireless communications devices. When these parameters are met, a hearing aid operates acceptably in close proximity to a wireless communications device.

Emission Categories	E-Field Emissions < 960 MHz (dB V/m)	E-Field Emissions > 960 MHz (dB V/m)
Category M1	50 - 55	40 - 45
Category M2	45 - 50	35 - 40
Category M3	40 - 45	30 - 35
Category M4	< 40	< 30

**4.2 EUT Configuration and Setting**

For HAC RF emission testing, the EUT was linked and controlled by base station emulator. Communication between the EUT and the emulator was established by air link. The distance between the EUT and the communicating antenna of the emulator is larger than 50 cm and the output power radiated from the emulator antenna is at least 30 dB smaller than the output power of EUT. The EUT was set from the emulator to radiate maximum output power during HAC testing.

**4.3 System Verification**

The measuring results for system check are shown as below.

Frequency (MHz)	Input Power (dBm)	Target Value (V/m)	E-Field 1 (V/m)	E-Field 2 (V/m)	Average E-Field (V/m)	Deviation (%)	Test Date
835	20.0	107.6	111.9	110.5	111.2	3.35	Nov. 09, 2018
1880	20.0	91.0	92.7	93.89	93.295	2.52	Nov. 09, 2018
2600	20.0	85.8	89.38	92.07	90.725	5.74	Nov. 09, 2018

**Note:**

1. Comparing to the reference target value provided by SPEAG, the validation data should be within its specification of 25 %. The result indicates the system check can meet the variation criterion and the plots can be referred to Appendix A of this report.
2. For E-Field, the deviation is  $[(E\text{-Field } 1 + E\text{-Field } 2) / 2 - \text{Target Value}] / \text{Target Value} \times 100\%$



**4.4 Maximum Target Conducted Power**

The maximum conducted average power (Unit: dBm) including tune-up tolerance is shown as below.

Air Interface		Max. Tune-up Power	
GSM	GSM850	33.2	
	EDGE850	26.5	
	GSM1900	30.3	
	EDGE1900	26.0	
WCDMA	Band II	24.0	
	Band IV	24.0	
	Band V	25.0	
CDMA	BC0	25.0	
	BC1	25.0	
	BC10	25.0	
FDD-LTE	Band 2	24.0	
	Band 4	24.0	
	Band 5	24.0	
	Band 12	24.0	
	Band 13	24.0	
	Band 14	24.0	
	Band 25	24.0	
	Band 26	24.0	
TDD-LTE	Band 38	QPSK	24.0
		16QAM	23.0
		64QAM	22.0
	Band 41	QPSK	26.5
		16QAM	25.5
		64QAM	24.5

# FCC HAC (RF Emission) Test Report

	Air Interface	Max. Tune-up Power
WLAN 2.4G	802.11b	16.0
	802.11g	16.0
	802.11n HT20	16.0
	802.11n HT40	13.0
WLAN 5.2G	802.11a	16.5
	802.11n HT20	16.0
	802.11n HT40	13.0
WLAN 5.3G	802.11a	16.5
	802.11n HT20	16.0
	802.11n HT40	13.0
WLAN 5.6G	802.11a	16.5
	802.11n HT20	16.5
	802.11n HT40	13.0
WLAN 5.8G	802.11a	16.5
	802.11n HT20	16.5
	802.11n HT40	13.0

**4.5 Low Power Exemption Evaluation**

According to ANSI C63.19-2011 section 4, RF air interface technologies that have low power have been found to produce sufficiently low RF interference potential, so it is possible to exempt them from the product testing. An RF air interface technology of a device is exempt from testing when its average antenna input power plus its worst-case MIF is  $\leq 17$  dBm for any of its operating modes. If a device supports multiple RF air interfaces, each RF air interface shall be evaluated individually. An RF air interface technology that is exempted from testing by above method could be rated as M4.

The low power exemption for this device is analyzed in below.

Air Interface		Max. Tune-up Power (dBm)	Worst Case MIF (dB)	Power + MIF (dB)	C63.19 Testing Required	
GSM	GSM850	33.2	3.63	36.83	YES	
	EDGE850	26.5	3.75	30.25	No	
	GSM1900	30.3	3.63	33.93	YES	
	EDGE1900	26	3.75	29.75	No	
WCDMA	AMR	25	-25.43	-0.43	No	
	HSPA	25	-20.39	4.61	No	
CDMA	Full Frame Rate	25	-19.71	5.29	No	
	1/8th Frame Rate	25	3.26	28.26	YES	
	EVDO	25	-17.67	7.33	No	
FDD-LTE		24	-9.76	14.24	No	
TDD-LTE	QPSK	26.5	-1.62	24.88	YES	
	16QAM	25.5	-1.44	24.06	No	
	64QAM	24.5	-1.54	22.96	No	
WLAN 2.4G	802.11b	ANT 1	16	-2.02	13.98	No
	802.11g	ANT 1	16	0.12	16.12	No
	802.11n HT20	ANT 1	16	-13.44	2.56	No
	802.11n HT40	ANT 1	13	-13.44	-0.44	No
WLAN 5.2G	802.11a	ANT 1	16.5	-3.15	13.35	No
	802.11n HT20	ANT 1	16	-13.44	2.56	No
	802.11n HT40	ANT 1	13	-13.44	-0.44	No
WLAN 5.3G	802.11a	ANT 1	16.5	-3.15	13.35	No
	802.11n HT20	ANT 1	16	-13.44	2.56	No
	802.11n HT40	ANT 1	13	-13.44	-0.44	No
WLAN 5.6G	802.11a	ANT 1	16.5	-3.15	13.35	No
	802.11n HT20	ANT 1	16.5	-13.44	3.06	No
	802.11n HT40	ANT 1	13	-13.44	-0.44	No
WLAN 5.8G	802.11a	ANT 1	16.5	-3.15	13.35	No
	802.11n HT20	ANT 1	16.5	-13.44	3.06	No
	802.11n HT40	ANT 1	13	-13.44	-0.44	No

**Note:**

1. The EDGE data modes were considered but not tested because GSM voice mode was worst case for the GSM air interface.
2. The TDD-LTE 16QAM/64QAM data modes were considered but not tested because QPSK mode was worst case for the TDD-LTE air interface.

# FCC HAC (RF Emission) Test Report

## 4.6 Measured Conducted Power Results

The measuring conducted average power (Unit: dBm) are shown as below.

Band	GSM850			GSM1900		
Channel	128	189	251	512	661	810
Frequency (MHz)	824.2	836.4	848.8	1850.2	1880.0	1909.8
GSM (GMSK, 1 Tx Slot)	32.52	32.74	32.84	28.49	28.53	28.45

Band	CDMA BC0			CDMA BC1		
Channel	1013	384	777	25	600	1175
Frequency (MHz)	824.70	836.52	848.31	1851.25	1880.00	1908.75
RC1+SO3, 1/8th Rate	23.72	23.84	23.68	23.96	24.05	23.97

Band	CDMA BC10		
Channel	476	580	684
Frequency (MHz)	817.9	820.5	823.1
RC1+SO3, 1/8th Rate	24.18	24.14	24.11

Band	LTE Band 38					
BW	Modulation	RB Size	RB Offset	Low	Mid	High
		Channel		37850	38000	38150
		Frequency (MHz)		2580	2595	2610
20M	QPSK	1	0	23.18	23.05	22.96
		1	50	23.31	23.18	23.09
		1	99	23.19	23.06	22.97
		50	0	22.54	22.41	22.32
		50	25	22.67	22.54	22.45
		50	50	22.42	22.29	22.20
		100	0	22.50	22.37	22.28

Band	LTE Band 41							
BW	Modulation	RB Size	RB Offset	Low	Low-Mid	Mid	High-Mid	High
		Channel		39750	40185	40620	41055	41490
		Frequency (MHz)		2506	2549.5	2593	2636.5	2680
20M	QPSK	1	0	26.07	26.05	25.99	25.79	26.13
		1	50	26.28	26.26	26.20	26.00	26.34
		1	99	25.69	25.67	25.61	25.41	25.75
		50	0	25.20	25.18	25.12	24.92	25.26
		50	25	25.26	25.24	25.18	24.98	25.32
		50	50	25.36	25.34	25.28	25.08	25.42
		100	0	25.23	25.21	25.15	24.95	25.29

## FCC HAC (RF Emission) Test Report

### 4.7 HAC RF Emission Testing Results

Plot No.	Band	Mode	Channel	Audio Interference Level (dB V/m)	FCC Limit (dB V/m)	FCC Margin (dB)	M-Rating
01	GSM850	GSM Voice	128	40.59	45	-4.41	M3
	GSM850	GSM Voice	189	40.94	45	-4.06	M3
	GSM850	GSM Voice	251	40.79	45	-4.21	M3
02	GSM1900	GSM Voice	512	28.23	35	-6.77	M4
	GSM1900	GSM Voice	661	28.25	35	-6.75	M4
	GSM1900	GSM Voice	810	28.94	35	-6.06	M4
03	CDMA BC0	RC1+SO3, 1/8th Rate	1013	37.52	45	-7.48	M4
	CDMA BC0	RC1+SO3, 1/8th Rate	384	33.9	45	-11.1	M4
	CDMA BC0	RC1+SO3, 1/8th Rate	777	35.53	45	-9.47	M4
	CDMA BC1	RC1+SO3, 1/8th Rate	25	21.7	35	-13.3	M4
	CDMA BC1	RC1+SO3, 1/8th Rate	600	20.99	35	-14.01	M4
04	CDMA BC1	RC1+SO3, 1/8th Rate	1175	22.9	35	-12.1	M4
	CDMA BC10	RC1+SO3, 1/8th Rate	476	33.84	45	-11.16	M4
	CDMA BC10	RC1+SO3, 1/8th Rate	580	36.58	45	-8.42	M4
05	CDMA BC10	RC1+SO3, 1/8th Rate	684	34.48	45	-10.52	M4
	LTE B38	20M, QPSK, 1RB, OS0	37850	20.19	35	-14.81	M4
	LTE B38	20M, QPSK, 1RB, OS0	38000	20.11	35	-14.89	M4
06	LTE B38	20M, QPSK, 1RB, OS0	38150	20.77	35	-14.23	M4
	LTE B41	20M, QPSK, 1RB, OS0	39750	22.04	35	-12.96	M4
	LTE B41	20M, QPSK, 1RB, OS0	40185	23.27	35	-11.73	M4
	LTE B41	20M, QPSK, 1RB, OS0	40620	22.89	35	-12.11	M4
	LTE B41	20M, QPSK, 1RB, OS0	41055	22.79	35	-12.21	M4
07	LTE B41	20M, QPSK, 1RB, OS0	41490	21.72	35	-13.28	M4

Test Engineer : Willy Chang

**5. Calibration of Test Equipment**

Equipment	Manufacturer	Model	SN	Cal. Date	Cal. Interval
835MHz Calibration Dipole	SPEAG	CD835V3	1041	Mar. 20, 2017	2 Years
1880MHz Calibration Dipole	SPEAG	CD1880V3	1032	Apr. 25, 2017	2 Years
2600MHz Calibration Dipole	SPEAG	CD2600V3	1005	Mar. 14, 2018	2 Years
Data Acquisition Electronics	SPEAG	DAE4	861	May. 30, 2018	1 Year
Wireless Communication Test Set	Agilent	E5515C	MY50266628	Dec. 06, 2017	1 Year
Universal Radio Communication Tester	R&S	CMW500	164864	Jan. 15, 2018	1 Year
MXG Analog Signal Generator	Agilent	N5181A	MY50143868	Jul. 03, 2018	1 Year
Power Meter	Anritsu	ML2495A	1218009	Jul. 03, 2018	1 Year
Power Sensor	Anritsu	MA2411B	1207252	Jul. 03, 2018	1 Year
Test Arch Phantom	SPEAG	Arch	N/A	N/A	N/A
Directional Coupler	Woken	0110A05602O-10	11122702	Sep. 10, 2018	1 Year
Power Amplifier	AR	5S1G4	0339656	Sep. 10, 2018	1 Year
Power Amplifier	AR	15S1G6	0350544	Sep. 10, 2018	1 Year

## FCC HAC (RF Emission) Test Report

### 6. Measurement Uncertainty

Error Description	Uncertainty Value (±%)	Probability Distribution	Divisor	Ci (E)	Standard Uncertainty (E)
<b>Measurement System</b>					
Probe Calibration	5.05	Normal	1	1	± 5.1 %
Axial Isotropy	4.7	Rectangular	√3	1	± 2.7 %
Sensor Displacement	16.5	Rectangular	√3	1	± 9.5 %
Boundary Effects	2.4	Rectangular	√3	1	± 1.4 %
Phantom Boundary Effect	7.2	Rectangular	√3	1	± 4.2 %
Linearity	4.7	Rectangular	√3	1	± 2.7 %
Scaling with PMR Calibration	10.0	Rectangular	√3	1	± 5.8 %
System Detection Limit	0.25	Rectangular	√3	1	± 0.1 %
Readout Electronics	0.3	Normal	1	1	± 0.3 %
Response Time	0.0	Rectangular	√3	1	± 0.0 %
Integration Time	2.6	Rectangular	√3	1	± 1.5 %
RF Ambient Conditions	3.0	Rectangular	√3	1	± 1.7 %
RF Reflections	12.0	Rectangular	√3	1	± 6.9 %
Probe Positioner	1.2	Rectangular	√3	1	± 0.7 %
Probe Positioning	4.7	Rectangular	√3	1	± 2.7 %
Extrap. and Interpolation	2.0	Rectangular	√3	1	± 1.2 %
<b>Test Sample Related</b>					
Device Positioning Vertical	4.7	Rectangular	√3	1	± 2.7 %
Device Positioning Lateral	1.0	Rectangular	√3	1	± 0.6 %
Device Holder and Phantom	2.4	Rectangular	√3	1	± 1.4 %
Power Drift	5.0	Rectangular	√3	1	± 2.9 %
<b>Phantom and Setup Related</b>					
Phantom Thickness	2.4	Rectangular	√3	1	± 1.4 %
<b>Combined Standard Uncertainty</b>					± 16.3 %
Coverage Factor for 95 %					K = 2
<b>Expanded Uncertainty</b>					± 32.6 %

Uncertainty budget for HAC RF Emission

### **7. Information of the Testing Laboratories**

We, Bureau Veritas Consumer Products Services (H.K.) Ltd., Taoyuan Branch, were founded in 1988 to provide our best service in EMC, Radio, Telecom and Safety consultation. Our laboratories are accredited and approved according to ISO/IEC 17025.

If you have any comments, please feel free to contact us at the following:

**Taiwan HwaYa EMC/RF/Safety/Telecom Lab:**

Add: No. 19, Hwa Ya 2nd Rd, Wen Hwa Vil., Kwei Shan Hsiang, Taoyuan Hsien 333, Taiwan, R.O.C.

Tel: 886-3-318-3232

Fax: 886-3-327-0892

**Taiwan LinKo EMC/RF Lab:**

Add: No. 47-2, 14th Ling, Chia Pau Vil., Linkou Dist., New Taipei City 244, Taiwan, R.O.C.

Tel: 886-2-2605-2180

Fax: 886-2-2605-1924

**Taiwan HsinChu EMC/RF Lab:**

Add: E-2, No.1, Li Hsin 1<sup>st</sup> Road, Hsinchu Science Park, Hsinchu City 30078, Taiwan, R.O.C.

Tel: 886-3-593-5343

Fax: 886-3-593-5342

**Email:** [service.adt@tw.bureauveritas.com](mailto:service.adt@tw.bureauveritas.com)

**Web Site:** [www.bureauveritas-adt.com](http://www.bureauveritas-adt.com)

The road map of all our labs can be found in our web site also.

---END---



## Appendix A. Plots of System Verification

The plots for system verification are shown as follows.

### System Check\_E-Field\_835\_181109

**DUT: HAC Dipole 835 MHz; Type: CD835V3; SN: 1041**

Communication System: CW; Frequency: 835 MHz; Duty Cycle: 1:1

Medium: Air Medium parameters used:  $\sigma = 0 \text{ S/m}$ ,  $\epsilon_r = 1$ ;  $\rho = 1000 \text{ kg/m}^3$

Ambient Temperature : 23.7 °C

DASY5 Configuration:

- Probe: EF3DV3 - SN4049; ConvF(1, 1, 1); Calibrated: 2017/12/05
- Sensor-Surface: (Fix Surface)
- Electronics: DAE4 Sn861; Calibrated: 2018/05/30
- Phantom: HAC Test Arch with AMCC; Type: SD HAC P01 BA;
- Measurement SW: DASY52, Version 52.10 (2); SEMCAD X Version 14.6.12 (7450)

**Hearing Aid Compatibility (41x361x1):** Interpolated grid: dx=0.5000 mm, dy=0.5000 mm

Device Reference Point: 0, 0, -6.3 mm

Reference Value = 117.2 V/m; Power Drift = 0.01 dB

E-field emissions = 111.9 V/m

Grid 1 <b>M4</b> <b>110.7 V/m</b>	Grid 2 <b>M4</b> <b>111.9 V/m</b>	Grid 3 <b>M4</b> <b>107.8 V/m</b>
Grid 4 <b>M4</b> <b>60.42 V/m</b>	Grid 5 <b>M4</b> <b>60.83 V/m</b>	Grid 6 <b>M4</b> <b>58.91 V/m</b>
Grid 7 <b>M4</b> <b>109.3 V/m</b>	Grid 8 <b>M4</b> <b>110.5 V/m</b>	Grid 9 <b>M4</b> <b>106.6 V/m</b>

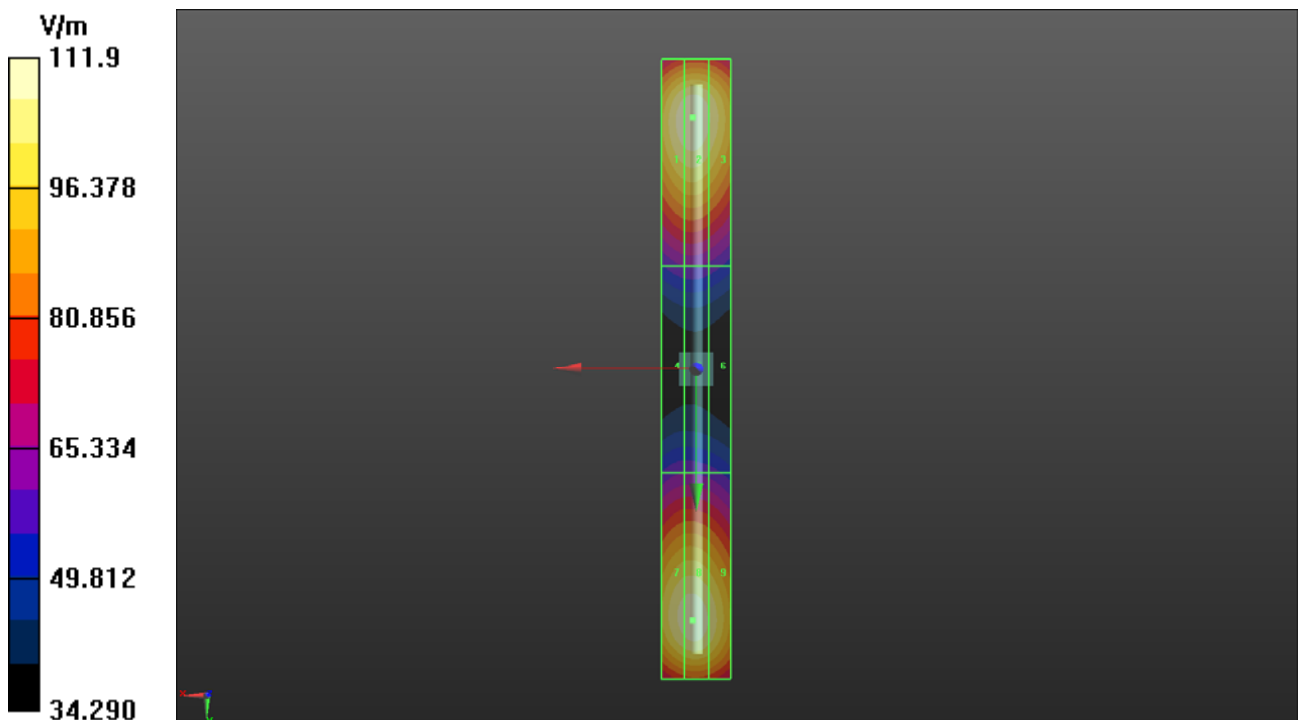

### System Check\_E-Field\_1880\_181109

**DUT: HAC Dipole 1880 MHz; Type: CD1880V3; SN: 1032**

Communication System: CW; Frequency: 1880 MHz; Duty Cycle: 1:1

Medium: Air Medium parameters used:  $\sigma = 0 \text{ S/m}$ ,  $\epsilon_r = 1$ ;  $\rho = 1000 \text{ kg/m}^3$

Ambient Temperature : 23.7 °C

DASY5 Configuration:

- Probe: EF3DV3 - SN4049; ConvF(1, 1, 1); Calibrated: 2017/12/05
- Sensor-Surface: (Fix Surface)
- Electronics: DAE4 Sn861; Calibrated: 2018/05/30
- Phantom: HAC Test Arch with AMCC; Type: SD HAC P01 BA;
- Measurement SW: DASY52, Version 52.10 (2); SEMCAD X Version 14.6.12 (7450)

**Hearing Aid Compatibility (41x181x1):** Interpolated grid: dx=0.5000 mm, dy=0.5000 mm

Device Reference Point: 0, 0, -6.3 mm

Reference Value = 152.1 V/m; Power Drift = 0.03 dB

E-field emissions = 93.89 V/m

Grid 1 <b>M3</b> <b>92.05 V/m</b>	Grid 2 <b>M3</b> <b>92.70 V/m</b>	Grid 3 <b>M3</b> <b>89.31 V/m</b>
Grid 4 <b>M3</b> <b>67.57 V/m</b>	Grid 5 <b>M3</b> <b>67.72 V/m</b>	Grid 6 <b>M3</b> <b>66.01 V/m</b>
Grid 7 <b>M3</b> <b>92.52 V/m</b>	Grid 8 <b>M3</b> <b>93.89 V/m</b>	Grid 9 <b>M3</b> <b>90.72 V/m</b>

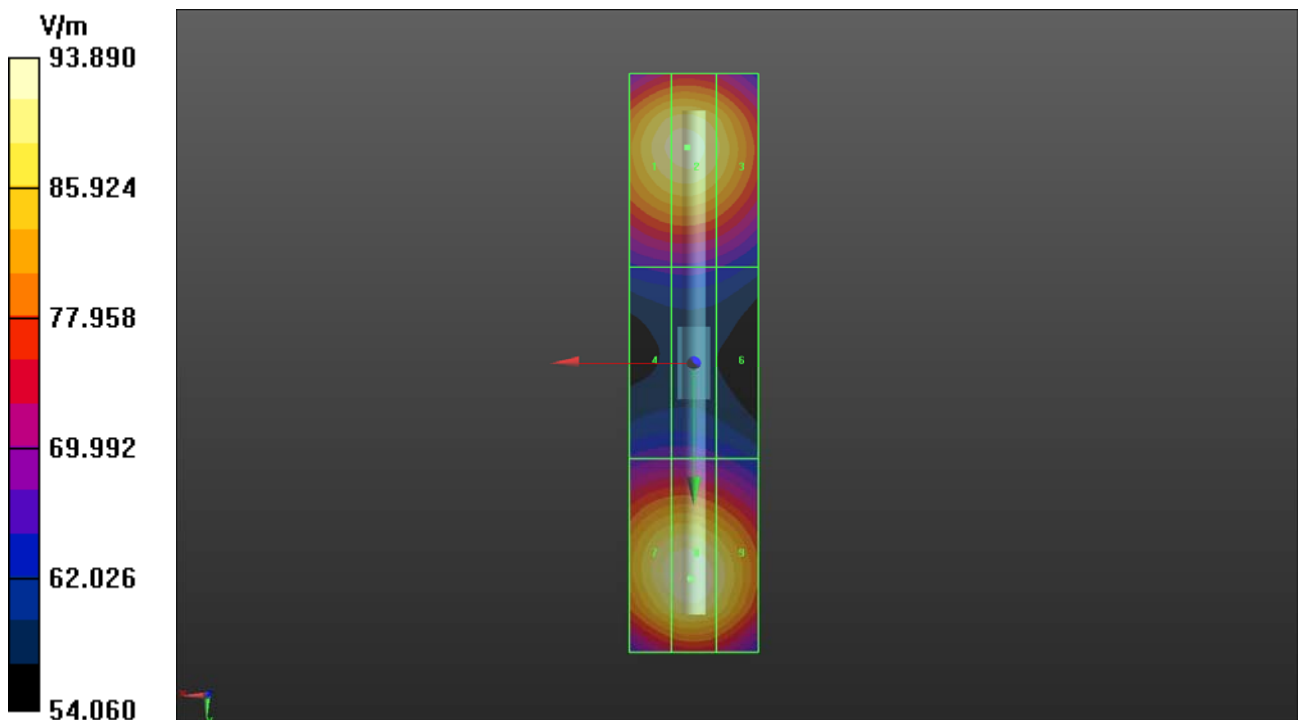

### System Check\_E-Field\_2600\_181109

**DUT: HAC Dipole 2600 MHz; Type: CD2600V3; SN:1005**

Communication System: CW; Frequency: 2600 MHz; Duty Cycle: 1:1

Medium: Air Medium parameters used:  $\sigma = 0 \text{ S/m}$ ,  $\epsilon_r = 1$ ;  $\rho = 0 \text{ kg/m}^3$

Ambient Temperature : 23.7 °C

DASY5 Configuration:

- Probe: EF3DV3 - SN4049; ConvF(1, 1, 1); Calibrated: 2017/12/05
- Sensor-Surface: (Fix Surface)
- Electronics: DAE4 Sn861; Calibrated: 2018/05/30
- Phantom: HAC Test Arch with AMCC; Type: SD HAC P01 BA;
- Measurement SW: DASY52, Version 52.10 (2); SEMCAD X Version 14.6.12 (7450)

**Hearing Aid Compatibility (41x181x1):** Interpolated grid: dx=0.5000 mm, dy=0.5000 mm

Device Reference Point: 0, 0, -6.3 mm

Reference Value = 70.26 V/m; Power Drift = 0.02 dB

E-field emissions = 92.07 V/m

Grid 1 M3 <b>88.76 V/m</b>	Grid 2 M3 <b>89.38 V/m</b>	Grid 3 M3 <b>85.74 V/m</b>
Grid 4 M3 <b>82.45 V/m</b>	Grid 5 M3 <b>82.69 V/m</b>	Grid 6 M3 <b>81.05 V/m</b>
Grid 7 M3 <b>90.75 V/m</b>	Grid 8 M3 <b>92.07 V/m</b>	Grid 9 M3 <b>89.48 V/m</b>

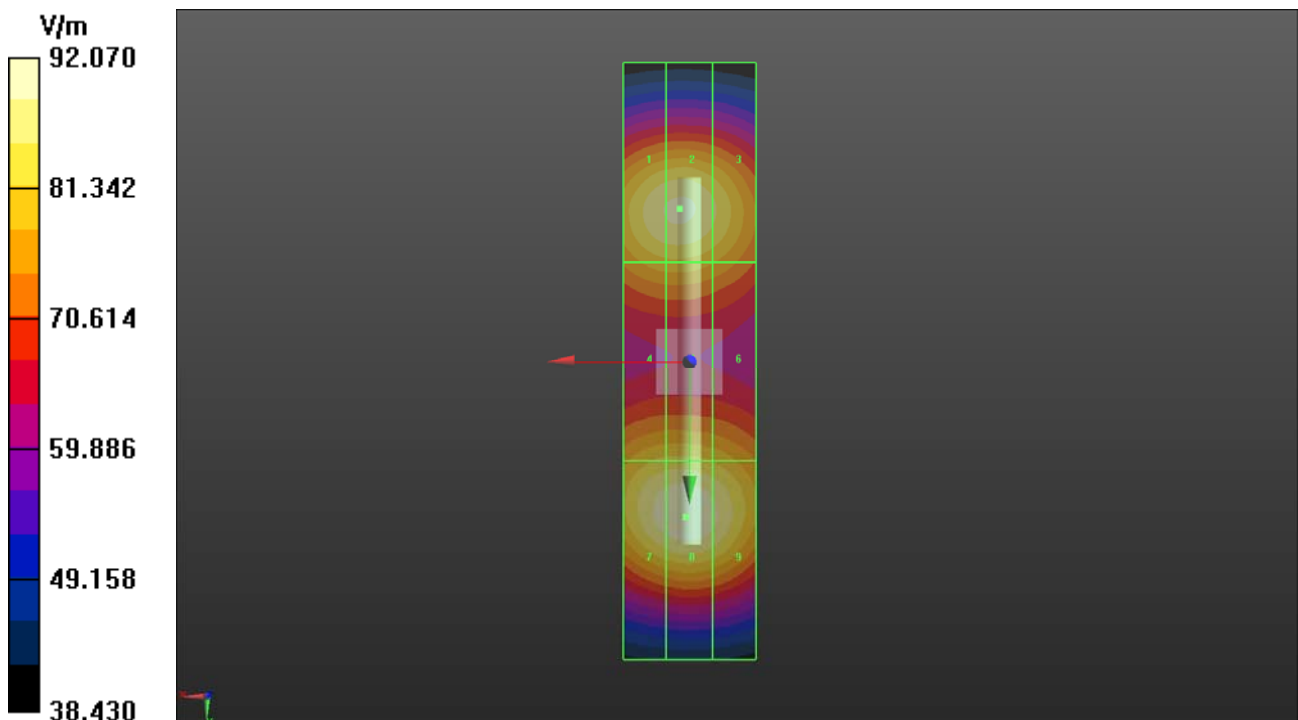



## **Appendix B. Plots of HAC RF Emission Measurement**

The plots for HAC measurement are shown as follows.

### P01 E-Field\_GSM850\_GSM\_Ch189

**DUT: 181019C31**

Communication System: GSM-FDD (TDMA, GMSK); Frequency: 836.4 MHz; Duty Cycle: 1:8.69

Medium: Air Medium parameters used:  $\sigma = 0 \text{ S/m}$ ,  $\epsilon_r = 1$ ;  $\rho = 1000 \text{ kg/m}^3$

Ambient Temperature : 23.7 °C

DASY5 Configuration:

- Probe: EF3DV3 - SN4049; ConvF(1, 1, 1); Calibrated: 2017/12/05
- Sensor-Surface: (Fix Surface)
- Electronics: DAE4 Sn861; Calibrated: 2018/05/30
- Phantom: HAC Test Arch with AMCC; Type: SD HAC P01 BA;
- Measurement SW: DASY52, Version 52.10 (2); SEMCAD X Version 14.6.12 (7450)

**Hearing Aid Compatibility (101x101x1):** Interpolated grid: dx=0.5000 mm, dy=0.5000 mm

Device Reference Point: 0, 0, -6.3 mm

Reference Value = 103.8 V/m; Power Drift = -0.03 dB

MIF = 3.63 dB

RF audio interference level = 40.94 dBV/m

**Emission category: M3**

Grid 1 <b>M3</b> <b>40.24 dBV/m</b>	Grid 2 <b>M3</b> <b>40.51 dBV/m</b>	Grid 3 <b>M4</b> <b>39.71 dBV/m</b>
Grid 4 <b>M3</b> <b>40.56 dBV/m</b>	Grid 5 <b>M3</b> <b>40.94 dBV/m</b>	Grid 6 <b>M3</b> <b>40.14 dBV/m</b>
Grid 7 <b>M3</b> <b>40.22 dBV/m</b>	Grid 8 <b>M3</b> <b>40.57 dBV/m</b>	Grid 9 <b>M4</b> <b>39.8 dBV/m</b>

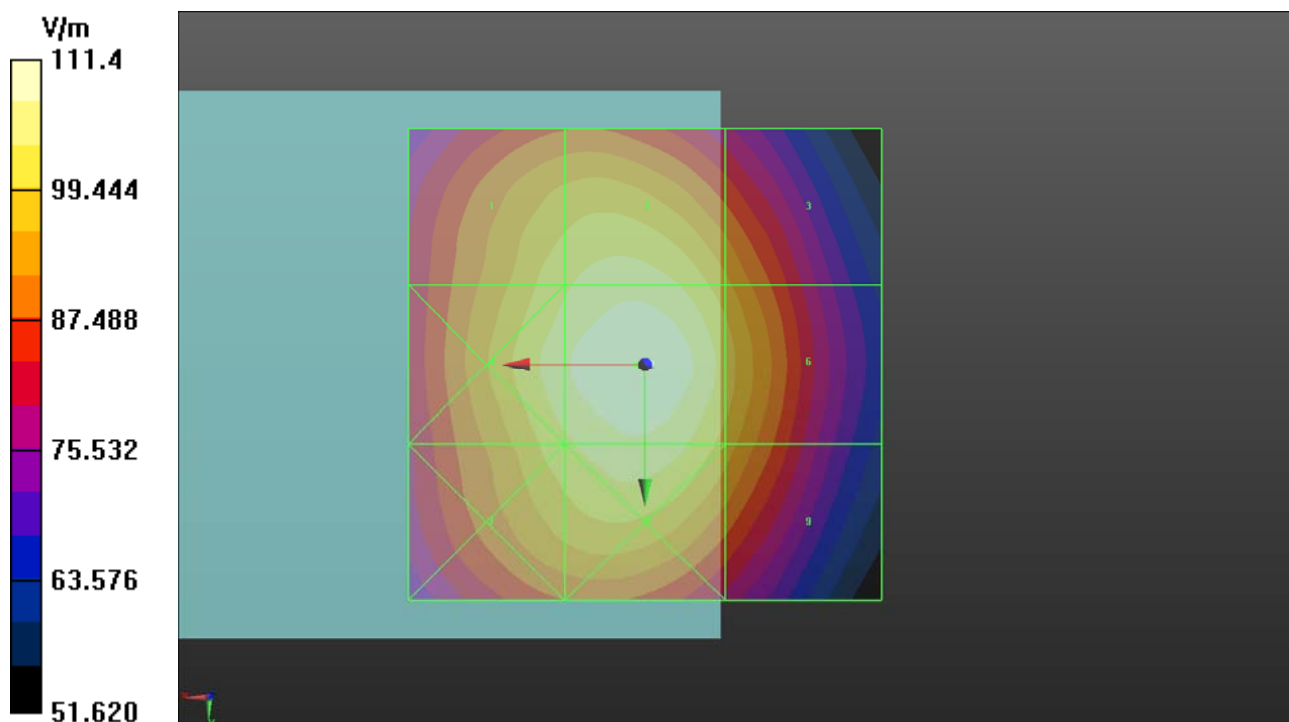

### P02 E-Field\_GSM1900\_GSM\_Ch810

**DUT: 181019C31**

Communication System: GSM-FDD (TDMA, GMSK); Frequency: 1909.8 MHz; Duty Cycle: 1:8.69  
 Medium: Air Medium parameters used:  $\sigma = 0 \text{ S/m}$ ,  $\epsilon_r = 1$ ;  $\rho = 1000 \text{ kg/m}^3$   
 Ambient Temperature : 23.7 °C

DASY5 Configuration:

- Probe: EF3DV3 - SN4049; ConvF(1, 1, 1); Calibrated: 2017/12/05
- Sensor-Surface: (Fix Surface)
- Electronics: DAE4 Sn861; Calibrated: 2018/05/30
- Phantom: HAC Test Arch with AMCC; Type: SD HAC P01 BA;
- Measurement SW: DASY52, Version 52.10 (2); SEMCAD X Version 14.6.12 (7450)

**Hearing Aid Compatibility (101x101x1):** Interpolated grid: dx=0.5000 mm, dy=0.5000 mm

Device Reference Point: 0, 0, -6.3 mm

Reference Value = 20.41 V/m; Power Drift = 0.05 dB

MIF = 3.63 dB

RF audio interference level = 28.94 dBV/m

**Emission category: M4**

Grid 1 <b>M4</b> <b>28.09 dBV/m</b>	Grid 2 <b>M4</b> <b>29.54 dBV/m</b>	Grid 3 <b>M4</b> <b>29.44 dBV/m</b>
Grid 4 <b>M4</b> <b>26.78 dBV/m</b>	Grid 5 <b>M4</b> <b>28.94 dBV/m</b>	Grid 6 <b>M4</b> <b>28.94 dBV/m</b>
Grid 7 <b>M4</b> <b>28.63 dBV/m</b>	Grid 8 <b>M4</b> <b>28.05 dBV/m</b>	Grid 9 <b>M4</b> <b>28.04 dBV/m</b>

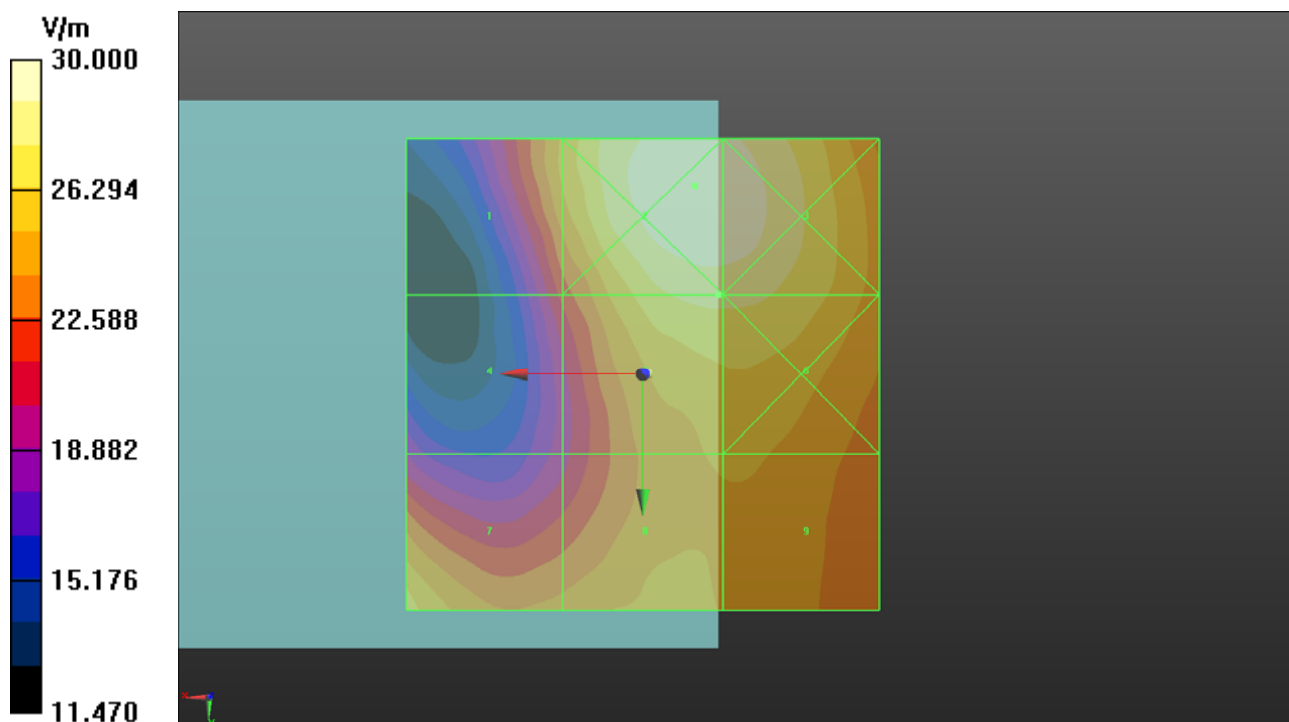

### P03 E-Field\_CDMA BC0\_RC1+SO3\_Ch1013

**DUT: 181019C31**

Communication System: CDMA2000, RC1, SO3, 1/8th Rate 25 fr.; Frequency: 824.7 MHz; Duty Cycle: 1:17.74

Medium: Air Medium parameters used:  $\sigma = 0 \text{ S/m}$ ,  $\epsilon_r = 1$ ;  $\rho = 1000 \text{ kg/m}^3$

Ambient Temperature : 23.7 °C

DASY5 Configuration:

- Probe: EF3DV3 - SN4049; ConvF(1, 1, 1); Calibrated: 2017/12/05
- Sensor-Surface: (Fix Surface)
- Electronics: DAE4 Sn861; Calibrated: 2018/05/30
- Phantom: HAC Test Arch with AMCC; Type: SD HAC P01 BA;
- Measurement SW: DASY52, Version 52.10 (2); SEMCAD X Version 14.6.12 (7450)

**Hearing Aid Compatibility (101x101x1):** Interpolated grid: dx=0.5000 mm, dy=0.5000 mm

Device Reference Point: 0, 0, -6.3 mm

Reference Value = 47.42 V/m; Power Drift = 0.08 dB

MIF = 3.26 dB

RF audio interference level = 37.52 dBV/m

**Emission category: M4**

Grid 1 <b>M4</b> <b>32.6 dBV/m</b>	Grid 2 <b>M4</b> <b>32.94 dBV/m</b>	Grid 3 <b>M4</b> <b>32.36 dBV/m</b>
Grid 4 <b>M4</b> <b>38.03 dBV/m</b>	Grid 5 <b>M4</b> <b>33.56 dBV/m</b>	Grid 6 <b>M4</b> <b>34.07 dBV/m</b>
Grid 7 <b>M4</b> <b>32.73 dBV/m</b>	Grid 8 <b>M4</b> <b>36.62 dBV/m</b>	Grid 9 <b>M4</b> <b>37.52 dBV/m</b>

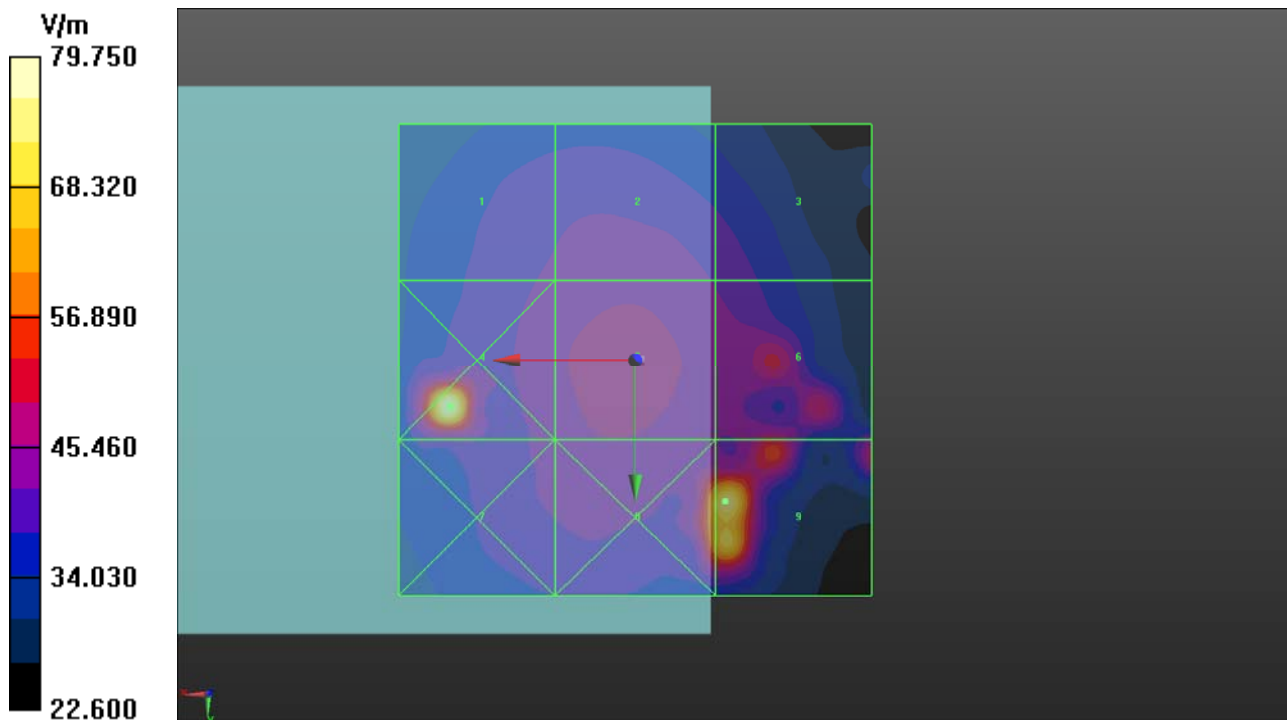



**P04 E-Field\_CDMA BC1\_RC1+SO3\_Ch1175**

**DUT: 181019C31**

Communication System: CDMA2000, RC1, SO3, 1/8th Rate 25 fr.; Frequency: 1908.75 MHz; Duty Cycle: 1:17.74

Medium: Air Medium parameters used:  $\sigma = 0 \text{ S/m}$ ,  $\epsilon_r = 1$ ;  $\rho = 1000 \text{ kg/m}^3$

Ambient Temperature : 23.7 °C

DASY5 Configuration:

- Probe: EF3DV3 - SN4049; ConvF(1, 1, 1); Calibrated: 2017/12/05
- Sensor-Surface: (Fix Surface)
- Electronics: DAE4 Sn861; Calibrated: 2018/05/30
- Phantom: HAC Test Arch with AMCC; Type: SD HAC P01 BA;
- Measurement SW: DASY52, Version 52.10 (2); SEMCAD X Version 14.6.12 (7450)

**Hearing Aid Compatibility (101x101x1):** Interpolated grid: dx=0.5000 mm, dy=0.5000 mm

Device Reference Point: 0, 0, -6.3 mm

Reference Value = 9.611 V/m; Power Drift = 0.06 dB

MIF = 3.26 dB

RF audio interference level = 22.90 dBV/m

**Emission category: M4**

Grid 1 <b>M4</b> <b>21.6 dBV/m</b>	Grid 2 <b>M4</b> <b>22.9 dBV/m</b>	Grid 3 <b>M4</b> <b>22.83 dBV/m</b>
Grid 4 <b>M4</b> <b>20.22 dBV/m</b>	Grid 5 <b>M4</b> <b>22.36 dBV/m</b>	Grid 6 <b>M4</b> <b>22.72 dBV/m</b>
Grid 7 <b>M4</b> <b>21.64 dBV/m</b>	Grid 8 <b>M4</b> <b>26.63 dBV/m</b>	Grid 9 <b>M4</b> <b>22.48 dBV/m</b>

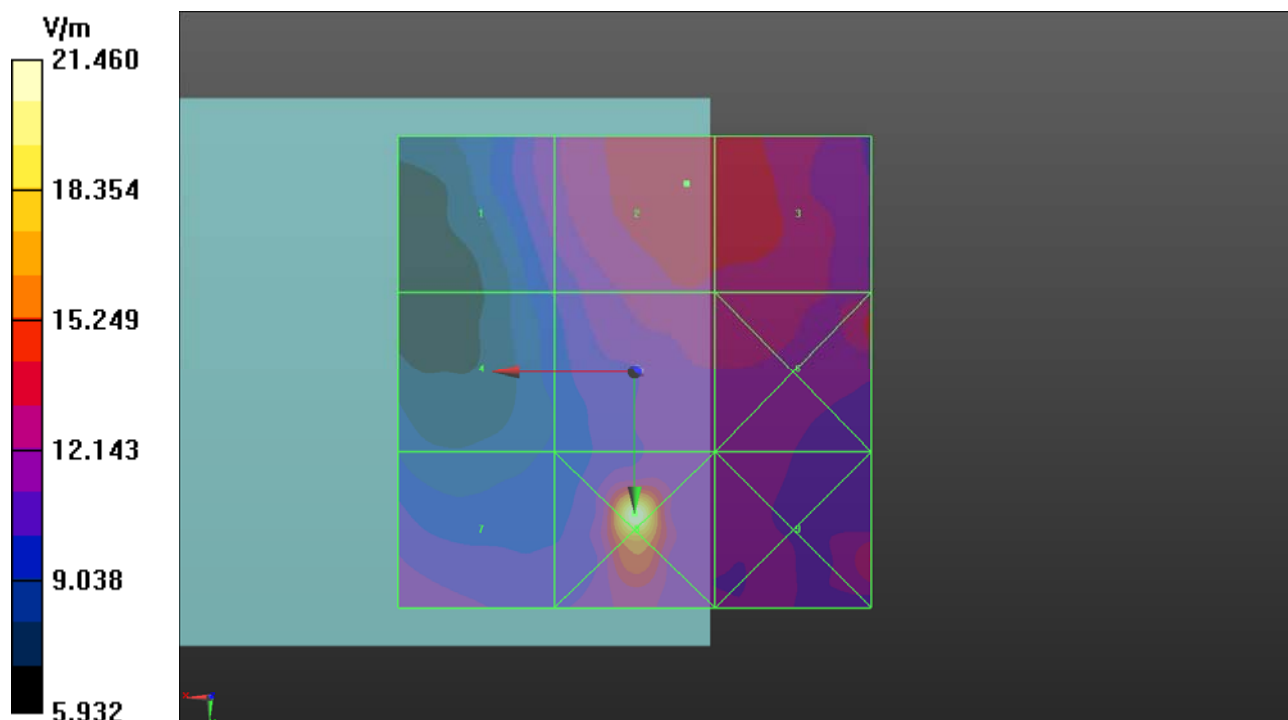

**P05 E-Field\_CDMA BC10\_RC1+SO3\_Ch580**

**DUT: 181019C31**

Communication System: CDMA2000, RC1, SO3, 1/8th Rate 25 fr.; Frequency: 820.5 MHz; Duty Cycle: 1:17.74

Medium: Air Medium parameters used:  $\sigma = 0$  S/m,  $\epsilon_r = 1$ ;  $\rho = 1000$  kg/m<sup>3</sup>

Ambient Temperature : 23.7 °C

DASY5 Configuration:

- Probe: EF3DV3 - SN4049; ConvF(1, 1, 1); Calibrated: 2017/12/05
- Sensor-Surface: (Fix Surface)
- Electronics: DAE4 Sn861; Calibrated: 2018/05/30
- Phantom: HAC Test Arch with AMCC; Type: SD HAC P01 BA;
- Measurement SW: DASY52, Version 52.10 (2); SEMCAD X Version 14.6.12 (7450)

**Hearing Aid Compatibility (101x101x1):** Interpolated grid: dx=0.5000 mm, dy=0.5000 mm

Device Reference Point: 0, 0, -6.3 mm

Reference Value = 46.78 V/m; Power Drift = -0.09 dB

MIF = 3.26 dB

RF audio interference level = 36.58 dBV/m

**Emission category: M4**

Grid 1 <b>M4</b> <b>32.91 dBV/m</b>	Grid 2 <b>M4</b> <b>35.18 dBV/m</b>	Grid 3 <b>M4</b> <b>32.35 dBV/m</b>
Grid 4 <b>M4</b> <b>36.21 dBV/m</b>	Grid 5 <b>M4</b> <b>36.58 dBV/m</b>	Grid 6 <b>M4</b> <b>34.35 dBV/m</b>
Grid 7 <b>M4</b> <b>32.7 dBV/m</b>	Grid 8 <b>M4</b> <b>34.99 dBV/m</b>	Grid 9 <b>M4</b> <b>34.6 dBV/m</b>

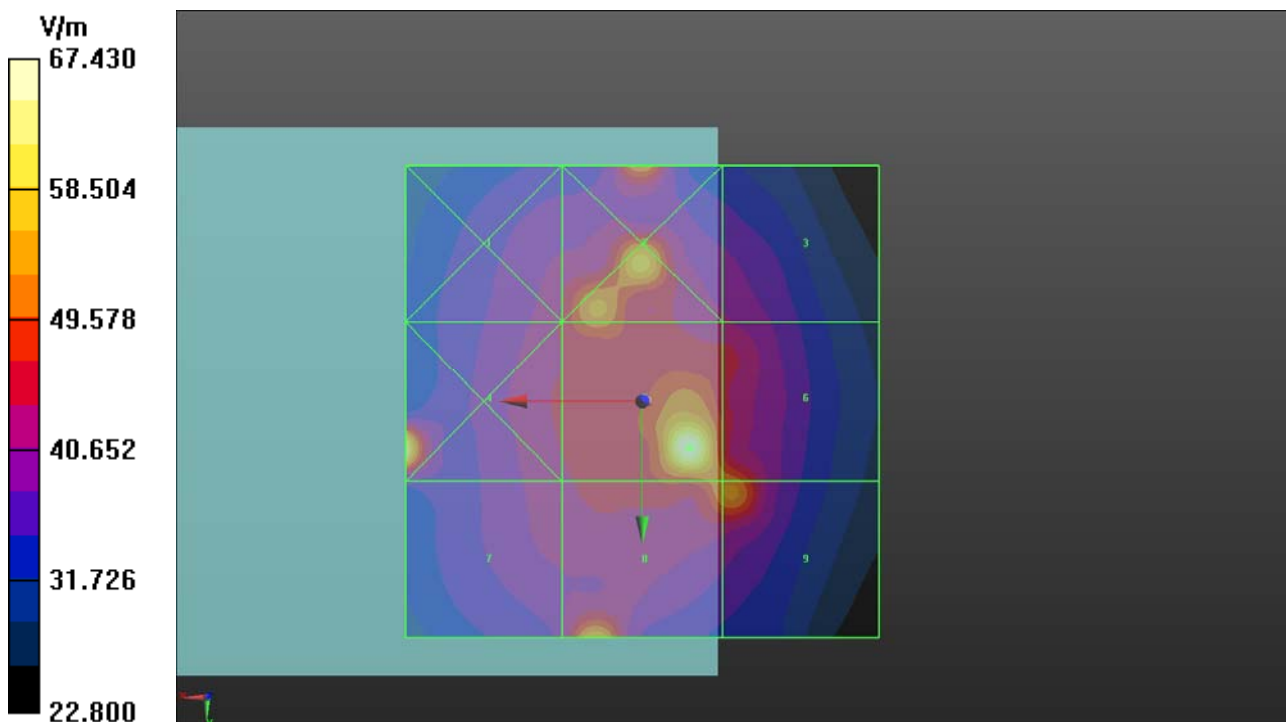

**P06 E-Field\_LTEW 38\_QPSK20M\_Ch38150\_1RB\_OS0**

**DUT: 181019C31**

Communication System: LTE-TDD (SC-FDMA, 1 RB, 20 MHz, QPSK); Frequency: 2610 MHz; Duty Cycle: 1:8.34

Medium: Air Medium parameters used:  $\sigma = 0$  S/m,  $\epsilon_r = 1$ ;  $\rho = 1000$  kg/m<sup>3</sup>

Ambient Temperature : 23.7 °C

DASY5 Configuration:

- Probe: EF3DV3 - SN4049; ConvF(1, 1, 1); Calibrated: 2017/12/05
- Sensor-Surface: (Fix Surface)
- Electronics: DAE4 Sn861; Calibrated: 2018/05/30
- Phantom: HAC Test Arch with AMCC; Type: SD HAC P01 BA;
- Measurement SW: DASY52, Version 52.10 (2); SEMCAD X Version 14.6.12 (7450)

**Hearing Aid Compatibility (101x101x1):** Interpolated grid: dx=0.5000 mm, dy=0.5000 mm

Device Reference Point: 0, 0, -6.3 mm

Reference Value = 10.37 V/m; Power Drift = -0.08 dB

MIF = -1.62 dB

RF audio interference level = 20.77 dBV/m

**Emission category: M4**

<b>Grid 1 M4</b> <b>20.78 dBV/m</b>	<b>Grid 2 M4</b> <b>19.28 dBV/m</b>	<b>Grid 3 M4</b> <b>18.96 dBV/m</b>
<b>Grid 4 M4</b> <b>19.22 dBV/m</b>	<b>Grid 5 M4</b> <b>20.12 dBV/m</b>	<b>Grid 6 M4</b> <b>20.57 dBV/m</b>
<b>Grid 7 M4</b> <b>18.16 dBV/m</b>	<b>Grid 8 M4</b> <b>20.67 dBV/m</b>	<b>Grid 9 M4</b> <b>20.83 dBV/m</b>

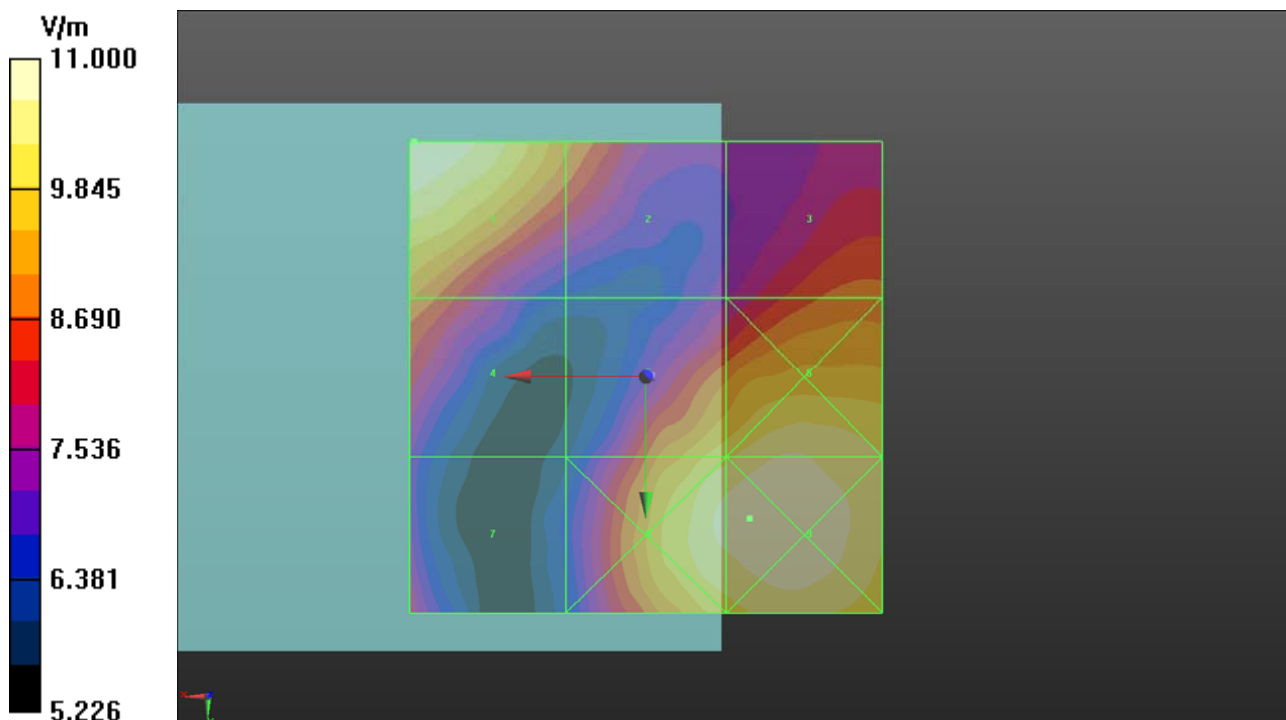

**P07 E-Field\_LTEW 41\_QPSK20M\_Ch40185\_1RB\_OS0**

**DUT: 181019C31**

Communication System: LTE-TDD (SC-FDMA, 1 RB, 20 MHz, QPSK); Frequency: 2549.5 MHz; Duty Cycle: 1:8.34

Medium: Air Medium parameters used:  $\sigma = 0$  S/m,  $\epsilon_r = 1$ ;  $\rho = 1000$  kg/m<sup>3</sup>

Ambient Temperature : 23.7 °C

DASY5 Configuration:

- Probe: EF3DV3 - SN4049; ConvF(1, 1, 1); Calibrated: 2017/12/05
- Sensor-Surface: (Fix Surface)
- Electronics: DAE4 Sn861; Calibrated: 2018/05/30
- Phantom: HAC Test Arch with AMCC; Type: SD HAC P01 BA;
- Measurement SW: DASY52, Version 52.10 (2); SEMCAD X Version 14.6.12 (7450)

**Hearing Aid Compatibility (101x101x1):** Interpolated grid: dx=0.5000 mm, dy=0.5000 mm

Device Reference Point: 0, 0, -6.3 mm

Reference Value = 11.57 V/m; Power Drift = 0.01 dB

MIF = -1.62 dB

RF audio interference level = 23.27 dBV/m

**Emission category: M4**

Grid 1 <b>M4</b> <b>23.27 dBV/m</b>	Grid 2 <b>M4</b> <b>22.06 dBV/m</b>	Grid 3 <b>M4</b> <b>20.69 dBV/m</b>
Grid 4 <b>M4</b> <b>21.66 dBV/m</b>	Grid 5 <b>M4</b> <b>22.17 dBV/m</b>	Grid 6 <b>M4</b> <b>22.77 dBV/m</b>
Grid 7 <b>M4</b> <b>19.86 dBV/m</b>	Grid 8 <b>M4</b> <b>23.31 dBV/m</b>	Grid 9 <b>M4</b> <b>23.43 dBV/m</b>

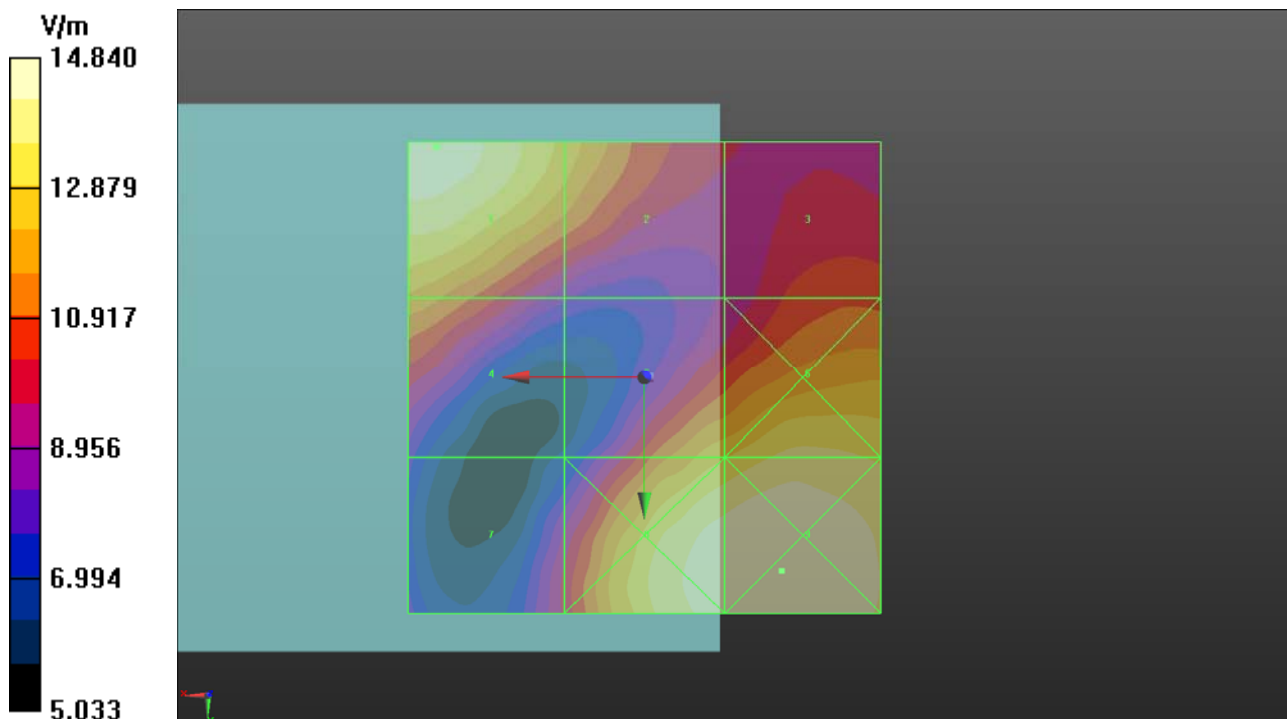



## **Appendix C. Calibration Certificate for Probe and Dipole**

The SPEAG calibration certificates are shown as follows.



Accredited by the Swiss Accreditation Service (SAS)  
The Swiss Accreditation Service is one of the signatories to the EA  
Multilateral Agreement for the recognition of calibration certificates

Accreditation No.: **SCS 0108**

Client **B.V. ADT (Auden)**

Certificate No: **CD835V3-1041\_Mar17**

## CALIBRATION CERTIFICATE

Object: **CD835V3 - SN: 1041**

Calibration procedure(s): **QA CAL-20.v6  
Calibration procedure for dipoles in air**

Calibration date: **March 20, 2017**

This calibration certificate documents the traceability to national standards, which realize the physical units of measurements (SI).  
The measurements and the uncertainties with confidence probability are given on the following pages and are part of the certificate.

All calibrations have been conducted in the closed laboratory facility: environment temperature (22 ± 3)°C and humidity < 70%.

Calibration Equipment used (M&TE critical for calibration)

Primary Standards	ID #	Cal Date (Certificate No.)	Scheduled Calibration
Power meter NRP	SN: 104778	06-Apr-16 (No. 217-02288/02289)	Apr-17
Power sensor NRP-Z91	SN: 103244	06-Apr-16 (No. 217-02288)	Apr-17
Power sensor NRP-Z91	SN: 103245	06-Apr-16 (No. 217-02289)	Apr-17
Reference 20 dB Attenuator	SN: 5058 (20k)	05-Apr-16 (No. 217-02292)	Apr-17
Type-N mismatch combination	SN: 5047.2 / 06327	05-Apr-16 (No. 217-02295)	Apr-17
Probe ER3DV6	SN: 2336	30-Dec-16 (No. ER3-2336_Dec16)	Dec-17
Probe H3DV6	SN: 6065	30-Dec-16 (No. H3-6065_Dec16)	Dec-17
DAE4	SN: 781	02-Sep-16 (No. DAE4-781_Sep16)	Sep-17
Secondary Standards	ID #	Check Date (in house)	Scheduled Check
Power meter Agilent 4419B	SN: GB42420191	09-Oct-09 (in house check Sep-14)	In house check: Oct-17
Power sensor HP E4412A	SN: US38485102	05-Jan-10 (in house check Sep-14)	In house check: Oct-17
Power sensor HP 8482A	SN: US37295597	09-Oct-09 (in house check Sep-14)	In house check: Oct-17
RF generator R&S SMT-06	SN: 832283/011	27-Aug-12 (in house check Oct-15)	In house check: Oct-17
Network Analyzer HP 8753E	SN: US37390585	18-Oct-01 (in house check Oct-16)	In house check: Oct-17

Calibrated by:	Name: <b>Johannes Kurikka</b>	Function: <b>Laboratory Technician</b>	Signature:
Approved by:	Name: <b>Katja Pokovic</b>	Function: <b>Technical Manager</b>	Signature:

Issued: March 20, 2017

This calibration certificate shall not be reproduced except in full without written approval of the laboratory.



Accredited by the Swiss Accreditation Service (SAS)  
**The Swiss Accreditation Service is one of the signatories to the EA  
Multilateral Agreement for the recognition of calibration certificates**

**Accreditation No.: SCS 0108**

## References

- [1] ANSI-C63.19-2007  
American National Standard for Methods of Measurement of Compatibility between Wireless Communications Devices and Hearing Aids.
- [2] ANSI-C63.19-2011  
American National Standard, Methods of Measurement of Compatibility between Wireless Communications Devices and Hearing Aids.

## Methods Applied and Interpretation of Parameters:

- **Coordinate System:** y-axis is in the direction of the dipole arms. z-axis is from the basis of the antenna (mounted on the table) towards its feed point between the two dipole arms. x-axis is normal to the other axes. In coincidence with the standards [1], the measurement planes (probe sensor center) are selected to be at a distance of 10 mm (15 mm for [2]) above the top metal edge of the dipole arms.
- **Measurement Conditions:** Further details are available from the hardcopies at the end of the certificate. All figures stated in the certificate are valid at the frequency indicated. The forward power to the dipole connector is set with a calibrated power meter connected and monitored with an auxiliary power meter connected to a directional coupler. While the dipole under test is connected, the forward power is adjusted to the same level.
- **Antenna Positioning:** The dipole is mounted on a HAC Test Arch phantom using the matching dipole positioner with the arms horizontal and the feeding cable coming from the floor. The measurements are performed in a shielded room with absorbers around the setup to reduce the reflections. It is verified before the mounting of the dipole under the Test Arch phantom, that its arms are perfectly in a line. It is installed on the HAC dipole positioner with its arms parallel below the dielectric reference wire and able to move elastically in vertical direction without changing its relative position to the top center of the Test Arch phantom. The vertical distance to the probe is adjusted after dipole mounting with a DASY5 Surface Check job. Before the measurement, the distance between phantom surface and probe tip is verified. The proper measurement distance is selected by choosing the matching section of the HAC Test Arch phantom with the proper device reference point (upper surface of the dipole) and the matching grid reference point (tip of the probe) considering the probe sensor offset. The vertical distance to the probe is essential for the accuracy.
- **Feed Point Impedance and Return Loss:** These parameters are measured using a HP 8753E Vector Network Analyzer. The impedance is specified at the SMA connector of the dipole. The influence of reflections was eliminated by applying the averaging function while moving the dipole in the air, at least 70cm away from any obstacles.
- **E-field distribution:** E field is measured in the x-y-plane with an isotropic ER3D-field probe with 100 mW forward power to the antenna feed point. In accordance with [1] and [2], the scan area is 20mm wide, its length exceeds the dipole arm length (180 or 90mm). The sensor center is 10 mm (15 mm for [2]) (in z) above the metal top of the dipole arms. Two 3D maxima are available near the end of the dipole arms. Assuming the dipole arms are perfectly in one line, the average of these two maxima (in subgrid 2 and subgrid 8) is determined to compensate for any non-parallelity to the measurement plane as well as the sensor displacement. The E-field value stated as calibration value represents the maximum of the interpolated 3D-E-field, in the plane above the dipole surface.
- **H-field distribution:** H-field is measured with an isotropic H-field probe with 100mW forward power to the antenna feed point, in the x-y-plane. The scan area and sensor distance is equivalent to the E-field scan. The maximum of the field is available at the center (subgrid 5) above the feed point. The H-field value stated as calibration value represents the maximum of the interpolated H-field, 10mm above the dipole surface at the feed point.

The reported uncertainty of measurement is stated as the standard uncertainty of measurement multiplied by the coverage factor  $k=2$ , which for a normal distribution corresponds to a coverage probability of approximately 95%.

## Measurement Conditions

DASY system configuration, as far as not given on page 1.

<b>DASY Version</b>	DASY5	V52.8.8
<b>Phantom</b>	HAC Test Arch	
<b>Distance Dipole Top - Probe Center</b>	10, 15 mm	
<b>Scan resolution</b>	dx, dy = 5 mm	
<b>Frequency</b>	835 MHz $\pm$ 1 MHz	
<b>Input power drift</b>	< 0.05 dB	

## Maximum Field values at 835 MHz

<b>H-field 10 mm above dipole surface</b>	condition	<b>interpolated maximum</b>
Maximum measured	100 mW input power	<b>0.464 A/m <math>\pm</math> 8.2 % (k=2)</b>

<b>E-field 10 mm above dipole surface</b>	condition	<b>Interpolated maximum</b>
Maximum measured above high end	100 mW input power	171.6 V/m = 44.69 dBV/m
Maximum measured above low end	100 mW input power	162.9 V/m = 44.24 dBV/m
Averaged maximum above arm	100 mW input power	<b>167.3 V/m <math>\pm</math> 12.8 % (k=2)</b>

<b>E-field 15 mm above dipole surface</b>	condition	<b>Interpolated maximum</b>
Maximum measured above high end	100 mW input power	108.9 V/m = 40.74 dBV/m
Maximum measured above low end	100 mW input power	106.2 V/m = 40.52 dBV/m
Averaged maximum above arm	100 mW input power	<b>107.6 V/m <math>\pm</math> 12.8 % (k=2)</b>



## Appendix (Additional assessments outside the scope of SCS 0108)

### Antenna Parameters

Frequency	Return Loss	Impedance
800 MHz	16.5 dB	41.0 $\Omega$ - 10.2 j $\Omega$
835 MHz	30.9 dB	50.4 $\Omega$ + 2.8 j $\Omega$
900 MHz	17.2 dB	51.7 $\Omega$ - 14.0 j $\Omega$
950 MHz	19.4 dB	51.5 $\Omega$ + 10.8 j $\Omega$
960 MHz	14.0 dB	64.9 $\Omega$ + 17.8 j $\Omega$

### 3.2 Antenna Design and Handling

The calibration dipole has a symmetric geometry with a built-in two stub matching network, which leads to the enhanced bandwidth.

The dipole is built of standard semirigid coaxial cable. The internal matching line is open ended. The antenna is therefore open for DC signals.

Do not apply force to dipole arms, as they are liable to bend. The soldered connections near the feedpoint may be damaged. After excessive mechanical stress or overheating, check the impedance characteristics to ensure that the internal matching network is not affected.

After long term use with 40W radiated power, only a slight warming of the dipole near the feedpoint can be measured.

# Impedance Measurement Plot

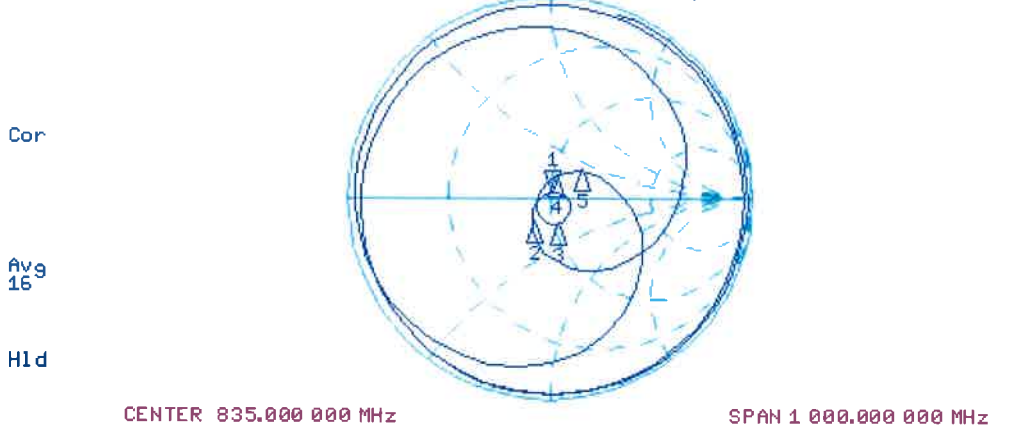
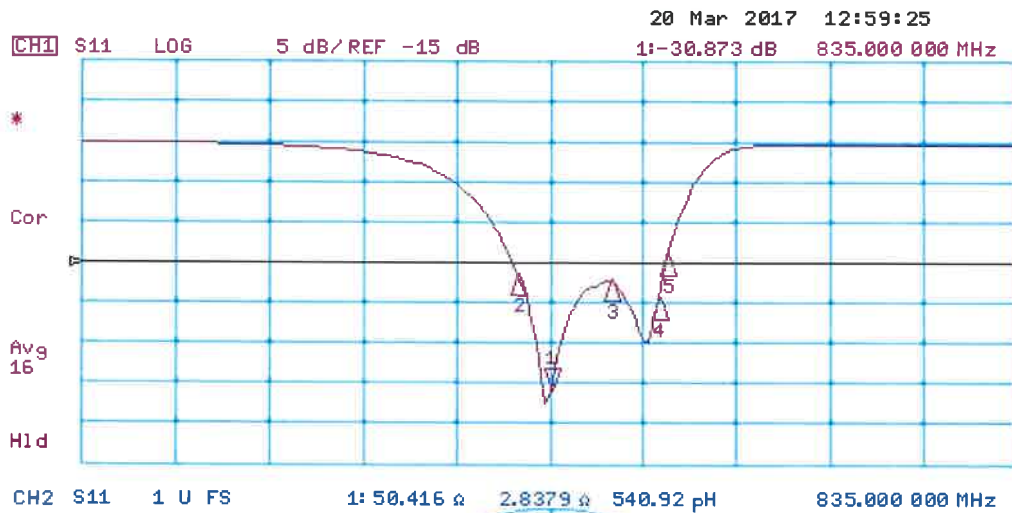

## DASY5 H-field Result

Date: 20.03.2017

Test Laboratory: SPEAG Lab 2

**DUT: HAC-Dipole 835 MHz; Type: CD835V3; Serial: CD835V3 - SN: 1041**

Communication System: UID 0 - CW ; Frequency: 835 MHz

Medium parameters used:  $\sigma = 0$  S/m,  $\epsilon_r = 1$ ;  $\rho = 1$  kg/m<sup>3</sup>

Phantom section: RF Section

Measurement Standard: DASY5 (IEEE/IEC/ANSI C63.19-2011)

DASY52 Configuration:

- Probe: H3DV6 - SN6065; ; Calibrated: 30.12.2016
- Sensor-Surface: (Fix Surface)
- Electronics: DAE4 Sn781; Calibrated: 02.09.2016
- Phantom: HAC Test Arch with AMCC; Type: SD HAC P01 BA; Serial: 1070
- DASY52 52.8.8(1222); SEMCAD X 14.6.10(7331)

**Dipole H-Field measurement @ 835MHz/H-Scan - 835MHz d=10mm/Hearing Aid Compatibility Test (41x361x1):**

Interpolated grid: dx=0.5000 mm, dy=0.5000 mm

Device Reference Point: 0, 0, -6.3 mm

Reference Value = 0.4830 A/m; Power Drift = 0.01 dB

PMR not calibrated. PMF = 1.000 is applied.

H-field emissions = 0.4635 A/m

**Near-field category: M4 (AWF 0 dB)**

PMF scaled H-field

Grid 1 M4 0.358 A/m	Grid 2 M4 0.410 A/m	Grid 3 M4 0.405 A/m
Grid 4 M4 0.406 A/m	Grid 5 M4 0.464 A/m	Grid 6 M4 0.460 A/m
Grid 7 M4 0.361 A/m	Grid 8 M4 0.408 A/m	Grid 9 M4 0.406 A/m

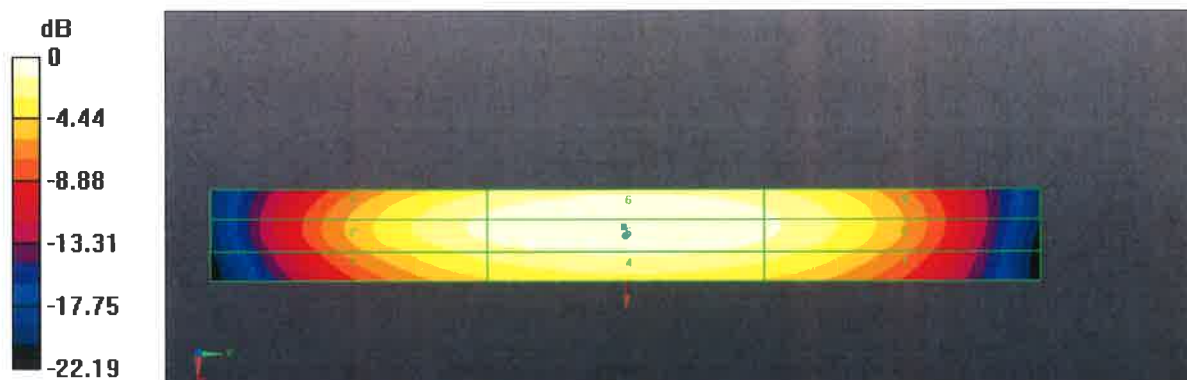

0 dB = 0.4635 A/m = -6.68 dBA/m

## DASY5 E-field Result

Date: 17.03.2017

Test Laboratory: SPEAG Lab 2

**DUT: HAC-Dipole 835 MHz; Type: CD835V3; Serial: CD835V3 - SN: 1041**

Communication System: UID 0 - CW ; Frequency: 835 MHz

Medium parameters used:  $\sigma = 0$  S/m,  $\epsilon_r = 1$ ;  $\rho = 1000$  kg/m<sup>3</sup>

Phantom section: RF Section

Measurement Standard: DASY5 (IEEE/IEC/ANSI C63.19-2011)

DASY52 Configuration:

- Probe: ER3DV6 - SN2336; ConvF(1, 1, 1); Calibrated: 30.12.2016;
- Sensor-Surface: (Fix Surface)
- Electronics: DAE4 Sn781; Calibrated: 02.09.2016
- Phantom: HAC Test Arch with AMCC; Type: SD HAC P01 BA; Serial: 1070
- DASY52 52.8.8(1222); SEMCAD X 14.6.10(7331)

**Dipole E-Field measurement @ 835MHz/E-Scan - 835MHz d=10mm/Hearing Aid Compatibility Test (41x361x1):**

Interpolated grid: dx=0.5000 mm, dy=0.5000 mm

Device Reference Point: 0, 0, -6.3 mm

Reference Value = 108.7 V/m; Power Drift = -0.04 dB

Applied MIF = 0.00 dB

RF audio interference level = 44.69 dBV/m

**Emission category: M3**

MIF scaled E-field

Grid 1 M3 43.88 dBV/m	Grid 2 M3 44.24 dBV/m	Grid 3 M3 44.09 dBV/m
Grid 4 M4 38.56 dBV/m	Grid 5 M4 38.94 dBV/m	Grid 6 M4 38.81 dBV/m
Grid 7 M3 43.89 dBV/m	Grid 8 M3 44.69 dBV/m	Grid 9 M3 44.68 dBV/m

**Dipole E-Field measurement @ 835MHz/E-Scan - 835MHz d=15mm/Hearing Aid Compatibility Test (41x361x1):**

Interpolated grid: dx=0.5000 mm, dy=0.5000 mm

Device Reference Point: 0, 0, -6.3 mm

Reference Value = 108.7 V/m; Power Drift = -0.03 dB

Applied MIF = 0.00 dB

RF audio interference level = 40.74 dBV/m

**Emission category: M3**

MIF scaled E-field

Grid 1 M3 40.31 dBV/m	Grid 2 M3 40.52 dBV/m	Grid 3 M3 40.45 dBV/m
Grid 4 M4 35.84 dBV/m	Grid 5 M4 36 dBV/m	Grid 6 M4 35.92 dBV/m
Grid 7 M3 40.41 dBV/m	Grid 8 M3 40.74 dBV/m	Grid 9 M3 40.71 dBV/m

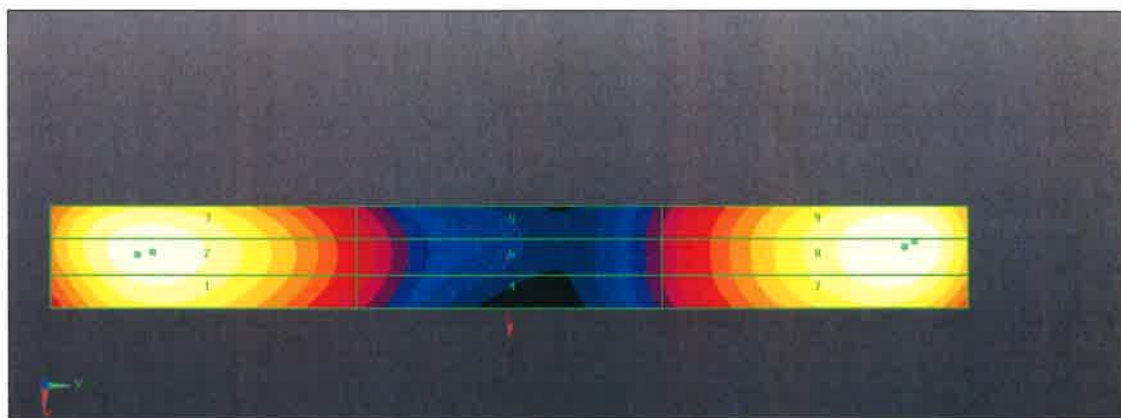
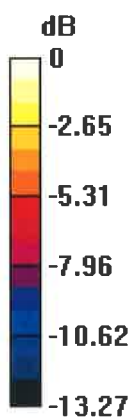

0 dB = 171.6 V/m = 44.69 dBV/m



BUREAU  
VERITAS

# Annual Confirmation of HAC Reference Dipole

Model : CD835V3

S/N : 1041

Measurement Date : 2018/3/19

Frequency (MHz)	Type	Item	Previous Measurement	Annual Check	Deviation	Accepted Tolerance	Result
835	Free Space	Return Loss	-30.873	-30.956	0.27%	±20%	PASS
		Real Impedance	50.416	50.452	0.04	±5Ω	PASS
		Imaginary Impedance	2.8379	3.1855	0.35	±5Ω	PASS

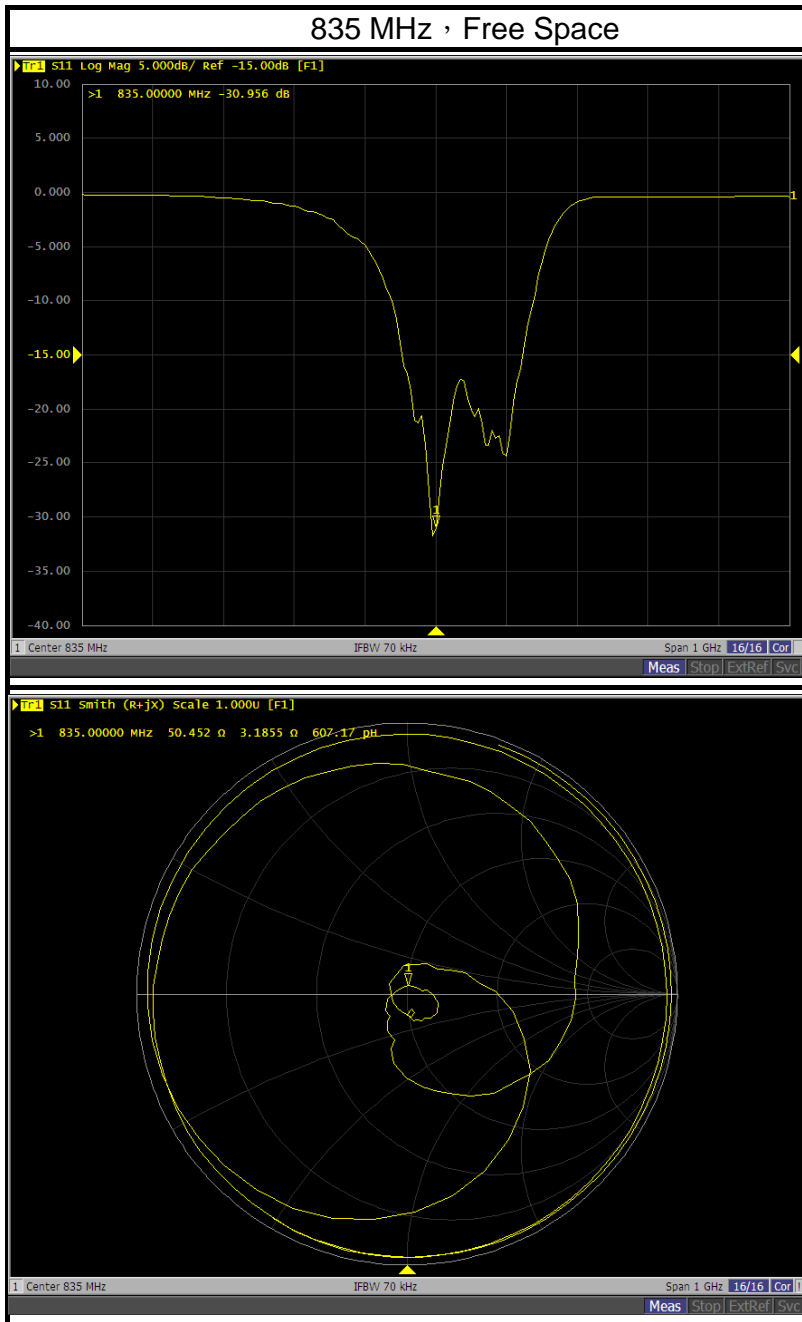



Accredited by the Swiss Accreditation Service (SAS)  
The Swiss Accreditation Service is one of the signatories to the EA  
Multilateral Agreement for the recognition of calibration certificates

Accreditation No.: **SCS 0108**

Client **B.V. ADT (Auden)**

Certificate No: **CD1880V3-1032\_Apr17**

## CALIBRATION CERTIFICATE

Object **CD1880V3 - SN: 1032**

Calibration procedure(s) **QA CAL-20.v6  
Calibration procedure for dipoles in air**

Calibration date: **April 25, 2017**

This calibration certificate documents the traceability to national standards, which realize the physical units of measurements (SI).  
The measurements and the uncertainties with confidence probability are given on the following pages and are part of the certificate.

All calibrations have been conducted in the closed laboratory facility: environment temperature (22 ± 3)°C and humidity < 70%.

Calibration Equipment used (M&TE critical for calibration)

Primary Standards	ID #	Cal Date (Certificate No.)	Scheduled Calibration
Power meter NRP	SN: 104778	04-Apr-17 (No. 217-02521/02522)	Apr-18
Power sensor NRP-Z91	SN: 103244	04-Apr-17 (No. 217-02521)	Apr-18
Power sensor NRP-Z91	SN: 103245	04-Apr-17 (No. 217-02522)	Apr-18
Reference 20 dB Attenuator	SN: 5058 (20k)	07-Apr-17 (No. 217-02528)	Apr-18
Type-N mismatch combination	SN: 5047.2 / 06327	07-Apr-17 (No. 217-02529)	Apr-18
Probe ER3DV6	SN: 2336	30-Dec-16 (No. ER3-2336_Dec16)	Dec-17
Probe H3DV6	SN: 6065	30-Dec-16 (No. H3-6065_Dec16)	Dec-17
DAE4	SN: 781	02-Sep-16 (No. DAE4-781_Sep16)	Sep-17
Secondary Standards	ID #	Check Date (in house)	Scheduled Check
Power meter Agilent 4419B	SN: GB42420191	09-Oct-09 (in house check Sep-14)	In house check: Oct-17
Power sensor HP E4412A	SN: US38485102	05-Jan-10 (in house check Sep-14)	In house check: Oct-17
Power sensor HP 8482A	SN: US37295597	09-Oct-09 (in house check Sep-14)	In house check: Oct-17
RF generator R&S SMT-06	SN: 832283/011	27-Aug-12 (in house check Oct-15)	In house check: Oct-17
Network Analyzer HP 8753E	SN: US37390585	18-Oct-01 (in house check Oct-16)	In house check: Oct-17

Calibrated by:	Name <b>Johannes Kurikka</b>	Function <b>Laboratory Technician</b>	Signature 
Approved by:	Name <b>Katja Pokovic</b>	Technical Manager	

Issued: April 26, 2017

This calibration certificate shall not be reproduced except in full without written approval of the laboratory.



Accredited by the Swiss Accreditation Service (SAS)

The Swiss Accreditation Service is one of the signatories to the EA  
Multilateral Agreement for the recognition of calibration certificates

Accreditation No.: **SCS 0108**

## References

- [1] ANSI-C63.19-2007  
American National Standard for Methods of Measurement of Compatibility between Wireless Communications Devices and Hearing Aids.
- [2] ANSI-C63.19-2011  
American National Standard, Methods of Measurement of Compatibility between Wireless Communications Devices and Hearing Aids.

## Methods Applied and Interpretation of Parameters:

- *Coordinate System:* y-axis is in the direction of the dipole arms. z-axis is from the basis of the antenna (mounted on the table) towards its feed point between the two dipole arms. x-axis is normal to the other axes. In coincidence with the standards [1], the measurement planes (probe sensor center) are selected to be at a distance of 10 mm (15 mm for [2]) above the top metal edge of the dipole arms.
- *Measurement Conditions:* Further details are available from the hardcopies at the end of the certificate. All figures stated in the certificate are valid at the frequency indicated. The forward power to the dipole connector is set with a calibrated power meter connected and monitored with an auxiliary power meter connected to a directional coupler. While the dipole under test is connected, the forward power is adjusted to the same level.
- *Antenna Positioning:* The dipole is mounted on a HAC Test Arch phantom using the matching dipole positioner with the arms horizontal and the feeding cable coming from the floor. The measurements are performed in a shielded room with absorbers around the setup to reduce the reflections. It is verified before the mounting of the dipole under the Test Arch phantom, that its arms are perfectly in a line. It is installed on the HAC dipole positioner with its arms parallel below the dielectric reference wire and able to move elastically in vertical direction without changing its relative position to the top center of the Test Arch phantom. The vertical distance to the probe is adjusted after dipole mounting with a DASY5 Surface Check job. Before the measurement, the distance between phantom surface and probe tip is verified. The proper measurement distance is selected by choosing the matching section of the HAC Test Arch phantom with the proper device reference point (upper surface of the dipole) and the matching grid reference point (tip of the probe) considering the probe sensor offset. The vertical distance to the probe is essential for the accuracy.
- *Feed Point Impedance and Return Loss:* These parameters are measured using a HP 8753E Vector Network Analyzer. The impedance is specified at the SMA connector of the dipole. The influence of reflections was eliminated by applying the averaging function while moving the dipole in the air, at least 70cm away from any obstacles.
- *E-field distribution:* E field is measured in the x-y-plane with an isotropic ER3D-field probe with 100 mW forward power to the antenna feed point. In accordance with [1] and [2], the scan area is 20mm wide, its length exceeds the dipole arm length (180 or 90mm). The sensor center is 10 mm (15 mm for [2]) (in z) above the metal top of the dipole arms. Two 3D maxima are available near the end of the dipole arms. Assuming the dipole arms are perfectly in one line, the average of these two maxima (in subgrid 2 and subgrid 8) is determined to compensate for any non-parallelity to the measurement plane as well as the sensor displacement. The E-field value stated as calibration value represents the maximum of the interpolated 3D-E-field, in the plane above the dipole surface.
- *H-field distribution:* H-field is measured with an isotropic H-field probe with 100mW forward power to the antenna feed point, in the x-y-plane. The scan area and sensor distance is equivalent to the E-field scan. The maximum of the field is available at the center (subgrid 5) above the feed point. The H-field value stated as calibration value represents the maximum of the interpolated H-field, 10mm above the dipole surface at the feed point.

The reported uncertainty of measurement is stated as the standard uncertainty of measurement multiplied by the coverage factor  $k=2$ , which for a normal distribution corresponds to a coverage probability of approximately 95%.



## Measurement Conditions

DASY system configuration, as far as not given on page 1.

<b>DASY Version</b>	DASY5	V52.10.0
<b>Phantom</b>	HAC Test Arch	
<b>Distance Dipole Top - Probe Center</b>	10, 15 mm	
<b>Scan resolution</b>	dx, dy = 5 mm	
<b>Frequency</b>	1880 MHz $\pm$ 1 MHz	
<b>Input power drift</b>	< 0.05 dB	

## Maximum Field values at 1880 MHz

<b>H-field 10 mm above dipole surface</b>	condition	<b>interpolated maximum</b>
Maximum measured	100 mW input power	<b>0.464 A/m <math>\pm</math> 8.2 % (k=2)</b>

<b>E-field 10 mm above dipole surface</b>	condition	<b>Interpolated maximum</b>
Maximum measured above high end	100 mW input power	141.2 V/m = 43.00 dBV/m
Maximum measured above low end	100 mW input power	140.9 V/m = 42.98 dBV/m
Averaged maximum above arm	100 mW input power	<b>141.1 V/m <math>\pm</math> 12.8 % (k=2)</b>

<b>E-field 15 mm above dipole surface</b>	condition	<b>Interpolated maximum</b>
Maximum measured above high end	100 mW input power	92.5 V/m = 39.32 dBV/m
Maximum measured above low end	100 mW input power	89.5 V/m = 39.04 dBV/m
Averaged maximum above arm	100 mW input power	<b>91.0 V/m <math>\pm</math> 12.8 % (k=2)</b>

## Appendix (Additional assessments outside the scope of SCS 0108)

### Antenna Parameters

Frequency	Return Loss	Impedance
1730 MHz	24.9 dB	$54.8 \Omega + 3.5 j\Omega$
1880 MHz	20.5 dB	$58.8 \Omega + 5.3 j\Omega$
1900 MHz	21.4 dB	$59.1 \Omega + 1.8 j\Omega$
1950 MHz	26.6 dB	$53.4 \Omega - 3.5 j\Omega$
2000 MHz	22.4 dB	$47.0 \Omega + 6.7 j\Omega$

### 3.2 Antenna Design and Handling

The calibration dipole has a symmetric geometry with a built-in two stub matching network, which leads to the enhanced bandwidth.

The dipole is built of standard semirigid coaxial cable. The internal matching line is open ended. The antenna is therefore open for DC signals.

Do not apply force to dipole arms, as they are liable to bend. The soldered connections near the feedpoint may be damaged. After excessive mechanical stress or overheating, check the impedance characteristics to ensure that the internal matching network is not affected.

After long term use with 40W radiated power, only a slight warming of the dipole near the feedpoint can be measured.

# Impedance Measurement Plot

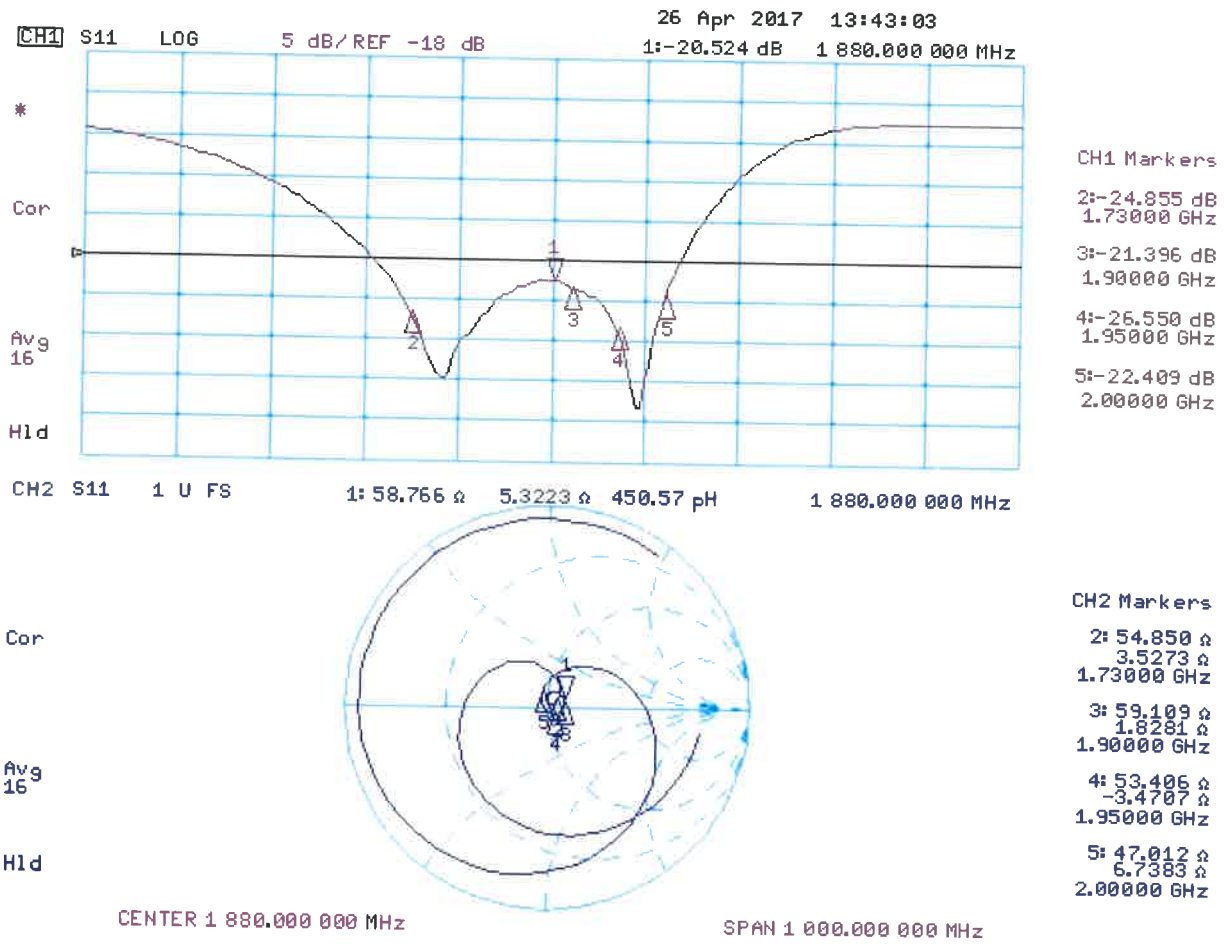

## DASY5 H-field Result

Date: 25.04.2017

Test Laboratory: SPEAG Lab2

**DUT: HAC Dipole 1880 MHz; Type: CD1880V3; Serial: CD1880V3 - SN: 1032**

Communication System: UID 0 - CW ; Frequency: 1880 MHz

Medium parameters used:  $\sigma = 0$  S/m,  $\epsilon_r = 1$ ;  $\rho = 1000$  kg/m<sup>3</sup>

Phantom section: RF Section

Measurement Standard: DASY5 (IEEE/IEC/ANSI C63.19-2011)

DASY52 Configuration:

- Probe: H3DV6 - SN6065; ; Calibrated: 30.12.2016
- Sensor-Surface: (Fix Surface)
- Electronics: DAE4 Sn781; Calibrated: 02.09.2016
- Phantom: HAC Test Arch with AMCC; Type: SD HAC P01 BA; Serial: 1070
- DASY52 52.10.0(1440); SEMCAD X 14.6.10(7413)

**Dipole H-Field measurement @ 1880MHz/H-Scan - 1880MHz d=10mm/Hearing Aid Compatibility Test (41x181x1):**

Interpolated grid: dx=0.5000 mm, dy=0.5000 mm

Device Reference Point: 0, 0, -6.3 mm

Reference Value = 0.4870 A/m; Power Drift = -0.00 dB

PMR not calibrated. PMF = 1.000 is applied.

H-field emissions = 0.4640 A/m

**Near-field category: M2 (AWF 0 dB)**

PMF scaled H-field

Grid 1 M2 0.390 A/m	Grid 2 M2 0.432 A/m	Grid 3 M2 0.422 A/m
Grid 4 M2 0.422 A/m	Grid 5 M2 0.464 A/m	Grid 6 M2 0.456 A/m
Grid 7 M2 0.384 A/m	Grid 8 M2 0.420 A/m	Grid 9 M2 0.413 A/m

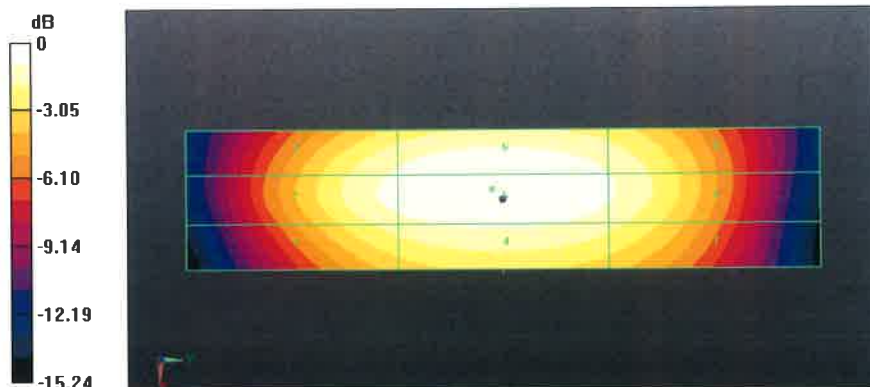

0 dB = 0.4640 A/m = -6.67 dBA/m

## DASY5 E-field Result

Date: 25.04.2017

Test Laboratory: SPEAG Lab2

**DUT: HAC Dipole 1880 MHz; Type: CD1880V3; Serial: CD1880V3 - SN: 1032**

Communication System: UID 0 - CW ; Frequency: 1880 MHz

Medium parameters used:  $\sigma = 0$  S/m,  $\epsilon_r = 1$ ;  $\rho = 1000$  kg/m<sup>3</sup>

Phantom section: RF Section

Measurement Standard: DASY5 (IEEE/IEC/ANSI C63.19-2011)

DASY52 Configuration:

- Probe: ER3DV6 - SN2336; ConvF(1, 1, 1); Calibrated: 30.12.2016;
- Sensor-Surface: (Fix Surface)
- Electronics: DAE4 Sn781; Calibrated: 02.09.2016
- Phantom: HAC Test Arch with AMCC; Type: SD HAC P01 BA; Serial: 1070
- DASY52 52.10.0(1440); SEMCAD X 14.6.10(7413)

**Dipole E-Field measurement @ 1880MHz/E-Scan - 1880MHz d=10mm/Hearing Aid Compatibility Test (41x181x1):**

Interpolated grid: dx=0.5000 mm, dy=0.5000 mm

Device Reference Point: 0, 0, -6.3 mm

Reference Value = 158.3 V/m; Power Drift = 0.02 dB

Applied MIF = 0.00 dB

RF audio interference level = 43.00 dBV/m

**Emission category: M1**

MIF scaled E-field

Grid 1 M1 42.53 dBV/m	Grid 2 M1 42.98 dBV/m	Grid 3 M1 42.86 dBV/m
Grid 4 M2 39.04 dBV/m	Grid 5 M2 39.41 dBV/m	Grid 6 M2 39.16 dBV/m
Grid 7 M1 42.42 dBV/m	Grid 8 M1 43 dBV/m	Grid 9 M1 42.92 dBV/m

**Dipole E-Field measurement @ 1880MHz/E-Scan - 1880MHz d=15mm/Hearing Aid Compatibility Test (41x181x1):**

Interpolated grid: dx=0.5000 mm, dy=0.5000 mm

Device Reference Point: 0, 0, -6.3 mm

Reference Value = 158.6 V/m; Power Drift = -0.02 dB

Applied MIF = 0.00 dB

RF audio interference level = 39.32 dBV/m

**Emission category: M2**

MIF scaled E-field

Grid 1 M2 39.06 dBV/m	Grid 2 M2 39.32 dBV/m	Grid 3 M2 39.25 dBV/m
Grid 4 M2 36.95 dBV/m	Grid 5 M2 37.13 dBV/m	Grid 6 M2 37.05 dBV/m
Grid 7 M2 38.76 dBV/m	Grid 8 M2 39.04 dBV/m	Grid 9 M2 38.99 dBV/m

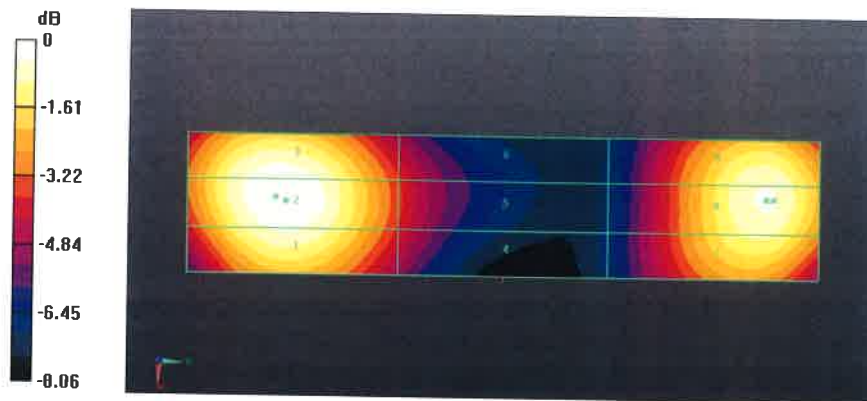

0 dB = 141.2 V/m = 43.00 dBV/m



BUREAU  
VERITAS

# Annual Confirmation of HAC Reference Dipole

Model : CD1880V3

S/N : 1032

Measurement Date : 2018/4/24

Frequency (MHz)	Type	Item	Previous Measurement	Annual Check	Deviation	Accepted Tolerance	Result
1880	Free Space	Return Loss	-20.524	-19.650	-4.26%	±20%	PASS
		Real Impedance	58.766	59.639	0.87	±5Ω	PASS
		Imaginary Impedance	5.3223	7.0685	1.75	±5Ω	PASS

1880 MHz · Free Space

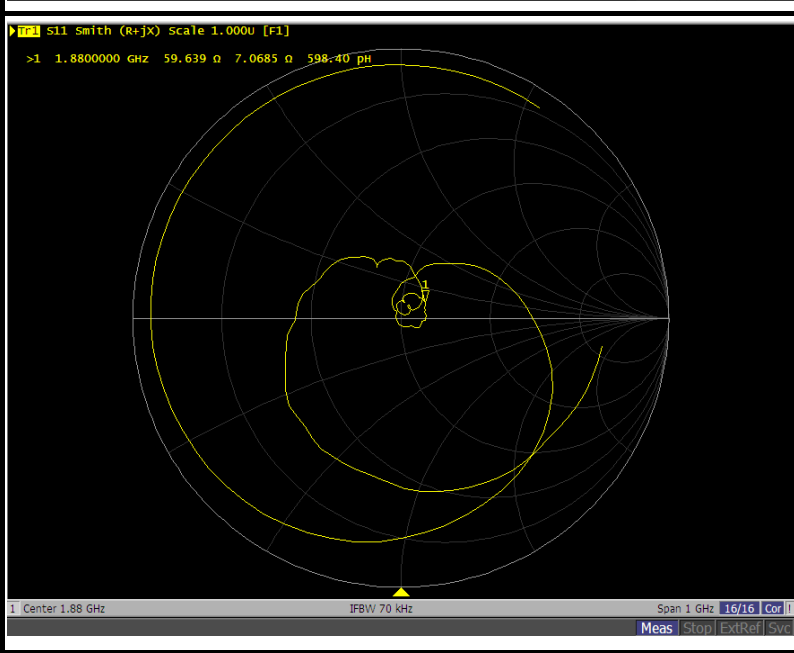



Accredited by the Swiss Accreditation Service (SAS)  
The Swiss Accreditation Service is one of the signatories to the EA  
Multilateral Agreement for the recognition of calibration certificates

Accreditation No.: **SCS 0108**

Client **B.V.ADT (Auden)**

Certificate No: **CD2600V3-1005\_Mar18**

## CALIBRATION CERTIFICATE

Object **CD2600V3 - SN: 1005**

Calibration procedure(s) **QA CAL-20.v6  
Calibration procedure for dipoles in air**

Calibration date: **March 14, 2018**

This calibration certificate documents the traceability to national standards, which realize the physical units of measurements (SI).  
The measurements and the uncertainties with confidence probability are given on the following pages and are part of the certificate.

All calibrations have been conducted in the closed laboratory facility: environment temperature ( $22 \pm 3$ )°C and humidity < 70%.

Calibration Equipment used (M&TE critical for calibration)

Primary Standards	ID #	Cal Date (Certificate No.)	Scheduled Calibration
Power meter NRP	SN: 104778	04-Apr-17 (No. 217-02521/02522)	Apr-18
Power sensor NRP-Z91	SN: 103244	04-Apr-17 (No. 217-02521)	Apr-18
Power sensor NRP-Z91	SN: 103245	04-Apr-17 (No. 217-02522)	Apr-18
Reference 20 dB Attenuator	SN: 5058 (20k)	07-Apr-17 (No. 217-02528)	Apr-18
Type-N mismatch combination	SN: 5047.2 / 06327	07-Apr-17 (No. 217-02529)	Apr-18
Probe EF3DV3	SN: 4013	05-Mar-18 (No. EF3-4013_Mar18)	Mar-19
DAE4	SN: 781	17-Jan-18 (No. DAE4-781_Jan18)	Jan-19

Secondary Standards	ID #	Check Date (in house)	Scheduled Check
Power meter Agilent 4419B	SN: GB42420191	09-Oct-09 (in house check Oct-17)	In house check: Oct-20
Power sensor HP E4412A	SN: US38485102	05-Jan-10 (in house check Oct-17)	In house check: Oct-20
Power sensor HP 8482A	SN: US37295597	09-Oct-09 (in house check Oct-17)	In house check: Oct-20
RF generator R&S SMT-06	SN: 832283/011	27-Aug-12 (in house check Oct-17)	In house check: Oct-20
Network Analyzer HP 8753E	SN: US37390585	18-Oct-01 (in house check Oct-17)	In house check: Oct-18

	Name	Function	Signature
Calibrated by:	Leif Klysner	Laboratory Technician	
Approved by:	Katja Pokovic	Technical Manager	

Issued: March 15, 2018

This calibration certificate shall not be reproduced except in full without written approval of the laboratory.





Accredited by the Swiss Accreditation Service (SAS)

The Swiss Accreditation Service is one of the signatories to the EA  
Multilateral Agreement for the recognition of calibration certificates

Accreditation No.: **SCS 0108**

## References

- [1] ANSI-C63.19-2011  
American National Standard, Methods of Measurement of Compatibility between Wireless Communications Devices and Hearing Aids.

## Methods Applied and Interpretation of Parameters:

- *Coordinate System:* y-axis is in the direction of the dipole arms. z-axis is from the basis of the antenna (mounted on the table) towards its feed point between the two dipole arms. x-axis is normal to the other axes. In coincidence with the standards [1], the measurement planes (probe sensor center) are selected to be at a distance of 15 mm above the top metal edge of the dipole arms.
- *Measurement Conditions:* Further details are available from the hardcopies at the end of the certificate. All figures stated in the certificate are valid at the frequency indicated. The forward power to the dipole connector is set with a calibrated power meter connected and monitored with an auxiliary power meter connected to a directional coupler. While the dipole under test is connected, the forward power is adjusted to the same level.
- *Antenna Positioning:* The dipole is mounted on a HAC Test Arch phantom using the matching dipole positioner with the arms horizontal and the feeding cable coming from the floor. The measurements are performed in a shielded room with absorbers around the setup to reduce the reflections. It is verified before the mounting of the dipole under the Test Arch phantom, that its arms are perfectly in a line. It is installed on the HAC dipole positioner with its arms parallel below the dielectric reference wire and able to move elastically in vertical direction without changing its relative position to the top center of the Test Arch phantom. The vertical distance to the probe is adjusted after dipole mounting with a DASY5 Surface Check job. Before the measurement, the distance between phantom surface and probe tip is verified. The proper measurement distance is selected by choosing the matching section of the HAC Test Arch phantom with the proper device reference point (upper surface of the dipole) and the matching grid reference point (tip of the probe) considering the probe sensor offset. The vertical distance to the probe is essential for the accuracy.
- *Feed Point Impedance and Return Loss:* These parameters are measured using a HP 8753E Vector Network Analyzer. The impedance is specified at the SMA connector of the dipole. The influence of reflections was eliminated by applying the averaging function while moving the dipole in the air, at least 70cm away from any obstacles.
- *E-field distribution:* E field is measured in the x-y-plane with an isotropic ER3D-field probe with 100 mW forward power to the antenna feed point. In accordance with [1], the scan area is 20mm wide, its length exceeds the dipole arm length (180 or 90mm). The sensor center is 15 mm (in z) above the metal top of the dipole arms. Two 3D maxima are available near the end of the dipole arms. Assuming the dipole arms are perfectly in one line, the average of these two maxima (in subgrid 2 and subgrid 8) is determined to compensate for any non-parallelity to the measurement plane as well as the sensor displacement. The E-field value stated as calibration value represents the maximum of the interpolated 3D-E-field, in the plane above the dipole surface.

The reported uncertainty of measurement is stated as the standard uncertainty of measurement multiplied by the coverage factor  $k=2$ , which for a normal distribution corresponds to a coverage probability of approximately 95%.

## Measurement Conditions

DASY system configuration, as far as not given on page 1.

<b>DASY Version</b>	DASY5	V52.10.0
<b>Phantom</b>	HAC Test Arch	
<b>Distance Dipole Top - Probe Center</b>	15 mm	
<b>Scan resolution</b>	dx, dy = 5 mm	
<b>Frequency</b>	2600 MHz $\pm$ 1 MHz	
<b>Input power drift</b>	< 0.05 dB	

## Maximum Field values at 2600 MHz

<b>E-field 15 mm above dipole surface</b>	<b>condition</b>	<b>Interpolated maximum</b>
Maximum measured above high end	100 mW input power	86.5 V/m = 38.74 dBV/m
Maximum measured above low end	100 mW input power	85.1 V/m = 38.60 dBV/m
Averaged maximum above arm	100 mW input power	<b>85.8 V/m <math>\pm</math> 12.8 % (k=2)</b>

## Appendix (Additional assessments outside the scope of SCS 0108)

### Antenna Parameters

<b>Frequency</b>	<b>Return Loss</b>	<b>Impedance</b>
2450 MHz	22.4 dB	44.6 $\Omega$ - 4.8 j $\Omega$
2550 MHz	28.7 dB	51.4 $\Omega$ + 3.5 j $\Omega$
2600 MHz	26.8 dB	54.8 $\Omega$ + 0.6 j $\Omega$
2650 MHz	24.9 dB	54.9 $\Omega$ - 3.5 j $\Omega$
2750 MHz	18.8 dB	47.9 $\Omega$ - 11.1 j $\Omega$

### 3.2 Antenna Design and Handling

The calibration dipole has a symmetric geometry with a built-in two stub matching network, which leads to the enhanced bandwidth.

The dipole is built of standard semirigid coaxial cable. The internal matching line is open ended. The antenna is therefore open for DC signals.

Do not apply force to dipole arms, as they are liable to bend. The soldered connections near the feedpoint may be damaged. After excessive mechanical stress or overheating, check the impedance characteristics to ensure that the internal matching network is not affected.

After long term use with 40W radiated power, only a slight warming of the dipole near the feedpoint can be measured.

# Impedance Measurement Plot

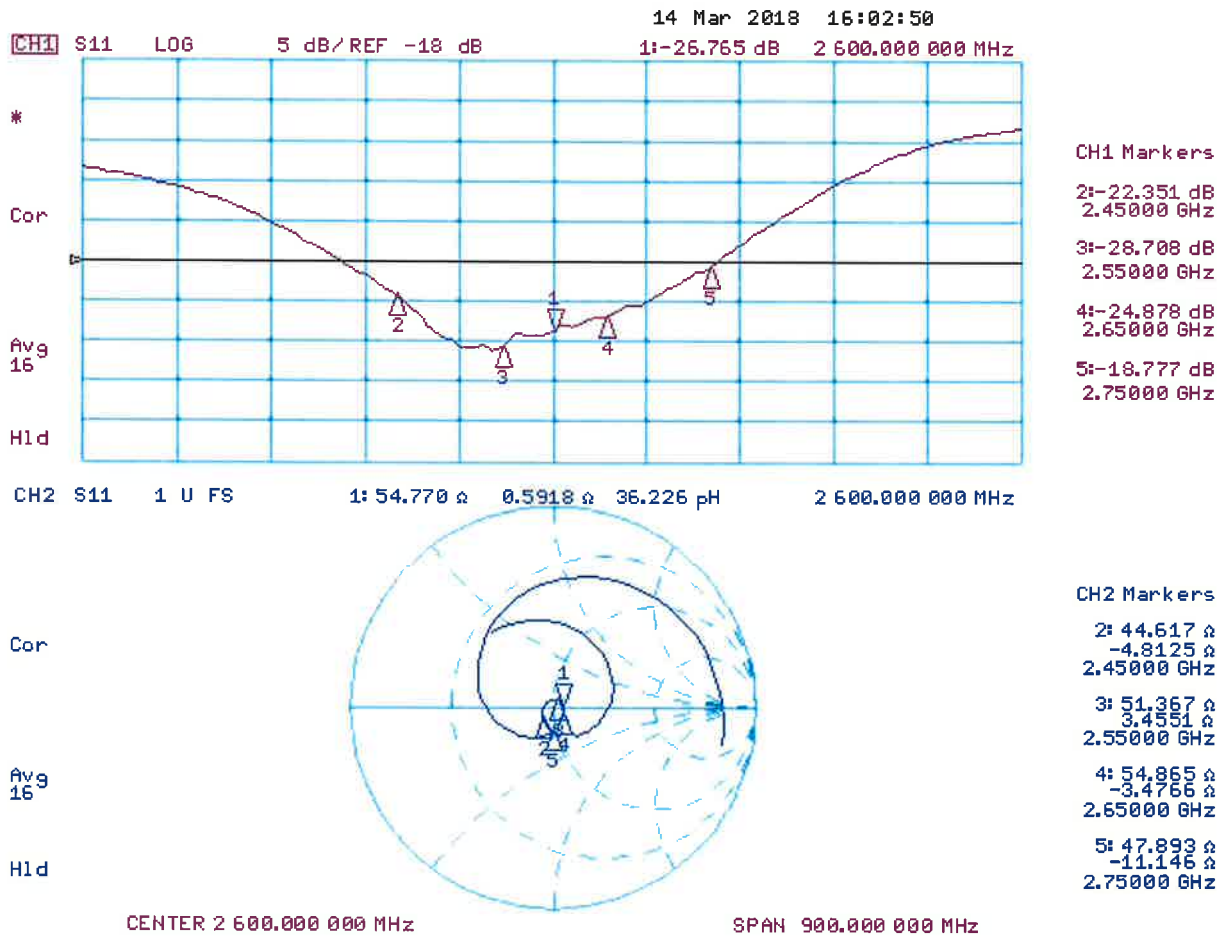

## DASY5 E-field Result

Date: 14.03.2018

Test Laboratory: SPEAG Lab2

**DUT: HAC Dipole 2600 MHz; Type: CD2600V3; Serial: CD2600V3 - SN: 1005**

Communication System: UID 0 - CW ; Frequency: 2600 MHz  
Medium parameters used:  $\sigma = 0$  S/m,  $\epsilon_r = 1$ ;  $\rho = 1000$  kg/m<sup>3</sup>  
Phantom section: RF Section  
Measurement Standard: DASY5 (IEEE/IEC/ANSI C63.19-2011)

DASY52 Configuration:

- Probe: EF3DV3 - SN4013; ConvF(1, 1, 1); Calibrated: 05.03.2018;
- Sensor-Surface: (Fix Surface)
- Electronics: DAE4 Sn781; Calibrated: 17.01.2018
- Phantom: HAC Test Arch with AMCC; Type: SD HAC P01 BA; Serial: 1070
- DASY52 52.10.0(1446); SEMCAD X 14.6.10(7417)

**Dipole E-Field measurement/E-Scan - 2600MHz d=15mm/Hearing Aid Compatibility Test (41x181x1): Interpolated grid:**

dx=0.5000 mm, dy=0.5000 mm

Device Reference Point: 0, 0, -6.3 mm

Reference Value = 63.21 V/m; Power Drift = -0.00 dB

Applied MIF = 0.00 dB

RF audio interference level = 38.74 dBV/m

**Emission category: M2**

MIF scaled E-field

Grid 1 M2 38.27 dBV/m	Grid 2 M2 38.6 dBV/m	Grid 3 M2 38.56 dBV/m
Grid 4 M2 37.94 dBV/m	Grid 5 M2 38.24 dBV/m	Grid 6 M2 38.22 dBV/m
Grid 7 M2 38.41 dBV/m	Grid 8 M2 38.74 dBV/m	Grid 9 M2 38.71 dBV/m

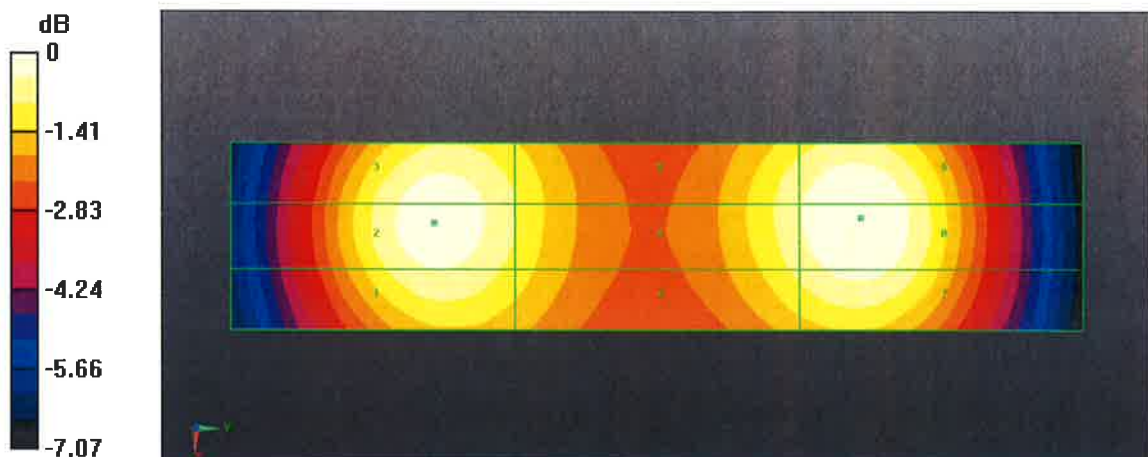



**Appendix D. Photographs of EUT and Setup**

# FCC HAC (RF Emission) Test Report

## <Photographs of EUT>

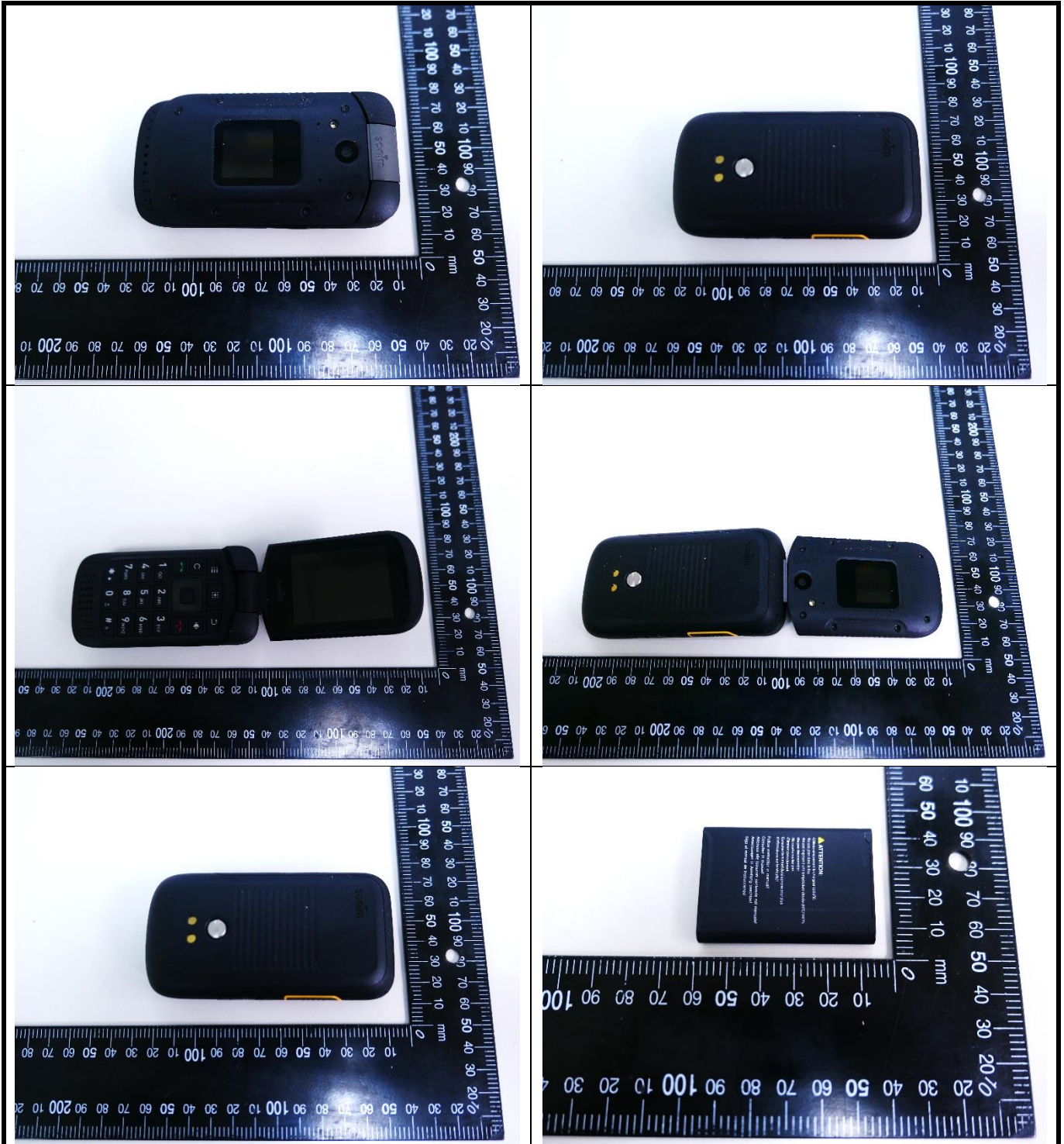

<Photographs of Setup>



Top View

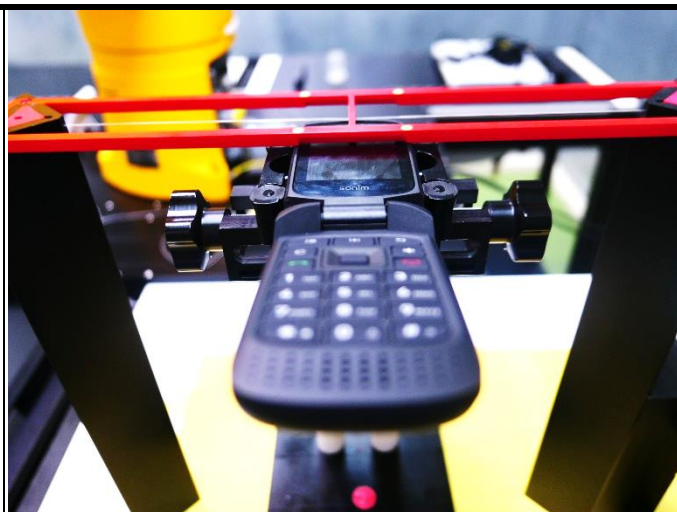

Bottom View

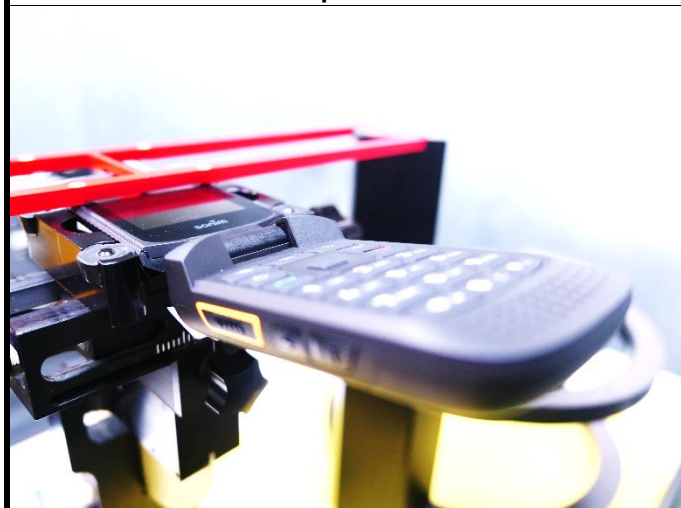

Left Side View

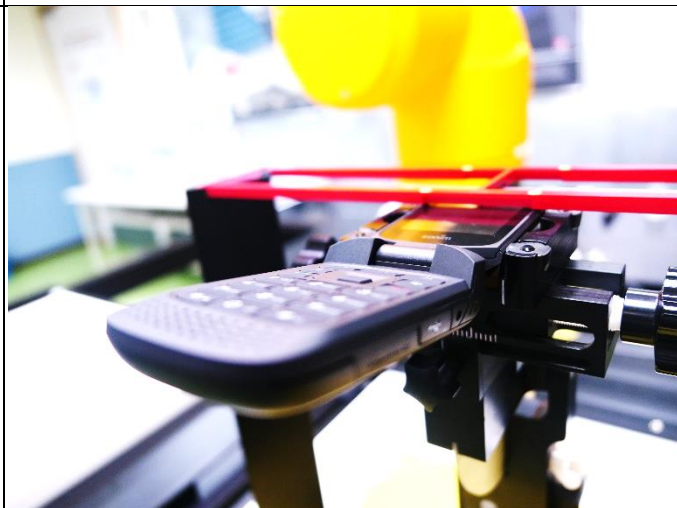

Right Side View