



Test Report No.: RF180829W002-9

# FCC TEST REPORT (PART 90)

Applicant:	Sonim Technologies, Inc.
Address:	1875 S. Grant St., Suite 750., San Mateo, CA, 94402

Manufacturer or Supplier:	Sonim Technologies (Shenzhen) Limited
Address:	2nd Floor, No. 2 Building Phase B, Daqian Industrial park, Longchang Road, 67 District, Baoan, Shenzhen, P. R. China
Product:	Mobile Phone
Brand Name:	Sonim
Model Name:	XP3800
FCC ID:	WYPPC2223
Date of tests:	Sep. 25, 2018 ~ Dec. 20, 2018

The tests have been carried out according to the requirements of the following standard:

- FCC Part 90, Subpart R, S     ANSI/TIA/EIA-603- D
- FCC Part 2                       ANSI/TIA/EIA-603-E     ANSI C63.26-2015

CONCLUSION: The submitted sample was found to COMPLY with the test requirement

Prepared by Roger Li Engineer / Mobile Department	Approved by Sam Tung Manager / Mobile Department
 Date: Dec. 21, 2018	 Date: Dec. 21, 2018

This report is governed by, and incorporates by reference, CPS Conditions of Service as posted at the date of issuance of this report at <http://www.bureauveritas.com/home/about-us/our-business/gps/about-us/terms-conditions> and is intended for your exclusive use. Any copying or replication of this report to or for any other person or entity, or use of our name or trademark, is permitted only with our prior written permission. This report sets forth our findings solely with respect to the test samples identified herein. The results set forth in this report are not indicative or representative of the quality or characteristics of the lot from which a test sample was taken or any similar or identical product unless specifically and expressly noted. Our report includes all of the tests requested by you and the results thereof based upon the information that you provided to us. Measurement uncertainty is only provided upon request for accredited tests. You have 60 days from date of issuance of this report to notify us of any material error or omission caused by our negligence or if you require measurement uncertainty; provided, however, that such notice shall be in writing and shall specifically address the issue you wish to raise. A failure to raise such issue within the prescribed time shall constitute your unqualified acceptance of the completeness of this report, the tests conducted and the correctness of the report contents.



# TABLE OF CONTENTS

<b>RELEASE CONTROL RECORD .....</b>	<b>3</b>
<b>1 SUMMARY OF TEST RESULTS .....</b>	<b>4</b>
1.1 MEASUREMENT UNCERTAINTY .....	4
1.2 TEST SITE AND INSTRUMENTS .....	5
<b>2 GENERAL INFORMATION.....</b>	<b>6</b>
2.1 GENERAL DESCRIPTION OF EUT .....	6
2.2 CONFIGURATION OF SYSTEM UNDER TEST .....	8
2.3 DESCRIPTION OF SUPPORT UNITS .....	9
2.4 DESCRIPTION OF TEST MODES.....	9
2.5 GENERAL DESCRIPTION OF APPLIED STANDARDS .....	12
<b>3 TEST TYPES AND RESULTS .....</b>	<b>13</b>
3.1 OUTPUT POWER MEASUREMENT .....	13
3.1.1 LIMITS OF OUTPUT POWER MEASUREMENT .....	13
3.1.2 TEST PROCEDURES .....	13
3.1.3 TEST SETUP .....	14
3.1.4 TEST RESULTS .....	15
3.2 FREQUENCY STABILITY MEASUREMENT .....	27
3.2.1 LIMITS OF FREQUENCY STABILITY MEASUREMENT .....	27
3.2.2 TEST PROCEDURE .....	27
3.2.3 TEST SETUP .....	27
3.2.4 TEST RESULTS .....	28
3.3 OCCUPIED BANDWIDTH MEASUREMENT .....	35
3.3.1 LIMITS OF OCCUPIED BANDWIDTH MEASUREMENT .....	35
3.3.2 TEST SETUP .....	35
3.3.3 TEST PROCEDURES .....	35
3.3.4 TEST RESULTS .....	36
3.4 EMISSION MASK MEASUREMENT .....	43
3.4.1 LIMITS OF EMISSION MASK MEASUREMENT .....	43
3.4.2 TEST SETUP .....	43
3.4.3 TEST PROCEDURES .....	44
3.4.4 TEST RESULTS .....	45
3.5 CONDUCTED SPURIOUS EMISSIONS.....	52
3.5.1 LIMITS OF CONDUCTED SPURIOUS EMISSIONS MEASUREMENT .....	52
3.5.2 TEST PROCEDURE .....	52
3.5.3 TEST SETUP .....	52
3.5.4 TEST RESULTS .....	53
3.6 RADIATED EMISSION MEASUREMENT .....	60
3.6.1 LIMITS OF RADIATED EMISSION MEASUREMENT .....	60
3.6.2 TEST PROCEDURES .....	60
3.6.3 DEVIATION FROM TEST STANDARD .....	60
3.6.4 TEST SETUP .....	61
3.6.5 TEST RESULTS .....	63
<b>4 INFORMATION ON THE TESTING LABORATORIES .....</b>	<b>87</b>
<b>5 APPENDIX A – MODIFICATIONS RECORDERS FOR ENGINEERING CHANGES TO THE EUT BY THE LAB .....</b>	<b>88</b>



Test Report No.: RF180829W002-9

## RELEASE CONTROL RECORD

ISSUE NO.	REASON FOR CHANGE	DATE ISSUED
RF180829W002-9	Original release	Dec. 21, 2018

## 1 SUMMARY OF TEST RESULTS

The EUT has been tested according to the following specifications:

APPLIED STANDARD: FCC Part 90 & Part 2			
STANDARD SECTION	TEST TYPE AND LIMIT	RESULT	REMARK
2.1046 90.635(b) 90.542(a)(7)	Maximum Peak Output Power	PASS	Meet the requirement of limit.
2.1055 90.213 90.539	Frequency Stability	PASS	Meet the requirement of limit.
2.1049 90.209	Occupied Bandwidth	PASS	Meet the requirement of limit.
2.1051 90.691 90.543	Emission Masks	PASS	Meet the requirement of limit.
2.1051 90.691 90.543	Conducted Spurious Emissions	PASS	Meet the requirement of limit.
2.1053 90.691 90.543	Radiated Spurious Emissions	PASS	Meet the requirement of limit. Minimum passing margin is -25.57dB at 51.48MHz.

### 1.1 MEASUREMENT UNCERTAINTY

Where relevant, the following measurement uncertainty levels have been estimated for tests performed on the EUT as specified in CISPR 16-4-2:

MEASUREMENT	FREQUENCY	UNCERTAINTY
Conducted emissions	9kHz~30MHz	2.66dB
Radiated emissions	9KHz ~ 30MHz	2.68dB
	30MHz ~ 1GMHz	3.26dB
	1GHz ~ 18GHz	4.48dB
	18GHz ~ 40GHz	4.12dB

This uncertainty represents an expanded uncertainty expressed at approximately the 95% confidence level using a coverage factor of k=2.



## 1.2 TEST SITE AND INSTRUMENTS

Equipment	Manufacturer	Model No.	Serial No.	Last Cal.	Next Cal.
MXE EMI Receiver	KEYSIGHT	N9038A-544	MY54450026	Mar. 16,18	Mar. 15,19
EXA Signal Analyzer	KEYSIGHT	N9010A-526	MY54510322	Mar. 16,18	Mar. 15,19
Bilog Antenna 1	ETS-LINDGREN	3143B	00161964	Mar. 15,18	Mar. 14,19
Bilog Antenna 2	ETS-LINDGREN	3143B	00161965	Mar. 15,18	Mar. 14,19
Horn Antenna 1	ETS-LINDGREN	3117	00168728	Mar. 15,18	Mar. 14,19
Horn Antenna 2	ETS-LINDGREN	3117	00168692	Nov. 30, 18	Nov. 29, 19
Loop antenna	Daze	ZN30900A	0708	Oct. 23,18	Oct. 22, 19
Horn Antenna (18GHz-40GHz)	N/A	QWH-SL-18-40 -K-SG/QMS-00 361	15433	Nov. 21, 18	Nov. 20, 19
Radio Communication Analyzer	ANRITSU	MT8820C	6201465426	Mar. 02,18	Mar. 01,19
Signal Pre-Amplifier	EMSI	EMC 9135	980249	Jul. 09,18	Jul. 08,19
Signal Pre-Amplifier	EMSI	EMC 012645B	980257	Jul. 09,18	Jul. 08,19
Signal Pre-Amplifier	EMSI	EMC 184045B	980259	Jul. 09,18	Jul. 08,19
3m Semi-anechoic Chamber	ETS-LINDGREN	9m*6m*6m	Euroshieldpn- CT0001143-1216	Apr. 21,18	Apr. 20,19
Test Software	E3	V 9.160323	N/A	N/A	N/A
Test Software	ADT	ADT_Radiated _V7.6.15.9.2	N/A	N/A	N/A
10dB Attenuator	JFW/USA	50HF-010-SM A	1505	Jul. 09,18	Jul. 08,19
Power Meter	Anritsu	ML2495A	1506002	Mar. 02,18	Mar. 01,19
Power Sensor	Anritsu	MA2411B	1339352	Mar. 16,18	Mar. 15,19
Humid & Temp Programmable Tester	Juyi	ITH-120-45-CP -AR	IAA1504-001	Jul. 09,18	Jul. 08,19
MXG Analog Microwave Signal Generator	KEYSIGHT	N5183A	MY50143024	Mar. 13,18	Mar. 12,19

- NOTE:**
1. The calibration interval of the above test instruments is 12 months or 24 months and the calibrations are traceable to CEPREI/CHINA, GRGT/CHINA and NIM/CHINA.
  2. The test was performed in 3m Semi-anechoic Chamber and RF Oven Room.
  3. The horn antenna is used only for the measurement of emission frequency above 1GHz if tested.
  4. The FCC Site Registration No. is 525120; The Designation No. is CN1171.

## 2 GENERAL INFORMATION

### 2.1 GENERAL DESCRIPTION OF EUT

<b>EUT</b>	Mobile Phone	
<b>BRAND NAME</b>	Sonim	
<b>MODEL NAME</b>	XP3800	
<b>POWER SUPPLY</b>	5.0Vdc (adapter or host equipment) 3.7Vdc (Li-ion, battery)	
<b>MODULATION TECHNOLOGY</b>	<b>CDMA</b>	QPSK, HPSK
	<b>LTE</b>	QPSK, 16QAM, 64QAM
<b>FREQUENCY RANGE</b>	<b>CDMA BC10</b>	817.9MHz ~ 823.1MHz
	<b>LTE Band 14 (Channel Bandwidth: 5MHz)</b>	790.5MHz ~ 795.5 MHz
	<b>LTE Band 14 (Channel Bandwidth: 10MHz)</b>	793 MHz
	<b>LTE Band 26 (Channel Bandwidth: 1.4MHz)</b>	814.7MHz ~ 823.3MHz
	<b>LTE Band 26 (Channel Bandwidth: 3MHz)</b>	815.5MHz ~ 822.5MHz
	<b>LTE Band 26 (Channel Bandwidth: 5MHz)</b>	816.5MHz ~ 821.5MHz
	<b>LTE Band 26 (Channel Bandwidth: 10MHz)</b>	819MHz
	<b>EMISSION DESIGNATOR</b>	<b>CDMA BC10</b>
<b>LTE Band 14 (Channel Bandwidth: 5MHz)</b>		QPSK: 4M47G7D
		16QAM: 4M47W7D
		64QAM: 4M47W7D
<b>LTE Band 14 (Channel Bandwidth: 10MHz)</b>		QPSK: 8M94G7D
		16QAM: 8M91W7D
		64QAM: 8M91W7D
<b>LTE Band 26 (Channel Bandwidth: 1.4MHz)</b>		QPSK: 1M09G7D
		16QAM: 1M09W7D
		64QAM: 1M09W7D
<b>LTE Band 26 (Channel Bandwidth: 3MHz)</b>		QPSK: 2M68G7D
		16QAM: 2M68W7D
	64QAM: 2M69W7D	
<b>LTE Band 26 (Channel Bandwidth: 5MHz)</b>	QPSK: 4M47G7D	
	16QAM: 4M47W7D	
	64QAM: 4M47W7D	

<b>EMISSION DESIGNATOR</b>	<b>LTE Band 26 (Channel Bandwidth: 10MHz)</b>	QPSK: 8M92G7D
		16QAM: 8M89W7D
		64QAM: 8M91W7D
<b>MAX. ERP POWER</b>	<b>CDMA BC10</b>	86mW
	<b>LTE Band 14 (Channel Bandwidth: 5MHz)</b>	278mW
	<b>LTE Band 14 (Channel Bandwidth: 10MHz)</b>	251mW
	<b>LTE Band 26 (Channel Bandwidth: 1.4MHz)</b>	144mW
	<b>LTE Band 26 (Channel Bandwidth: 3MHz)</b>	152mW
	<b>LTE Band 26 (Channel Bandwidth: 5MHz)</b>	151mW
	<b>LTE Band 26 (Channel Bandwidth: 10MHz)</b>	115mW
<b>ANTENNA TYPE</b>	Fixed Internal antenna with 0.5dBi gain	
<b>HW VERSION</b>	DVT2	
<b>SW VERSION</b>	3A.0.0-00-8.1.0-29.09.04	
<b>I/O PORTS</b>	Refer to user's manual	
<b>DATA CABLE</b>	USB cable: non-shielded, detachable, 1.5m	

**NOTE:**

- For a more detailed features description, please refer to the manufacturer's specifications or the user's manual.
- The EUT was powered by the following adapters:

<b>ADAPTER 1</b>	
<b>BRAND:</b>	Sonim
<b>MODEL:</b>	TUUS050100-K00
<b>INPUT:</b>	AC 100-240V, 200mA
<b>OUTPUT:</b>	DC 5V, 1000mA

<b>ADAPTER 2</b>	
<b>BRAND:</b>	Sonim
<b>MODEL:</b>	AQ05A-050B
<b>INPUT:</b>	AC 100-240V, 200mA
<b>OUTPUT:</b>	DC 5V, 1000mA

- The EUT matched the following USB cable:

<b>USB CABLE</b>	
<b>BRAND:</b>	N.A
<b>MODEL:</b>	N.A
<b>SIGNAL LINE:</b>	1.5 METER

- For the test results, the EUT had been tested with all conditions. But only the worst case was shown in test report.

## 2.2 CONFIGURATION OF SYSTEM UNDER TEST

### FOR RADIATION EMISSION TEST

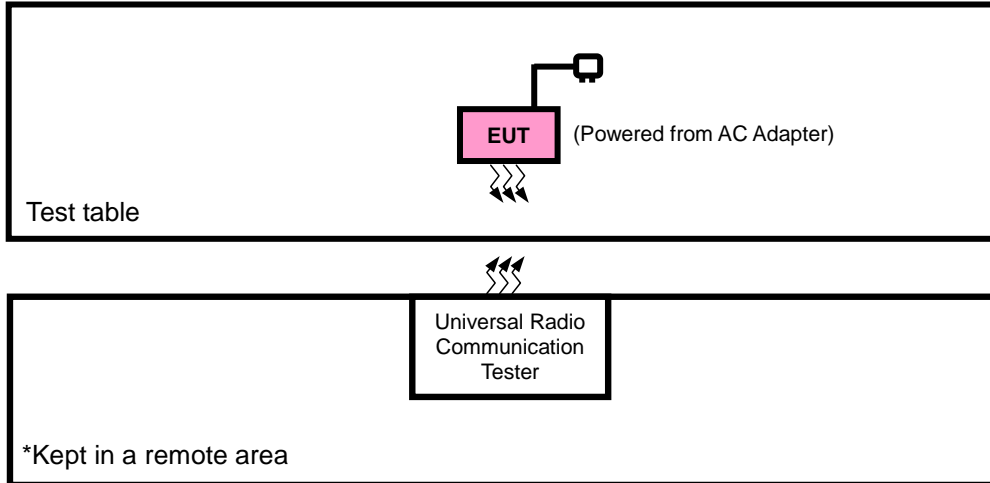

### FOR CONDUCTED & E.R.P./E.I.R.P TEST

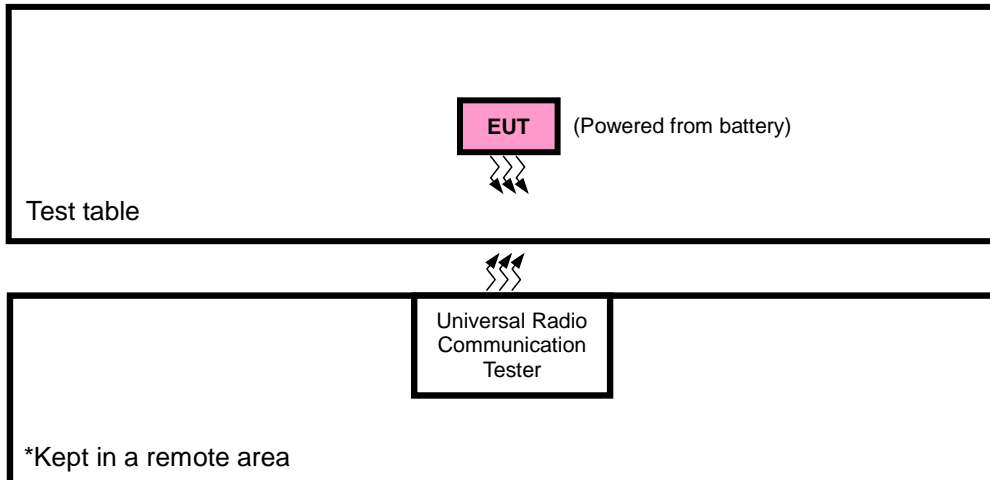





### 2.3 DESCRIPTION OF SUPPORT UNITS

The EUT has been tested as an independent unit together with other necessary accessories or support units. The following support units or accessories were used to form a representative test configuration during the tests.

NO.	PRODUCT	BRAND	MODEL NO.	SERIAL NO.	FCC ID
1	DC source	LONG WEI	PS-6403D	010934269	N/A
2	PC	HP	A6608CN	3CR83825X3	N/A

NO.	SIGNAL CABLE DESCRIPTION OF THE ABOVE SUPPORT UNITS
1	DC Line: Unshielded, Detachable 1.0m
2	AC Line: Unshielded, Detachable 1.5m

**NOTE:**

1. All power cords of the above support units are non shielded (1.8m).

### 2.4 DESCRIPTION OF TEST MODES

Pre-Scan has been conducted to determine the worst-case mode from all possible combinations between available modulations, data rates, XYZ axis and antenna ports. The worst case in ERP/EIRP and radiated emission was found when positioned on X-plane for CDMA/LTE. Following channel(s) was (were) selected for the final test as listed below:

EUT CONFIGURE MODE	DESCRIPTION
A	EUT + Adapter + USB Cable + with CDMA or LTE link
B	EUT + Battery with CDMA or LTE link

#### CDMA BC10 MODE

EUT CONFIGURE MODE	TEST ITEM	AVAILABLE CHANNEL	TESTED CHANNEL	MODE
B	ERP	476 to 684	476, 580, 684	1xRTT
B	FREQUENCY STABILITY	476 to 684	476, 684	1xRTT
B	OCCUPIED BANDWIDTH	476 to 684	476, 580, 684	1xRTT
B	PEAK TO AVERAGE RATIO	476 to 684	476, 580, 684	1xRTT
B	BAND EDGE	476 to 684	476, 684	1xRTT
B	CONDCUDED EMISSION	476 to 684	476, 580, 684	1xRTT
A	RADIATED EMISSION	476 to 684	476, 580, 684	1xRTT

**LTE BAND 14**

EUT CONFIGURE MODE	TEST ITEM	AVAILABLE CHANNEL	TESTED CHANNEL	CHANNEL BANDWIDTH	MODULATION	MODE
B	EIRP	23305 to 23355	23305, 23330, 23355	5MHz	QPSK, 16QAM, 64QAM	1 RB / 0 RB Offset
		23330	23330	10MHz	QPSK, 16QAM, 64QAM	1 RB / 0 RB Offset
B	FREQUENCY STABILITY	23305 to 23355	23305, 23355	5MHz	QPSK, 16QAM	1 RB / 0 RB Offset
		23330	23330	10MHz	QPSK, 16QAM	1 RB / 0 RB Offset
B	OCCUPIED BANDWIDTH	23305 to 23355	23305, 23330, 23355	5MHz	QPSK, 16QAM, 64QAM	25 RB / 0 RB Offset
		23330	23330	10MHz	QPSK, 16QAM, 64QAM	50 RB / 0 RB Offset
B	BAND EDGE	23305 to 23355	23305	5MHz	QPSK, 16QAM	25 RB / 0 RB Offset
			23330	5MHz	QPSK, 16QAM	25 RB / 0 RB Offset
			23355	5MHz	QPSK, 16QAM	25 RB / 0 RB Offset
		23330	23330	10MHz	QPSK, 16QAM	50 RB / 0 RB Offset
			23330	10MHz	QPSK, 16QAM	50 RB / 0 RB Offset
B	CONDCUDED EMISSION	23305 to 23355	23305, 23330, 23355	5MHz	QPSK, 16QAM	1 RB / 0 RB Offset
		23330	23330	10MHz	QPSK, 16QAM	1 RB / 0 RB Offset
A	RADIATED EMISSION	23305 to 23355	23330	5MHz	QPSK	1 RB / 0 RB Offset
		23330	23330	10MHz	QPSK	1 RB / 0 RB Offset

**Note:** This device was tested under all bandwidths, RB configurations and modulations. The worst case was found in QPSK modulation.

**LTE BAND 26**

EUT CONFIGURE MODE	TEST ITEM	AVAILABLE CHANNEL	TESTED CHANNEL	CHANNEL BANDWIDTH	MODULATION	MODE		
B	ERP	26697 to 26783	26697, 26740, 26783	1.4MHz	QPSK, 16QAM, 64QAM	1 RB / 0 RB Offset		
		26705 to 26775	26705, 26740, 26775	3MHz	QPSK, 16QAM, 64QAM	1 RB / 0 RB Offset		
		26715 to 26765	26715, 26740, 26765	5MHz	QPSK, 16QAM, 64QAM	1 RB / 0 RB Offset		
		26740	26740	10MHz	QPSK, 16QAM, 64QAM	1 RB / 0 RB Offset		
B	FREQUENCY STABILITY	26697 to 26783	26697, 26783	1.4MHz	QPSK	1 RB / 0 RB Offset		
		26705 to 26775	26705, 26775	3MHz	QPSK	1 RB / 0 RB Offset		
		26715 to 26765	26715, 26765	5MHz	QPSK	1 RB / 0 RB Offset		
		26740	26740	10MHz	QPSK	1 RB / 0 RB Offset		
B	OCCUPIED BANDWIDTH	26697 to 26783	26697, 26740, 26783	1.4MHz	QPSK, 16QAM, 64QAM	6 RB / 0 RB Offset		
		26705 to 26775	26705, 26740, 26775	3MHz	QPSK, 16QAM, 64QAM	15 RB / 0 RB Offset		
		26715 to 26765	26715, 26740, 26765	5MHz	QPSK, 16QAM, 64QAM	25 RB / 0 RB Offset		
		26740	26740	10MHz	QPSK, 16QAM, 64QAM	50 RB / 0 RB Offset		
B	BAND EDGE	26697 to 26783	26697	1.4MHz	QPSK	1 RB / 0 RB Offset 6 RB / 0 RB Offset		
			26783	1.4MHz	QPSK	1 RB / 5 RB Offset 6 RB / 0 RB Offset		
		26705 to 26775	26705	3MHz	QPSK	1 RB / 0 RB Offset 15 RB / 0 RB Offset		
			26775	3MHz	QPSK	1 RB / 14 RB Offset 15 RB / 0 RB Offset		
		26715 to 26765	26715	5MHz	QPSK	1 RB / 0 RB Offset 25 RB / 0 RB Offset		
			26765	5MHz	QPSK	1 RB / 24 RB Offset 25 RB / 0 RB Offset		
		26740	26740	10MHz	QPSK	1 RB / 0 RB Offset 50 RB / 0 RB Offset		
			26740	10MHz	QPSK	1 RB / 49 RB Offset 50 RB / 0 RB Offset		
		B	CONDCUDED EMISSION	26697 to 26783	26697, 26740, 26783	1.4MHz	QPSK	1 RB / 0 RB Offset
				26705 to 26775	26705, 26740, 26775	3MHz	QPSK	1 RB / 0 RB Offset
				26715 to 26765	26715, 26740, 26765	5MHz	QPSK	1 RB / 0 RB Offset
				26740	26740	10MHz	QPSK	1 RB / 0 RB Offset
A	RADIATED EMISSION	26697 to 26783	26697, 26740, 26783	1.4MHz	QPSK	1 RB / 0 RB Offset		
		26705 to 26775	26740	3MHz	QPSK	1 RB / 0 RB Offset		
		26715 to 26765	26740	5MHz	QPSK	1 RB / 0 RB Offset		
		26740	26740	10MHz	QPSK	1 RB / 0 RB Offset		

**Note:** This device was tested under all bandwidths, RB configurations and modulations. The worst case was found in QPSK modulation.



Test Report No.: RF180829W002-6

**TEST CONDITION:**

TEST ITEM	ENVIRONMENTAL CONDITIONS	INPUT POWER	TESTED BY
EIRP(ERP)	24deg. C, 60%RH	3.7Vdc from Battery	Rose Ma
FREQUENCY STABILITY	24deg. C, 61%RH	DC 3.4V/3.7V/4.2V	Rain Wang
OCCUPIED BANDWIDTH	24deg. C, 61%RH	3.7Vdc from Battery	Rain Wang
BAND EDGE	24deg. C, 61%RH	3.7Vdc from Battery	Rain Wang
CONDCUDED EMISSION	24deg. C, 61%RH	3.7Vdc from Battery	Rain Wang
RADIATED EMISSION	23deg. C, 70%RH	DC 5V from adaptor	Rose Ma

## 2.5 GENERAL DESCRIPTION OF APPLIED STANDARDS

The EUT is a RF product. According to the specifications of the manufacturer, it must comply with the requirements of the following standards:

**FCC 47 CFR Part 2**

**FCC 47 CFR Part 90**

**ANSI/TIA/EIA-603-D**

**ANSI/TIA/EIA-603-E**

**ANSI C63.26-2015**

**NOTE:** All test items have been performed and recorded as per the above standards.



### 3 TEST TYPES AND RESULTS

#### 3.1 OUTPUT POWER MEASUREMENT

##### 3.1.1 LIMITS OF OUTPUT POWER MEASUREMENT

Per FCC Part 90.635(a)(b)

Mobile stations are limited to 100 watts e.r.p. Portable stations are limited to 3 watts e.r.p.

##### 3.1.2 TEST PROCEDURES

###### EIRP / ERP MEASUREMENT:

- a. The EUT was set up for the maximum power with LTE link data modulation. The power was measured with R&S Spectrum Analyzer. All measurements were done at 3 channels (low, middle and high operational frequency range). RBW and VBW is 10MHz for LTE.
- b. E.I.R.P power measurement. In the semi-anechoic chamber, EUT placed on the 0.8m height of Turn Table, rotated the table around 360 degrees to search the maximum radiation power and receiver antenna shall be rotated vertical and horizontal polarization and moved height from 1m to 4m to find the maximum polar radiated power. The "Read Value" is the spectrum reading the maximum power value.
- c. The substitution horn antenna is substituted for EUT at the same position and signals generator export the CW signal to the substitution antenna via a TX cable. Rotated the Turn Table and moved receiving antenna to find the maximum radiation power. Adjust output power level of S.G to get a Value of spectrum reading equal to "Read Value" of step a. Record the power level of S.G
- d.  $EIRP = \text{Output power level of S.G} - \text{TX cable loss} + \text{Antenna gain of substitution horn}$
- e.  $E.R.P = E.I.R.P - 2.15 \text{ dB}$

###### CONDUCTED POWER MEASUREMENT:

- a. The EUT was set up for the maximum power with LTE link data modulation and link up with simulator.
- b. Set the EUT to transmit under low, middle and high channel and record the power level shown on simulator.

### 3.1.3 TEST SETUP

#### ERP MEASUREMENT:

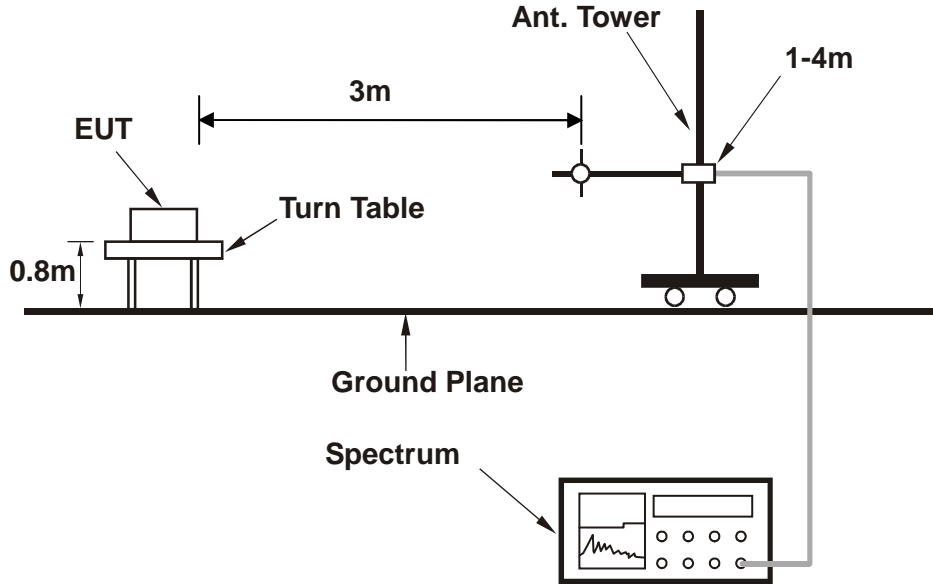

#### EIRP MEASUREMENT:

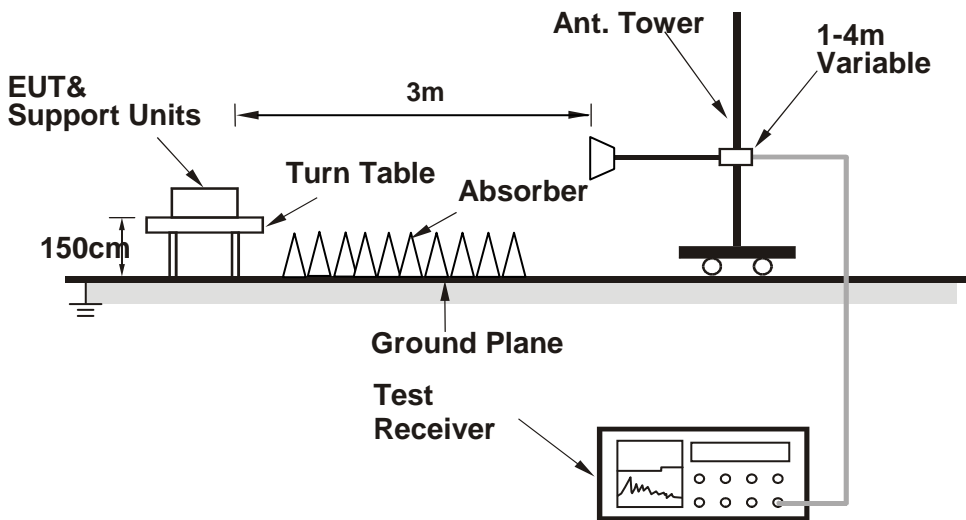

For the actual test configuration, please refer to the attached file (Test Setup Photo).

#### CONDUCTED POWER MEASUREMENT:

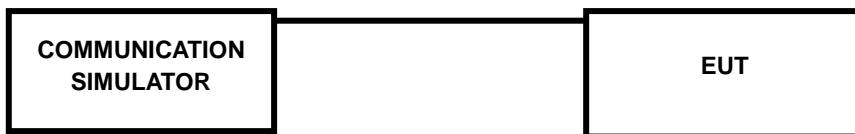

For the actual test configuration, please refer to the attached file (Test Setup Photo).



**BUREAU  
VERITAS**

Test Report No.: RF180829W002-6

### 3.1.4 TEST RESULTS

#### AVERAGE CONDUCTED OUTPUT POWER (dBm)

Band	CDMA2000 BC10		
Channel	476	580	684
Frequency (MHz)	817.9	820.5	823.1
RC1+SO55	24.68	24.61	24.68
RC3+SO55	24.71	24.64	24.58
RC3+SO32(FCH)	<b>24.74</b>	24.69	24.61
RC3+SO32(SCH)	24.07	24.02	23.94
RTAP 153.6	24.39	24.35	24.33
RETAP 4096	24.37	24.33	24.30
RC1+SO3	24.18	24.14	24.11
RC3+SO3	24.24	24.20	24.17

LTE Band 14								
BW	Modulation	RB Size	RB Offset	Low CH	Mid CH	High CH	MPR	
				23305	23330	23355		
				Frequency	Frequency	Frequency		
				790.5 MHz	793 MHz	795.5 MHz		
5 MHz	QPSK	1	0	23.17	23.12	23.22	0	
		1	12	23.28	23.23	23.33	0	
		1	24	23.19	23.14	23.24	0	
		12	0	22.33	22.28	22.38	1	
		12	6	22.35	22.30	22.40	1	
		12	13	22.26	22.21	22.31	1	
		25	0	22.21	22.16	22.26	1	
	16QAM	1	0	21.67	21.62	21.72	1	
		1	12	21.78	21.73	21.83	1	
		1	24	21.66	21.61	21.71	1	
		12	0	21.17	21.12	21.22	2	
		12	6	21.38	21.33	21.43	2	
		12	13	21.36	21.31	21.41	2	
		25	0	21.07	21.02	21.12	2	
	64QAM	1	0	21.04	20.99	21.09	2	
		1	12	21.29	21.24	21.34	2	
		1	24	21.20	21.15	21.25	2	
		12	0	20.42	20.37	20.47	3	
		12	6	20.40	20.35	20.45	3	
		12	13	20.32	20.27	20.37	3	
		25	0	20.34	20.29	20.39	3	



Test Report No.: RF180829W002-6

LTE Band 14							
BW	Modulation	RB Size	RB Offset	CH	CH 23330	CH	MPR
				Frequency MHz	Frequency 793 MHz	Frequency MHz	
10 MHz	QPSK	1	0	-	23.19	-	0
		1	24	-	<b>23.31</b>	-	0
		1	49	-	23.22	-	0
		25	0	-	22.33	-	1
		25	12	-	22.31	-	1
		25	25	-	22.26	-	1
		50	0	-	22.18	-	1
	16QAM	1	0	-	21.67	-	1
		1	24	-	21.75	-	1
		1	49	-	21.69	-	1
		25	0	-	21.18	-	2
		25	12	-	21.35	-	2
		25	25	-	21.36	-	2
		50	0	-	21.09	-	2
	64QAM	1	0	-	21.04	-	2
		1	24	-	21.26	-	2
		1	49	-	21.16	-	2
		25	0	-	20.42	-	3
		25	12	-	20.36	-	3
		25	25	-	20.32	-	3
		50	0	-	20.31	-	3



LTE Band 26							
BW	Modulation	RB Size	RB Offset	Low CHG 26697	Mid CH 26740	High CH 26783	MPR
				Frequency 814.7 MHz	Frequency 819 MHz	Frequency 823.3 MHz	
1.4 MHz	QPSK	1	0	22.91	22.95	22.99	0
		1	2	23.12	23.16	23.20	0
		1	5	22.86	22.90	22.94	0
		3	0	22.89	22.93	22.97	0
		3	1	23.10	23.14	23.18	0
		3	3	22.84	22.88	22.92	0
	16QAM	6	0	21.91	21.95	21.99	1
		1	0	21.32	21.36	21.40	1
		1	2	21.27	21.31	21.35	1
		1	5	21.23	21.27	21.31	1
		3	0	21.31	21.35	21.39	1
		3	1	21.26	21.30	21.34	1
	64QAM	3	3	21.22	21.26	21.30	1
		6	0	20.96	21.00	21.04	2
		1	0	20.83	20.87	20.91	2
		1	2	20.79	20.83	20.87	2
		1	5	20.77	20.81	20.85	2
		3	0	20.82	20.86	20.90	3
		3	1	20.78	20.82	20.86	3
	3	3	20.76	20.80	20.84	3	
	6	0	20.09	20.13	20.17	3	

LTE Band 26							
BW	Modulation	RB Size	RB Offset	Low CHG 26705	Mid CH 26740	High CH 26775	MPR
				Frequency 815.5 MHz	Frequency 819 MHz	Frequency 822.5 MHz	
3 MHz	QPSK	1	0	22.95	22.99	23.03	0
		1	7	23.16	23.20	23.24	0
		1	14	22.90	22.94	22.98	0
		8	0	22.05	22.09	22.13	1
		8	3	22.01	22.05	22.09	1
		8	7	21.95	21.99	22.03	1
		15	0	21.95	21.99	22.03	1
	16QAM	1	0	21.36	21.40	21.44	1
		1	7	21.31	21.35	21.39	1
		1	14	21.27	21.31	21.35	1
		8	0	21.23	21.27	21.31	2
		8	3	21.18	21.22	21.26	2
		8	7	21.14	21.18	21.22	2
		15	0	21.00	21.04	21.08	2
	64QAM	1	0	20.87	20.91	20.95	2
		1	7	20.83	20.87	20.91	2
		1	14	20.81	20.85	20.89	2
		8	0	20.86	20.90	20.94	3
		8	3	20.82	20.86	20.90	3
		8	7	20.80	20.84	20.88	3
		15	0	20.13	20.17	20.21	3



Test Report No.: RF180829W002-6

LTE Band 26							
BW	Modulation	RB Size	RB Offset	Low CHG 26715	Mid CH 26740	High CH 26765	MPR
				Frequency 816.5 MHz	Frequency 819 MHz	Frequency 821.5 MHz	
5 MHz	QPSK	1	0	22.98	23.02	23.06	0
		1	12	23.19	23.23	23.27	0
		1	24	22.93	22.97	23.01	0
		12	0	22.08	22.12	22.16	1
		12	6	22.04	22.08	22.12	1
		12	13	21.98	22.02	22.06	1
		25	0	21.98	22.02	22.06	1
	16QAM	1	0	21.39	21.43	21.47	1
		1	12	21.34	21.38	21.42	1
		1	24	21.30	21.34	21.38	1
		12	0	21.26	21.30	21.34	2
		12	6	21.21	21.25	21.29	2
		12	13	21.17	21.21	21.25	2
		25	0	21.03	21.07	21.11	2
	64QAM	1	0	20.91	20.95	20.99	2
		1	12	20.87	20.91	20.95	2
		1	24	20.85	20.89	20.93	2
		12	0	20.21	20.25	20.29	3
		12	6	20.19	20.23	20.27	3
		12	13	20.16	20.20	20.24	3
		25	0	20.17	20.21	20.25	3

LTE Band 26							
BW	Modulation	RB Size	RB Offset	CH	CH 26740	CH	MPR
				Frequency MHz	Frequency 819 MHz	Frequency MHz	
10 MHz	QPSK	1	0	-	23.02	-	0
		1	24	-	<b>23.23</b>	-	0
		1	49	-	22.97	-	0
		25	0	-	22.12	-	1
		25	12	-	22.08	-	1
		25	25	-	22.02	-	1
		50	0	-	22.02	-	1
	16QAM	1	0	-	21.43	-	1
		1	24	-	21.38	-	1
		1	49	-	21.34	-	1
		25	0	-	21.30	-	2
		25	12	-	21.25	-	2
		25	25	-	21.21	-	2
		50	0	-	21.07	-	2
	64QAM	1	0	-	20.95	-	2
		1	24	-	20.91	-	2
		1	49	-	20.89	-	2
		25	0	-	20.25	-	3
		25	12	-	20.23	-	3
		25	25	-	20.20	-	3
		50	0	-	20.21	-	3

**EIRP**

**CDMA BC10**

Channel	Frequency (MHz)	SPA LVL (dBm)	Correction Factor(dB)	ERP(dBm)	ERP(mW)	Polarization (H/V)
476	817.9	-13.08	33.56	18.33	68.06	H
580	820.5	-12.14	33.63	19.34	<b>85.88</b>	H
684	823.1	-12.36	33.57	19.06	80.50	H
476	817.9	-20.78	34.24	11.31	13.51	V
580	820.5	-21.39	34.59	11.05	12.72	V
684	823.1	-21.18	34.62	11.29	13.47	V

**REMARKS:** 1. ERP Output Power (dBm) = SPA LVL (dBm) + Correction Factor (dB) -2.15(dB).  
2. Correction factor (dB) = Free Space Loss + Antenna Factor + Cable Loss

**LTE BAND 14**

**CHANNEL BANDWIDTH: 5MHz QPSK**

Channel	Frequency (MHz)	SPA LVL (dBm)	Correction Factor(dB)	ERP(dBm)	ERP(mW)	Polarization (H/V)	LIMIT (W)
23305	790.5	-8.87	33.18	22.16	164.44	H	3
23330	793.0	-6.67	33.26	24.44	<b>278.16</b>	H	3
23355	795.5	-9.21	33.28	21.92	155.42	H	3
23305	790.5	-15.97	32.25	14.13	25.90	V	3
23330	793.0	-14.79	32.34	15.40	34.67	V	3
23355	795.5	-16.24	32.41	14.02	25.26	V	3

**CHANNEL BANDWIDTH: 5MHz 16QAM**

Channel	Frequency (MHz)	SPA LVL (dBm)	Correction Factor(dB)	ERP(dBm)	ERP(mW)	Polarization (H/V)	LIMIT (W)
23305	790.5	-9.45	33.18	21.58	143.88	H	3
23330	793.0	-7.54	33.26	23.57	227.67	H	3
23355	795.5	-9.88	33.28	21.25	133.20	H	3
23305	790.5	-16.48	32.25	13.62	23.03	V	3
23330	793.0	-15.66	32.34	14.53	28.38	V	3
23355	795.5	-16.96	32.41	13.30	21.40	V	3



Test Report No.: RF180829W002-6

### CHANNEL BANDWIDTH: 5MHz 64QAM

Channel	Frequency (MHz)	SPA LVL (dBm)	Correction Factor(dB)	ERP(dBm)	ERP(mW)	Polarization (H/V)	LIMIT (W)
23305	790.5	-10.21	33.18	20.82	120.78	H	3
23330	793.0	-8.78	33.26	22.33	171.12	H	3
23355	795.5	-10.98	33.28	20.15	103.40	H	3
23305	790.5	-17.66	32.25	12.44	17.55	V	3
23330	793.0	-16.88	32.34	13.31	21.43	V	3
23355	795.5	-18.15	32.41	12.11	16.27	V	3

### LTE BAND 14

#### CHANNEL BANDWIDTH: 10MHz QPSK

Channel	Frequency (MHz)	SPA LVL (dBm)	Correction Factor(dB)	ERP(dBm)	ERP(mW)	Polarization (H/V)	LIMIT (W)
23330	793.0	-7.12	33.26	23.99	<b>250.78</b>	H	3
23330	793.0	-15.24	32.34	14.95	31.25	V	3

#### CHANNEL BANDWIDTH: 10MHz 16QAM

Channel	Frequency (MHz)	SPA LVL (dBm)	Correction Factor(dB)	ERP(dBm)	ERP(mW)	Polarization (H/V)	LIMIT (W)
23330	793.0	-8.19	33.26	22.92	196.02	H	3
23330	793.0	-16.31	32.34	13.88	24.42	V	3

#### CHANNEL BANDWIDTH: 10MHz 64QAM

Channel	Frequency (MHz)	SPA LVL (dBm)	Correction Factor(dB)	ERP(dBm)	ERP(mW)	Polarization (H/V)	LIMIT (W)
23330	793.0	-9.23	33.26	21.88	154.28	H	3
23330	793.0	-17.33	32.34	12.86	19.31	V	3

- REMARKS:** 1. ERP Output Power (dBm) = SPA LVL (dBm) + Correction Factor (dB) -2.15(dB).  
2. Correction factor (dB) = Free Space Loss + Antenna Factor + Cable Loss



Test Report No.: RF180829W002-6

**LTE BAND 26**

**CHANNEL BANDWIDTH: 1.4MHz QPSK**

Channel	Frequency (MHz)	SPA LVL (dBm)	Correction Factor(dB)	ERP(dBm)	ERP(mW)	Polarization (H/V)	LIMIT (W)
26697	814.7	-9.94	33.67	21.58	<b>143.98</b>	H	3
26740	819.0	-10.42	33.62	21.05	127.47	H	3
26783	823.3	-10.42	33.65	21.08	128.09	H	3
26697	814.7	-17.46	34.25	14.64	29.09	V	3
26740	819.0	-16.31	34.60	16.14	41.10	V	3
26783	823.3	-17.83	34.63	14.65	29.17	V	3

**CHANNEL BANDWIDTH: 1.4MHz 16QAM**

Channel	Frequency (MHz)	SPA LVL (dBm)	Correction Factor(dB)	ERP(dBm)	ERP(mW)	Polarization (H/V)	LIMIT (W)
26697	814.7	-10.77	33.67	20.75	118.93	H	3
26915	819.0	-11.44	33.62	20.03	100.79	H	3
26783	823.3	-11.52	33.65	19.98	99.43	H	3
26697	814.7	-18.29	34.25	13.81	24.03	V	3
26915	819.0	-17.33	34.60	15.12	32.49	V	3
26783	823.3	-18.93	34.63	13.55	22.65	V	3

**CHANNEL BANDWIDTH: 1.4MHz 64QAM**

Channel	Frequency (MHz)	SPA LVL (dBm)	Correction Factor(dB)	ERP(dBm)	ERP(mW)	Polarization (H/V)	LIMIT (W)
26697	814.7	-11.41	33.67	20.11	102.64	H	3
26915	819.0	-11.98	33.62	19.49	89.00	H	3
26783	823.3	-12.11	33.65	19.39	86.80	H	3
26697	814.7	-18.98	34.25	13.12	20.50	V	3
26915	819.0	-17.80	34.60	14.65	29.16	V	3
26783	823.3	-19.28	34.63	13.20	20.89	V	3



Test Report No.: RF180829W002-6

**LTE BAND 26**

**CHANNEL BANDWIDTH: 3MHz QPSK**

Channel	Frequency (MHz)	SPA LVL (dBm)	Correction Factor(dB)	ERP(dBm)	ERP(mW)	Polarization (H/V)	LIMIT (W)
26705	815.5	-9.75	33.72	21.82	<b>152.09</b>	H	3
26740	819.0	-10.36	33.62	21.11	129.24	H	3
26775	822.5	-10.29	33.65	21.21	132.10	H	3
26705	815.5	-17.27	34.30	14.88	30.77	V	3
26740	819.0	-16.25	34.60	16.20	41.67	V	3
26775	822.5	-17.70	34.57	14.72	29.66	V	3

**CHANNEL BANDWIDTH: 3MHz 16QAM**

Channel	Frequency (MHz)	SPA LVL (dBm)	Correction Factor(dB)	ERP(dBm)	ERP(mW)	Polarization (H/V)	LIMIT (W)
26705	815.5	-10.90	33.72	20.67	116.71	H	3
26740	819.0	-11.46	33.62	20.01	100.32	H	3
26775	822.5	-11.45	33.65	20.05	101.13	H	3
26705	815.5	-18.42	34.30	13.73	23.61	V	3
26740	819.0	-17.35	34.60	15.10	32.34	V	3
26775	822.5	-18.86	34.57	13.56	22.70	V	3

**CHANNEL BANDWIDTH: 3MHz 64QAM**

Channel	Frequency (MHz)	SPA LVL (dBm)	Correction Factor(dB)	ERP(dBm)	ERP(mW)	Polarization (H/V)	LIMIT (W)
26705	815.5	-11.22	33.72	20.35	108.42	H	3
26740	819.0	-11.92	33.62	19.55	90.24	H	3
26775	822.5	-11.98	33.65	19.52	89.52	H	3
26705	815.5	-18.79	34.30	13.36	21.68	V	3
26740	819.0	-17.74	34.60	14.71	29.57	V	3
26775	822.5	-19.15	34.57	13.27	21.24	V	3





Test Report No.: RF180829W002-6

**LTE BAND 26**

**CHANNEL BANDWIDTH: 5MHz QPSK**

Channel	Frequency (MHz)	SPA LVL (dBm)	Correction Factor(dB)	ERP(dBm)	ERP(mW)	Polarization (H/V)	LIMIT (W)
26715	816.5	-9.76	33.69	21.78	<b>150.80</b>	H	3
26740	819.0	-10.43	33.62	21.04	127.17	H	3
26765	821.5	-10.36	33.66	21.15	130.35	H	3
26715	816.5	-17.28	34.85	15.42	34.83	V	3
26740	819.0	-16.32	34.60	16.13	41.00	V	3
26765	821.5	-17.77	34.59	14.67	29.34	V	3

**CHANNEL BANDWIDTH: 5MHz 16QAM**

Channel	Frequency (MHz)	SPA LVL (dBm)	Correction Factor(dB)	ERP(dBm)	ERP(mW)	Polarization (H/V)	LIMIT (W)
26715	816.5	-10.62	33.69	20.92	123.71	H	3
26740	819.0	-11.30	33.62	20.17	104.09	H	3
26765	821.5	-11.21	33.66	20.30	107.18	H	3
26715	816.5	-18.14	34.85	14.56	28.57	V	3
26740	819.0	-17.19	34.60	15.26	33.56	V	3
26765	821.5	-18.62	34.59	13.82	24.12	V	3

**CHANNEL BANDWIDTH: 5MHz 64QAM**

Channel	Frequency (MHz)	SPA LVL (dBm)	Correction Factor(dB)	ERP(dBm)	ERP(mW)	Polarization (H/V)	LIMIT (W)
26715	816.5	-11.23	33.69	20.31	107.50	H	3
26740	819.0	-11.99	33.62	19.48	88.80	H	3
26765	821.5	-12.05	33.66	19.46	88.33	H	3
26715	816.5	-18.80	34.85	13.90	24.54	V	3
26740	819.0	-17.81	34.60	14.64	29.09	V	3
26765	821.5	-19.22	34.59	13.22	21.01	V	3



## LTE BAND 26

## CHANNEL BANDWIDTH: 10MHz QPSK

Channel	Frequency (MHz)	SPA LVL (dBm)	Correction Factor(dB)	ERP(dBm)	ERP(mW)	Polarization (H/V)	LIMIT (W)
26740	819.0	-10.88	33.62	20.59	<b>114.66</b>	H	3
26740	819.0	-16.77	34.60	15.68	36.97	V	3

## CHANNEL BANDWIDTH: 10MHz 16QAM

Channel	Frequency (MHz)	SPA LVL (dBm)	Correction Factor(dB)	ERP(dBm)	ERP(mW)	Polarization (H/V)	LIMIT (W)
26740	819.0	-11.95	33.62	19.52	89.62	H	3
26740	819.0	-17.84	34.60	14.61	28.89	V	3

## CHANNEL BANDWIDTH: 10MHz 64QAM

Channel	Frequency (MHz)	SPA LVL (dBm)	Correction Factor(dB)	ERP(dBm)	ERP(mW)	Polarization (H/V)	LIMIT (W)
26740	819.0	-12.44	33.62	19.03	80.06	H	3
26740	819.0	-18.26	34.60	14.19	26.23	V	3

**REMARKS:** 1. ERP Output Power (dBm) = SPA LVL (dBm) + Correction Factor (dB) -2.15(dB).

2. Correction factor (dB) = Free Space Loss + Antenna Factor + Cable Loss

### 3.2 FREQUENCY STABILITY MEASUREMENT

#### 3.2.1 LIMITS OF FREQUENCY STABILITY MEASUREMENT

The frequency stability of mobile, portable and control transmitters operating in the wideband segment must be 1.25 parts per million or better when AFC is locked to a base station, and 5 parts per million or better when AFC is not locked

#### 3.2.2 TEST PROCEDURE

- a. Device is placed at the oven room. The oven room could control the temperatures and humidity. Power warm up is at least 15 min and power applied should perform before recording frequency error.
- b. EUT is connected the external power supply to control the DC input power. The test voltage range is from minimum to maximum working voltage. Each step shall be record the frequency error rate.
- c. The temperature range step is 10 degrees in this test items. All temperature levels shall be hold the  $\pm 0.5^{\circ}\text{C}$  during the measurement testing. The each temperature step shall be at least 0.5 hours, consider the EUT could be test under the stability condition.

**NOTE:** The frequency error was recorded frequency error from the communication simulator.

#### 3.2.3 TEST SETUP

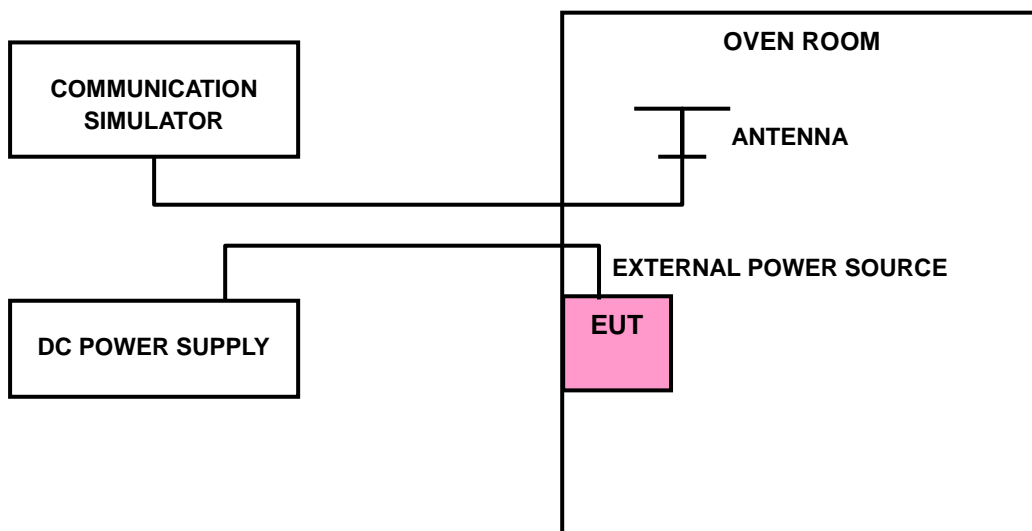



### 3.2.4 TEST RESULTS

#### CDMA BC10

##### FREQUENCY ERROR VS. VOLTAGE

VOLTAGE (Volts)	FREQUENCY ERROR (ppm)		LIMIT (ppm)
	Low Channel	High Channel	
3.7	0.0019	0.0017	2.5
3.4	-0.0023	-0.0021	2.5
4.2	0.0019	0.0018	2.5

**NOTE:** The applicant defined the normal working voltage of the battery is from 3.4Vdc to 4.2Vdc.

##### FREQUENCY ERROR vs. TEMPERATURE.

TEMP. (°C)	FREQUENCY ERROR (ppm)		LIMIT (ppm)
	Low Channel	High Channel	
-30	-0.0125	-0.0120	2.5
-20	-0.0115	-0.0110	2.5
-10	-0.0100	-0.0095	2.5
0	-0.0088	-0.0084	2.5
10	-0.0064	-0.0061	2.5
20	-0.0050	-0.0048	2.5
30	-0.0042	-0.0040	2.5
40	-0.0025	-0.0024	2.5
50	-0.0014	-0.0013	2.5



**LTE BAND 14**

**FREQUENCY ERROR VS. VOLTAGE**

VOLTAGE (Volts)	5MHz		LIMIT (ppm)
	FREQUENCY ERROR (ppm)		
	Low Channel	High Channel	
3.7	0.0020	0.0019	2.5
3.4	-0.0026	-0.0024	2.5
4.2	0.0019	0.0021	2.5

**NOTE:** The applicant defined the normal working voltage of the battery is from 3.4Vdc to 4.2Vdc.

**FREQUENCY ERROR vs. TEMPERATURE.**

TEMP. (°C)	5MHz		LIMIT (ppm)
	FREQUENCY ERROR (ppm)		
	Low Channel	High Channel	
-30	-0.0146	-0.0145	2.5
-20	-0.0132	-0.0130	2.5
-10	-0.0119	-0.0117	2.5
0	-0.0096	-0.0093	2.5
10	-0.0073	-0.0070	2.5
20	-0.0061	-0.0059	2.5
30	-0.0049	-0.0046	2.5
40	-0.0027	-0.0024	2.5
50	-0.0010	-0.0007	2.5



Test Report No.: RF180829W002-6

**FREQUENCY ERROR VS. VOLTAGE**

VOLTAGE (Volts)	10MHz	LIMIT (ppm)
	FREQUENCY ERROR (ppm)	
	Channel 23330	
3.7	0.0025	2.5
3.4	-0.0026	2.5
4.2	0.0021	2.5

**NOTE:** The applicant defined the normal working voltage of the battery is from 3.4Vdc to 4.2Vdc.

**FREQUENCY ERROR vs. TEMPERATURE.**

TEMP. (°C)	10MHz	LIMIT (ppm)
	FREQUENCY ERROR (ppm)	
	Channel 23330	
-30	-0.0152	2.5
-20	-0.0138	2.5
-10	-0.0114	2.5
0	-0.0085	2.5
10	-0.0069	2.5
20	-0.0049	2.5
30	-0.0028	2.5
40	-0.0013	2.5
50	0.0006	2.5

**LTE BAND 26**

**FREQUENCY ERROR VS. VOLTAGE**

VOLTAGE (Volts)	1.4MHz		LIMIT (ppm)
	FREQUENCY ERROR (ppm)		
	Low Channel	High Channel	
3.7	0.0008	0.0009	2.5
3.4	-0.0009	-0.0010	2.5
4.2	0.0007	0.0008	2.5

**NOTE:** The applicant defined the normal working voltage of the battery is from 3.4Vdc to 4.2Vdc.

**FREQUENCY ERROR vs. TEMPERATURE.**

TEMP. (°C)	1.4MHz		LIMIT (ppm)
	FREQUENCY ERROR (ppm)		
	Low Channel	High Channel	
-30	-0.0057	-0.0052	2.5
-20	-0.0053	-0.0051	2.5
-10	-0.0051	-0.0044	2.5
0	-0.0046	-0.0040	2.5
10	-0.0037	-0.0040	2.5
20	-0.0030	-0.0035	2.5
30	-0.0024	-0.0023	2.5
40	-0.0023	-0.0012	2.5
50	-0.0003	-0.0002	2.5

**FREQUENCY ERROR VS. VOLTAGE**

VOLTAGE (Volts)	3MHz		LIMIT (ppm)
	FREQUENCY ERROR (ppm)		
	Low Channel	High Channel	
3.7	0.0008	0.0010	2.5
3.4	-0.0010	-0.0010	2.5
4.2	0.0010	0.0010	2.5

**NOTE:** The applicant defined the normal working voltage of the battery is from 3.4Vdc to 4.2Vdc.

**FREQUENCY ERROR vs. TEMPERATURE.**

TEMP. (°C)	3MHz		LIMIT (ppm)
	FREQUENCY ERROR (ppm)		
	Low Channel	High Channel	
-30	-0.0051	-0.0053	2.5
-20	-0.0050	-0.0050	2.5
-10	-0.0048	-0.0043	2.5
0	-0.0037	-0.0036	2.5
10	-0.0037	-0.0032	2.5
20	-0.0033	-0.0027	2.5
30	-0.0030	-0.0027	2.5
40	-0.0023	-0.0017	2.5
50	0.0000	0.0004	2.5



**FREQUENCY ERROR VS. VOLTAGE**

VOLTAGE (Volts)	5MHz		LIMIT (ppm)
	FREQUENCY ERROR (ppm)		
	Low Channel	High Channel	
3.7	0.0009	0.0011	2.5
3.4	-0.0012	-0.0011	2.5
4.2	0.0010	0.0010	2.5

**NOTE:** The applicant defined the normal working voltage of the battery is from 3.4Vdc to 4.2Vdc.

**FREQUENCY ERROR vs. TEMPERATURE.**

TEMP. (°C)	5MHz		LIMIT (ppm)
	FREQUENCY ERROR (ppm)		
	Low Channel	High Channel	
-30	-0.0058	-0.0056	2.5
-20	-0.0054	-0.0052	2.5
-10	-0.0049	-0.0044	2.5
0	-0.0040	-0.0038	2.5
10	-0.0036	-0.0035	2.5
20	-0.0035	-0.0028	2.5
30	-0.0031	-0.0027	2.5
40	-0.0014	-0.0018	2.5
50	-0.0005	-0.0004	2.5



Test Report No.: RF180829W002-6

**FREQUENCY ERROR VS. VOLTAGE**

VOLTAGE (Volts)	10MHz	LIMIT (ppm)
	FREQUENCY ERROR (ppm)	
	Channel 26740	
3.7	0.0010	2.5
3.4	-0.0011	2.5
4.2	-0.0009	2.5

**NOTE:** The applicant defined the normal working voltage of the battery is from 3.4Vdc to 4.2Vdc.

**FREQUENCY ERROR vs. TEMPERATURE.**

TEMP. (°C)	10MHz	LIMIT (ppm)
	FREQUENCY ERROR (ppm)	
	Channel 26740	
-30	-0.0054	2.5
-20	-0.0052	2.5
-10	-0.0046	2.5
0	-0.0044	2.5
10	-0.0034	2.5
20	-0.0029	2.5
30	-0.0026	2.5
40	-0.0021	2.5
50	-0.0004	2.5

### 3.3 OCCUPIED BANDWIDTH MEASUREMENT

#### 3.3.1 LIMITS OF OCCUPIED BANDWIDTH MEASUREMENT

The width of a frequency band such that, below the lower and above the upper frequency limits, the mean powers emitted are each equal to a specified percentage 0.5 %of the total mean power of a given emission.

#### 3.3.2 TEST SETUP

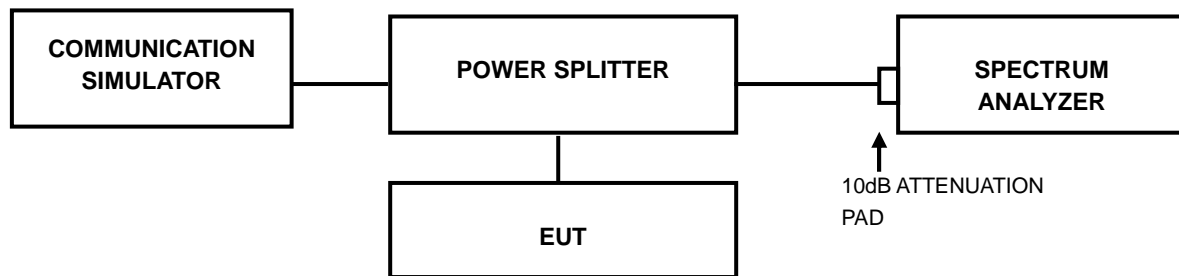

#### 3.3.3 TEST PROCEDURES

- The conducted occupied bandwidth used the power splitter via EUT RF power connector between simulation base station and spectrum analyzer.
- Use OBW measurement function of Spectrum analyzer to measure 99 % occupied bandwidth.

### 3.3.4 TEST RESULTS

CHANNEL	Frequency (MHz)	99% OCCUPIED Bandwidth (MHz)	CHANNEL	Frequency (MHz)	26dB Bandwidth (MHz)
		CDMA BC10			CDMA BC10
476	817.9	1.28	476	817.9	1.43
580	820.5	1.28	580	820.5	1.43
684	823.1	1.27	684	823.1	1.43

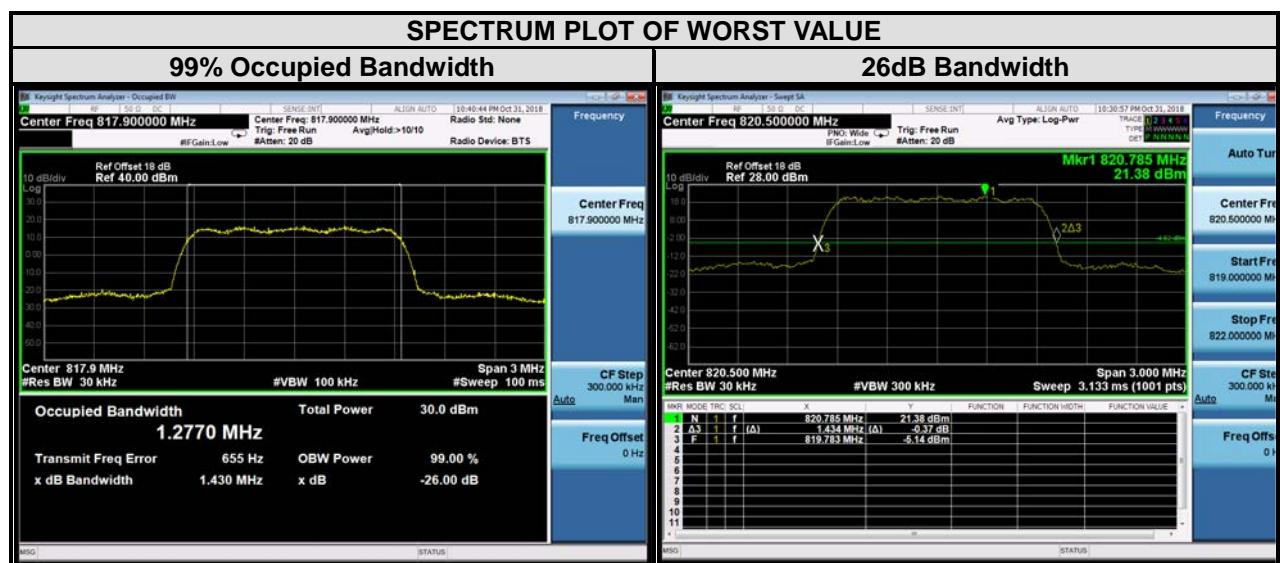



LTE BAND 14

CHANNEL BANDWIDTH: 5MHz				
CHANNEL	FREQUENCY (MHz)	99% OCCUPIED Bandwidth (MHz)		
		QPSK	16QAM	64QAM
23305	790.5	4.47	4.47	4.47
23330	793	4.47	4.47	4.47
23355	795.5	4.47	4.47	4.47





LTE BAND 14

CHANNEL BANDWIDTH: 10MHz				
CHANNEL	FREQUENCY (MHz)	99% OCCUPIED Bandwidth (MHz)		
		QPSK	16QAM	64QAM
-	-	-	-	-
23330	793	8.94	8.91	8.91
-	-	-	-	-



LTE BAND 26

CHANNEL BANDWIDTH: 1.4MHz				
CHANNEL	Frequency (MHz)	99% OCCUPIED Bandwidth (MHz)		
		QPSK	16QAM	64QAM
26697	814.7	1.08	1.08	1.08
26740	819	1.09	1.09	1.09
26783	823.3	1.09	1.09	1.08



**LTE BAND 26**

CHANNEL BANDWIDTH: 3MHz				
CHANNEL	Frequency (MHz)	99% OCCUPIED Bandwidth (MHz)		
		QPSK	16QAM	64QAM
26705	815.5	2.68	2.68	2.69
26740	819	2.68	2.68	2.69
26775	822.5	2.68	2.68	2.69







**BUREAU  
VERITAS**

Test Report No.: RF180829W002-6

**LTE BAND 26**

CHANNEL BANDWIDTH: 5MHz				
CHANNEL	Frequency (MHz)	99% OCCUPIED Bandwidth (MHz)		
		QPSK	16QAM	64QAM
26715	816.5	4.47	4.47	4.47
26740	819	4.47	4.47	4.47
26765	821.5	4.47	4.47	4.47





LTE BAND 26

CHANNEL BANDWIDTH: 10MHz				
CHANNEL	Frequency (MHz)	99% OCCUPIED Bandwidth (MHz)		
		QPSK	16QAM	64QAM
-	-	-	-	-
26740	819	8.92	8.89	8.91
-	-	-	-	-



### 3.4 EMISSION MASK MEASUREMENT

#### 3.4.1 LIMITS OF EMISSION MASK MEASUREMENT

According to FCC part 90.691 shall be tested the emission mask. For any frequency removed from the EA licensee's frequency block by up to and including 37.5 kHz, the power of any emission shall be attenuated below the transmitter power (P) in watts by at least  $116 \text{ Log}_{10}(f/6.1)$  decibels or  $50 + 10 \text{ Log}_{10}(P)$  decibels or 80 decibels, whichever is the lesser attenuation, where f is the frequency removed from the center of the outer channel in the block in kilohertz and where f is greater than 12.5 kHz.

#### 3.4.2 TEST SETUP

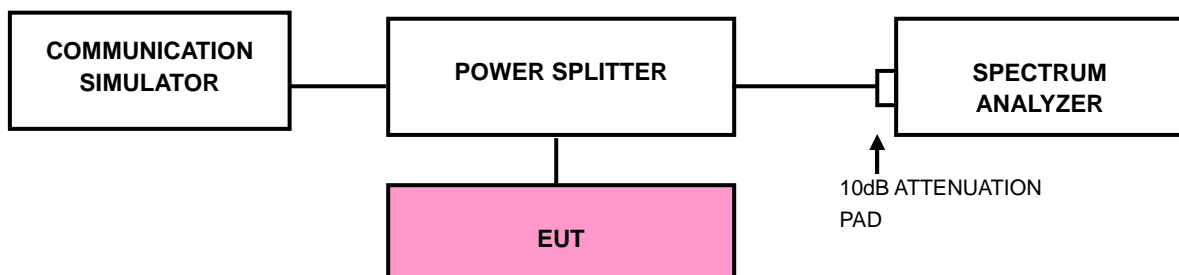



### 3.4.3 TEST PROCEDURES

- a. The EUT was set up for the maximum peak power with LTE link data modulation. The power was measured with R&S Spectrum Analyzer. All measurements were done at 2 channels (low and high operational frequency range.).
- b. The band edge measurement used the power splitter via EUT RF power connector between simulation base station and spectrum analyzer.
- c. The center frequency of spectrum is the band edge frequency and span is 10MHz. RBW of the spectrum is 100kHz and VBW of the spectrum is 300kHz (CDMA).
- d. The center frequency of spectrum is the band edge frequency and span is 1~5 MHz. RBW of the spectrum is 20kHz and VBW of the spectrum is 100 kHz. (LTE bandwidth 1.4MHz)
- e. The center frequency of spectrum is the band edge frequency and span is 1~5 MHz. RBW of the spectrum is 30kHz and VBW of the spectrum is 100kHz. (LTE bandwidth 3MHz)
- f. The center frequency of spectrum is the band edge frequency and span is 1~5 MHz. RBW of the spectrum is 50kHz and VBW of the spectrum is 200kHz. (LTE bandwidth 5MHz)
- g. The center frequency of spectrum is the band edge frequency and span is 1~5 MHz. RBW of the spectrum is 100kHz and VBW of the spectrum is 300kHz. (LTE bandwidth 10MHz)
- h. Record the max trace plot into the test report.



### 3.4.4 TEST RESULTS

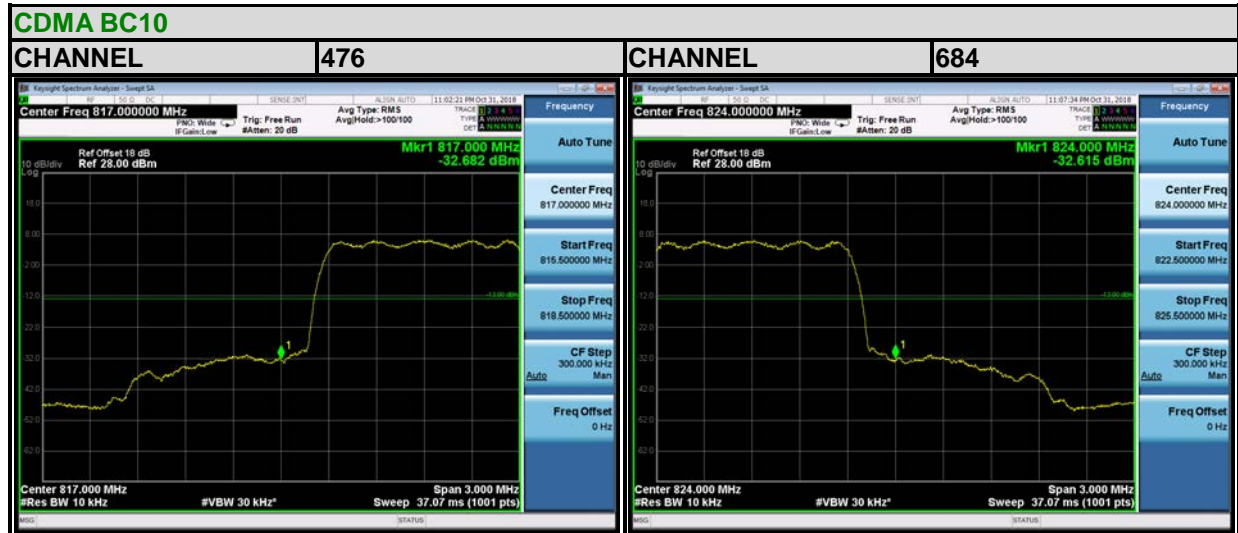



Test Report No.: RF180829W002-6

LTE BAND 14





BUREAU  
VERITAS

Test Report No.: RF180829W002-6

LTE BAND 14





BUREAU VERITAS

# Test Report No.: RF180829W002-6

## LTE BAND 26







BUREAU VERITAS

Test Report No.: RF180829W002-6

LTE BAND 26

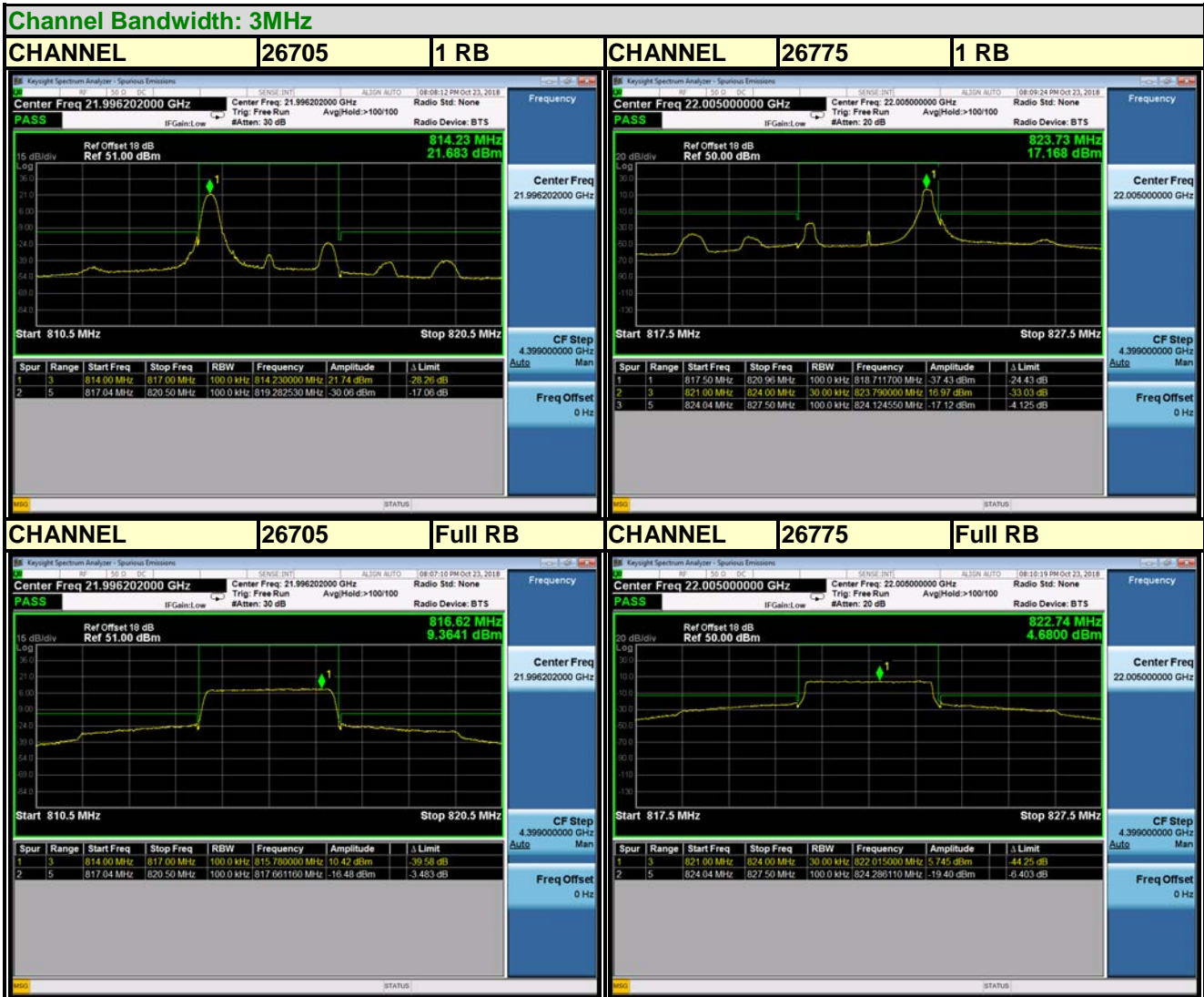



BUREAU VERITAS

Test Report No.: RF180829W002-6

LTE BAND 26





LTE BAND 26



### 3.5 CONDUCTED SPURIOUS EMISSIONS

#### 3.5.1 LIMITS OF CONDUCTED SPURIOUS EMISSIONS MEASUREMENT

The power of any emission outside a licensee's frequency block shall be attenuated below the transmitter power (P) by at least  $43 + 10 \log_{10}(P)$  dB. The limit of emission equal to  $-13\text{dBm}$

#### 3.5.2 TEST PROCEDURE

- a. The EUT makes a phone call to the communication simulator. All measurements were done at middle operational frequency range.
- b. Measuring frequency range is from 30 MHz to 9GHz. 10dB attenuation pad is connected with spectrum. RBW=1MHz and VBW=3MHz are used for conducted emission measurement.

#### 3.5.3 TEST SETUP

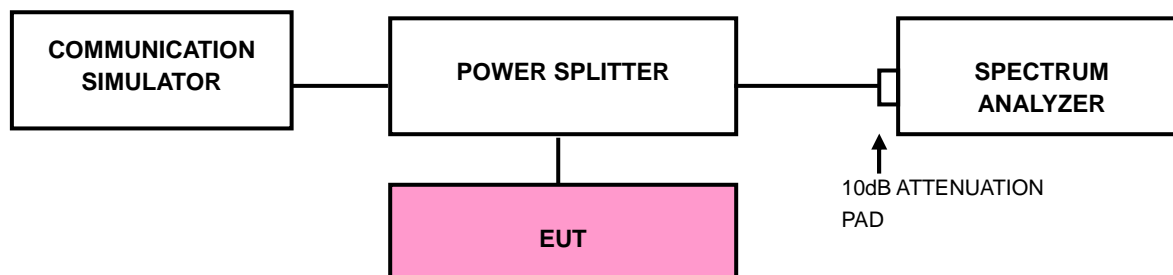

### 3.5.4 TEST RESULTS

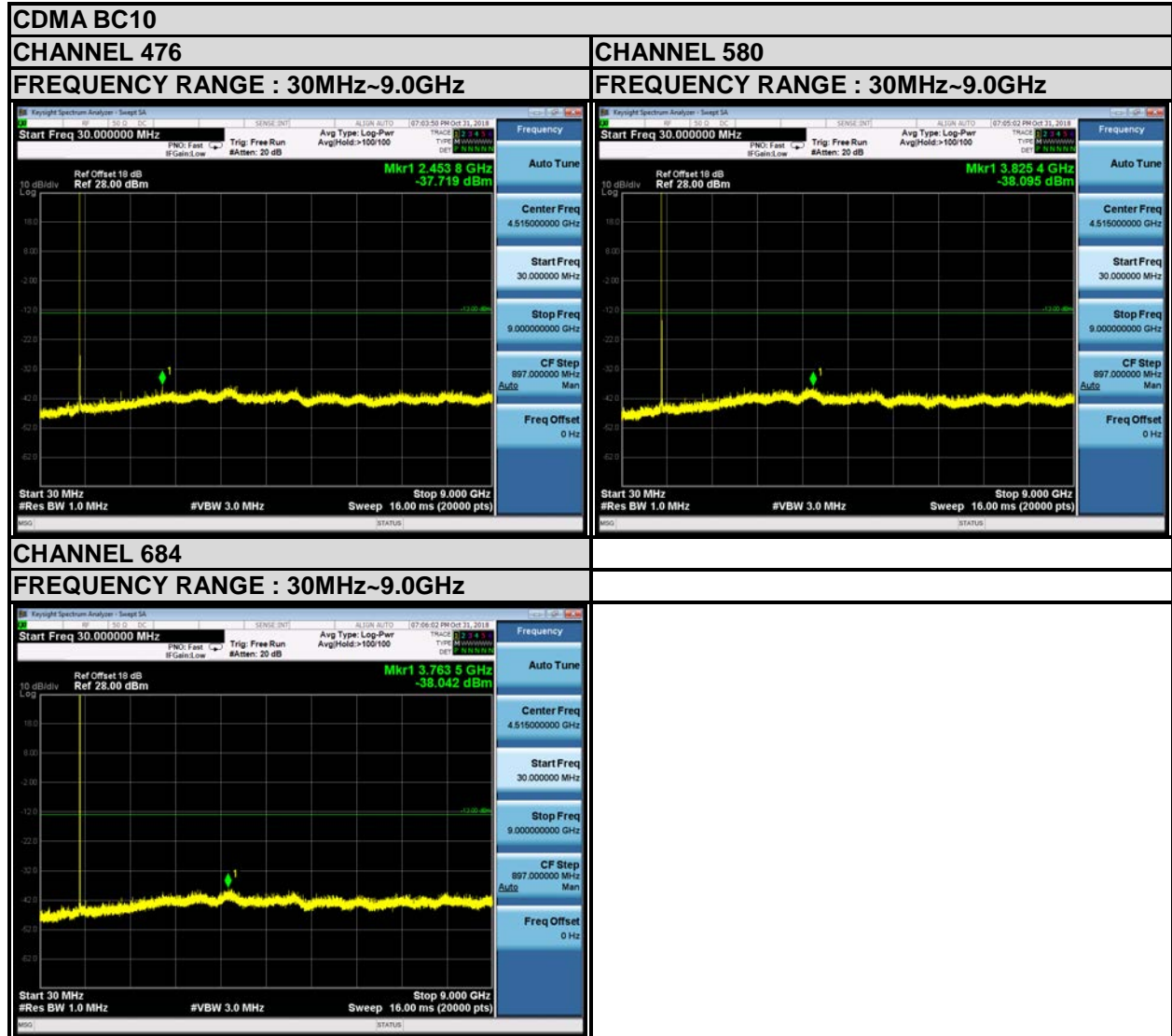



BUREAU VERITAS

Test Report No.: RF180829W002-6

LTE Band 14

5MHz / QPSK

CHANNEL 23305

FREQUENCY RANGE : 30MHz~7.85GHz

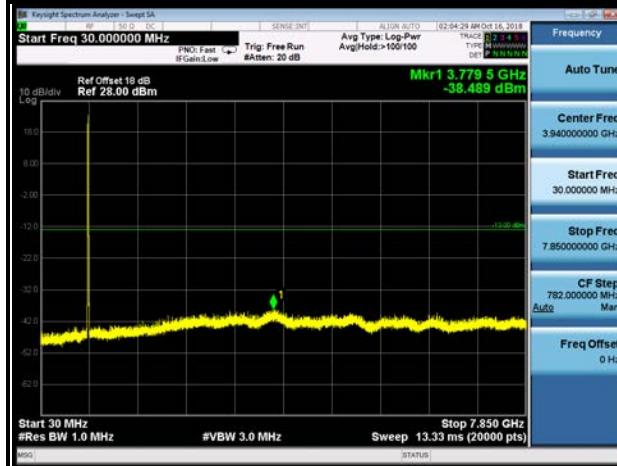

CHANNEL 23330

FREQUENCY RANGE : 30MHz~7.85GHz

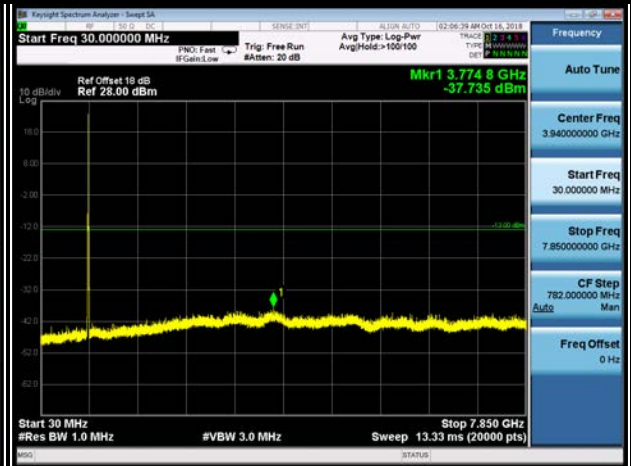

CHANNEL 23355

FREQUENCY RANGE : 30MHz~7.85GHz

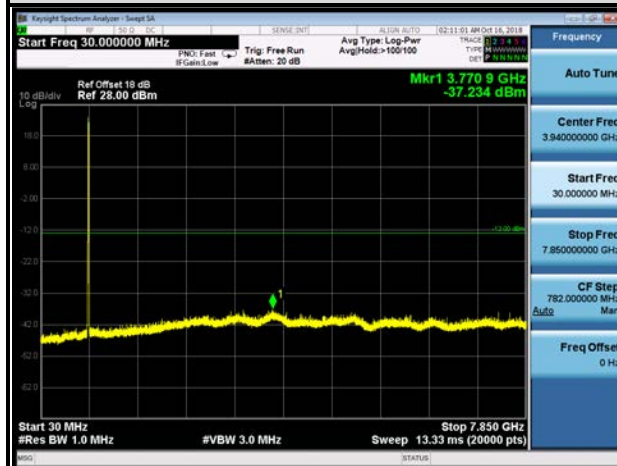



BUREAU  
VERITAS

Test Report No.: RF180829W002-6

10MHz / QPSK

CHANNEL 23330

FREQUENCY RANGE : 30MHz~7.85GHz

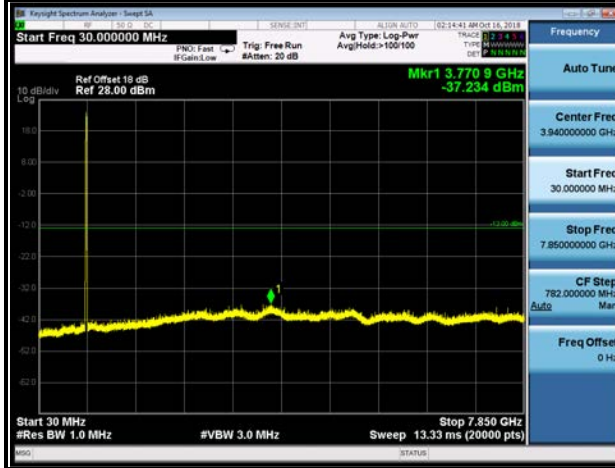



BUREAU VERITAS

Test Report No.: RF180829W002-6

LTE BAND 26

1.4MHz / QPSK

CHANNEL 26697

FREQUENCY RANGE : 30MHz~9GHz

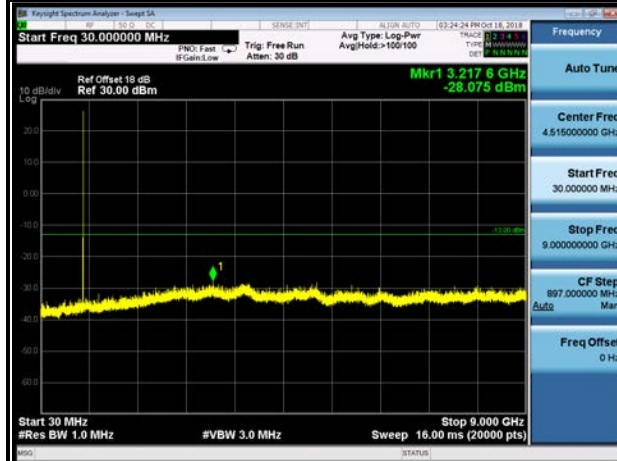

CHANNEL 26740

FREQUENCY RANGE : 30MHz~9GHz

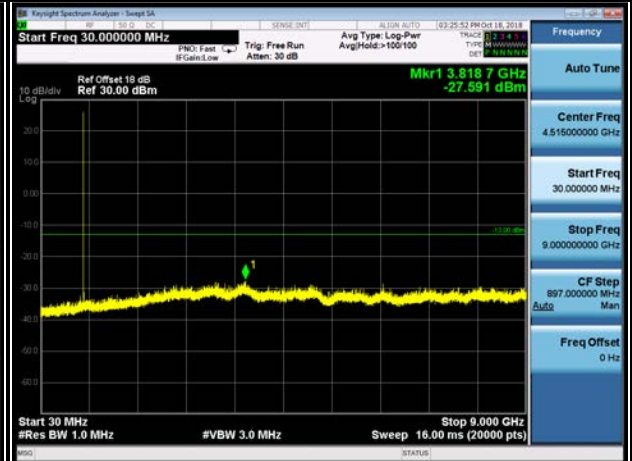

CHANNEL 26783

FREQUENCY RANGE : 30MHz~9GHz

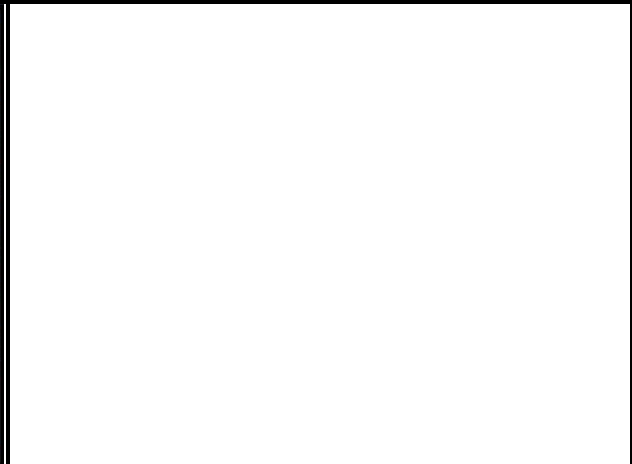
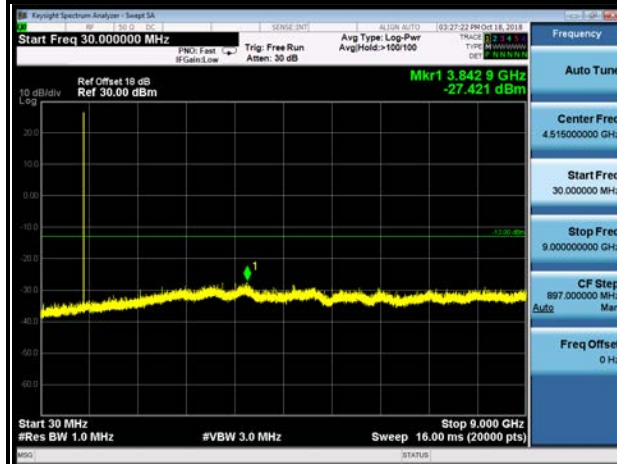





BUREAU VERITAS

Test Report No.: RF180829W002-6

3MHz / QPSK

CHANNEL 26705

FREQUENCY RANGE : 30MHz~9GHz

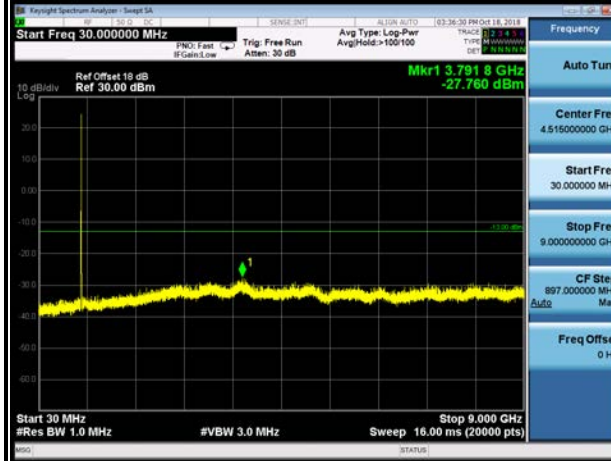

CHANNEL 26740

FREQUENCY RANGE : 30MHz~9GHz

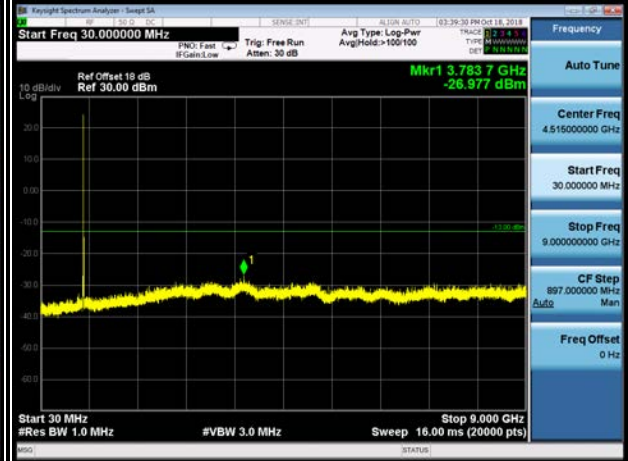

CHANNEL 26775

FREQUENCY RANGE : 30MHz~9GHz

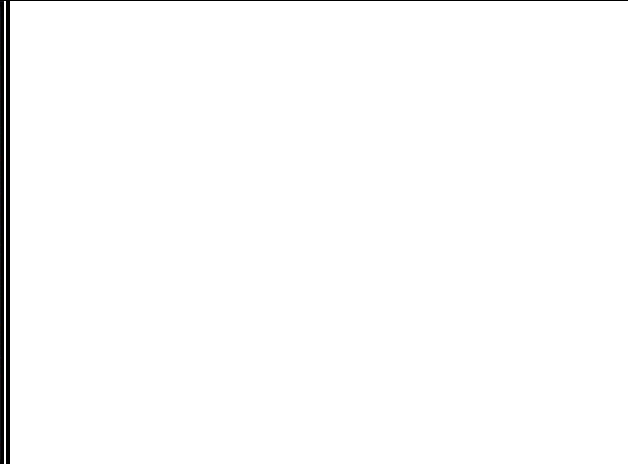
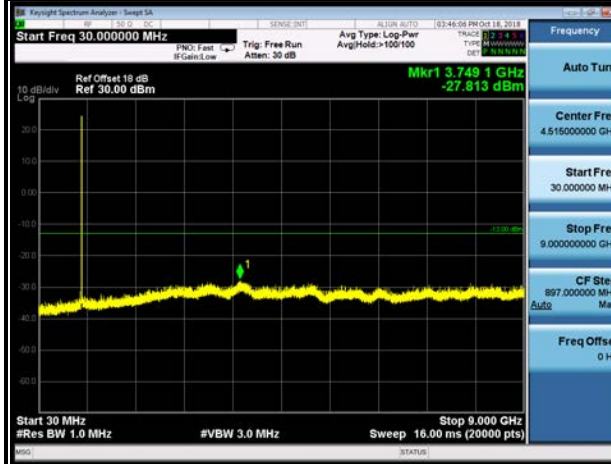



BUREAU VERITAS

Test Report No.: RF180829W002-6





BUREAU VERITAS

Test Report No.: RF180829W002-6

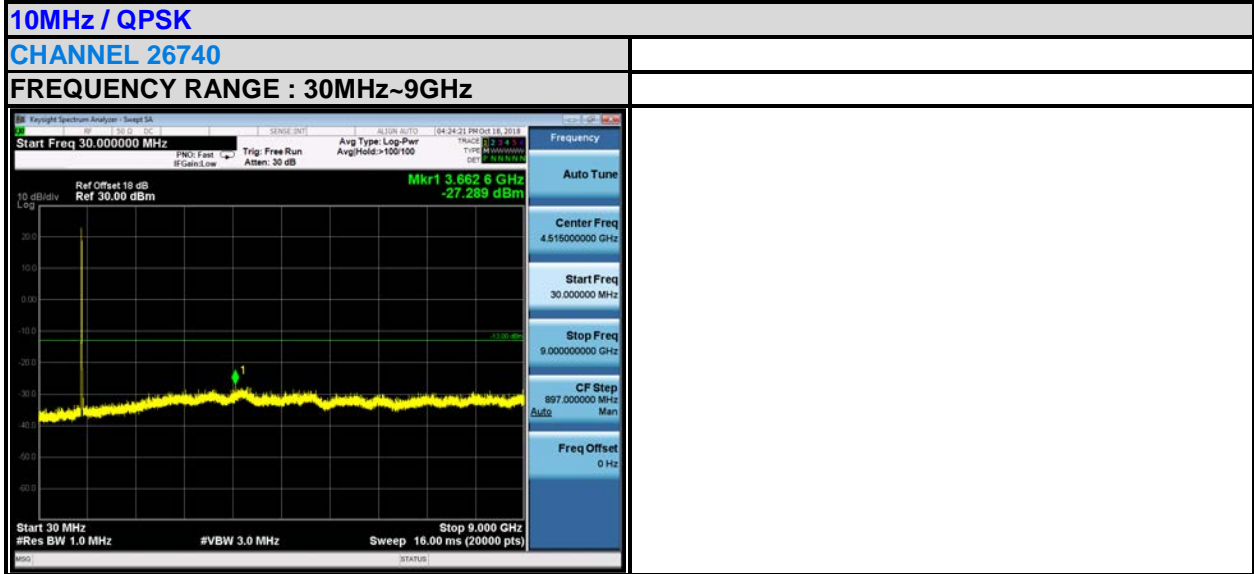



### 3.6 RADIATED EMISSION MEASUREMENT

#### 3.6.1 LIMITS OF RADIATED EMISSION MEASUREMENT

(1) The power of any emission outside a licensee's frequency block shall be attenuated below the transmitter power (P) by at least  $43 + 10 \log_{10}(P)$  dB. The limit of emission equal to  $-13\text{dBm}$

(2) For operations in the 763–775 MHz and 793–805 MHz bands, all emissions including harmonics in the band 1559–1610 MHz shall be limited to  $-70\text{ dBW/MHz}$  equivalent isotropically radiated power (EIRP) for wideband signals, and  $-80\text{ dBW}$  EIRP for discrete emissions of less than 700 Hz bandwidth. For the purpose of equipment authorization, a transmitter shall be tested with an antenna that is representative of the type that will be used with the equipment in normal operation.

#### 3.6.2 TEST PROCEDURES

- a. Substitution method is used for E.I.R.P measurement. In the semi-anechoic chamber, EUT placed on the 0.8m height of Turn Table, rotated the table around 360 degrees to search the maximum radiation power and receiver antenna shall be rotated vertical and horizontal polarization and moved height from 1m to 4m to find the maximum polar radiated power. The “Read Value” is the spectrum reading the maximum power value.
- b. The substitution horn antenna is substituted for EUT at the same position and signals generator export the CW signal to the substitution antenna via a TX cable. Rotated the Turn Table and moved receiving antenna to find the maximum radiation power. Adjust output power level of S.G to get a Value of spectrum reading equal to “Read Value” of step a. Record the power level of S.G
- c.  $\text{EIRP} = \text{Output power level of S.G} - \text{TX cable loss} + \text{Antenna gain of substitution horn.}$
- d. E.R.P power can be calculated form E.I.R.P power by subtracting the gain of dipole,  $\text{E.R.P power} = \text{E.I.P.R power} - 2.15\text{dBi.}$

**NOTE:** The resolution bandwidth of spectrum analyzer is 1 MHz and the video bandwidth is 3 MHz.

#### 3.6.3 DEVIATION FROM TEST STANDARD

No deviation

### 3.6.4 TEST SETUP

#### <Below 30MHz>

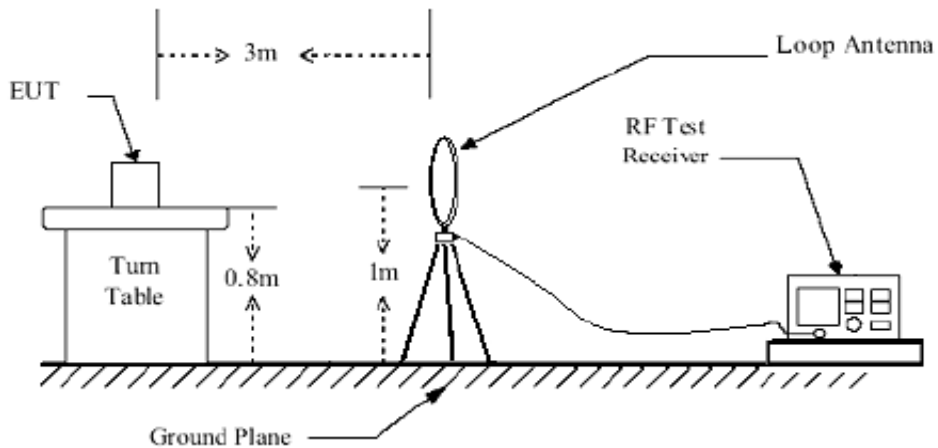

#### < Frequency Range 30MHz~1GHz >

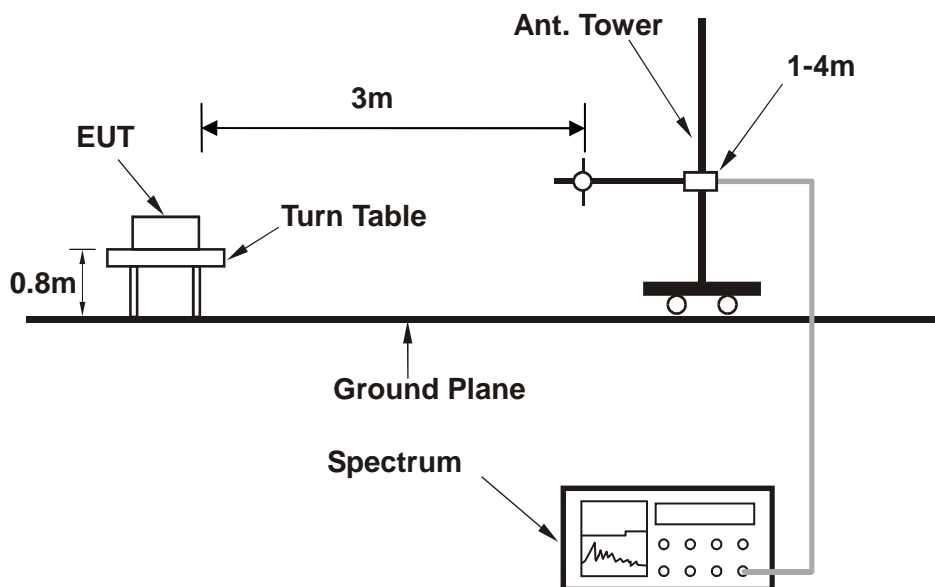

< Frequency Range above 1GHz >

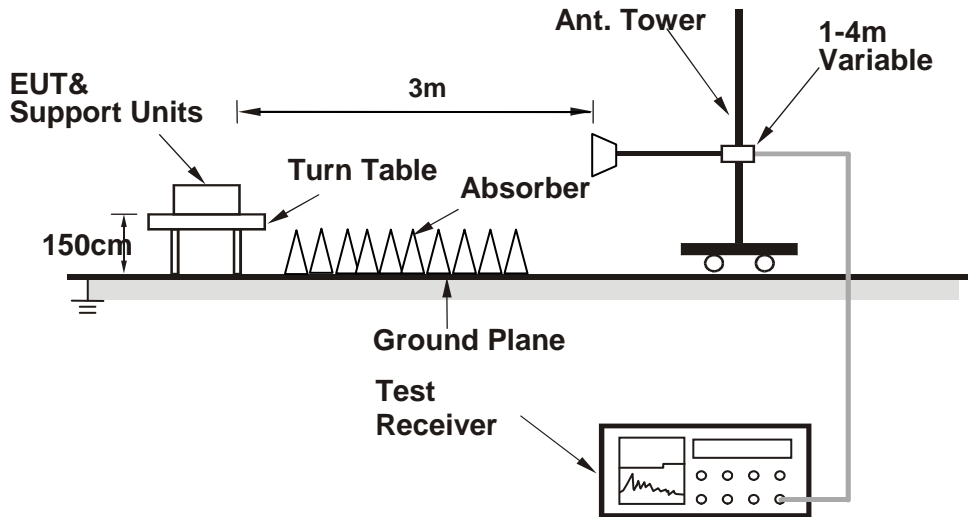

For the actual test configuration, please refer to the attached file (Test Setup Photo).



### 3.6.5 TEST RESULTS

#### BELOW 1GHz WORST-CASE DATA

**9 KHz – 30 MHz data:** the amplitude of spurious emissions attenuated more than 20 dB below the permissible value is not required in the report.

**30 MHz – 1GHz data:**

**CDMA BC10:**

<b>MODE</b>	TX channel 580	<b>FREQUENCY RANGE</b>	Below 1000MHz
<b>ENVIRONMENTAL CONDITIONS</b>	23deg. C, 70%RH	<b>INPUT POWER</b>	DC 5V from adapter
<b>TESTED BY</b>	Rose Ma		
<b>ANTENNA POLARITY &amp; TEST DISTANCE: HORIZONTAL AT 3 M</b>			

	Freq	Level	Read Level	Limit Line	Over Limit	Factor	Remark	Pol/Phase
	MHz	dBm/m	dBm	dBm/m	dB	dB/m		
1	51.480	-38.57	-40.16	-13.00	-25.57	1.59	Peak	Horizontal
2	99.870	-50.88	-39.76	-13.00	-37.88	-11.12	Peak	Horizontal
3	185.690	-54.20	-36.59	-13.00	-41.20	-17.61	Peak	Horizontal
4	215.240	-58.79	-41.85	-13.00	-45.79	-16.94	Peak	Horizontal
5	321.540	-58.41	-45.32	-13.00	-45.41	-13.09	Peak	Horizontal
6	425.680	-59.69	-49.25	-13.00	-46.69	-10.44	Peak	Horizontal

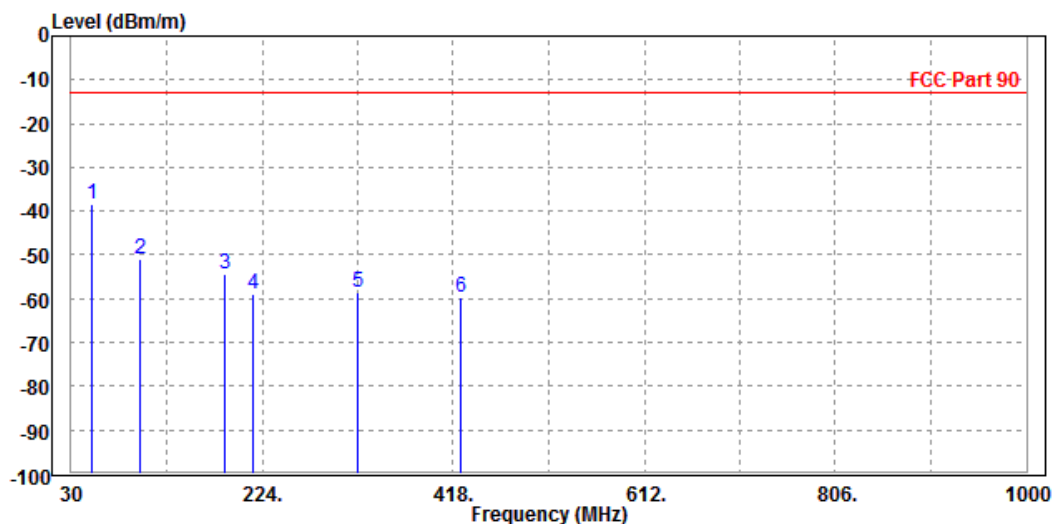



Test Report No.: RF180829W002-6

<b>MODE</b>	TX channel 580	<b>FREQUENCY RANGE</b>	Below 1000MHz
<b>ENVIRONMENTAL CONDITIONS</b>	23deg. C, 70%RH	<b>INPUT POWER</b>	DC 5V from adapter
<b>TESTED BY</b>	Rose Ma		
<b>ANTENNA POLARITY &amp; TEST DISTANCE: VERTICAL AT 3 M</b>			

	Freq	Level	Read Level	Limit Line	Over Limit	Factor	Remark	Pol/Phase	
	MHz	dBm/m	dBm	dBm/m	dB	dB/m			
1	PP	57.150	-42.35	-32.16	-13.00	-29.35	-10.19	Peak	Vertical
2		115.260	-61.05	-48.36	-13.00	-48.05	-12.69	Peak	Vertical
3		165.570	-57.53	-42.85	-13.00	-44.53	-14.68	Peak	Vertical
4		171.250	-59.78	-45.69	-13.00	-46.78	-14.09	Peak	Vertical
5		315.650	-53.02	-41.78	-13.00	-40.02	-11.24	Peak	Vertical
6		512.650	-57.52	-50.26	-13.00	-44.52	-7.26	Peak	Vertical

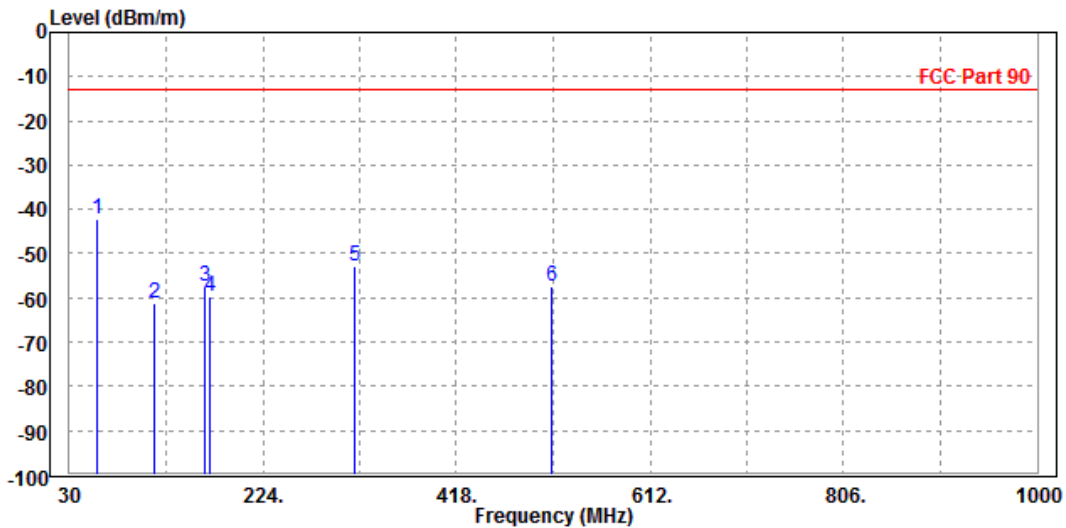





Test Report No.: RF180829W002-6

**ABOVE 1GHz**

**Note:** For higher frequency, the emission is too low to be detected.

**CDMA BC10**

**CH 476:**

<b>MODE</b>	TX channel 476	<b>FREQUENCY RANGE</b>	Above 1000MHz
<b>ENVIRONMENTAL CONDITIONS</b>	23deg. C, 70%RH	<b>INPUT POWER</b>	DC 5V from adapter
<b>TESTED BY</b>	Rose Ma		
<b>ANTENNA POLARITY &amp; TEST DISTANCE: HORIZONTAL AT 3 M</b>			

	Freq	Level	Read Level	Limit Line	Over Limit	Factor	Remark	Pol/Phase
	MHz	dBm/m	dBm	dBm/m	dB	dB/m		
1	1636.000	-45.85	-40.78	-13.00	-32.85	-5.07	Peak	Horizontal
2 PP	2455.000	-40.58	-38.91	-13.00	-27.58	-1.67	Peak	Horizontal

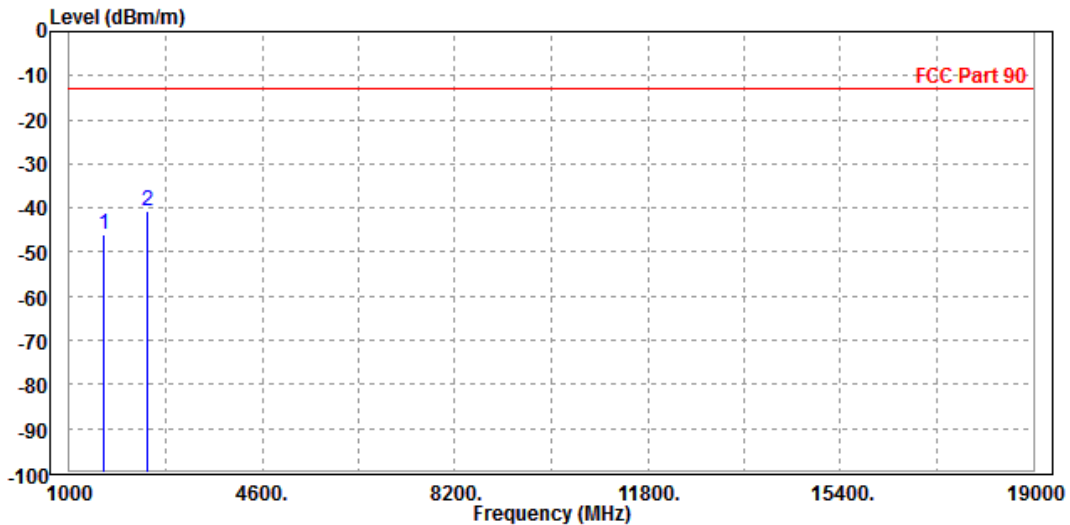



Test Report No.: RF180829W002-6

<b>MODE</b>	TX channel 476	<b>FREQUENCY RANGE</b>	Above 1000MHz
<b>ENVIRONMENTAL CONDITIONS</b>	23deg. C, 70%RH	<b>INPUT POWER</b>	DC 5V from adapter
<b>TESTED BY</b>	Rose Ma		
<b>ANTENNA POLARITY &amp; TEST DISTANCE: VERTICAL AT 3 M</b>			

	Freq	Level	Read Level	Limit Line	Over Limit	Factor	Remark	Pol/Phase
	MHz	dBm/m	dBm	dBm/m	dB	dB/m		
1	1636.000	-47.89	-44.23	-13.00	-34.89	-3.66	Peak	Vertical
2 PP	2455.000	-42.44	-42.26	-13.00	-29.44	-0.18	Peak	Vertical

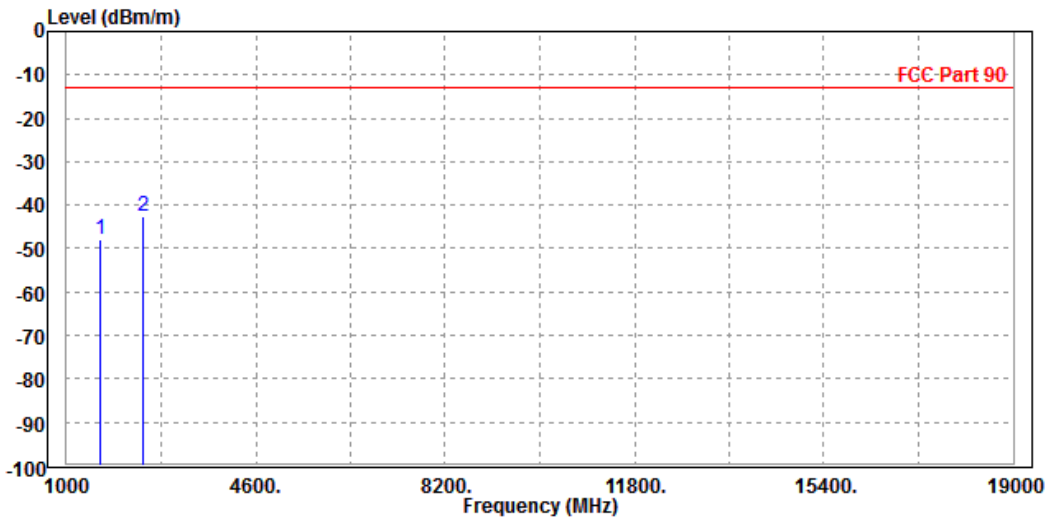



Test Report No.: RF180829W002-6

CH 580:

<b>MODE</b>	TX channel 580	<b>FREQUENCY RANGE</b>	Above 1000MHz
<b>ENVIRONMENTAL CONDITIONS</b>	23deg. C, 70%RH	<b>INPUT POWER</b>	DC 5V from adapter
<b>TESTED BY</b>	Rose Ma		
<b>ANTENNA POLARITY &amp; TEST DISTANCE: HORIZONTAL AT 3 M</b>			

	Freq	Level	Read Level	Limit Line	Over Limit	Factor	Remark	Pol/Phase
	MHz	dBm/m	dBm	dBm/m	dB	dB/m		
1	1640.000	-45.28	-40.25	-13.00	-32.28	-5.03	Peak	Horizontal
2 PP	2460.000	-42.53	-40.86	-13.00	-29.53	-1.67	Peak	Horizontal

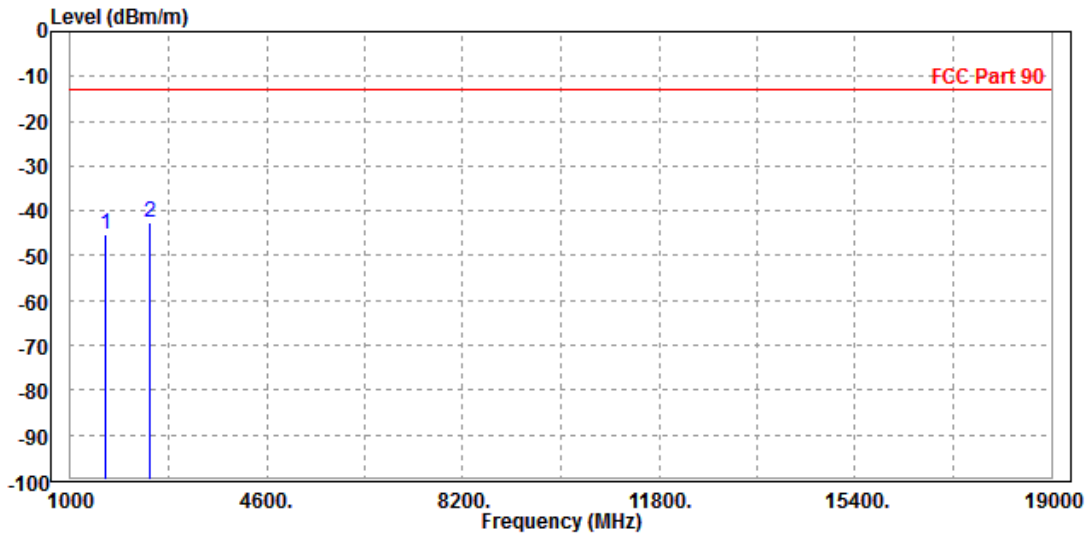



Test Report No.: RF180829W002-6

<b>MODE</b>	TX channel 580	<b>FREQUENCY RANGE</b>	Above 1000MHz
<b>ENVIRONMENTAL CONDITIONS</b>	23deg. C, 70%RH	<b>INPUT POWER</b>	DC 5V from adapter
<b>TESTED BY</b>	Rose Ma		
<b>ANTENNA POLARITY &amp; TEST DISTANCE: VERTICAL AT 3 M</b>			

	Freq	Level	Read Level	Limit Line	Over Limit	Factor	Remark	Pol/Phase
	MHz	dBm/m	dBm	dBm/m	dB	dB/m		
1	1640.000	-44.04	-40.42	-13.00	-31.04	-3.62	Peak	Vertical
2 PP	2460.000	-40.70	-40.53	-13.00	-27.70	-0.17	Peak	Vertical

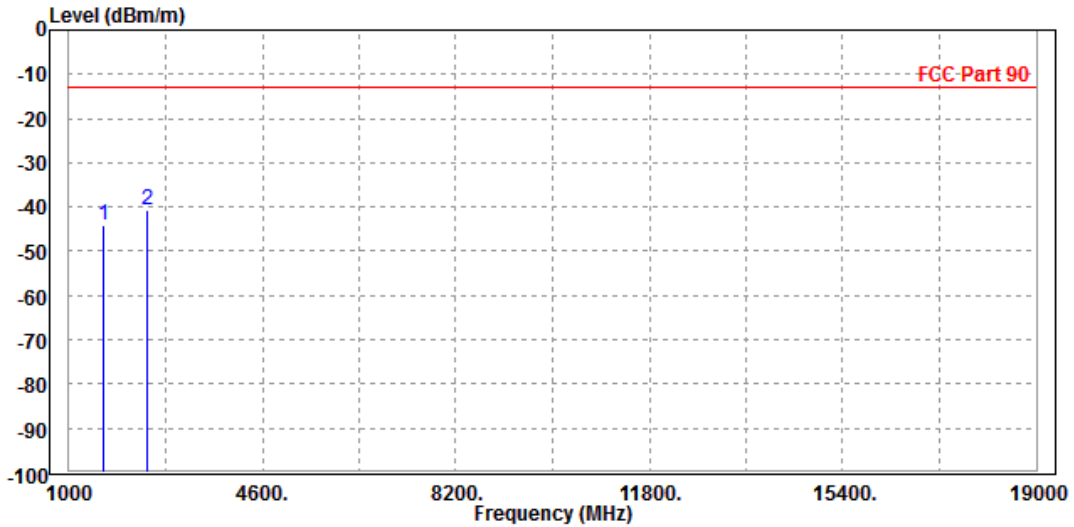



Test Report No.: RF180829W002-6

CH 684:

<b>MODE</b>	TX channel 684	<b>FREQUENCY RANGE</b>	Above 1000MHz
<b>ENVIRONMENTAL CONDITIONS</b>	23deg. C, 70%RH	<b>INPUT POWER</b>	DC 5V from adapter
<b>TESTED BY</b>	Rose Ma		
<b>ANTENNA POLARITY &amp; TEST DISTANCE: HORIZONTAL AT 3 M</b>			

	Freq	Level	Read Level	Limit Line	Over Limit	Factor	Remark	Pol/Phase
	MHz	dBm/m	dBm	dBm/m	dB	dB/m		
1	1646.000	-44.29	-39.31	-13.00	-31.29	-4.98	Peak	Horizontal
2 PP	2468.000	-39.55	-37.89	-13.00	-26.55	-1.66	Peak	Horizontal

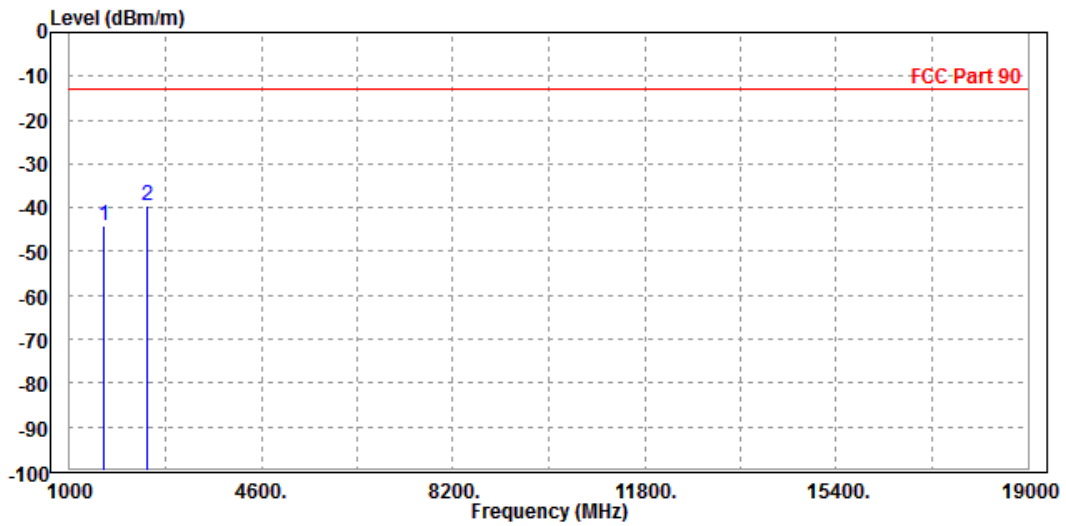



Test Report No.: RF180829W002-6

<b>MODE</b>	TX channel 684	<b>FREQUENCY RANGE</b>	Above 1000MHz
<b>ENVIRONMENTAL CONDITIONS</b>	23deg. C, 70%RH	<b>INPUT POWER</b>	DC 5V from adapter
<b>TESTED BY</b>	Rose Ma		
<b>ANTENNA POLARITY &amp; TEST DISTANCE: VERTICAL AT 3 M</b>			

	Freq	Level	Read Level	Limit Line	Over Limit	Factor	Remark	Pol/Phase
	MHz	dBm/m	dBm	dBm/m	dB	dB/m		
1	1646.000	-47.72	-44.15	-13.00	-34.72	-3.57	Peak	Vertical
2 PP	2468.000	-40.52	-40.35	-13.00	-27.52	-0.17	Peak	Vertical

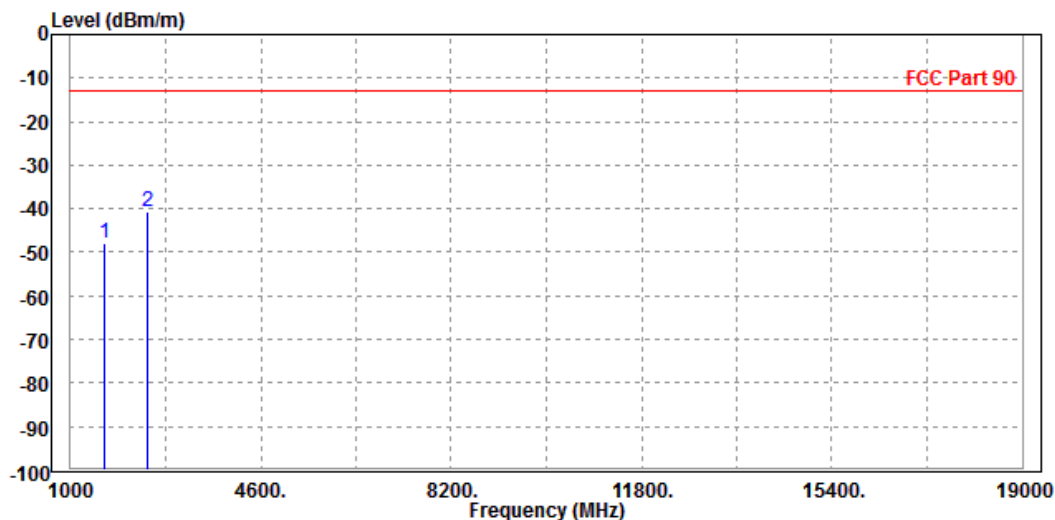



Test Report No.: RF180829W002-6

LTE BAND 14

CHANNEL BANDWIDTH: 5MHz / QPSK

MODE	TX channel 23330	FREQUENCY RANGE	Above 1000MHz
ENVIRONMENTAL CONDITIONS	23deg. C, 70%RH	INPUT POWER	DC 5V from adapter
TESTED BY	Rose Ma		
ANTENNA POLARITY & TEST DISTANCE: HORIZONTAL AT 3 M			

	Freq	Level	Read Level	Limit Line	Over Limit	Factor	Remark	Pol/Phase
	MHz	dBm/m	dBm	dBm/m	dB	dB/m		
1	1598.000	-60.96	-55.58	-13.00	-47.96	-5.38	Peak	Horizontal
2 PP	2379.000	-57.83	-56.10	-13.00	-44.83	-1.73	Peak	Horizontal

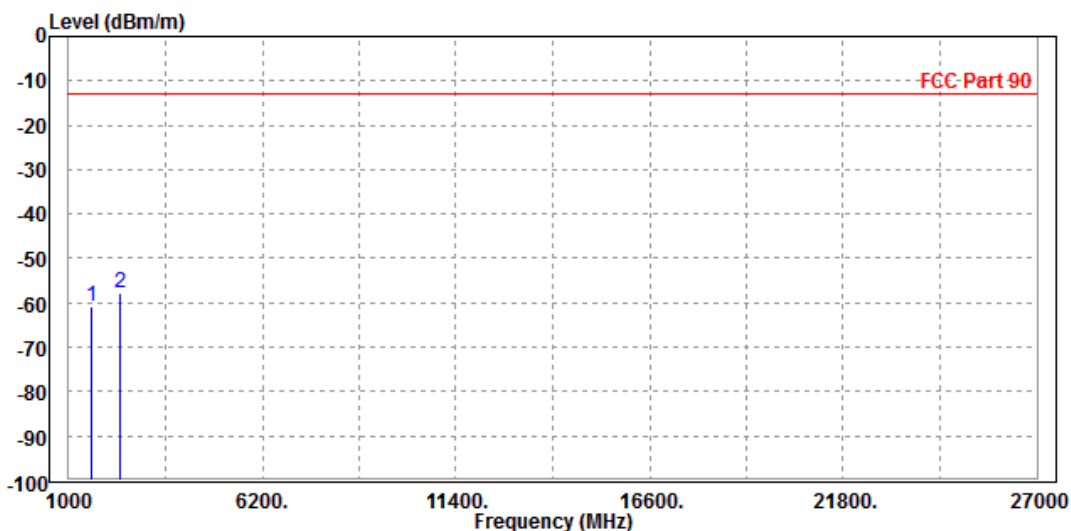



Test Report No.: RF180829W002-6

<b>MODE</b>	TX channel 23330	<b>FREQUENCY RANGE</b>	Above 1000MHz
<b>ENVIRONMENTAL CONDITIONS</b>	23deg. C, 70%RH	<b>INPUT POWER</b>	DC 5V from adapter
<b>TESTED BY</b>	Rose Ma		
<b>ANTENNA POLARITY &amp; TEST DISTANCE: VERTICAL AT 3 M</b>			

	Freq	Level	Read Level	Limit Line	Over Limit	Factor	Remark	Pol/Phase
	MHz	dBm/m	dBm	dBm/m	dB	dB/m		
1	1598.000	-60.95	-56.93	-13.00	-47.95	-4.02	Peak	Vertical
2 PP	2379.000	-57.21	-57.02	-13.00	-44.21	-0.19	Peak	Vertical

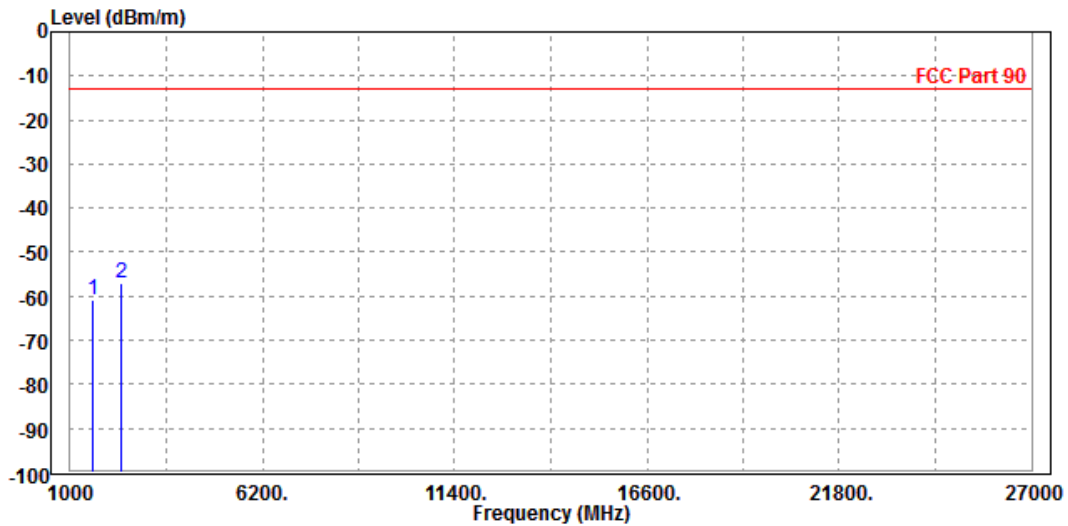





Test Report No.: RF180829W002-6

CHANNEL BANDWIDTH: 10MHz / QPSK

MODE	TX channel 23330	FREQUENCY RANGE	Above 1000MHz
ENVIRONMENTAL CONDITIONS	23deg. C, 70%RH	INPUT POWER	DC 5V from adapter
TESTED BY	Rose Ma		
ANTENNA POLARITY & TEST DISTANCE: HORIZONTAL AT 3 M			

	Freq	Level	Read Level	Limit Line	Over Limit	Factor	Remark	Pol/Phase
	MHz	dBm/m	dBm	dBm/m	dB	dB/m		
1	1598.000	-55.90	-50.52	-13.00	-42.90	-5.38	Peak	Horizontal
2 PP	2379.000	-44.21	-42.48	-13.00	-31.21	-1.73	Peak	Horizontal

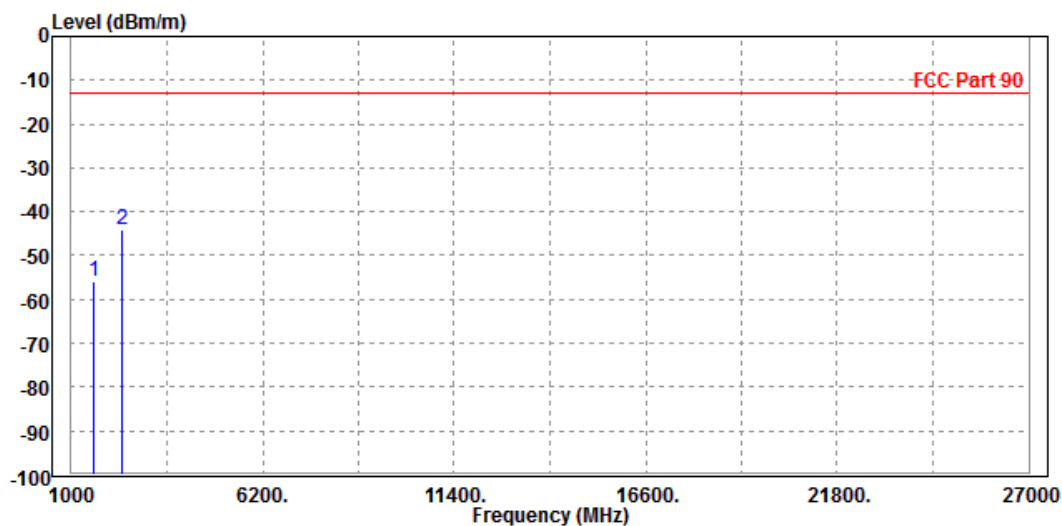



Test Report No.: RF180829W002-6

<b>MODE</b>	TX channel 23330	<b>FREQUENCY RANGE</b>	Above 1000MHz
<b>ENVIRONMENTAL CONDITIONS</b>	23deg. C, 70%RH	<b>INPUT POWER</b>	DC 5V from adapter
<b>TESTED BY</b>	Rose Ma		
<b>ANTENNA POLARITY &amp; TEST DISTANCE: VERTICAL AT 3 M</b>			

	Freq	Level	Read Level	Limit Line	Over Limit	Factor	Remark	Pol/Phase
	MHz	dBm/m	dBm	dBm/m	dB	dB/m		
1	1598.000	-55.95	-51.93	-13.00	-42.95	-4.02	Peak	Vertical
2 PP	2379.000	-46.43	-46.24	-13.00	-33.43	-0.19	Peak	Vertical

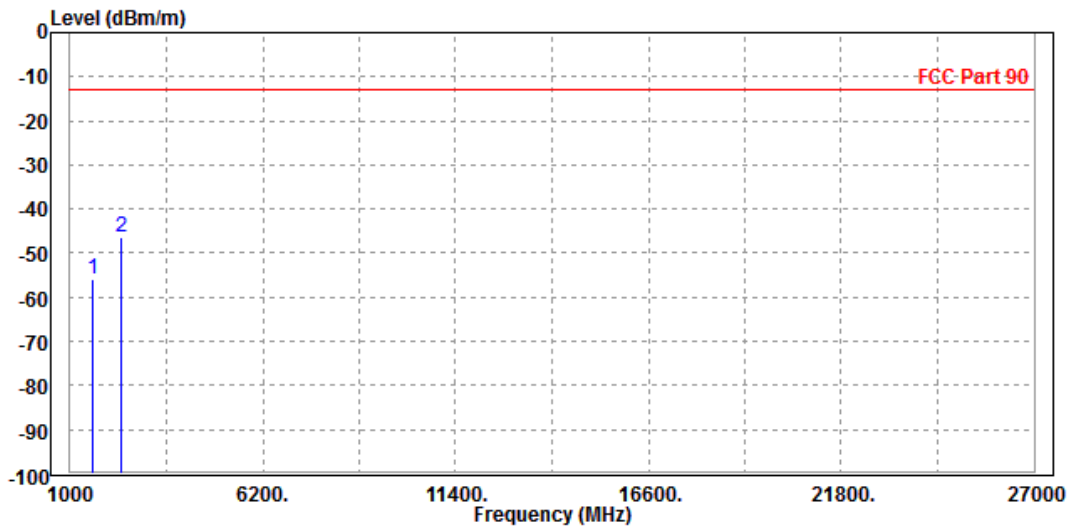



Test Report No.: RF180829W002-6

LTE BAND 26

CHANNEL BANDWIDTH: 1.4MHz / QPSK

CH 26697

MODE	TX channel 26697	FREQUENCY RANGE	Above 1000MHz
ENVIRONMENTAL CONDITIONS	23deg. C, 70%RH	INPUT POWER	DC 5V from adapter
TESTED BY	Rose Ma		
ANTENNA POLARITY & TEST DISTANCE: HORIZONTAL AT 3 M			

	Freq	Level	Read Level	Limit Line	Over Limit	Factor	Remark	Pol/Phase
	MHz	dBm/m	dBm	dBm/m	dB	dB/m		
1	1650.120	-61.20	-56.25	-13.00	-48.20	-4.95	Peak	Horizontal
2	PP 2493.000	-59.20	-57.56	-13.00	-46.20	-1.64	Peak	Horizontal

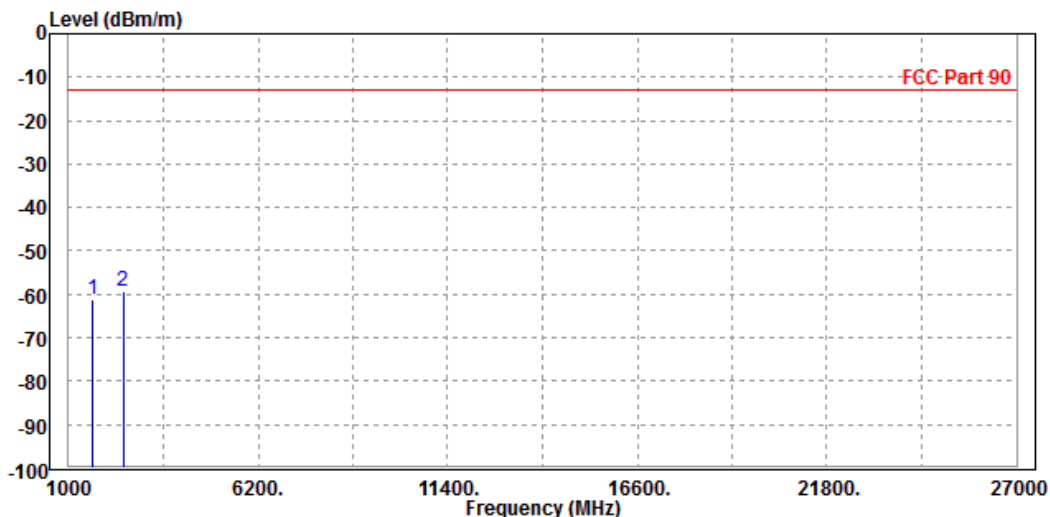



Test Report No.: RF180829W002-6

<b>MODE</b>	TX channel 26697	<b>FREQUENCY RANGE</b>	Above 1000MHz
<b>ENVIRONMENTAL CONDITIONS</b>	23deg. C, 70%RH	<b>INPUT POWER</b>	DC 5V from adapter
<b>TESTED BY</b>	Rose Ma		
<b>ANTENNA POLARITY &amp; TEST DISTANCE: VERTICAL AT 3 M</b>			

	Freq	Level	Read Level	Limit Line	Over Limit	Factor	Remark	Pol/Phase
	MHz	dBm/m	dBm	dBm/m	dB	dB/m		
1	1650.120	-53.21	-49.68	-13.00	-40.21	-3.53	Peak	Vertical
2 PP	2493.000	-48.86	-48.69	-13.00	-35.86	-0.17	Peak	Vertical

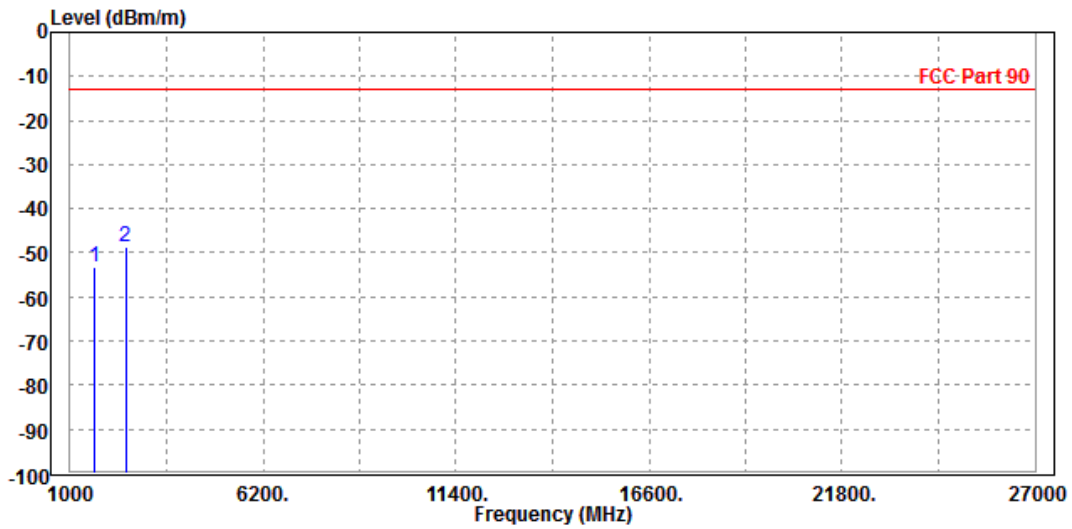



Test Report No.: RF180829W002-6

CH 26740

MODE	TX channel 26740	FREQUENCY RANGE	Above 1000MHz
ENVIRONMENTAL CONDITIONS	23deg. C, 70%RH	INPUT POWER	DC 5V from adapter
TESTED BY	Rose Ma		
ANTENNA POLARITY & TEST DISTANCE: HORIZONTAL AT 3 M			

	Freq	Level	Read Level	Limit Line	Over Limit	Factor	Remark	Pol/Phase
	MHz	dBm/m	dBm	dBm/m	dB	dB/m		
1	1638.000	-58.23	-53.18	-13.00	-45.23	-5.05	Peak	Horizontal
2 PP	2457.000	-53.51	-51.84	-13.00	-40.51	-1.67	Peak	Horizontal

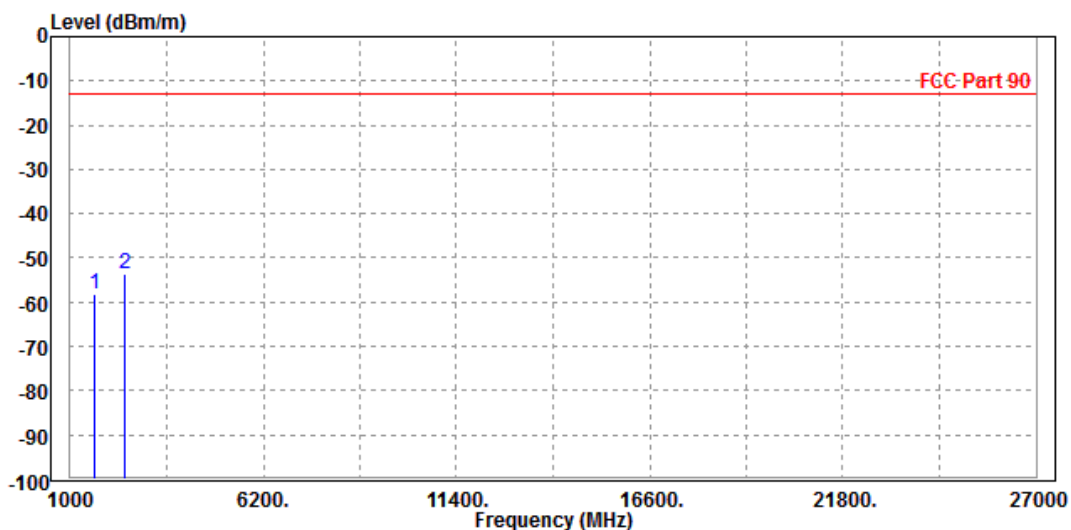



Test Report No.: RF180829W002-6

<b>MODE</b>	TX channel 26740	<b>FREQUENCY RANGE</b>	Above 1000MHz
<b>ENVIRONMENTAL CONDITIONS</b>	23deg. C, 70%RH	<b>INPUT POWER</b>	DC 5V from adapter
<b>TESTED BY</b>	Rose Ma		
<b>ANTENNA POLARITY &amp; TEST DISTANCE: VERTICAL AT 3 M</b>			

	Freq	Level	Read Level	Limit Line	Over Limit	Factor	Remark	Pol/Phase
	MHz	dBm/m	dBm	dBm/m	dB	dB/m		
1	1638.000	-62.00	-58.36	-13.00	-49.00	-3.64	Peak	Vertical
2 PP	2457.000	-55.57	-55.39	-13.00	-42.57	-0.18	Peak	Vertical

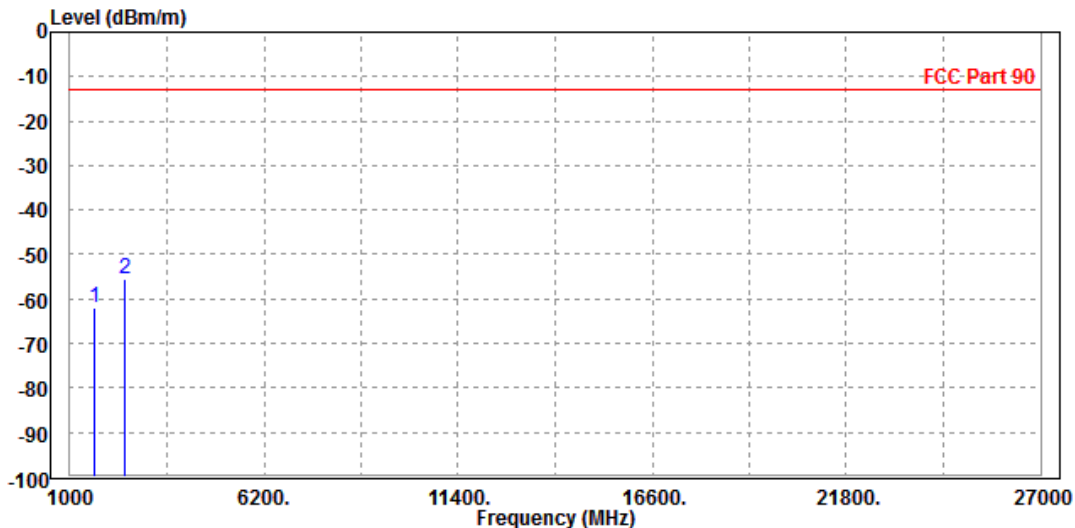



Test Report No.: RF180829W002-6

CH 26783

<b>MODE</b>	TX channel 26783	<b>FREQUENCY RANGE</b>	Above 1000MHz
<b>ENVIRONMENTAL CONDITIONS</b>	23deg. C, 70%RH	<b>INPUT POWER</b>	DC 5V from adapter
<b>TESTED BY</b>	Rose Ma		
<b>ANTENNA POLARITY &amp; TEST DISTANCE: HORIZONTAL AT 3 M</b>			

	Freq	Level	Read Level	Limit Line	Over Limit	Factor	Remark	Pol/Phase
	MHz	dBm/m	dBm	dBm/m	dB	dB/m		
1	1646.600	-61.57	-56.59	-13.00	-48.57	-4.98	Peak	Horizontal
2	PP 2469.900	-59.89	-58.23	-13.00	-46.89	-1.66	Peak	Horizontal

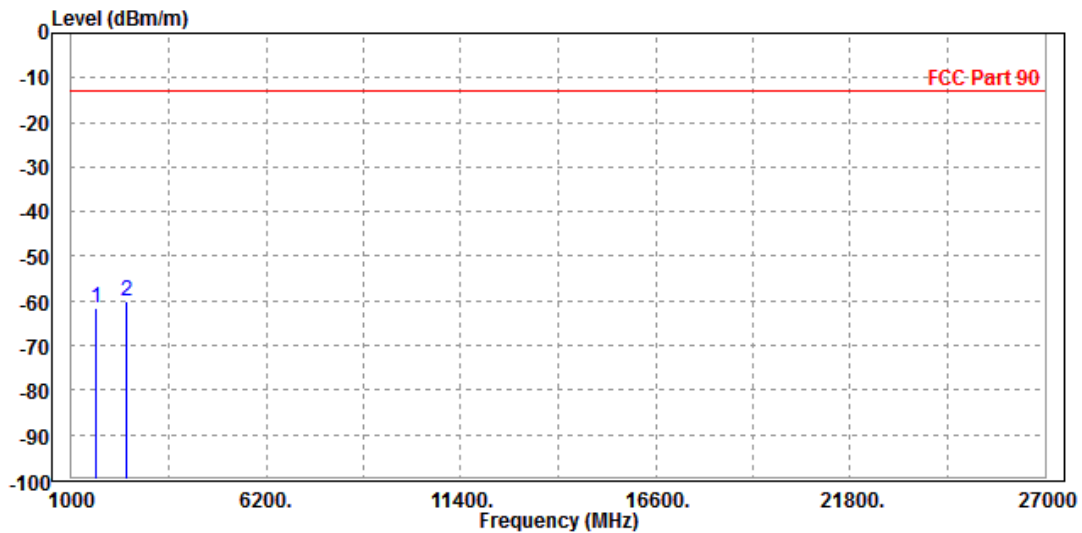



Test Report No.: RF180829W002-6

<b>MODE</b>	TX channel 26783	<b>FREQUENCY RANGE</b>	Above 1000MHz
<b>ENVIRONMENTAL CONDITIONS</b>	23deg. C, 70%RH	<b>INPUT POWER</b>	DC 5V from adapter
<b>TESTED BY</b>	Rose Ma		
<b>ANTENNA POLARITY &amp; TEST DISTANCE: VERTICAL AT 3 M</b>			

	Freq	Level	Read Level	Limit Line	Over Limit	Factor	Remark	Pol/Phase
	MHz	dBm/m	dBm	dBm/m	dB	dB/m		
1	1646.600	-58.19	-54.63	-13.00	-45.19	-3.56	Peak	Vertical
2 PP	2469.900	-57.14	-56.97	-13.00	-44.14	-0.17	Peak	Vertical

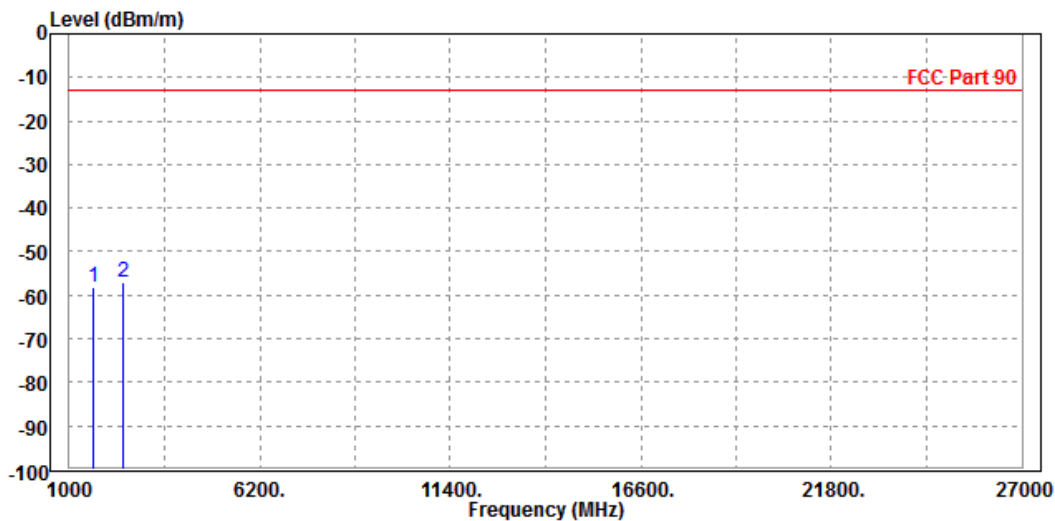





Test Report No.: RF180829W002-6

**CHANNEL BANDWIDTH: 3MHz / QPSK**

<b>MODE</b>	TX channel 26740	<b>FREQUENCY RANGE</b>	Above 1000MHz
<b>ENVIRONMENTAL CONDITIONS</b>	23deg. C, 70%RH	<b>INPUT POWER</b>	DC 5V from adapter
<b>TESTED BY</b>	Rose Ma		
<b>ANTENNA POLARITY &amp; TEST DISTANCE: HORIZONTAL AT 3 M</b>			

	Freq	Level	Read Level	Limit Line	Over Limit	Factor	Remark	Pol/Phase
	MHz	dBm/m	dBm	dBm/m	dB	dB/m		
1	1638.000	-61.99	-56.94	-13.00	-48.99	-5.05	Peak	Horizontal
2 PP	2457.000	-57.56	-55.89	-13.00	-44.56	-1.67	Peak	Horizontal

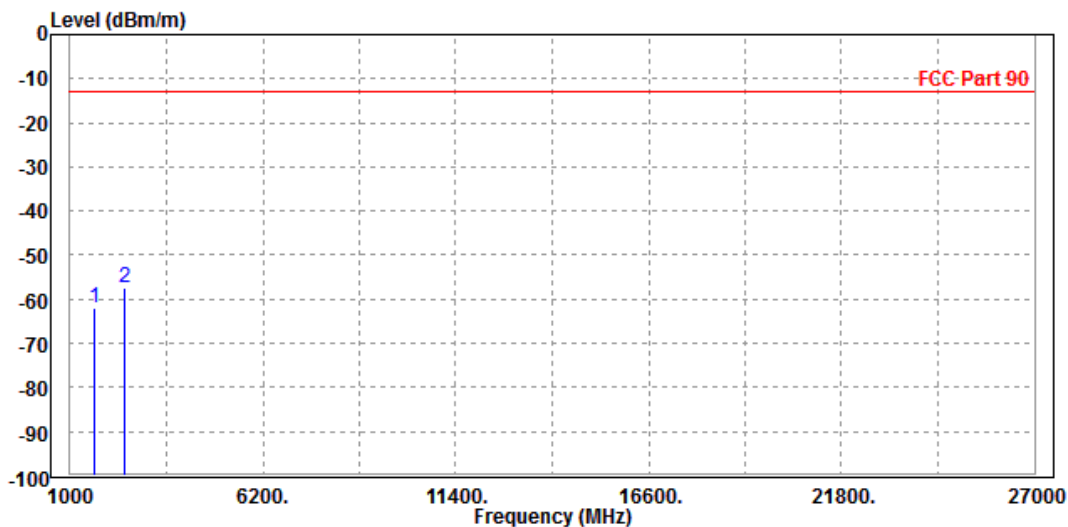



Test Report No.: RF180829W002-6

<b>MODE</b>	TX channel 26740	<b>FREQUENCY RANGE</b>	Above 1000MHz
<b>ENVIRONMENTAL CONDITIONS</b>	23deg. C, 70%RH	<b>INPUT POWER</b>	DC 5V from adapter
<b>TESTED BY</b>	Rose Ma		
<b>ANTENNA POLARITY &amp; TEST DISTANCE: VERTICAL AT 3 M</b>			

	Freq	Level	Read Level	Limit Line	Over Limit	Factor	Remark	Pol/Phase
	MHz	dBm/m	dBm	dBm/m	dB	dB/m		
1	1638.000	-60.63	-56.99	-13.00	-47.63	-3.64	Peak	Vertical
2 PP	2457.000	-57.30	-57.12	-13.00	-44.30	-0.18	Peak	Vertical

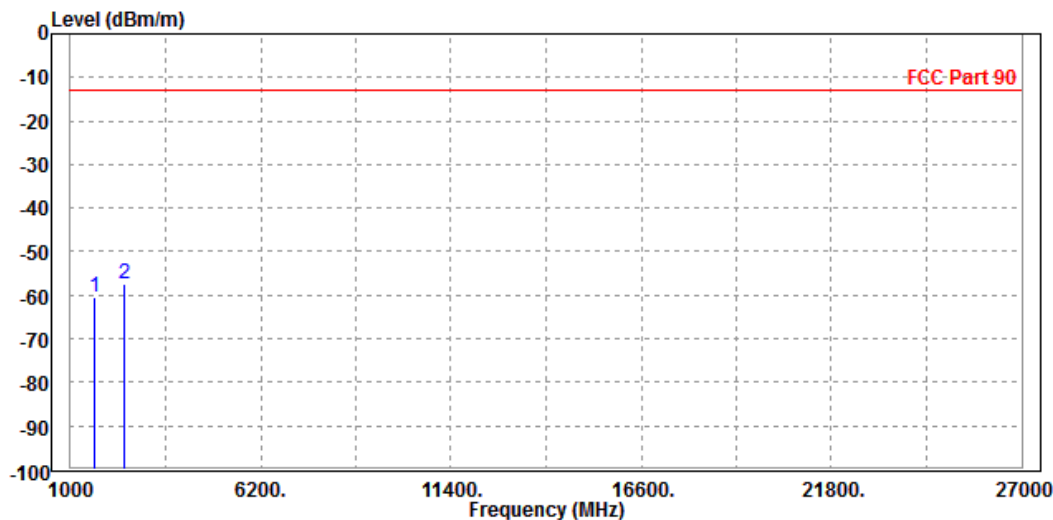



Test Report No.: RF180829W002-6

**CHANNEL BANDWIDTH: 5MHz / QPSK**

<b>MODE</b>	TX channel 26740	<b>FREQUENCY RANGE</b>	Above 1000MHz
<b>ENVIRONMENTAL CONDITIONS</b>	23deg. C, 70%RH	<b>INPUT POWER</b>	DC 5V from adapter
<b>TESTED BY</b>	Rose Ma		
<b>ANTENNA POLARITY &amp; TEST DISTANCE: HORIZONTAL AT 3 M</b>			

	Freq	Level	Read Level	Limit Line	Over Limit	Factor	Remark	Pol/Phase
	MHz	dBm/m	dBm	dBm/m	dB	dB/m		
1	1638.000	-57.66	-52.61	-13.00	-44.66	-5.05	Peak	Horizontal
2 PP	2457.000	-54.39	-52.72	-13.00	-41.39	-1.67	Peak	Horizontal

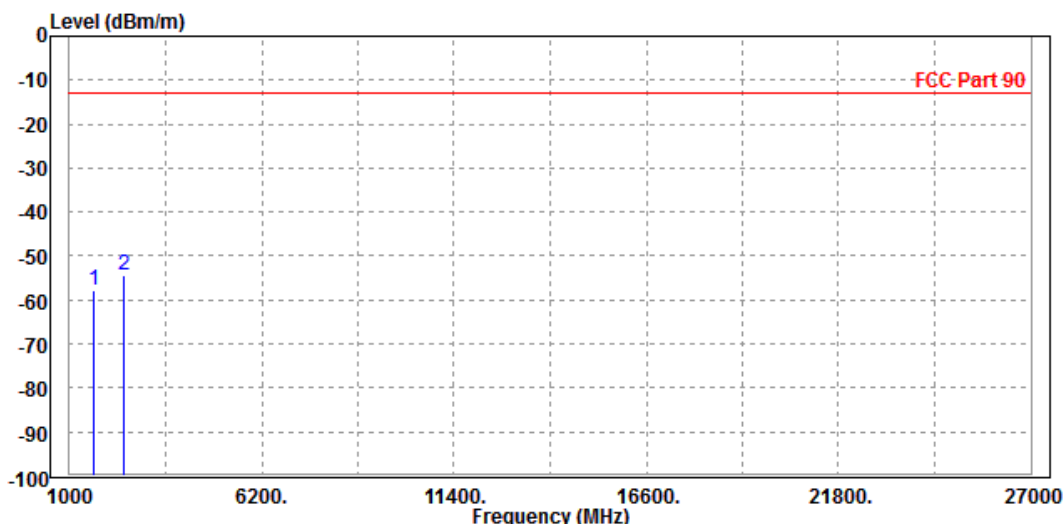



Test Report No.: RF180829W002-6

MODE	TX channel 26740	FREQUENCY RANGE	Above 1000MHz
ENVIRONMENTAL CONDITIONS	23deg. C, 70%RH	INPUT POWER	DC 5V from adapter
TESTED BY	Rose Ma		
ANTENNA POLARITY & TEST DISTANCE: VERTICAL AT 3 M			

	Freq	Level	Read Level	Limit Line	Over Limit	Factor	Remark	Pol/Phase
	MHz	dBm/m	dBm	dBm/m	dB	dB/m		
1	1638.000	-61.77	-58.13	-13.00	-48.77	-3.64	Peak	Vertical
2 PP	2457.000	-57.97	-57.79	-13.00	-44.97	-0.18	Peak	Vertical

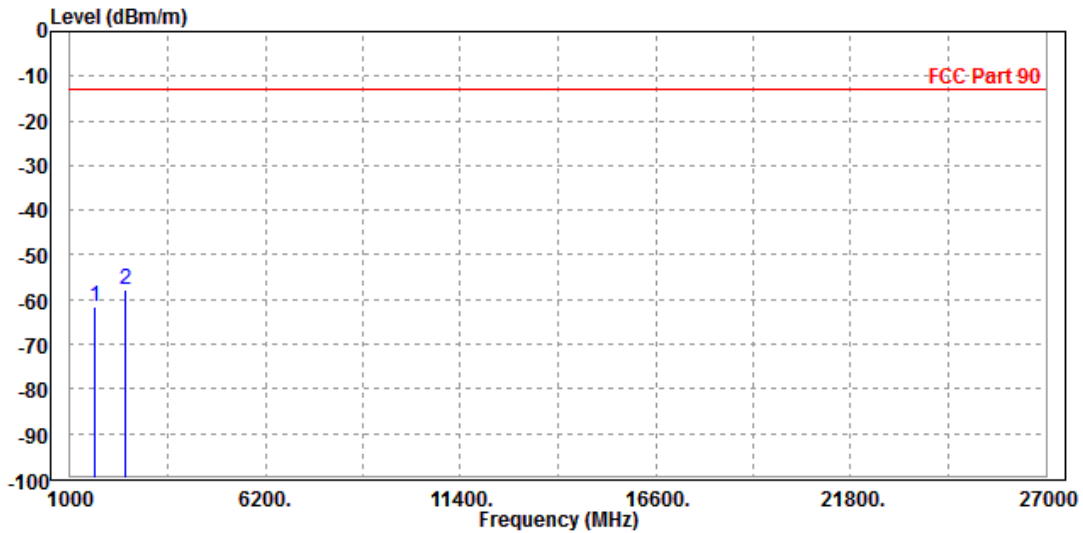



Test Report No.: RF180829W002-6

CHANNEL BANDWIDTH: 10MHz / QPSK

MODE	TX channel 26740	FREQUENCY RANGE	Above 1000MHz
ENVIRONMENTAL CONDITIONS	23deg. C, 70%RH	INPUT POWER	DC 5V from adapter
TESTED BY	Rose Ma		
ANTENNA POLARITY & TEST DISTANCE: HORIZONTAL AT 3 M			

	Freq	Level	Read Level	Limit Line	Over Limit	Factor	Remark	Pol/Phase
	MHz	dBm/m	dBm	dBm/m	dB	dB/m		
1	1638.000	-58.34	-53.29	-13.00	-45.34	-5.05	Peak	Horizontal
2 PP	2457.000	-55.55	-53.88	-13.00	-42.55	-1.67	Peak	Horizontal

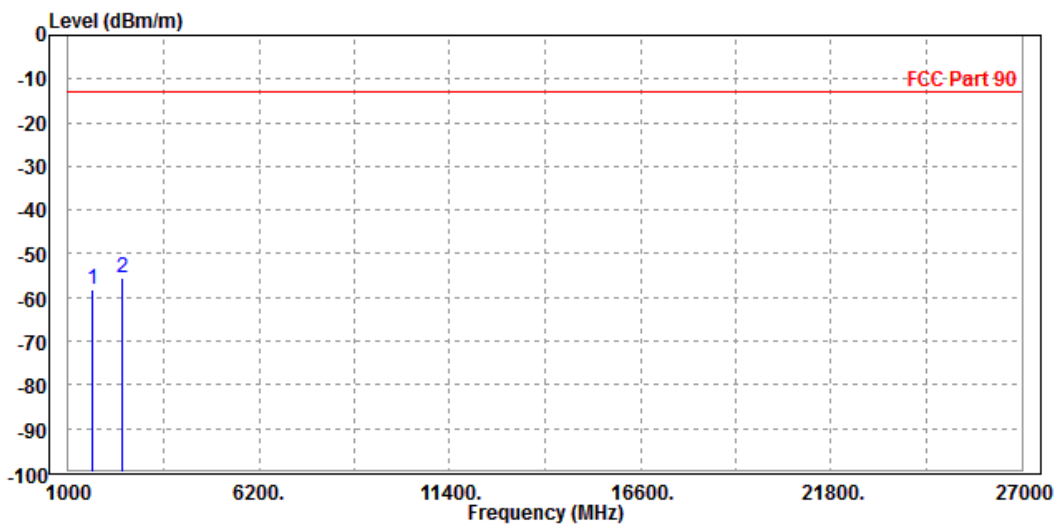



Test Report No.: RF180829W002-6

<b>MODE</b>	TX channel 26740	<b>FREQUENCY RANGE</b>	Above 1000MHz
<b>ENVIRONMENTAL CONDITIONS</b>	23deg. C, 70%RH	<b>INPUT POWER</b>	DC 5V from adapter
<b>TESTED BY</b>	Rose Ma		
<b>ANTENNA POLARITY &amp; TEST DISTANCE: VERTICAL AT 3 M</b>			

	Freq	Level	Read Level	Limit Line	Over Limit	Factor	Remark	Pol/Phase
	MHz	dBm/m	dBm	dBm/m	dB	dB/m		
1	1638.000	-56.86	-53.22	-13.00	-43.86	-3.64	Peak	Vertical
2 PP	2457.000	-54.30	-54.12	-13.00	-41.30	-0.18	Peak	Vertical

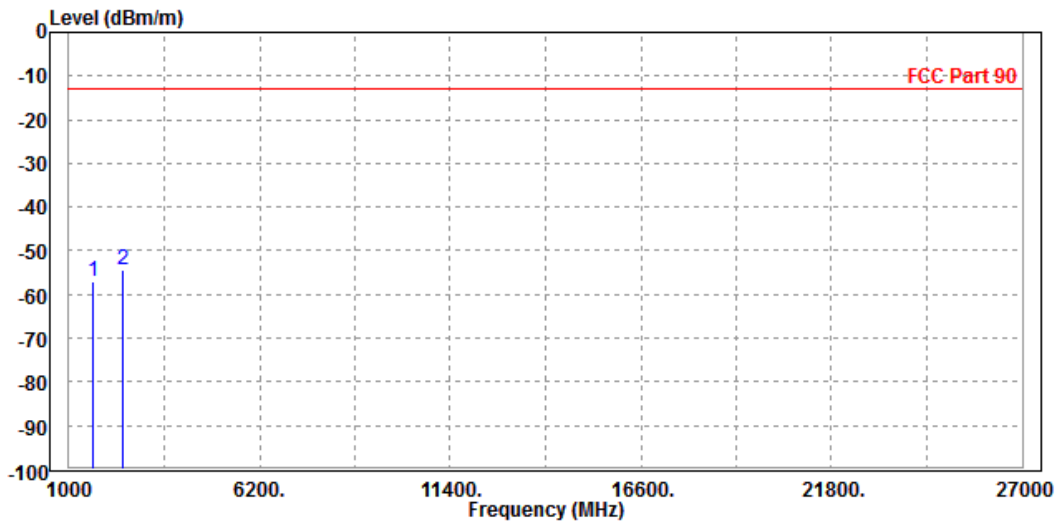



Test Report No.: RF180829W002-6

## 4 INFORMATION ON THE TESTING LABORATORIES

We, BV 7LAYERS COMMUNICATIONS TECHNOLOGY (SHENZHEN) CO. LTD., were founded in 2015 to provide our best service in EMC, Radio, Telecom and Safety consultation. Our laboratories are accredited and approved according to ISO/IEC 17025.

If you have any comments, please feel free to contact us at the following:

**Shenzhen EMC/RF Lab:**

Tel: +86-755-88696566

Fax: +86-755-88696577

**Email:** [customerservice.dg@cn.bureauveritas.com](mailto:customerservice.dg@cn.bureauveritas.com)

**Web Site:** [www.adt.com.tw](http://www.adt.com.tw)

The address and road map of all our labs can be found in our web site also.



Test Report No.: RF180829W002-6

## 5 APPENDIX A – MODIFICATIONS RECORDERS FOR ENGINEERING CHANGES TO THE EUT BY THE LAB

No modifications were made to the EUT by the lab during the test.

---END---