

FCC TEST REPORT (PART 24)



Applicant:	Sonim Technologies, Inc.
Address:	1875 S. Grant St., Suite 750., San Mateo, CA, 94402

Manufacturer or Supplier:	Sonim Technologies (Shenzhen) Limited
Address:	2nd Floor, No. 2 Building Phase B, Daqian Industrial park, Longchang Road, 67 District, Baoan, Shenzhen, P. R. China
Product:	Mobile Phone
Brand Name:	Sonim
Model Name:	XP3800
FCC ID:	WYPPC2223
Date of tests:	Oct. 09, 2018 ~ Dec. 20, 2018

The tests have been carried out according to the requirements of the following standard:

- FCC PART 24, Subpart E** **ANSI C63.26-2015**
 ANSI/TIA/EIA-603-D **ANSI/TIA/EIA-603-E**

CONCLUSION: The submitted sample was found to COMPLY with the test requirement

Prepared by Roger Li Engineer / Mobile Department	Approved by Sam Tung Manager / Mobile Department
	
Date: Dec. 21, 2018	Date: Dec. 21, 2018

This report is governed by, and incorporates by reference, CPS Conditions of Service as posted at the date of issuance of this report at <http://www.bureauveritas.com/home/about-us/our-business/cps/about-us/terms-conditions> and is intended for your exclusive use. Any copying or replication of this report to or for any other person or entity, or use of our name or trademark, is permitted only with our prior written permission. This report sets forth our findings solely with respect to the test samples identified herein. The results set forth in this report are not indicative or representative of the quality or characteristics of the lot from which a test sample was taken or any similar or identical product unless specifically and expressly noted. Our report includes all of the tests requested by you and the results thereof based upon the information that you provided to us. Measurement uncertainty is only provided upon request for accredited tests. You have 60 days from date of issuance of this report to notify us of any material error or omission caused by our negligence or if you require measurement uncertainty; provided, however, that such notice shall be in writing and shall specifically address the issue you wish to raise. A failure to raise such issue within the prescribed time shall constitute your unqualified acceptance of the completeness of this report, the tests conducted and the correctness of the report contents.



TABLE OF CONTENTS

RELEASE CONTROL RECORD	4
1 SUMMARY OF TEST RESULTS.....	5
1.1 MEASUREMENT UNCERTAINTY	5
1.2 TEST SITE AND INSTRUMENTS	6
2 GENERAL INFORMATION	7
2.1 GENERAL DESCRIPTION OF EUT.....	7
2.2 CONFIGURATION OF SYSTEM UNDER TEST	11
2.3 DESCRIPTION OF SUPPORT UNITS.....	12
2.4 TEST ITEM AND TEST CONFIGURATION	12
2.5 EUT OPERATING CONDITIONS	18
2.6 GENERAL DESCRIPTION OF APPLIED STANDARDS	18
3 TEST TYPES AND RESULTS.....	19
3.1 OUTPUT POWER MEASUREMENT	19
3.1.1 LIMITS OF OUTPUT POWER MEASUREMENT	19
3.1.2 TEST PROCEDURES	19
3.1.3 TEST SETUP	20
3.1.4 TEST RESULTS	21
3.2 FREQUENCY STABILITY MEASUREMENT	48
3.2.1 LIMITS OF FREQUENCY STABILITY MEASUREMENT	48
3.2.2 TEST PROCEDURE.....	48
3.2.3 TEST SETUP.....	48
3.2.4 TEST RESULTS	49
3.3 OCCUPIED BANDWIDTH MEASUREMENT	65
3.3.1 TEST PROCEDURES	65
3.3.2 TEST SETUP.....	65
3.3.3 TEST RESULTS	66
3.4 BAND EDGE MEASUREMENT	90
3.4.1 LIMITS OF BAND EDGE MEASUREMENT.....	90
3.4.2 TEST SETUP.....	90
3.4.3 TEST PROCEDURES	91
3.4.4. TEST RESULTS.....	92
3.5 CONDUCTED SPURIOUS EMISSIONS	106
3.5.1 LIMITS OF CONDUCTED SPURIOUS EMISSIONS MEASUREMENT.....	106
3.5.2 TEST PROCEDURE.....	106
3.5.3 TEST SETUP.....	106
3.5.4 TEST RESULTS	107
3.6 RADIATED EMISSION MEASUREMENT	123
3.6.1 LIMITS OF RADIATED EMISSION MEASUREMENT	123
3.6.2 TEST PROCEDURES	123
3.6.3 DEVIATION FROM TEST STANDARD	123
3.6.4 TEST SETUP	124
3.6.5 TEST RESULTS	126
3.7 PEAK TO AVERAGE RATIO	184
3.7.1 LIMITS OF PEAK TO AVERAGE RATIO MEASUREMENT.....	184
3.7.2 TEST SETUP.....	184
3.7.3 TEST PROCEDURES	184
3.7.4 TEST RESULTS	185



Test Report No.: RF180829W002-5

4	INFORMATION ON THE TESTING LABORATORIES	209
5	APPENDIX A – MODIFICATIONS RECORDERS FOR ENGINEERING CHANGES TO THE EUT BY THE LAB	210



Test Report No.: RF180829W002-5

RELEASE CONTROL RECORD

ISSUE NO.	REASON FOR CHANGE	DATE ISSUED
RF180829W002-5	Original release	Dec. 21, 2018

1 SUMMARY OF TEST RESULTS

The EUT has been tested according to the following specifications:

APPLIED STANDARD: FCC Part 24 & Part 2			
STANDARD SECTION	TEST TYPE	RESULT	REMARK
2.1046 24.232	Equivalent Isotropic Radiated Power	PASS	Meet the requirement of limit.
2.1055 24.235	Frequency Stability	PASS	Meet the requirement of limit.
2.1049 24.238(b)	Occupied Bandwidth	PASS	Meet the requirement of limit.
24.232(d)	Peak to average ratio	PASS	Meet the requirement of limit.
24.238(b)	Band Edge Measurements	PASS	Meet the requirement of limit.
2.1051 24.238	Conducted Spurious Emissions	PASS	Meet the requirement of limit.
2.1053 24.238	Radiated Spurious Emissions	PASS	Meet the requirement of limit. Minimum passing margin is -17.75dB at 5743.000MHz.

1.1 MEASUREMENT UNCERTAINTY

Where relevant, the following measurement uncertainty levels have been estimated for tests performed on the EUT as specified in CISPR 16-4-2:

MEASUREMENT	FREQUENCY	UNCERTAINTY
Conducted emissions	9kHz~30MHz	2.66dB
Radiated emissions	9KHz ~ 30MHz	2.68dB
	30MHz ~ 1GHz	3.26dB
	1GHz ~ 18GHz	4.48dB
	18GHz ~ 40GHz	4.12dB

This uncertainty represents an expanded uncertainty expressed at approximately the 95% confidence level using a coverage factor of k=2.



1.2 TEST SITE AND INSTRUMENTS

Equipment	Manufacturer	Model No.	Serial No.	Last Cal.	Next Cal.
MXE EMI Receiver	KEYSIGHT	N9038A-544	MY54450026	Mar. 16,18	Mar. 15,19
EXA Signal Analyzer	KEYSIGHT	N9010A-526	MY54510322	Mar. 16,18	Mar. 15,19
Bilog Antenna 1	ETS-LINDGREN	3143B	00161964	Mar. 15,18	Mar. 14,19
Bilog Antenna 2	ETS-LINDGREN	3143B	00161965	Mar. 15,18	Mar. 14,19
Horn Antenna 1	ETS-LINDGREN	3117	00168728	Mar. 15,18	Mar. 14,19
Horn Antenna 2	ETS-LINDGREN	3117	00168692	Nov. 30, 18	Nov. 29, 19
Loop antenna	Daze	ZN30900A	0708	Oct. 23,18	Oct. 22, 19
Horn Antenna (18GHz-40GHz)	N/A	QWH-SL-18-40-K-SG/QMS-00361	15433	Nov. 21, 18	Nov. 20, 19
Radio Communication Analyzer	ANRITSU	MT8820C	6201465426	Mar. 02,18	Mar. 01,19
Signal Pre-Amplifier	EMSI	EMC 9135	980249	Jul. 09,18	Jul. 08,19
Signal Pre-Amplifier	EMSI	EMC 012645B	980257	Jul. 09,18	Jul. 08,19
Signal Pre-Amplifier	EMSI	EMC 184045B	980259	Jul. 09,18	Jul. 08,19
3m Semi-anechoic Chamber	ETS-LINDGREN	9m*6m*6m	Euroshieldpn-CT0001143-1216	Apr. 21,18	Apr. 20,19
Test Software	E3	V 9.160323	N/A	N/A	N/A
Test Software	ADT	ADT_Radiated_V7.6.15.9.2	N/A	N/A	N/A
10dB Attenuator	JFW/USA	50HF-010-SM A	1505	Jul. 09,18	Jul. 08,19
Power Meter	Anritsu	ML2495A	1506002	Mar. 02,18	Mar. 01,19
Power Sensor	Anritsu	MA2411B	1339352	Mar. 16,18	Mar. 15,19
Humid & Temp Programmable Tester	Juyi	ITH-120-45-CP-AR	IAA1504-001	Jul. 09,18	Jul. 08,19
MXG Analog Microwave Signal Generator	KEYSIGHT	N5183A	MY50143024	Mar. 13,18	Mar. 12,19

NOTE: 1. The calibration interval of the above test instruments is 12 months or 24 months and the calibrations are traceable to CEPREI/CHINA, GRGT/CHINA and NIM/CHINA.

2. The test was performed in 3m Semi-anechoic Chamber and RF Oven Room.

3. The horn antenna is used only for the measurement of emission frequency above 1GHz if tested.

4. The FCC Site Registration No. is 525120; The Designation No. is CN1171.

2 GENERAL INFORMATION

2.1 GENERAL DESCRIPTION OF EUT

PRODUCT	Mobile Phone	
BRAND NAME	Sonim	
MODEL NAME	XP3800	
POWER SUPPLY	5.0Vdc (adapter or host equipment) 3.7Vdc (Li-ion, battery)	
MODULATION TYPE	GSM, GPRS: GMSK EDGE: GMSK, 8PSK WCDMA : BPSK CDMA : GMSK LTE Band : QPSK, 16QAM, 64QAM	
FREQUENCY RANGE	GSM, GPRS, EDGE	1850.2MHz ~ 1909.8MHz
	WCDMA	1852.4MHz ~ 1907.6MHz
	CDMA BC1	1851.25MHz ~1908.75MHz
	LTE Band 2 Channel Bandwidth: 1.4MHz	1850.7MHz ~ 1909.3MHz
	LTE Band 2 Channel Bandwidth: 3MHz	1851.5MHz ~ 1908.5MHz
	LTE Band 2 Channel Bandwidth: 5MHz	1852.5MHz ~ 1907.5MHz
	LTE Band 2 Channel Bandwidth: 10MHz	1855.0MHz ~ 1905.0MHz
	LTE Band 2 Channel Bandwidth: 15MHz	1857.5MHz ~ 1902.5MHz
	LTE Band 2 Channel Bandwidth: 20MHz	1860.0MHz ~ 1900.0MHz
	LTE Band 25 Channel Bandwidth: 1.4MHz	1850.7MHz ~ 1914.3MHz
	LTE Band 25 Channel Bandwidth: 3MHz	1851.5MHz ~ 1913.5MHz
	LTE Band 25 Channel Bandwidth: 5MHz	1852.5MHz ~ 1912.5MHz
	LTE Band 25 Channel Bandwidth: 10MHz	1855MHz ~ 1910MHz
	LTE Band 25 Channel Bandwidth: 15MHz	1857.5MHz ~ 1907.5MHz
	LTE Band 25 Channel Bandwidth: 20MHz	1860MHz ~ 1905MHz
MAX. EIRP POWER	GSM	933mW
	EDGE	738mW
	WCDMA	362mW



Test Report No.: RF180829W002-5

	CDMA BC1	142mW	
	LTE Band 2 Channel Bandwidth: 1.4MHz	340mW	
	LTE Band 2 Channel Bandwidth: 3MHz	341mW	
	LTE Band 2 Channel Bandwidth: 5MHz	336mW	
	LTE Band 2 Channel Bandwidth: 10MHz	354mW	
	LTE Band 2 Channel Bandwidth: 15MHz	364mW	
	LTE Band 2 Channel Bandwidth: 20MHz	286mW	
	LTE Band 25 Channel Bandwidth: 1.4MHz	233mW	
	LTE Band 25 Channel Bandwidth: 3MHz	235mW	
	LTE Band 25 Channel Bandwidth: 5MHz	237mW	
	LTE Band 25 Channel Bandwidth: 10MHz	241mW	
	LTE Band 25 Channel Bandwidth: 15MHz	232mW	
	LTE Band 25 Channel Bandwidth: 20MHz	209mW	
	EMISSION DESIGNATOR	GSM	245KGXW
		EDGE	252KG7W
WCDMA		4M14F9W	
CDMA BC1		1M27F9W	
LTE Band 2 Channel Bandwidth: 1.4MHz		QPSK: 1M08G7D	
		16QAM: 1M08W7D	
		64QAM: 1M08W7D	
LTE Band 2 Channel Bandwidth: 3MHz		QPSK: 2M68G7D	
		16QAM: 2M68W7D	
		64QAM: 2M68W7D	
LTE Band 2 Channel Bandwidth: 5MHz		QPSK: 4M47G7D	
		16QAM: 4M46W7D	
		64QAM: 4M47W7D	
LTE Band 2 Channel Bandwidth: 10MHz		QPSK: 8M91G7D	
		16QAM: 8M92W7D	
	64QAM: 8M91W7D		

EMISSION DESIGNATOR	LTE Band 2 Channel Bandwidth: 15MHz	QPSK: 13M3G7D
		16QAM: 13M4W7D
		64QAM: 13M4W7D
	LTE Band 2 Channel Bandwidth: 20MHz	QPSK: 17M8G7D
		16QAM: 17M8W7D
		64QAM: 17M8W7D
	LTE Band 25 Channel Bandwidth: 1.4MHz	QPSK: 1M09G7D
		16QAM: 1M09W7D
		64QAM: 1M08W7D
	LTE Band 25 Channel Bandwidth: 3MHz	QPSK: 2M68G7D
		16QAM: 2M68W7D
		64QAM: 2M69W7D
	LTE Band 25 Channel Bandwidth: 5MHz	QPSK: 4M47G7D
		16QAM: 4M47W7D
		64QAM: 4M47W7D
	LTE Band 25 Channel Bandwidth: 10MHz	QPSK: 8M93G7D
		16QAM: 8M90W7D
		64QAM: 8M93W7D
	LTE Band 25 Channel Bandwidth: 15MHz	QPSK: 13M4G7D
		16QAM: 13M4W7D
		64QAM: 13M4W7D
	LTE Band 25 Channel Bandwidth: 20MHz	QPSK: 17M8G7D
		16QAM: 17M8W7D
		64QAM: 17M9W7D
ANTENNA TYPE	Fixed Internal antenna with 0dBi gain	
HW VERSION	DVT2	
SW VERSION	3A.0.0-00-8.1.0-29.09.04	
I/O PORTS	Refer to user's manual	
CABLE SUPPLIED	USB cable: non-shielded, detachable, 1.5meter	

NOTE:

- For a more detailed features description, please refer to the manufacturer's specifications or the user's manual.
- The EUT was powered by the following adapters:

ADAPTER 1	
BRAND:	Sonim
MODEL:	TUUS050100-K00
INPUT:	AC 100-240V, 200mA
OUTPUT:	DC 5V, 1000mA

ADAPTER 2	
BRAND:	Sonim
MODEL:	AQ05A-050B
INPUT:	AC 100-240V, 200mA
OUTPUT:	DC 5V, 1000mA

3. The EUT matched the following USB cable:

USB CABLE	
BRAND:	N.A
MODEL:	N.A
SIGNAL LINE:	1.5 METER

4. For the test results, the EUT had been tested with all conditions. But only the worst case was shown in test report.

2.2 CONFIGURATION OF SYSTEM UNDER TEST

FOR RADIATION EMISSION TEST

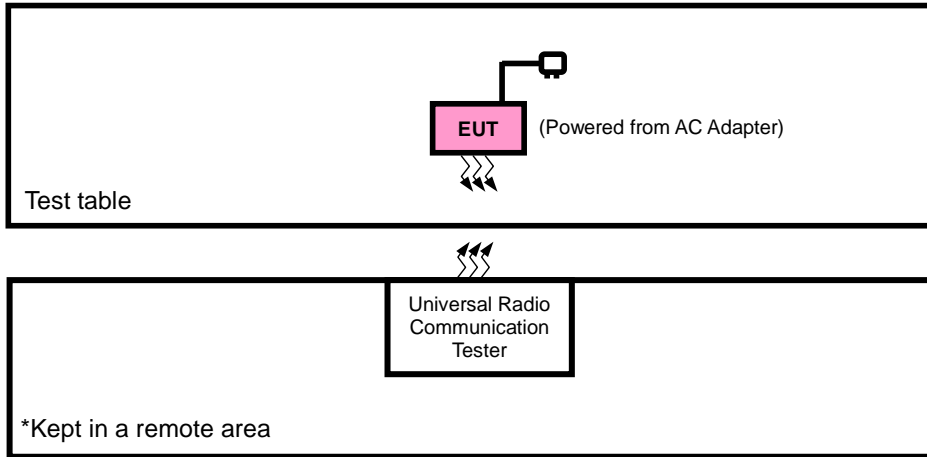

FOR CONDUCTED & E.I.R.P. TEST

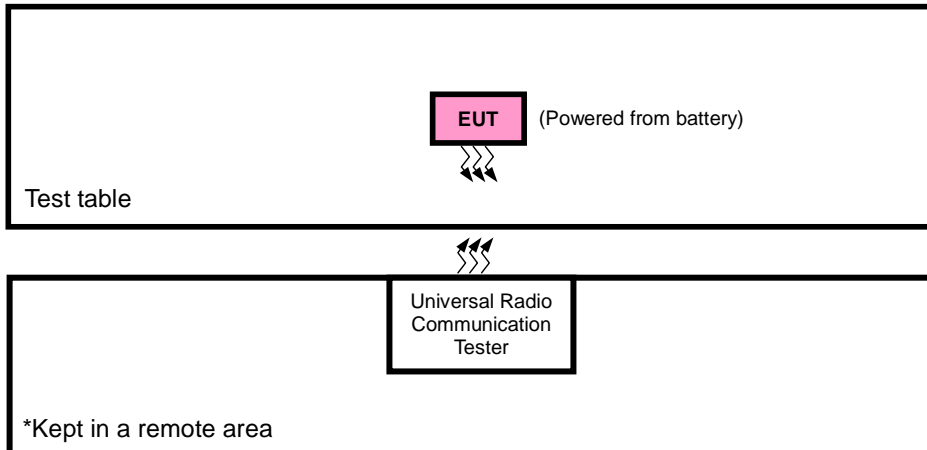



2.3 DESCRIPTION OF SUPPORT UNITS

The EUT has been tested as an independent unit together with other necessary accessories or support units. The following support units or accessories were used to form a representative test configuration during the tests.

NO.	PRODUCT	BRAND	MODEL NO.	SERIAL NO.	FCC ID
1	DC source	LONG WEI	PS-6403D	010934269	N/A
2	PC	HP	A6608CN	3CR83825X3	N/A

NO.	SIGNAL CABLE DESCRIPTION OF THE ABOVE SUPPORT UNITS
1	DC Line: Unshielded, Detachable 1.0m
2	AC Line: Unshielded, Detachable 1.5m

NOTE:

- All power cords of the above support units are non shielded (1.8m).

2.4 TEST ITEM AND TEST CONFIGURATION

Pre-Scan has been conducted to determine the worst-case mode from all possible combinations between available modulations, data rates, XYZ axis and antenna ports

The worst case in EIRP and radiated emission was found when positioned on X-plane for GSM/EDGE/WCDMA/CDMA/LTE. Following channel(s) was (were) selected for the final test as listed below:

EUT CONFIGURE MODE	DESCRIPTION
A	EUT + Adapter + USB Cable with GSM, WCDMA, CDMA or LTE link
B	EUT + Battery with GSM, WCDMA, CDMA or LTE link

GSM MODE

EUT CONFIGURE MODE	TEST ITEM	AVAILABLE CHANNEL	TESTED CHANNEL	MODE
B	EIRP	512 to 810	512, 661, 810	GSM, EDGE
B	FREQUENCY STABILITY	512 to 810	512, 810	GSM, EDGE
B	OCCUPIED BANDWIDTH	512 to 810	512, 661, 810	GSM, EDGE
B	PEAK TO AVERAGE RATIO	512 to 810	512, 661, 810	GSM, EDGE
B	BAND EDGE	512 to 810	512, 810	GSM, EDGE
B	CONDCUDED EMISSION	512 to 810	512, 661, 810	GSM, EDGE
A	RADIATED EMISSION	512 to 810	512, 661, 810	GSM, EDGE



Test Report No.: RF180829W002-5

WCDMA MODE

EUT CONFIGURE MODE	TEST ITEM	AVAILABLE CHANNEL	TESTED CHANNEL	MODE
B	EIRP	9262 to 9538	9262, 9400, 9538	WCDMA
B	FREQUENCY STABILITY	9262 to 9538	9262, 9538	WCDMA
B	OCCUPIED BANDWIDTH	9262 to 9538	9262, 9400, 9538	WCDMA
B	PEAK TO AVERAGE RATIO	9262 to 9538	9262, 9400, 9538	WCDMA
B	BAND EDGE	9262 to 9538	9262, 9538	WCDMA
B	CONDCUDED EMISSION	9262 to 9538	9262, 9400, 9538	WCDMA
A	RADIATED EMISSION	9262 to 9538	9262, 9400, 9538	WCDMA

CDMA BC 1 MODE

EUT CONFIGURE MODE	TEST ITEM	AVAILABLE CHANNEL	TESTED CHANNEL	MODE
B	ERP	25 to 1175	25, 600, 1175	CDMA BC 1
B	FREQUENCY STABILITY	25 to 1175	25, 1175	CDMA BC 1
B	OCCUPIED BANDWIDTH	25 to 1175	25, 600, 1175	CDMA BC 1
B	PEAK TO AVERAGE RATIO	25 to 1175	25, 600, 1175	CDMA BC 1
B	BAND EDGE	25 to 1175	25, 1175	CDMA BC 1
B	CONDCUDED EMISSION	25 to 1175	25, 600, 1175	CDMA BC 1
A	RADIATED EMISSION	25 to 1175	25, 600, 1175	CDMA BC 1



Test Report No.: RF180829W002-5

LTE BAND 2

EUT CONFIGURE MODE	TEST ITEM	AVAILABLE CHANNEL	TESTED CHANNEL	CHANNEL BANDWIDTH	MODULATION	MODE
B	EIRP	18607 to 19193	18607, 18900, 19193	1.4MHz	QPSK,16QAM, 64QAM	1 RB / 0 RB Offset
		18615 to 19185	18615, 18900, 19185	3MHz	QPSK,16QAM, 64QAM	1 RB / 0 RB Offset
		18625 to 19175	18625, 18900, 19175	5MHz	QPSK,16QAM, 64QAM	1 RB / 0 RB Offset
		18650 to 19150	18650, 18900, 19150	10MHz	QPSK,16QAM, 64QAM	1 RB / 0 RB Offset
		18675 to 19125	18675, 18900, 19125	15MHz	QPSK,16QAM, 64QAM	1 RB / 0 RB Offset
		18700 to 19100	18700, 18900, 19100	20MHz	QPSK,16QAM, 64QAM	1 RB / 0 RB Offset
B	FREQUENCY STABILITY	18607 to 19193	18607, 19193	1.4MHz	QPSK	1 RB / 0 RB Offset
		18615 to 19185	18615, 19185	3MHz	QPSK	1 RB / 0 RB Offset
		18625 to 19175	18625, 19175	5MHz	QPSK	1 RB / 0 RB Offset
		18650 to 19150	18650, 19150	10MHz	QPSK	1 RB / 0 RB Offset
		18675 to 19125	18675, 19125	15MHz	QPSK	1 RB / 0 RB Offset
		18700 to 19100	18700, 19100	20MHz	QPSK	1 RB / 0 RB Offset
B	OCCUPIED BANDWIDTH	18607 to 19193	18607, 18900, 19193	1.4MHz	QPSK,16QAM, 64QAM	6 RB / 0 RB Offset
		18615 to 19185	18615, 18900, 19185	3MHz	QPSK,16QAM, 64QAM	15 RB / 0 RB Offset
		18625 to 19175	18625, 18900, 19175	5MHz	QPSK,16QAM, 64QAM	25 RB / 0 RB Offset
		18650 to 19150	18650, 18900, 19150	10MHz	QPSK,16QAM, 64QAM	50 RB / 0 RB Offset
		18675 to 19125	18675, 18900, 19125	15MHz	QPSK,16QAM, 64QAM	75 RB / 0 RB Offset
		18700 to 19100	18700, 18900, 19100	20MHz	QPSK,16QAM, 64QAM	100 RB / 0 RB Offset
B	PEAK TO AVERAGE RATIO	18607 to 19193	18607, 18900, 19193	1.4MHz	QPSK,16QAM, 64QAM	1 RB / 0 RB Offset
		18615 to 19185	18615, 18900, 19185	3MHz	QPSK,16QAM, 64QAM	1 RB / 0 RB Offset
		18625 to 19175	18625, 18900, 19175	5MHz	QPSK,16QAM, 64QAM	1 RB / 0 RB Offset
		18650 to 19150	18650, 18900, 19150	10MHz	QPSK,16QAM, 64QAM	1 RB / 0 RB Offset
		18675 to 19125	18675, 18900, 19125	15MHz	QPSK,16QAM, 64QAM	1 RB / 0 RB Offset
		18700 to 19100	18700, 18900, 19100	20MHz	QPSK,16QAM, 64QAM	1 RB / 0 RB Offset

B	BAND EDGE	18607 to 19193	18607	1.4MHz	QPSK	1 RB / 0 RB Offset
			19193	1.4MHz	QPSK	6 RB / 0 RB Offset
		18615 to 19185	18615	3MHz	QPSK	1 RB / 5 RB Offset
			19185	3MHz	QPSK	6 RB / 0 RB Offset
		18625 to 19175	18615	3MHz	QPSK	1 RB / 0 RB Offset
			19185	3MHz	QPSK	15 RB / 0 RB Offset
		18625 to 19175	18625	5MHz	QPSK	1 RB / 14 RB Offset
			19175	5MHz	QPSK	15 RB / 0 RB Offset
		18650 to 19150	18625	5MHz	QPSK	1 RB / 0 RB Offset
			19175	5MHz	QPSK	25 RB / 0 RB Offset
		18650 to 19150	18650	10MHz	QPSK	1 RB / 24 RB Offset
			19150	10MHz	QPSK	25 RB / 0 RB Offset
		18675 to 19125	18650	10MHz	QPSK	1 RB / 0 RB Offset
			19150	10MHz	QPSK	50 RB / 0 RB Offset
		18675 to 19125	18675	15MHz	QPSK	1 RB / 49 RB Offset
			19125	15MHz	QPSK	50 RB / 0 RB Offset
18700 to 19100	18675	15MHz	QPSK	1 RB / 0 RB Offset		
	19125	15MHz	QPSK	75 RB / 0 RB Offset		
18700 to 19100	18700	20MHz	QPSK	1 RB / 74 RB Offset		
	19100	20MHz	QPSK	75 RB / 0 RB Offset		
B	CONDCUDED EMISSION	18607 to 19193	18607, 18900, 19193	1.4MHz	QPSK	1 RB / 0 RB Offset
		18615 to 19185	18615, 18900, 19185	3MHz	QPSK	1 RB / 0 RB Offset
		18625 to 19175	18625, 18900, 19175	5MHz	QPSK	1 RB / 0 RB Offset
		18650 to 19150	18650, 18900, 19150	10MHz	QPSK	1 RB / 0 RB Offset
		18675 to 19125	18675, 18900, 19125	15MHz	QPSK	1 RB / 0 RB Offset
		18700 to 19100	18700, 18900, 19100	20MHz	QPSK	1 RB / 0 RB Offset
A	RADIATED EMISSION	18607 to 19193	18900	1.4MHz	QPSK	1 RB / 0 RB Offset
		18615 to 19185	18900	3MHz	QPSK	1 RB / 0 RB Offset
		18625 to 19175	18900	5MHz	QPSK	1 RB / 0 RB Offset
		18650 to 19150	18650, 18900, 19150	10MHz	QPSK	1 RB / 0 RB Offset
		18675 to 19125	18900	15MHz	QPSK	1 RB / 0 RB Offset
		18700 to 19100	18900	20MHz	QPSK	1 RB / 0 RB Offset



Test Report No.: RF180829W002-5

LTE BAND 25 MODE

EUT CONFIGURE MODE	TEST ITEM	AVAILABLE CHANNEL	TESTED CHANNEL	CHANNEL BANDWIDTH	MODULATION	MODE
B	EIRP	26047 to 26683	26047, 26365, 26683	1.4MHz	QPSK,16QAM, 64QAM	1 RB / 0 RB Offset
		26055 to 26675	26055, 26365, 26675	3MHz	QPSK,16QAM, 64QAM	1 RB / 0 RB Offset
		26065 to 26665	26065, 26365, 26665	5MHz	QPSK,16QAM, 64QAM	1 RB / 0 RB Offset
		26090 to 26640	26090, 26365 26640	10MHz	QPSK,16QAM, 64QAM	1 RB / 0 RB Offset
		26115 to 26615	26115, 26365, 26615	15MHz	QPSK,16QAM, 64QAM	1 RB / 0 RB Offset
		26140 to 26590	26140, 26365, 26590	20MHz	QPSK,16QAM, 64QAM	1 RB / 0 RB Offset
B	FREQUENCY STABILITY	26047 to 26683	26047, 26683	1.4MHz	QPSK	1 RB / 0 RB Offset
		26055 to 26675	26055, 26675	3MHz	QPSK	1 RB / 0 RB Offset
		26065 to 26665	26065, 26665	5MHz	QPSK	1 RB / 0 RB Offset
		26090 to 26640	26090, 26640	10MHz	QPSK	1 RB / 0 RB Offset
		26115 to 26615	26115, 26615	15MHz	QPSK	1 RB / 0 RB Offset
		26140 to 26590	26140, 26590	20MHz	QPSK	1 RB / 0 RB Offset
B	OCCUPIED BANDWIDTH	26047 to 26683	26047, 26365, 26683	1.4MHz	QPSK,16QAM, 64QAM	6 RB / 0 RB Offset
		26055 to 26675	26055, 26365, 26675	3MHz	QPSK,16QAM, 64QAM	15 RB / 0 RB Offset
		26065 to 26665	26065, 26365, 26665	5MHz	QPSK,16QAM, 64QAM	25 RB / 0 RB Offset
		26090 to 26640	26090, 26365 26640	10MHz	QPSK,16QAM, 64QAM	50 RB / 0 RB Offset
		26115 to 26615	26115, 26365, 26615	15MHz	QPSK,16QAM, 64QAM	75 RB / 0 RB Offset
		26140 to 26590	26140, 26365, 26590	20MHz	QPSK,16QAM, 64QAM	100 RB / 0 RB Offset
B	PEAK TO AVERAGE RATIO	26047 to 26683	26047, 26365, 26683	1.4MHz	QPSK,16QAM, 64QAM	1 RB / 0 RB Offset
		26055 to 26675	26055, 26365, 26675	3MHz	QPSK,16QAM, 64QAM	1 RB / 0 RB Offset
		26065 to 26665	26065, 26365, 26665	5MHz	QPSK,16QAM, 64QAM	1 RB / 0 RB Offset
		26090 to 26640	26090, 26365 26640	10MHz	QPSK,16QAM, 64QAM	1 RB / 0 RB Offset
		26115 to 26615	26115, 26365, 26615	15MHz	QPSK,16QAM, 64QAM	1 RB / 0 RB Offset
		26140 to 26590	26140, 26365, 26590	20MHz	QPSK,16QAM, 64QAM	1 RB / 0 RB Offset



Test Report No.: RF180829W002-5

B	BAND EDGE	26047 to 26683	26047	1.4MHz	QPSK	1 RB / 0 RB Offset		
			26683	1.4MHz	QPSK	6 RB / 0 RB Offset		
		26055 to 26675	26055	3MHz	QPSK	1 RB / 5 RB Offset		
			26675	3MHz	QPSK	6 RB / 0 RB Offset		
		26065 to 26665	26065	5MHz	QPSK	1 RB / 0 RB Offset		
			26665	5MHz	QPSK	15 RB / 0 RB Offset		
		26090 to 26640	26090	10MHz	QPSK	1 RB / 14 RB Offset		
			26640	10MHz	QPSK	15 RB / 0 RB Offset		
		26115 to 26615	26065	5MHz	QPSK	1 RB / 0 RB Offset		
			26615	15MHz	QPSK	25 RB / 0 RB Offset		
		26140 to 26590	26090	10MHz	QPSK	1 RB / 24 RB Offset		
			26590	20MHz	QPSK	25 RB / 0 RB Offset		
		26115 to 26615	26115	15MHz	QPSK	1 RB / 0 RB Offset		
			26615	15MHz	QPSK	50 RB / 0 RB Offset		
		26140 to 26590	26140	20MHz	QPSK	1 RB / 49 RB Offset		
			26590	20MHz	QPSK	50 RB / 0 RB Offset		
		B	CONDCUETED EMISSION	26047 to 26683	26047, 26365, 26683	1.4MHz	QPSK	1 RB / 0 RB Offset
				26055 to 26675	26055, 26365, 26675	3MHz	QPSK	1 RB / 0 RB Offset
26065 to 26665	26065, 26365, 26665			5MHz	QPSK	1 RB / 0 RB Offset		
26090 to 26640	26090, 26365, 26640			10MHz	QPSK	1 RB / 0 RB Offset		
26115 to 26615	26115, 26365, 26615			15MHz	QPSK	1 RB / 0 RB Offset		
26140 to 26590	26140, 26365, 26590			20MHz	QPSK	1 RB / 0 RB Offset		
A	RADIATED EMISSION	26047 to 26683	26047, 26365, 26683	1.4MHz	QPSK	1 RB / 0 RB Offset		
		26055 to 26675	26365	3MHz	QPSK	1 RB / 0 RB Offset		
		26065 to 26665	26365	5MHz	QPSK	1 RB / 0 RB Offset		
		26090 to 26640	26365	10MHz	QPSK	1 RB / 0 RB Offset		
		26115 to 26615	26365	15MHz	QPSK	1 RB / 0 RB Offset		
		26140 to 26590	26365	20MHz	QPSK	1 RB / 0 RB Offset		

TEST CONDITION:

TEST ITEM	ENVIRONMENTAL CONDITIONS	INPUT POWER	TESTED BY
EIRP	25deg. C, 57%RH	3.7Vdc from Battery	Rose Ma
FREQUENCY STABILITY	23deg. C, 61%RH	DC 3.4V/3.7V/4.2V	Rain Wang
OCCUPIED BANDWIDTH	23deg. C, 61%RH	3.7Vdc from Battery	Rain Wang
PEAK TO AVERAGE RATIO	23deg. C, 61%RH	3.7Vdc from Battery	Rain Wang
BAND EDGE	23deg. C, 61%RH	3.7Vdc from Battery	Rain Wang
CONDCUETED EMISSION	23deg. C, 61%RH	3.7Vdc from Battery	Rain Wang
RADIATED EMISSION	23deg. C, 70%RH	DC 5V from adaptor	Rose Ma



Test Report No.: RF180829W002-5

2.5 EUT OPERATING CONDITIONS

The EUT makes a call to the communication simulator. The communication simulator station system controlled a EUT to export maximum output power under transmission mode and specific channel frequency

2.6 GENERAL DESCRIPTION OF APPLIED STANDARDS

The EUT is a RF product. According to the specifications of the manufacturer, it must comply with the requirements of the following standards:

FCC 47 CFR Part 2

FCC 47 CFR Part 24

KDB 971168 D01 Power Meas License Digital Systems v03

ANSI/TIA/EIA-603-D

ANSI/TIA/EIA-603-E

ANSI C63.26-2015

NOTE: All test items have been performed and recorded as per the above standards.



3 TEST TYPES AND RESULTS

3.1 OUTPUT POWER MEASUREMENT

3.1.1 LIMITS OF OUTPUT POWER MEASUREMENT

Mobile and portable stations are limited to 2 watts EIRP.

3.1.2 TEST PROCEDURES

EIRP MEASUREMENT:

- a. All measurements were done at low, middle and high operational frequency range. RBW and VBW is 1MHz for GSM, GPRS, EDGE & CDMA, 5MHz for WCDMA mode and 10MHz for LTE mode.
- b. Substitution method is used for E.I.R.P measurement. In the semi-anechoic chamber, EUT placed on the 0.8m height of Turn Table, rotated the table around 360 degrees to search the maximum radiation power and receiver antenna shall be rotated vertical and horizontal polarization and moved height from 1m to 4m to find the maximum polar radiated power. The “Read Value” is the spectrum reading the maximum power value.
- c. The substitution horn antenna is substituted for EUT at the same position and signals generator export the CW signal to the substitution antenna via a tx cable. Rotated the Turn Table and moved receiving antenna to find the maximum radiation power. Adjust output power level of S.G to get a Value of spectrum reading equal to “Read Value “ of step b. Record the power level of S.G
- d. $EIRP = \text{Output power level of S.G} - \text{TX cable loss} + \text{Antenna gain of substitution horn.}$

CONDUCTED POWER MEASUREMENT:

The EUT was set up for the maximum power with GSM, GPRS, EDGE & WCDMA link data modulation and link up with simulator. Set the EUT to transmit under low, middle and high channel and record the power level shown on simulator.

3.1.3 TEST SETUP

EIRP / ERP Measurement:

<Radiated Emission below or equal 1 GHz>

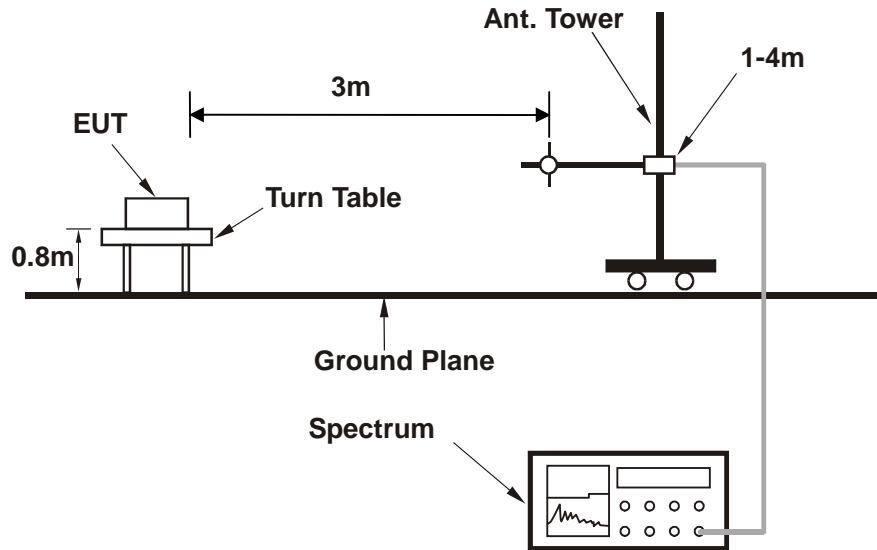

<Radiated Emission above 1 GHz>

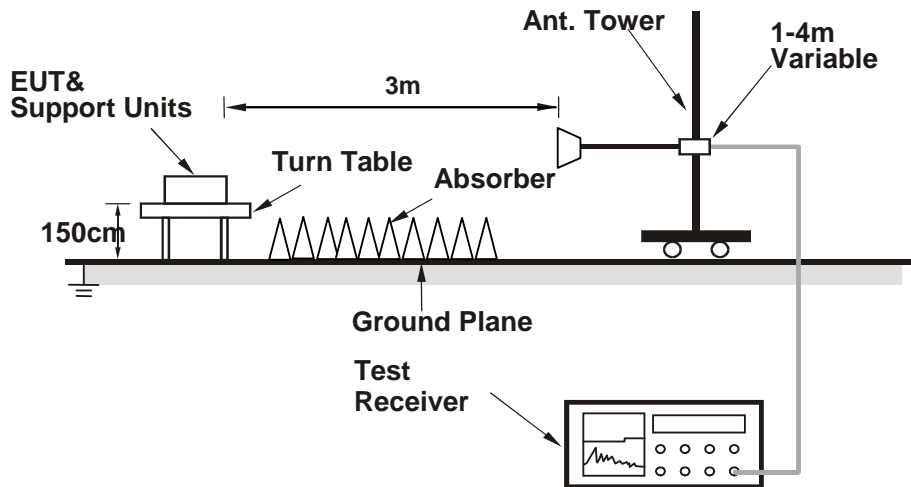

For the actual test configuration, please refer to the attached file (Test Setup Photo).

CONDUCTED POWER MEASUREMENT:

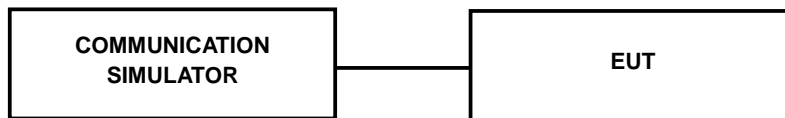



3.1.4 TEST RESULTS

CONDUCTED OUTPUT POWER (dBm)

Band	GSM1900		
Channel	512	661	810
Frequency (MHz)	1850.2	1880.0	1909.8
GSM	28.49	28.53	28.45
GPRS 8	28.48	28.52	28.44
GPRS 10	28.04	28.08	28.00
GPRS 11	26.87	26.91	26.83
GPRS 12	25.31	25.35	25.27
EDGE 8 (MCS9)	24.97	25.01	24.93
EDGE 10 (MCS9)	24.81	24.85	24.77
EDGE 11 (MCS9)	23.59	23.63	23.55
EDGE 12 (MCS9)	22.36	22.40	22.32

Band	WCDMA II		
Channel	9262	9400	9538
Frequency (MHz)	1852.4	1880.0	1907.6
RMC 12.2K	23.40	23.81	23.85
HSPA			
HSDPA Subtest-1	22.08	22.49	22.53
HSDPA Subtest-2	22.03	22.44	22.48
HSDPA Subtest-3	21.55	21.96	22.00
HSDPA Subtest-4	21.52	21.93	21.97
HSUPA Subtest-1	22.04	22.45	22.49
HSUPA Subtest-2	20.18	20.59	20.63
HSUPA Subtest-3	21.16	21.57	21.61
HSUPA Subtest-4	20.15	20.56	20.60
HSUPA Subtest-5	22.14	22.55	22.59

Band	CDMA2000 BC1		
Channel	1013	384	777
Frequency (MHz)	1851.25	1880	1908.75
RC1+SO55	24.73	24.76	24.74
RC3+SO55	24.68	24.81	24.70
RC3+SO32(FCH)	24.76	24.85	24.77
RC3+SO32(SCH)	23.43	23.52	23.44
RTAP 153.6	24.47	24.57	24.49
RETAP 4096	24.45	24.54	24.46
RC1+SO3	23.96	24.05	23.97
RC3+SO3	23.86	23.95	23.87



Test Report No.: RF180829W002-5

LTE Band 2							
BW	Modulation	RB Size	RB Offset	Low CH 18607	Mid CH 18900	High CH 19193	3GPP MPR (dB)
				Frequency 1850.7 MHz	Frequency 1880 MHz	Frequency 1909.3 MHz	
1.4MHz	QPSK	1	0	23.55	23.72	23.69	0
		1	2	23.48	23.65	23.62	0
		1	5	23.32	23.49	23.46	0
		3	0	23.54	23.71	23.68	0
		3	1	23.47	23.64	23.61	0
		3	3	23.31	23.48	23.45	0
	16QAM	6	0	22.43	22.60	22.57	1
		1	0	22.06	22.23	22.20	1
		1	2	22.25	22.42	22.39	1
		1	5	21.86	22.03	22.00	1
		3	0	22.04	22.21	22.18	1
		3	1	22.23	22.40	22.37	1
	64QAM	3	3	21.84	22.01	21.98	1
		6	0	21.45	21.62	21.59	2
		1	0	21.51	21.68	21.65	2
		1	2	22.32	22.49	22.46	2
		1	5	21.54	21.71	21.68	2
		3	0	21.49	21.66	21.63	3
		3	1	22.30	22.47	22.44	3
		3	3	21.52	21.69	21.66	3
	6	0	20.54	20.71	20.68	3	

LTE Band 2							
BW	Modulation	RB Size	RB Offset	Low CH 18615	Mid CH 18900	High CH 19185	3GPP MPR (dB)
				Frequency 1851.5 MHz	Frequency 1880 MHz	Frequency 1908.5 MHz	
3MHz	QPSK	1	0	23.58	23.75	23.72	0
		1	7	23.51	23.68	23.65	0
		1	14	23.35	23.52	23.49	0
		8	0	22.57	22.74	22.71	1
		8	3	22.46	22.63	22.60	1
		8	7	22.44	22.61	22.58	1
		15	0	22.46	22.63	22.60	1
	16QAM	1	0	22.09	22.26	22.23	1
		1	7	22.28	22.45	22.42	1
		1	14	21.89	22.06	22.03	1
		8	0	21.51	21.68	21.65	2
		8	3	21.48	21.65	21.62	2
		8	7	21.57	21.74	21.71	2
		15	0	21.48	21.65	21.62	2
	64QAM	1	0	21.54	21.71	21.68	2
		1	7	22.35	22.52	22.49	2
		1	14	21.57	21.74	21.71	2
		8	0	20.61	20.78	20.75	3
		8	3	20.49	20.66	20.63	3
		8	7	20.44	20.61	20.58	3
		15	0	20.57	20.74	20.71	3

LTE Band 2							
BW	Modulation	RB Size	RB Offset	Low CH 18625	Mid CH 18900	High CH 19175	3GPP MPR (dB)
				Frequency 1852.5 MHz	Frequency 1880 MHz	Frequency 1907.5 MHz	
5MHz	QPSK	1	0	23.61	23.78	23.75	0
		1	12	23.54	23.71	23.68	0
		1	24	23.38	23.55	23.52	0
		12	0	22.60	22.77	22.74	1
		12	6	22.49	22.66	22.63	1
		12	13	22.47	22.64	22.61	1
		25	0	22.49	22.66	22.63	1
	16QAM	1	0	22.12	22.29	22.26	1
		1	12	22.31	22.48	22.45	1
		1	24	21.92	22.09	22.06	1
		12	0	21.54	21.71	21.68	2
		12	6	21.51	21.68	21.65	2
		12	13	21.60	21.77	21.74	2
		25	0	21.51	21.68	21.65	2
	64QAM	1	0	21.57	21.74	21.71	2
		1	12	22.38	22.55	22.52	2
		1	24	21.60	21.77	21.74	2
		12	0	20.64	20.81	20.78	3
		12	6	20.52	20.69	20.66	3
		12	13	20.47	20.64	20.61	3
		12	13	20.47	20.64	20.61	3
25		0	20.60	20.77	20.74	3	

LTE Band 2							
BW	Modulation	RB Size	RB Offset	Low CH 18650	Mid CH 18900	High CH 19150	3GPP MPR (dB)
				Frequency 1855 MHz	Frequency 1880 MHz	Frequency 1905 MHz	
10MHz	QPSK	1	0	23.63	23.80	23.77	0
		1	24	23.56	23.73	23.70	0
		1	49	23.40	23.57	23.54	0
		25	0	22.62	22.79	22.76	1
		25	12	22.51	22.68	22.65	1
		25	25	22.49	22.66	22.63	1
		50	0	22.51	22.68	22.65	1
	16QAM	1	0	22.14	22.31	22.28	1
		1	24	22.33	22.50	22.47	1
		1	49	21.94	22.11	22.08	1
		25	0	21.56	21.73	21.70	2
		25	12	21.53	21.70	21.67	2
		25	25	21.62	21.79	21.76	2
		50	0	21.53	21.70	21.67	2
	64QAM	1	0	21.59	21.76	21.73	2
		1	24	22.40	22.57	22.54	2
		1	49	21.62	21.79	21.76	2
		25	0	20.66	20.83	20.80	3
		25	12	20.54	20.71	20.68	3
		25	25	20.49	20.66	20.63	3
		50	0	20.62	20.79	20.76	3

LTE Band 2							
BW	Modulation	RB Size	RB Offset	Low CH 18675	Mid CH 18900	High CH 19125	3GPP MPR (dB)
				Frequency 1857.5 MHz	Frequency 1880 MHz	Frequency 1902.5 MHz	
15MHz	QPSK	1	0	23.66	23.83	23.80	0
		1	37	23.59	23.76	23.73	0
		1	74	23.43	23.60	23.57	0
		36	0	22.65	22.82	22.79	1
		36	19	22.54	22.71	22.68	1
		36	39	22.52	22.69	22.66	1
		75	0	22.54	22.71	22.68	1
	16QAM	1	0	22.17	22.34	22.31	1
		1	37	22.36	22.53	22.50	1
		1	74	21.97	22.14	22.11	1
		36	0	21.59	21.76	21.73	2
		36	19	21.56	21.73	21.70	2
		36	39	21.65	21.82	21.79	2
		75	0	21.56	21.73	21.70	2
	64QAM	1	0	21.62	21.79	21.76	2
		1	37	22.43	22.60	22.57	2
		1	74	21.65	21.82	21.79	2
		36	0	20.69	20.86	20.83	3
		36	19	20.57	20.74	20.71	3
		36	39	20.52	20.69	20.66	3
		75	0	20.65	20.82	20.79	3

LTE Band 2							
BW	Modulation	RB Size	RB Offset	Low CH 18700	Mid CH 18900	High CH 19100	3GPP MPR (dB)
				Frequency 1860 MHz	Frequency 1880 MHz	Frequency 1900 MHz	
20MHz	QPSK	1	0	23.71	23.88	23.85	0
		1	50	23.64	23.81	23.78	0
		1	99	23.48	23.65	23.62	0
		50	0	22.70	22.87	22.84	1
		50	25	22.59	22.76	22.73	1
		50	50	22.57	22.74	22.71	1
		100	0	22.59	22.76	22.73	1
	16QAM	1	0	22.22	22.39	22.36	1
		1	50	22.41	22.58	22.55	1
		1	99	22.02	22.19	22.16	1
		50	0	21.64	21.81	21.78	2
		50	25	21.61	21.78	21.75	2
		50	50	21.70	21.87	21.84	2
		100	0	21.61	21.78	21.75	2
	64QAM	1	0	21.67	21.84	21.81	2
		1	50	22.48	22.65	22.62	2
		1	99	21.70	21.87	21.84	2
		50	0	20.74	20.91	20.88	3
		50	25	20.62	20.79	20.76	3
		50	50	20.57	20.74	20.71	3
		100	0	20.70	20.87	20.84	3



Test Report No.: RF180829W002-5

LTE Band 25							
BW	Modulation	RB Size	RB Offset	Low CH 26047	Mid CH 26365	High CH 26683	3GPP MPR (dB)
				Frequency 1850.7 MHz	Frequency 1882.5 MHz	Frequency 1914.3 MHz	
1.4MHz	QPSK	1	0	23.51	23.70	23.63	0
		1	2	23.53	23.65	23.63	0
		1	5	23.50	23.60	23.56	0
		3	0	23.50	23.63	23.63	0
		3	1	23.49	23.63	23.51	0
		3	3	23.35	23.47	23.43	0
		6	0	22.53	22.63	22.61	1
	16QAM	1	0	22.32	22.45	22.41	1
		1	2	22.32	22.41	22.41	1
		1	5	22.24	22.36	22.37	1
		3	0	22.72	22.86	22.80	1
		3	1	22.62	22.84	22.74	1
		3	3	22.62	22.76	22.74	1
		6	0	21.32	21.51	21.42	2
	64QAM	1	0	21.77	21.94	21.91	2
		1	2	21.72	21.93	21.84	2
		1	5	21.74	21.83	21.83	2
		3	0	21.56	21.73	21.65	3
		3	1	21.54	21.73	21.63	3
		3	3	21.51	21.63	21.64	3
		6	0	20.48	20.62	20.56	3



Test Report No.: RF180829W002-5

LTE Band 25							
BW	Modulation	RB Size	RB Offset	Low CH 26055	Mid CH 26365	High CH 26675	3GPP MPR (dB)
				Frequency 1851.5 MHz	Frequency 1882.5 MHz	Frequency 1913.5 MHz	
3MHz	QPSK	1	0	23.53	23.72	23.62	0
		1	7	23.49	23.66	23.63	0
		1	14	23.46	23.60	23.56	0
		8	0	22.49	22.66	22.63	1
		8	3	22.42	22.63	22.53	1
		8	7	22.32	22.54	22.47	1
		15	0	22.50	22.64	22.55	1
	16QAM	1	0	22.29	22.51	22.44	1
		1	7	22.29	22.44	22.39	1
		1	14	22.27	22.36	22.37	1
		8	0	21.68	21.87	21.80	2
		8	3	21.67	21.79	21.77	2
		8	7	21.64	21.74	21.70	2
		15	0	21.32	21.45	21.45	2
	64QAM	1	0	21.83	21.97	21.85	2
		1	7	21.75	21.87	21.83	2
		1	14	21.75	21.85	21.83	2
		8	0	20.59	20.77	20.66	3
		8	3	20.58	20.67	20.68	3
		8	7	20.48	20.67	20.60	3
		15	0	20.50	20.59	20.60	3

LTE Band 25							
BW	Modulation	RB Size	RB Offset	Low CH 26065	Mid CH 26365	High CH 26665	3GPP MPR (dB)
				Frequency 1852.5 MHz	Frequency 1882.5 MHz	Frequency 1912.5 MHz	
5MHz	QPSK	1	0	23.54	23.67	23.63	0
		1	12	23.54	23.63	23.63	0
		1	24	23.47	23.59	23.60	0
		12	0	22.52	22.66	22.60	1
		12	6	22.42	22.64	22.54	1
		12	13	22.36	22.50	22.48	1
		25	0	22.48	22.67	22.58	1
	16QAM	1	0	22.30	22.47	22.44	1
		1	12	22.26	22.47	22.38	1
		1	24	22.27	22.36	22.36	1
		12	0	21.68	21.85	21.77	2
		12	6	21.64	21.83	21.73	2
		12	13	21.59	21.76	21.73	2
		25	0	21.32	21.46	21.42	2
	64QAM	1	0	21.77	21.94	21.91	2
		1	12	21.72	21.93	21.83	2
		1	24	21.68	21.90	21.83	2
		12	0	20.60	20.74	20.65	3
		12	6	20.52	20.74	20.67	3
		12	13	20.52	20.66	20.57	3
		12	13	20.52	20.66	20.57	3
		25	0	20.46	20.65	20.58	3

LTE Band 25							
BW	Modulation	RB Size	RB Offset	Low CH 26090	Mid CH 26365	High CH 26640	3GPP MPR (dB)
				Frequency 1855 MHz	Frequency 1882.5 MHz	Frequency 1910 MHz	
10MHz	QPSK	1	0	23.51	23.70	23.63	0
		1	24	23.54	23.63	23.64	0
		1	49	23.44	23.63	23.56	0
		25	0	22.53	22.65	22.63	1
		25	12	22.48	22.58	22.54	1
		25	25	22.34	22.47	22.47	1
		50	0	22.53	22.67	22.55	1
	16QAM	1	0	22.30	22.44	22.40	1
		1	24	22.31	22.43	22.41	1
		1	49	22.27	22.37	22.33	1
		25	0	21.70	21.83	21.83	2
		25	12	21.68	21.77	21.78	2
		25	25	21.58	21.77	21.70	2
		50	0	21.36	21.45	21.46	2
	64QAM	1	0	21.76	21.95	21.88	2
		1	24	21.77	21.89	21.87	2
		1	49	21.74	21.84	21.80	2
		25	0	20.58	20.71	20.71	3
		25	12	20.59	20.73	20.61	3
		25	25	20.51	20.63	20.59	3
		50	0	20.51	20.61	20.59	3

LTE Band 25							
BW	Modulation	RB Size	RB Offset	Low CH 26115	Mid CH 26365	High CH 26615	3GPP MPR (dB)
				Frequency 1857.5 MHz	Frequency 1882.5 MHz	Frequency 1907.5 MHz	
15MHz	QPSK	1	0	23.58	23.70	23.60	0
		1	37	23.52	23.68	23.59	0
		1	74	23.50	23.66	23.57	0
		36	0	22.50	22.66	22.64	1
		36	19	22.49	22.63	22.54	1
		36	39	22.32	22.48	22.47	1
		75	0	22.53	22.65	22.60	1
	16QAM	1	0	22.34	22.51	22.40	1
		1	37	22.30	22.44	22.41	1
		1	74	22.23	22.42	22.35	1
		36	0	21.74	21.83	21.84	2
		36	19	21.62	21.81	21.74	2
		36	39	21.63	21.75	21.73	2
		75	0	21.37	21.48	21.39	2
	64QAM	1	0	21.78	21.96	21.89	2
		1	37	21.78	21.88	21.84	2
		1	74	21.70	21.83	21.83	2
		36	0	20.63	20.77	20.65	3
		36	19	20.53	20.67	20.63	3
		36	39	20.54	20.70	20.61	3
		75	0	20.50	20.59	20.60	3

LTE Band 25							
BW	Modulation	RB Size	RB Offset	Low CH 26140	Mid CH 26365	High CH 26590	3GPP MPR (dB)
				Frequency 1860 MHz	Frequency 1882.5 MHz	Frequency 1905 MHz	
20MHz	QPSK	1	0	23.59	23.74	23.68	0
		1	50	23.56	23.71	23.65	0
		1	99	23.52	23.67	23.61	0
		50	0	22.56	22.71	22.65	1
		50	25	22.50	22.65	22.59	1
		50	50	22.40	22.55	22.49	1
		100	0	22.54	22.69	22.63	1
	16QAM	1	0	22.37	22.52	22.46	1
		1	50	22.34	22.49	22.43	1
		1	99	22.29	22.44	22.38	1
		50	0	21.76	21.91	21.85	2
		50	25	21.70	21.85	21.79	2
		50	50	21.66	21.81	21.75	2
		100	0	21.38	21.53	21.47	2
	64QAM	1	0	21.84	21.99	21.93	2
		1	50	21.80	21.95	21.89	2
		1	99	21.76	21.91	21.85	2
		50	0	20.64	20.79	20.73	3
		50	25	20.60	20.75	20.69	3
		50	50	20.56	20.71	20.65	3
		100	0	20.52	20.67	20.61	3



Test Report No.: RF180829W002-5

EIRP POWER (dBm)

GSM

Channel	Frequency (MHz)	SPA LVL (dBm)	Correction Factor(dB)	EIRP(dBm)	EIRP(mW)	Polarization (H/V)
512	1850.2	-14.13	43.83	29.70	933.25	H
661	1880.0	-14.72	43.57	28.85	767.36	H
810	1909.8	-14.88	44.57	29.69	931.11	H
512	1850.2	-21.83	46.39	24.56	285.76	V
661	1880.0	-22.24	47.10	24.86	306.06	V
810	1909.8	-21.11	45.98	24.87	306.62	V

REMARKS: 1. EIRP Output Power (dBm) = SPA LVL (dBm) + Correction Factor (dB).
 2. Correction factor (dB) = Free Space Loss + Antenna Factor + Cable Loss

EDGE

Channel	Frequency (MHz)	SPA LVL (dBm)	Correction Factor(dB)	EIRP(dBm)	EIRP(mW)	Polarization (H/V)
512	1850.2	-15.67	43.83	28.16	654.64	H
661	1880.0	-15.59	43.57	27.98	628.06	H
810	1909.8	-15.89	44.57	28.68	737.90	H
512	1850.2	-22.56	46.39	23.83	241.55	V
661	1880.0	-23.36	47.10	23.74	236.48	V
810	1909.8	-22.79	45.98	23.19	208.26	V

REMARKS: 1. EIRP Output Power (dBm) = SPA LVL (dBm) + Correction Factor (dB).
 2. Correction factor (dB) = Free Space Loss + Antenna Factor + Cable Loss

WCDMA

Channel	Frequency (MHz)	SPA LVL (dBm)	Correction Factor(dB)	EIRP(dBm)	EIRP(mW)	Polarization (H/V)
9262	1852.4	-19.12	43.83	24.71	295.80	H
9400	1880.0	-19.65	43.57	23.92	246.60	H
9538	1907.6	-18.98	44.57	25.59	362.24	H
9262	1852.4	-25.51	46.39	20.88	122.46	V
9400	1880.0	-27.03	47.10	20.07	101.58	V
9538	1907.6	-25.38	45.98	20.60	114.71	V

REMARKS: 1. EIRP Output Power (dBm) = SPA LVL (dBm) + Correction Factor (dB).
 2. Correction factor (dB) = Free Space Loss + Antenna Factor + Cable Loss



Test Report No.: RF180829W002-5

CDMA BC 1

Channel	Frequency (MHz)	SPA LVL (dBm)	Correction Factor(dB)	ERP(dBm)	ERP(mW)	Polarization (H/V)
25	1851.3	-22.89	43.83	20.94	124.17	H
600	1880.0	-22.72	43.57	20.85	121.62	H
1175	1908.8	-23.06	44.57	21.51	141.58	H
25	1851.3	-34.18	46.39	12.21	16.63	V
600	1880.0	-35.35	47.10	11.75	14.96	V
1175	1908.8	-35.09	45.98	10.89	12.26	V

REMARKS: 1. ERP Output Power (dBm) = SPA LVL (dBm) + Correction Factor (dB) -2.15(dB).
 2. Correction factor (dB) = Free Space Loss + Antenna Factor + Cable Loss

LTE BAND 2

CHANNEL BANDWIDTH: 1.4MHz QPSK

Channel	Frequency (MHz)	SPA LVL (dBm)	Correction Factor(dB)	EIRP(dBm)	EIRP(mW)	Polarization (H/V)	LIMIT (W)
18607	1850.7	-18.52	43.83	25.31	339.94	H	2
18900	1880.0	-18.54	43.57	25.03	318.42	H	2
19193	1909.3	-20.37	44.32	23.95	248.26	H	2
18607	1850.7	-26.97	46.41	19.44	87.92	V	2
18900	1880.0	-26.62	47.07	20.45	110.92	V	2
19193	1909.3	-28.52	45.88	17.36	54.50	V	2

CHANNEL BANDWIDTH: 1.4MHz 16QAM

Channel	Frequency (MHz)	SPA LVL (dBm)	Correction Factor(dB)	EIRP(dBm)	EIRP(mW)	Polarization (H/V)	LIMIT (W)
18607	1850.7	-19.39	43.83	24.44	278.23	H	2
18900	1880.0	-19.47	43.57	24.10	257.04	H	2
19193	1909.3	-21.33	44.32	22.99	199.02	H	2
18607	1850.7	-27.84	46.41	18.57	71.96	V	2
18900	1880.0	-27.55	47.07	19.52	89.54	V	2
19193	1909.3	-29.48	45.88	16.40	43.69	V	2



Test Report No.: RF180829W002-5

CHANNEL BANDWIDTH: 1.4MHZ 64QAM

Channel	Frequency (MHz)	SPA LVL (dBm)	Correction Factor(dB)	EIRP(dBm)	EIRP(mW)	Polarization (H/V)	LIMIT (W)
18607	1850.7	-20.12	43.83	23.71	235.18	H	2
18900	1880.0	-20.64	43.57	22.93	196.34	H	2
19193	1908.3	-22.22	44.32	22.10	162.14	H	2
18607	1850.7	-29.07	46.41	17.34	54.21	V	2
18900	1880.0	-28.65	47.07	18.42	69.50	V	2
19193	1908.3	-30.46	45.88	15.42	34.87	V	2

CHANNEL BANDWIDTH: 3MHz QPSK

Channel	Frequency (MHz)	SPA LVL (dBm)	Correction Factor(dB)	EIRP(dBm)	EIRP(mW)	Polarization (H/V)	LIMIT (W)
18615	1851.5	-18.50	43.82	25.32	340.56	H	2
18900	1880.0	-18.60	43.57	24.97	314.05	H	2
19185	1908.5	-20.32	44.38	24.06	254.45	H	2
18615	1851.5	-26.95	46.45	19.50	89.15	V	2
18900	1880.0	-26.68	47.07	20.39	109.40	V	2
19185	1908.5	-28.47	45.88	17.41	55.08	V	2

CHANNEL BANDWIDTH: 3MHz 16QAM

Channel	Frequency (MHz)	SPA LVL (dBm)	Correction Factor(dB)	EIRP(dBm)	EIRP(mW)	Polarization (H/V)	LIMIT (W)
18615	1851.5	-19.57	43.82	24.25	266.20	H	2
18900	1880.0	-19.49	43.57	24.08	255.86	H	2
19185	1908.5	-21.31	44.38	23.07	202.58	H	2
18615	1851.5	-28.02	46.45	18.43	69.68	V	2
18900	1880.0	-27.57	47.07	19.50	89.13	V	2
19185	1908.5	-29.46	45.88	16.42	43.85	V	2



CHANNEL BANDWIDTH: 3MHZ 64QAM

Channel	Frequency (MHz)	SPA LVL (dBm)	Correction Factor(dB)	EIRP(dBm)	EIRP(mW)	Polarization (H/V)	LIMIT (W)
18615	1851.5	-20.10	43.82	23.72	235.61	H	2
18900	1880.0	-20.70	43.57	22.87	193.64	H	2
19185	1908.5	-22.17	44.38	22.21	166.19	H	2
18615	1851.5	-29.05	46.45	17.40	54.97	V	2
18900	1880.0	-28.71	47.07	18.36	68.55	V	2
19185	1908.5	-30.41	45.88	15.47	35.24	V	2

CHANNEL BANDWIDTH: 5MHz QPSK

Channel	Frequency (MHz)	SPA LVL (dBm)	Correction Factor(dB)	EIRP(dBm)	EIRP(mW)	Polarization (H/V)	LIMIT (W)
18625	1852.5	-18.56	43.83	25.27	336.36	H	2
18900	1880.0	-18.55	43.57	25.02	317.69	H	2
19175	1907.5	-20.27	44.19	23.92	246.49	H	2
18625	1852.5	-27.01	46.46	19.45	88.17	V	2
18900	1880.0	-26.63	47.07	20.44	110.66	V	2
19175	1907.5	-28.42	45.89	17.47	55.86	V	2

CHANNEL BANDWIDTH: 5MHz 16QAM

Channel	Frequency (MHz)	SPA LVL (dBm)	Correction Factor(dB)	EIRP(dBm)	EIRP(mW)	Polarization (H/V)	LIMIT (W)
18625	1852.5	-19.39	43.83	24.44	277.84	H	2
18900	1880.0	-19.57	43.57	24.00	251.19	H	2
19175	1907.5	-21.37	44.19	22.82	191.34	H	2
18625	1852.5	-27.84	46.46	18.62	72.83	V	2
18900	1880.0	-27.65	47.07	19.42	87.50	V	2
19175	1907.5	-29.52	45.89	16.37	43.36	V	2



CHANNEL BANDWIDTH: 5MHZ 64QAM

Channel	Frequency (MHz)	SPA LVL (dBm)	Correction Factor(dB)	EIRP(dBm)	EIRP(mW)	Polarization (H/V)	LIMIT (W)
18625	1852.5	-20.16	43.83	23.67	232.70	H	2
18900	1880.0	-20.65	43.57	22.92	195.88	H	2
19175	1907.5	-22.12	44.19	22.07	160.99	H	2
18625	1852.5	-29.11	46.46	17.35	54.36	V	2
18900	1880.0	-28.66	47.07	18.41	69.34	V	2
19175	1907.5	-30.36	45.89	15.53	35.74	V	2

CHANNEL BANDWIDTH: 10MHz QPSK

Channel	Frequency (MHz)	SPA LVL (dBm)	Correction Factor(dB)	EIRP(dBm)	EIRP(mW)	Polarization (H/V)	LIMIT (W)
18650	1855.0	-18.37	43.86	25.49	354.08	H	2
18900	1880.0	-18.49	43.57	25.08	322.11	H	2
19150	1905.0	-20.14	43.99	23.85	242.88	H	2
18650	1855.0	-26.82	46.28	19.46	88.27	V	2
18900	1880.0	-26.57	47.07	20.50	112.20	V	2
19150	1905.0	-28.29	45.92	17.63	57.97	V	2

CHANNEL BANDWIDTH: 10MHz 16QAM

Channel	Frequency (MHz)	SPA LVL (dBm)	Correction Factor(dB)	EIRP(dBm)	EIRP(mW)	Polarization (H/V)	LIMIT (W)
18650	1855.0	-19.52	43.86	24.34	271.71	H	2
18900	1880.0	-19.59	43.57	23.98	250.03	H	2
19150	1905.0	-21.30	43.99	22.69	185.95	H	2
18650	1855.0	-27.97	46.28	18.31	67.73	V	2
18900	1880.0	-27.67	47.07	19.40	87.10	V	2
19150	1905.0	-29.45	45.92	16.47	44.38	V	2



CHANNEL BANDWIDTH: 10MHz 64QAM

Channel	Frequency (MHz)	SPA LVL (dBm)	Correction Factor(dB)	EIRP(dBm)	EIRP(mW)	Polarization (H/V)	LIMIT (W)
18650	1855.0	-19.97	43.86	23.89	244.96	H	2
18900	1880.0	-20.59	43.57	22.98	198.61	H	2
19150	1905.0	-21.99	43.99	22.00	158.64	H	2
18650	1855.0	-28.92	46.28	17.36	54.43	V	2
18900	1880.0	-28.60	47.07	18.47	70.31	V	2
19150	1905.0	-30.23	45.92	15.69	37.09	V	2

CHANNEL BANDWIDTH: 15MHz QPSK

Channel	Frequency (MHz)	SPA LVL (dBm)	Correction Factor(dB)	EIRP(dBm)	EIRP(mW)	Polarization (H/V)	LIMIT (W)
18675	1857.5	-18.38	43.99	25.61	364.08	H	2
18900	1880.0	-18.56	43.57	25.01	316.96	H	2
19125	1902.5	-20.21	43.66	23.45	221.05	H	2
18675	1857.5	-26.83	45.93	19.10	81.23	V	2
18900	1880.0	-26.64	47.07	20.43	110.41	V	2
19125	1902.5	-28.36	46.20	17.84	60.84	V	2

CHANNEL BANDWIDTH: 15MHz 16QAM

Channel	Frequency (MHz)	SPA LVL (dBm)	Correction Factor(dB)	EIRP(dBm)	EIRP(mW)	Polarization (H/V)	LIMIT (W)
18675	1857.5	-19.24	43.99	24.75	298.68	H	2
18900	1880.0	-19.43	43.57	24.14	259.42	H	2
19125	1902.5	-21.06	43.66	22.60	181.76	H	2
18675	1857.5	-27.69	45.93	18.24	66.63	V	2
18900	1880.0	-27.51	47.07	19.56	90.36	V	2
19125	1902.5	-29.21	46.20	16.99	50.03	V	2



CHANNEL BANDWIDTH: 15MHZ 64QAM

Channel	Frequency (MHz)	SPA LVL (dBm)	Correction Factor(dB)	EIRP(dBm)	EIRP(mW)	Polarization (H/V)	LIMIT (W)
18675	1857.5	-20.35	43.99	23.64	231.31	H	2
18900	1880.0	-20.66	43.57	22.91	195.43	H	2
19125	1902.5	-22.06	43.66	21.60	144.38	H	2
18675	1857.5	-28.93	45.93	17.00	50.08	V	2
18900	1880.0	-28.67	47.07	18.40	69.18	V	2
19125	1902.5	-30.30	46.20	15.90	38.92	V	2

CHANNEL BANDWIDTH: 20MHz QPSK

Channel	Frequency (MHz)	SPA LVL (dBm)	Correction Factor(dB)	EIRP(dBm)	EIRP(mW)	Polarization (H/V)	LIMIT (W)
18700	1860.0	-18.96	43.50	24.54	284.38	H	2
18900	1880.0	-19.01	43.57	24.56	285.76	H	2
19100	1900.0	-20.79	43.62	22.83	191.69	H	2
18700	1860.0	-27.41	45.57	18.16	65.46	V	2
18900	1880.0	-27.09	47.07	19.98	99.54	V	2
19100	1900.0	-28.94	46.26	17.32	53.96	V	2

CHANNEL BANDWIDTH: 20MHz 16QAM

Channel	Frequency (MHz)	SPA LVL (dBm)	Correction Factor(dB)	EIRP(dBm)	EIRP(mW)	Polarization (H/V)	LIMIT (W)
18700	1860.0	-19.89	43.50	23.61	229.56	H	2
18900	1880.0	-20.08	43.57	23.49	223.36	H	2
19100	1900.0	-21.62	43.62	22.00	158.34	H	2
18700	1860.0	-28.34	45.57	17.23	52.84	V	2
18900	1880.0	-28.16	47.07	18.91	77.80	V	2
19100	1900.0	-29.77	46.26	16.49	44.58	V	2



CHANNEL BANDWIDTH: 20MHZ 64QAM

Channel	Frequency (MHz)	SPA LVL (dBm)	Correction Factor(dB)	EIRP(dBm)	EIRP(mW)	Polarization (H/V)	LIMIT (W)
18700	1860.0	-20.56	43.50	22.94	196.74	H	2
18900	1880.0	-21.11	43.57	22.46	176.20	H	2
19100	1900.0	-22.64	43.62	20.98	125.20	H	2
18700	1860.0	-29.51	45.57	16.06	40.36	V	2
18900	1880.0	-29.12	47.07	17.95	62.37	V	2
19100	1900.0	-30.88	46.26	15.38	34.52	V	2

REMARKS: 1. EIRP Output Power (dBm) = SPA LVL (dBm) + Correction Factor (dB).
 2. Correction factor (dB) = Free Space Loss + Antenna Factor + Cable Loss

LTE BAND 25

CHANNEL BANDWIDTH: 1.4MHz QPSK

Channel	Frequency (MHz)	SPA LVL (dBm)	Correction Factor(dB)	EIRP(dBm)	EIRP(mW)	Polarization (H/V)	LIMIT (W)
26047	1850.7	-21.41	43.83	22.42	174.58	H	2
26340	1880.0	-19.90	43.57	23.68	233.08	H	2
26683	1914.3	-20.72	44.40	23.68	233.24	H	2
26047	1850.7	-29.33	46.41	17.09	51.12	V	2
26340	1880.0	-27.64	47.07	19.43	87.70	V	2
26683	1914.3	-29.12	45.99	16.87	48.69	V	2

CHANNEL BANDWIDTH: 1.4MHz 16QAM

Channel	Frequency (MHz)	SPA LVL (dBm)	Correction Factor(dB)	EIRP(dBm)	EIRP(mW)	Polarization (H/V)	LIMIT (W)
26047	1850.7	-22.28	43.83	21.55	142.89	H	2
26340	1880.0	-20.83	43.57	22.75	188.15	H	2
26683	1914.3	-21.68	44.40	22.72	186.98	H	2
26047	1850.7	-30.20	46.41	16.22	41.84	V	2
26340	1880.0	-28.57	47.07	18.50	70.79	V	2
26683	1914.3	-30.08	45.99	15.91	39.03	V	2



CHANNEL BANDWIDTH: 1.4MHZ 64QAM

Channel	Frequency (MHz)	SPA LVL (dBm)	Correction Factor(dB)	EIRP(dBm)	EIRP(mW)	Polarization (H/V)	LIMIT (W)
26047	1850.7	-23.21	43.83	20.62	115.35	H	2
26340	1880.0	-21.68	43.57	21.90	154.70	H	2
26683	1914.3	-23.02	44.40	21.38	137.40	H	2
26047	1850.7	-31.35	46.41	15.07	32.11	V	2
26340	1880.0	-28.08	47.07	18.99	79.25	V	2
26683	1914.3	-29.26	45.99	16.73	47.10	V	2

CHANNEL BANDWIDTH: 3MHz QPSK

Channel	Frequency (MHz)	SPA LVL (dBm)	Correction Factor(dB)	EIRP(dBm)	EIRP(mW)	Polarization (H/V)	LIMIT (W)
26055	1851.5	-21.39	43.82	22.43	174.90	H	2
26340	1880.0	-19.96	43.57	23.62	229.88	H	2
26675	1913.5	-20.67	44.38	23.70	234.64	H	2
26055	1851.5	-29.31	46.45	17.15	51.83	V	2
26340	1880.0	-27.70	47.07	19.37	86.50	V	2
26675	1913.5	-29.07	45.95	16.88	48.80	V	2

CHANNEL BANDWIDTH: 3MHz 16QAM

Channel	Frequency (MHz)	SPA LVL (dBm)	Correction Factor(dB)	EIRP(dBm)	EIRP(mW)	Polarization (H/V)	LIMIT (W)
26055	1851.5	-22.46	43.82	21.36	136.71	H	2
26340	1880.0	-20.85	43.57	22.73	187.28	H	2
26675	1913.5	-21.66	44.38	22.71	186.81	H	2
26055	1851.5	-30.38	46.45	16.08	40.51	V	2
26340	1880.0	-28.59	47.07	18.48	70.47	V	2
26675	1913.5	-30.06	45.95	15.89	38.85	V	2



CHANNEL BANDWIDTH: 3MHZ 64QAM

Channel	Frequency (MHz)	SPA LVL (dBm)	Correction Factor(dB)	EIRP(dBm)	EIRP(mW)	Polarization (H/V)	LIMIT (W)
26055	1851.5	-23.19	43.82	20.63	115.56	H	2
26340	1880.0	-21.74	43.57	21.84	152.58	H	2
26675	1913.5	-22.97	44.38	21.41	138.23	H	2
26055	1851.5	-31.33	46.45	15.13	32.55	V	2
26340	1880.0	-28.14	47.07	18.93	78.16	V	2
26675	1913.5	-29.21	45.95	16.74	47.21	V	2

CHANNEL BANDWIDTH: 5MHz QPSK

Channel	Frequency (MHz)	SPA LVL (dBm)	Correction Factor(dB)	EIRP(dBm)	EIRP(mW)	Polarization (H/V)	LIMIT (W)
26065	1852.5	-21.45	43.83	22.37	172.74	H	2
26340	1880.0	-19.91	43.57	23.67	232.54	H	2
26665	1912.5	-20.62	44.37	23.75	237.03	H	2
26065	1852.5	-29.37	46.46	17.10	51.26	V	2
26340	1880.0	-27.65	47.07	19.42	87.50	V	2
26665	1912.5	-29.02	45.90	16.88	48.80	V	2

CHANNEL BANDWIDTH: 5MHz 16QAM

Channel	Frequency (MHz)	SPA LVL (dBm)	Correction Factor(dB)	EIRP(dBm)	EIRP(mW)	Polarization (H/V)	LIMIT (W)
26065	1852.5	-22.28	43.83	21.54	142.69	H	2
26340	1880.0	-20.93	43.57	22.65	183.87	H	2
26665	1912.5	-21.72	44.37	22.65	183.99	H	2
26065	1852.5	-30.20	46.46	16.27	42.34	V	2
26340	1880.0	-28.67	47.07	18.40	69.18	V	2
26665	1912.5	-30.12	45.90	15.78	37.88	V	2



CHANNEL BANDWIDTH: 5MHZ 64QAM

Channel	Frequency (MHz)	SPA LVL (dBm)	Correction Factor(dB)	EIRP(dBm)	EIRP(mW)	Polarization (H/V)	LIMIT (W)
26065	1852.5	-23.25	43.83	20.57	114.13	H	2
26340	1880.0	-21.69	43.57	21.89	154.35	H	2
26665	1912.5	-22.92	44.37	21.45	139.64	H	2
26065	1852.5	-31.39	46.46	15.08	32.20	V	2
26340	1880.0	-28.09	47.07	18.98	79.07	V	2
26665	1912.5	-29.16	45.90	16.74	47.21	V	2

CHANNEL BANDWIDTH: 10MHz QPSK

Channel	Frequency (MHz)	SPA LVL (dBm)	Correction Factor(dB)	EIRP(dBm)	EIRP(mW)	Polarization (H/V)	LIMIT (W)
26090	1855.0	-21.26	43.86	22.60	181.84	H	2
26340	1880.0	-19.85	43.57	23.73	235.78	H	2
26640	1910.0	-20.49	44.32	23.83	241.38	H	2
26090	1855.0	-29.18	46.28	17.10	51.32	V	2
26340	1880.0	-27.59	47.07	19.48	88.72	V	2
26640	1910.0	-28.89	45.88	17.00	50.10	V	2

CHANNEL BANDWIDTH: 10MHz 16QAM

Channel	Frequency (MHz)	SPA LVL (dBm)	Correction Factor(dB)	EIRP(dBm)	EIRP(mW)	Polarization (H/V)	LIMIT (W)
26090	1855.0	-22.41	43.86	21.45	139.54	H	2
26340	1880.0	-20.95	43.57	22.63	183.02	H	2
26640	1910.0	-21.65	44.32	22.67	184.80	H	2
26090	1855.0	-30.33	46.28	15.95	39.38	V	2
26340	1880.0	-28.69	47.07	18.38	68.87	V	2
26640	1910.0	-30.05	45.88	15.84	38.35	V	2



CHANNEL BANDWIDTH: 10MHZ 64QAM

Channel	Frequency (MHz)	SPA LVL (dBm)	Correction Factor(dB)	EIRP(dBm)	EIRP(mW)	Polarization (H/V)	LIMIT (W)
26090	1855.0	-23.06	43.86	20.80	120.14	H	2
26340	1880.0	-21.63	43.57	21.95	156.49	H	2
26640	1910.0	-22.79	44.32	21.53	142.20	H	2
26090	1855.0	-31.20	46.28	15.08	32.23	V	2
26340	1880.0	-28.03	47.07	19.04	80.17	V	2
26640	1910.0	-29.03	45.88	16.85	48.46	V	2

CHANNEL BANDWIDTH: 15MHz QPSK

Channel	Frequency (MHz)	SPA LVL (dBm)	Correction Factor(dB)	EIRP(dBm)	EIRP(mW)	Polarization (H/V)	LIMIT (W)
26115	1857.5	-21.27	43.99	22.72	186.98	H	2
26340	1880.0	-19.92	43.57	23.66	232.01	H	2
26615	1907.5	-20.56	44.19	23.63	230.46	H	2
26115	1857.5	-29.19	45.93	16.74	47.23	V	2
26340	1880.0	-27.66	47.07	19.41	87.30	V	2
26615	1907.5	-28.96	45.89	16.94	49.37	V	2

CHANNEL BANDWIDTH: 15MHz 16QAM

Channel	Frequency (MHz)	SPA LVL (dBm)	Correction Factor(dB)	EIRP(dBm)	EIRP(mW)	Polarization (H/V)	LIMIT (W)
26115	1857.5	-22.13	43.99	21.86	153.39	H	2
26340	1880.0	-20.79	43.57	22.79	189.89	H	2
26615	1907.5	-21.41	44.19	22.78	189.50	H	2
26115	1857.5	-30.05	45.93	15.88	38.74	V	2
26340	1880.0	-28.53	47.07	18.54	71.45	V	2
26615	1907.5	-29.81	45.89	16.09	40.60	V	2



Test Report No.: RF180829W002-5

CHANNEL BANDWIDTH: 15MHZ 64QAM

Channel	Frequency (MHz)	SPA LVL (dBm)	Correction Factor(dB)	EIRP(dBm)	EIRP(mW)	Polarization (H/V)	LIMIT (W)
26115	1857.5	-23.07	43.99	20.92	123.54	H	2
26340	1880.0	-21.70	43.57	21.88	153.99	H	2
26615	1907.5	-22.86	44.19	21.33	135.77	H	2
26115	1857.5	-31.21	45.93	14.72	29.66	V	2
26340	1880.0	-28.10	47.07	18.97	78.89	V	2
26615	1907.5	-29.10	45.89	16.79	47.76	V	2

CHANNEL BANDWIDTH: 20MHz QPSK

Channel	Frequency (MHz)	SPA LVL (dBm)	Correction Factor(dB)	EIRP(dBm)	EIRP(mW)	Polarization (H/V)	LIMIT (W)
26140	1860.0	-21.85	43.50	21.65	146.05	H	2
26340	1880.0	-20.37	43.57	23.21	209.17	H	2
26590	1905.0	-21.14	43.99	22.85	192.84	H	2
26140	1860.0	-29.77	45.57	15.81	38.06	V	2
26340	1880.0	-28.11	47.07	18.96	78.70	V	2
26590	1905.0	-29.54	45.92	16.39	43.51	V	2

CHANNEL BANDWIDTH: 20MHz 16QAM

Channel	Frequency (MHz)	SPA LVL (dBm)	Correction Factor(dB)	EIRP(dBm)	EIRP(mW)	Polarization (H/V)	LIMIT (W)
26140	1860.0	-22.78	43.50	20.72	117.90	H	2
26340	1880.0	-21.44	43.57	22.14	163.49	H	2
26590	1905.0	-21.97	43.99	22.02	159.29	H	2
26140	1860.0	-30.70	45.57	14.88	30.73	V	2
26340	1880.0	-29.18	47.07	17.89	61.52	V	2
26590	1905.0	-30.37	45.92	15.56	35.94	V	2



Test Report No.: RF180829W002-5

CHANNEL BANDWIDTH: 20MHZ 64QAM

Channel	Frequency (MHz)	SPA LVL (dBm)	Correction Factor(dB)	EIRP(dBm)	EIRP(mW)	Polarization (H/V)	LIMIT (W)
26140	1860.0	-23.65	43.50	19.85	96.49	H	2
26340	1880.0	-22.15	43.57	21.43	138.84	H	2
26590	1905.0	-23.44	43.99	20.55	113.61	H	2
26140	1860.0	-31.79	45.57	13.79	23.91	V	2
26340	1880.0	-28.55	47.07	18.52	71.12	V	2
26590	1905.0	-29.68	45.92	16.24	42.09	V	2

REMARKS: 1. EIRP Output Power (dBm) = SPA LVL (dBm) + Correction Factor (dB).

2. Correction factor (dB) = Free Space Loss + Antenna Factor + Cable Loss

3.2 FREQUENCY STABILITY MEASUREMENT

3.2.1 LIMITS OF FREQUENCY STABILITY MEASUREMENT

The frequency stability shall be sufficient to ensure that the fundamental emission stays within the authorized frequency block.

3.2.2 TEST PROCEDURE

- a. Device is placed at the oven room. The oven room could control the temperatures and humidity. Power warm up is at least 15 min and power applied should perform before recording frequency error.
- b. EUT is connected the external power supply to control the DC input power. The test voltage range is from minimum to maximum working voltage. Each step shall be record the frequency error rate.
- c. The temperature range step is 10 degrees in this test items. All temperature levels shall be hold the $\pm 0.5^{\circ}\text{C}$ during the measurement testing. The each temperature step shall be at least 0.5 hours, consider the EUT could be test under the stability condition.

NOTE: The frequency error was recorded frequency error from the communication simulator.

3.2.3 TEST SETUP

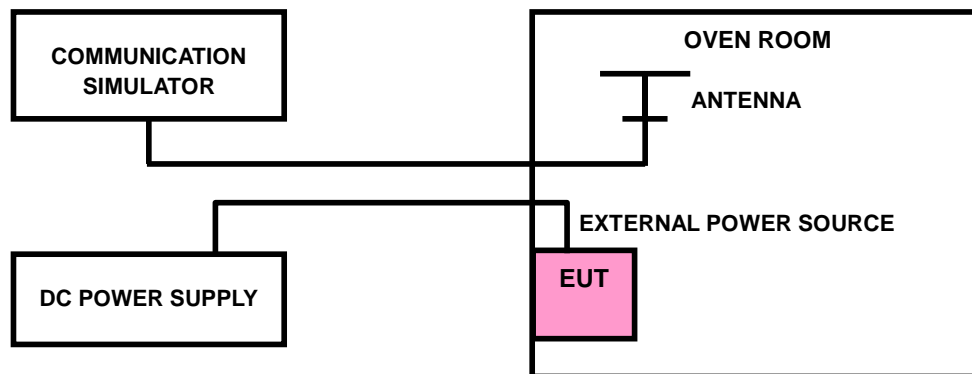



3.2.4 TEST RESULTS

GSM1900

FREQUENCY ERROR VS. VOLTAGE

VOLTAGE (Volts)	FREQUENCY ERROR (ppm)		LIMIT (ppm)
	Low Channel	High Channel	
3.7	0.0009	0.0008	2.5
3.4	-0.0012	-0.0009	2.5
4.2	0.0009	0.0008	2.5

NOTE: The applicant defined the normal working voltage of the battery is from 3.4Vdc to 4.2Vdc.

FREQUENCY ERROR vs. TEMPERATURE.

TEMP. (°C)	FREQUENCY ERROR (ppm)		LIMIT (ppm)
	Low Channel	High Channel	
-30	-0.0053	-0.0051	2.5
-20	-0.0051	-0.0049	2.5
-10	-0.0045	-0.0043	2.5
0	-0.0042	-0.0040	2.5
10	-0.0034	-0.0032	2.5
20	-0.0029	-0.0027	2.5
30	-0.0025	-0.0023	2.5
40	-0.0012	-0.0011	2.5
50	0.0002	0.0004	2.5



EDGE 1900

FREQUENCY ERROR VS. VOLTAGE

VOLTAGE (Volts)	FREQUENCY ERROR (ppm)		LIMIT (ppm)
	Low Channel	High Channel	
3.7	0.0012	0.0011	2.5
3.4	-0.0013	-0.0012	2.5
4.2	0.0010	0.0009	2.5

NOTE: The applicant defined the normal working voltage of the battery is from 3.4Vdc to 4.2Vdc.

FREQUENCY ERROR vs. TEMPERATURE.

TEMP. (°C)	FREQUENCY ERROR (ppm)		LIMIT (ppm)
	Low Channel	High Channel	
-30	-0.0052	-0.0050	2.5
-20	-0.0051	-0.0048	2.5
-10	-0.0046	-0.0045	2.5
0	-0.0041	-0.0041	2.5
10	-0.0037	-0.0037	2.5
20	-0.0033	0.0033	2.5
30	-0.0029	-0.0025	2.5
40	-0.0018	-0.0018	2.5
50	-0.0005	-0.0005	2.5



WCDMA BAND II

FREQUENCY ERROR VS. VOLTAGE

VOLTAGE (Volts)	FREQUENCY ERROR (ppm)		LIMIT (ppm)
	Low Channel	High Channel	
3.7	0.0009	0.0009	2.5
3.4	-0.0010	-0.0011	2.5
4.2	0.0009	0.0010	2.5

NOTE: The applicant defined the normal working voltage of the battery is from 3.4Vdc to 4.2Vdc.

FREQUENCY ERROR vs. TEMPERATURE.

TEMP. (°C)	FREQUENCY ERROR (ppm)		LIMIT (ppm)
	Low Channel	High Channel	
-30	-0.0050	-0.0047	2.5
-20	-0.0050	-0.0047	2.5
-10	-0.0048	-0.0043	2.5
0	-0.0044	-0.0036	2.5
10	-0.0037	-0.0036	2.5
20	-0.0032	-0.0026	2.5
30	-0.0026	-0.0024	2.5
40	-0.0023	-0.0022	2.5
50	0.0000	0.0002	2.5



CDMA BC1

FREQUENCY ERROR VS. VOLTAGE

VOLTAGE (Volts)	FREQUENCY ERROR (ppm)		LIMIT (ppm)
	Low Channel	High Channel	
3.7	0.0019	0.0018	2.5
3.4	-0.0022	-0.0021	2.5
4.2	0.0019	0.0016	2.5

NOTE: The applicant defined the normal working voltage of the battery is from 3.4Vdc to 4.2Vdc.

FREQUENCY ERROR vs. TEMPERATURE.

TEMP. (°C)	FREQUENCY ERROR (ppm)		LIMIT (ppm)
	Low Channel	High Channel	
-30	-0.0127	-0.0121	2.5
-20	-0.0115	-0.0110	2.5
-10	-0.0100	-0.0095	2.5
0	-0.0088	-0.0084	2.5
10	-0.0066	-0.0063	2.5
20	-0.0054	-0.0052	2.5
30	-0.0043	-0.0042	2.5
40	-0.0041	-0.0039	2.5
50	-0.0015	-0.0014	2.5



LTE BAND 2

FREQUENCY ERROR VS. VOLTAGE

VOLTAGE (Volts)	1.4MHz		LIMIT (ppm)
	FREQUENCY ERROR (ppm)		
	Low Channel	High Channel	
3.7	0.0008	0.0009	2.5
3.4	-0.0009	-0.0010	2.5
4.2	0.0007	0.0009	2.5

NOTE: The applicant defined the normal working voltage of the battery is from 3.4Vdc to 4.2Vdc.

FREQUENCY ERROR vs. TEMPERATURE.

TEMP. (°C)	1.4MHz		LIMIT (ppm)
	FREQUENCY ERROR (ppm)		
	Low Channel	High Channel	
-30	-0.0055	-0.0056	2.5
-20	-0.0049	-0.0052	2.5
-10	-0.0044	-0.0045	2.5
0	-0.0039	-0.0039	2.5
10	-0.0030	-0.0027	2.5
20	-0.0024	-0.0025	2.5
30	-0.0017	-0.0017	2.5
40	-0.0006	-0.0005	2.5
50	-0.0003	-0.0005	2.5



FREQUENCY ERROR VS. VOLTAGE

VOLTAGE (Volts)	3MHz		LIMIT (ppm)
	FREQUENCY ERROR (ppm)		
	Low Channel	High Channel	
3.7	0.0008	0.0010	2.5
3.4	-0.0010	-0.0010	2.5
4.2	0.0010	0.0009	2.5

NOTE: The applicant defined the normal working voltage of the battery is from 3.4Vdc to 4.2Vdc.

FREQUENCY ERROR vs. TEMPERATURE.

TEMP. (°C)	3MHz		LIMIT (ppm)
	FREQUENCY ERROR (ppm)		
	Low Channel	High Channel	
-30	-0.0055	-0.0056	2.5
-20	-0.0050	-0.0052	2.5
-10	-0.0043	-0.0037	2.5
0	-0.0037	-0.0031	2.5
10	-0.0033	-0.0029	2.5
20	-0.0018	-0.0025	2.5
30	-0.0013	-0.0014	2.5
40	-0.0007	-0.0007	2.5
50	-0.0006	-0.0004	2.5



FREQUENCY ERROR VS. VOLTAGE

VOLTAGE (Volts)	5MHz		LIMIT (ppm)
	FREQUENCY ERROR (ppm)		
	Low Channel	High Channel	
3.7	0.0009	0.0011	2.5
3.4	-0.0011	-0.0012	2.5
4.2	0.0010	0.0010	2.5

NOTE: The applicant defined the normal working voltage of the battery is from 3.4Vdc to 4.2Vdc.

FREQUENCY ERROR vs. TEMPERATURE.

TEMP. (°C)	5MHz		LIMIT (ppm)
	FREQUENCY ERROR (ppm)		
	Low Channel	High Channel	
-30	-0.0054	-0.0055	2.5
-20	-0.0050	-0.0049	2.5
-10	-0.0045	-0.0040	2.5
0	-0.0039	-0.0032	2.5
10	-0.0034	-0.0026	2.5
20	-0.0028	-0.0018	2.5
30	-0.0023	-0.0011	2.5
40	-0.0013	-0.0007	2.5
50	0.0004	0.0002	2.5



FREQUENCY ERROR VS. VOLTAGE

VOLTAGE (Volts)	10MHz		LIMIT (ppm)
	FREQUENCY ERROR (ppm)		
	Low Channel	High Channel	
3.7	0.0010	0.0008	2.5
3.4	-0.0012	-0.0009	2.5
4.2	0.0009	0.0008	2.5

NOTE: The applicant defined the normal working voltage of the battery is from 3.4Vdc to 4.2Vdc.

FREQUENCY ERROR vs. TEMPERATURE.

TEMP. (°C)	10MHz		LIMIT (ppm)
	FREQUENCY ERROR (ppm)		
	Low Channel	High Channel	
-30	-0.0056	-0.0049	2.5
-20	-0.0047	-0.0043	2.5
-10	-0.0039	-0.0039	2.5
0	-0.0034	-0.0033	2.5
10	-0.0028	-0.0023	2.5
20	-0.0017	-0.0018	2.5
30	-0.0012	-0.0011	2.5
40	-0.0005	-0.0009	2.5
50	0.0002	0.0002	2.5

FREQUENCY ERROR VS. VOLTAGE

VOLTAGE (Volts)	15MHz		LIMIT (ppm)
	FREQUENCY ERROR (ppm)		
	Low Channel	High Channel	
3.7	0.0012	0.0011	2.5
3.4	-0.0011	-0.0012	2.5
4.2	0.0009	0.0010	2.5

NOTE: The applicant defined the normal working voltage of the battery is from 3.4Vdc to 4.2Vdc.

FREQUENCY ERROR vs. TEMPERATURE.

TEMP. (°C)	15MHz		LIMIT (ppm)
	FREQUENCY ERROR (ppm)		
	Low Channel	High Channel	
-30	-0.0049	-0.0050	2.5
-20	-0.0043	-0.0034	2.5
-10	-0.0039	-0.0033	2.5
0	-0.0029	-0.0031	2.5
10	-0.0022	-0.0022	2.5
20	-0.0018	-0.0015	2.5
30	-0.0014	-0.0005	2.5
40	-0.0007	-0.0004	2.5
50	0.0005	0.0001	2.5



FREQUENCY ERROR VS. VOLTAGE

VOLTAGE (Volts)	20MHz		LIMIT (ppm)
	FREQUENCY ERROR (ppm)		
	Low Channel	High Channel	
3.7	0.0011	0.0011	2.5
3.4	-0.0012	-0.0011	2.5
4.2	0.0010	0.0012	2.5

NOTE: The applicant defined the normal working voltage of the battery is from 3.4Vdc to 4.2Vdc.

FREQUENCY ERROR vs. TEMPERATURE.

TEMP. (°C)	20MHz		LIMIT (ppm)
	FREQUENCY ERROR (ppm)		
	Low Channel	High Channel	
-30	-0.0050	-0.0052	2.5
-20	-0.0044	-0.0037	2.5
-10	-0.0040	-0.0036	2.5
0	-0.0032	-0.0027	2.5
10	-0.0023	-0.0023	2.5
20	-0.0018	-0.0015	2.5
30	-0.0007	-0.0007	2.5
40	-0.0002	-0.0003	2.5
50	0.0003	0.0003	2.5



LTE BAND 25

FREQUENCY ERROR VS. VOLTAGE

VOLTAGE (Volts)	1.4MHz		LIMIT (ppm)
	FREQUENCY ERROR (ppm)		
	Low Channel	High Channel	
3.7	0.0007	0.0010	2.5
3.4	-0.0009	-0.0010	2.5
4.2	0.0007	0.0008	2.5

NOTE: The applicant defined the normal working voltage of the battery is from 3.4Vdc to 4.2Vdc.

FREQUENCY ERROR vs. TEMPERATURE.

TEMP. (°C)	1.4MHz		LIMIT (ppm)
	FREQUENCY ERROR (ppm)		
	Low Channel	High Channel	
-30	-0.0061	-0.0055	2.5
-20	-0.0060	-0.0053	2.5
-10	-0.0059	-0.0052	2.5
0	-0.0054	-0.0045	2.5
10	-0.0050	-0.0038	2.5
20	-0.0043	-0.0037	2.5
30	-0.0031	-0.0035	2.5
40	-0.0018	-0.0027	2.5
50	-0.0002	0.0005	2.5



FREQUENCY ERROR VS. VOLTAGE

VOLTAGE (Volts)	3MHz		LIMIT (ppm)
	FREQUENCY ERROR (ppm)		
	Low Channel	High Channel	
3.7	0.0008	0.0009	2.5
3.4	-0.0011	-0.0011	2.5
4.2	0.0008	0.0009	2.5

NOTE: The applicant defined the normal working voltage of the battery is from 3.4Vdc to 4.2Vdc.

FREQUENCY ERROR vs. TEMPERATURE.

TEMP. (°C)	3MHz		LIMIT (ppm)
	FREQUENCY ERROR (ppm)		
	Low Channel	High Channel	
-30	0.0008	0.0009	2.5
-20	-0.0011	-0.0011	2.5
-10	0.0008	0.0009	2.5
0	0.0008	0.0009	2.5
10	-0.0011	-0.0011	2.5
20	0.0008	0.0009	2.5
30	0.0008	0.0009	2.5
40	-0.0011	-0.0011	2.5
50	0.0008	0.0009	2.5



FREQUENCY ERROR VS. VOLTAGE

VOLTAGE (Volts)	5MHz		LIMIT (ppm)
	FREQUENCY ERROR (ppm)		
	Low Channel	High Channel	
3.7	0.0010	0.0010	2.5
3.4	-0.0008	-0.0011	2.5
4.2	0.0008	0.0009	2.5

NOTE: The applicant defined the normal working voltage of the battery is from 3.4Vdc to 4.2Vdc.

FREQUENCY ERROR vs. TEMPERATURE.

TEMP. (°C)	5MHz		LIMIT (ppm)
	FREQUENCY ERROR (ppm)		
	Low Channel	High Channel	
-30	-0.0063	-0.0059	2.5
-20	-0.0061	-0.0056	2.5
-10	-0.0048	-0.0045	2.5
0	-0.0047	-0.0044	2.5
10	-0.0039	-0.0036	2.5
20	-0.0034	-0.0031	2.5
30	-0.0025	-0.0023	2.5
40	-0.0017	-0.0015	2.5
50	-0.0003	-0.0003	2.5



FREQUENCY ERROR VS. VOLTAGE

VOLTAGE (Volts)	10MHz		LIMIT (ppm)
	FREQUENCY ERROR (ppm)		
	Low Channel	High Channel	
3.7	0.0007	0.0008	2.5
3.4	-0.0007	-0.0011	2.5
4.2	0.0007	0.0007	2.5

NOTE: The applicant defined the normal working voltage of the battery is from 3.4Vdc to 4.2Vdc.

FREQUENCY ERROR vs. TEMPERATURE.

TEMP. (°C)	10MHz		LIMIT (ppm)
	FREQUENCY ERROR (ppm)		
	Low Channel	High Channel	
-30	-0.0056	-0.0052	2.5
-20	-0.0053	-0.0049	2.5
-10	-0.0048	-0.0045	2.5
0	-0.0041	-0.0038	2.5
10	-0.0041	-0.0038	2.5
20	-0.0030	-0.0028	2.5
30	-0.0028	-0.0026	2.5
40	-0.0020	-0.0018	2.5
50	0.0001	0.0002	2.5



FREQUENCY ERROR VS. VOLTAGE

VOLTAGE (Volts)	15MHz		LIMIT (ppm)
	FREQUENCY ERROR (ppm)		
	Low Channel	High Channel	
3.7	0.0009	0.0010	2.5
3.4	-0.0010	-0.0012	2.5
4.2	0.0007	0.0009	2.5

NOTE: The applicant defined the normal working voltage of the battery is from 3.4Vdc to 4.2Vdc.

FREQUENCY ERROR vs. TEMPERATURE.

TEMP. (°C)	15MHz		LIMIT (ppm)
	FREQUENCY ERROR (ppm)		
	Low Channel	High Channel	
-30	-0.0059	-0.0055	2.5
-20	-0.0056	-0.0052	2.5
-10	-0.0048	-0.0044	2.5
0	-0.0041	-0.0039	2.5
10	-0.0041	-0.0038	2.5
20	-0.0029	-0.0027	2.5
30	-0.0025	-0.0023	2.5
40	-0.0023	-0.0021	2.5
50	0.0002	0.0003	2.5



FREQUENCY ERROR VS. VOLTAGE

VOLTAGE (Volts)	20MHz		LIMIT (ppm)
	FREQUENCY ERROR (ppm)		
	Low Channel	High Channel	
3.7	0.0008	0.0010	2.5
3.4	-0.0009	-0.0010	2.5
4.2	0.0007	0.0010	2.5

NOTE: The applicant defined the normal working voltage of the battery is from 3.4Vdc to 4.2Vdc.

FREQUENCY ERROR vs. TEMPERATURE.

TEMP. (°C)	20MHz		LIMIT (ppm)
	FREQUENCY ERROR (ppm)		
	Low Channel	High Channel	
-30	-0.0060	-0.0057	2.5
-20	-0.0058	-0.0055	2.5
-10	-0.0053	-0.0050	2.5
0	-0.0046	-0.0043	2.5
10	-0.0039	-0.0036	2.5
20	-0.0030	-0.0028	2.5
30	-0.0025	-0.0023	2.5
40	-0.0022	-0.0021	2.5
50	-0.0002	-0.0001	2.5

3.3 OCCUPIED BANDWIDTH MEASUREMENT

3.3.1 TEST PROCEDURES

The EUT makes a call to the communication simulator. All measurements were done at low, middle and high operational frequency range. The communication simulator station system controlled a EUT to export maximum output power under transmission mode and specific channel frequency. Use OBW measurement function of Spectrum analyzer to measure 99 % occupied bandwidth.

3.3.2 TEST SETUP

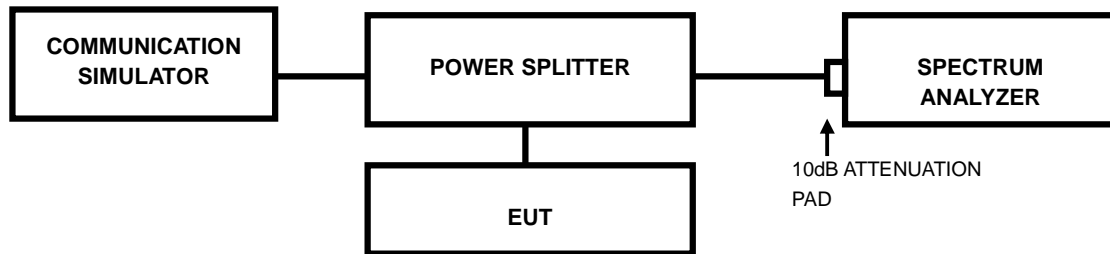

3.3.3 TEST RESULTS

Channel	Frequency (MHz)	99% Occupied bandwidth (kHz)		Channel	Frequency (MHz)	99% Occupied bandwidth (MHz)
		GSM	EDGE			WCDMA
512	1850.2	245.00	245.00	9262	1852.4	4.14
661	1880.0	245.00	252.00	9400	1880.0	4.14
810	1909.8	244.00	252.00	9538	1907.6	4.13

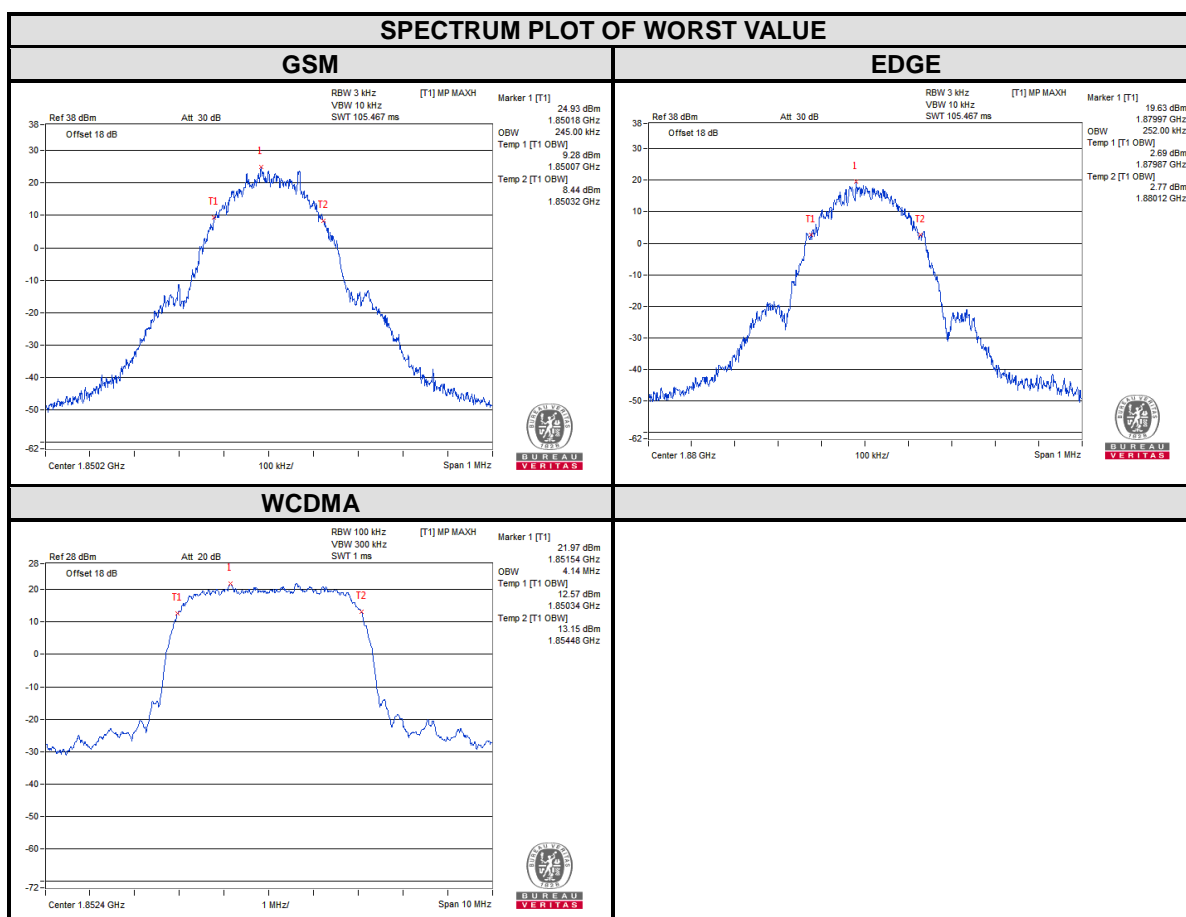

Channel	Frequency (MHz)	26dB bandwidth (kHz)		CHANNEL	FREQUENCY (MHz)	26dB bandwidth (MHz)
		GSM	EDGE			WCDMA
512	1850.2	317.50	311.54	9262	1852.4	4.74
661	1880.0	314.27	308.71	9400	1880.0	4.74
810	1909.8	317.97	315.65	9538	1907.6	4.71

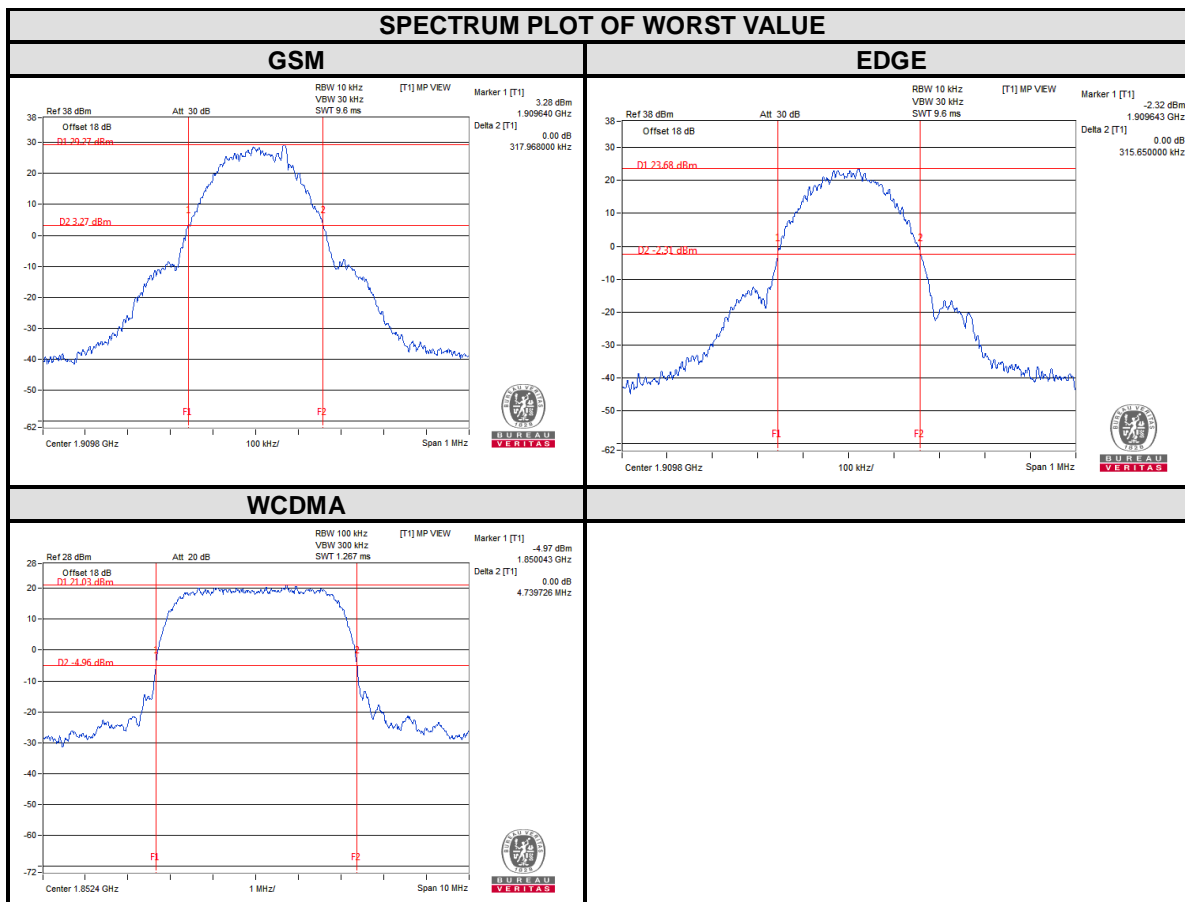



CDMA BC 1

CHANNEL	Frequency (MHz)	99% OCCUPIED Bandwidth (MHz)	CHANNEL	Frequency (MHz)	26dB Bandwidth (MHz)
25	1851.25	1.27	25	1851.25	1.44
600	1880.00	1.28	600	1880.00	1.43
1175	1908.75	1.28	1175	1908.75	1.43

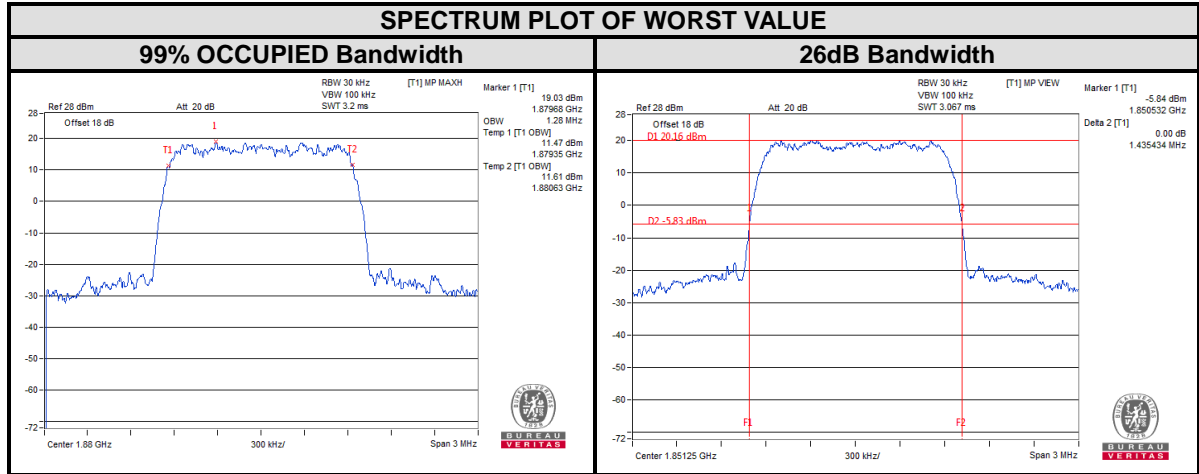

LTE band 2				
Channel Bandwidth : 1.4MHz				
Channel	Frequency (MHz)	99% Occupied bandwidth (MHz)		
		QPSK	16QAM	64QAM
18607	1850.7	1.08	1.08	1.08
18900	1880	1.08	1.08	1.08
19193	1909.3	1.08	1.08	1.08

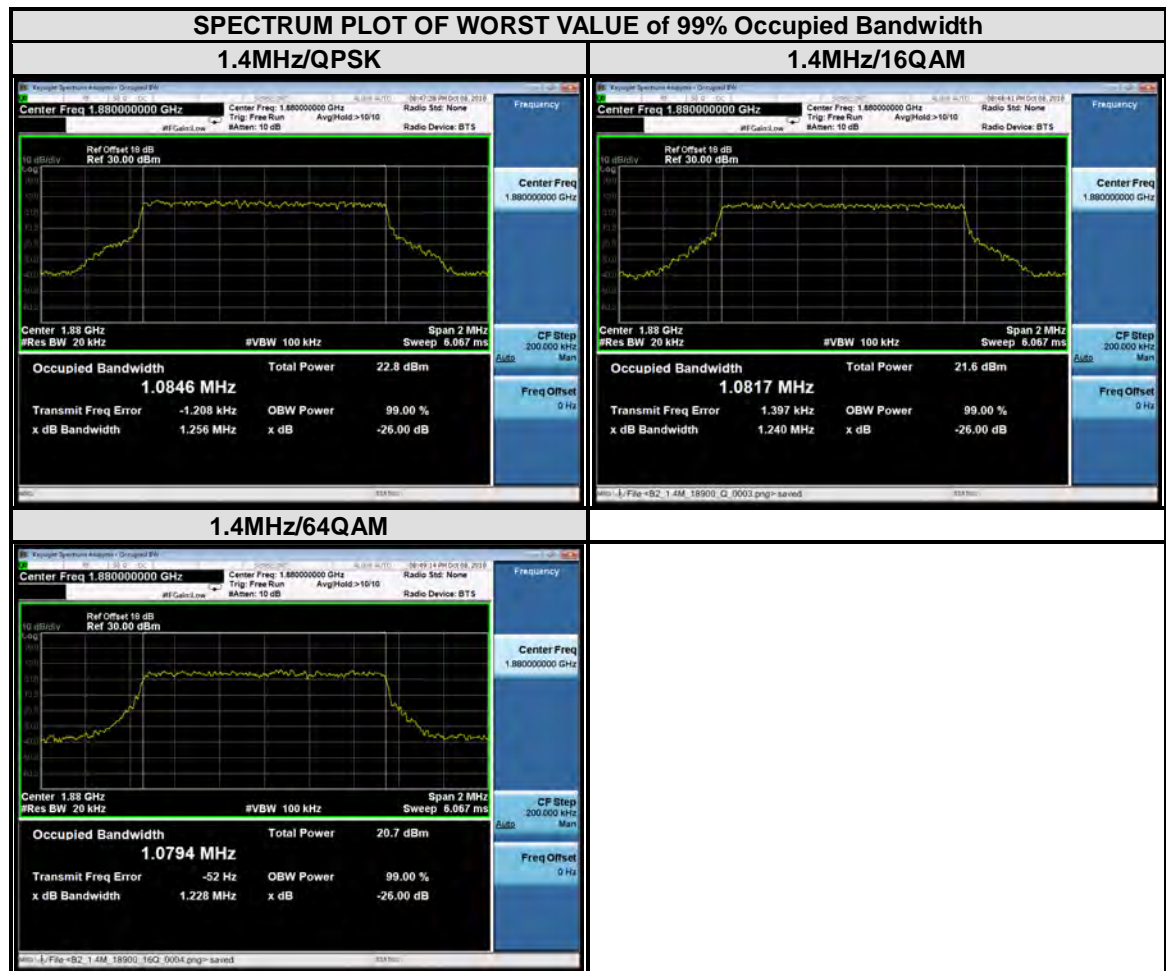

LTE band 2				
Channel Bandwidth : 3MHz				
Channel	Frequency (MHz)	99% Occupied bandwidth (MHz)		
		QPSK	16QAM	64QAM
18615	1851.5	2.68	2.68	2.68
18900	1880	2.67	2.68	2.68
19185	1908.5	2.68	2.67	2.68

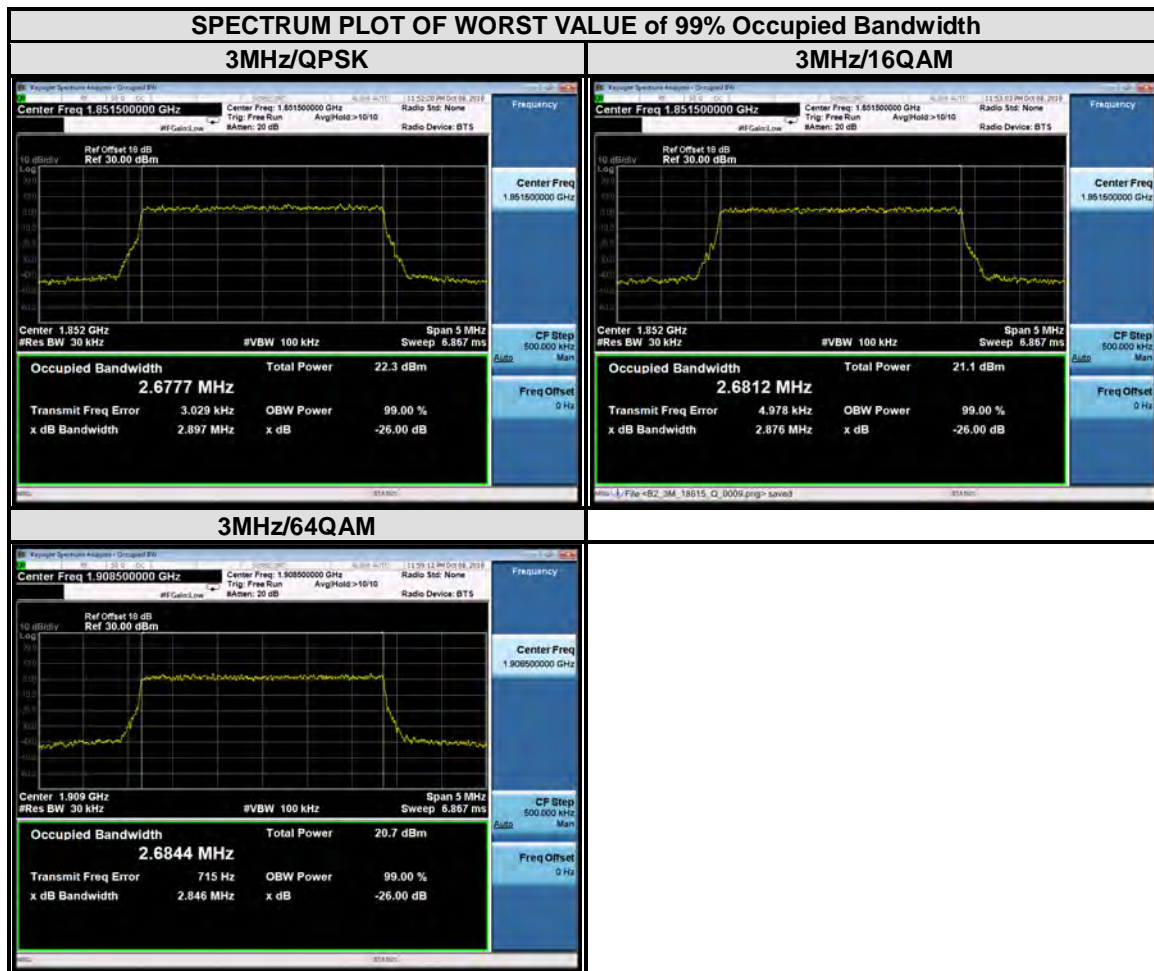

LTE band 2				
Channel Bandwidth : 5MHz				
Channel	Frequency (MHz)	99% Occupied bandwidth (MHz)		
		QPSK	16QAM	64QAM
18625	1852.5	4.47	4.46	4.46
18900	1880	4.45	4.46	4.46
19175	1907.5	4.47	4.46	4.47



LTE band 2				
Channel Bandwidth : 10MHz				
Channel	Frequency (MHz)	99% Occupied bandwidth (MHz)		
		QPSK	16QAM	64QAM
18650	1855	8.91	8.91	8.91
18900	1880	8.91	8.88	8.90
19150	1905	8.88	8.92	8.90

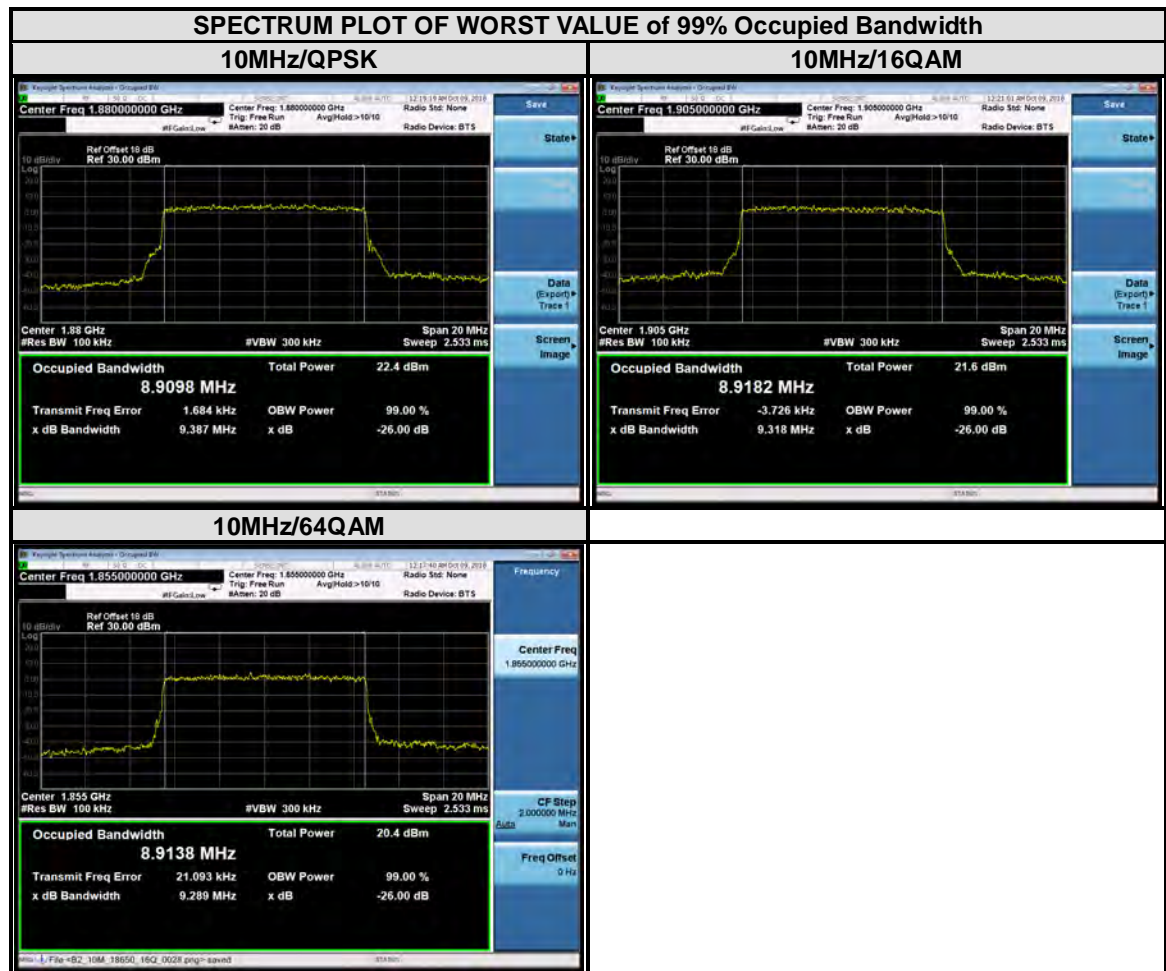



LTE band 2				
Channel Bandwidth : 15MHz				
Channel	Frequency (MHz)	99% Occupied bandwidth (MHz)		
		QPSK	16QAM	64QAM
18675	1857.5	13.32	13.36	13.31
18900	1880	13.34	13.35	13.35
19125	1902.5	13.31	13.32	13.36



LTE band 2				
Channel Bandwidth : 20MHz				
Channel	Frequency (MHz)	99% Occupied bandwidth (MHz)		
		QPSK	16QAM	64QAM
18700	1860	17.79	17.80	17.75
18900	1880	17.83	17.78	17.80
19100	1900	17.73	17.68	17.79

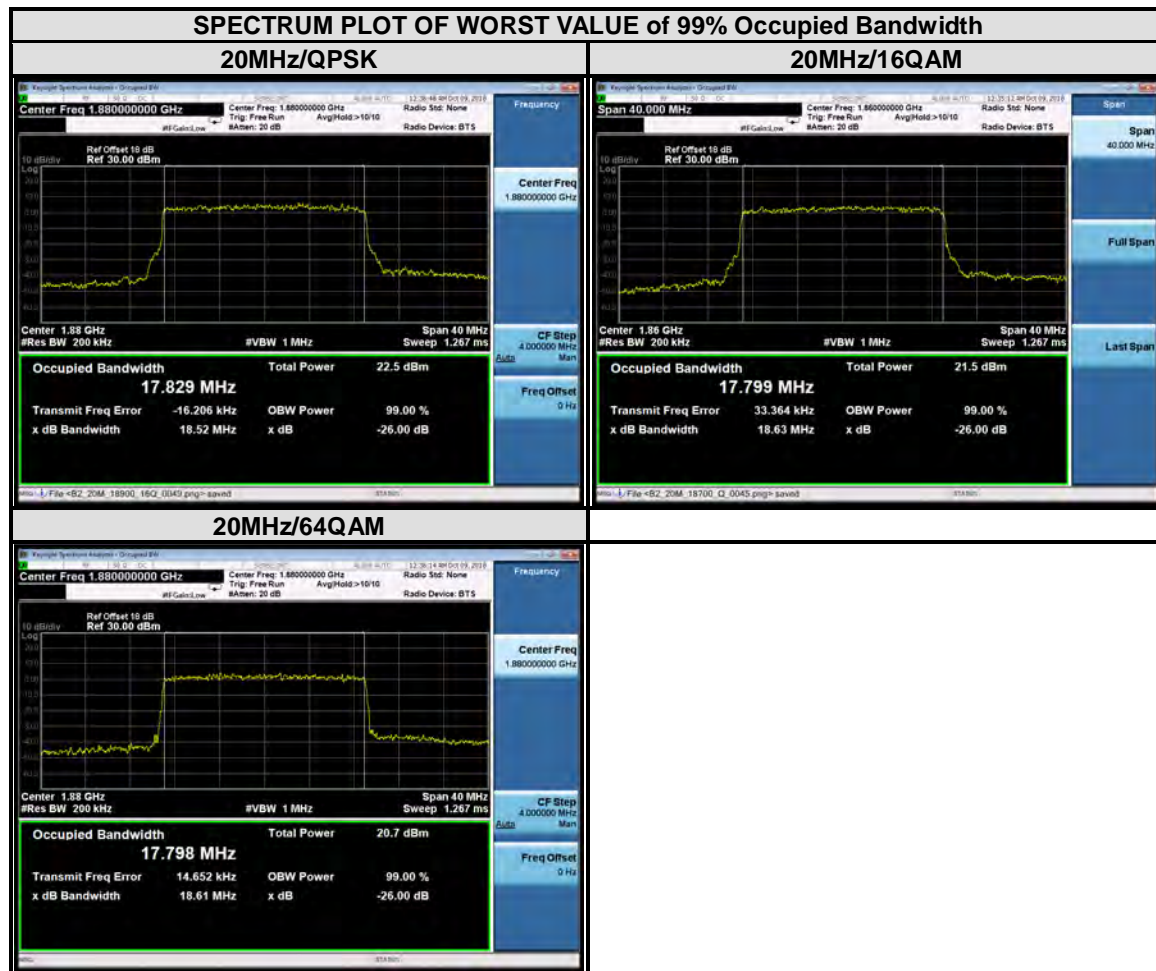

LTE band 2				
Channel Bandwidth : 1.4MHz				
CHANNEL	Frequency (MHz)	26 dB bandwidth (MHz)		
		QPSK	16QAM	64QAM
18607	1850.7	1.25	1.22	1.23
18900	1880	1.26	1.24	1.23
19193	1909.3	1.25	1.24	1.24



LTE band 2				
Channel Bandwidth : 3MHz				
CHANNEL	Frequency (MHz)	26 dB bandwidth (MHz)		
		QPSK	16QAM	64QAM
18615	1851.5	2.90	2.88	2.84
18900	1880	2.88	2.86	2.85
19185	1908.5	2.89	2.89	2.85



LTE band 2				
Channel Bandwidth : 5MHz				
CHANNEL	Frequency (MHz)	26 dB bandwidth (MHz)		
		QPSK	16QAM	64QAM
18625	1852.5	4.74	4.74	4.67
18900	1880	4.74	4.74	4.79
19175	1907.5	4.72	4.71	4.72



LTE band 2				
Channel Bandwidth : 10MHz				
CHANNEL	Frequency (MHz)	26 dB bandwidth (MHz)		
		QPSK	16QAM	64QAM
18650	1855	9.42	9.32	9.29
18900	1880	9.39	9.33	9.35
19150	1905	9.34	9.32	9.28



LTE band 2				
Channel Bandwidth : 15MHz				
CHANNEL	Frequency (MHz)	26 dB bandwidth (MHz)		
		QPSK	16QAM	64QAM
18675	1857.5	13.94	14.09	13.84
18900	1880	13.91	13.90	13.88
19125	1902.5	13.96	13.90	13.88



LTE band 2				
Channel Bandwidth : 20MHz				
CHANNEL	Frequency (MHz)	26 dB bandwidth (MHz)		
		QPSK	16QAM	64QAM
18700	1860	18.50	18.63	18.53
18900	1880	18.52	18.64	18.61
19100	1900	18.51	18.45	18.55

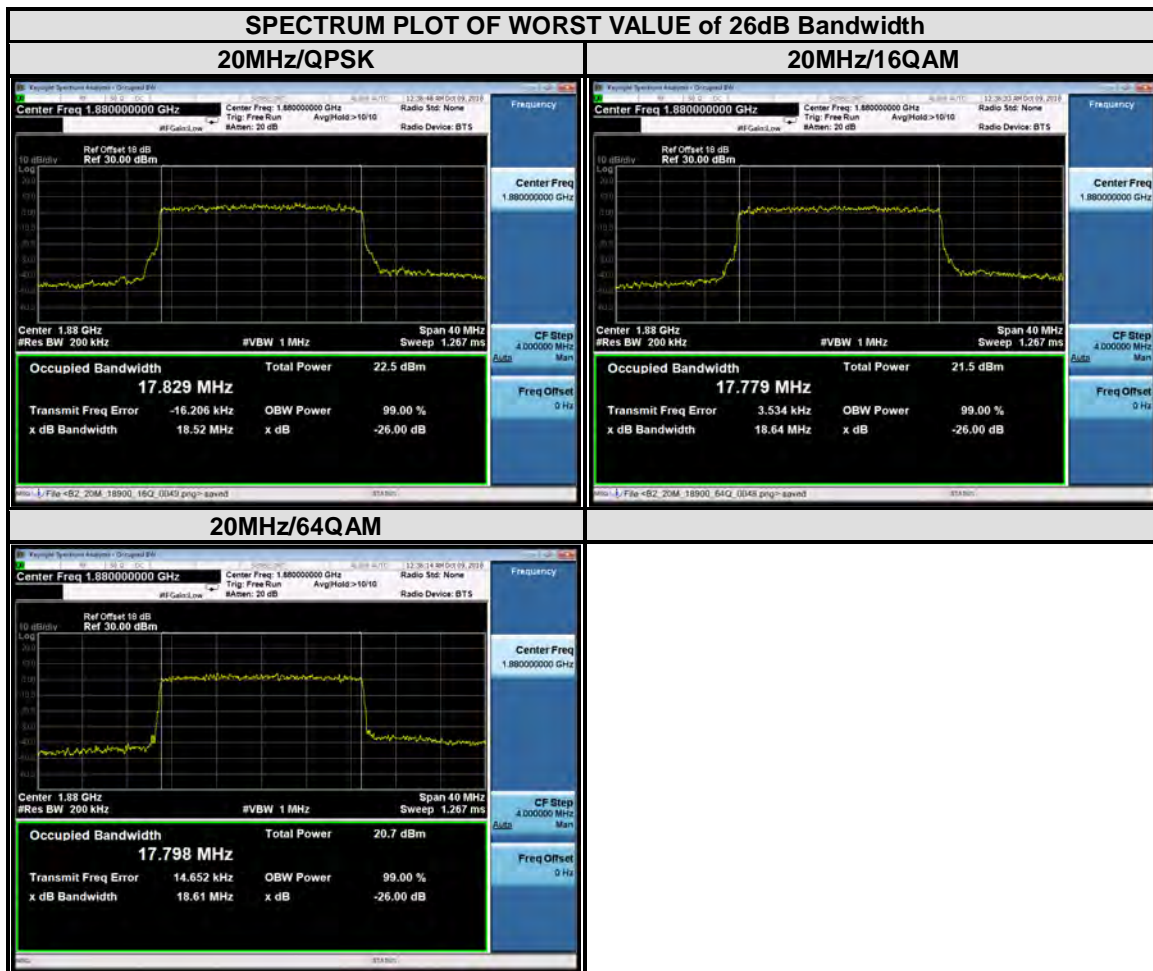

LTE band 25				
Channel Bandwidth : 1.4MHz				
Channel	Frequency (MHz)	99% Occupied bandwidth (MHz)		
		QPSK	16QAM	64QAM
26047	1850.7	1.08	1.09	1.08
26365	1880	1.08	1.08	1.08
26683	1914.3	1.09	1.09	1.08



LTE band 25				
Channel Bandwidth : 3MHz				
Channel	Frequency (MHz)	99% Occupied bandwidth (MHz)		
		QPSK	16QAM	64QAM
26055	1851.5	2.68	2.68	2.69
26365	1880	2.68	2.68	2.68
26675	1913.5	2.67	2.68	2.68



LTE band 25				
Channel Bandwidth : 5MHz				
Channel	Frequency (MHz)	99% Occupied bandwidth (MHz)		
		QPSK	16QAM	64QAM
26065	1852.5	4.47	4.47	4.47
26365	1880	4.47	4.47	4.47
26665	1912.5	4.47	4.46	4.47



LTE band 25				
Channel Bandwidth : 10MHz				
Channel	Frequency (MHz)	99% Occupied bandwidth (MHz)		
		QPSK	16QAM	64QAM
26090	1855	8.93	8.90	8.92
26365	1880	8.93	8.89	8.92
26640	1910	8.93	8.90	8.93



LTE band 25				
Channel Bandwidth : 15MHz				
Channel	Frequency (MHz)	99% Occupied bandwidth (MHz)		
		QPSK	16QAM	64QAM
26115	1857.5	13.38	13.38	13.36
26365	1880	13.39	13.36	13.36
26615	1907.5	13.42	13.39	13.38



LTE band 25				
Channel Bandwidth : 20MHz				
Channel	Frequency (MHz)	99% Occupied bandwidth (MHz)		
		QPSK	16QAM	64QAM
26140	1860	17.80	17.80	17.81
26365	1880	17.80	17.82	17.81
26590	1905	17.85	17.84	17.85

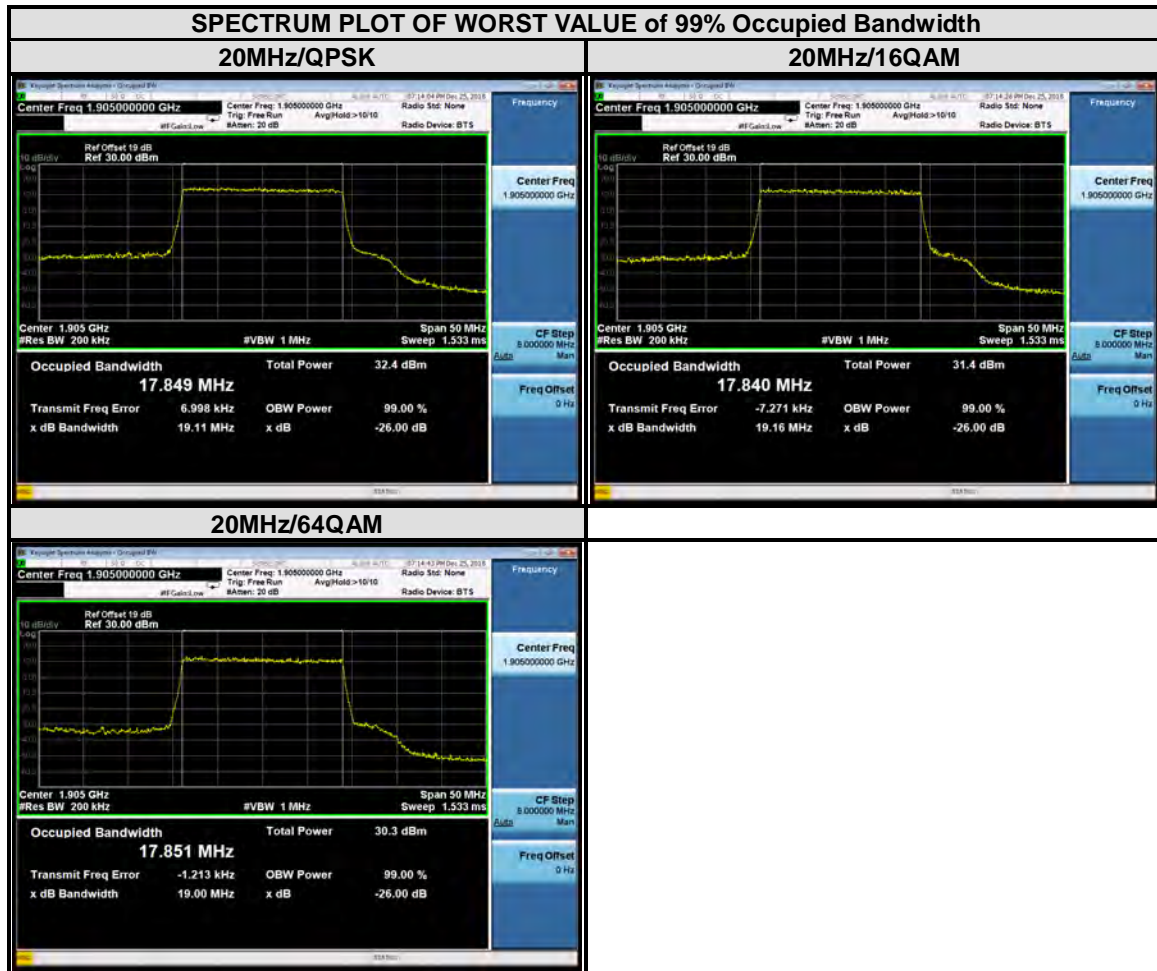

LTE band 25							
Channel Bandwidth : 1.4MHz				Channel Bandwidth : 3MHz			
Channel	Frequency (MHz)	26dB bandwidth (MHz)		Channel	Frequency (MHz)	26dB bandwidth (MHz)	
		QPSK	16QAM			QPSK	16QAM
26047	1850.7	1.25	1.26	26055	1851.5	2.92	2.93
26365	1880	1.25	1.27	26340	1880	2.92	2.93
26683	1914.3	1.26	1.27	26675	1913.5	2.93	2.93



LTE band 25							
Channel Bandwidth : 5MHz				Channel Bandwidth : 10MHz			
Channel	Frequency (MHz)	26dB bandwidth (MHz)		Channel	Frequency (MHz)	26dB bandwidth (MHz)	
		QPSK	16QAM			QPSK	16QAM
26065	1852.5	4.92	4.93	26090	1855	9.68	9.60
26365	1880	4.93	4.93	26365	1880	9.62	9.61
26665	1912.5	4.90	4.93	26640	1910	9.66	9.67

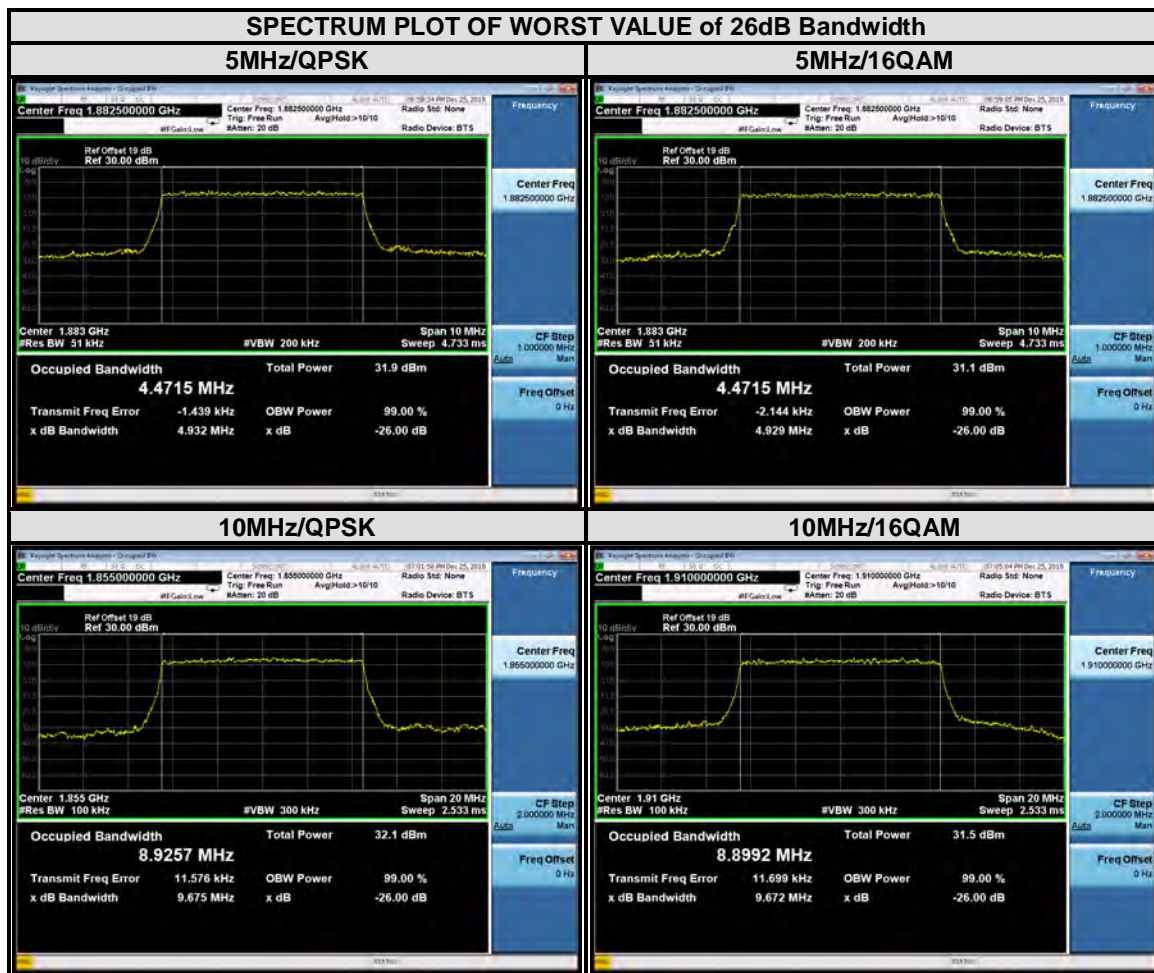

LTE band 25							
Channel Bandwidth : 15MHz				Channel Bandwidth : 20MHz			
Channel	Frequency (MHz)	26dB bandwidth (MHz)		Channel	Frequency (MHz)	26dB bandwidth (MHz)	
		QPSK	16QAM			QPSK	16QAM
26115	1857.5	14.35	14.37	26140	1860	19.02	19.06
26365	1880	14.28	14.42	26365	1880	18.93	18.97
26615	1907.5	14.34	14.52	26590	1905	19.11	19.16

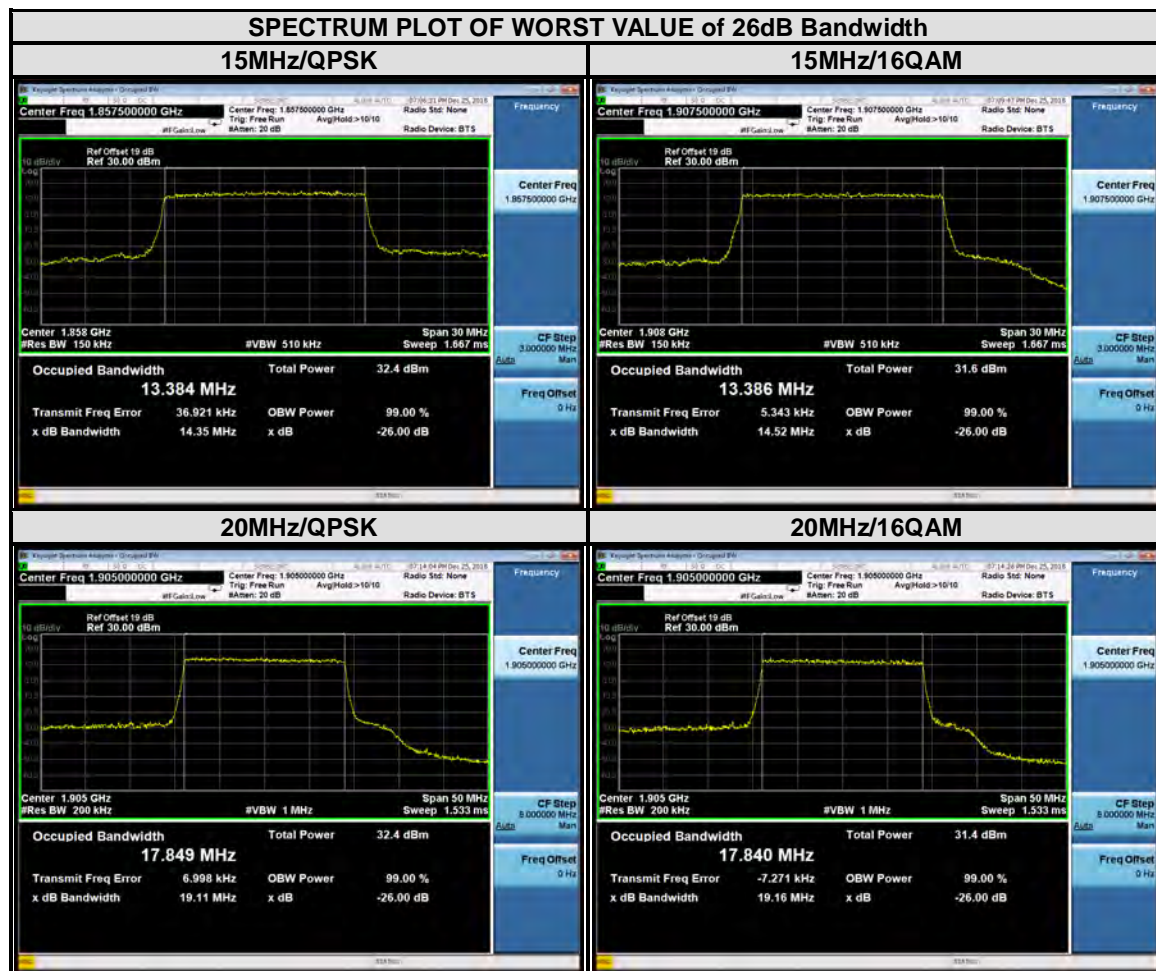

3.4 BAND EDGE MEASUREMENT

3.4.1 LIMITS OF BAND EDGE MEASUREMENT

Power of any emission outside of the authorized operating frequency ranges must be attenuated below the transmitting power (P) by a factor of at least $43 + 10 \log(P)$ dB. In the 1 MHz bands immediately outside and adjacent to the frequency block a resolution bandwidth of at least one percent of the emission bandwidth of the fundamental emission of the transmitter may be employed.

3.4.2 TEST SETUP

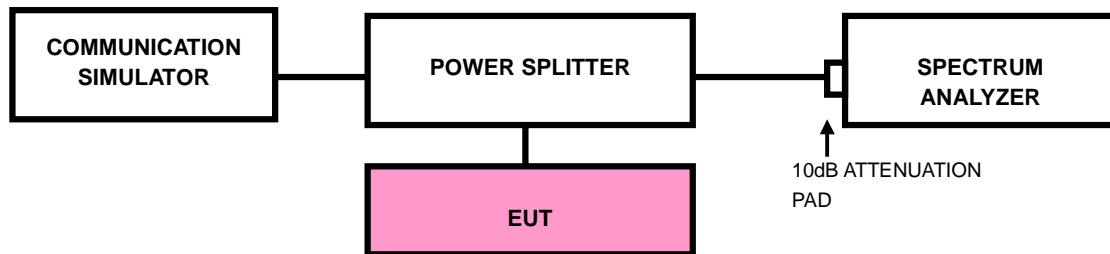



3.4.3 TEST PROCEDURES

- a. All measurements were done at low and high operational frequency range.
- b. The center frequency of spectrum is the band edge frequency and span is 1.5 MHz. RBW of the spectrum is 10kHz and VBW of the spectrum is 30kHz (GSM/GPRS/ EDGE).
- c. The center frequency of spectrum is the band edge frequency and span is 10MHz. RBW of the spectrum is 100kHz and VBW of the spectrum is 300kHz (WCDMA).
- d. The center frequency of spectrum is the band edge frequency and span is 3MHz. RBW of the spectrum is 15kHz and VBW of the spectrum is 15kHz (CDMA BC 1)
- e. The center frequency of spectrum is the band edge frequency and span is 1~5 MHz. RBW of the spectrum is 20kHz and VBW of the spectrum is 100 kHz. (LTE bandwidth 1.4MHz)
- f. The center frequency of spectrum is the band edge frequency and span is 1~5 MHz. RBW of the spectrum is 30kHz and VBW of the spectrum is 100kHz. (LTE bandwidth 3MHz)
- g. The center frequency of spectrum is the band edge frequency and span is 1~5 MHz. RBW of the spectrum is 50kHz and VBW of the spectrum is 200kHz. (LTE bandwidth 5MHz)
- h. The center frequency of spectrum is the band edge frequency and span is 1~5 MHz. RBW of the spectrum is 100kHz and VBW of the spectrum is 300kHz. (LTE bandwidth 10MHz)
- i. The center frequency of spectrum is the band edge frequency and span is 1~5 MHz. RBW of the spectrum is 200kHz and VBW of the spectrum is 1MHz. (LTE bandwidth 15MHz)
- j. The center frequency of spectrum is the band edge frequency and span is 1~5 MHz. RBW of the spectrum is 200kHz and VBW of the spectrum is 1MHz. (LTE bandwidth 20MHz)
- k. Record the max trace plot into the test report.

3.4.4. TEST RESULTS

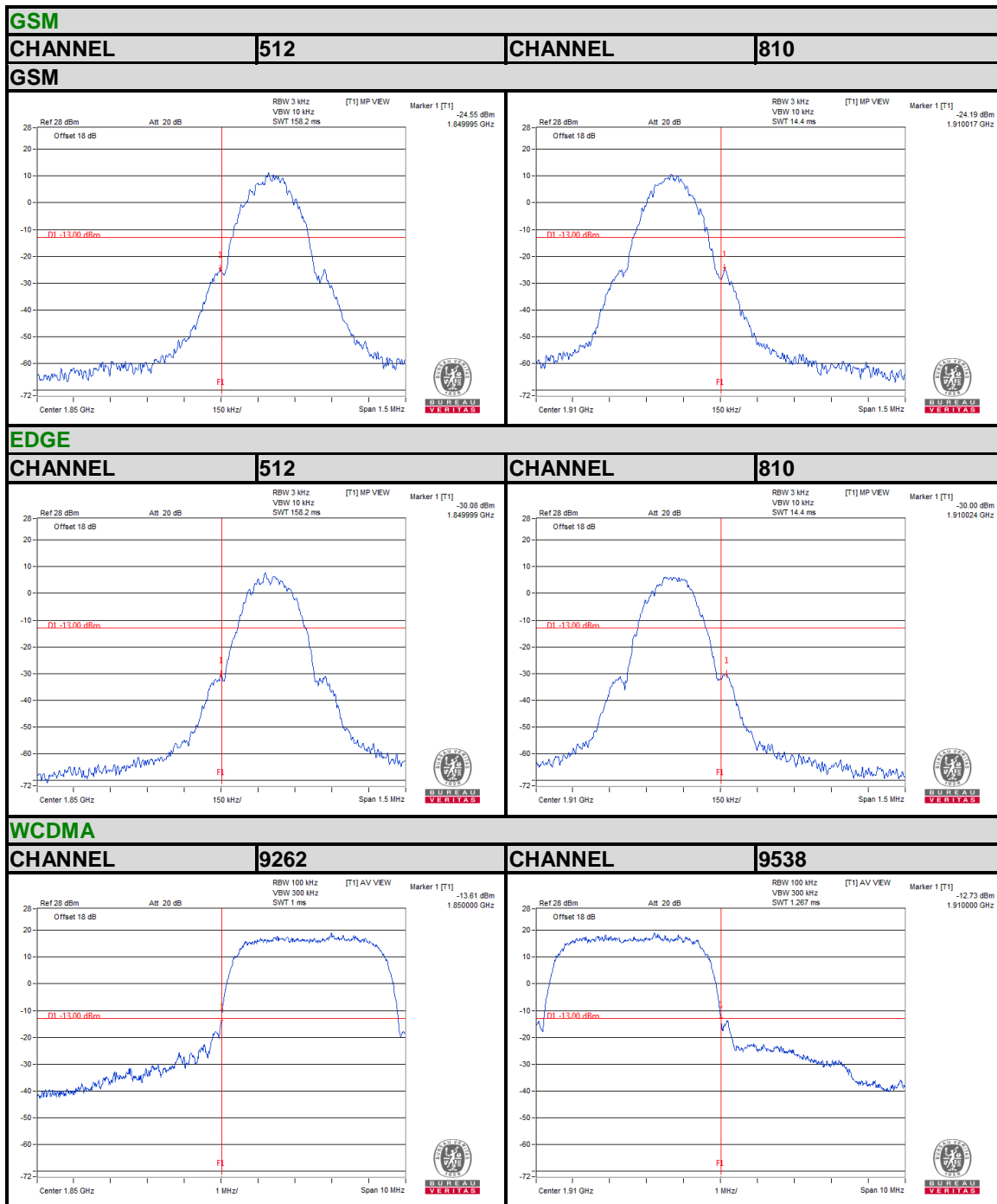



Test Report No.: RF180829W002-5

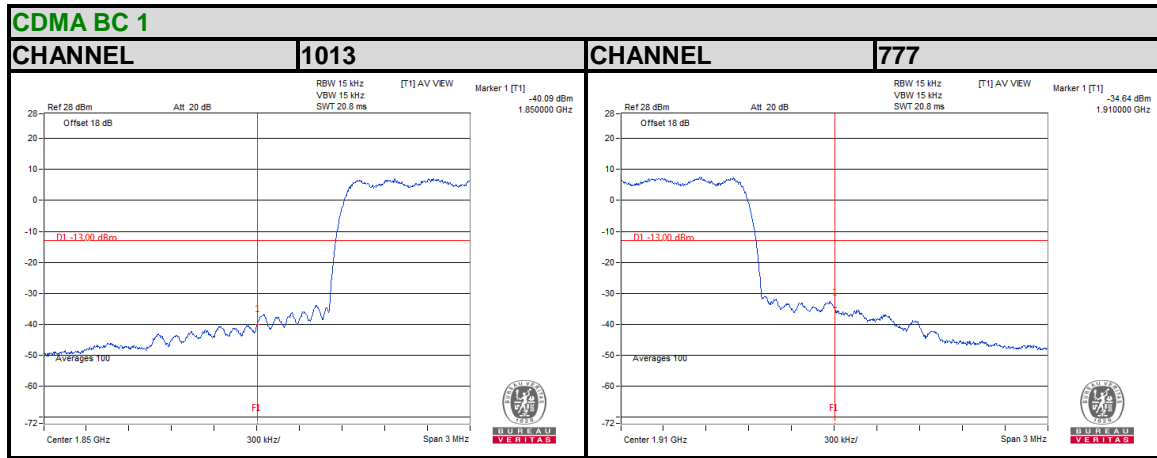

BV 7Layers Communications Technology
(Shenzhen) Co. Ltd

No.B102, Dazu Chuangxin Mansion, North of Beihuan
Avenue, North Area, Hi-Tech Industrial Park, Nanshan
District, Shenzhen, Guangdong, China

Tel: +86 755 8869 6566
Fax: +86 755 8869 6577
Email: customerservice.dq@cn.bureauveritas.com



LTE BAND 2

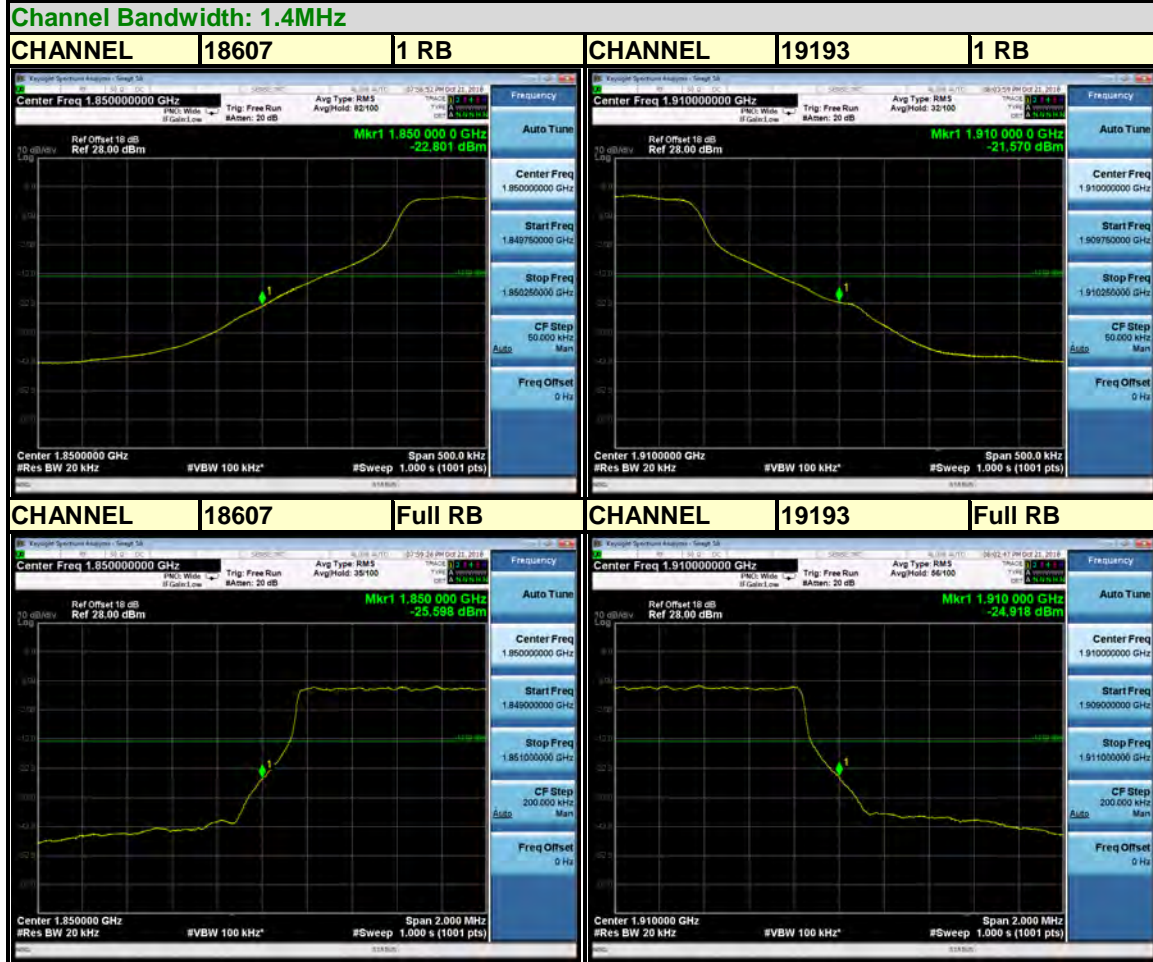

LTE BAND 2

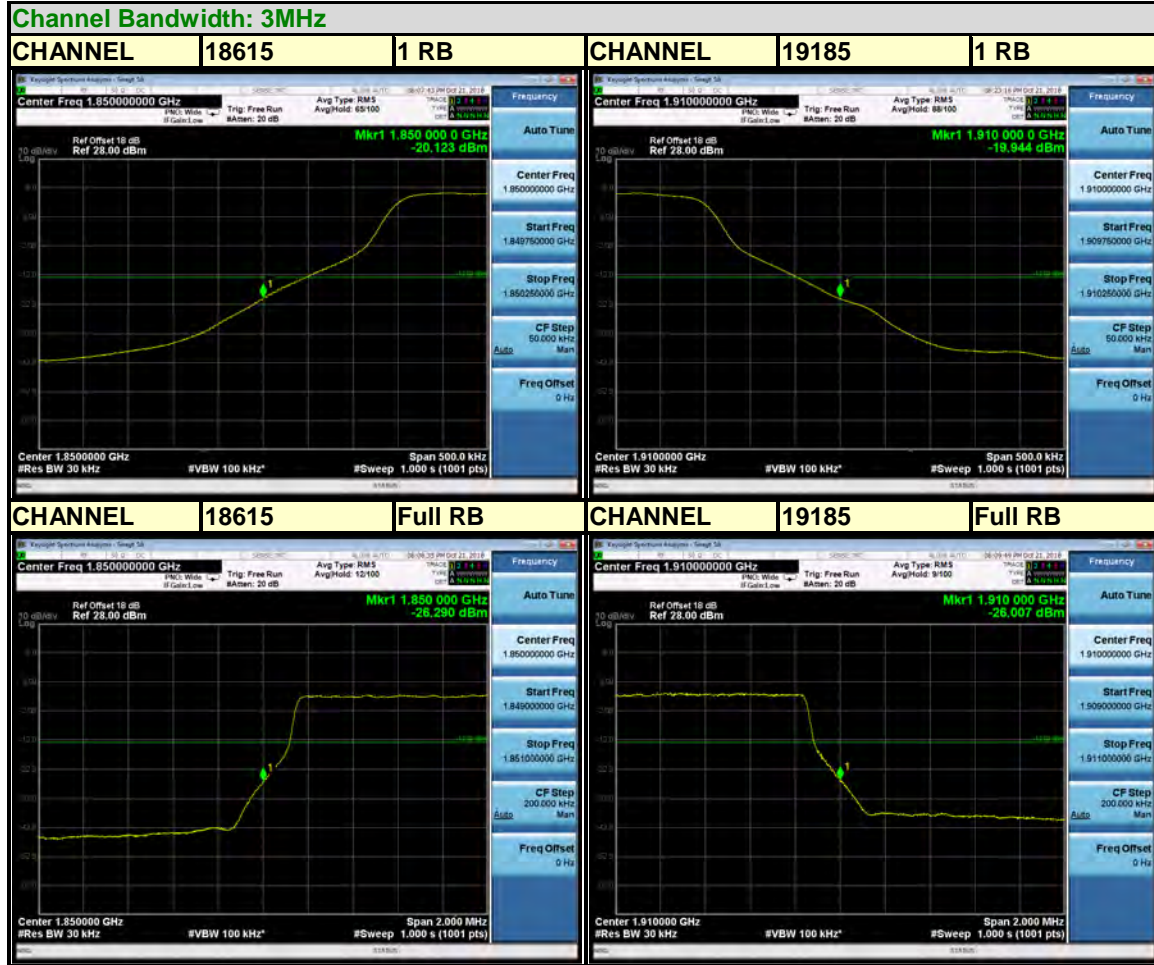

LTE BAND 2

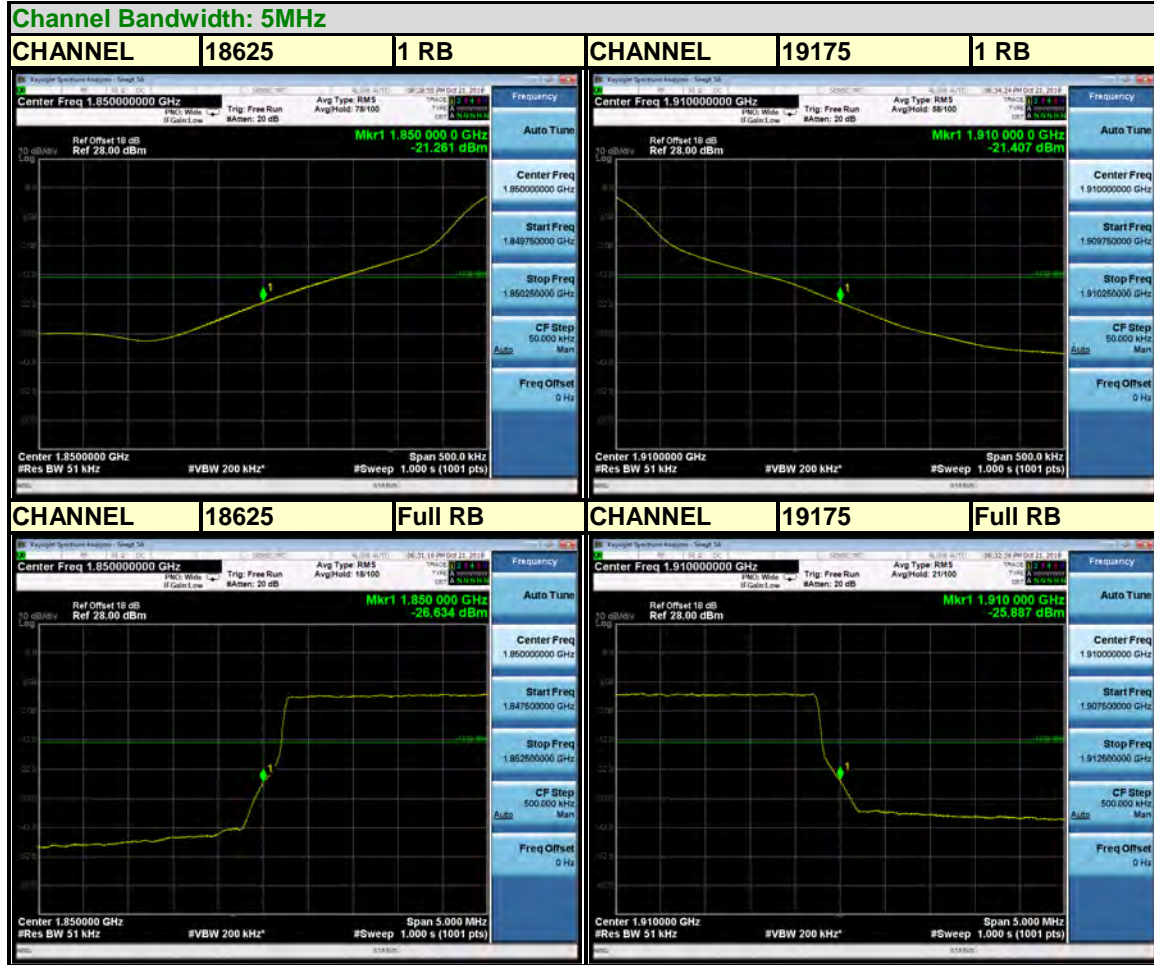

LTE BAND 2

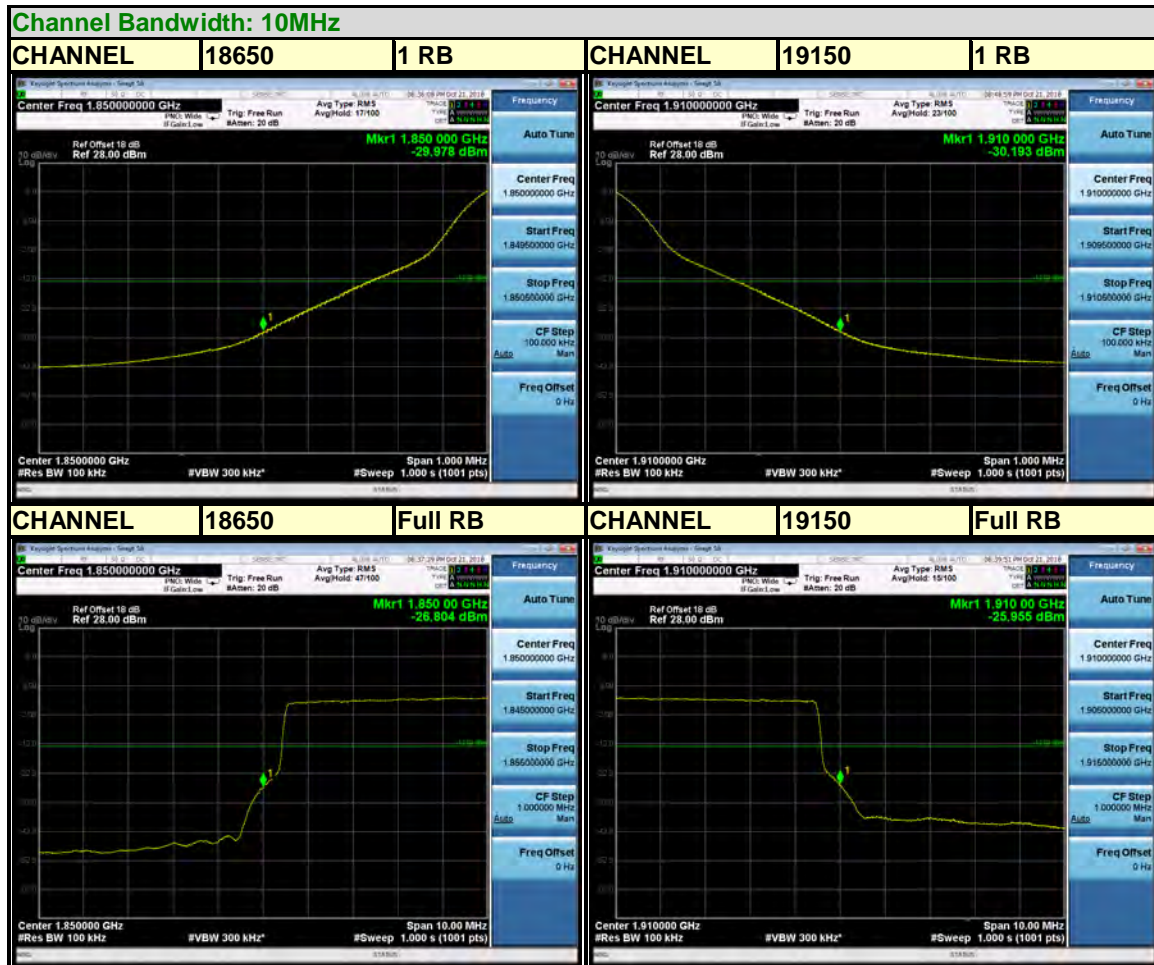



LTE BAND 2

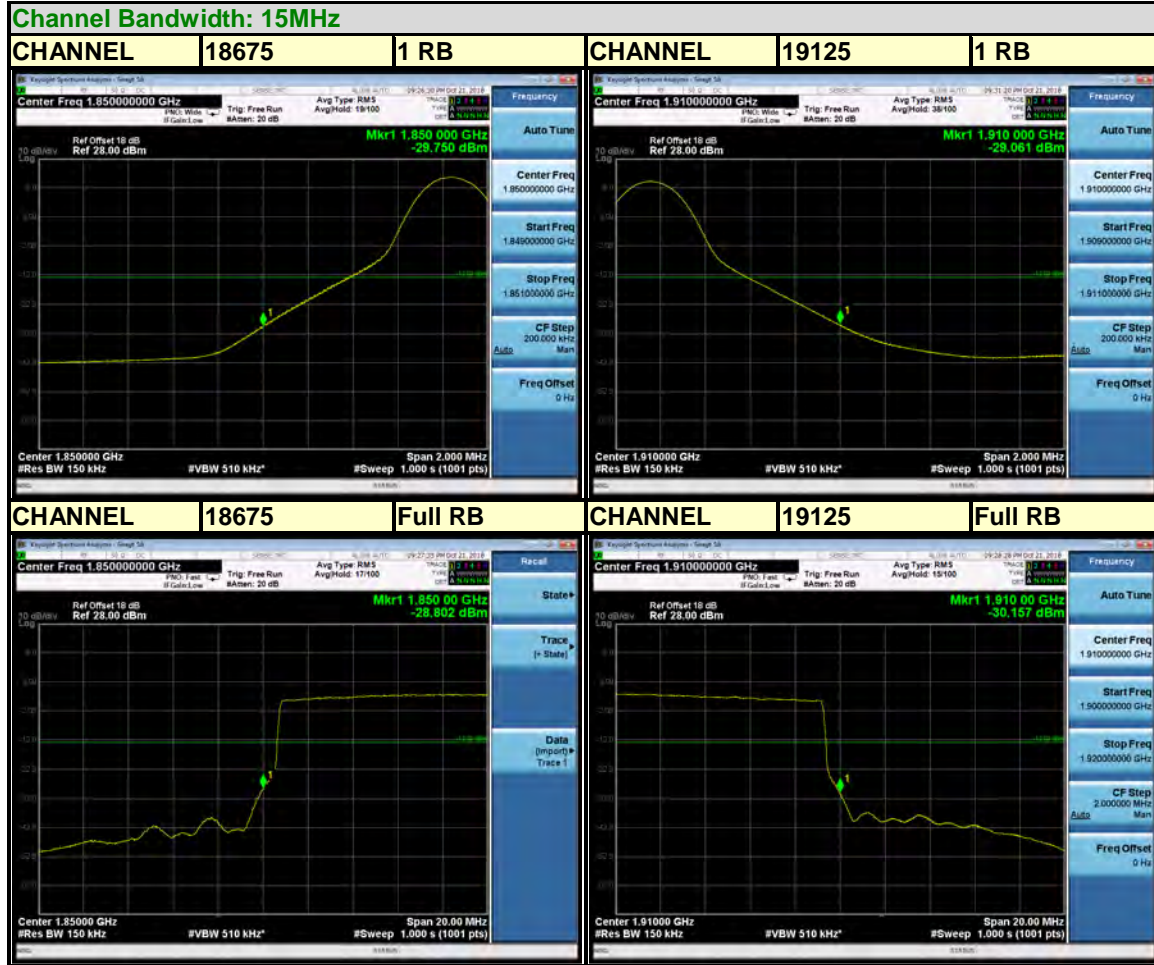

LTE BAND 2

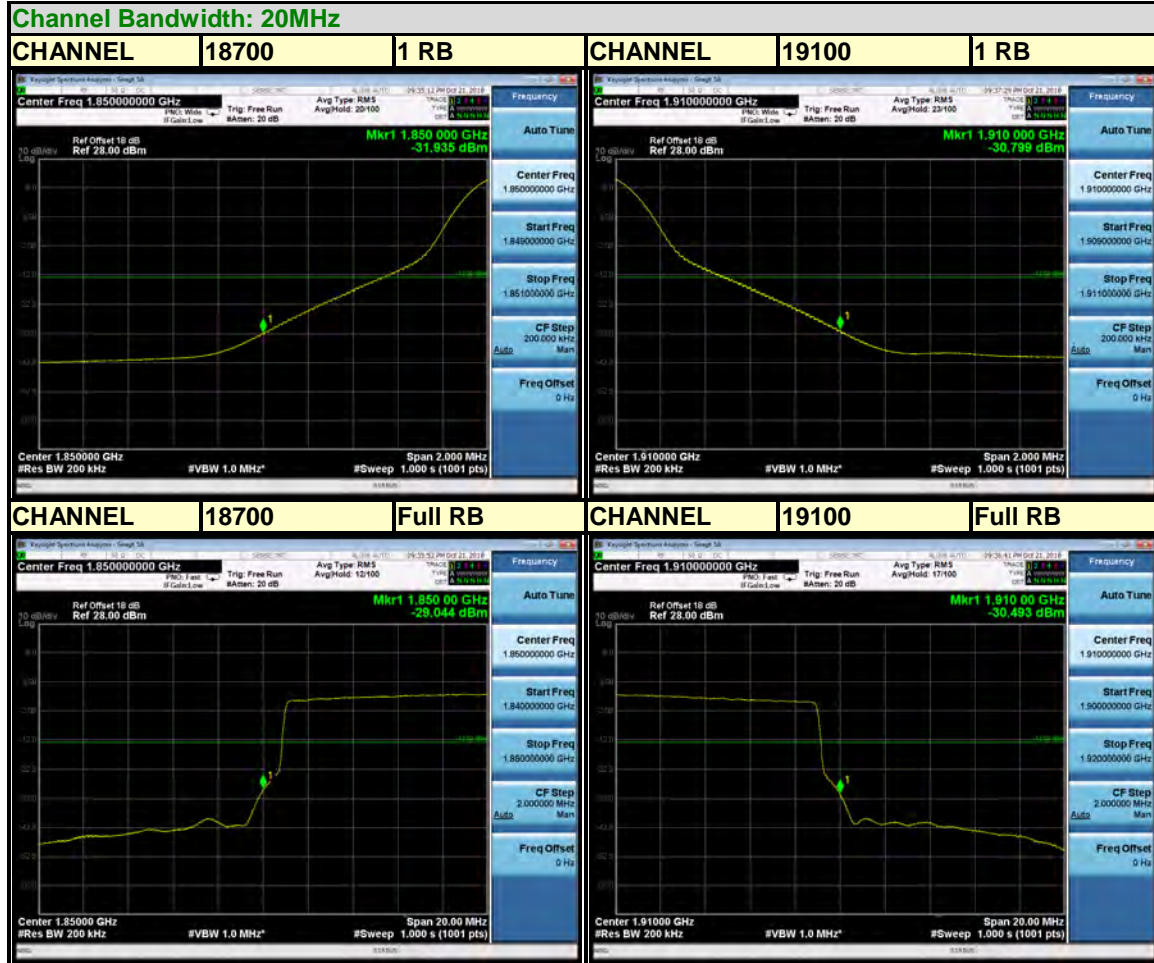

LTE BAND 25

Channel Bandwidth: 1.4MHz





LTE BAND 25

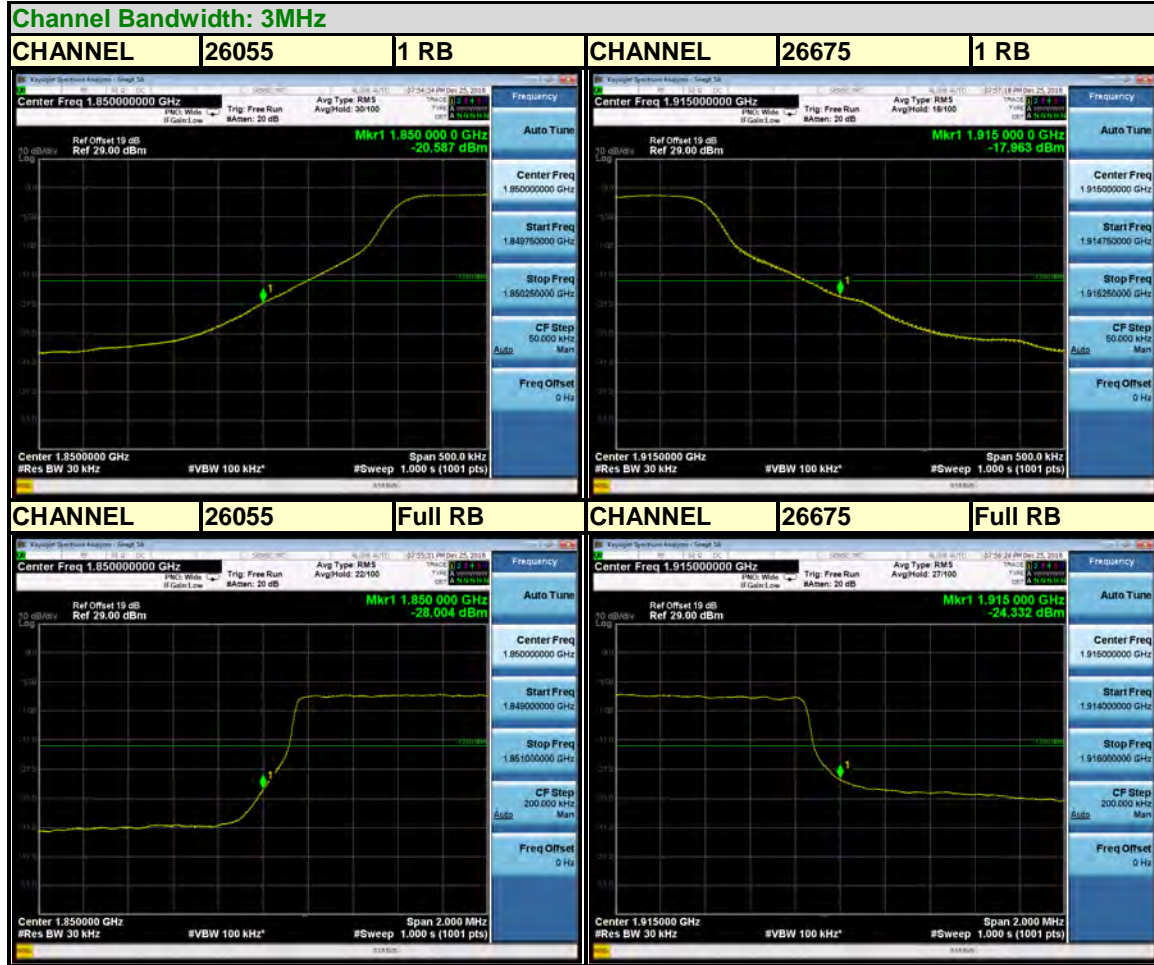



BUREAU VERITAS

Test Report No.: RF180829W002-5

LTE BAND 25

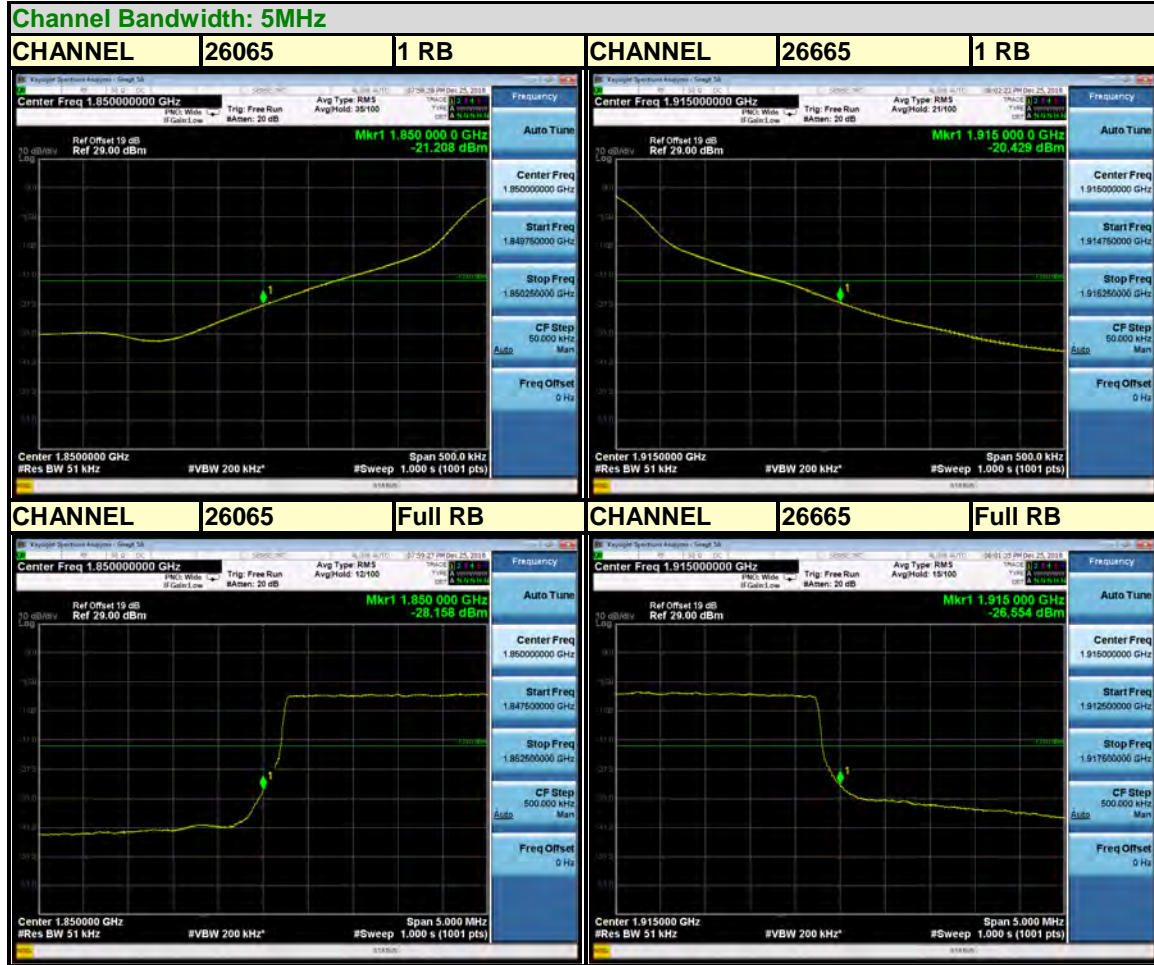



LTE BAND 25

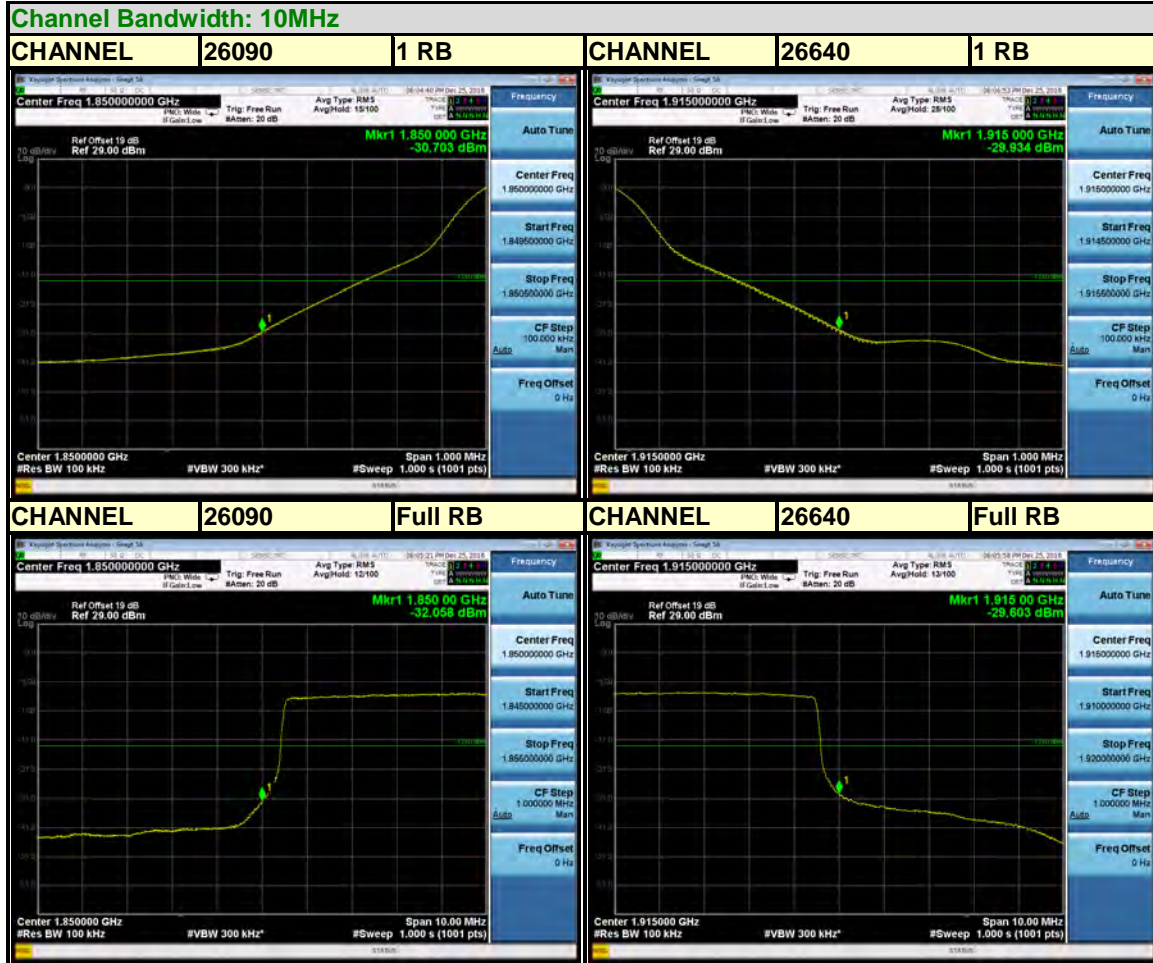

LTE BAND 25

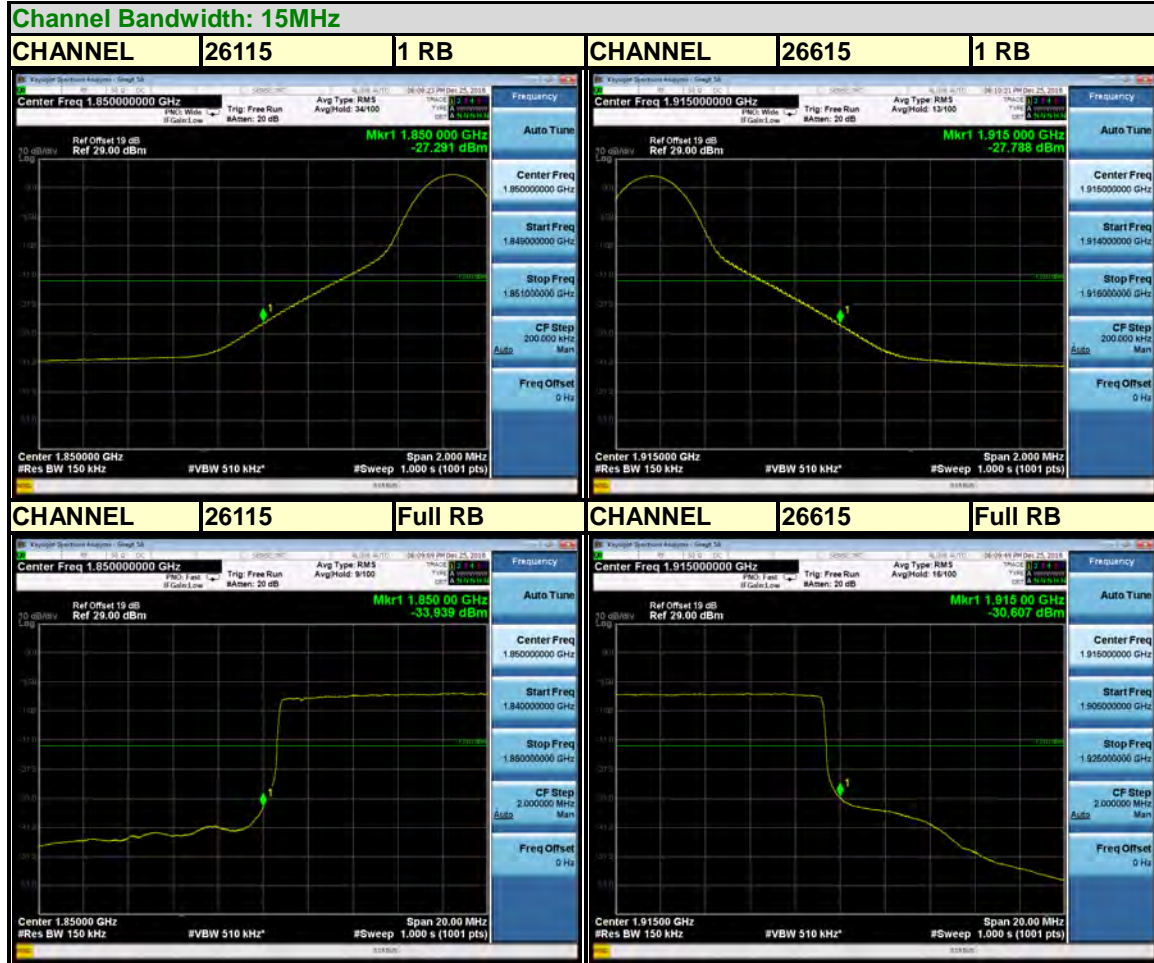



LTE BAND 25

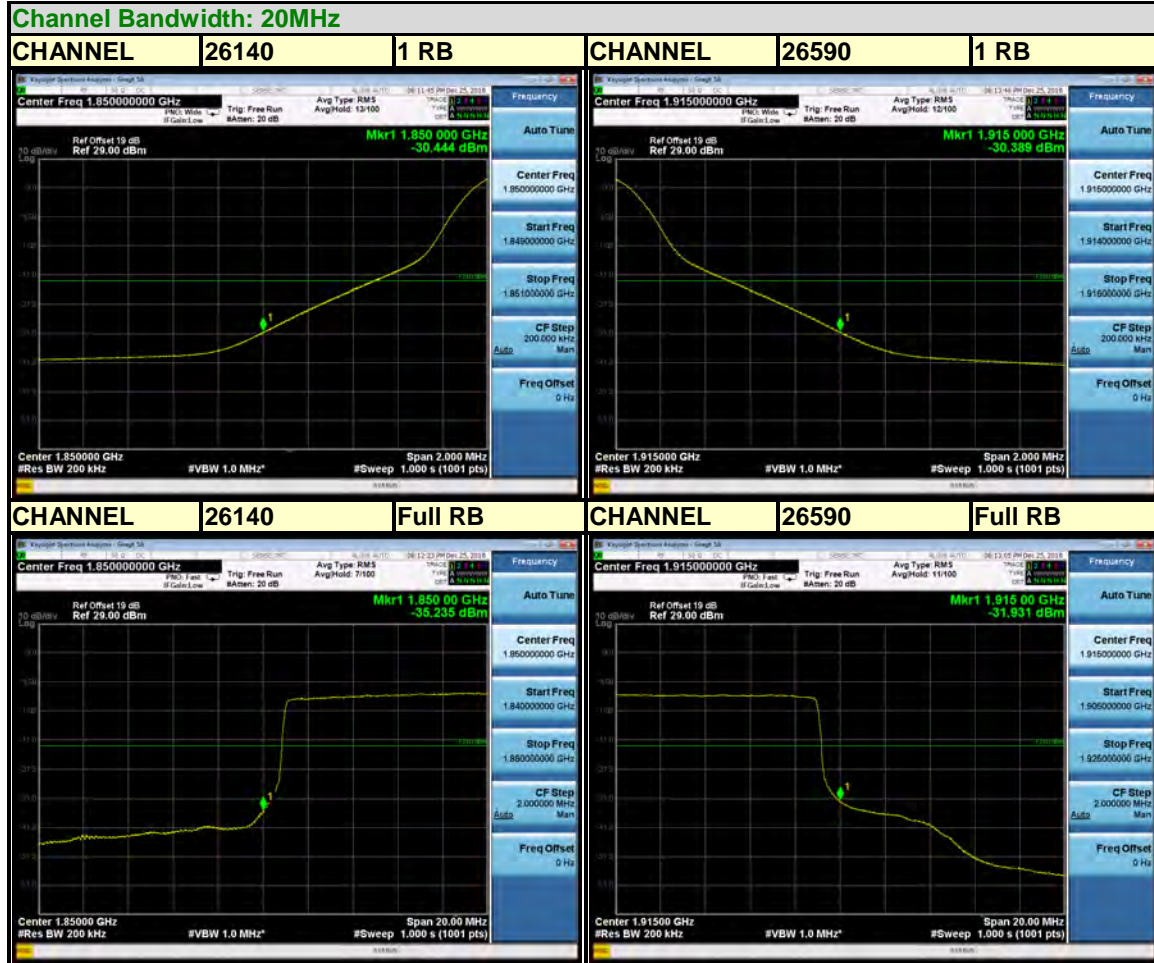

3.5 CONDUCTED SPURIOUS EMISSIONS

3.5.1 LIMITS OF CONDUCTED SPURIOUS EMISSIONS MEASUREMENT

The power of any emission outside of the authorized operating frequency ranges must be attenuated below the transmitting power (P) by a factor of at least $43 + 10 \log(P)$ dB. The emission limit equal to -13dBm .

3.5.2 TEST PROCEDURE

- a. The EUT makes a phone call to the communication simulator. All measurements were done at low, middle and high operational frequency range.
- b. Measuring frequency range is from 9 kHz to 19.1GHz. 10dB attenuation pad is connected with spectrum. RBW=1MHz and VBW=3MHz is used for conducted emission measurement.

3.5.3 TEST SETUP

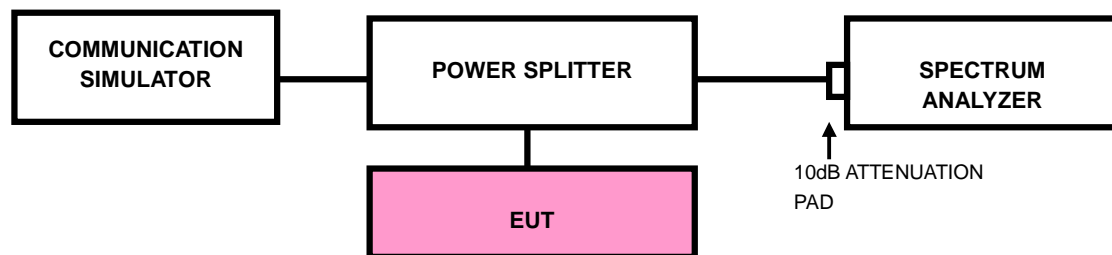



3.5.4 TEST RESULTS

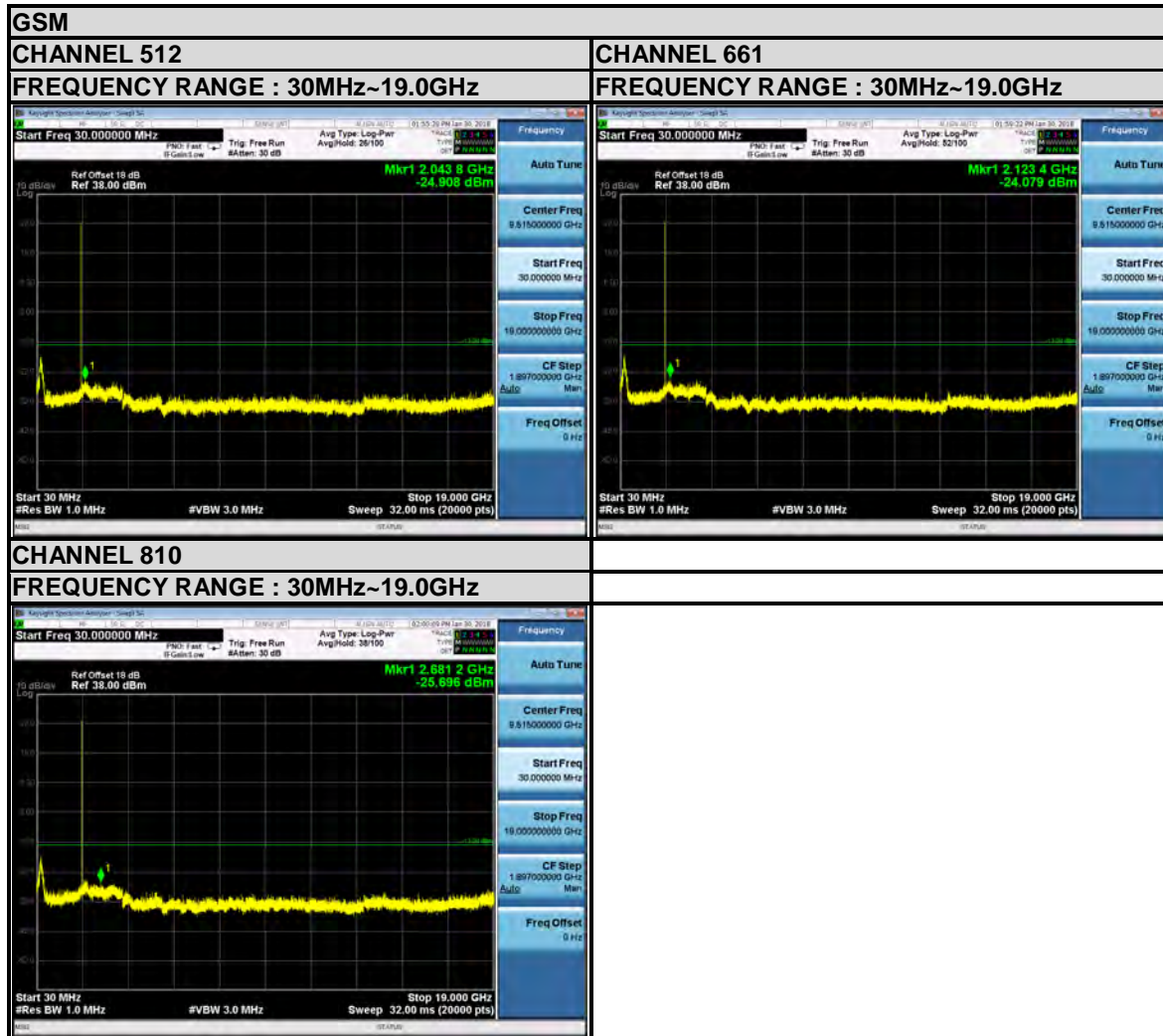

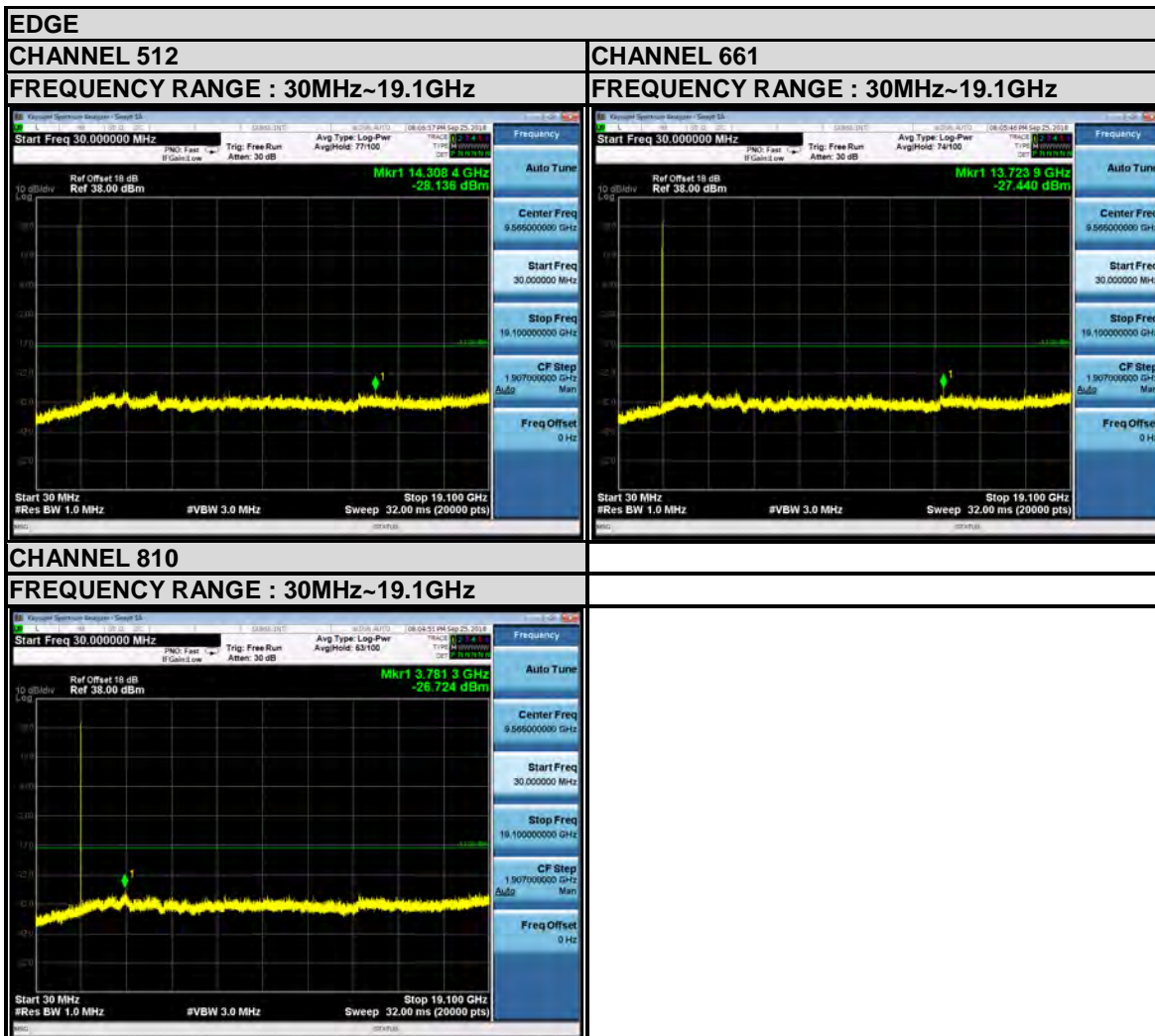

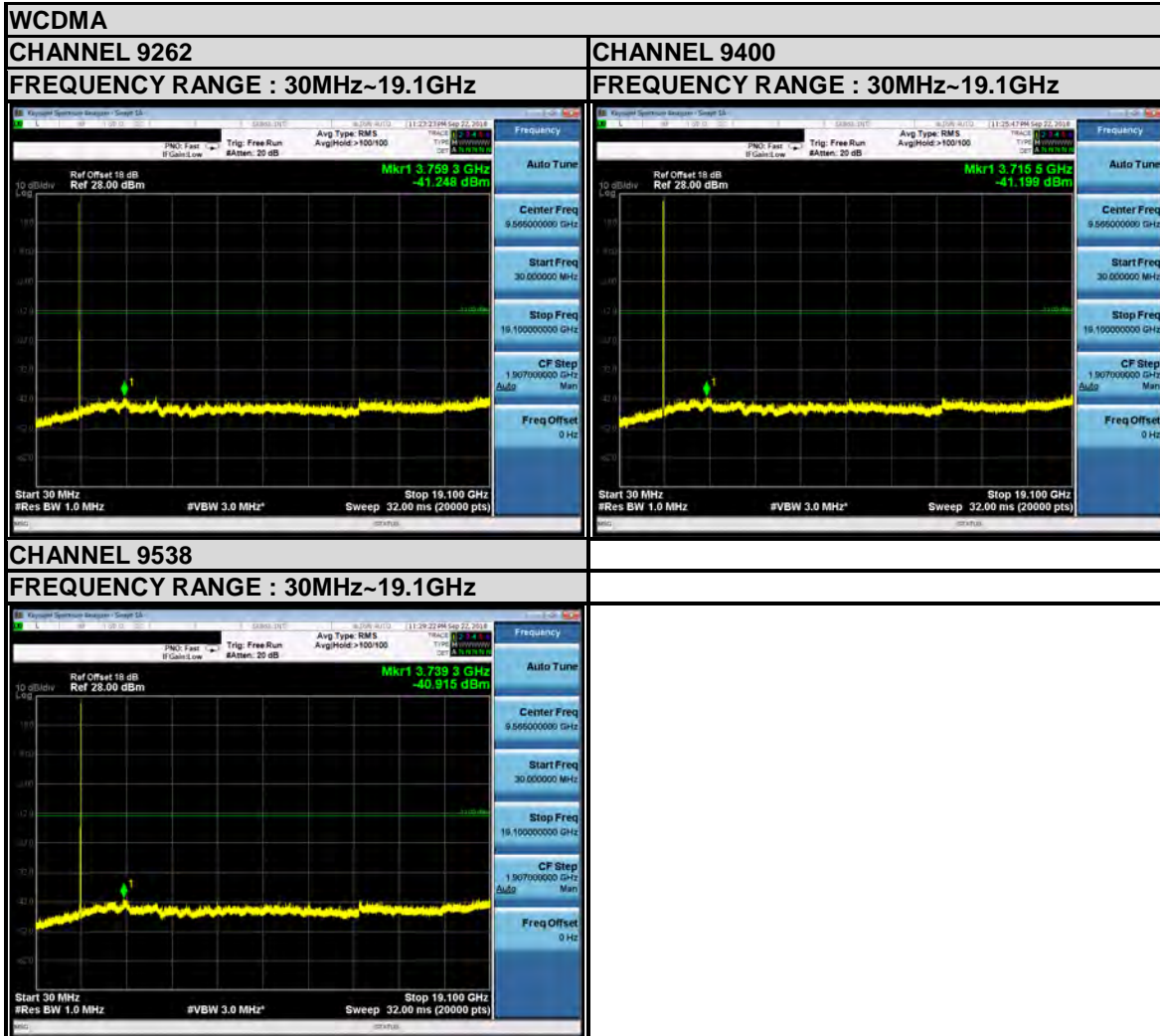

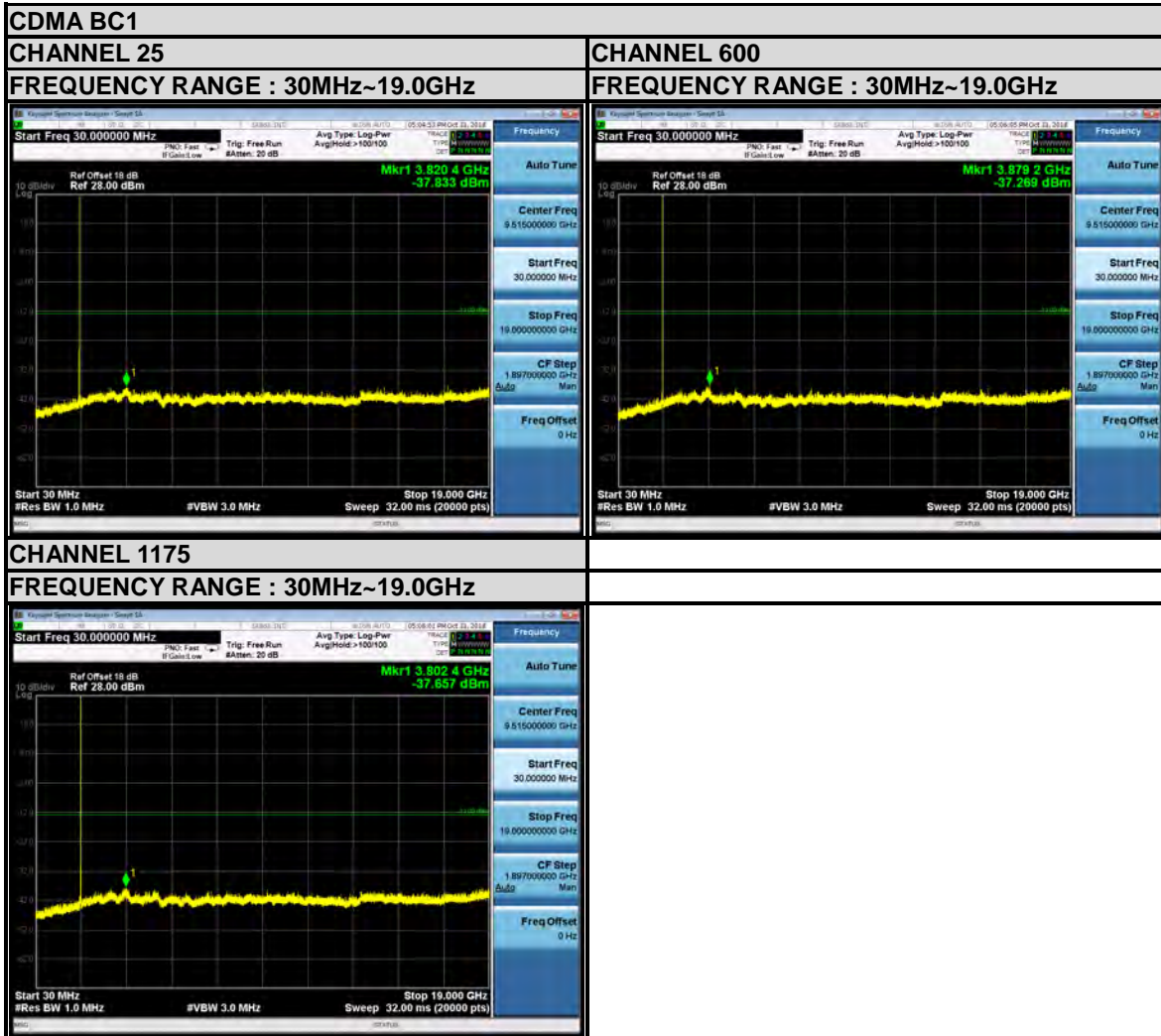



LTE BAND 2

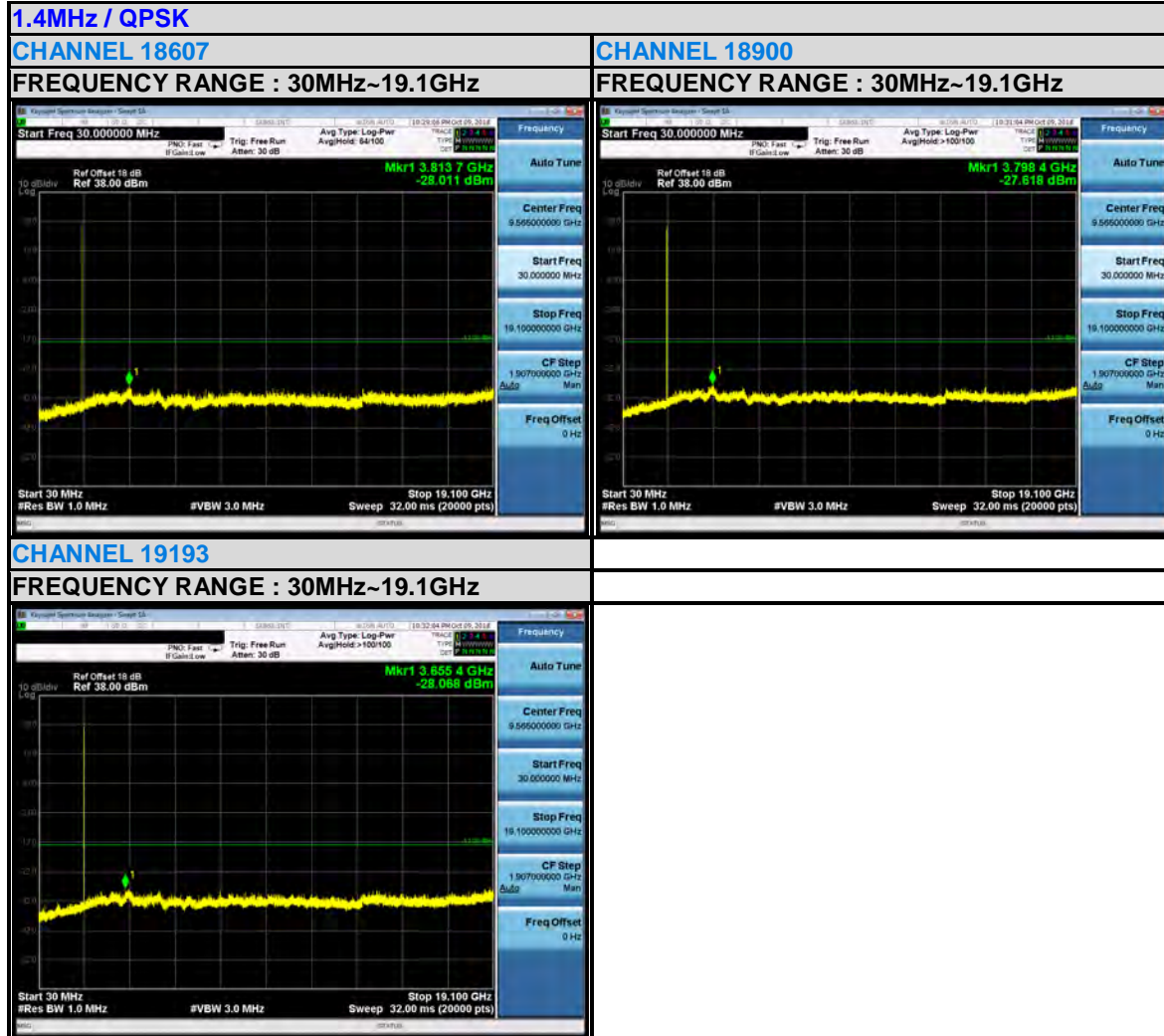



Test Report No.: RF180829W002-5

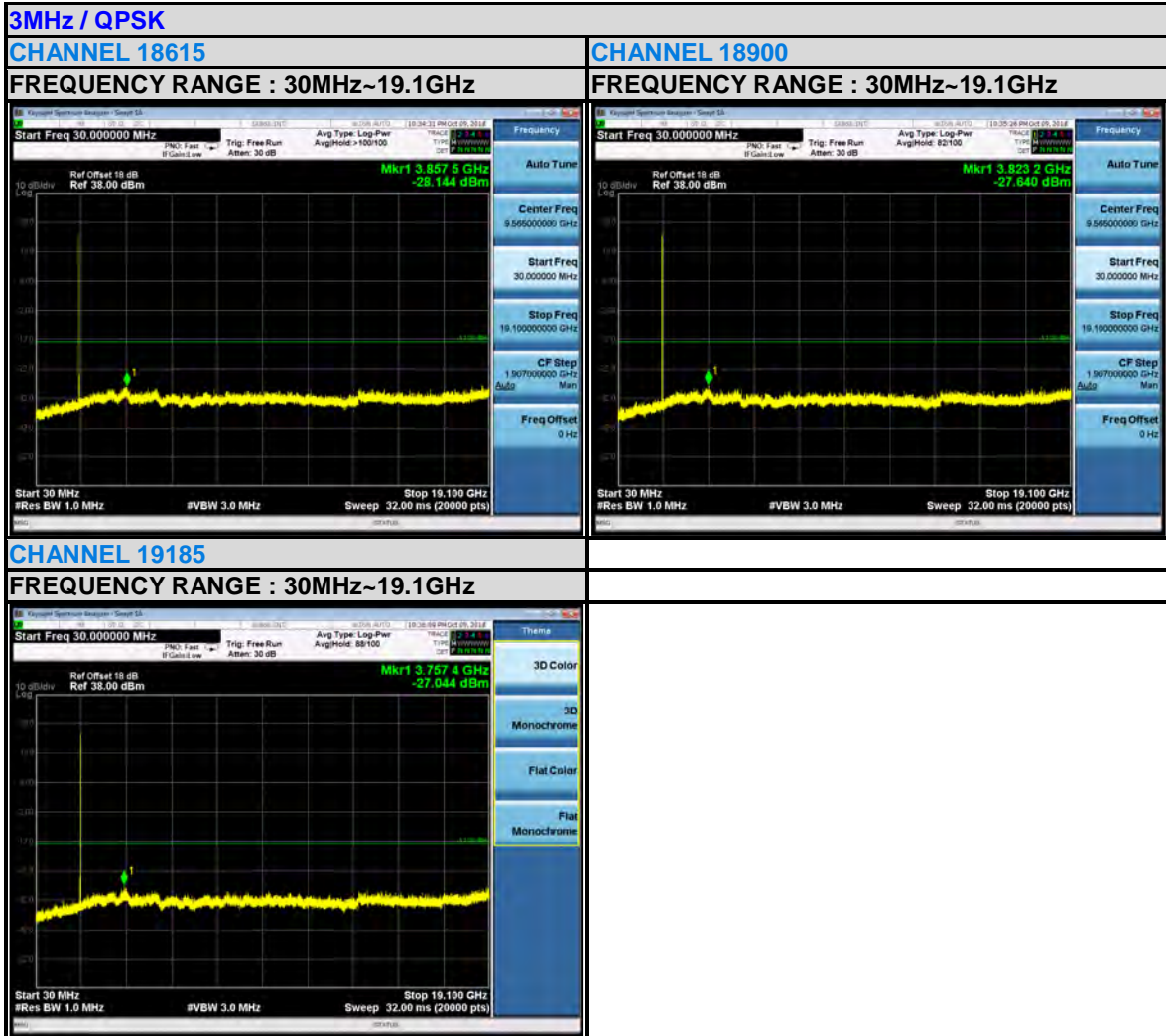



Test Report No.: RF180829W002-5

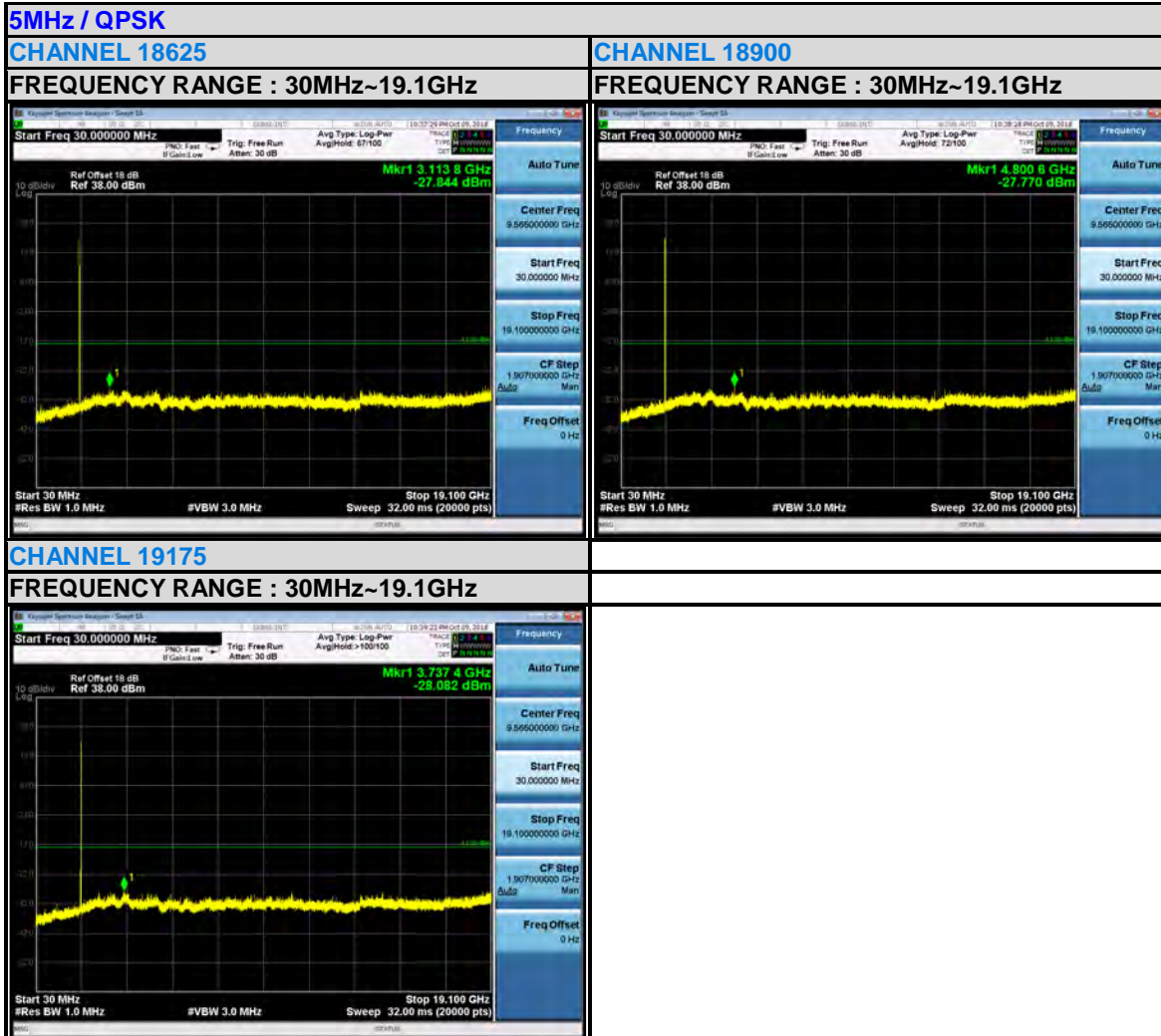

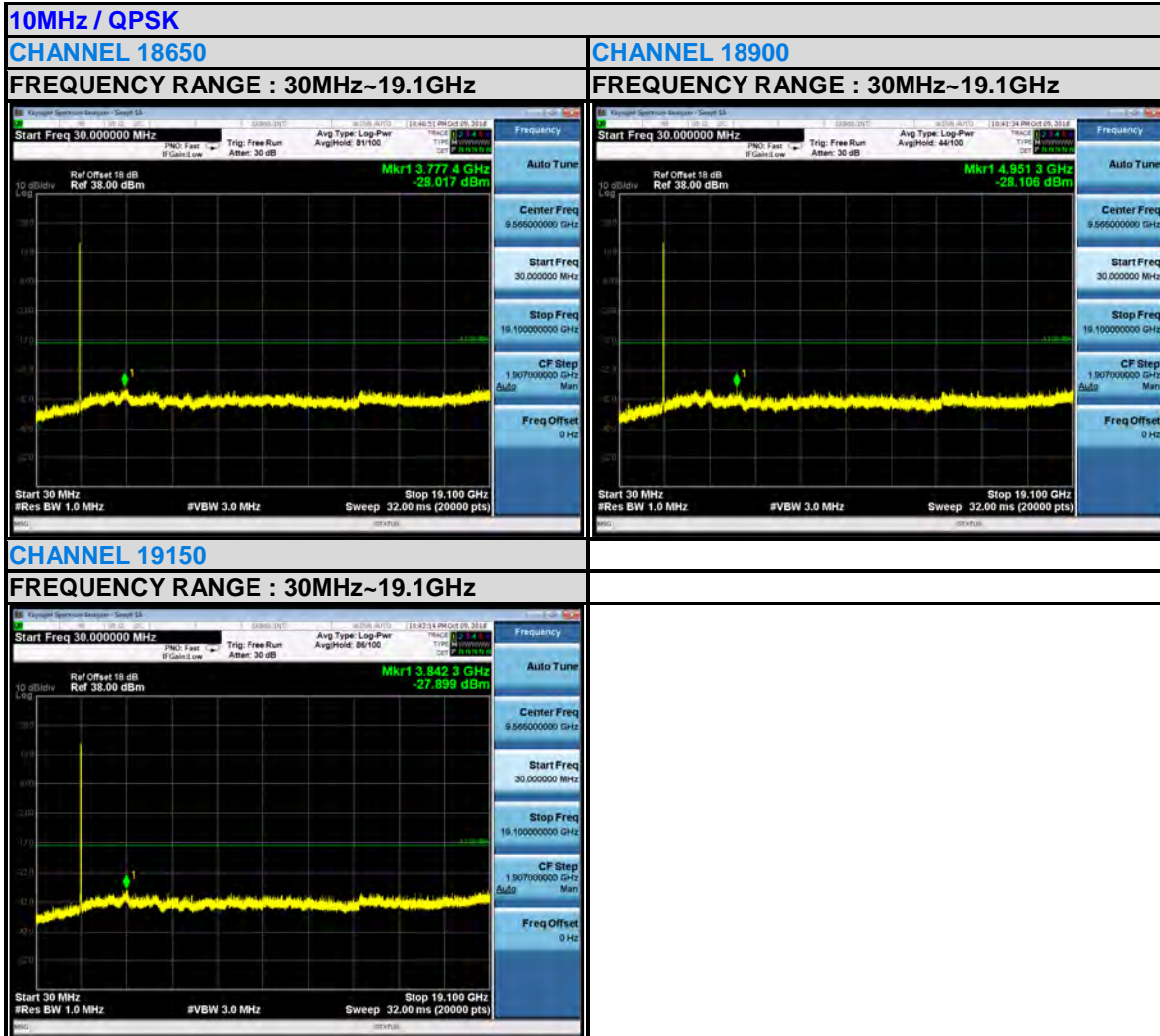



Test Report No.: RF180829W002-5

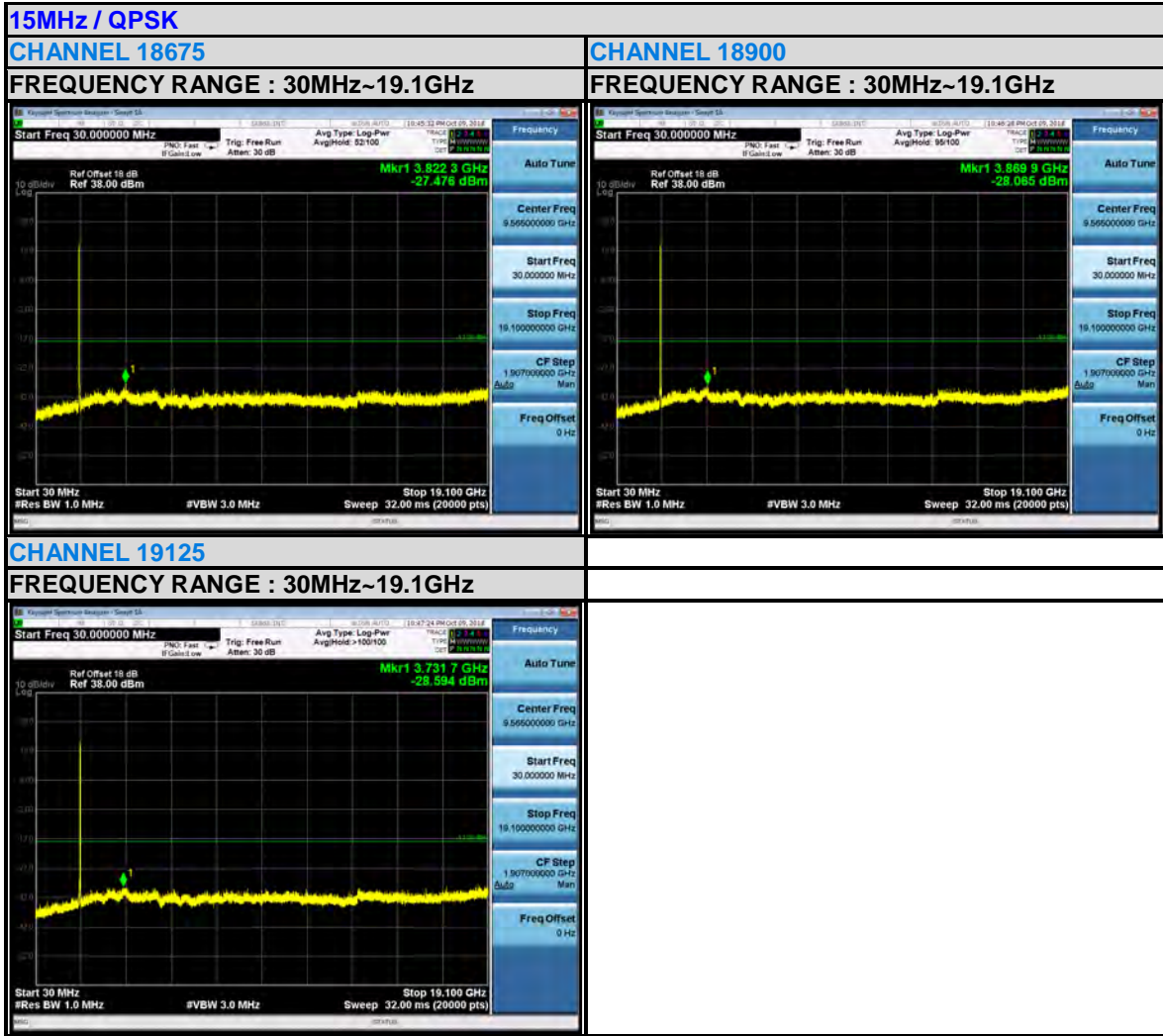





LTE BAND 25

1.4MHz / QPSK

CHANNEL 26047

FREQUENCY RANGE : 30MHz~19.15GHz

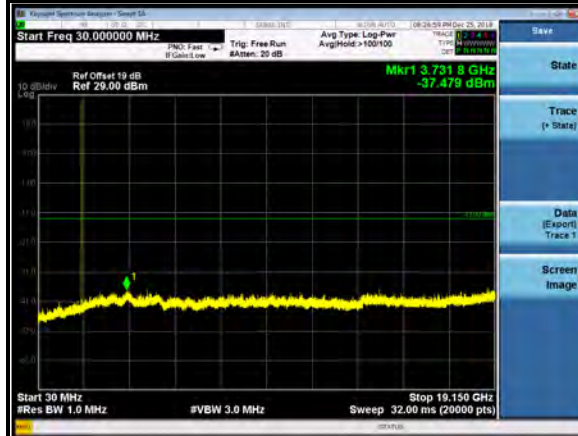

CHANNEL 26365

FREQUENCY RANGE : 30MHz~19.15GHz

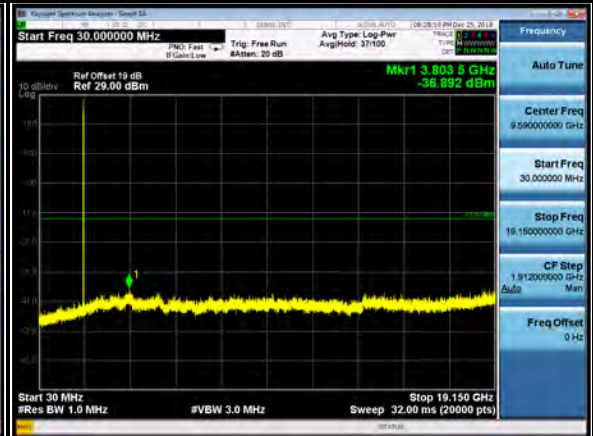

CHANNEL 26683

FREQUENCY RANGE : 30MHz~19.15GHz

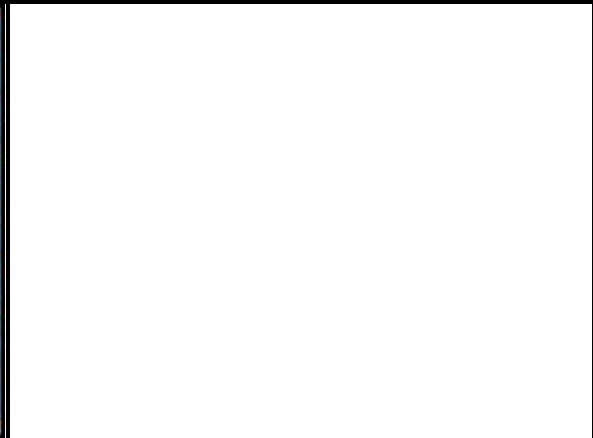
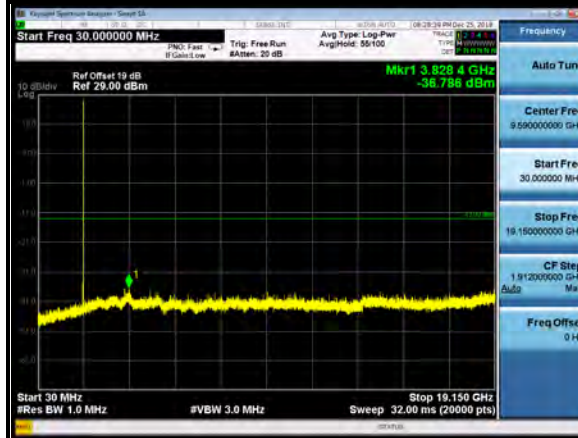

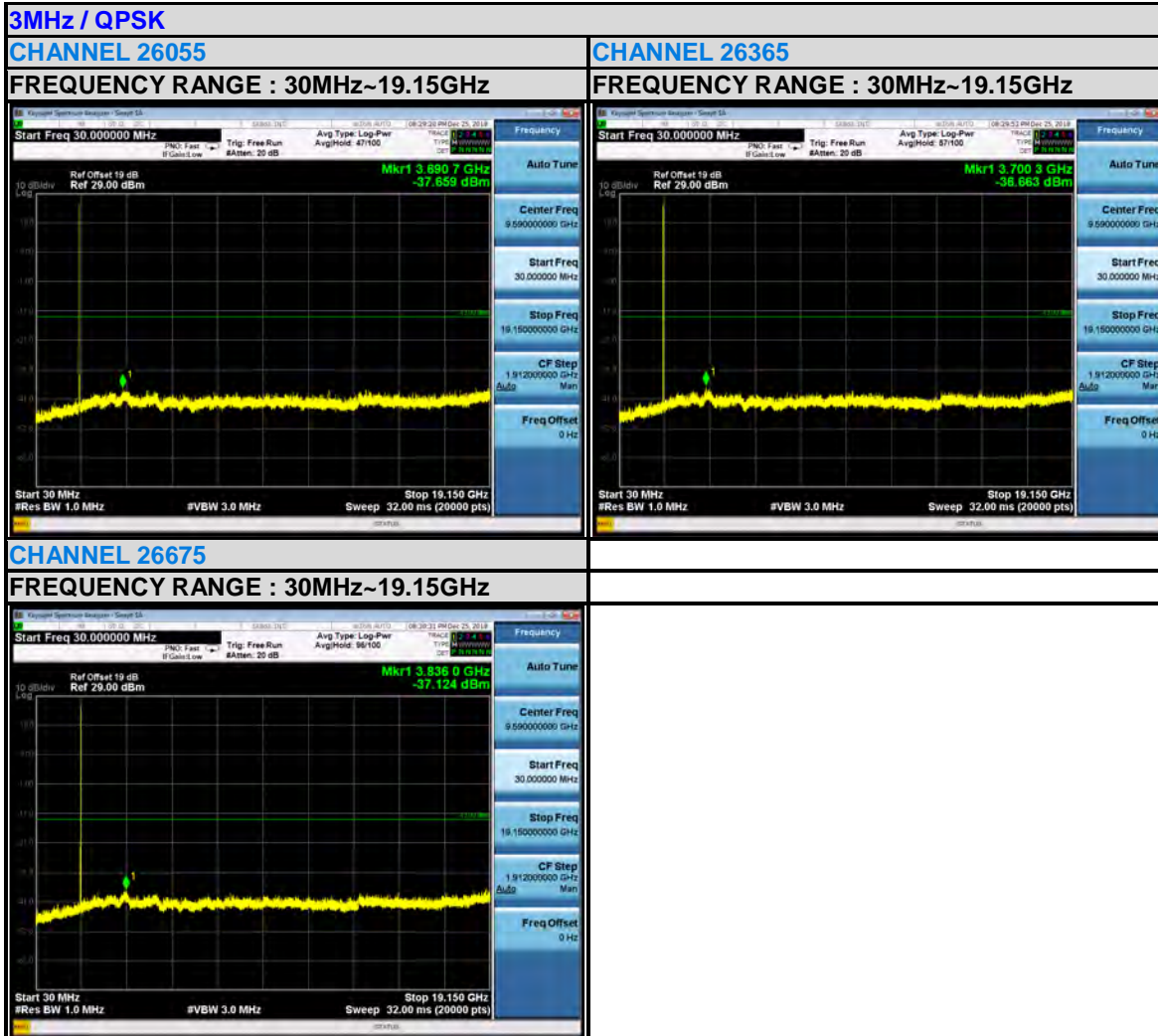

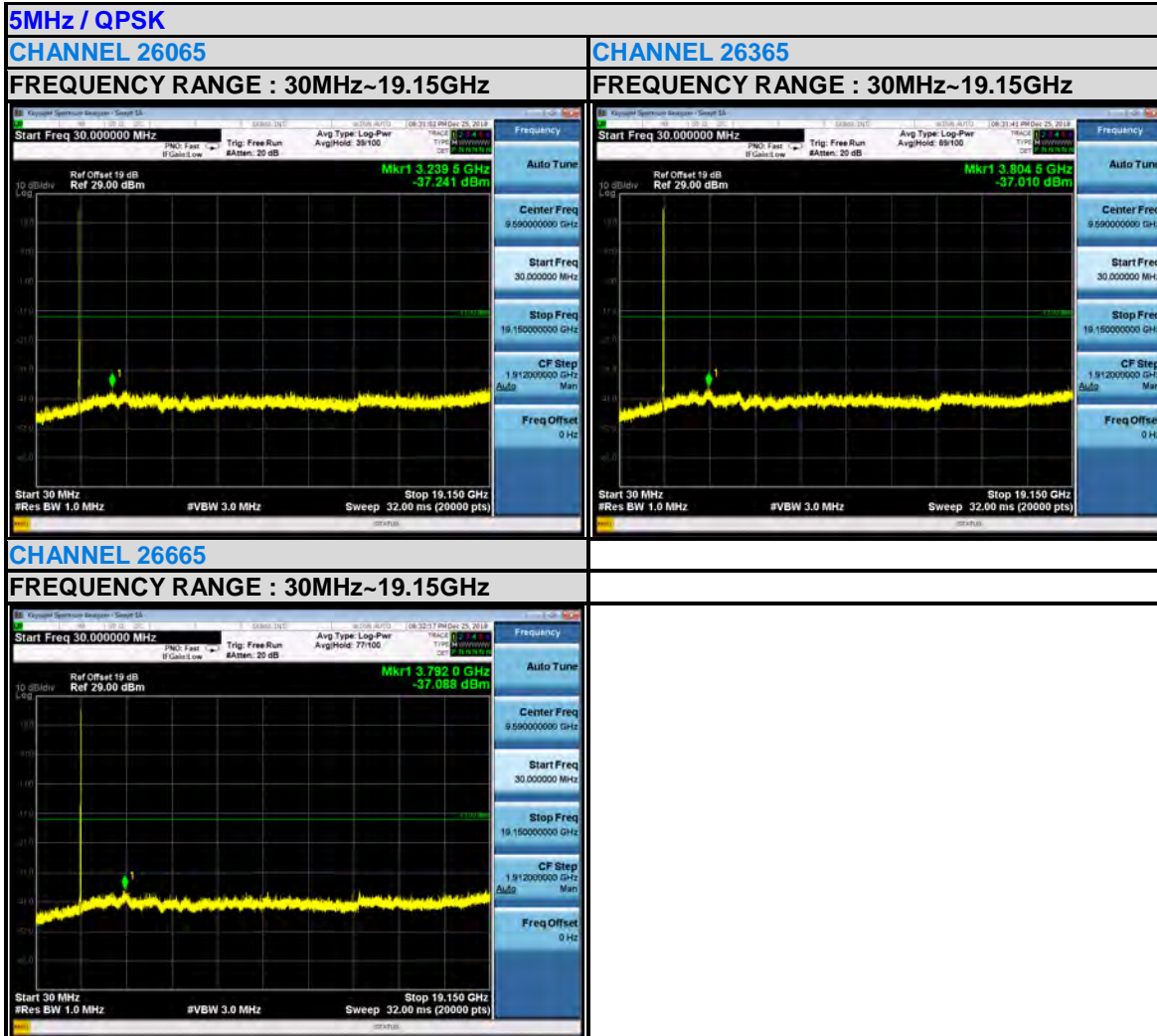



Test Report No.: RF180829W002-5

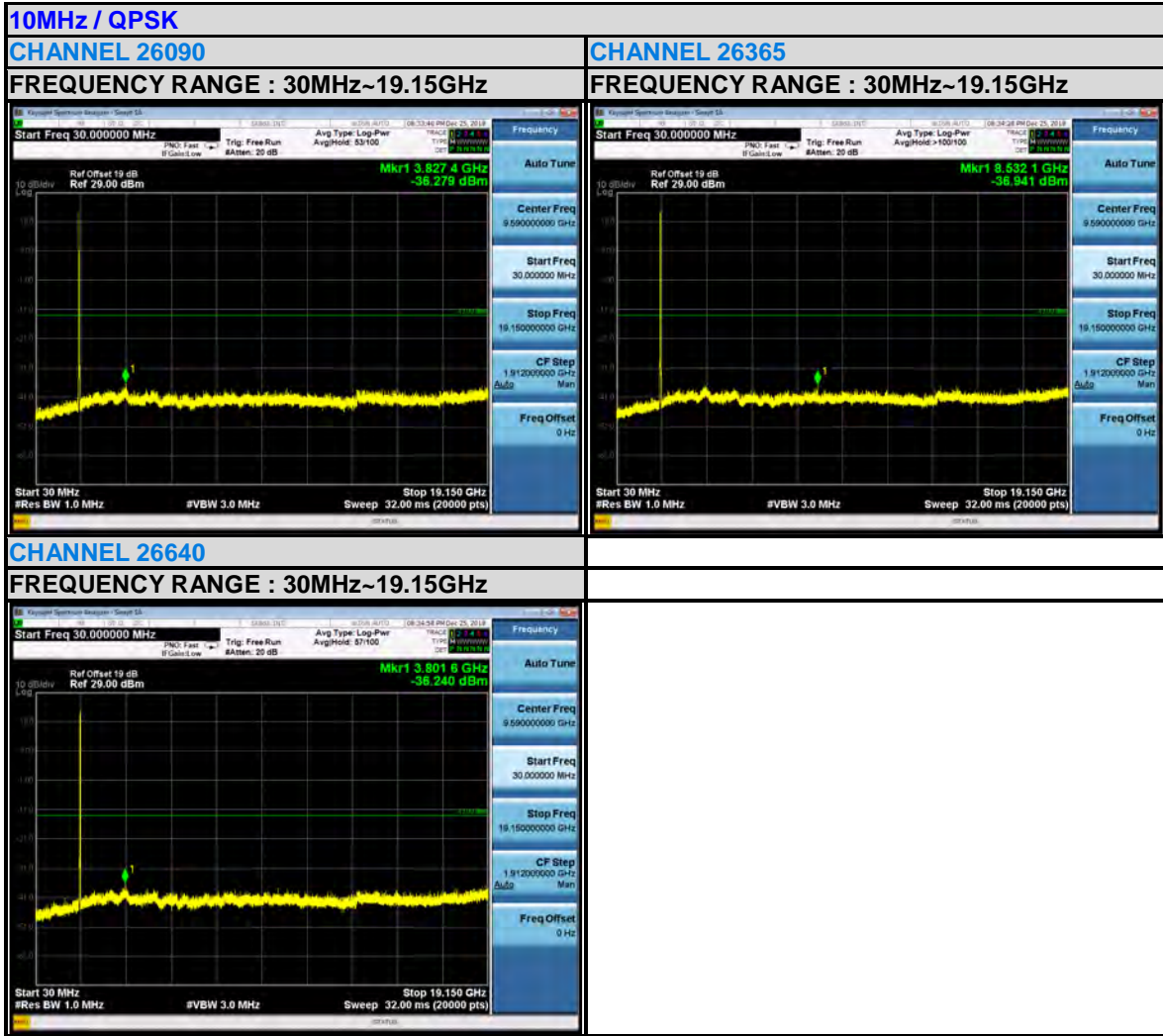



Test Report No.: RF180829W002-5

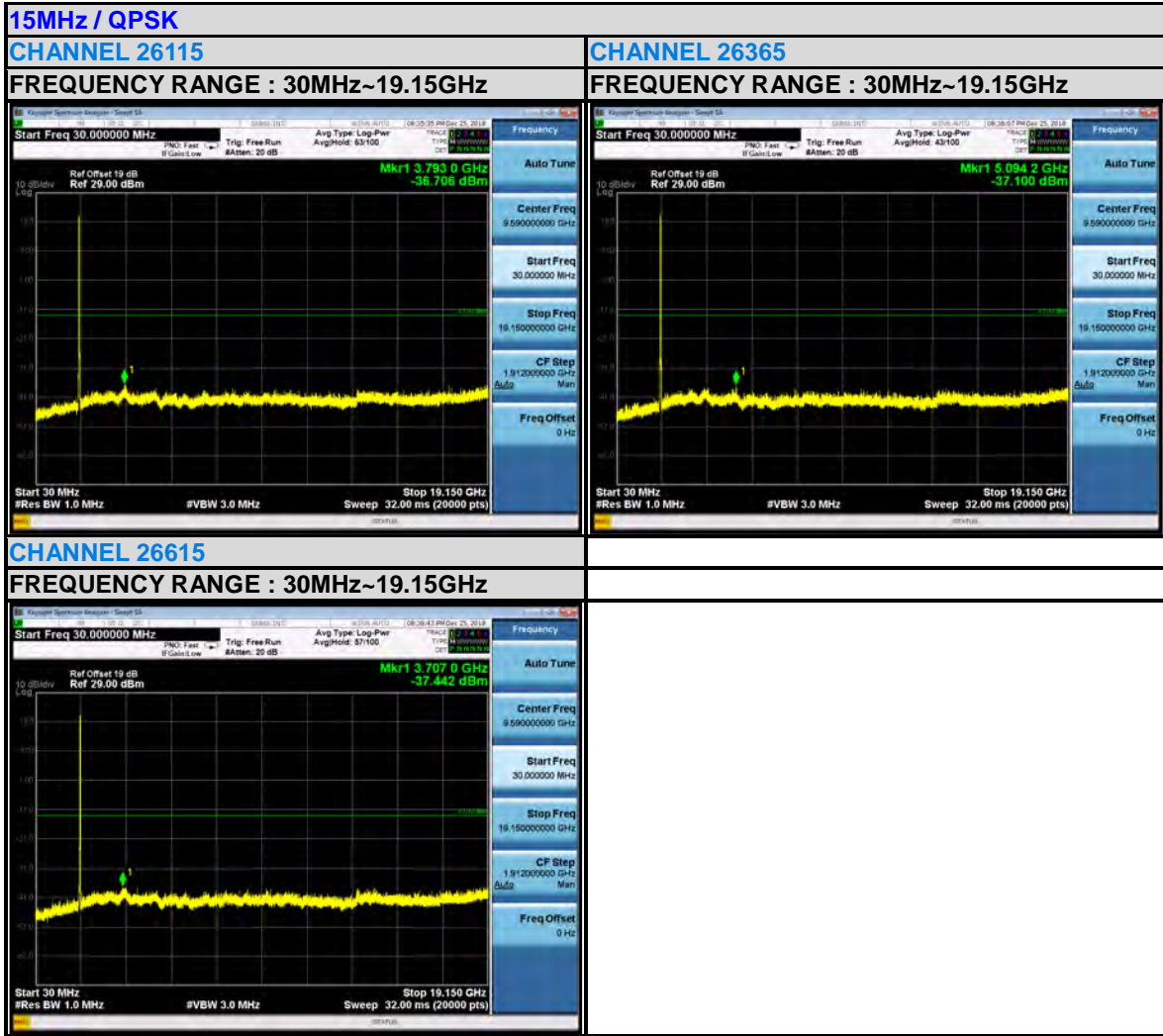



Test Report No.: RF180829W002-5





3.6 RADIATED EMISSION MEASUREMENT

3.6.1 LIMITS OF RADIATED EMISSION MEASUREMENT

The power of any emission outside of the authorized operating frequency ranges must be attenuated below the transmitting power (P) by a factor of at least $43 + 10 \log(P)$ dB. The emission limit equal to -13dBm .

3.6.2 TEST PROCEDURES

- a. Substitution method is used for E.I.R.P measurement. In the semi-anechoic chamber, EUT placed on the 0.8m height of Turn Table, rotated the table around 360 degrees to search the maximum radiation power and receiver antenna shall be rotated vertical and horizontal polarization and moved height from 1m to 4m to find the maximum polar radiated power. The “Read Value” is the spectrum reading the maximum power value.
- b. The substitution horn antenna is substituted for EUT at the same position and signals generator export the CW signal to the substitution antenna via a TX cable. Rotated the Turn Table and moved receiving antenna to find the maximum radiation power. Adjust output power level of S.G to get a Value of spectrum reading equal to “Read Value “ of step a. Record the power level of S.G
- c. EIRP = Output power level of S.G - TX cable loss + Antenna gain of substitution horn.

NOTE: The resolution bandwidth and video bandwidth of test receiver/spectrum analyzer is 1MHz/3MHz.

3.6.3 DEVIATION FROM TEST STANDARD

No deviation

3.6.4 TEST SETUP

<Below 30MHz>

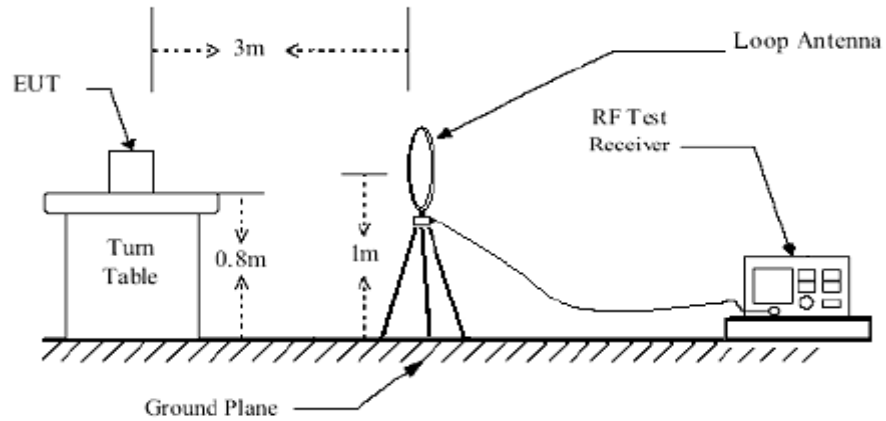

< Frequency Range 30MHz~1GHz >

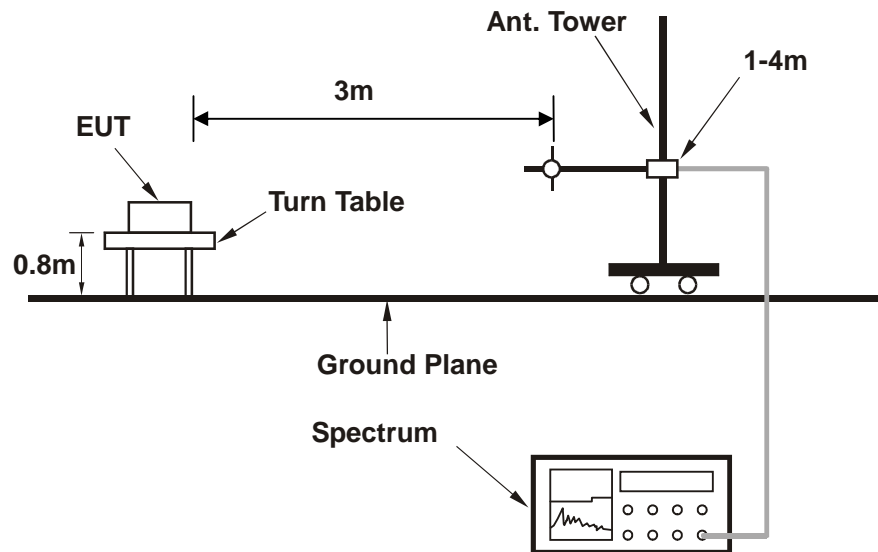

< Frequency Range above 1GHz >

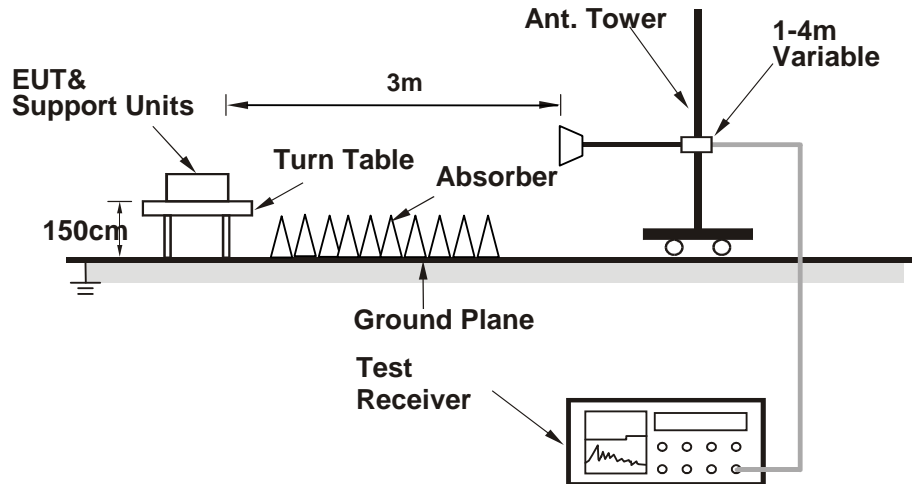

For the actual test configuration, please refer to the attached file (Test Setup Photo).



3.6.5 TEST RESULTS

BELOW 1GHz WORST-CASE DATA

9 KHz – 30 MHz data: the amplitude of spurious emissions attenuated more than 20 dB below the permissible value is not required in the report.

30 MHz – 1GHz data:

LTE Band 25:

MODE	TX channel 26365	FREQUENCY RANGE	Below 1000MHz
ENVIRONMENTAL CONDITIONS	23deg. C, 70%RH	INPUT POWER	DC 5V from adapter
TESTED BY	Rose Ma		
ANTENNA POLARITY & TEST DISTANCE: HORIZONTAL AT 3 M			

	Freq	Level	Read Level	Limit Line	Over Limit	Factor	Remark	Pol/Phase
	MHz	dBm/m	dBm	dBm/m	dB	dB/m		
1	62.850	-49.94	-41.29	-13.00	-36.94	-8.65	Peak	Horizontal
2	95.680	-48.65	-38.41	-13.00	-35.65	-10.24	Peak	Horizontal
3	178.520	-54.35	-36.54	-13.00	-41.35	-17.81	Peak	Horizontal
4	221.360	-65.58	-48.75	-13.00	-52.58	-16.83	Peak	Horizontal
5	302.580	-63.93	-50.21	-13.00	-50.93	-13.72	Peak	Horizontal
6	425.620	-53.03	-42.59	-13.00	-40.03	-10.44	Peak	Horizontal

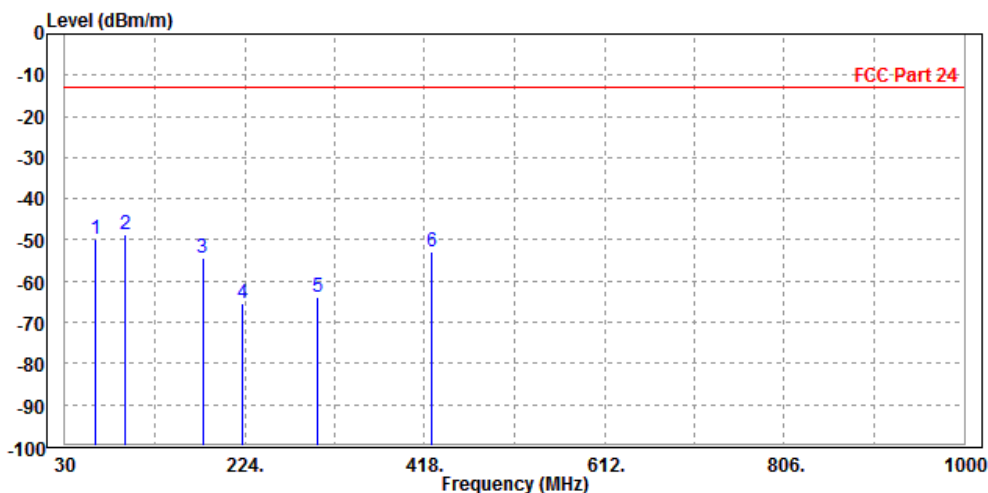



Test Report No.: RF180829W002-5

MODE	TX channel 26365	FREQUENCY RANGE	Below 1000MHz
ENVIRONMENTAL CONDITIONS	23deg. C, 70%RH	INPUT POWER	DC 5V from adapter
TESTED BY	Rose Ma		
ANTENNA POLARITY & TEST DISTANCE: VERTICAL AT 3 M			

	Freq	Level	Read Level	Limit Line	Over Limit	Factor	Remark	Pol/Phase	
	MHz	dBm/m	dBm	dBm/m	dB	dB/m			
1	PP	62.310	-49.36	-36.25	-13.00	-36.36	-13.11	Peak	Vertical
2		125.680	-60.66	-48.59	-13.00	-47.66	-12.07	Peak	Vertical
3		161.240	-61.37	-46.23	-13.00	-48.37	-15.14	Peak	Vertical
4		179.650	-58.68	-45.48	-13.00	-45.68	-13.20	Peak	Vertical
5		356.290	-53.27	-42.18	-13.00	-40.27	-11.09	Peak	Vertical
6		501.260	-57.14	-49.89	-13.00	-44.14	-7.25	Peak	Vertical

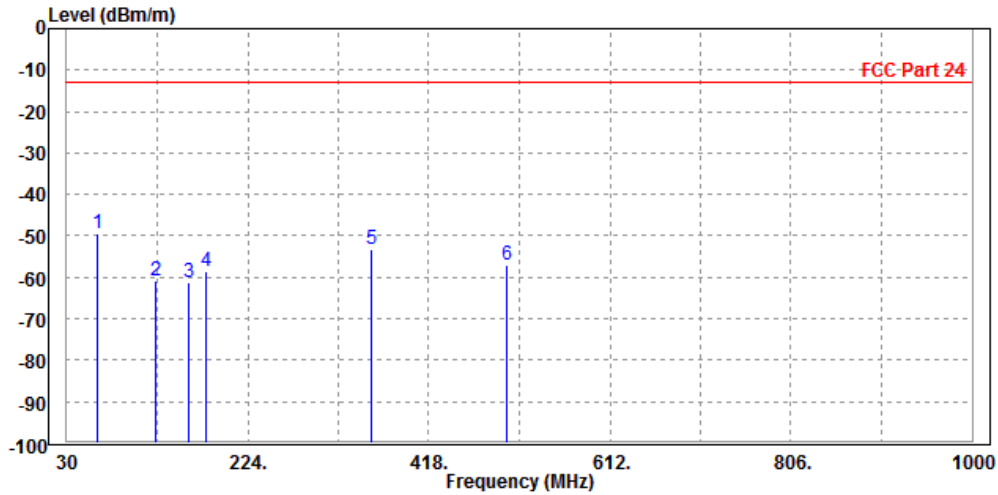



Test Report No.: RF180829W002-5

ABOVE 1GHz DATA

Note: For higher frequency, the emission is too low to be detected.

PCS 1900:

CH 512

MODE	TX channel 512	FREQUENCY RANGE	Above 1000MHz
ENVIRONMENTAL CONDITIONS	23deg. C, 70%RH	INPUT POWER	DC 5V from adapter
TESTED BY	Rose Ma		
ANTENNA POLARITY & TEST DISTANCE: HORIZONTAL AT 3 M			

	Freq	Level	Read Level	Limit Line	Over Limit	Factor	Remark	Pol/Phase
	MHz	dBm/m	dBm	dBm/m	dB	dB/m		
1	PP 3698.000	-42.61	-45.72	-13.00	-29.61	3.11	Peak	Horizontal
2	5550.600	-47.68	-56.70	-13.00	-34.68	9.02	Peak	Horizontal

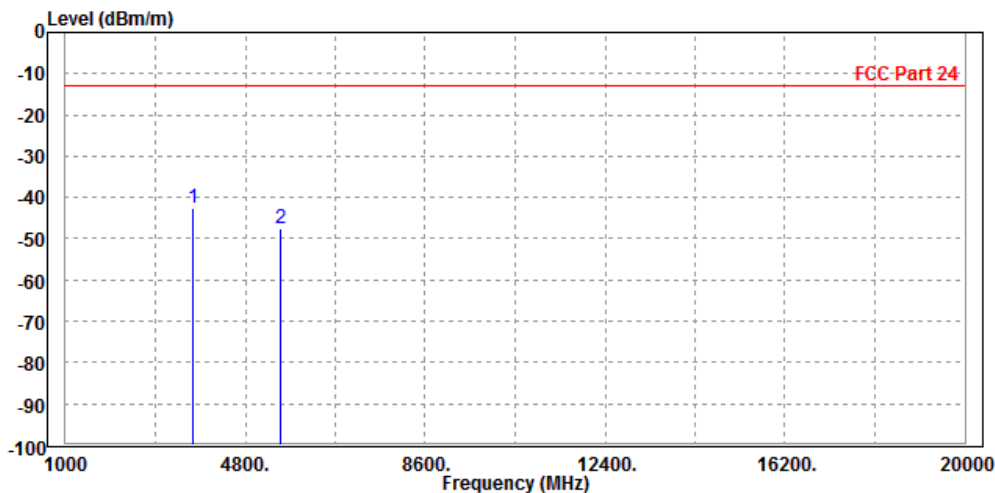



Test Report No.: RF180829W002-5

MODE	TX channel 512	FREQUENCY RANGE	Above 1000MHz
ENVIRONMENTAL CONDITIONS	23deg. C, 70%RH	INPUT POWER	DC 5V from adapter
TESTED BY	Rose Ma		
ANTENNA POLARITY & TEST DISTANCE: VERTICAL AT 3 M			

	Freq	Level	Read Level	Limit Line	Over Limit	Factor	Remark	Pol/Phase
	MHz	dBm/m	dBm	dBm/m	dB	dB/m		
1	PP 3698.000	-46.01	-49.58	-13.00	-33.01	3.57	Peak	Vertical
2	5550.600	-49.07	-57.14	-13.00	-36.07	8.07	Peak	Vertical

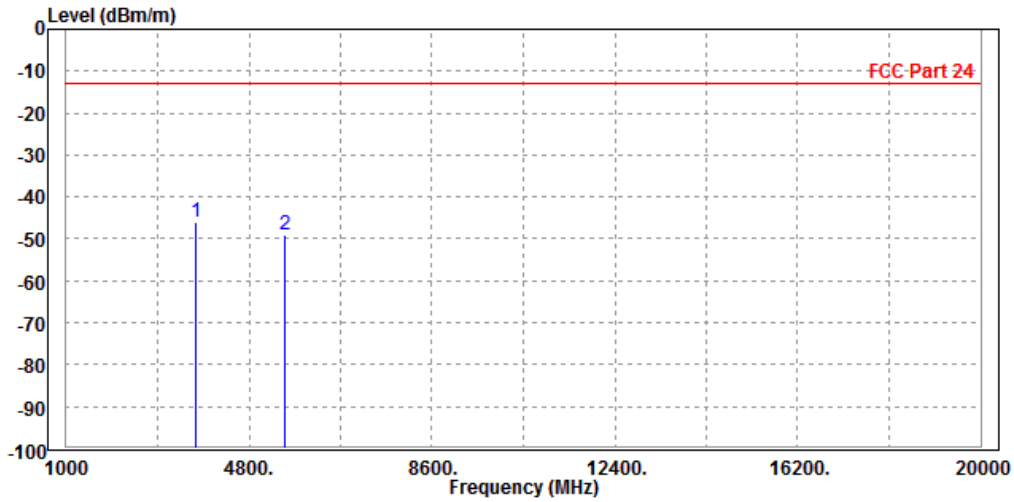



Test Report No.: RF180829W002-5

CH 661

MODE	TX channel 661	FREQUENCY RANGE	Above 1000MHz
ENVIRONMENTAL CONDITIONS	23deg. C, 70%RH	INPUT POWER	DC 5V from adapter
TESTED BY	Rose Ma		
ANTENNA POLARITY & TEST DISTANCE: HORIZONTAL AT 3 M			

	Freq	Level	Read Level	Limit Line	Over Limit	Factor	Remark	Pol/Phase
	MHz	dBm/m	dBm	dBm/m	dB	dB/m		
1	PP 3755.000	-44.34	-47.73	-13.00	-31.34	3.39	Peak	Horizontal
2	5640.000	-47.18	-56.30	-13.00	-34.18	9.12	Peak	Horizontal

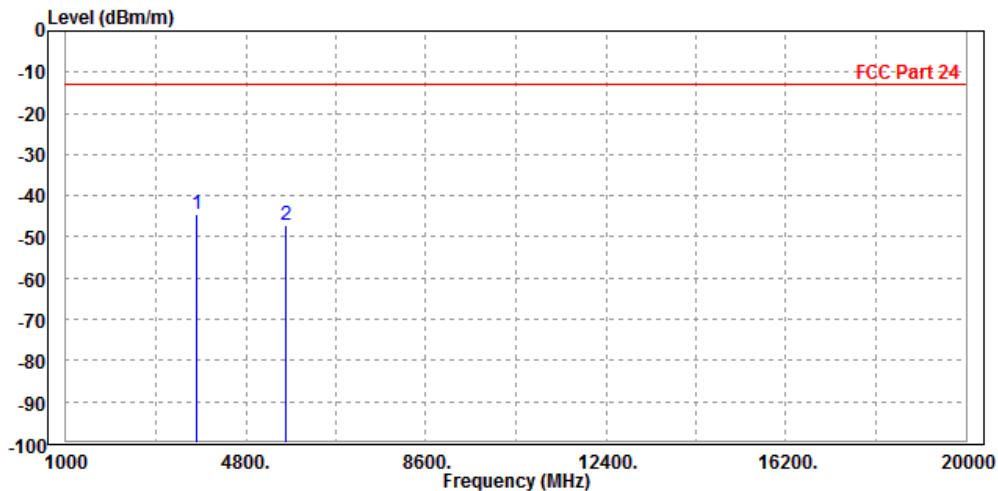



Test Report No.: RF180829W002-5

MODE	TX channel 661	FREQUENCY RANGE	Above 1000MHz
ENVIRONMENTAL CONDITIONS	23deg. C, 70%RH	INPUT POWER	DC 5V from adapter
TESTED BY	Rose Ma		
ANTENNA POLARITY & TEST DISTANCE: VERTICAL AT 3 M			

	Freq	Level	Read Level	Limit Line	Over Limit	Factor	Remark	Pol/Phase
	MHz	dBm/m	dBm	dBm/m	dB	dB/m		
1	PP 3755.000	-44.05	-47.90	-13.00	-31.05	3.85	Peak	Vertical
2	5640.000	-44.56	-52.82	-13.00	-31.56	8.26	Peak	Vertical

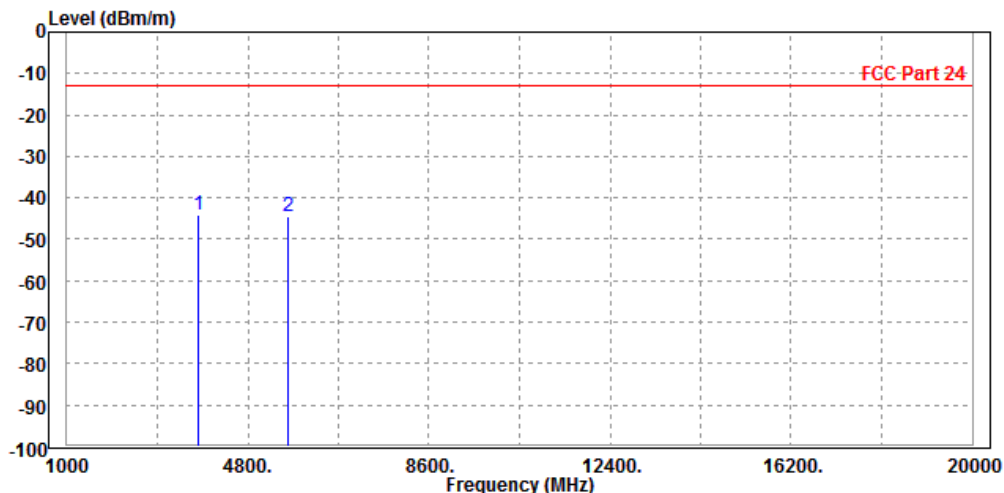



Test Report No.: RF180829W002-5

CH 810

MODE	TX channel 810	FREQUENCY RANGE	Above 1000MHz
ENVIRONMENTAL CONDITIONS	23deg. C, 70%RH	INPUT POWER	DC 5V from adapter
TESTED BY	Rose Ma		
ANTENNA POLARITY & TEST DISTANCE: HORIZONTAL AT 3 M			

	Freq	Level	Read Level	Limit Line	Over Limit	Factor	Remark	Pol/Phase
	MHz	dBm/m	dBm	dBm/m	dB	dB/m		
1	PP 3812.000	-38.59	-42.25	-13.00	-25.59	3.66	Peak	Horizontal
2	5731.000	-42.66	-51.88	-13.00	-29.66	9.22	Peak	Horizontal

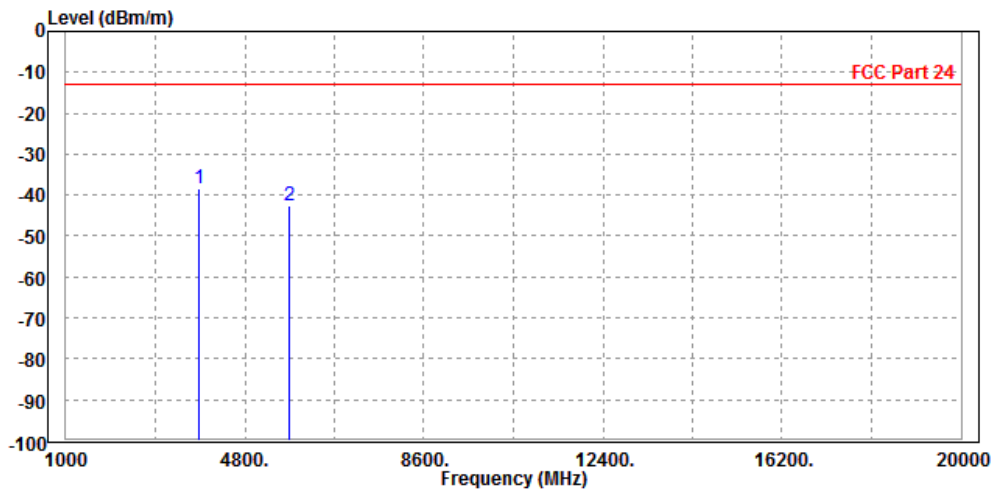



Test Report No.: RF180829W002-5

MODE	TX channel 810	FREQUENCY RANGE	Above 1000MHz
ENVIRONMENTAL CONDITIONS	23deg. C, 70%RH	INPUT POWER	DC 5V from adapter
TESTED BY	Rose Ma		
ANTENNA POLARITY & TEST DISTANCE: VERTICAL AT 3 M			

	Freq	Level	Read Level	Limit Line	Over Limit	Factor	Remark	Pol/Phase
	MHz	dBm/m	dBm	dBm/m	dB	dB/m		
1	PP 3812.000	-36.64	-40.78	-13.00	-23.64	4.14	Peak	Vertical
2	5731.000	-40.48	-48.92	-13.00	-27.48	8.44	Peak	Vertical

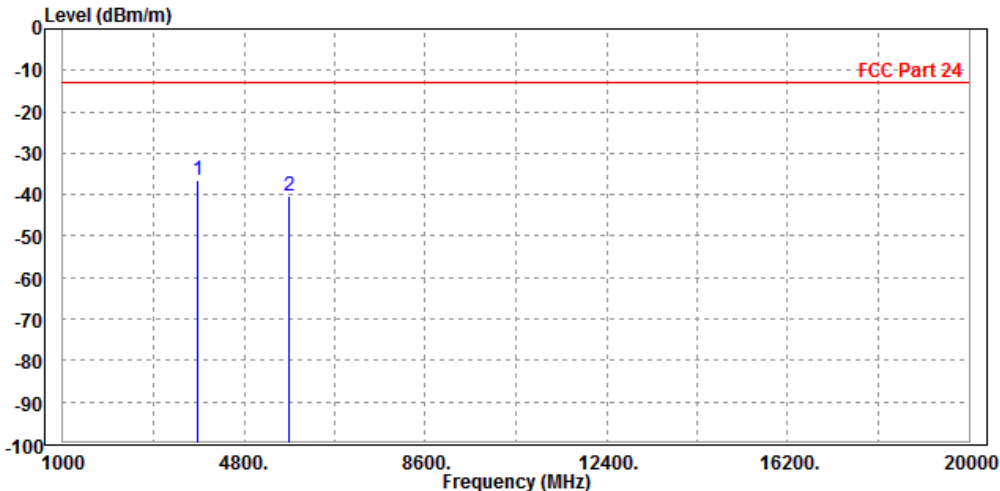



Test Report No.: RF180829W002-5

EDGE 1900:

CH 512

MODE	TX channel 512	FREQUENCY RANGE	Above 1000MHz
ENVIRONMENTAL CONDITIONS	23deg. C, 70%RH	INPUT POWER	DC 5V from adapter
TESTED BY	Rose Ma		
ANTENNA POLARITY & TEST DISTANCE: HORIZONTAL AT 3 M			

	Freq	Level	Read Level	Limit Line	Over Limit	Factor	Remark	Pol/Phase
	MHz	dBm/m	dBm	dBm/m	dB	dB/m		
1	PP 3698.000	-47.35	-50.46	-13.00	-34.35	3.11	Peak	Horizontal
2	5550.600	-48.25	-57.27	-13.00	-35.25	9.02	Peak	Horizontal

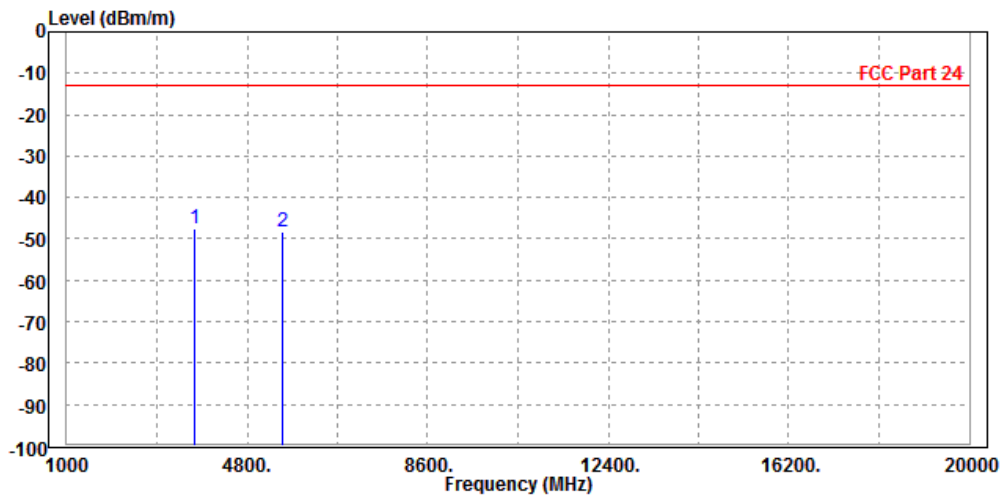



Test Report No.: RF180829W002-5

MODE	TX channel 512	FREQUENCY RANGE	Above 1000MHz
ENVIRONMENTAL CONDITIONS	23deg. C, 70%RH	INPUT POWER	DC 5V from adapter
TESTED BY	Rose Ma		
ANTENNA POLARITY & TEST DISTANCE: VERTICAL AT 3 M			

	Freq	Level	Read Level	Limit Line	Over Limit	Factor	Remark	Pol/Phase
	MHz	dBm/m	dBm	dBm/m	dB	dB/m		
1	PP 3698.000	-47.74	-51.31	-13.00	-34.74	3.57	Peak	Vertical
2	5550.600	-50.12	-58.19	-13.00	-37.12	8.07	Peak	Vertical

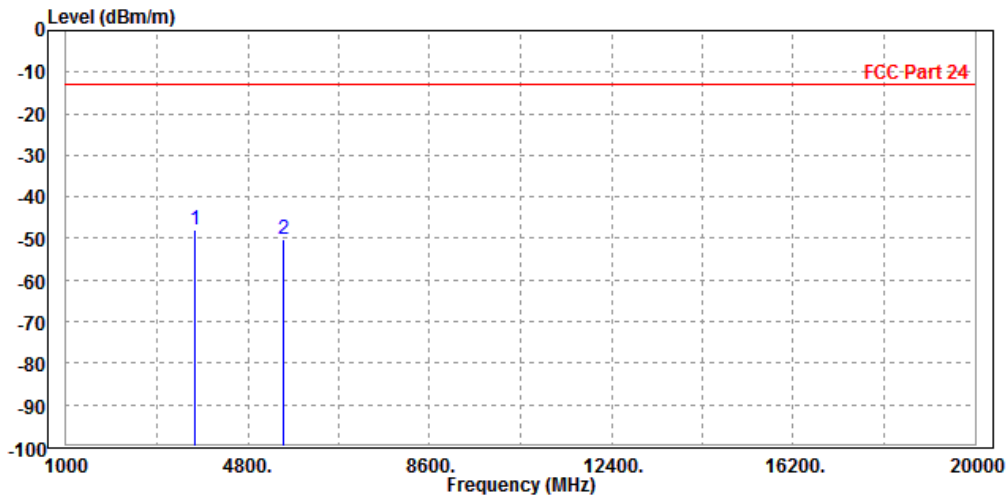



Test Report No.: RF180829W002-5

CH 661

MODE	TX channel 661	FREQUENCY RANGE	Above 1000MHz
ENVIRONMENTAL CONDITIONS	23deg. C, 70%RH	INPUT POWER	DC 5V from adapter
TESTED BY	Rose Ma		
ANTENNA POLARITY & TEST DISTANCE: HORIZONTAL AT 3 M			

	Freq	Level	Read Level	Limit Line	Over Limit	Factor	Remark	Pol/Phase
	MHz	dBm/m	dBm	dBm/m	dB	dB/m		
1	PP 3755.000	-37.16	-40.55	-13.00	-24.16	3.39	Peak	Horizontal
2	5640.000	-44.59	-53.71	-13.00	-31.59	9.12	Peak	Horizontal

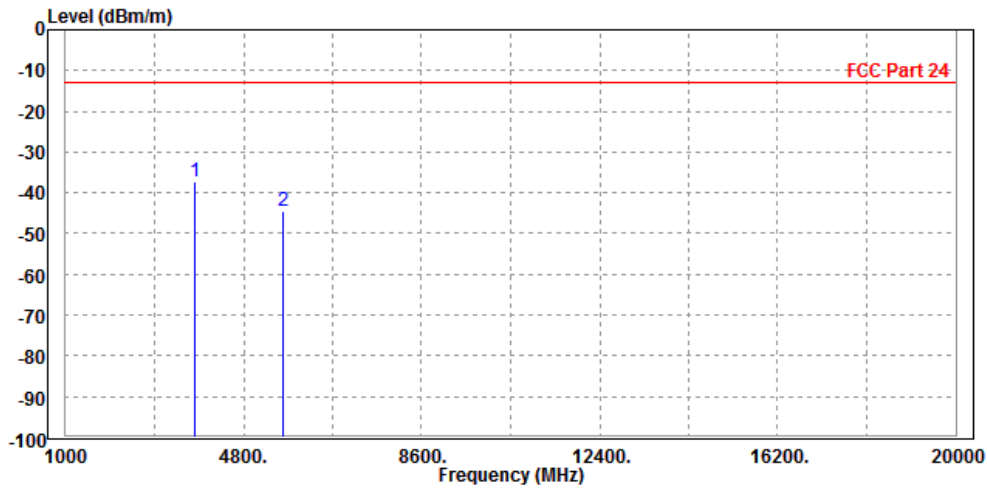



Test Report No.: RF180829W002-5

MODE	TX channel 661	FREQUENCY RANGE	Above 1000MHz
ENVIRONMENTAL CONDITIONS	23deg. C, 70%RH	INPUT POWER	DC 5V from adapter
TESTED BY	Rose Ma		
ANTENNA POLARITY & TEST DISTANCE: VERTICAL AT 3 M			

	Freq	Level	Read Level	Limit Line	Over Limit	Factor	Remark	Pol/Phase
	MHz	dBm/m	dBm	dBm/m	dB	dB/m		
1	3755.000	-45.63	-49.48	-13.00	-32.63	3.85	Peak	Vertical
2 PP	5640.000	-40.40	-48.66	-13.00	-27.40	8.26	Peak	Vertical

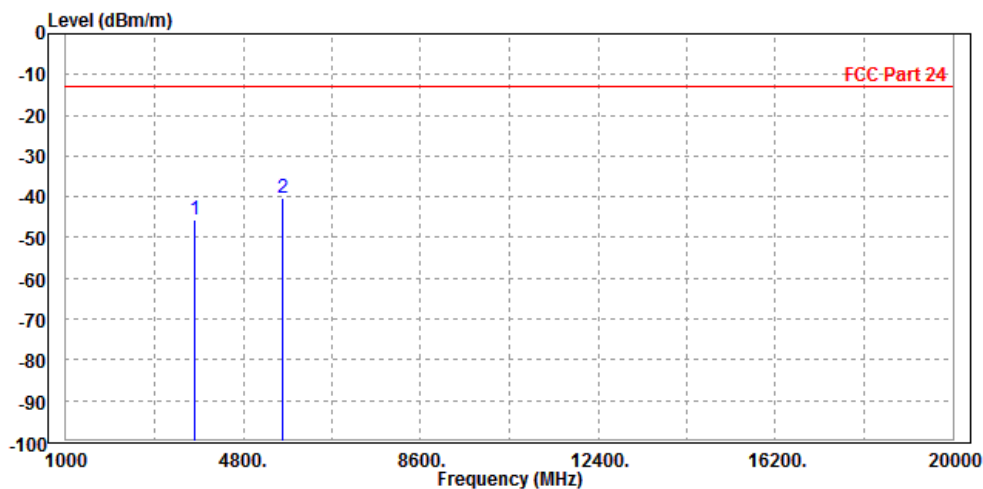



Test Report No.: RF180829W002-5

CH 810

MODE	TX channel 810	FREQUENCY RANGE	Above 1000MHz
ENVIRONMENTAL CONDITIONS	23deg. C, 70%RH	INPUT POWER	DC 5V from adapter
TESTED BY	Rose Ma		
ANTENNA POLARITY & TEST DISTANCE: HORIZONTAL AT 3 M			

	Freq	Level	Read Level	Limit Line	Over Limit	Factor	Remark	Pol/Phase
	MHz	dBm/m	dBm	dBm/m	dB	dB/m		
1	PP 3812.000	-44.95	-48.61	-13.00	-31.95	3.66	Peak	Horizontal
2	5729.400	-47.30	-56.52	-13.00	-34.30	9.22	Peak	Horizontal

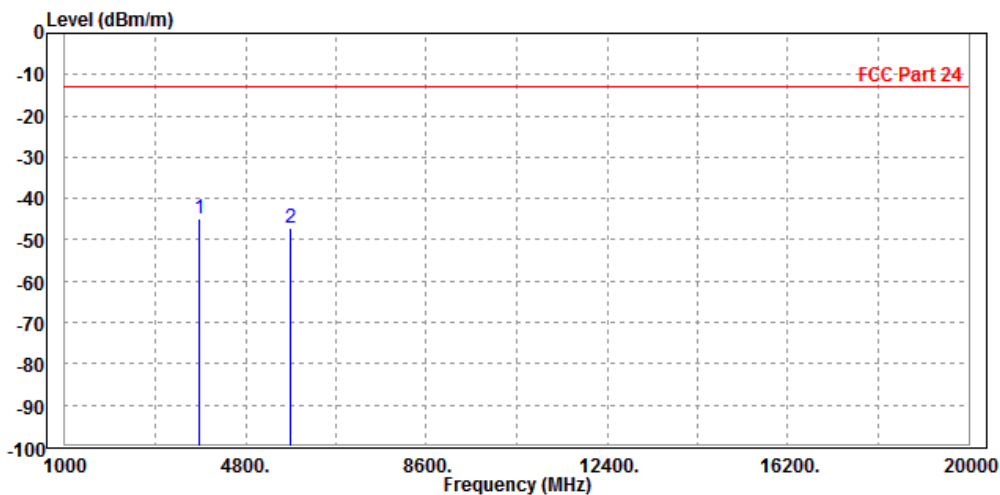



Test Report No.: RF180829W002-5

MODE	TX channel 810	FREQUENCY RANGE	Above 1000MHz
ENVIRONMENTAL CONDITIONS	23deg. C, 70%RH	INPUT POWER	DC 5V from adapter
TESTED BY	Rose Ma		
ANTENNA POLARITY & TEST DISTANCE: VERTICAL AT 3 M			

	Freq	Level	Read Level	Limit Line	Over Limit	Factor	Remark	Pol/Phase
	MHz	dBm/m	dBm	dBm/m	dB	dB/m		
1	PP 3812.000	-44.54	-48.68	-13.00	-31.54	4.14	Peak	Vertical
2	5729.400	-47.35	-55.79	-13.00	-34.35	8.44	Peak	Vertical

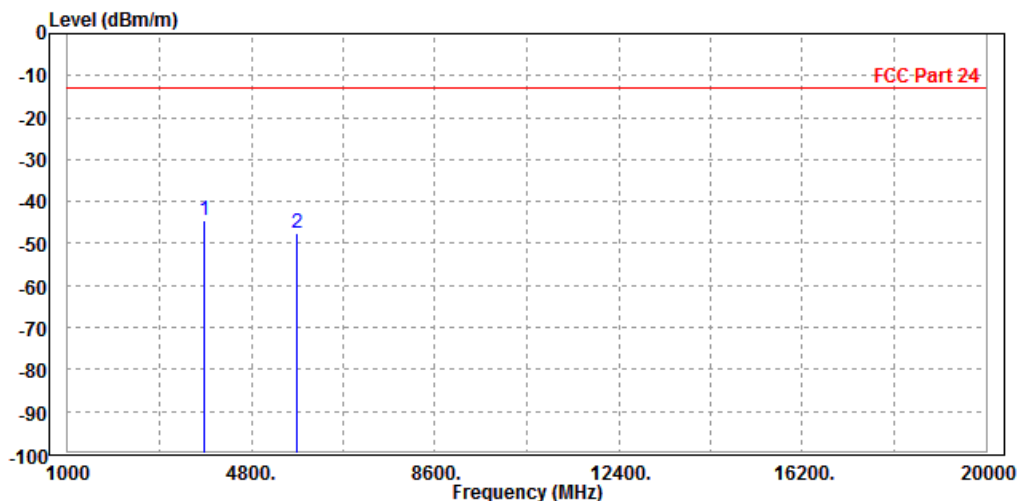



Test Report No.: RF180829W002-5

WCDMA Band II

CH 9262

MODE	TX channel 9262	FREQUENCY RANGE	Above 1000MHz
ENVIRONMENTAL CONDITIONS	23deg. C, 70%RH	INPUT POWER	DC 5V from adapter
TESTED BY	Rose Ma		
ANTENNA POLARITY & TEST DISTANCE: HORIZONTAL AT 3 M			

	Freq	Level	Read Level	Limit Line	Over Limit	Factor	Remark	Pol/Phase
	MHz	dBm/m	dBm	dBm/m	dB	dB/m		
1	3698.000	-53.15	-56.26	-13.00	-40.15	3.11	Peak	Horizontal
2	PP 5557.200	-48.85	-57.88	-13.00	-35.85	9.03	Peak	Horizontal

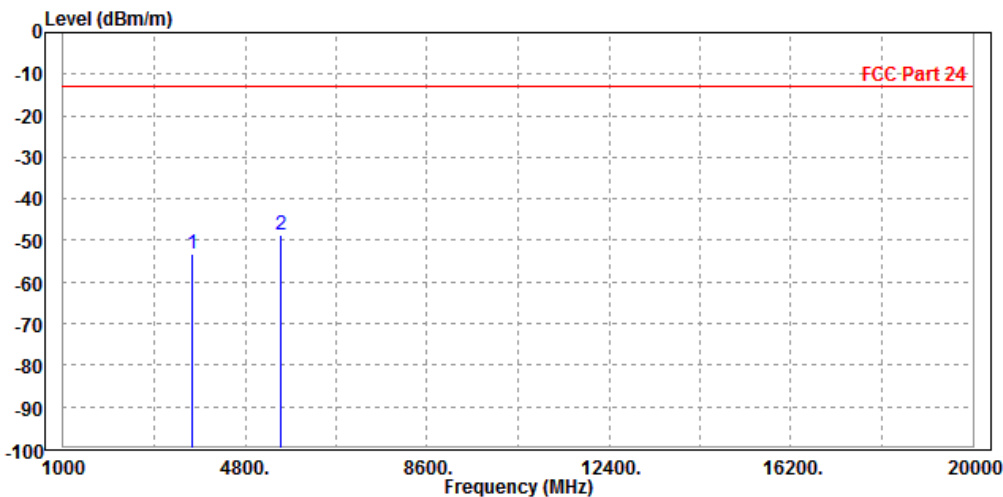



Test Report No.: RF180829W002-5

MODE	TX channel 9262	FREQUENCY RANGE	Above 1000MHz
ENVIRONMENTAL CONDITIONS	23deg. C, 70%RH	INPUT POWER	DC 5V from adapter
TESTED BY	Rose Ma		
ANTENNA POLARITY & TEST DISTANCE: VERTICAL AT 3 M			

	Freq	Level	Read Level	Limit Line	Over Limit	Factor	Remark	Pol/Phase
	MHz	dBm/m	dBm	dBm/m	dB	dB/m		
1	3698.000	-51.54	-55.11	-13.00	-38.54	3.57	Peak	Vertical
2 PP	5557.200	-49.66	-57.75	-13.00	-36.66	8.09	Peak	Vertical

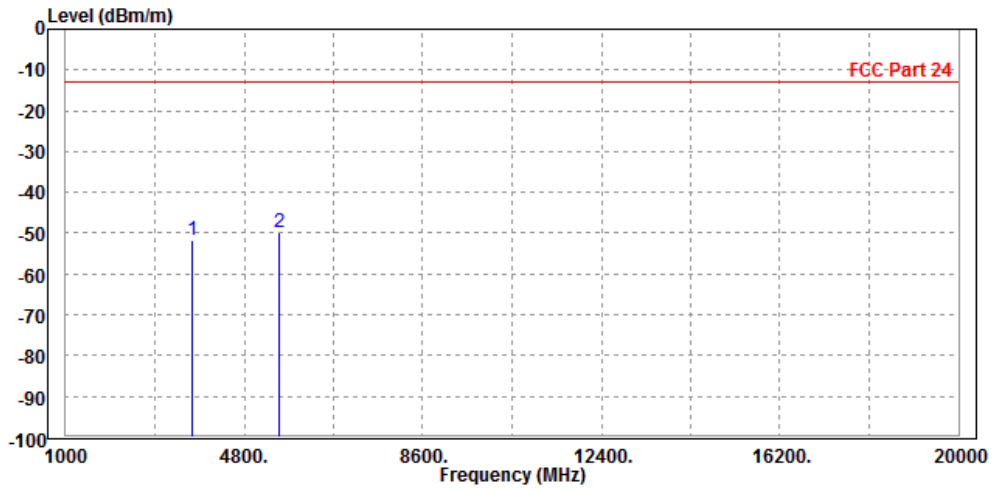



Test Report No.: RF180829W002-5

CH 9400

MODE	TX channel 9400	FREQUENCY RANGE	Above 1000MHz
ENVIRONMENTAL CONDITIONS	23deg. C, 70%RH	INPUT POWER	DC 5V from adapter
TESTED BY	Rose Ma		
ANTENNA POLARITY & TEST DISTANCE: HORIZONTAL AT 3 M			

	Freq	Level	Read Level	Limit Line	Over Limit	Factor	Remark	Pol/Phase
	MHz	dBm/m	dBm	dBm/m	dB	dB/m		
1	3755.000	-52.00	-55.39	-13.00	-39.00	3.39	Peak	Horizontal
2 PP	5640.000	-47.11	-56.23	-13.00	-34.11	9.12	Peak	Horizontal

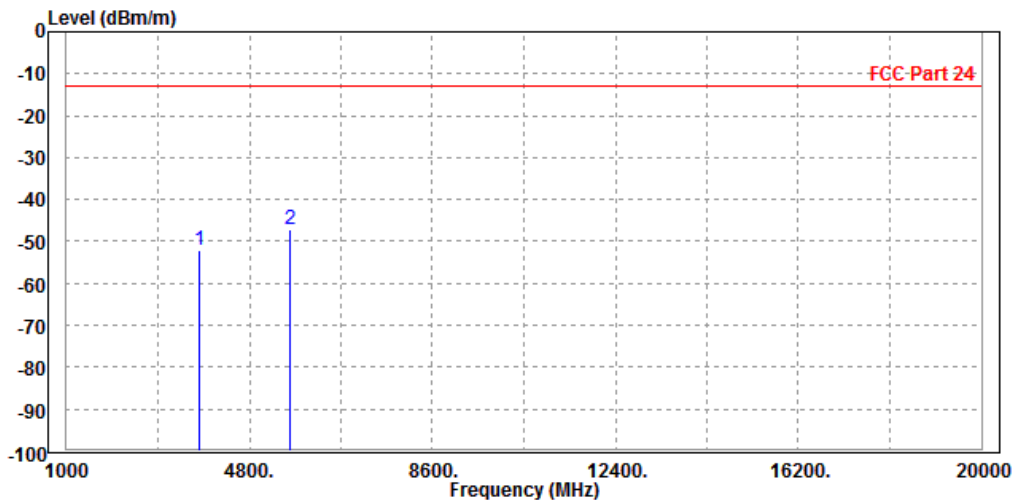



Test Report No.: RF180829W002-5

MODE	TX channel 9400	FREQUENCY RANGE	Above 1000MHz
ENVIRONMENTAL CONDITIONS	23deg. C, 70%RH	INPUT POWER	DC 5V from adapter
TESTED BY	Rose Ma		
ANTENNA POLARITY & TEST DISTANCE: VERTICAL AT 3 M			

	Freq	Level	Read Level	Limit Line	Over Limit	Factor	Remark	Pol/Phase
	MHz	dBm/m	dBm	dBm/m	dB	dB/m		
1	3755.000	-53.19	-57.04	-13.00	-40.19	3.85	Peak	Vertical
2 PP	5640.000	-48.56	-56.82	-13.00	-35.56	8.26	Peak	Vertical

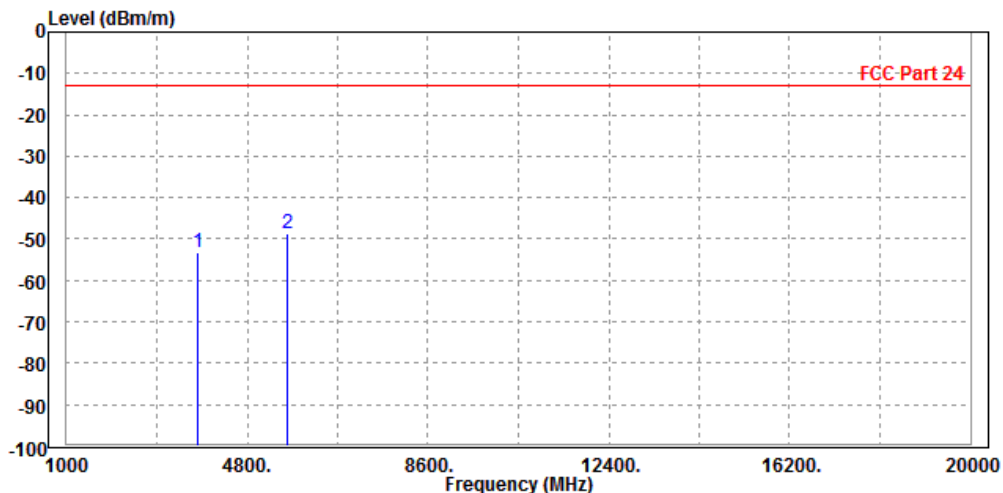



Test Report No.: RF180829W002-5

CH 9538

MODE	TX channel 9538	FREQUENCY RANGE	Above 1000MHz
ENVIRONMENTAL CONDITIONS	23deg. C, 70%RH	INPUT POWER	DC 5V from adapter
TESTED BY	Rose Ma		
ANTENNA POLARITY & TEST DISTANCE: HORIZONTAL AT 3 M			

	Freq	Level	Read Level	Limit Line	Over Limit	Factor	Remark	Pol/Phase
	MHz	dBm/m	dBm	dBm/m	dB	dB/m		
1	3812.000	-46.65	-50.31	-13.00	-33.65	3.66	Peak	Horizontal
2 PP	5722.800	-37.47	-46.69	-13.00	-24.47	9.22	Peak	Horizontal

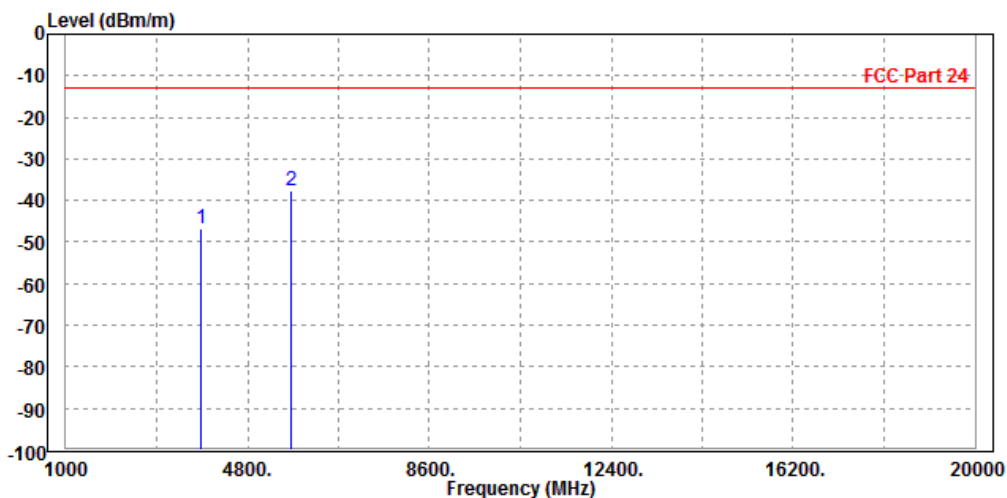



Test Report No.: RF180829W002-5

MODE	TX channel 9538	FREQUENCY RANGE	Above 1000MHz
ENVIRONMENTAL CONDITIONS	23deg. C, 70%RH	INPUT POWER	DC 5V from adapter
TESTED BY	Rose Ma		
ANTENNA POLARITY & TEST DISTANCE: VERTICAL AT 3 M			

	Freq	Level	Read Level	Limit Line	Over Limit	Factor	Remark	Pol/Phase
	MHz	dBm/m	dBm	dBm/m	dB	dB/m		
1	3812.000	-44.45	-48.59	-13.00	-31.45	4.14	Peak	Vertical
2 PP	5722.800	-36.89	-45.31	-13.00	-23.89	8.42	Peak	Vertical

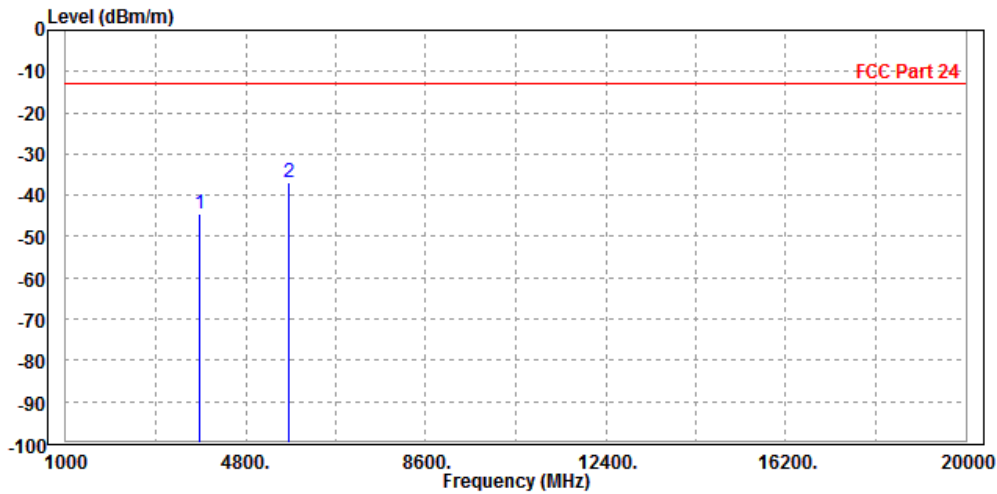



Test Report No.: RF180829W002-5

CDMA BC1

CH 25

MODE	TX channel 25	FREQUENCY RANGE	Above 1000MHz
ENVIRONMENTAL CONDITIONS	23deg. C, 70%RH	INPUT POWER	DC 5V from adapter
TESTED BY	Rose Ma		
ANTENNA POLARITY & TEST DISTANCE: HORIZONTAL AT 3 M			

	Freq	Level	Read Level	Limit Line	Over Limit	Factor	Remark	Pol/Phase
	MHz	dBm/m	dBm	dBm/m	dB	dB/m		
1	3698.000	-40.28	-43.39	-13.00	-27.28	3.11	Peak	Horizontal
2 PP	5553.000	-34.36	-43.38	-13.00	-21.36	9.02	Peak	Horizontal

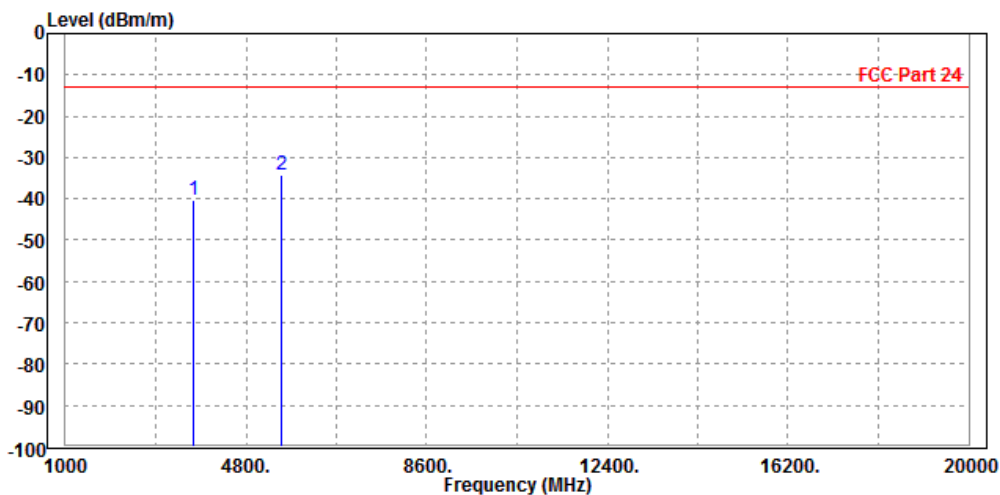



Test Report No.: RF180829W002-5

MODE	TX channel 25	FREQUENCY RANGE	Above 1000MHz
ENVIRONMENTAL CONDITIONS	23deg. C, 70%RH	INPUT POWER	DC 5V from adapter
TESTED BY	Rose Ma		
ANTENNA POLARITY & TEST DISTANCE: VERTICAL AT 3 M			

	Freq	Level	Read Level	Limit Line	Over Limit	Factor	Remark	Pol/Phase
	MHz	dBm/m	dBm	dBm/m	dB	dB/m		
1	3698.000	-40.21	-43.78	-13.00	-27.21	3.57	Peak	Vertical
2 PP	5553.000	-33.37	-41.45	-13.00	-20.37	8.08	Peak	Vertical

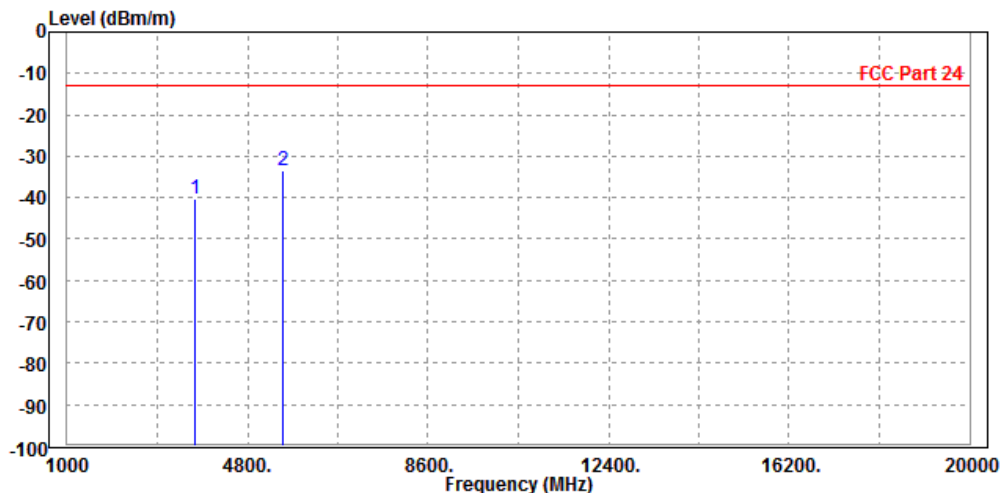



Test Report No.: RF180829W002-5

CH 600

MODE	TX channel 600	FREQUENCY RANGE	Above 1000MHz
ENVIRONMENTAL CONDITIONS	23deg. C, 70%RH	INPUT POWER	DC 5V from adapter
TESTED BY	Rose Ma		
ANTENNA POLARITY & TEST DISTANCE: HORIZONTAL AT 3 M			

	Freq	Level	Read Level	Limit Line	Over Limit	Factor	Remark	Pol/Phase
	MHz	dBm/m	dBm	dBm/m	dB	dB/m		
1	3755.000	-42.06	-45.45	-13.00	-29.06	3.39	Peak	Horizontal
2 PP	5640.000	-35.19	-44.31	-13.00	-22.19	9.12	Peak	Horizontal

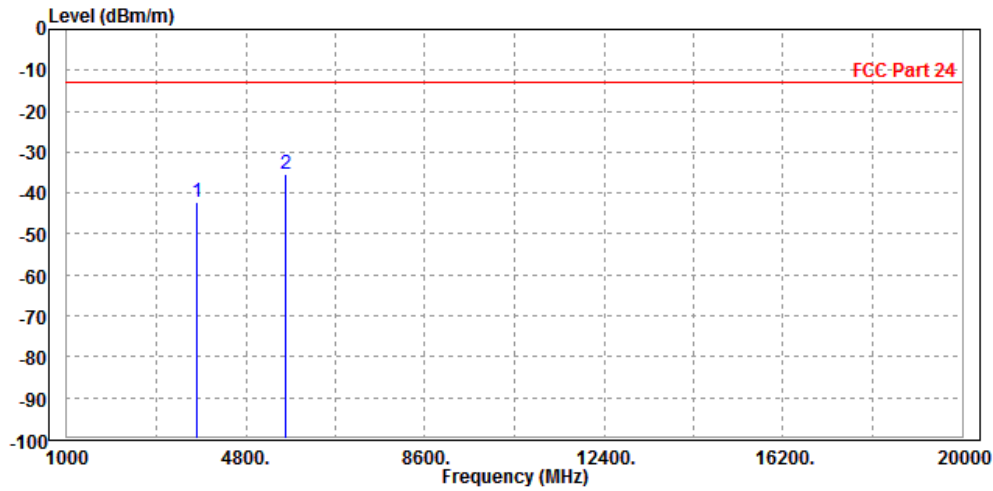



Test Report No.: RF180829W002-5

MODE	TX channel 600	FREQUENCY RANGE	Above 1000MHz
ENVIRONMENTAL CONDITIONS	23deg. C, 70%RH	INPUT POWER	DC 5V from adapter
TESTED BY	Rose Ma		
ANTENNA POLARITY & TEST DISTANCE: VERTICAL AT 3 M			

	Freq	Level	Read Level	Limit Line	Over Limit	Factor	Remark	Pol/Phase
	MHz	dBm/m	dBm	dBm/m	dB	dB/m		
1	3755.000	-39.57	-43.42	-13.00	-26.57	3.85	Peak	Vertical
2 PP	5640.000	-34.97	-43.23	-13.00	-21.97	8.26	Peak	Vertical

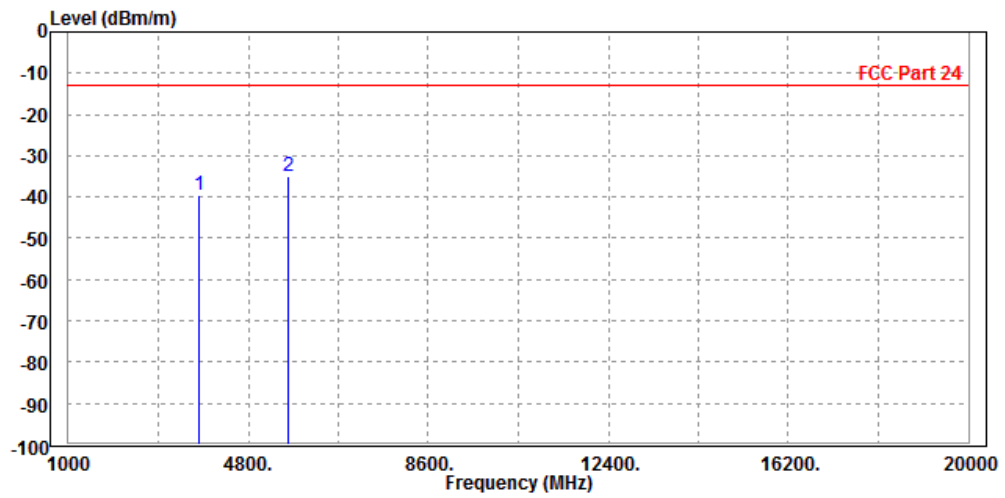



Test Report No.: RF180829W002-5

CH 1175

MODE	TX channel 1175	FREQUENCY RANGE	Above 1000MHz
ENVIRONMENTAL CONDITIONS	23deg. C, 70%RH	INPUT POWER	DC 5V from adapter
TESTED BY	Rose Ma		
ANTENNA POLARITY & TEST DISTANCE: HORIZONTAL AT 3 M			

	Freq	Level	Read Level	Limit Line	Over Limit	Factor	Remark	Pol/Phase
	MHz	dBm/m	dBm	dBm/m	dB	dB/m		
1	3698.000	-40.28	-43.39	-13.00	-27.28	3.11	Peak	Horizontal
2 PP	5553.000	-34.36	-43.38	-13.00	-21.36	9.02	Peak	Horizontal

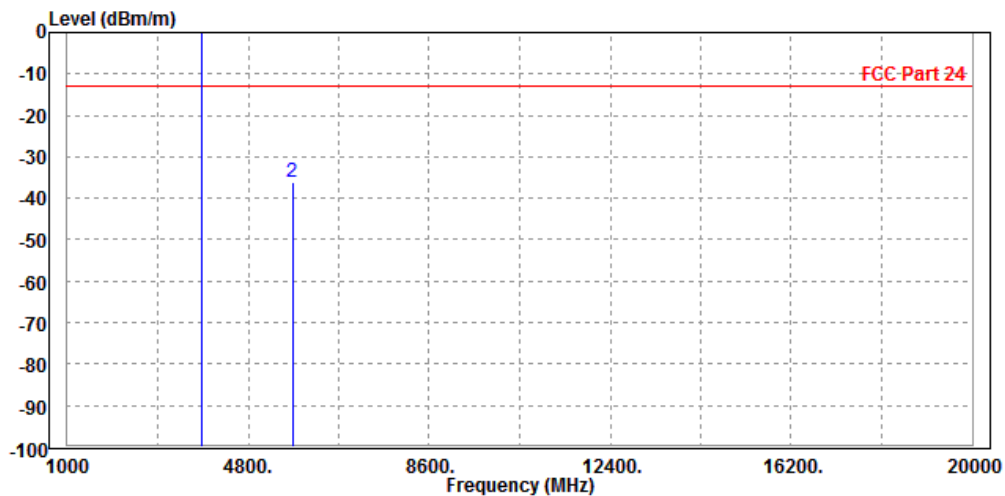



Test Report No.: RF180829W002-5

MODE	TX channel 1175	FREQUENCY RANGE	Above 1000MHz
ENVIRONMENTAL CONDITIONS	23deg. C, 70%RH	INPUT POWER	DC 5V from adapter
TESTED BY	Rose Ma		
ANTENNA POLARITY & TEST DISTANCE: VERTICAL AT 3 M			

	Freq	Level	Read Level	Limit Line	Over Limit	Factor	Remark	Pol/Phase
	MHz	dBm/m	dBm	dBm/m	dB	dB/m		
1	3817.000	-40.34	-44.51	-13.00	-27.34	4.17	Peak	Vertical
2 PP	5731.000	-34.32	-42.76	-13.00	-21.32	8.44	Peak	Vertical

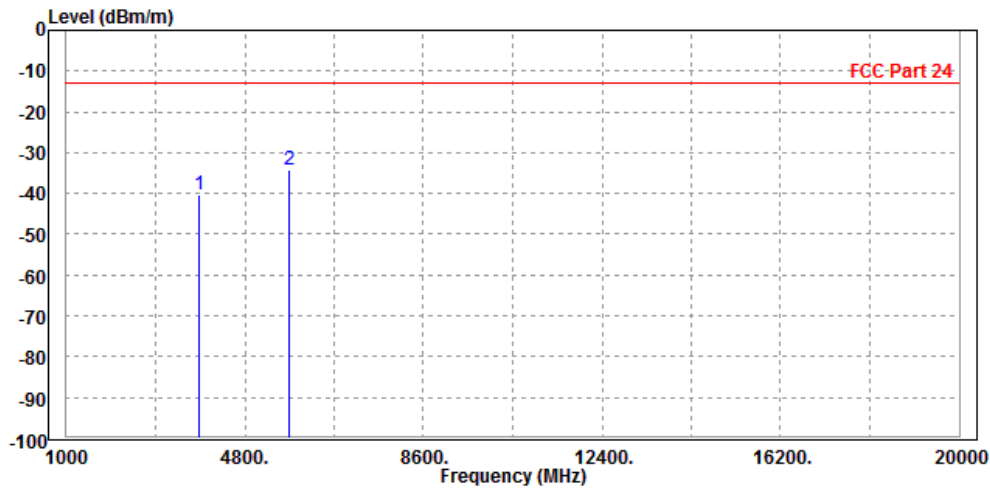



Test Report No.: RF180829W002-5

LTE Band 2

CHANNEL BANDWIDTH: 1.4MHz / QPSK

MODE	TX channel 18900	FREQUENCY RANGE	Above 1000MHz
ENVIRONMENTAL CONDITIONS	23deg. C, 70%RH	INPUT POWER	DC 5V from adapter
TESTED BY	Rose Ma		
ANTENNA POLARITY & TEST DISTANCE: HORIZONTAL AT 3 M			

	Freq	Level	Read Level	Limit Line	Over Limit	Factor	Remark	Pol/Phase
	MHz	dBm/m	dBm	dBm/m	dB	dB/m		
1	3755.000	-46.16	-49.55	-13.00	-33.16	3.39	Peak	Horizontal
2 PP	5640.000	-35.57	-44.69	-13.00	-22.57	9.12	Peak	Horizontal

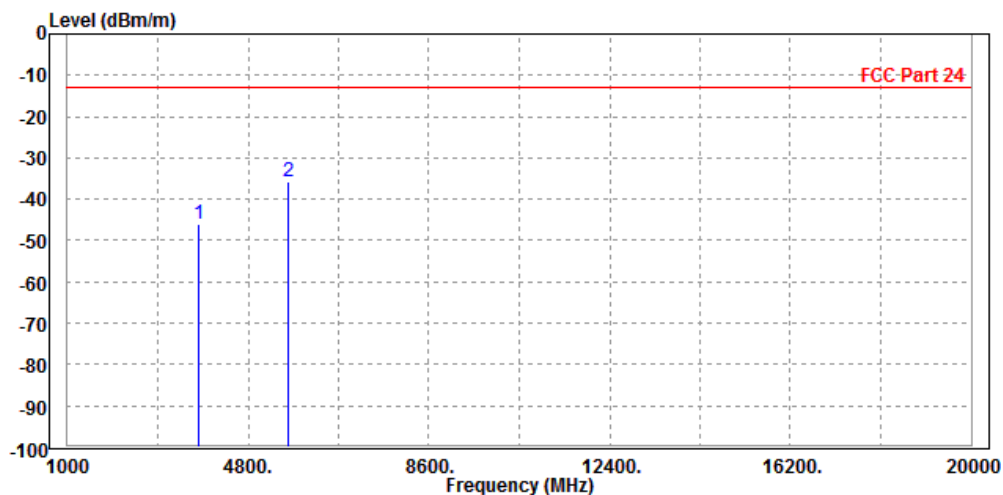



Test Report No.: RF180829W002-5

MODE	TX channel 18900	FREQUENCY RANGE	Above 1000MHz
ENVIRONMENTAL CONDITIONS	23deg. C, 70%RH	INPUT POWER	DC 5V from adapter
TESTED BY	Rose Ma		
ANTENNA POLARITY & TEST DISTANCE: VERTICAL AT 3 M			

	Freq	Level	Read Level	Limit Line	Over Limit	Factor	Remark	Pol/Phase
	MHz	dBm/m	dBm	dBm/m	dB	dB/m		
1	3755.000	-45.00	-48.85	-13.00	-32.00	3.85	Peak	Vertical
2 PP	5640.000	-40.92	-49.18	-13.00	-27.92	8.26	Peak	Vertical

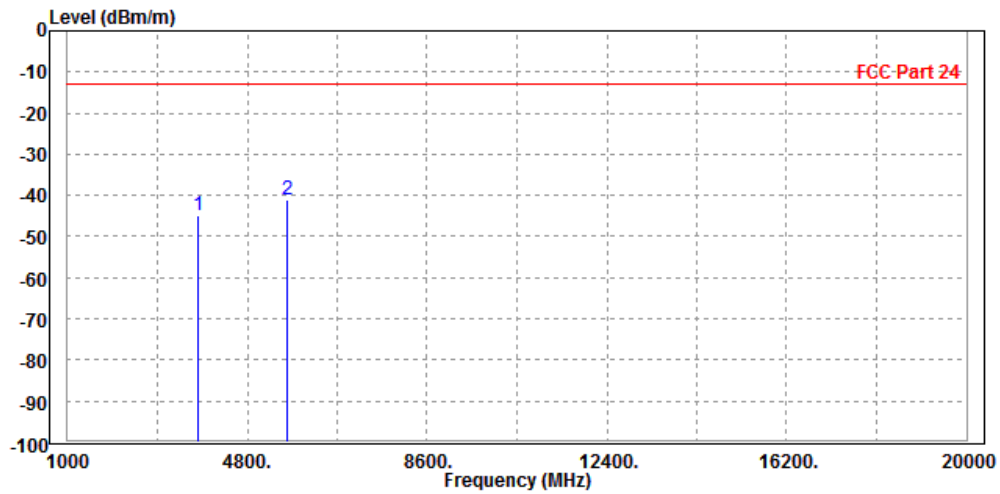



Test Report No.: RF180829W002-5

CHANNEL BANDWIDTH: 3MHz / QPSK

MODE	TX channel 18900	FREQUENCY RANGE	Above 1000MHz
ENVIRONMENTAL CONDITIONS	23deg. C, 70%RH	INPUT POWER	DC 5V from adapter
TESTED BY	Rose Ma		
ANTENNA POLARITY & TEST DISTANCE: HORIZONTAL AT 3 M			

	Freq	Level	Read Level	Limit Line	Over Limit	Factor	Remark	Pol/Phase
	MHz	dBm/m	dBm	dBm/m	dB	dB/m		
1	3755.000	-49.29	-52.68	-13.00	-36.29	3.39	Peak	Horizontal
2 PP	5640.000	-38.50	-47.62	-13.00	-25.50	9.12	Peak	Horizontal

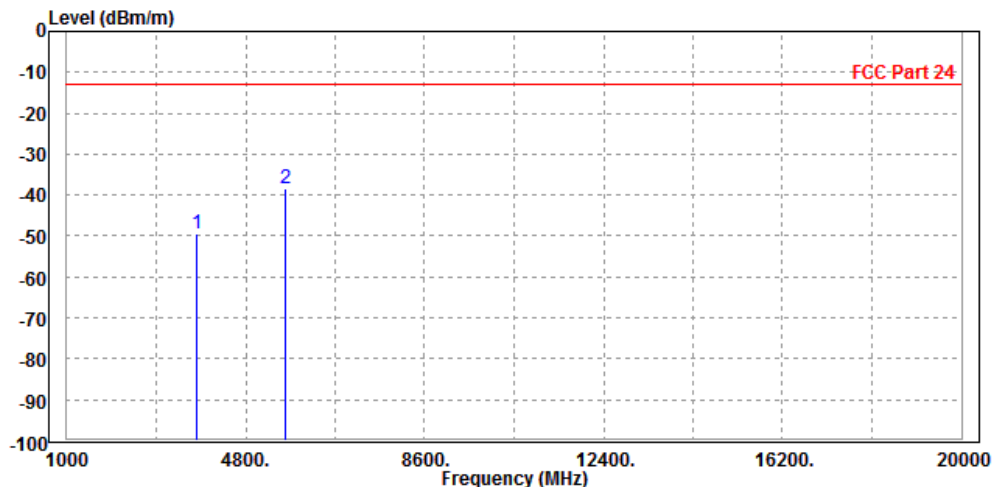



Test Report No.: RF180829W002-5

MODE	TX channel 18900	FREQUENCY RANGE	Above 1000MHz
ENVIRONMENTAL CONDITIONS	23deg. C, 70%RH	INPUT POWER	DC 5V from adapter
TESTED BY	Rose Ma		
ANTENNA POLARITY & TEST DISTANCE: VERTICAL AT 3 M			

	Freq	Read Level	Limit Level	Over Limit	Factor	Remark	Pol/Phase
	MHz	dBm/m	dBm	dBm/m	dB	dB/m	
1	3755.000	-45.95	-49.80	-13.00	-32.95	3.85 Peak	Vertical
2 PP	5640.000	-42.89	-51.15	-13.00	-29.89	8.26 Peak	Vertical

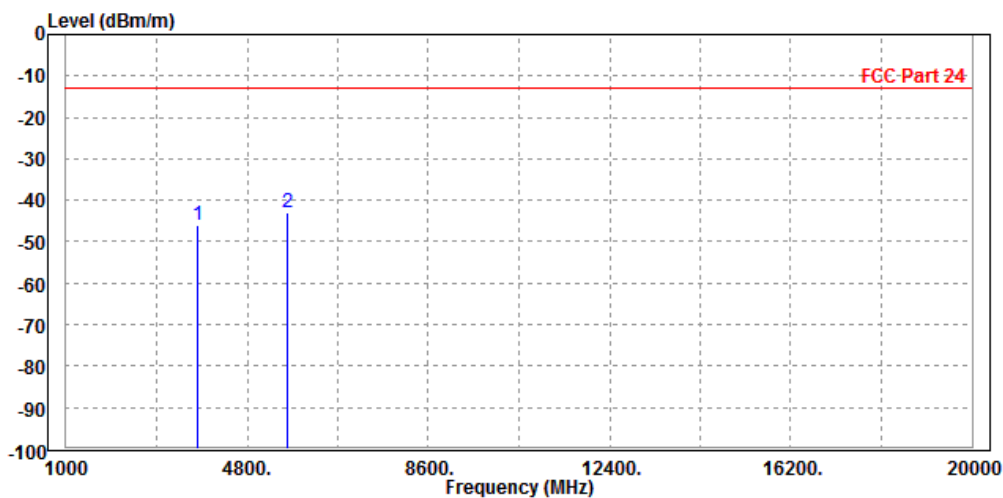



Test Report No.: RF180829W002-5

CHANNEL BANDWIDTH: 5MHz / QPSK

MODE	TX channel 18900	FREQUENCY RANGE	Above 1000MHz
ENVIRONMENTAL CONDITIONS	23deg. C, 70%RH	INPUT POWER	DC 5V from adapter
TESTED BY	Rose Ma		
ANTENNA POLARITY & TEST DISTANCE: HORIZONTAL AT 3 M			

	Freq	Level	Read Level	Limit Line	Over Limit	Factor	Remark	Pol/Phase
	MHz	dBm/m	dBm	dBm/m	dB	dB/m		
1	3755.000	-47.70	-51.09	-13.00	-34.70	3.39	Peak	Horizontal
2 PP	5640.000	-38.86	-47.98	-13.00	-25.86	9.12	Peak	Horizontal

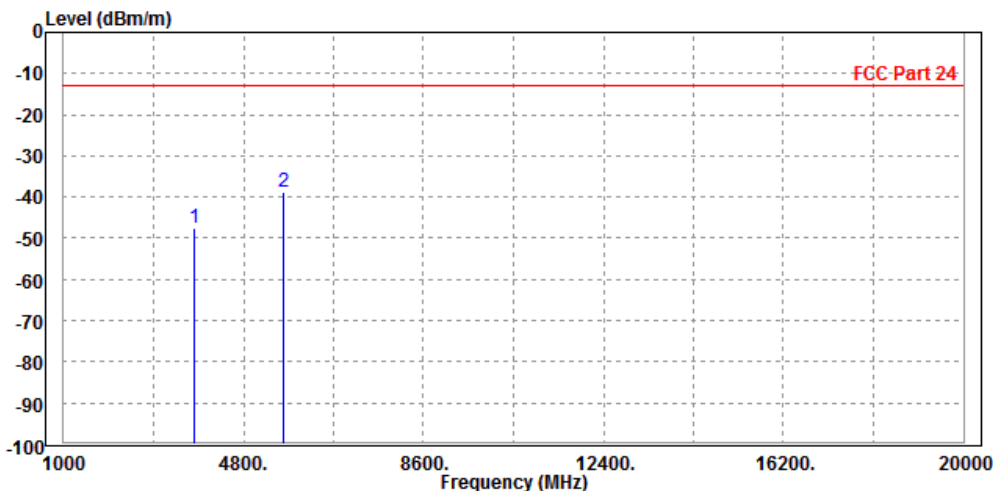



Test Report No.: RF180829W002-5

MODE	TX channel 18900	FREQUENCY RANGE	Above 1000MHz
ENVIRONMENTAL CONDITIONS	23deg. C, 70%RH	INPUT POWER	DC 5V from adapter
TESTED BY	Rose Ma		
ANTENNA POLARITY & TEST DISTANCE: VERTICAL AT 3 M			

	Freq	Level	Read Level	Limit Line	Over Limit	Factor	Remark	Pol/Phase
	MHz	dBm/m	dBm	dBm/m	dB	dB/m		
1	3755.000	-46.49	-50.34	-13.00	-33.49	3.85	Peak	Vertical
2 PP	5640.000	-43.72	-51.98	-13.00	-30.72	8.26	Peak	Vertical

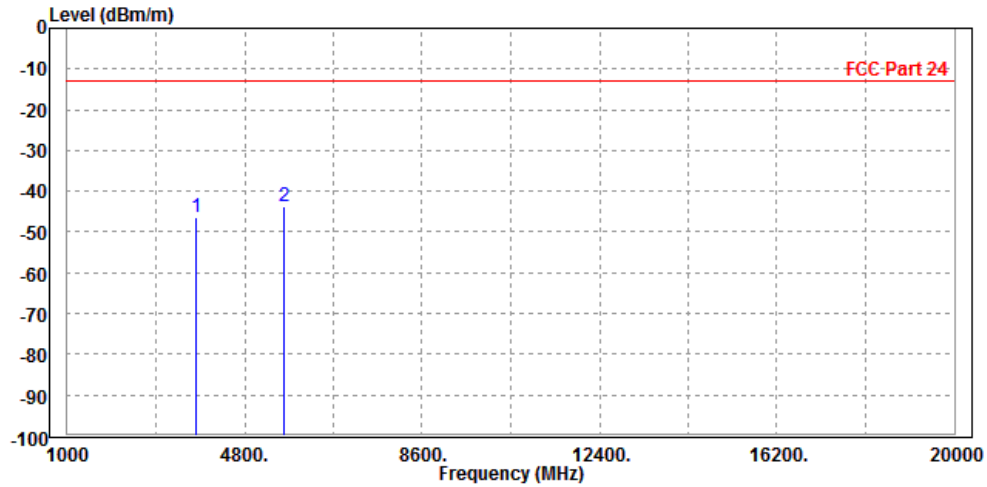



Test Report No.: RF180829W002-5

CHANNEL BANDWIDTH: 10MHz / QPSK

CH 18650

MODE	TX channel 18650	FREQUENCY RANGE	Above 1000MHz
ENVIRONMENTAL CONDITIONS	23deg. C, 70%RH	INPUT POWER	DC 5V from adapter
TESTED BY	Rose Ma		
ANTENNA POLARITY & TEST DISTANCE: HORIZONTAL AT 3 M			

	Freq	Level	Read Level	Limit Line	Over Limit	Factor	Remark	Pol/Phase
	MHz	dBm/m	dBm	dBm/m	dB	dB/m		
1	3717.000	-52.67	-55.88	-13.00	-39.67	3.21	Peak	Horizontal
2 PP	5565.000	-38.92	-47.96	-13.00	-25.92	9.04	Peak	Horizontal

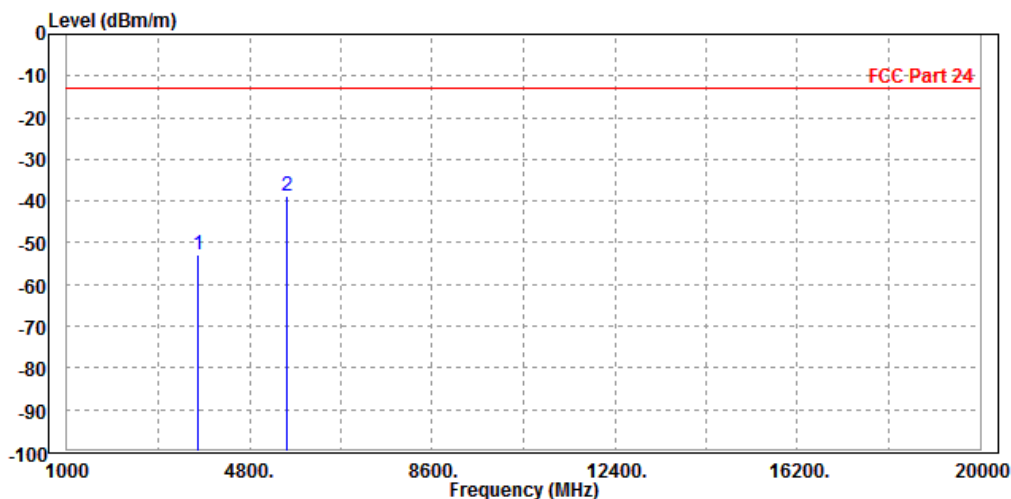



Test Report No.: RF180829W002-5

MODE	TX channel 18650	FREQUENCY RANGE	Above 1000MHz
ENVIRONMENTAL CONDITIONS	23deg. C, 70%RH	INPUT POWER	DC 5V from adapter
TESTED BY	Rose Ma		
ANTENNA POLARITY & TEST DISTANCE: VERTICAL AT 3 M			

	Freq	Level	Read Level	Limit Line	Over Limit	Factor	Remark	Pol/Phase
	MHz	dBm/m	dBm	dBm/m	dB	dB/m		
1	3717.000	-50.80	-54.46	-13.00	-37.80	3.66	Peak	Vertical
2 PP	5565.000	-46.60	-54.70	-13.00	-33.60	8.10	Peak	Vertical

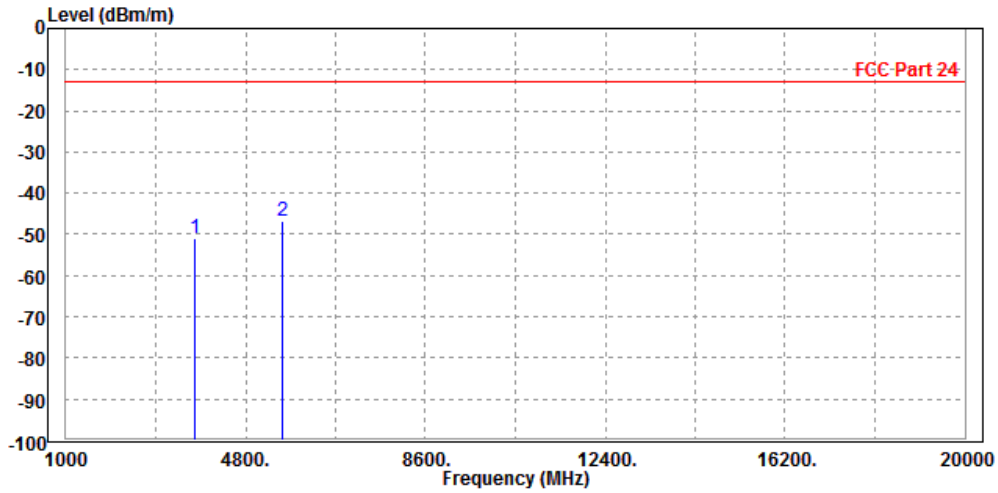



Test Report No.: RF180829W002-5

CH 18900

MODE	TX channel 18900	FREQUENCY RANGE	Above 1000MHz
ENVIRONMENTAL CONDITIONS	23deg. C, 70%RH	INPUT POWER	DC 5V from adapter
TESTED BY	Rose Ma		
ANTENNA POLARITY & TEST DISTANCE: HORIZONTAL AT 3 M			

	Freq	Level	Read Level	Limit Line	Over Limit	Factor	Remark	Pol/Phase
	MHz	dBm/m	dBm	dBm/m	dB	dB/m		
1	3755.000	-37.88	-41.27	-13.00	-24.88	3.39	Peak	Horizontal
2 PP	5640.000	-33.23	-42.35	-13.00	-20.23	9.12	Peak	Horizontal

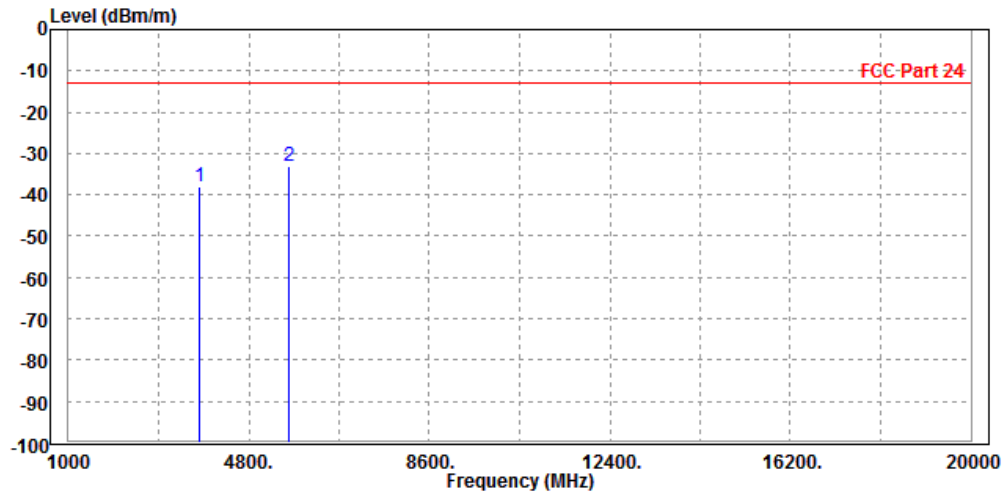



Test Report No.: RF180829W002-5

MODE	TX channel 18900	FREQUENCY RANGE	Above 1000MHz
ENVIRONMENTAL CONDITIONS	23deg. C, 70%RH	INPUT POWER	DC 5V from adapter
TESTED BY	Rose Ma		
ANTENNA POLARITY & TEST DISTANCE: VERTICAL AT 3 M			

	Freq	Level	Read Level	Limit Line	Over Limit	Factor	Remark	Pol/Phase
	MHz	dBm/m	dBm	dBm/m	dB	dB/m		
1	3755.000	-40.94	-44.79	-13.00	-27.94	3.85	Peak	Vertical
2 PP	5640.000	-33.32	-41.58	-13.00	-20.32	8.26	Peak	Vertical

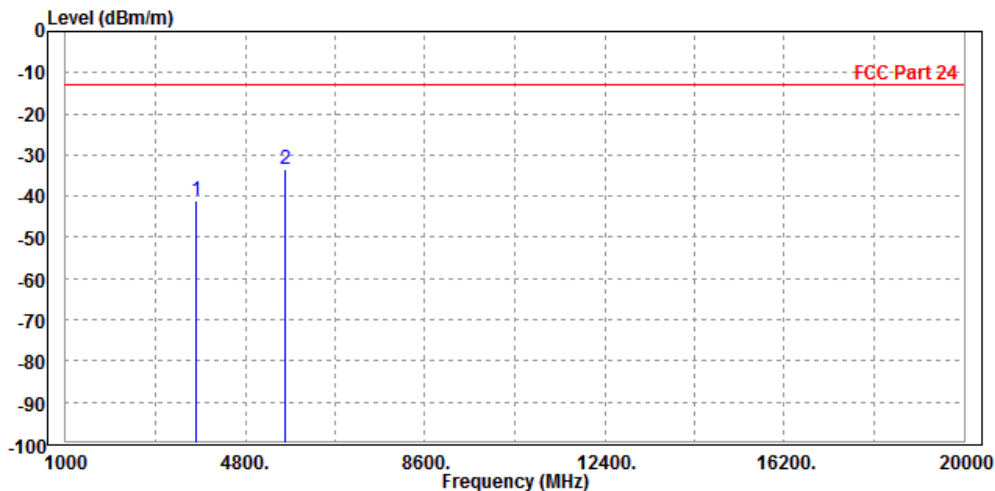



Test Report No.: RF180829W002-5

CH 19150

MODE	TX channel 19150	FREQUENCY RANGE	Above 1000MHz
ENVIRONMENTAL CONDITIONS	23deg. C, 70%RH	INPUT POWER	DC 5V from adapter
TESTED BY	Rose Ma		
ANTENNA POLARITY & TEST DISTANCE: HORIZONTAL AT 3 M			

	Freq	Level	Read Level	Limit Line	Over Limit	Factor	Remark	Pol/Phase
	MHz	dBm/m	dBm	dBm/m	dB	dB/m		
1	3812.000	-45.55	-49.21	-13.00	-32.55	3.66	Peak	Horizontal
2 PP	5715.000	-38.89	-48.10	-13.00	-25.89	9.21	Peak	Horizontal

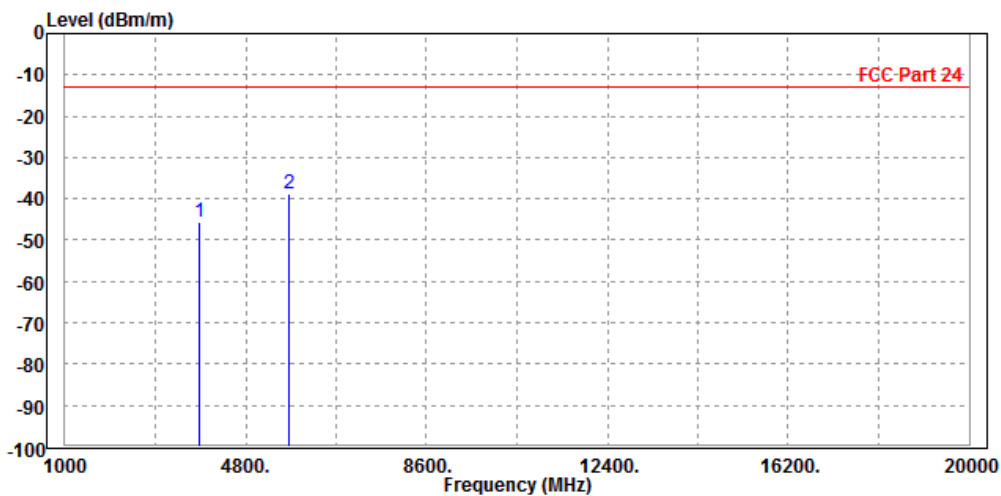



Test Report No.: RF180829W002-5

MODE	TX channel 19150	FREQUENCY RANGE	Above 1000MHz
ENVIRONMENTAL CONDITIONS	23deg. C, 70%RH	INPUT POWER	DC 5V from adapter
TESTED BY	Rose Ma		
ANTENNA POLARITY & TEST DISTANCE: VERTICAL AT 3 M			

	Freq	Level	Read Level	Limit Line	Over Limit	Factor	Remark	Pol/Phase
	MHz	dBm/m	dBm	dBm/m	dB	dB/m		
1	3812.000	-47.34	-51.48	-13.00	-34.34	4.14	Peak	Vertical
2 PP	5715.000	-44.42	-52.83	-13.00	-31.42	8.41	Peak	Vertical

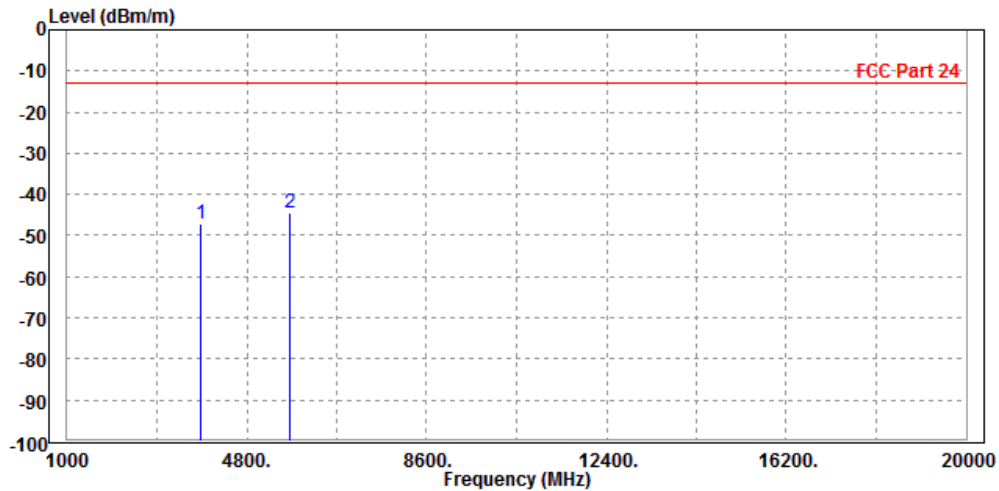



Test Report No.: RF180829W002-5

CHANNEL BANDWIDTH: 15MHz / QPSK

MODE	TX channel 18900	FREQUENCY RANGE	Above 1000MHz
ENVIRONMENTAL CONDITIONS	23deg. C, 70%RH	INPUT POWER	DC 5V from adapter
TESTED BY	Rose Ma		
ANTENNA POLARITY & TEST DISTANCE: HORIZONTAL AT 3 M			

	Freq	Level	Read Level	Limit Line	Over Limit	Factor	Remark	Pol/Phase
	MHz	dBm/m	dBm	dBm/m	dB	dB/m		
1	3755.000	-52.11	-55.50	-13.00	-39.11	3.39	Peak	Horizontal
2 PP	5640.000	-41.21	-50.33	-13.00	-28.21	9.12	Peak	Horizontal

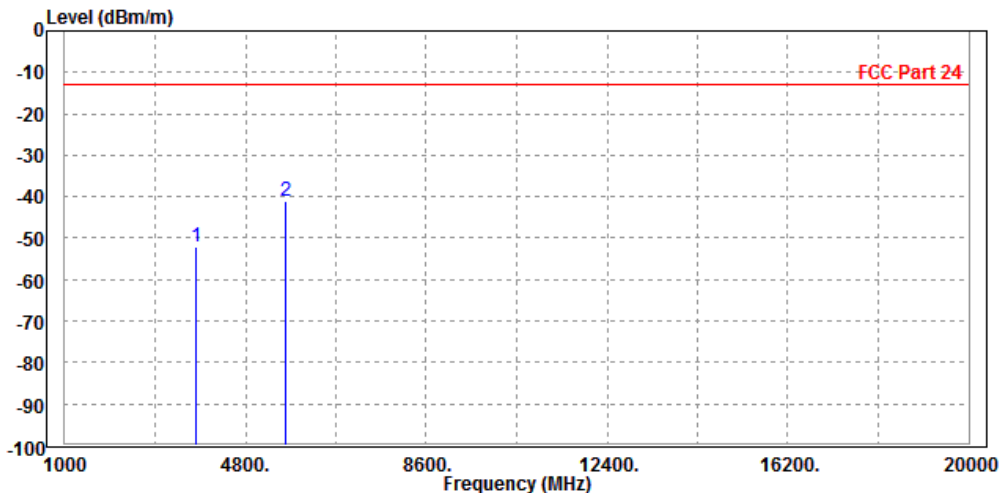



Test Report No.: RF180829W002-5

MODE	TX channel 18900	FREQUENCY RANGE	Above 1000MHz
ENVIRONMENTAL CONDITIONS	23deg. C, 70%RH	INPUT POWER	DC 5V from adapter
TESTED BY	Rose Ma		
ANTENNA POLARITY & TEST DISTANCE: VERTICAL AT 3 M			

	Freq	Level	Read Level	Limit Line	Over Limit	Factor	Remark	Pol/Phase
	MHz	dBm/m	dBm	dBm/m	dB	dB/m		
1	3755.000	-50.17	-54.02	-13.00	-37.17	3.85	Peak	Vertical
2 PP	5640.000	-46.36	-54.62	-13.00	-33.36	8.26	Peak	Vertical

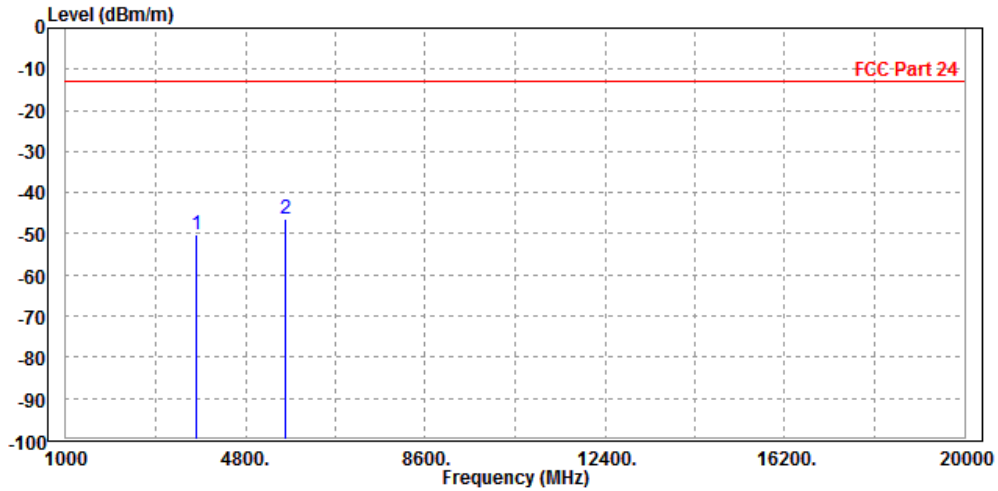



Test Report No.: RF180829W002-5

CHANNEL BANDWIDTH: 20MHz / QPSK

MODE	TX channel 18900	FREQUENCY RANGE	Above 1000MHz
ENVIRONMENTAL CONDITIONS	23deg. C, 70%RH	INPUT POWER	DC 5V from adapter
TESTED BY	Rose Ma		
ANTENNA POLARITY & TEST DISTANCE: HORIZONTAL AT 3 M			

	Freq	Level	Read Level	Limit Line	Over Limit	Factor	Remark	Pol/Phase
	MHz	dBm/m	dBm	dBm/m	dB	dB/m		
1	3755.000	-52.04	-55.43	-13.00	-39.04	3.39	Peak	Horizontal
2 PP	5640.000	-42.61	-51.73	-13.00	-29.61	9.12	Peak	Horizontal

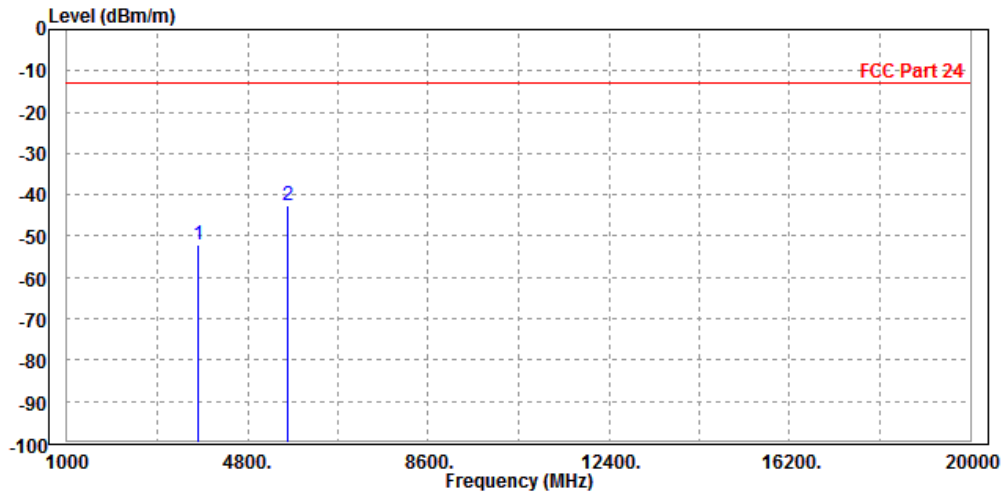



Test Report No.: RF180829W002-5

MODE	TX channel 18900	FREQUENCY RANGE	Above 1000MHz
ENVIRONMENTAL CONDITIONS	23deg. C, 70%RH	INPUT POWER	DC 5V from adapter
TESTED BY	Rose Ma		
ANTENNA POLARITY & TEST DISTANCE: VERTICAL AT 3 M			

	Freq	Level	Read Level	Limit Line	Over Limit	Factor	Remark	Pol/Phase
	MHz	dBm/m	dBm	dBm/m	dB	dB/m		
1	3755.000	-49.23	-53.08	-13.00	-36.23	3.85	Peak	Vertical
2 PP	5640.000	-46.95	-55.21	-13.00	-33.95	8.26	Peak	Vertical

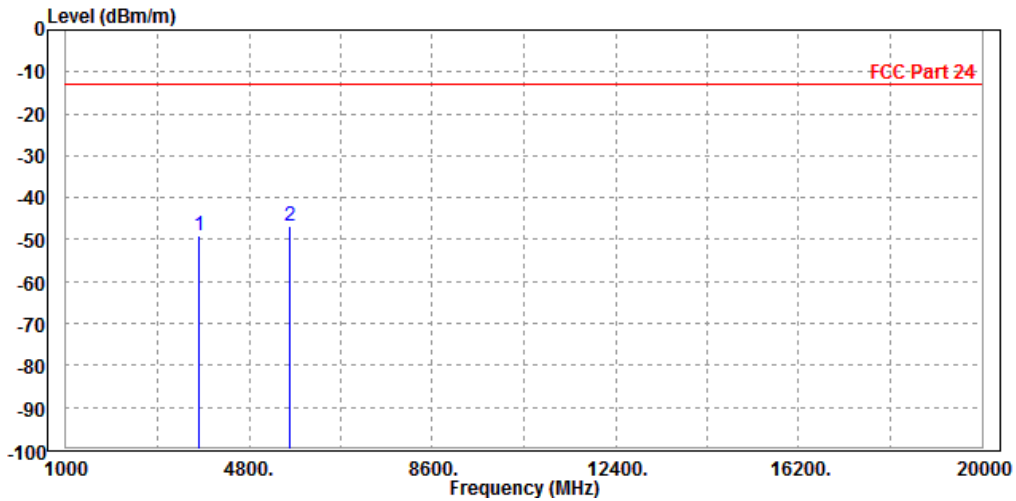



Test Report No.: RF180829W002-5

LTE Band 25

CHANNEL BANDWIDTH: 1.4MHz / QPSK

CH26047

MODE	TX channel 26047	FREQUENCY RANGE	Above 1000MHz
ENVIRONMENTAL CONDITIONS	23deg. C, 70%RH	INPUT POWER	DC 5V from adapter
TESTED BY	Rose Ma		
ANTENNA POLARITY & TEST DISTANCE: HORIZONTAL AT 3 M			

	Freq	Level	Read Level	Limit Line	Over Limit	Factor	Remark	Pol/Phase
	MHz	dBm/m	dBm	dBm/m	dB	dB/m		
1	3701.400	-39.53	-42.66	-13.00	-26.53	3.13	Peak	Horizontal
2 PP	5552.100	-36.35	-45.37	-13.00	-23.35	9.02	Peak	Horizontal

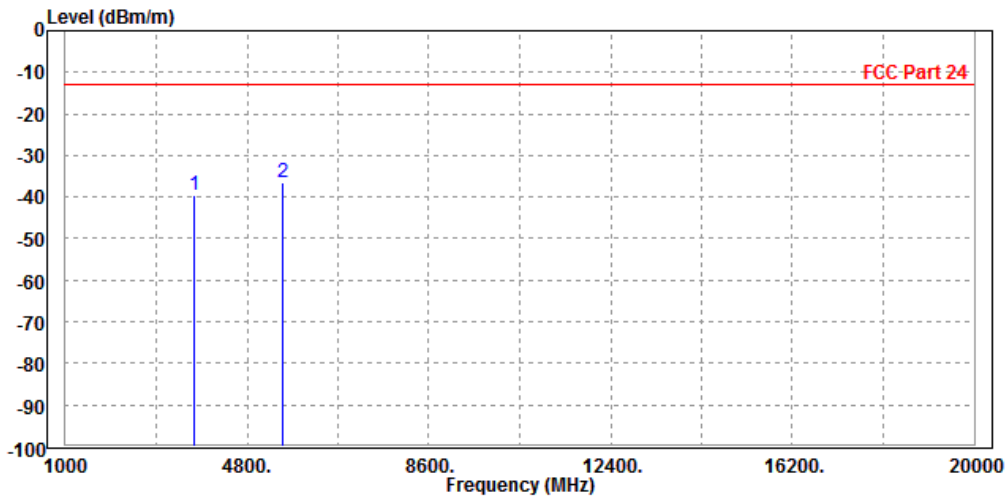



Test Report No.: RF180829W002-5

MODE	TX channel 26047	FREQUENCY RANGE	Above 1000MHz
ENVIRONMENTAL CONDITIONS	23deg. C, 70%RH	INPUT POWER	DC 5V from adapter
TESTED BY	Rose Ma		
ANTENNA POLARITY & TEST DISTANCE: VERTICAL AT 3 M			

	Freq	Level	Read Level	Limit Line	Over Limit	Factor	Remark	Pol/Phase
	MHz	dBm/m	dBm	dBm/m	dB	dB/m		
1	3701.400	-37.45	-41.03	-13.00	-24.45	3.58	Peak	Vertical
2 PP	5552.100	-32.75	-40.83	-13.00	-19.75	8.08	Peak	Vertical

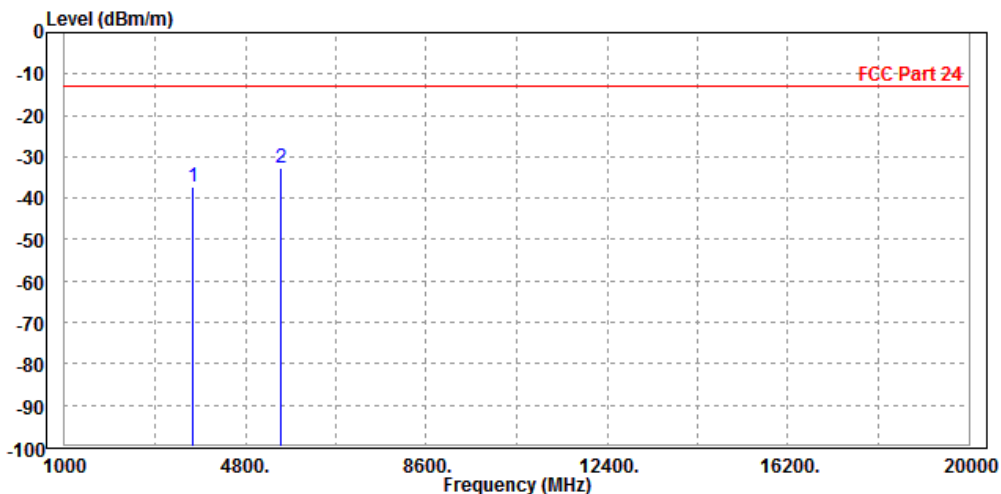



Test Report No.: RF180829W002-5

CH26365

MODE	TX channel 26365	FREQUENCY RANGE	Above 1000MHz
ENVIRONMENTAL CONDITIONS	23deg. C, 70%RH	INPUT POWER	DC 5V from adapter
TESTED BY	Rose Ma		
ANTENNA POLARITY & TEST DISTANCE: HORIZONTAL AT 3 M			

	Freq	Level	Read Level	Limit Line	Over Limit	Factor	Remark	Pol/Phase
	MHz	dBm/m	dBm	dBm/m	dB	dB/m		
1	3765.000	-37.08	-40.52	-13.00	-24.08	3.44	Peak	Horizontal
2 PP	5647.500	-34.42	-43.55	-13.00	-21.42	9.13	Peak	Horizontal

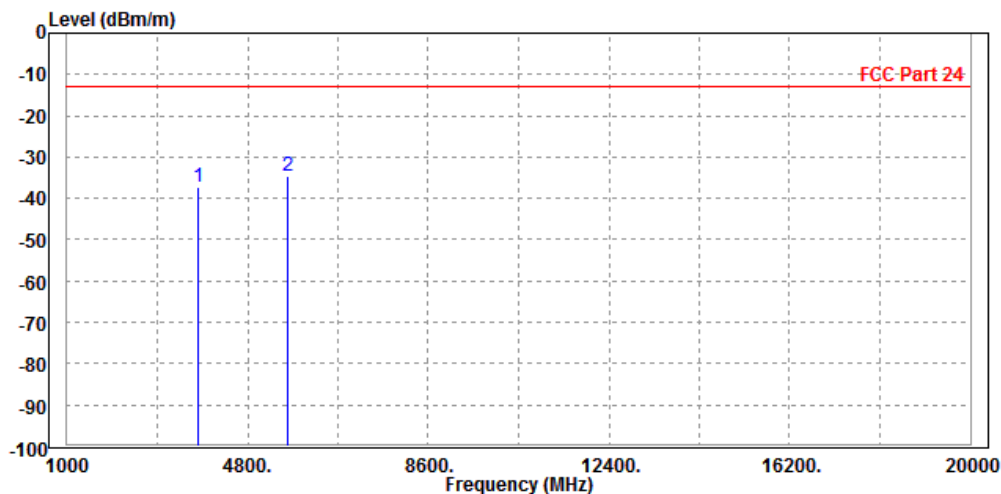



Test Report No.: RF180829W002-5

MODE	TX channel 26365	FREQUENCY RANGE	Above 1000MHz
ENVIRONMENTAL CONDITIONS	23deg. C, 70%RH	INPUT POWER	DC 5V from adapter
TESTED BY	Rose Ma		
ANTENNA POLARITY & TEST DISTANCE: VERTICAL AT 3 M			

	Freq	Level	Read Level	Limit Line	Over Limit	Factor	Remark	Pol/Phase
	MHz	dBm/m	dBm	dBm/m	dB	dB/m		
1	3765.000	-42.88	-46.78	-13.00	-29.88	3.90	Peak	Vertical
2 PP	5647.500	-39.62	-47.89	-13.00	-26.62	8.27	Peak	Vertical

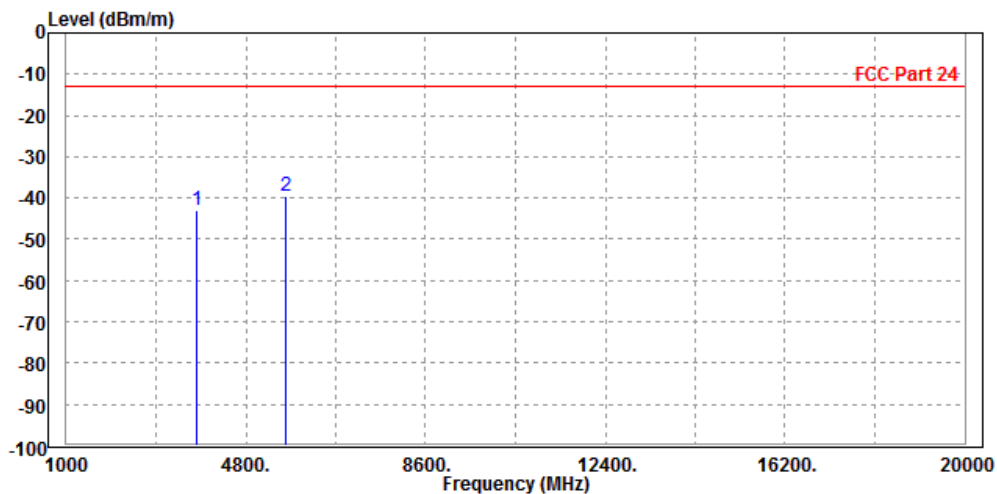



Test Report No.: RF180829W002-5

CH26683

MODE	TX channel 26683	FREQUENCY RANGE	Above 1000MHz
ENVIRONMENTAL CONDITIONS	23deg. C, 70%RH	INPUT POWER	DC 5V from adapter
TESTED BY	Rose Ma		
ANTENNA POLARITY & TEST DISTANCE: HORIZONTAL AT 3 M			

	Freq	Level	Read Level	Limit Line	Over Limit	Factor	Remark	Pol/Phase
	MHz	dBm/m	dBm	dBm/m	dB	dB/m		
1	3834.000	-37.79	-41.56	-13.00	-24.79	3.77	Peak	Horizontal
2 PP	5743.000	-32.95	-42.19	-13.00	-19.95	9.24	Peak	Horizontal

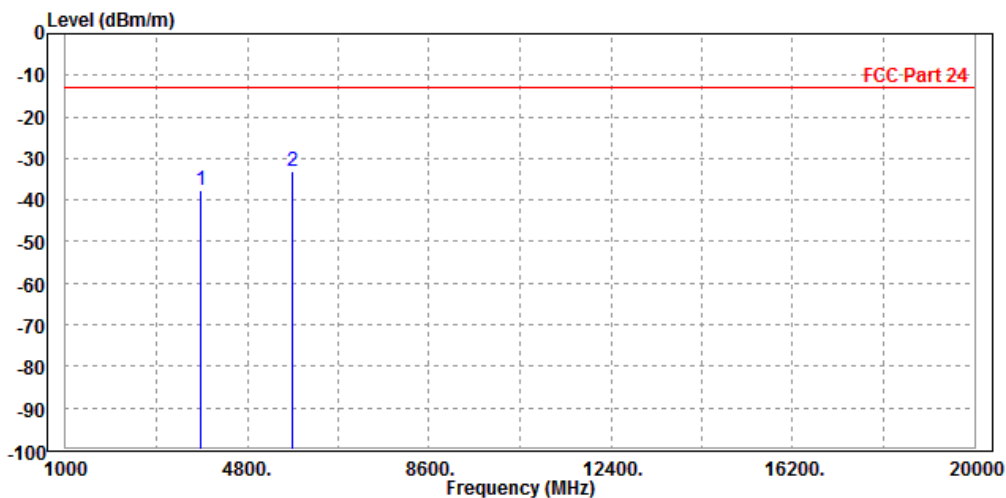



Test Report No.: RF180829W002-5

MODE	TX channel 26683	FREQUENCY RANGE	Above 1000MHz
ENVIRONMENTAL CONDITIONS	23deg. C, 70%RH	INPUT POWER	DC 5V from adapter
TESTED BY	Rose Ma		
ANTENNA POLARITY & TEST DISTANCE: VERTICAL AT 3 M			

	Freq	Level	Read Level	Limit Line	Over Limit	Factor	Remark	Pol/Phase
	MHz	dBm/m	dBm	dBm/m	dB	dB/m		
1	3834.000	-43.61	-47.86	-13.00	-30.61	4.25	Peak	Vertical
2 PP	5743.000	-30.75	-39.22	-13.00	-17.75	8.47	Peak	Vertical

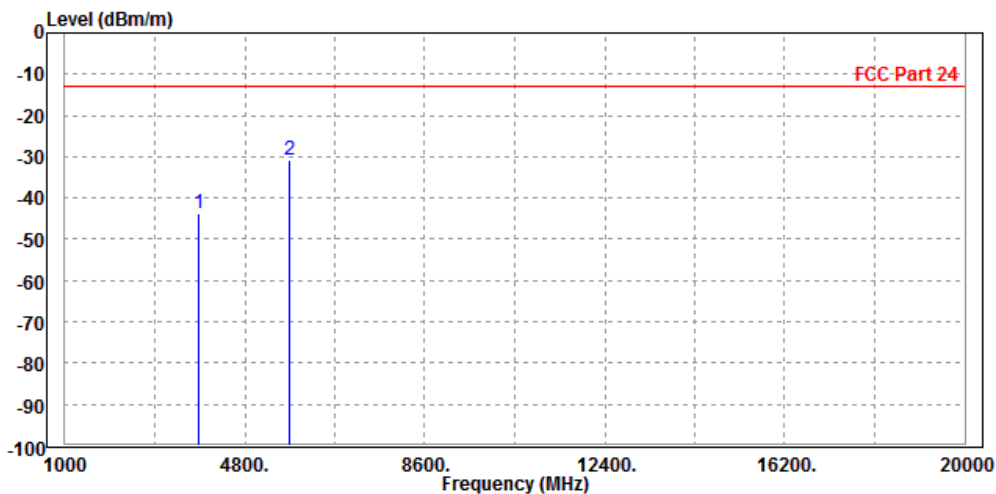



Test Report No.: RF180829W002-5

CHANNEL BANDWIDTH: 3MHz / QPSK

MODE	TX channel 26365	FREQUENCY RANGE	Above 1000MHz
ENVIRONMENTAL CONDITIONS	23deg. C, 70%RH	INPUT POWER	DC 5V from adapter
TESTED BY	Rose Ma		
ANTENNA POLARITY & TEST DISTANCE: HORIZONTAL AT 3 M			

	Freq	Level	Read Level	Limit Line	Over Limit	Factor	Remark	Pol/Phase
	MHz	dBm/m	dBm	dBm/m	dB	dB/m		
1	3765.000	-44.08	-47.52	-13.00	-31.08	3.44	Peak	Horizontal
2 PP	5647.500	-36.95	-46.08	-13.00	-23.95	9.13	Peak	Horizontal

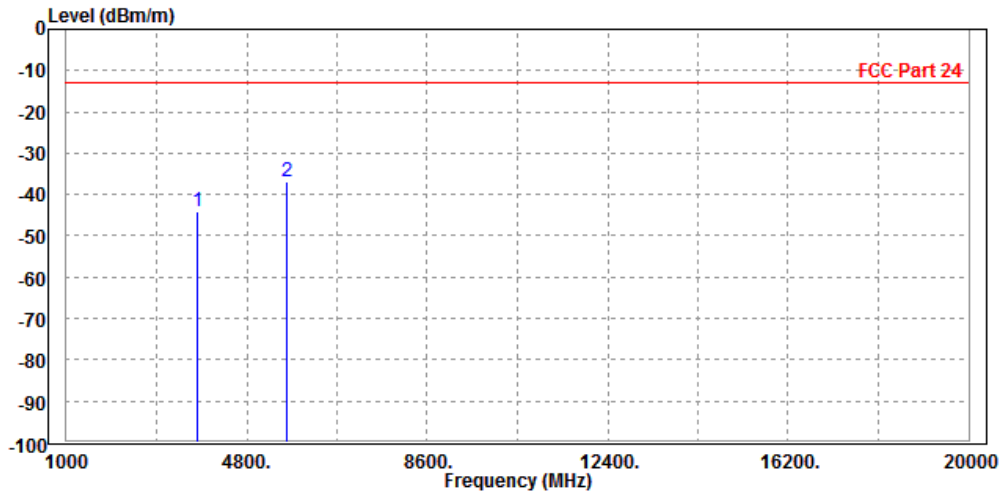



Test Report No.: RF180829W002-5

MODE	TX channel 26365	FREQUENCY RANGE	Above 1000MHz
ENVIRONMENTAL CONDITIONS	23deg. C, 70%RH	INPUT POWER	DC 5V from adapter
TESTED BY	Rose Ma		
ANTENNA POLARITY & TEST DISTANCE: VERTICAL AT 3 M			

	Freq	Level	Read Level	Limit Line	Over Limit	Factor	Remark	Pol/Phase
	MHz	dBm/m	dBm	dBm/m	dB	dB/m		
1	3765.000	-41.34	-45.24	-13.00	-28.34	3.90	Peak	Vertical
2 PP	5647.500	-35.91	-44.18	-13.00	-22.91	8.27	Peak	Vertical

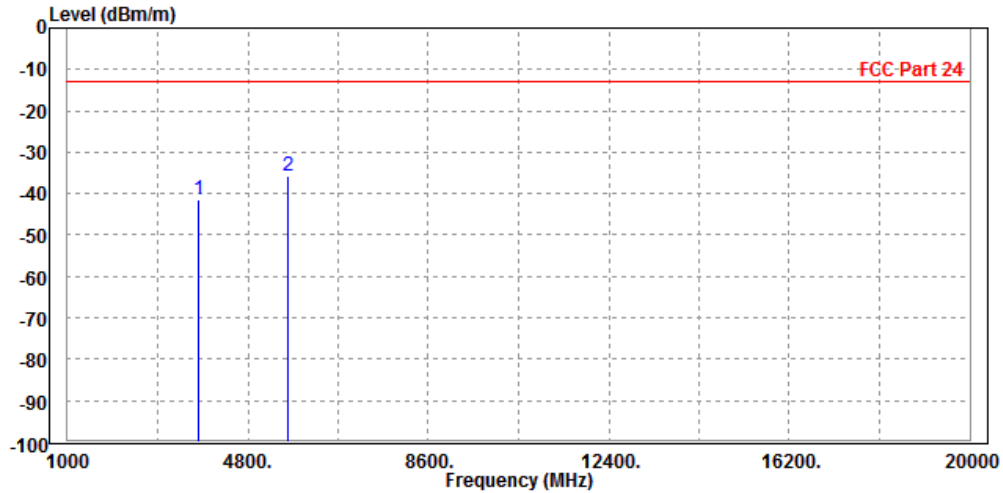



Test Report No.: RF180829W002-5

CHANNEL BANDWIDTH: 5MHz / QPSK

MODE	TX channel 26365	FREQUENCY RANGE	Above 1000MHz
ENVIRONMENTAL CONDITIONS	23deg. C, 70%RH	INPUT POWER	DC 5V from adapter
TESTED BY	Rose Ma		
ANTENNA POLARITY & TEST DISTANCE: HORIZONTAL AT 3 M			

	Freq	Level	Read Level	Limit Line	Over Limit	Factor	Remark	Pol/Phase
	MHz	dBm/m	dBm	dBm/m	dB	dB/m		
1	3765.000	-40.12	-43.56	-13.00	-27.12	3.44	Peak	Horizontal
2 PP	5647.500	-34.91	-44.04	-13.00	-21.91	9.13	Peak	Horizontal

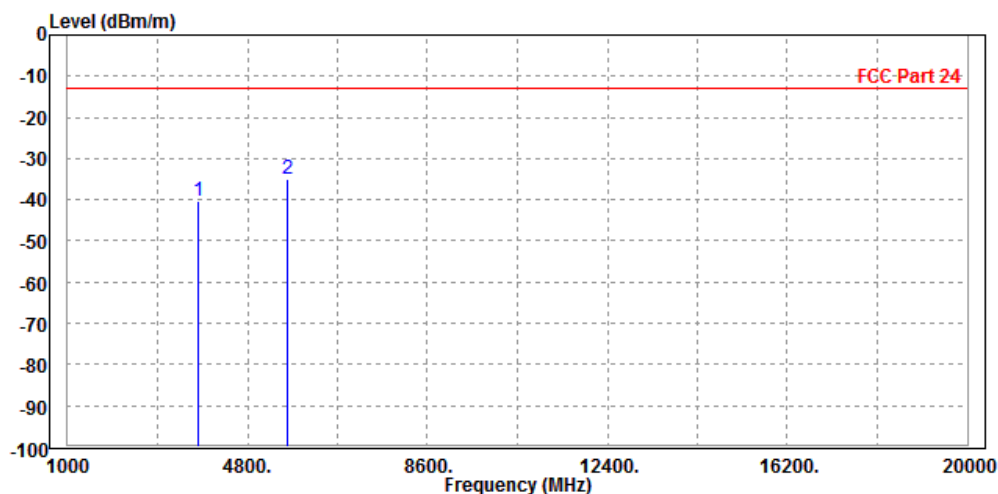



Test Report No.: RF180829W002-5

MODE	TX channel 26365	FREQUENCY RANGE	Above 1000MHz
ENVIRONMENTAL CONDITIONS	23deg. C, 70%RH	INPUT POWER	DC 5V from adapter
TESTED BY	Rose Ma		
ANTENNA POLARITY & TEST DISTANCE: VERTICAL AT 3 M			

	Freq	Level	Read Level	Limit Line	Over Limit	Factor	Remark	Pol/Phase
	MHz	dBm/m	dBm	dBm/m	dB	dB/m		
1	3765.000	-44.11	-48.01	-13.00	-31.11	3.90	Peak	Vertical
2 PP	5647.500	-40.85	-49.12	-13.00	-27.85	8.27	Peak	Vertical

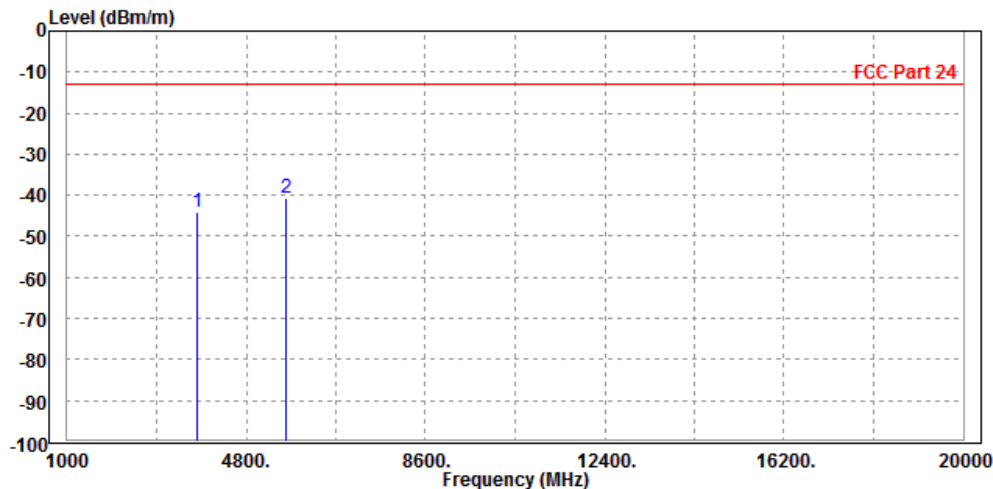



Test Report No.: RF180829W002-5

CHANNEL BANDWIDTH: 10MHz / QPSK

MODE	TX channel 26365	FREQUENCY RANGE	Above 1000MHz
ENVIRONMENTAL CONDITIONS	23deg. C, 70%RH	INPUT POWER	DC 5V from adapter
TESTED BY	Rose Ma		
ANTENNA POLARITY & TEST DISTANCE: HORIZONTAL AT 3 M			

	Freq	Level	Read Level	Limit Line	Over Limit	Factor	Remark	Pol/Phase
	MHz	dBm/m	dBm	dBm/m	dB	dB/m		
1	3765.000	-39.40	-42.84	-13.00	-26.40	3.44	Peak	Horizontal
2 PP	5647.500	-37.05	-46.18	-13.00	-24.05	9.13	Peak	Horizontal

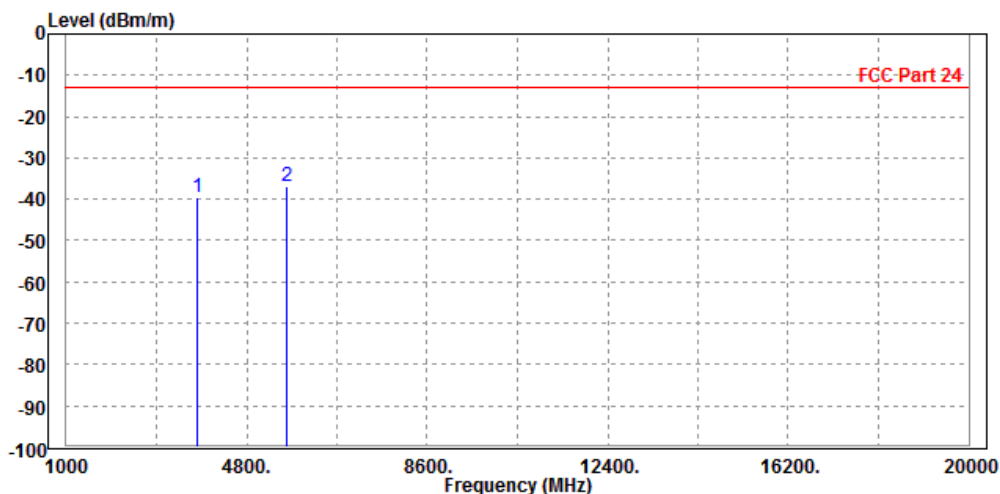



Test Report No.: RF180829W002-5

MODE	TX channel 26365	FREQUENCY RANGE	Above 1000MHz
ENVIRONMENTAL CONDITIONS	23deg. C, 70%RH	INPUT POWER	DC 5V from adapter
TESTED BY	Rose Ma		
ANTENNA POLARITY & TEST DISTANCE: VERTICAL AT 3 M			

	Freq	Level	Read Level	Limit Line	Over Limit	Factor	Remark	Pol/Phase
	MHz	dBm/m	dBm	dBm/m	dB	dB/m		
1	3765.000	-44.62	-48.52	-13.00	-31.62	3.90	Peak	Vertical
2 PP	5647.500	-37.61	-45.88	-13.00	-24.61	8.27	Peak	Vertical

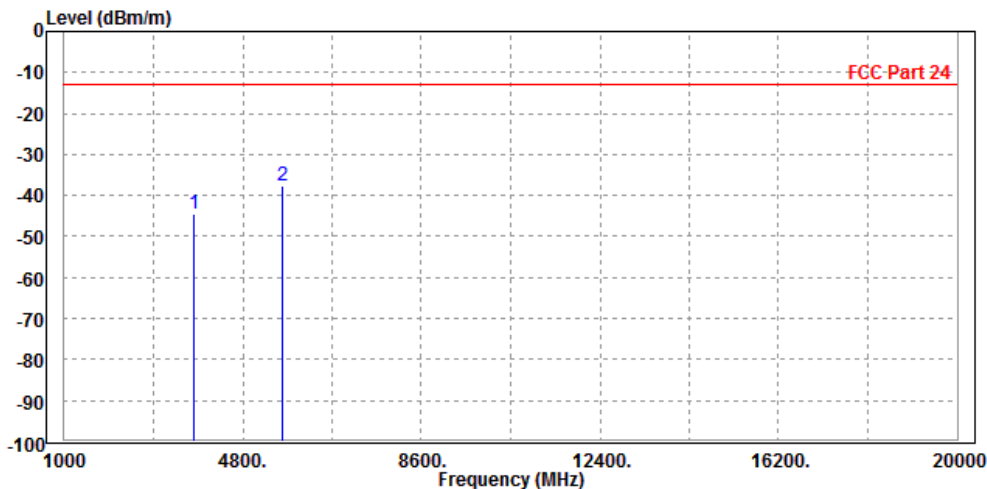



Test Report No.: RF180829W002-5

CHANNEL BANDWIDTH: 15MHz / QPSK

MODE	TX channel 26365	FREQUENCY RANGE	Above 1000MHz
ENVIRONMENTAL CONDITIONS	23deg. C, 70%RH	INPUT POWER	DC 5V from adapter
TESTED BY	Rose Ma		
ANTENNA POLARITY & TEST DISTANCE: HORIZONTAL AT 3 M			

	Freq	Level	Read Level	Limit Line	Over Limit	Factor	Remark	Pol/Phase
	MHz	dBm/m	dBm	dBm/m	dB	dB/m		
1	3765.000	-42.70	-46.14	-13.00	-29.70	3.44	Peak	Horizontal
2 PP	5647.500	-39.44	-48.57	-13.00	-26.44	9.13	Peak	Horizontal

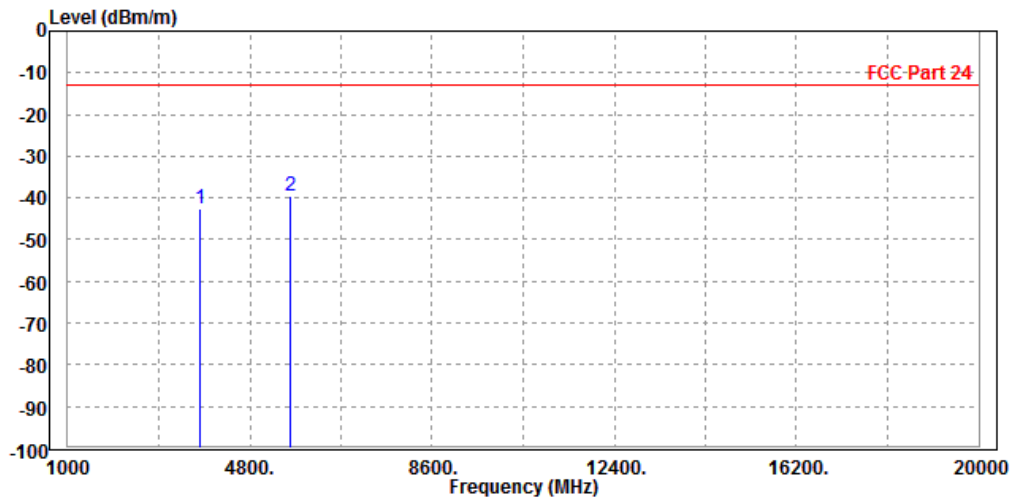



Test Report No.: RF180829W002-5

MODE	TX channel 26365	FREQUENCY RANGE	Above 1000MHz
ENVIRONMENTAL CONDITIONS	23deg. C, 70%RH	INPUT POWER	DC 5V from adapter
TESTED BY	Rose Ma		
ANTENNA POLARITY & TEST DISTANCE: VERTICAL AT 3 M			

	Freq	Level	Read Level	Limit Line	Over Limit	Factor	Remark	Pol/Phase
	MHz	dBm/m	dBm	dBm/m	dB	dB/m		
1	3765.000	-42.27	-46.17	-13.00	-29.27	3.90	Peak	Vertical
2	PP 5647.500	-39.97	-48.24	-13.00	-26.97	8.27	Peak	Vertical

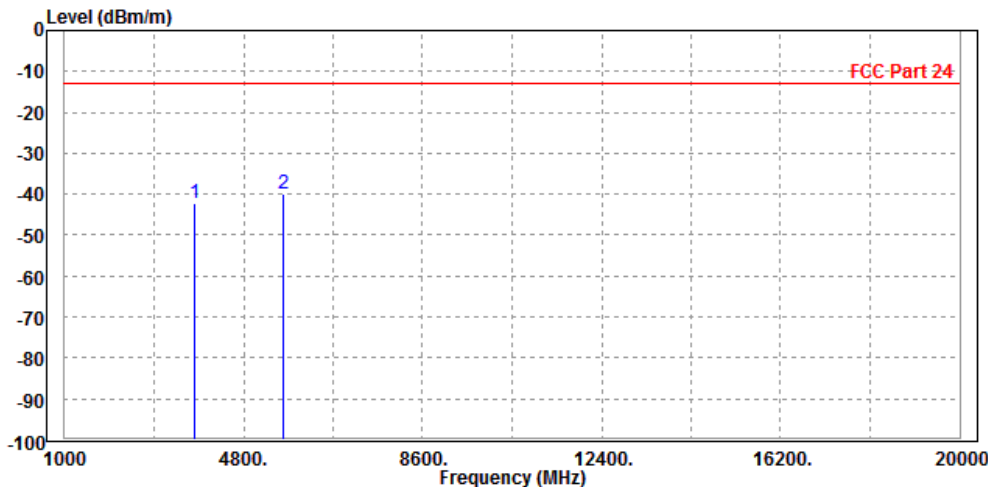



Test Report No.: RF180829W002-5

CHANNEL BANDWIDTH: 20MHz / QPSK

MODE	TX channel 26365	FREQUENCY RANGE	Above 1000MHz
ENVIRONMENTAL CONDITIONS	23deg. C, 70%RH	INPUT POWER	DC 5V from adapter
TESTED BY	Rose Ma		
ANTENNA POLARITY & TEST DISTANCE: HORIZONTAL AT 3 M			

	Freq	Level	Read Level	Limit Line	Over Limit	Factor	Remark	Pol/Phase
	MHz	dBm/m	dBm	dBm/m	dB	dB/m		
1	3765.000	-39.01	-42.45	-13.00	-26.01	3.44	Peak	Horizontal
2 PP	5647.500	-34.54	-43.67	-13.00	-21.54	9.13	Peak	Horizontal

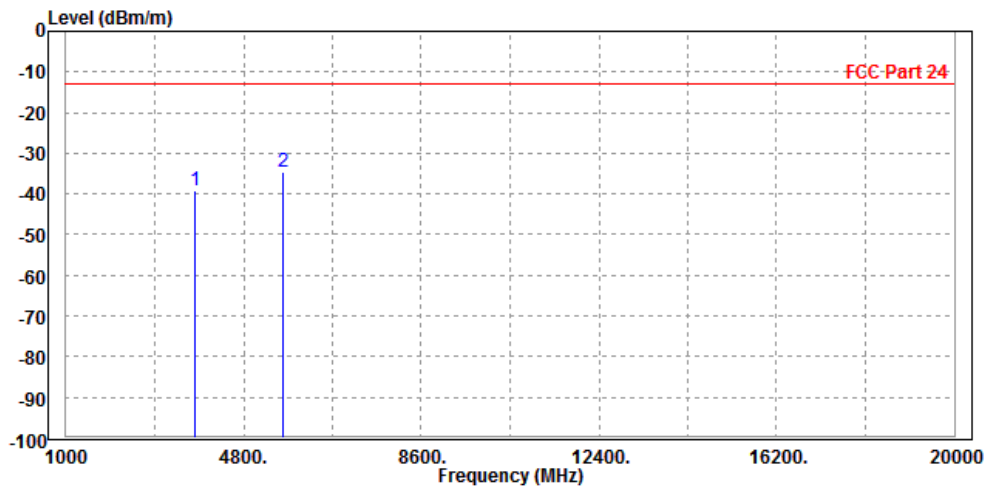



Test Report No.: RF180829W002-5

MODE	TX channel 26365	FREQUENCY RANGE	Above 1000MHz
ENVIRONMENTAL CONDITIONS	23deg. C, 70%RH	INPUT POWER	DC 5V from adapter
TESTED BY	Rose Ma		
ANTENNA POLARITY & TEST DISTANCE: VERTICAL AT 3 M			

	Freq	Level	Read Level	Limit Line	Over Limit	Factor	Remark	Pol/Phase
	MHz	dBm/m	dBm	dBm/m	dB	dB/m		
1	3765.000	-44.33	-48.23	-13.00	-31.33	3.90	Peak	Vertical
2 PP	5647.500	-38.08	-46.35	-13.00	-25.08	8.27	Peak	Vertical

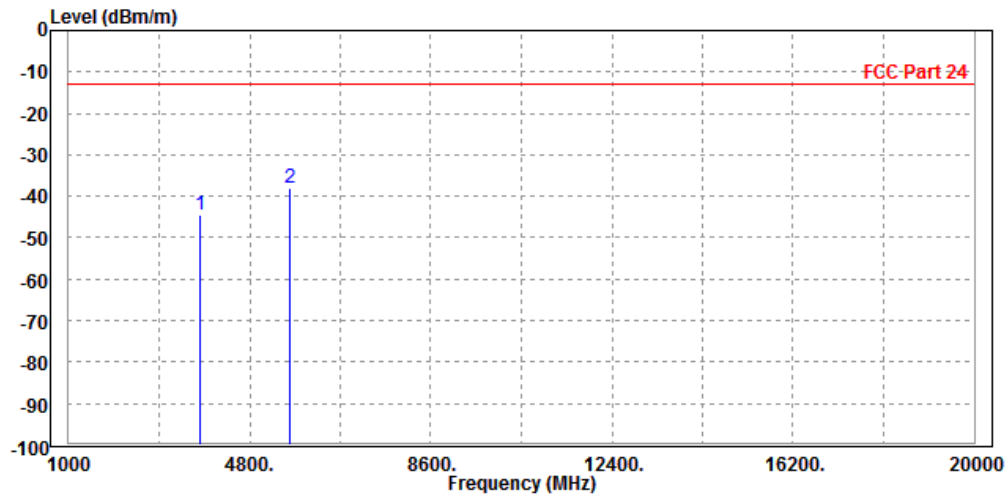

3.7 PEAK TO AVERAGE RATIO

3.7.1 LIMITS OF peak to average ratio MEASUREMENT

In measuring transmissions in this band using an average power technique, the peak to-average ratio (PAR) of the transmission may not exceed 13 dB

3.7.2 TEST SETUP

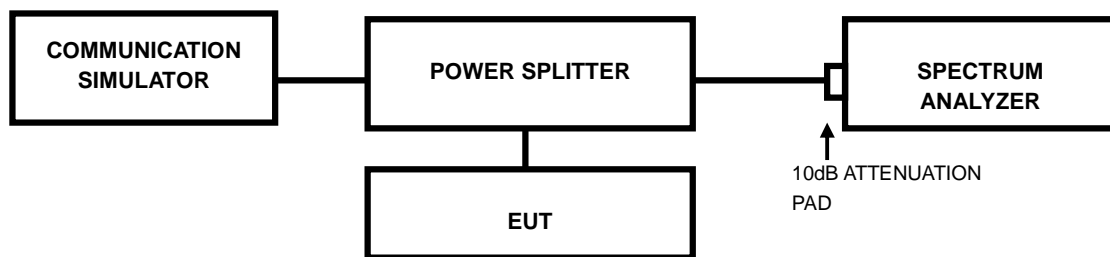

3.7.3 TEST PROCEDURES

1. Set resolution/measurement bandwidth \geq signal's occupied bandwidth;
2. Set the number of counts to a value that stabilizes the measured CCDF curve;
3. Record the maximum PAPR level associated with a probability of 0.1%.



Test Report No.: RF180829W002-5

3.7.4 TEST RESULTS

GSM

CHANNEL	FREQUENCY (MHz)	PEAK TO AVERAGE RATIO (dB)
512	1850.2	2.66

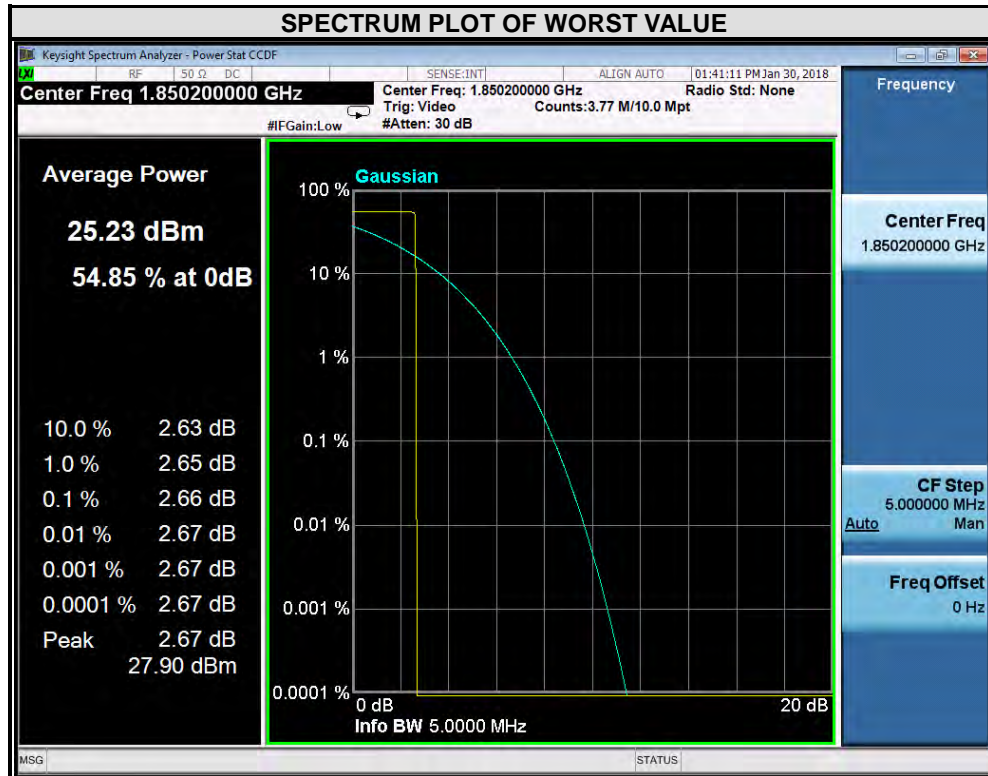



Test Report No.: RF180829W002-5

CHANNEL	FREQUENCY (MHz)	PEAK TO AVERAGE RATIO (dB)
661	1880	2.66

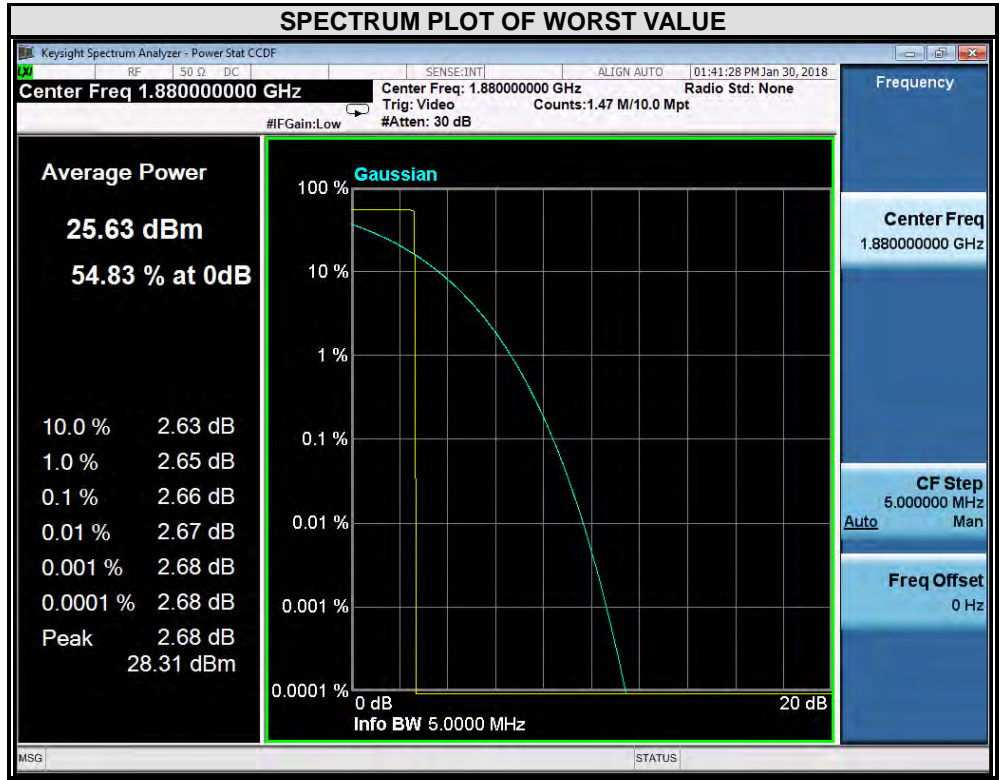



Test Report No.: RF180829W002-5

CHANNEL	FREQUENCY (MHz)	PEAK TO AVERAGE RATIO (dB)
810	1909.8	2.66

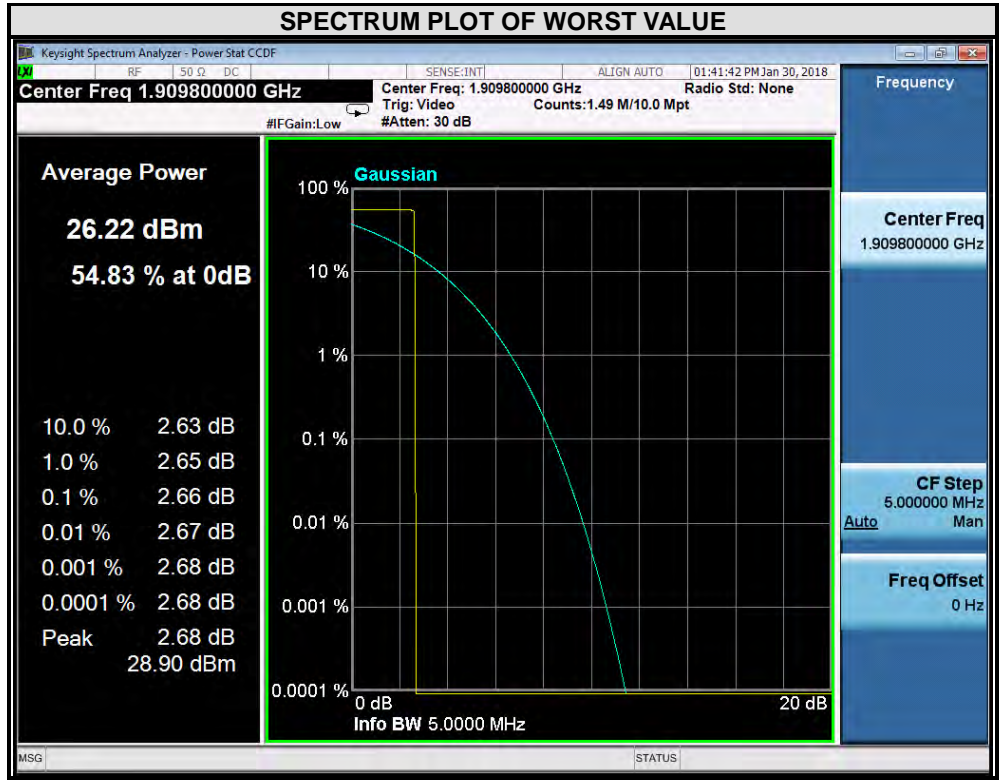



Test Report No.: RF180829W002-5

EDGE

CHANNEL	FREQUENCY (MHz)	PEAK TO AVERAGE RATIO (dB)
512	1850.2	5.83

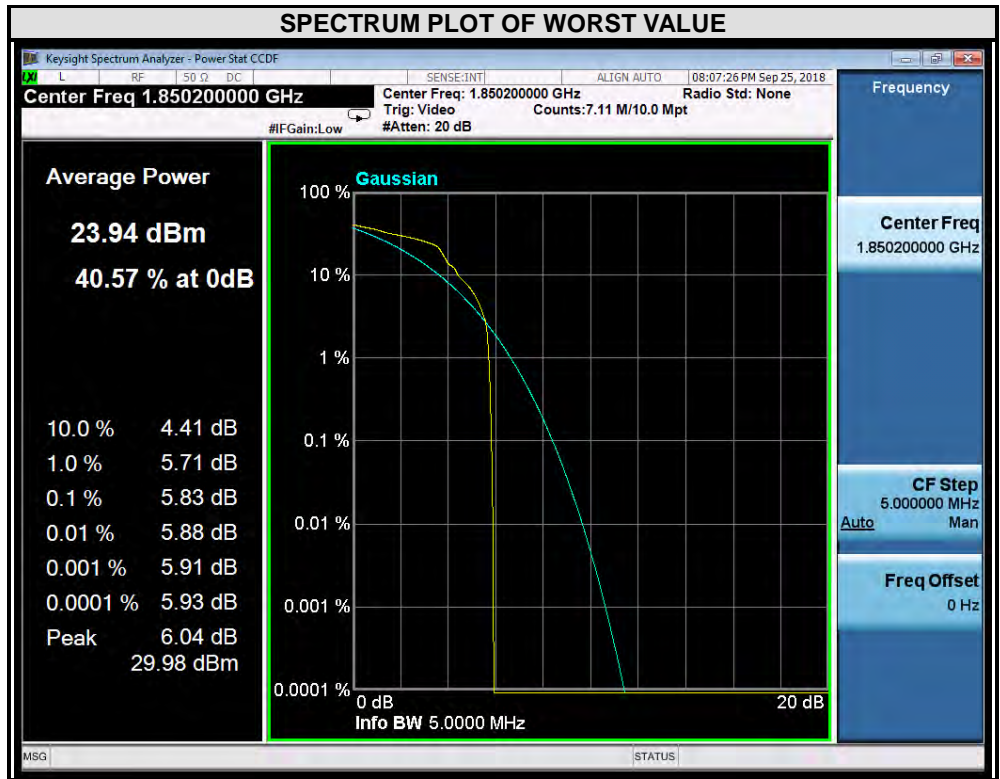



Test Report No.: RF180829W002-5

CHANNEL	FREQUENCY (MHz)	PEAK TO AVERAGE RATIO (dB)
661	1880	5.83

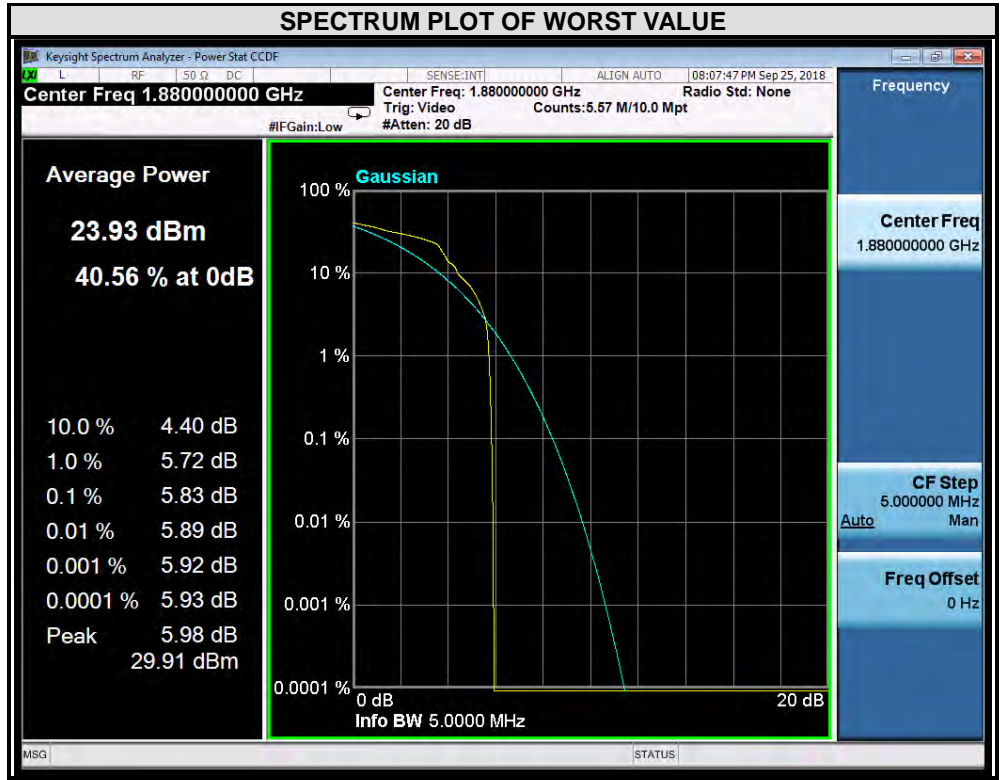



Test Report No.: RF180829W002-5

CHANNEL	FREQUENCY (MHz)	PEAK TO AVERAGE RATIO (dB)
810	1909.8	5.85

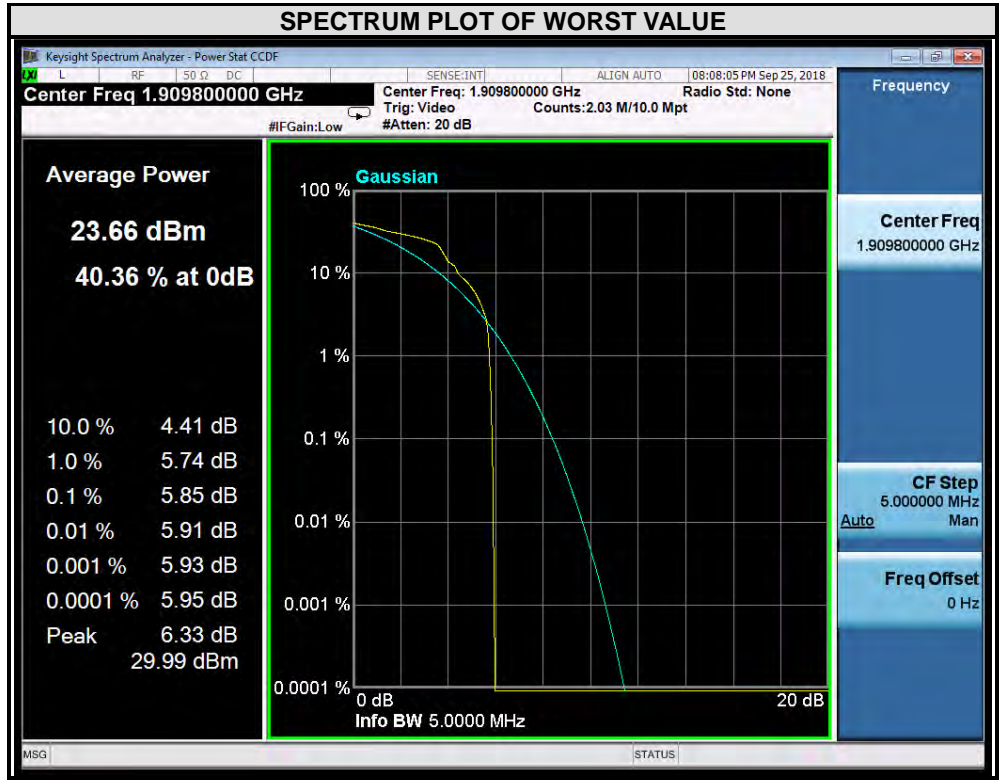



Test Report No.: RF180829W002-5

WCDMA

CHANNEL	FREQUENCY (MHz)	PEAK TO AVERAGE RATIO (dB)
9262	1852.4	2.92

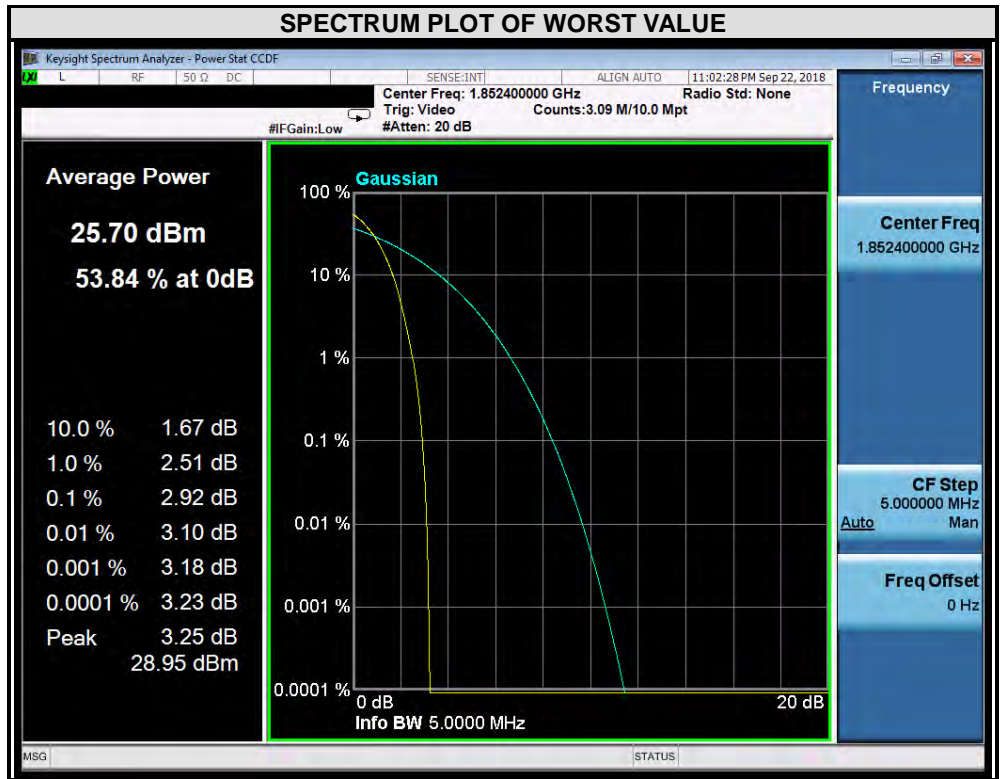



Test Report No.: RF180829W002-5

CHANNEL	FREQUENCY (MHz)	PEAK TO AVERAGE RATIO (dB)
9400	1880.0	2.65

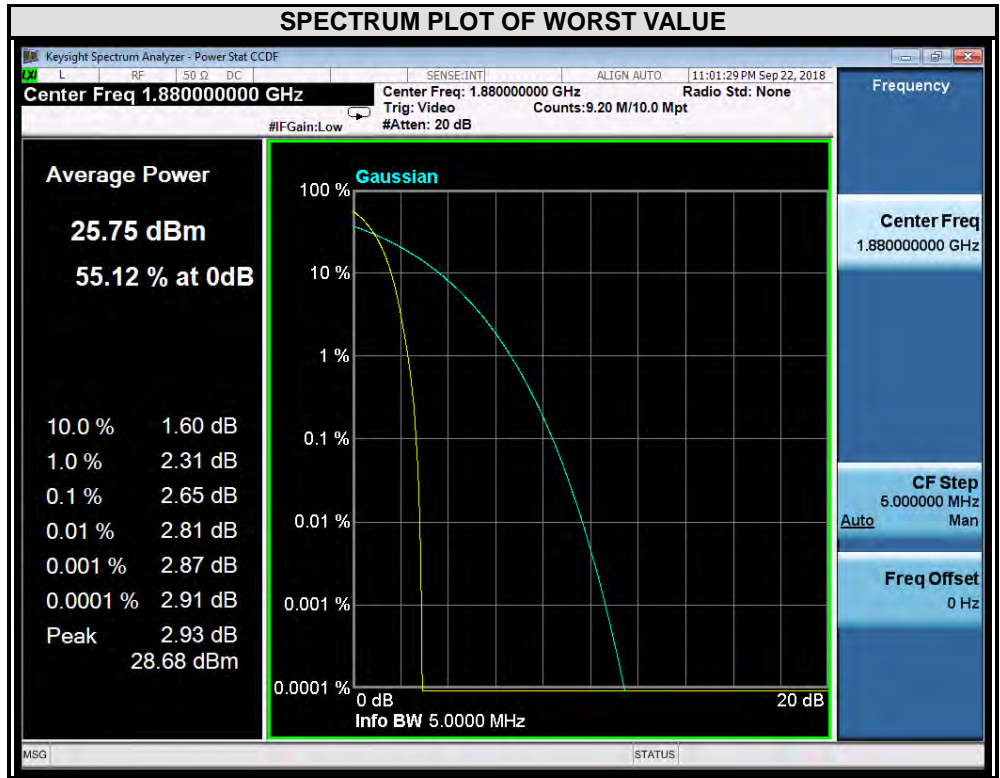



Test Report No.: RF180829W002-5

CHANNEL	FREQUENCY (MHz)	PEAK TO AVERAGE RATIO (dB)
9538	1907.6	3.86

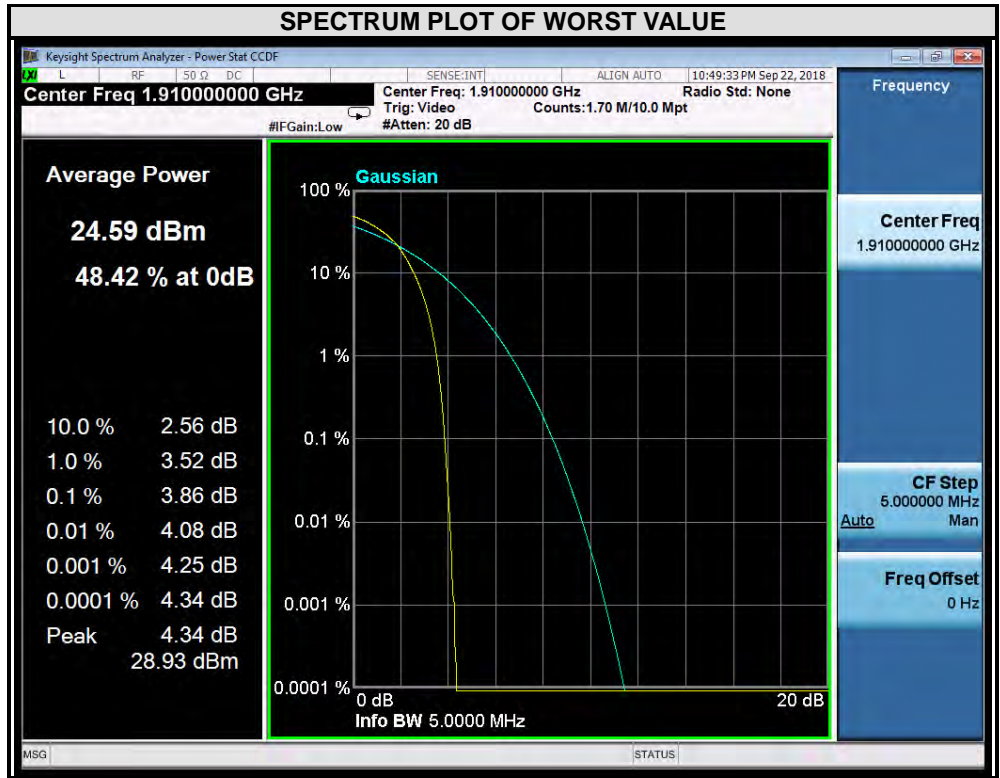



Test Report No.: RF180829W002-5

CDMA BC1

CHANNEL	FREQUENCY (MHz)	PEAK TO AVERAGE RATIO (dB)
25	1851.2	3.43

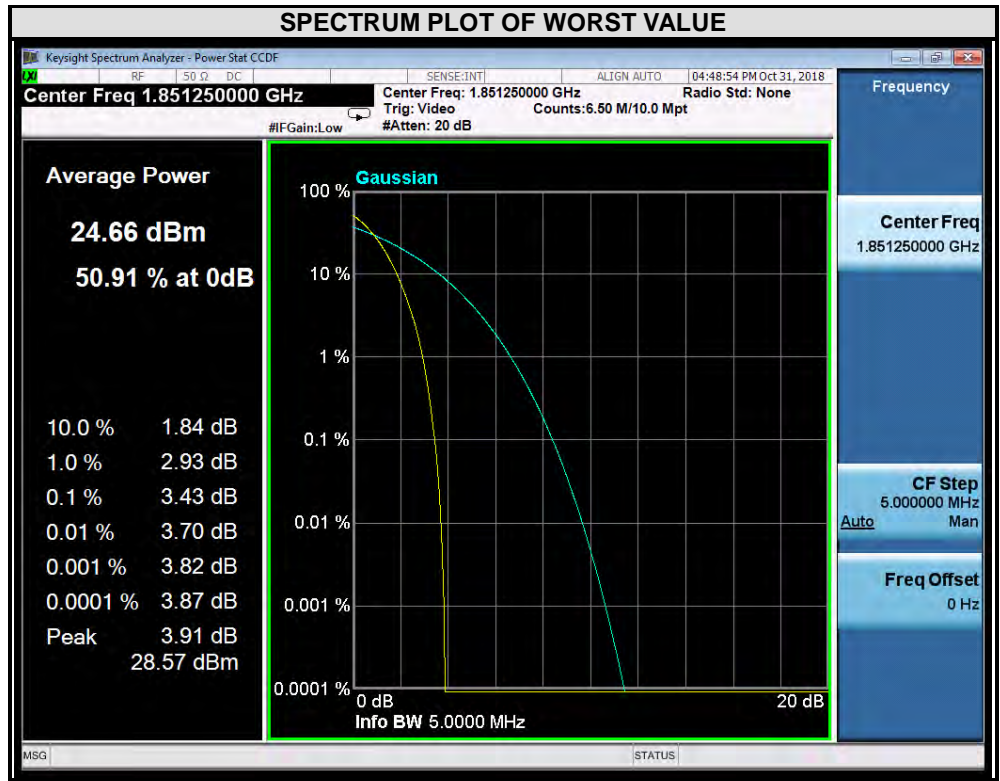



Test Report No.: RF180829W002-5

CHANNEL	FREQUENCY (MHz)	PEAK TO AVERAGE RATIO (dB)
600	1880	3.45

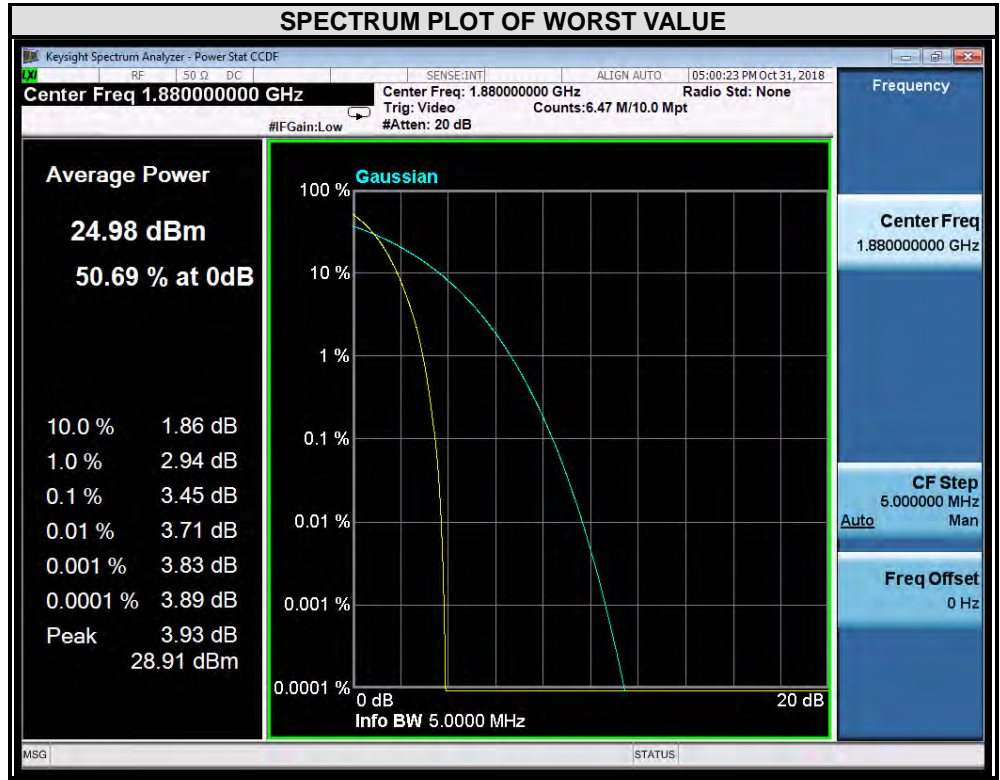



Test Report No.: RF180829W002-5

CHANNEL	FREQUENCY (MHz)	PEAK TO AVERAGE RATIO (dB)
1175	1908.8	3.36

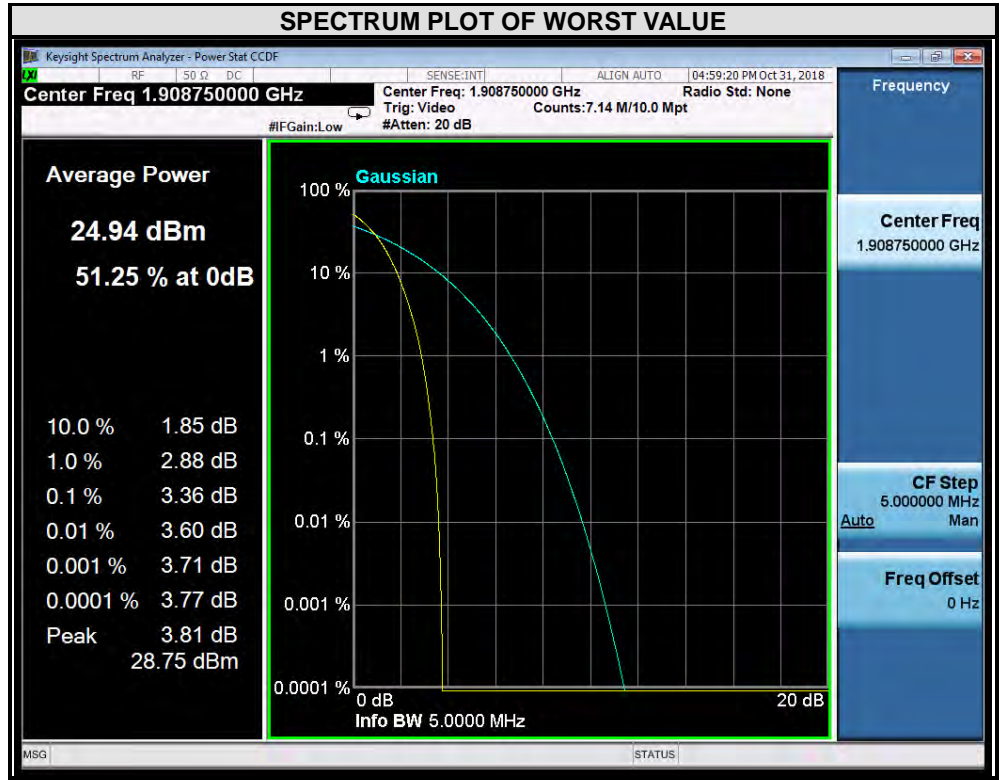

LTE BAND 2

CHANNEL BANDWIDTH: 1.4MHz				
CHANNEL	Frequency (MHz)	PEAK TO AVERAGE RATIO (dB)		
		QPSK	16QAM	64QAM
18607	1850.7	4.28	4.95	5.51
18900	1880	3.99	4.72	5.00
19193	1909.3	4.32	4.99	5.61

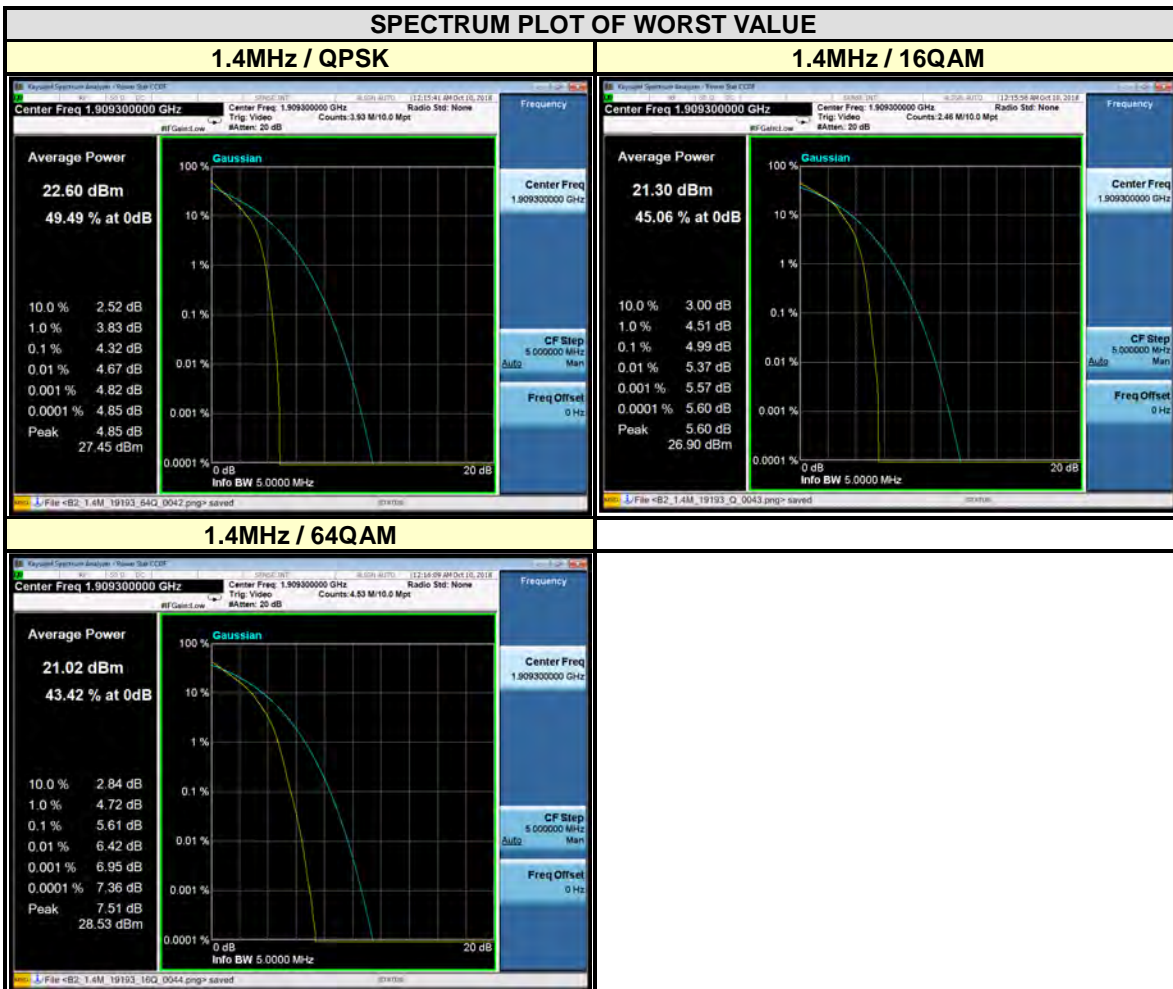

CHANNEL BANDWIDTH: 3MHz				
CHANNEL	Frequency (MHz)	PEAK TO AVERAGE RATIO (dB)		
		QPSK	16QAM	64QAM
18615	1851.5	4.49	5.24	5.67
18900	1880	4.17	4.96	5.27
19185	1908.5	4.48	5.27	6.05



CHANNEL BANDWIDTH: 5MHz				
CHANNEL	Frequency (MHz)	PEAK TO AVERAGE RATIO (dB)		
		QPSK	16QAM	64QAM
18625	1852.5	4.38	5.06	5.61
18900	1880	4.16	4.90	5.41
19175	1907.5	4.49	5.16	5.93

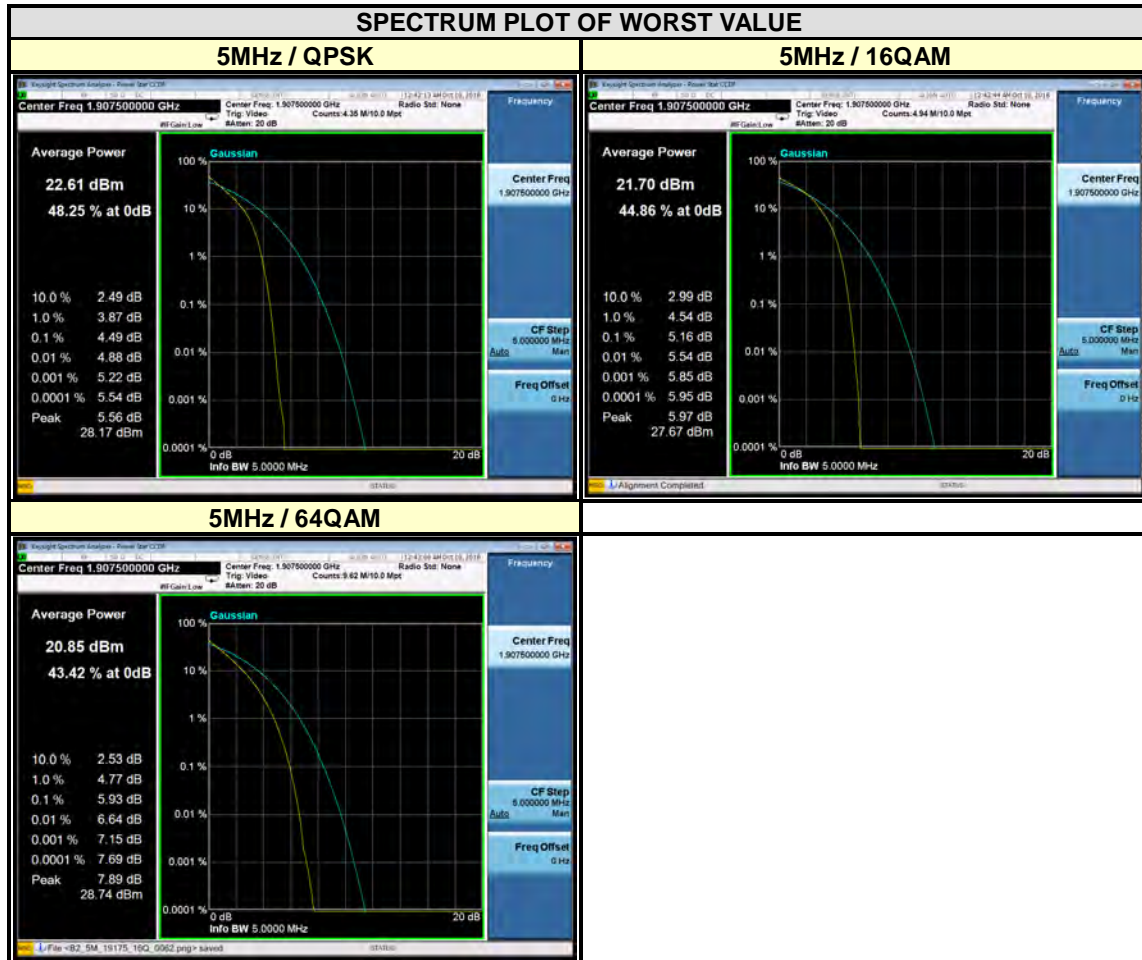

CHANNEL BANDWIDTH: 10MHz				
CHANNEL	Frequency (MHz)	PEAK TO AVERAGE RATIO (dB)		
		QPSK	16QAM	64QAM
18650	1855	4.34	5.10	5.36
18900	1880	4.18	4.95	5.19
19150	1905	4.54	4.64	5.93

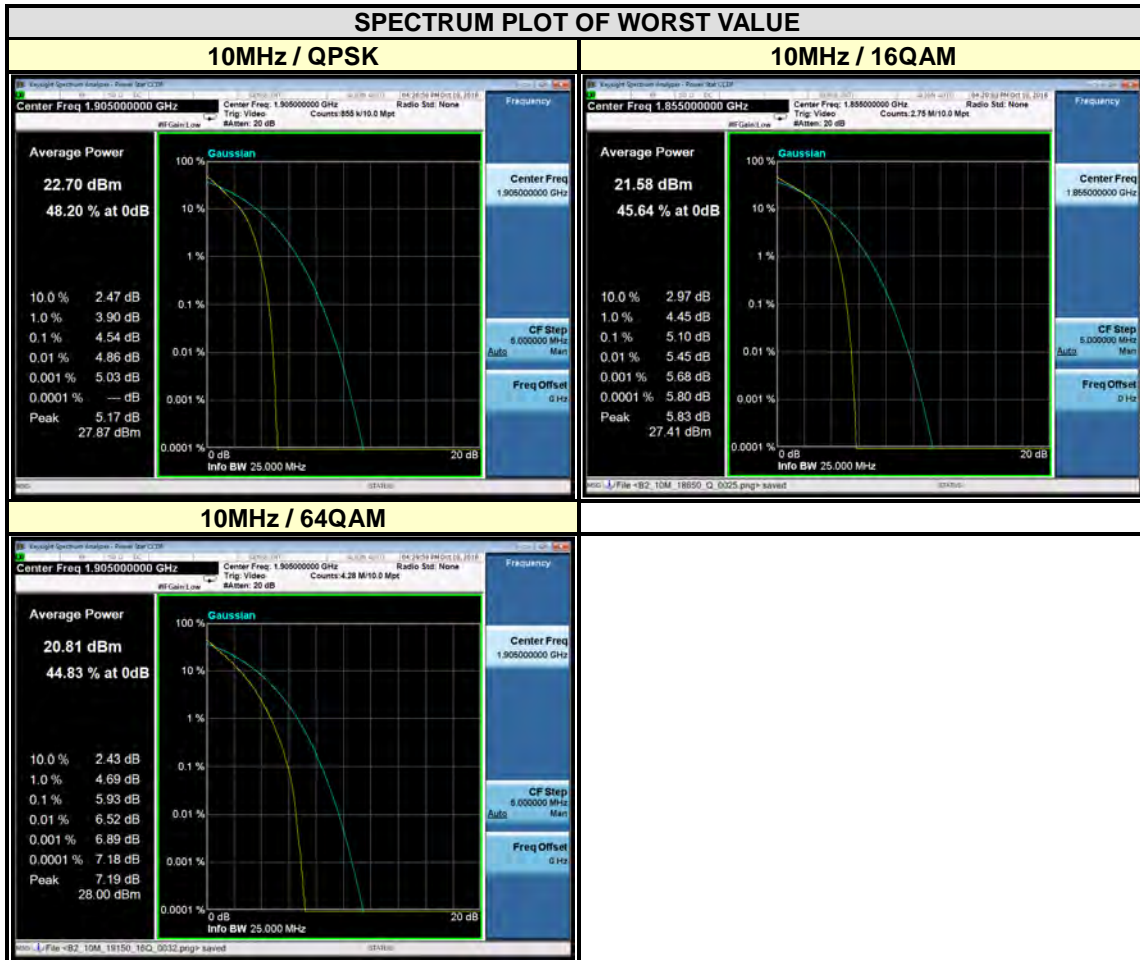

CHANNEL BANDWIDTH: 15MHz				
CHANNEL	Frequency (MHz)	PEAK TO AVERAGE RATIO (dB)		
		QPSK	16QAM	64QAM
18675	1857.5	4.26	4.91	5.41
18900	1880	4.08	4.86	5.06
19125	1902.5	4.34	5.12	5.61

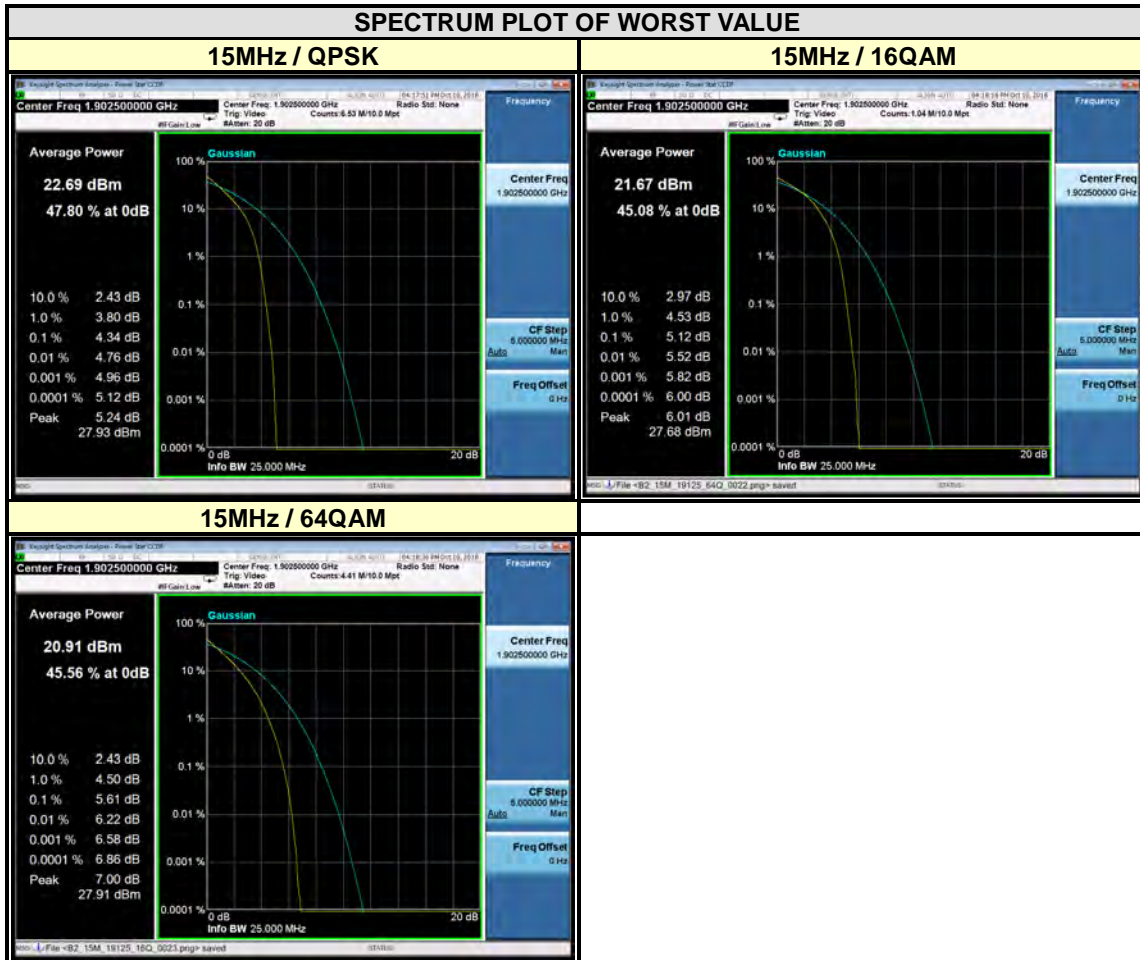

CHANNEL BANDWIDTH: 20MHz				
CHANNEL	Frequency (MHz)	PEAK TO AVERAGE RATIO (dB)		
		QPSK	16QAM	64QAM
18700	1860	4.34	5.11	5.41
18900	1880	4.21	5.04	5.89
19100	1900	4.41	5.13	5.53

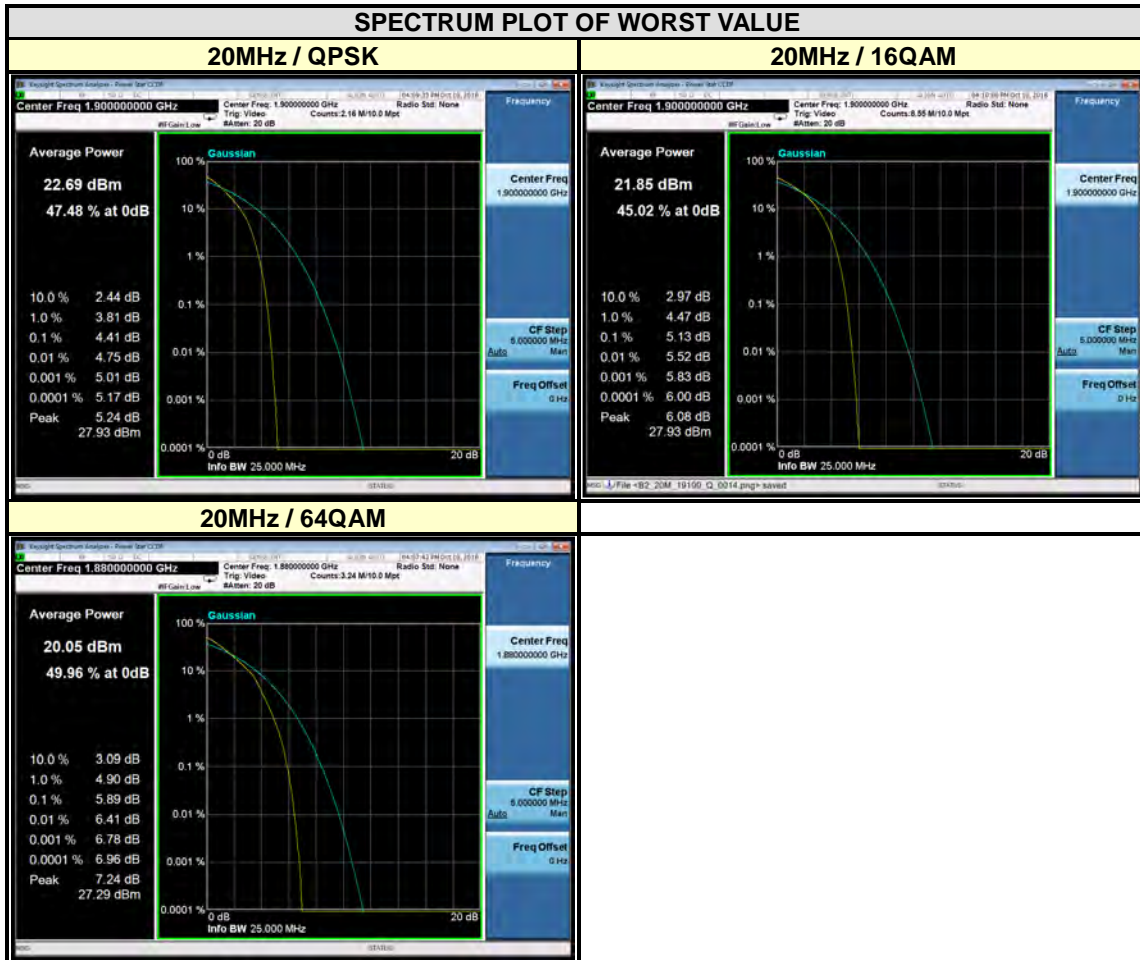



LTE BAND 25

CHANNEL BANDWIDTH: 1.4MHz				
CHANNEL	Frequency (MHz)	PEAK TO AVERAGE RATIO (dB)		
		QPSK	16QAM	64QAM
26047	1850.7	5.11	5.85	5.42
26365	1880	4.40	5.25	5.14
26683	1914.3	4.05	5.01	5.24

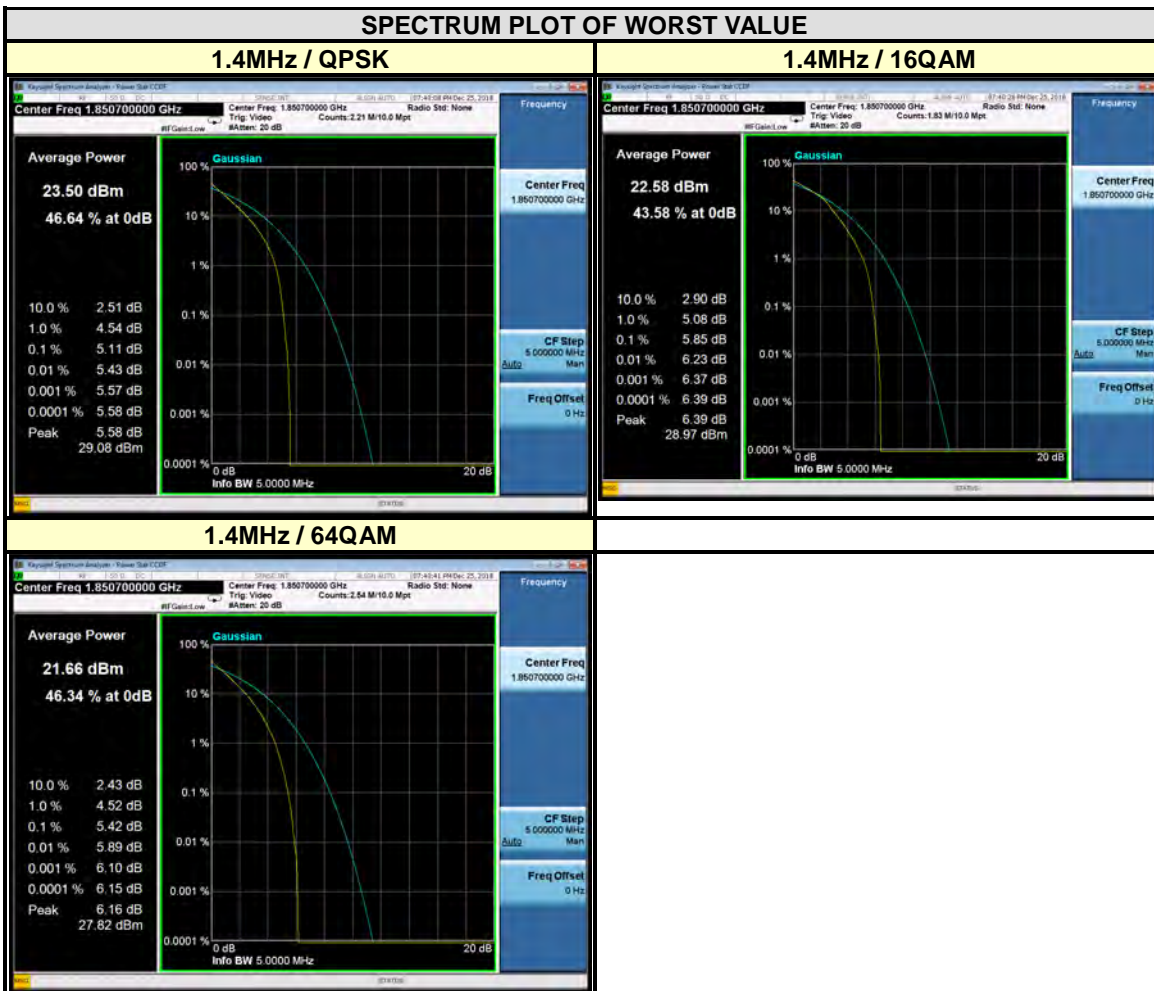

CHANNEL BANDWIDTH: 3MHz				
CHANNEL	Frequency (MHz)	PEAK TO AVERAGE RATIO (dB)		
		QPSK	16QAM	64QAM
26055	1851.5	5.20	5.96	5.61
26365	1880	4.55	5.38	5.34
26675	1913.5	4.35	5.12	5.46



CHANNEL BANDWIDTH: 5MHz				
CHANNEL	Frequency (MHz)	PEAK TO AVERAGE RATIO (dB)		
		QPSK	16QAM	64QAM
26065	1852.5	4.76	5.82	5.44
26365	1880	4.37	5.27	5.20
26665	1912.5	4.38	5.30	5.47

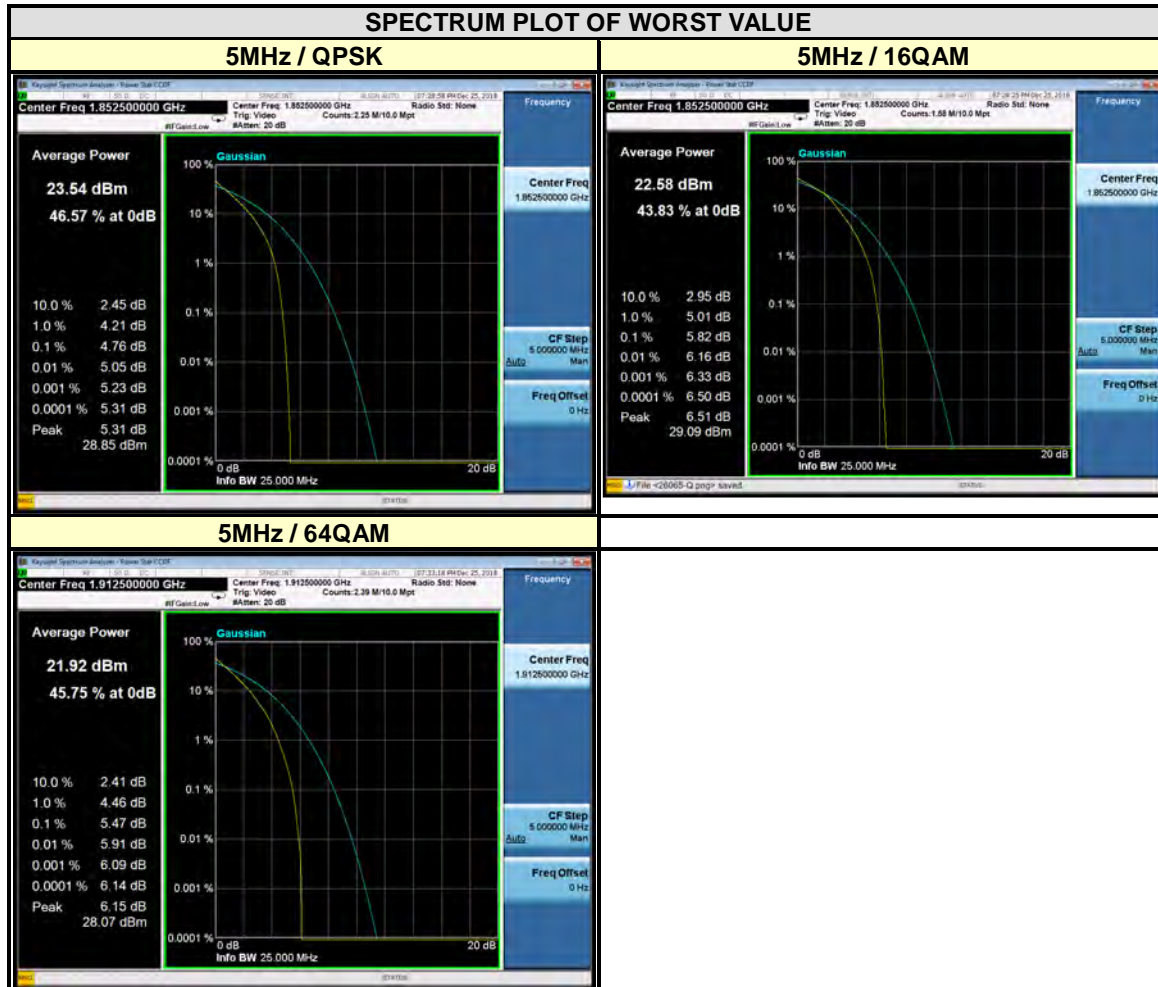

CHANNEL BANDWIDTH: 10MHz				
CHANNEL	Frequency (MHz)	PEAK TO AVERAGE RATIO (dB)		
		QPSK	16QAM	64QAM
26090	1855	4.97	5.75	5.37
26365	1880	4.71	5.56	5.20
26640	1910	5.96	6.73	5.99



CHANNEL BANDWIDTH: 15MHz				
CHANNEL	Frequency (MHz)	PEAK TO AVERAGE RATIO (dB)		
		QPSK	16QAM	64QAM
26115	1857.5	4.75	5.52	5.37
26365	1880	4.76	5.56	5.18
26615	1907.5	5.05	5.84	5.72



CHANNEL BANDWIDTH: 20MHz				
CHANNEL	Frequency (MHz)	PEAK TO AVERAGE RATIO (dB)		
		QPSK	16QAM	64QAM
26140	1860	4.93	5.76	5.33
26365	1880	4.76	5.66	5.20
26590	1905	5.13	5.94	5.76





Test Report No.: RF180829W002-5

4 INFORMATION ON THE TESTING LABORATORIES

We, BV 7LAYERS COMMUNICATIONS TECHNOLOGY (SHENZHEN) CO. LTD., were founded in 2015 to provide our best service in EMC, Radio, Telecom and Safety consultation. Our laboratories are accredited and approved according to ISO/IEC 17025.

If you have any comments, please feel free to contact us at the following:

Shenzhen EMC/RF Lab:

Tel: +86-755-88696566

Fax: +86-755-88696577

Email: customerservice.dg@cn.bureauveritas.com

Web Site: www.adt.com.tw

The address and road map of all our labs can be found in our web site also.



Test Report No.: RF180829W002-5

5 APPENDIX A – MODIFICATIONS RECORDERS FOR ENGINEERING CHANGES TO THE EUT BY THE LAB

No any modifications are made to the EUT by the lab during the test.

---END---