



FCC RF Test Report

APPLICANT : Sonim Technologies, Inc.
EQUIPMENT : LTE Phone
BRAND NAME : Sonim
MODEL NAME : XP5800(PC2111)
FCC ID : WYPPC2100
STANDARD : FCC 47 CFR Part 2, 27D
CLASSIFICATION : PCS Licensed Transmitter Held to Ear (PCE)

The product was received on Sep. 21, 2017 and completely tested on Oct. 11, 2017. We, Sporton International (Kunshan) Inc., would like to declare that the tested sample has been evaluated in accordance with the procedures given in ANSI/TIA-603-E and shown compliance with the applicable technical standards.

This report contains data that were produced under subcontract by Laboratory SPORTON INTERNATIONAL INC.

The test results in this report apply exclusively to the tested model / sample. Without written approval of Sporton International (Kunshan) Inc., the test report shall not be reproduced except in full.



Approved by: James Huang / Manager

Sporton International (Kunshan) Inc.

**No.3-2 Ping-Xiang Rd, Kunshan Development Zone Kunshan City Jiangsu Province 215335
China**



TABLE OF CONTENTS

REVISION HISTORY.....3
SUMMARY OF TEST RESULT4
1 GENERAL DESCRIPTION5
1.1 Applicant.....5
1.2 Manufacturer.....5
1.3 Product Feature of Equipment Under Test.....5
1.4 Product Specification of Equipment Under Test.....5
1.5 Modification of EUT6
1.6 Maximum Frequency Tolerance and Emission Designator and Conducted power6
1.7 Testing Site.....7
1.8 Applied Standards8
2 TEST CONFIGURATION OF EQUIPMENT UNDER TEST9
2.1 Test Mode.....9
2.2 Connection Diagram of Test System.....10
2.3 Support Unit used in test configuration and system10
2.4 Measurement Results Explanation Example.....10
2.5 Frequency List of Low/Middle/High Channels11
3 CONDUCTED TEST ITEMS12
3.1 Measuring Instruments12
3.2 Test Setup12
3.3 Test Result of Conducted Test12
3.4 Conducted Output Power Measurement13
3.5 Peak-to-Average Ratio14
3.6 EIRP Power Density15
3.7 Occupied Bandwidth.....16
3.8 Conducted Band Edge Measurement17
3.9 Conducted Spurious Emission Measurement18
3.10 Frequency Stability Measurement.....19
4 RADIATED TEST ITEMS20
4.1 Measuring Instruments20
4.2 Test Setup20
4.3 Test Result of Radiated Test20
4.4 Radiated Spurious Emission Measurement21
5 LIST OF MEASURING EQUIPMENT22
6 UNCERTAINTY OF EVALUATION23

APPENDIX A. TEST RESULTS OF CONDUCTED TEST

APPENDIX B. TEST RESULTS OF RADIATED TEST

APPENDIX C. TEST SETUP PHOTOGRAPHS



SUMMARY OF TEST RESULT

Report Section	FCC Rule	Description	Limit	Result	Remark
3.4	§2.1046	Conducted Output Power	Reporting Only	PASS	-
3.5	-	Peak-to-Average Ratio	<13dB	N/A	Reporting only
3.6	§27.50 (a)(3)	EIRP Power Density	EIRP < 250mW/5MHz	PASS	-
3.7	§2.1049	Occupied Bandwidth	Reporting Only	PASS	-
3.8	§2.1051 §27.53 (a)(4)	Conducted Band Edge Measurement	Refer standard	PASS	-
3.9	§2.1051 §27.53 (a)(4)	Conducted Spurious Emission	< 70+10log ₁₀ (P[Watts])	PASS	-
3.10	§2.1055 §27.54	Frequency Stability Temperature & Voltage	Within the band	PASS	-
4.4	§2.1053 §27.53 (a)(4)	Radiated Spurious Emission	< 70+10log ₁₀ (P[Watts])	PASS	Under limit 4.21 dB at 11527.000 MHz



1 General Description

1.1 Applicant

Sonim Technologies, Inc.
1825 S. Grant St., Suite 200., San Mateo, CA, 94402

1.2 Manufacturer

Sonim Technologies (Shenzhen) Limited
2nd Floor, No. 2 Building Phase B, Daqian Industrial park, Longchang Road, 67 District, Baoan, Shenzhen, P. R. China

1.3 Product Feature of Equipment Under Test

Product Feature	
Equipment	LTE Phone
Brand Name	Sonim
Model Name	XP5800(PC2111)
FCC ID	WYPPC2100
EUT supports Radios application	CDMA/EV-DO/GSM/GPRS/EGPRS/WCDMA/HSPA/ DC-HSDPA/HSPA+(16QAM uplink is not supported)/LTE WLAN 2.4GHz 802.11b/g/n HT20/HT40 WLAN 5GHz 802.11a/n HT20/HT40 Bluetooth v3.0 + EDR/Bluetooth v4.0 LE /Bluetooth v4.2 LE
IMEI Code	Conducted: 001080001908624/001080001908624 Radiation: 001080001912451/001080001912444
HW Version	A
SW Version	5SA.0.0-00-7.1.2-00.25.01
EUT Stage	Identical Prototype

1.4 Product Specification of Equipment Under Test

Product Feature	
Tx Frequency	LTE Band 30 : 2307.5 MHz ~ 2312.5 MHz
Rx Frequency	LTE Band 30 : 2352.5 MHz ~ 2357.5 MHz
Bandwidth	5MHz / 10MHz
Maximum Output Power to Antenna	LTE Band 30 : 21.71 dBm
Antenna Type/Gain	PIFA Antenna / -2.00dBi
Type of Modulation	QPSK / 16QAM

1.5 Modification of EUT

No modifications are made to the EUT during all test items.

1.6 Maximum Frequency Tolerance and Emission Designator and Conducted power

LTE Band 30		QPSK			16QAM		
BW (MHz)	Frequency Range (MHz)	Emission Designator (99%OBW)	Frequency Tolerance (ppm)	Maximum Conducted power(W)	Emission Designator (99%OBW)	Frequency Tolerance (ppm)	Maximum Conducted power(W)
5	2307.5 ~ 2312.5	4M48G7D	-	0.1449	4M51W7D	-	0.1239
10	2310.0	8M99G7D	0.0017	0.1483	8M91W7D	-	0.1242

1.7 Testing Site

Sporton Lab is accredited to ISO 17025 by National Voluntary Laboratory Accreditation Program (NVLAP code: 600155-0) and the FCC designation No. is CN5013.

Test Site	Sporton International (Kunshan) Inc.	
Test Site Location	No.3-2 Ping-Xiang Rd, Kunshan Development Zone Kunshan City Jiangsu Province 215335 China TEL : +86-512-57900158 FAX : +86-512-57900958	
Test Site No.	Sporton Site No.	FCC Test Firm Registration No.
	TH01-KS	630927

SPORTON INTERNATIONAL INC. is accredited to ISO 17025 by Taiwan Accreditation Foundation (TAF code : 1190) and the FCC designation No. TW0007 under the FCC-recognized accredited testing laboratories by Mutual Recognition Agreement (MRA) in FCC Test.

Test Site	SPORTON INTERNATIONAL INC.	
Test Site Location	No.58, Aly. 75, Ln. 564, Wenhua 3rd Rd., Guishan Dist., Taoyuan City 333, Taiwan (R.O.C.) TEL: +886-3-327-3456 FAX: +886-3-328-4978	
Test Site No.	Sporton Site No.	
	03CH15-HY	
FCC Test Firm Registration No.	214511	

Note:

1. The test site complies with ANSI C63.4 2014 requirement.
2. Test data subcontracted: radiated spurious emissions only in section 4.4 of this report.



1.8 Applied Standards

According to the specifications of the manufacturer, the EUT must comply with the requirements of the following standards:

- ♦ 47 CFR Part 2, Part 27(D)
- ♦ ANSI/TIA-603-E
- ♦ FCC KDB 971168 D01 Power Meas. License Digital Systems v03

Remark:

1. All test items were verified and recorded according to the standards and without any deviation during the test.
2. This EUT has also been tested and complied with the requirements of FCC Part 15, Subpart B, recorded in a separate test report.

2 Test Configuration of Equipment Under Test

2.1 Test Mode

Antenna port conducted and radiated test items listed below are performed according to KDB 971168 D01 Power Meas. License Digital Systems v03 with maximum output power.

Radiated measurements are performed by rotating the EUT in three different orthogonal test planes to find the maximum emission.

Conducted Test Cases	Band	Bandwidth (MHz)						Modulation		RB #			Test Channel		
		1.4	3	5	10	15	20	QPSK	16QAM	1	Half	Full	L	M	H
Max. Output Power	30	-	-	V		-	-	V	V	V	V	V	V	V	V
		-	-		V	-	-	V	V	V	V	V		V	
Peak-to-Average Ratio	30	-	-		V	-	-	V	V	V		V		V	
E.I.R.P PSD	30	-	-	V		-	-	V	V	V			V	V	V
		-	-		V	-	-	V	V	V				V	
26dB and 99% Bandwidth	30	-	-	V		-	-	V	V			V	V	V	V
		-	-		V	-	-	V	V			V		V	
Conducted Band Edge	30	-	-	V		-	-	V	V	V		V	V		V
		-	-		V	-	-	V	V	V		V		V	
Conducted Spurious Emission	30	-	-	V		-	-	V	V	V			V	V	V
		-	-		V	-	-	V	V	V				V	
Frequency Stability	30	-	-		V	-	-	V				V		V	
Radiated Spurious Emission	30	-	-	V		-	-	V		V			V	V	V
					V			V		V				V	
Note	<ol style="list-style-type: none"> The mark "v " means that this configuration is chosen for testing The mark "- " means that this bandwidth is not supported. The device is investigated from 30MHz to 10 times of fundamental signal for radiated spurious emission test under different RB size/offset and modulations in exploratory test. Subsequently, only the worst case emissions are reported. 														

2.2 Connection Diagram of Test System

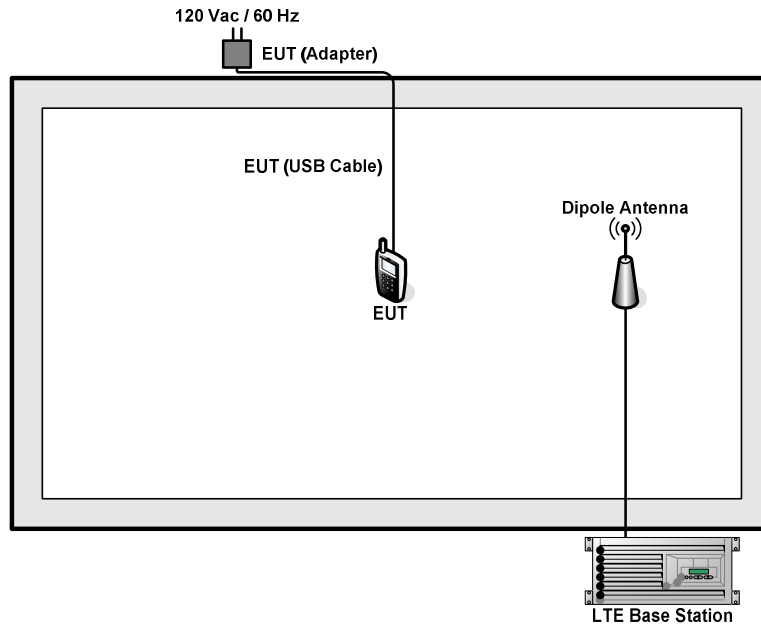

2.3 Support Unit used in test configuration and system

Item	Equipment	Trade Name	Model No.	FCC ID	Data Cable	Power Cord
1.	LTE Base Station	Anritsu	MT8820C	N/A	N/A	Unshielded, 1.8 m
2.	DC Power Supply	GW INSTRON	GPS-3030D	N/A	N/A	Unshielded, 1.8 m

2.4 Measurement Results Explanation Example

For all conducted test items:

The offset level is set in the spectrum analyzer to compensate the RF cable loss between EUT conducted output port and spectrum analyzer. With the offset compensation, the spectrum analyzer reading level is exactly the EUT RF output level.

Example:

The spectrum analyzer offset is derived from RF cable loss.

$Offset = RF\ cable\ loss.$

The following shows an offset computation example with RF cable loss 5.5dB.

Example :

$Offset(dB) = RF\ cable\ loss(dB).$
 $= 5.5 (dB)$



2.5 Frequency List of Low/Middle/High Channels

LTE Band 30 Channel and Frequency List				
BW [MHz]	Channel/Frequency(MHz)	Lowest	Middle	Highest
10	Channel	-	27710	-
	Frequency	-	2310	-
5	Channel	27685	27710	27735
	Frequency	2307.5	2310	2312.5

3 Conducted Test Items

3.1 Measuring Instruments

See list of measuring instruments of this test report.

3.2 Test Setup

3.2.1 Conducted Output Power

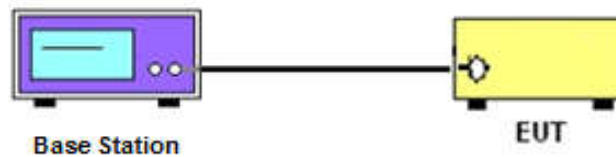

3.2.2 Peak-to-Average Ratio, Occupied / 26dB Bandwidth ,Band-Edge and Conducted Spurious Emission

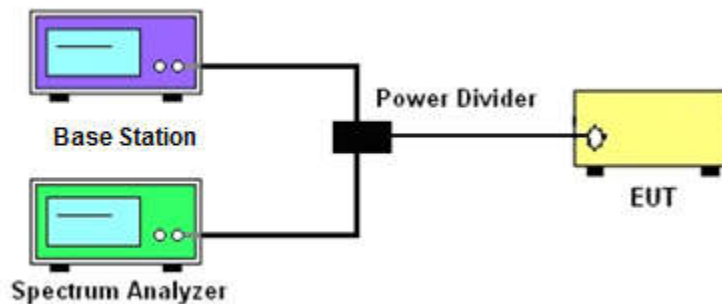

3.2.3 Frequency Stability

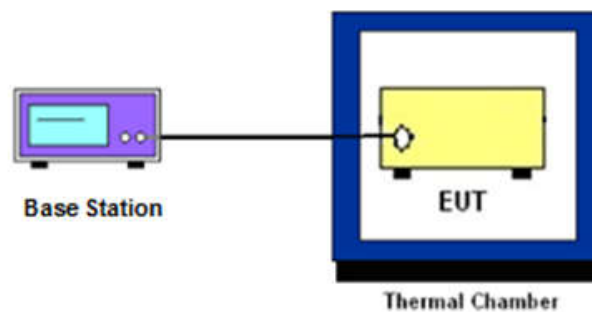

3.3 Test Result of Conducted Test

Please refer to Appendix A.



3.4 Conducted Output Power Measurement

3.4.1 Description of the Conducted Output Power Measurement

A base station simulator was used to establish communication with the EUT. Its parameters were set to transmit the maximum power on the EUT. The measured power in the radio frequency on the transmitter output terminals shall be reported.

3.4.2 Test Procedures

1. The transmitter output port was connected to base station.
2. Set EUT at maximum power through base station.
3. Select lowest, middle, and highest channels for each band and different modulation.

3.5 Peak-to-Average Ratio

3.5.1 Description of the PAR Measurement

Power Complementary Cumulative Distribution Function (CCDF) curves provide a means for characterizing the power peaks of a digitally modulated signal on a statistical basis. A CCDF curve depicts the probability of the peak signal amplitude exceeding the average power level. Most contemporary measurement instrumentation include the capability to produce CCDF curves for an input signal provided that the instrument's resolution bandwidth can be set wide enough to accommodate the entire input signal bandwidth. In measuring transmissions in this band using an average power technique, the peak-to-average ratio (PAR) of the transmission may not exceed 13 dB.

3.5.2 Test Procedures

1. The testing follows FCC KDB 971168 D01 v03 Section 5.7.1.
2. The EUT was connected to spectrum and system simulator via a power divider.
3. Set the CCDF (Complementary Cumulative Distribution Function) option in spectrum analyzer.
4. The highest RF powers were measured and recorded the maximum PAPR level associated with a probability of 0.1 %.
5. Record the deviation as Peak to Average Ratio.



3.6 EIRP Power Density

3.6.1 Description of EIRP Power Density

For mobile and portable stations transmitting in the 2305-2315 MHz band or the 2350-2360 MHz band, the average EIRP must not exceed 50 milliwatts within any 1 megahertz of authorized bandwidth, *except that* for mobile and portable stations compliant with 3GPP LTE standards or another advanced mobile broadband protocol that avoids concentrating energy at the edge of the operating band the average EIRP must not exceed 250 milliwatts within any 5 megahertz of authorized bandwidth but may exceed 50 milliwatts within any 1 megahertz of authorized bandwidth. For mobile and portable stations using time division duplexing (TDD) technology, the duty cycle must not exceed 38 percent in the 2305-2315 MHz and 2350-2360 MHz bands. Mobile and portable stations using FDD technology are restricted to transmitting in the 2305-2315 MHz band. Power averaging shall not include intervals in which the transmitter is off.

3.6.2 Test Procedures

1. Set instrument center frequency to OBW center frequency.
2. Set span to at least 1.5 times the OBW.
3. Set the RBW to the specified reference bandwidth (often 1 MHz).
4. Set VBW $\geq 3 \times$ RBW.
5. Detector = RMS (power averaging).
6. Ensure that the number of measurement points in the sweep $\geq 2 \times$ span/RBW.
7. Sweep time = auto couple.
8. Employ trace averaging (RMS) mode over a minimum of 100 traces.
9. Use the peak marker function to determine the maximum amplitude level within the reference bandwidth (PSD).

3.7 Occupied Bandwidth

3.7.1 Description of Occupied Bandwidth Measurement

The occupied bandwidth is the width of a frequency band such that, below the lower and above the upper frequency limits, the mean powers emitted are each equal to a specified percentage 0.5% of the total mean transmitted power.

The 26dB occupied bandwidth is the width of a frequency band such that, below the lower and above the upper frequency limits, the mean powers emitted are each equal 26 dB.

The 26 dB emission bandwidth(EBW) is defined as the frequency range between two points, one above and one below the carrier frequency, at which the spectral density of the emission is attenuated 26 dB below the maximum in-band spectral density of the modulated signal. Spectral density (power per unit bandwidth) is to be measured with a detector of resolution bandwidth equal to approximately 1.0% of the emission bandwidth.

3.7.2 Test Procedures

1. The EUT was connected to Spectrum Analyzer and Base Station via power divider.
2. The 26dB and 99% occupied bandwidth (BW) of the middle channel for the highest RF powers with full RB sizes were measured.

3.8 Conducted Band Edge Measurement

3.8.1 Description of Conducted Band Edge Measurement

27.53 (a)(4)

For mobile and portable stations operating in the 2305-2315 MHz and 2350-2360 MHz bands:

(i) By a factor of not less than: $43 + 10 \log (P)$ dB on all frequencies between 2305 and 2320 MHz and on all frequencies between 2345 and 2360 MHz that are outside the licensed band(s) of operation, not less than $55 + 10 \log (P)$ dB on all frequencies between 2320 and 2324 MHz and on all frequencies between 2341 and 2345 MHz, not less than $61 + 10 \log (P)$ dB on all frequencies between 2324 and 2328 MHz and on all frequencies between 2337 and 2341 MHz, and not less than $67 + 10 \log (P)$ dB on all frequencies between 2328 and 2337 MHz;

(ii) By a factor of not less than $43 + 10 \log (P)$ dB on all frequencies between 2300 and 2305 MHz, $55 + 10 \log (P)$ dB on all frequencies between 2296 and 2300 MHz, $61 + 10 \log (P)$ dB on all frequencies between 2292 and 2296 MHz, $67 + 10 \log (P)$ dB on all frequencies between 2288 and 2292 MHz, and $70 + 10 \log (P)$ dB below 2288 MHz;

(iii) By a factor of not less than $43 + 10 \log (P)$ dB on all frequencies between 2360 and 2365 MHz, and not less than $70 + 10 \log (P)$ dB above 2365 MHz.

3.8.2 Test Procedures

1. The EUT was connected to Spectrum Analyzer and Base Station via power divider.
2. The band edges of low and high channels were measured with $RBW \geq 1\%$ EBW set in Spectrum Analyzer, while the EUT was transmitting under maximum power.
3. The RF fundamental frequency should be excluded against the limit line in the operating frequency band.
4. The limit line is derived from $43 + 10 \log(P)$ dB below the transmitter power P (Watts)
 $= P(W) - [43 + 10 \log(P)] (dB) = [30 + 10 \log(P)] (dBm) - [43 + 10 \log(P)] (dB) = -13 dBm$.

3.9 Conducted Spurious Emission Measurement

3.9.1 Description of Conducted Spurious Emission Measurement

The power of any emission outside of the authorized operating frequency ranges must be lower than the transmitter power (P) by a factor of at least $70 + 10 \log (P)$ dB.

It is measured by means of a calibrated spectrum analyzer and scanned from 30MHz up to a frequency including its 10th harmonic.

3.9.2 Test Procedures

1. The EUT was connected to spectrum analyzer and base station via power divider.
2. The RF output of EUT was connected to the spectrum analyzer by RF cable and attenuator.
The path loss was compensated to the results for each measurement.
3. The middle channel for the highest RF power within the transmitting frequency was measured.
4. The conducted spurious emission for the whole frequency range was taken.
5. Make the measurement with the spectrum analyzer's RBW = 1MHz, VBW = 3MHz, taking the record of maximum spurious emission.
6. The RF fundamental frequency should be excluded against the limit line in the operating frequency band.
7. The limit line is derived from $70 + 10\log(P)$ dB below the transmitter power P(Watts)
 $= P(W) - [70 + 10\log(P)]$ (dB)
 $= [30 + 10\log(P)]$ (dBm) - $[70 + 10\log(P)]$ (dB)
 $= -40$ dBm.

3.10 Frequency Stability Measurement

3.10.1 Description of Frequency Stability Measurement

The frequency stability shall be measured by variation of ambient temperature and variation of primary supply voltage to ensure that the fundamental emission stays within the authorized frequency block. The frequency stability of the transmitter shall be maintained within $\pm 0.00025\%$ ($\pm 2.5\text{ppm}$) of the center frequency.

3.10.2 Test Procedures for Temperature Variation

1. The EUT was set up in the thermal chamber and connected with the base station.
2. With power OFF, the temperature was decreased to -30°C and the EUT was stabilized before testing. Power was applied and the maximum change in frequency was recorded within one minute.
3. With power OFF, the temperature was raised in 10°C step up to 50°C . The EUT was stabilized at each step for at least half an hour. Power was applied and the maximum frequency change was recorded within one minute.

3.10.3 Test Procedures for Voltage Variation

1. The EUT was placed in a temperature chamber at $25\pm 5^{\circ}\text{C}$ and connected with the base station.
2. The power supply voltage to the EUT was varied from 85% to 115% of the nominal value measured at the input to the EUT.
3. The variation in frequency was measured for the worst case.

4 Radiated Test Items

4.1 Measuring Instruments

See list of measuring instruments of this test report.

4.2 Test Setup

4.2.1 For radiated test from 30MHz to 1GHz

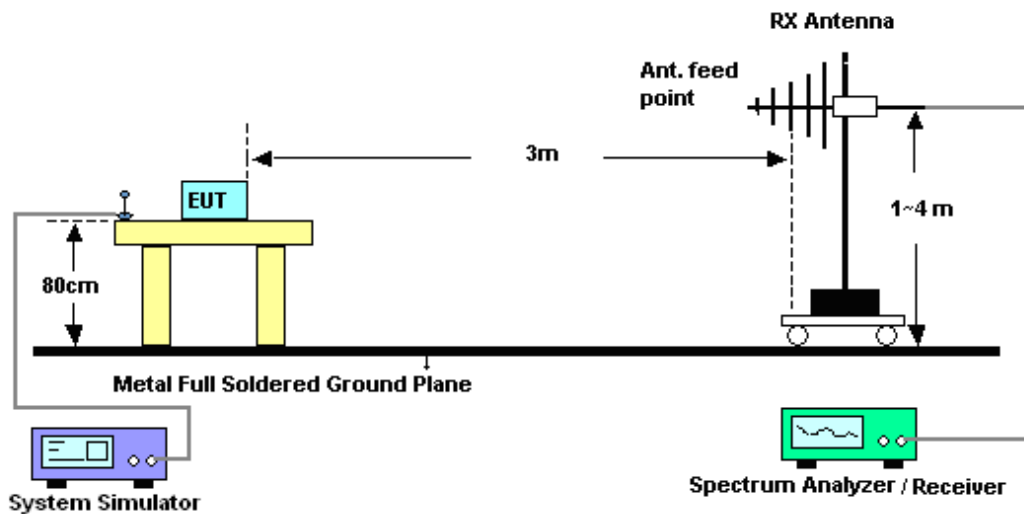

4.2.2 For radiated test above 1GHz

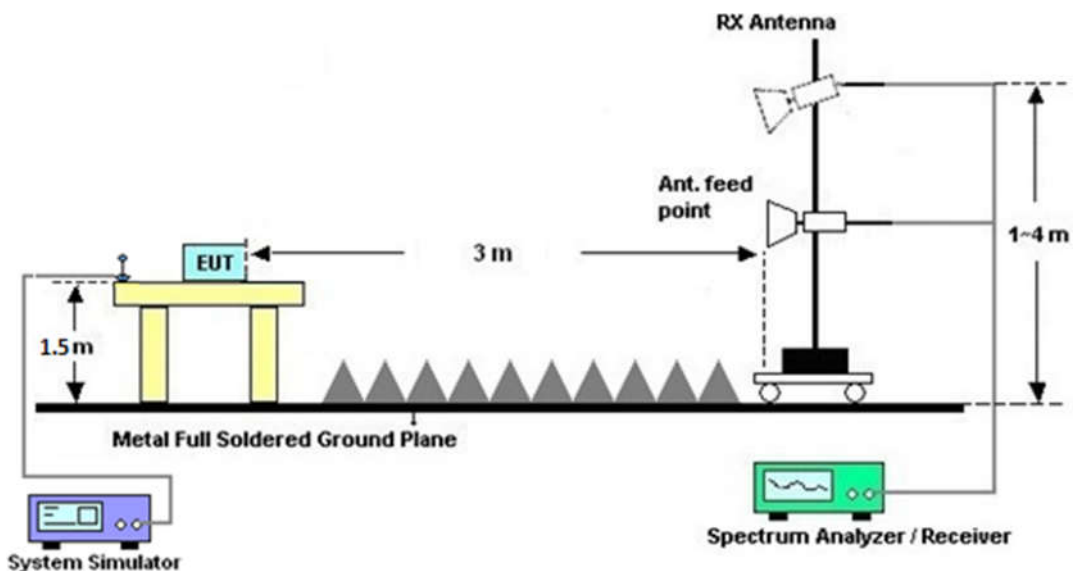

4.3 Test Result of Radiated Test

Please refer to Appendix B.



4.4 Radiated Spurious Emission Measurement

4.4.1 Description of Radiated Spurious Emission

The radiated spurious emission was measured by substitution method according to ANSI/TIA-603-E. The power of any emission outside of the authorized operating frequency ranges must be attenuated below the transmitter power (P) by a factor of at least $70 + 10 \log (P)$ dB.

4.4.2 Test Procedures

1. The EUT was placed on a turntable with 0.8 meter for frequency below 1GHz and 1.5 meter for frequency above 1GHz respectively above ground.
2. The EUT was set 3 meters from the receiving antenna, which was mounted on the antenna tower.
3. The table was rotated 360 degrees to determine the position of the highest spurious emission.
4. The height of the receiving antenna is varied between one meter and four meters to search the maximum spurious emission for both horizontal and vertical polarizations.
5. Make the measurement with the spectrum analyzer's RBW = 1MHz, VBW = 3MHz, Sweep = 500ms, Taking the record of maximum spurious emission.
6. A horn antenna was substituted in place of the EUT and was driven by a signal generator.
7. Tune the output power of signal generator to the same emission level with EUT maximum spurious emission.
8. Taking the record of output power at antenna port.
9. Repeat step 7 to step 8 for another polarization.
10. The RF fundamental frequency should be excluded against the limit line in the operating frequency band.
The limit line is derived from $70 + 10\log(P)$ dB below the transmitter power P(Watts)
 $= P(W) - [70 + 10\log(P)]$ (dB)
 $= [30 + 10\log(P)]$ (dBm) - $[70 + 10\log(P)]$ (dB)
 $= -40$ dBm.
11. EIRP (dBm) = S.G. Power – Tx Cable Loss + Tx Antenna Gain



5 List of Measuring Equipment

Instrument	Manufacturer	Model No.	Serial No.	Characteristics	Calibration Date	Test Date	Due Date	Remark
Spectrum Analyzer	R&S	FSV40	101040	10Hz~40GHz	Aug. 08, 2017	Aug. 19, 2017	Aug. 07, 2018	Conducted (TH01-KS)
Thermal Chamber	Ten Billion	TTC-B3S	TBN-960502	-40~+150°C	Oct. 13, 2016	Aug. 19, 2017	Oct. 12, 2017	Conducted (TH01-KS)
Bilog Antenna	TESEQ	CBL6111D&00800N1D0	41912&05	30MHz to 1GHz	Jan. 07, 2017	Oct. 02, 2017~ Oct. 11, 2017	Jan. 06, 2018	Radiation (03CH15-HY)
Horn Antenna	SCHWARZBECK	BBHA 9120D	BBHA 9120 D 1212	1G~18GHz	Mar. 17, 2017	Oct. 02, 2017~ Oct. 11, 2017	Mar. 16, 2018	Radiation (03CH15-HY)
SHF-EHF Horn Antenna	SCHWARZBECK	BBHA 9170	BBHA917058 4	18GHz- 40GHz	Nov. 08, 2016	Oct. 02, 2017~ Oct. 11, 2017	Nov. 07, 2017	Radiation (03CH15-HY)
Amplifier	SONOMA	310N	363440	9kHz~1GHz	Nov. 09, 2016	Oct. 02, 2017~ Oct. 11, 2017	Nov. 08, 2017	Radiation (03CH15-HY)
Preamplifier	MITEQ	AMF-7D-00 101800	2025787	1GHZ~18GHZ	Feb. 13, 2017	Oct. 02, 2017~ Oct. 11, 2017	Feb. 12, 2018	Radiation (03CH15-HY)
Preamplifier	MITEQ	TTA 1840-35-HG	1887435	18GHz ~ 40GHz	Oct. 13, 2016	Oct. 02, 2017~ Oct. 11, 2017	Oct. 12, 2017	Radiation (03CH15-HY)
Preamplifier	Keysight	83017A	MY53270195	1GHz~26.5GHz	Aug. 21, 2017	Oct. 02, 2017~ Oct. 11, 2017	Aug. 20, 2018	Radiation (03CH15-HY)
Spectrum Analyzer	Agilent	N9030A	MY52350276	3Hz~44GHz	Mar. 23, 2017	Oct. 02, 2017~ Oct. 11, 2017	Mar. 22, 2018	Radiation (03CH15-HY)
Controller	ChainTek	3000-1	N/A	Control Turn table & Ant Mast	NCR	Oct. 02, 2017~ Oct. 11, 2017	NCR	Radiation (03CH15-HY)
Antenna Mast	ChainTek	MBS-520-1	N/A	1m~4m	NCR	Oct. 02, 2017~ Oct. 11, 2017	NCR	Radiation (03CH15-HY)
Turn Table	ChainTek	T-200-S-1	N/A	0~360 Degree	NCR	Oct. 02, 2017~ Oct. 11, 2017	NCR	Radiation (03CH15-HY)

NCR: No Calibration Required



6 Uncertainty of Evaluation

Uncertainty of Radiated Emission Measurement (30 MHz ~ 1000 MHz)

Measuring Uncertainty for a Level of Confidence of 95% ($U = 2Uc(y)$)	3.4dB
---	-------

Uncertainty of Radiated Emission Measurement (1 GHz ~ 18 GHz)

Measuring Uncertainty for a Level of Confidence of 95% ($U = 2Uc(y)$)	3.7dB
---	-------

Uncertainty of Radiated Emission Measurement (18 GHz ~ 40 GHz)

Measuring Uncertainty for a Level of Confidence of 95% ($U = 2Uc(y)$)	4.0dB
---	-------



Appendix A. Test Results of Conducted Test

Conducted Output Power(Average power)

LTE Band 30 Maximum Average Power [dBm]						
BW [MHz]	RB Size	RB Offset	Mod	Lowest	Middle	Highest
5	1	0	QPSK	21.61	21.53	21.49
5	1	12		21.37	21.31	21.33
5	1	24		21.41	21.46	21.45
5	12	0		20.50	20.53	20.47
5	12	7		20.47	20.54	20.39
5	12	13		20.39	20.52	20.38
5	25	0		20.40	20.47	20.45
5	1	0	16-QAM	20.89	20.93	20.88
5	1	12		20.70	20.70	20.69
5	1	24		20.63	20.78	20.69
5	12	0		19.50	19.58	19.51
5	12	7		19.45	19.53	19.49
5	12	13		19.42	19.52	19.45
5	25	0		19.43	19.56	19.48
10	1	0	QPSK	-	21.71	-
10	1	25			21.38	
10	1	49			21.62	
10	25	0			20.59	
10	25	12			20.52	
10	25	25			20.51	
10	50	0			20.47	
10	1	0	16-QAM	-	20.94	-
10	1	25			20.63	
10	1	49			20.71	
10	25	0			19.42	
10	25	12			19.49	
10	25	25			19.51	
10	50	0			19.43	



Peak-to-Average Ratio

Mode	LTE Band 30 / 10MHz				
Mod.	QPSK		16QAM		Limit: 13dB
RB Size	1RB	Full RB	1RB	Full RB	Result
Lowest CH	-	-	-	-	PASS
Middle CH	4.84	4.84	5.59	5.91	
Highest CH	-	-	-	-	



LTE Band 30 / 10MHz / QPSK

Middle Channel / 1RB

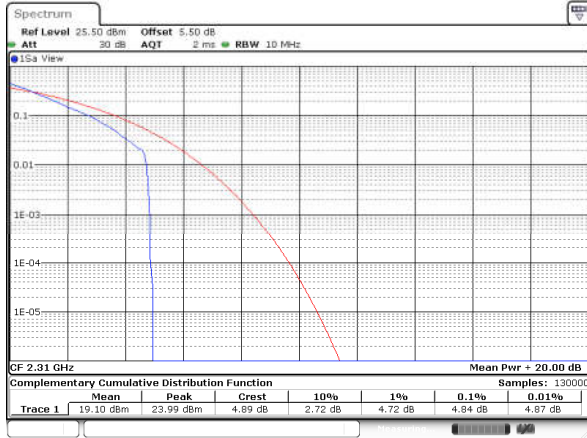

Date: 19 AUG 2017 10:45:41

Middle Channel / Full RB

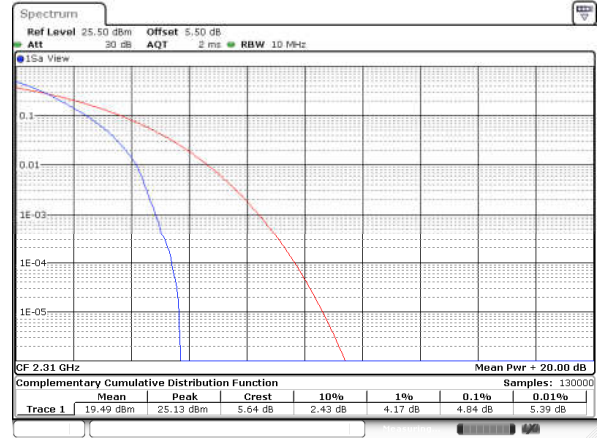

Date: 19 AUG 2017 10:44:15

LTE Band 30 / 10MHz / 16QAM

Middle Channel / 1RB

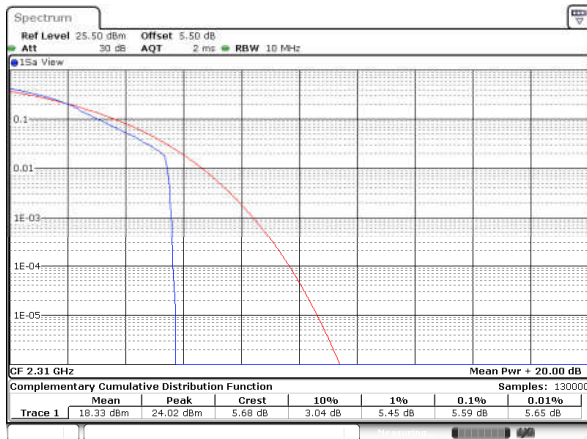

Date: 19 AUG 2017 10:45:29

Middle Channel / Full RB

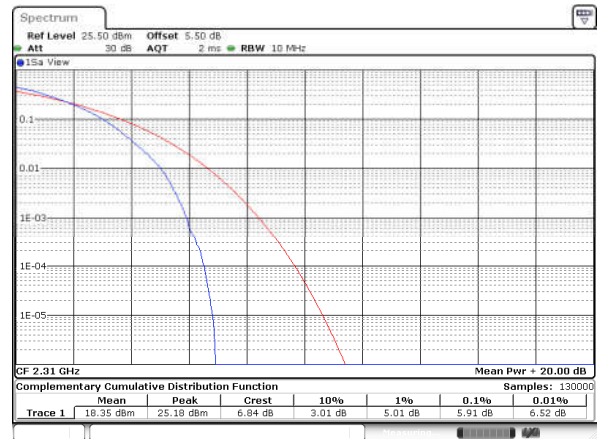

Date: 19 AUG 2017 10:44:27



EIRP Power Density

Mode	LTE Band 30 : Conducted Power Density (dBm/5MHz)							
BW	5MHz		10MHz					
Mod.	QPSK	16QAM	QPSK	16QAM				
Lowest CH	21.60	21.00						
Middle CH	21.94	21.00	21.95	20.97				
Highest CH	21.70	20.77						

Mode	LTE Band 30 : EIRP Power Density (dBm/5MHz)							
BW	5MHz		10MHz					
Mod.	QPSK	16QAM	QPSK	16QAM				
Lowest CH	19.60	19.00						
Middle CH	19.94	19.00	19.95	18.97				
Highest CH	19.70	18.77						
Antenna Gain	-2.0 dBi							
Limit	250mW / 5MHz = 24dBm / 5MHz							
Result	Pass							



LTE Band 30 / 5MHz

Lowest Channel / 5MHz / 1RB0 / QPSK

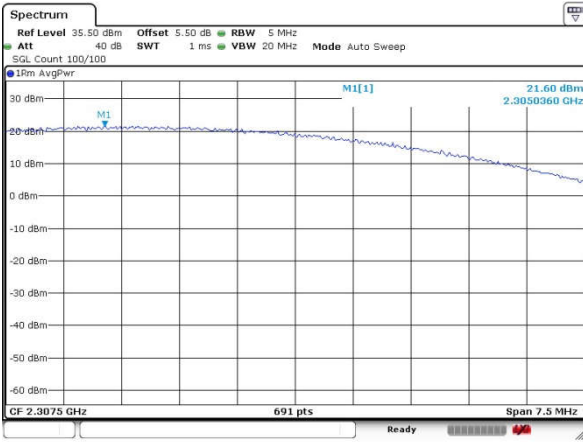

Date: 19 AUG 2017 10:49:52

Lowest Channel / 5MHz / 1RB0 / 16QAM

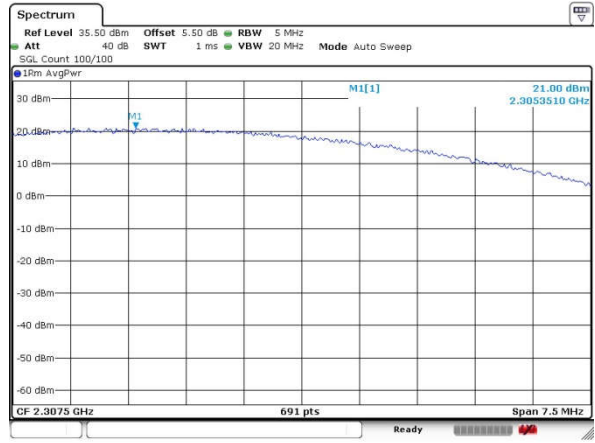

Date: 19 AUG 2017 10:50:59

Middle Channel / 5MHz / 1RB0 / QPSK

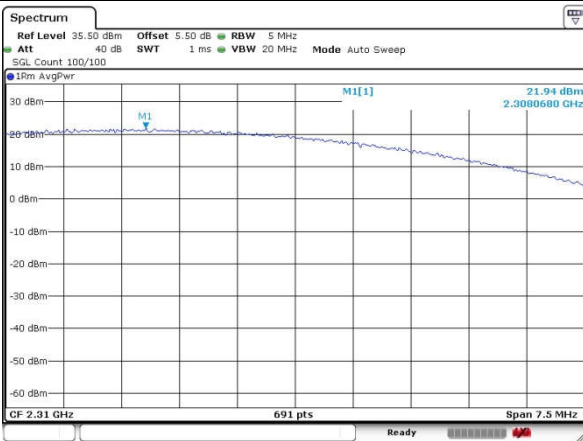

Date: 19 AUG 2017 10:52:58

Middle Channel / 5MHz / 1RB0 / 16QAM

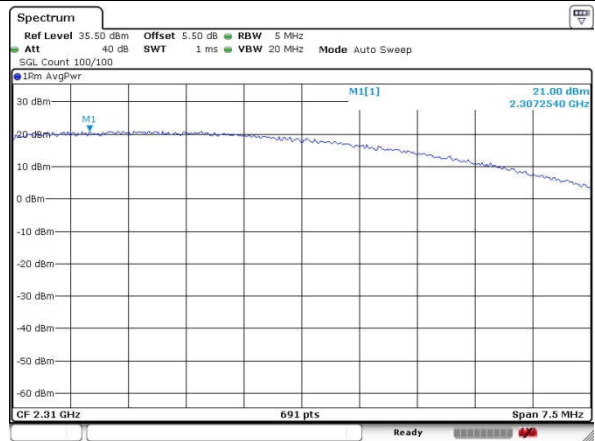

Date: 19 AUG 2017 10:52:41

Highest Channel / 5MHz / 1RB0 / QPSK

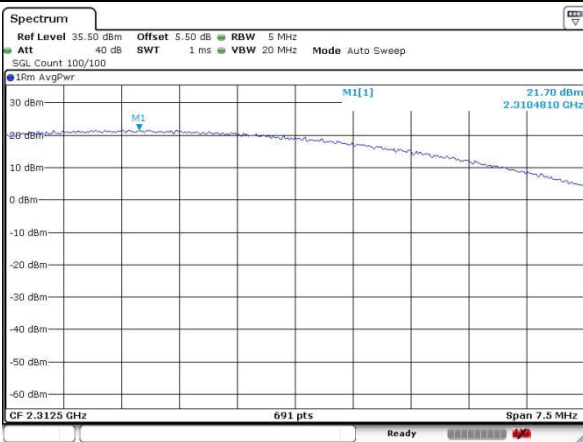

Date: 19 AUG 2017 10:53:34

Highest Channel / 5MHz / 1RB0 / 16QAM

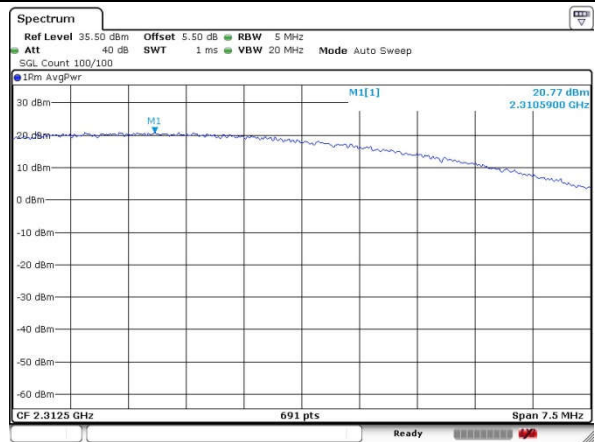

Date: 19 AUG 2017 10:54:00



26dB Bandwidth

Mode	LTE Band 30 : 26dB BW(MHz)							
BW	5MHz		10MHz					
Mod.	QPSK	16QAM	QPSK	16QAM				
Lowest CH	4.97	4.85						
Middle CH	4.88	4.94	9.79	9.63				
Highest CH	4.97	4.97						



LTE Band 30

Lowest Channel / 5MHz / QPSK

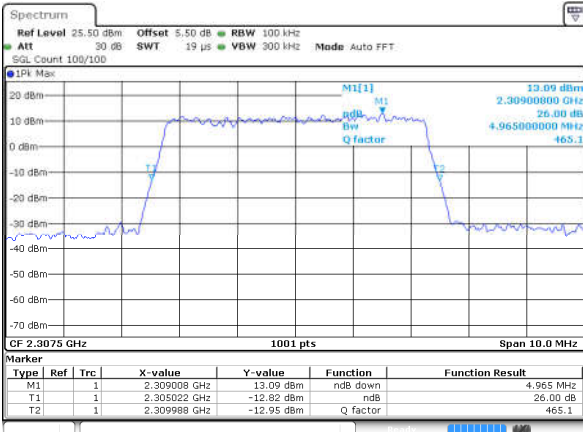

Date: 19 AUG 2017 09:44:11

Lowest Channel / 5MHz / 16QAM

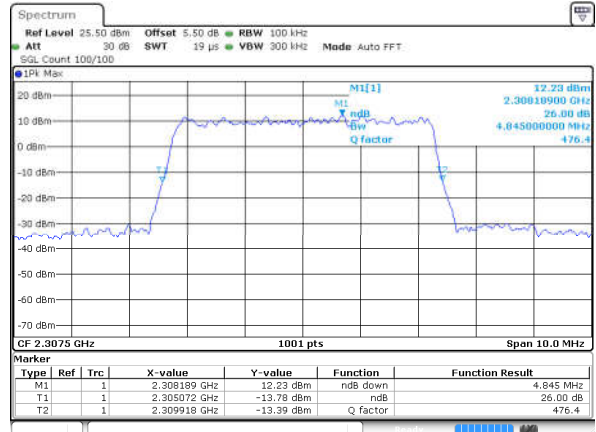

Date: 19 AUG 2017 09:43:28

Middle Channel / 5MHz / QPSK

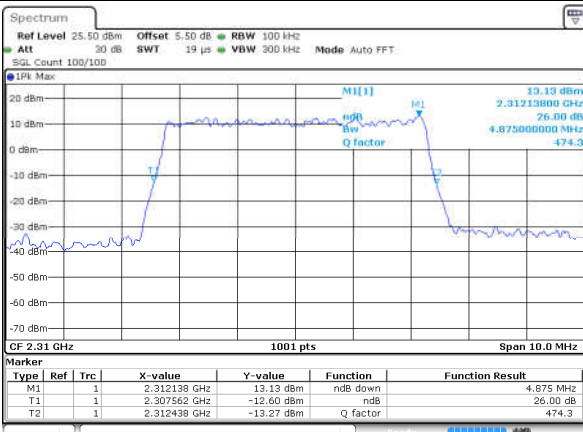

Date: 19 AUG 2017 09:45:12

Middle Channel / 5MHz / 16QAM

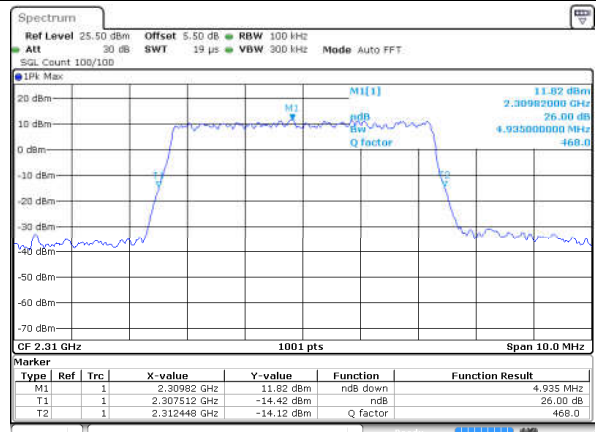

Date: 19 AUG 2017 09:45:43

Highest Channel / 5MHz / QPSK

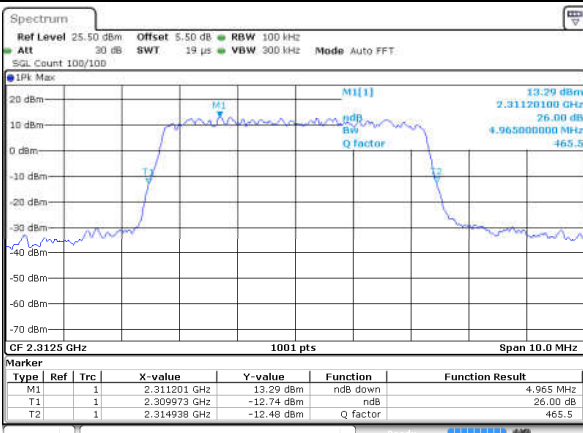

Date: 19 AUG 2017 09:46:32

Highest Channel / 5MHz / 16QAM

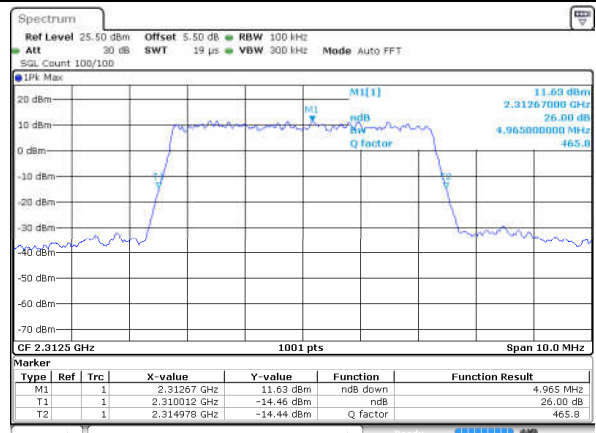

Date: 19 AUG 2017 09:46:55



LTE Band 30

Middle Channel / 10MHz / QPSK

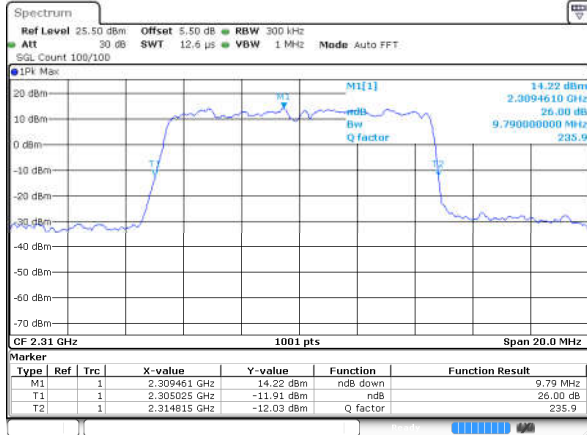

Date: 19 AUG 2017 10:33:19

Middle Channel / 10MHz / 16QAM

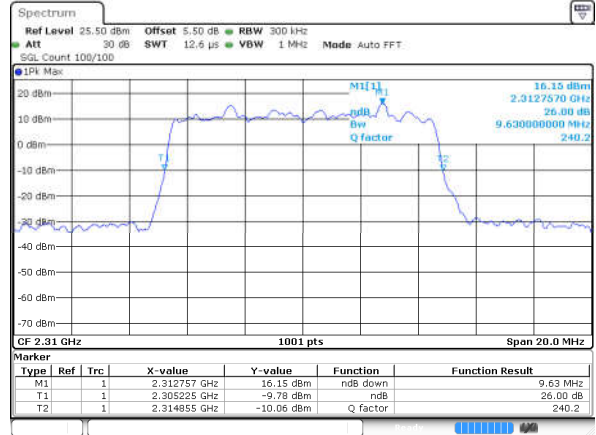

Date: 19 AUG 2017 10:33:53



Occupied Bandwidth

Mode	LTE Band 30 : 99%OBW(MHz)								
BW	5MHz		10MHz						
Mod.	QPSK	16QAM	QPSK	16QAM					
Lowest CH	4.45	4.50	-	-					
Middle CH	4.48	4.47	8.99	8.91					
Highest CH	4.48	4.51	-	-					



LTE Band 30

Lowest Channel / 5MHz / QPSK

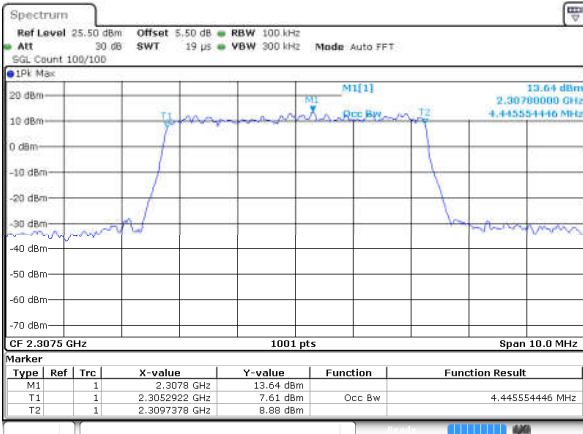

Date: 19 AUG 2017 09:36:20

Lowest Channel / 5MHz / 16QAM

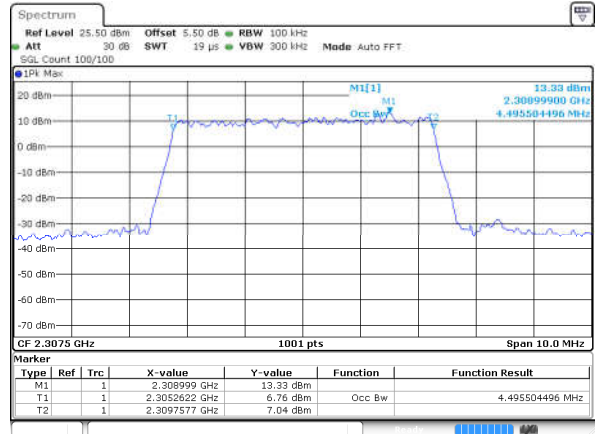

Date: 19 AUG 2017 09:42:28

Middle Channel / 5MHz / QPSK

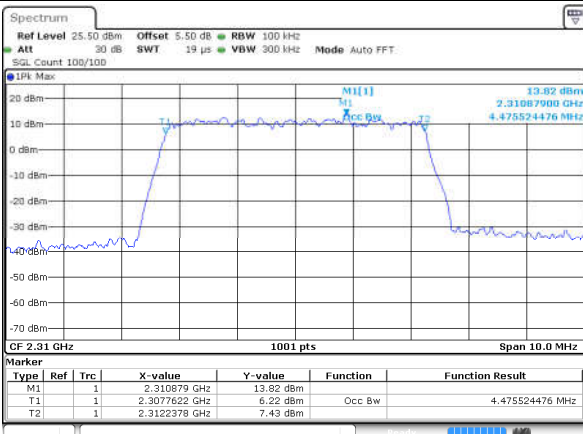

Date: 19 AUG 2017 09:45:03

Middle Channel / 5MHz / 16QAM

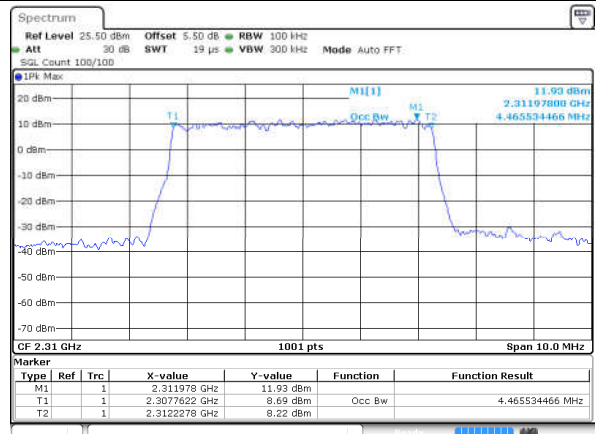

Date: 19 AUG 2017 09:45:32

Highest Channel / 5MHz / QPSK

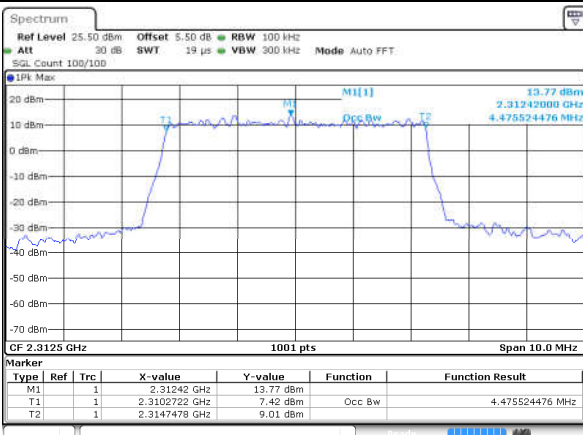

Date: 19 AUG 2017 09:46:23

Highest Channel / 5MHz / 16QAM

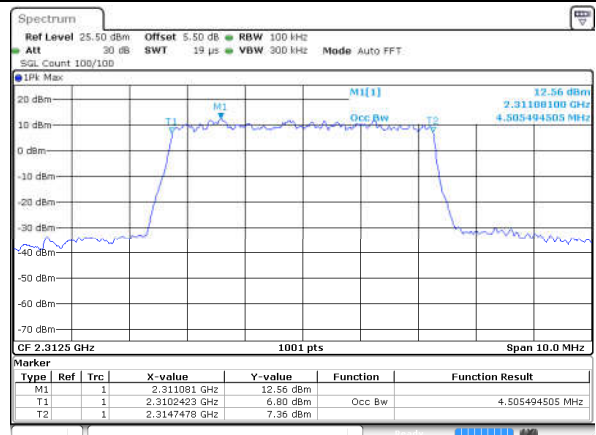

Date: 19 AUG 2017 09:46:45



LTE Band 30

Middle Channel / 10MHz / QPSK

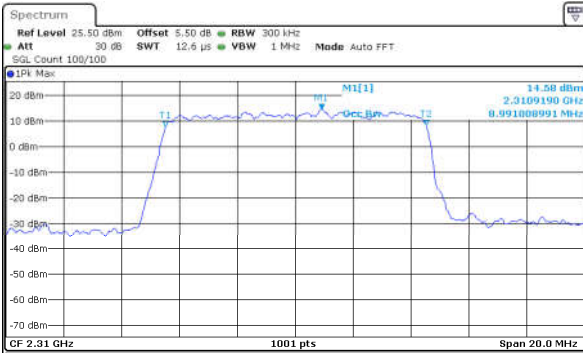

Type	Ref	Trc	X-value	Y-value	Function	Function Result
M1	1		2.310919 GHz	14.58 dBm		
T1	1		2.3055245 GHz	7.99 dBm	Occ Bw	8.991008991 MHz
T2	1		2.3145155 GHz	8.36 dBm		

Date: 19 AUG 2017 10:33:30

Middle Channel / 10MHz / 16QAM

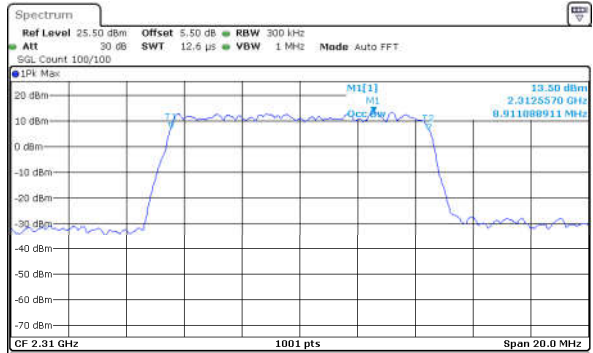

Type	Ref	Trc	X-value	Y-value	Function	Function Result
M1	1		2.312557 GHz	13.50 dBm		
T1	1		2.3055445 GHz	7.52 dBm	Occ Bw	8.911008911 MHz
T2	1		2.3144555 GHz	6.55 dBm		

Date: 19 AUG 2017 10:33:41





Conducted Band Edge

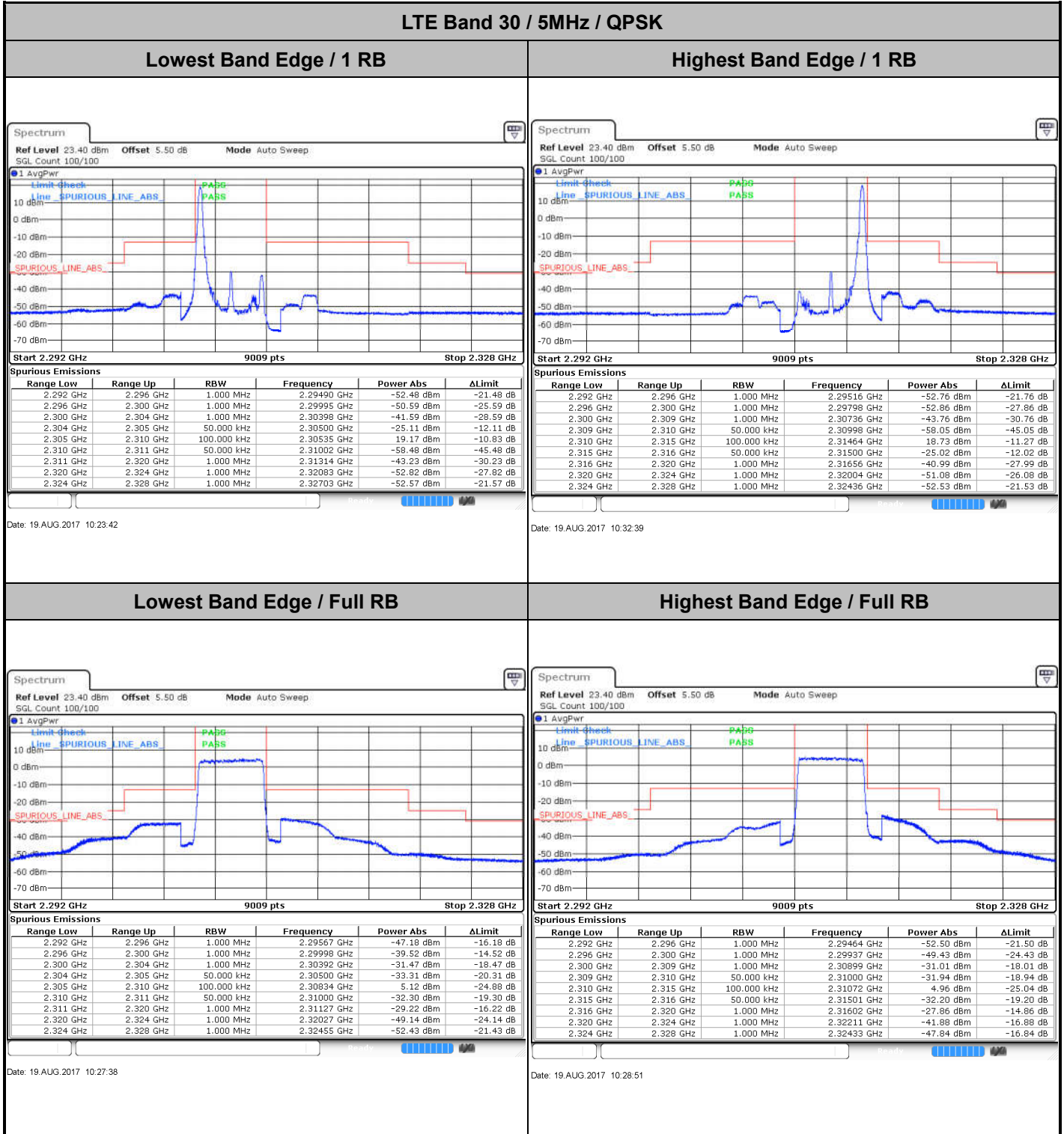



LTE Band 30 / 5MHz / 16QAM

Lowest Band Edge / 1RB

Highest Band Edge / 1 RB

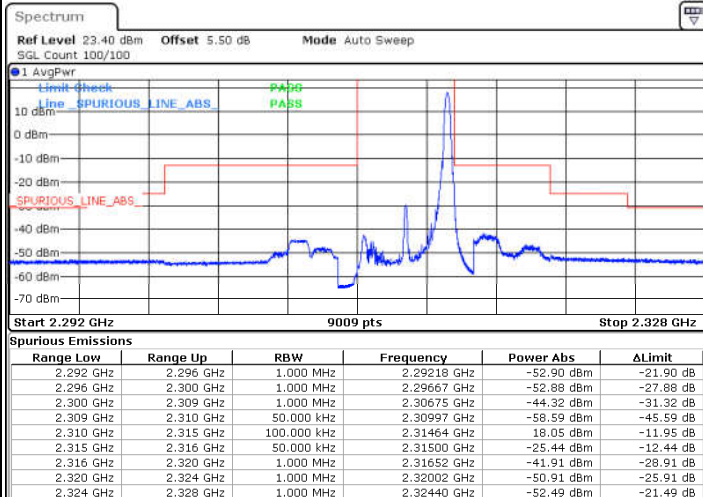
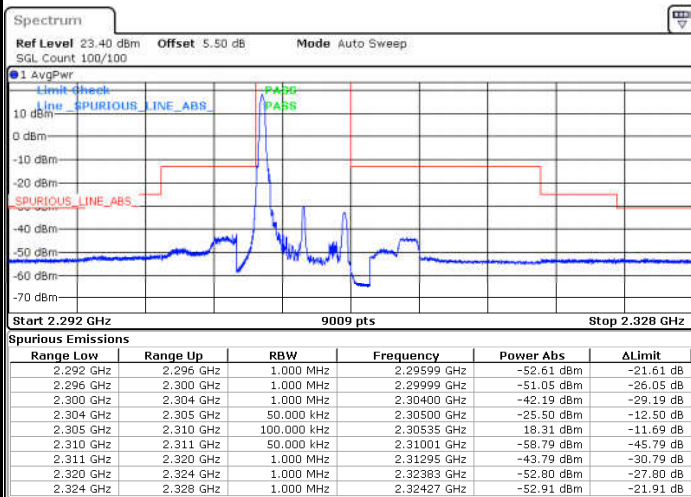

Date: 19 AUG 2017 10:24:21

Date: 19 AUG 2017 10:31:59

Lowest Band Edge / Full RB

Highest Band Edge / Full RB

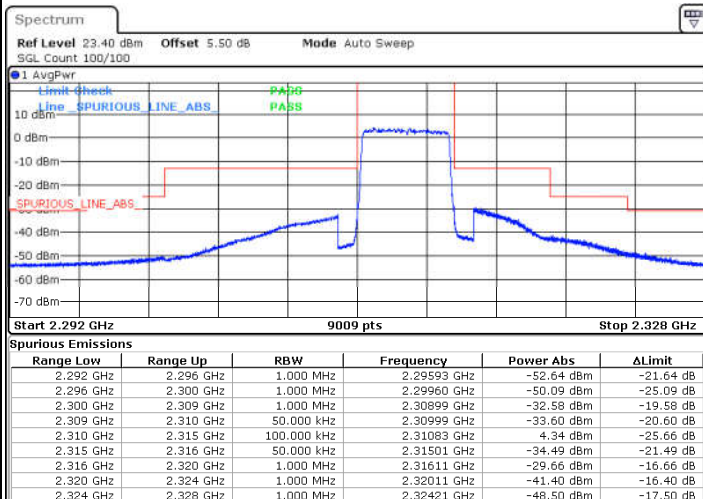
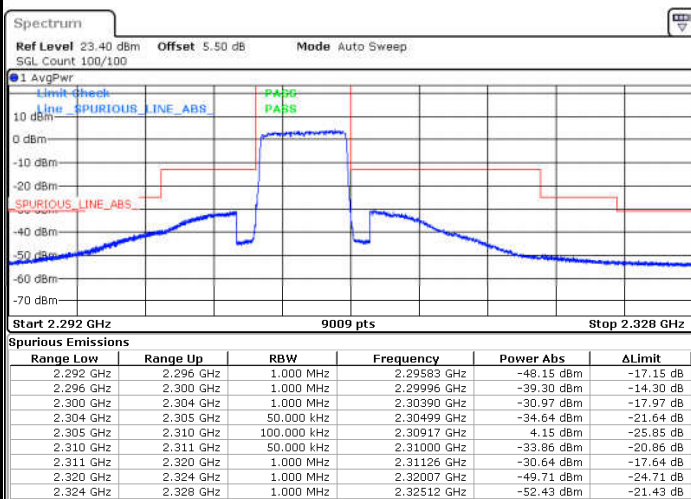

Date: 19 AUG 2017 10:27:01

Date: 19 AUG 2017 10:29:41



LTE Band 30 / 10MHz / QPSK

Lowest Band Edge / 1 RB

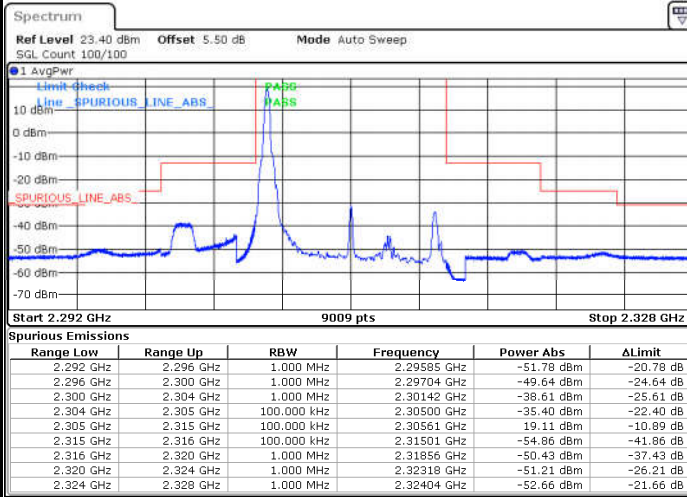

Date: 19.AUG.2017 10:37:47

Highest Band Edge / 1 RB

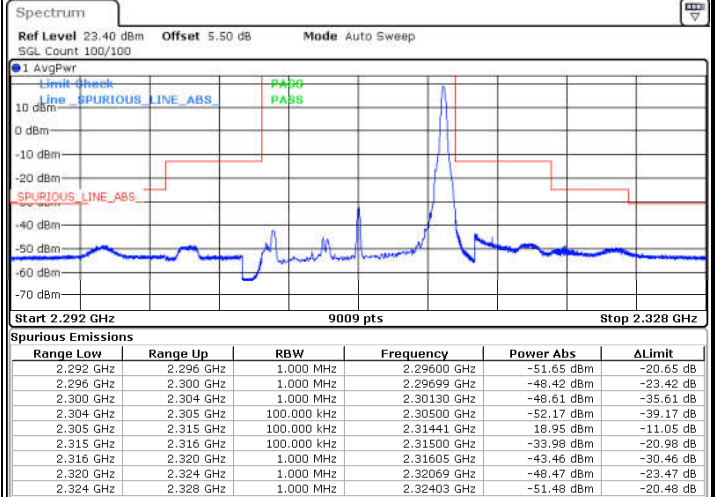

Date: 19.AUG.2017 10:40:42

Band Edge / Full RB

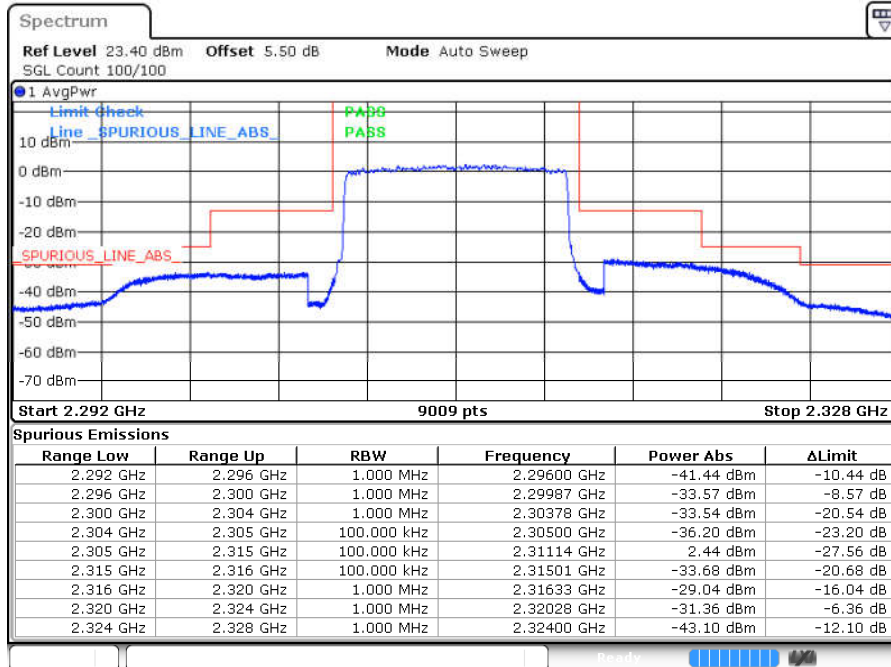

Date: 19.AUG.2017 10:41:29



LTE Band 30 / 10MHz / 16QAM

Lowest Band Edge / 1 RB

Highest Band Edge / 1 RB

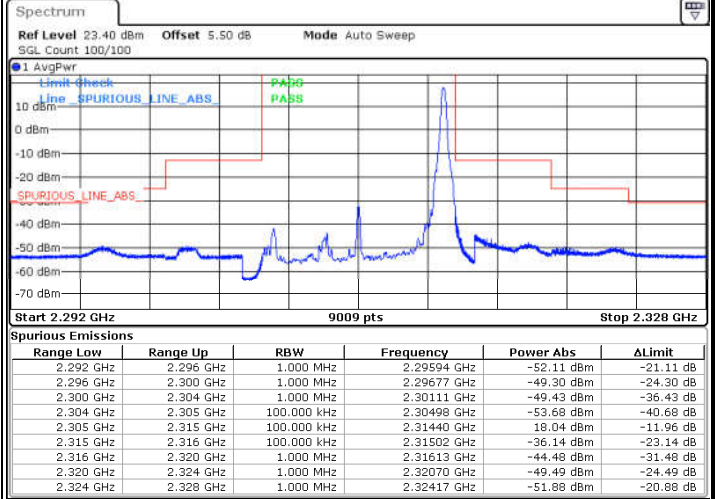
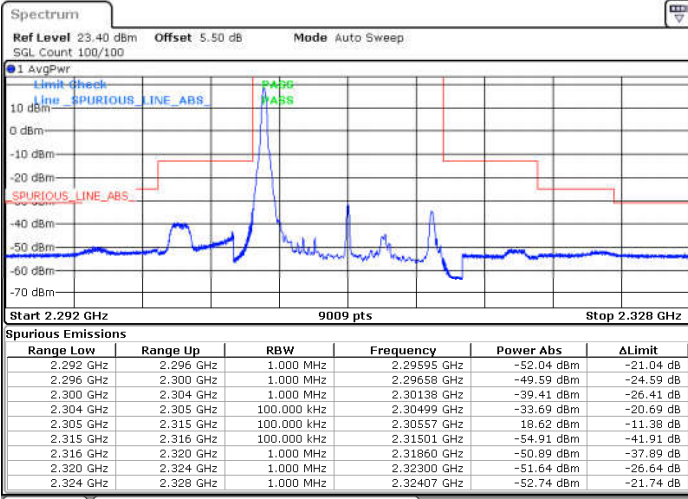

Date: 19.AUG.2017 10:38:14

Date: 19.AUG.2017 10:40:16

Band Edge / Full RB

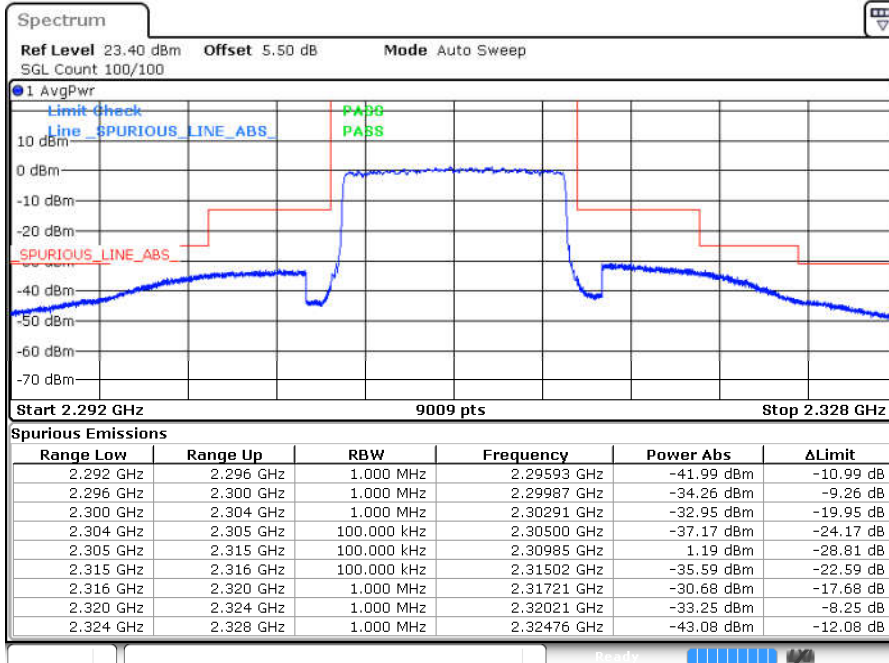

Date: 19.AUG.2017 10:42:16



Conducted Spurious Emission

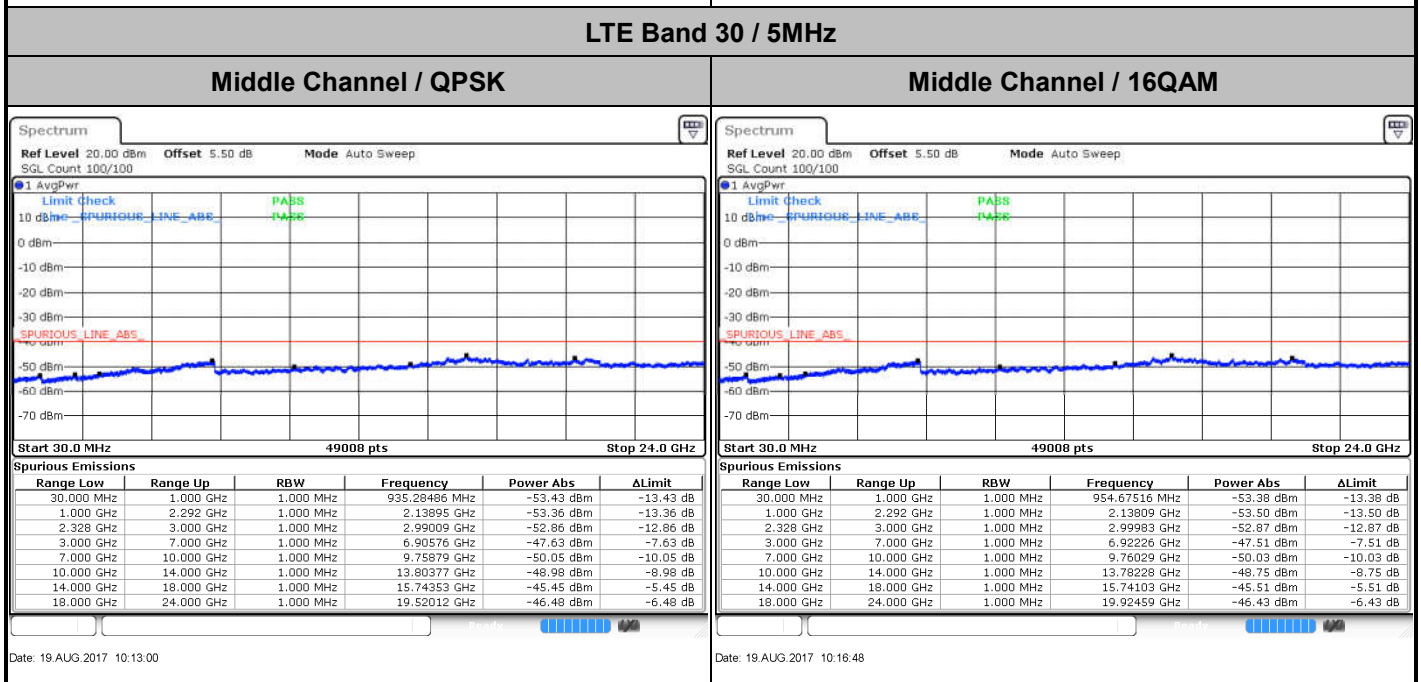
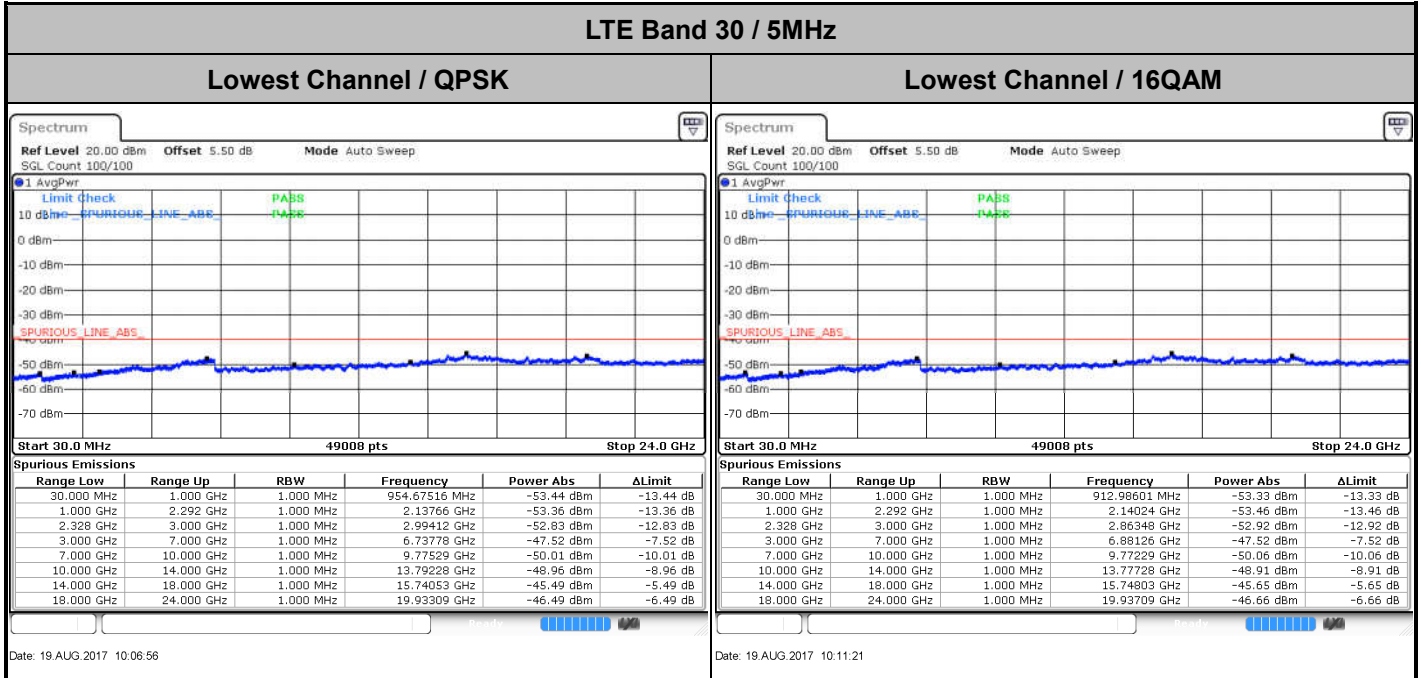

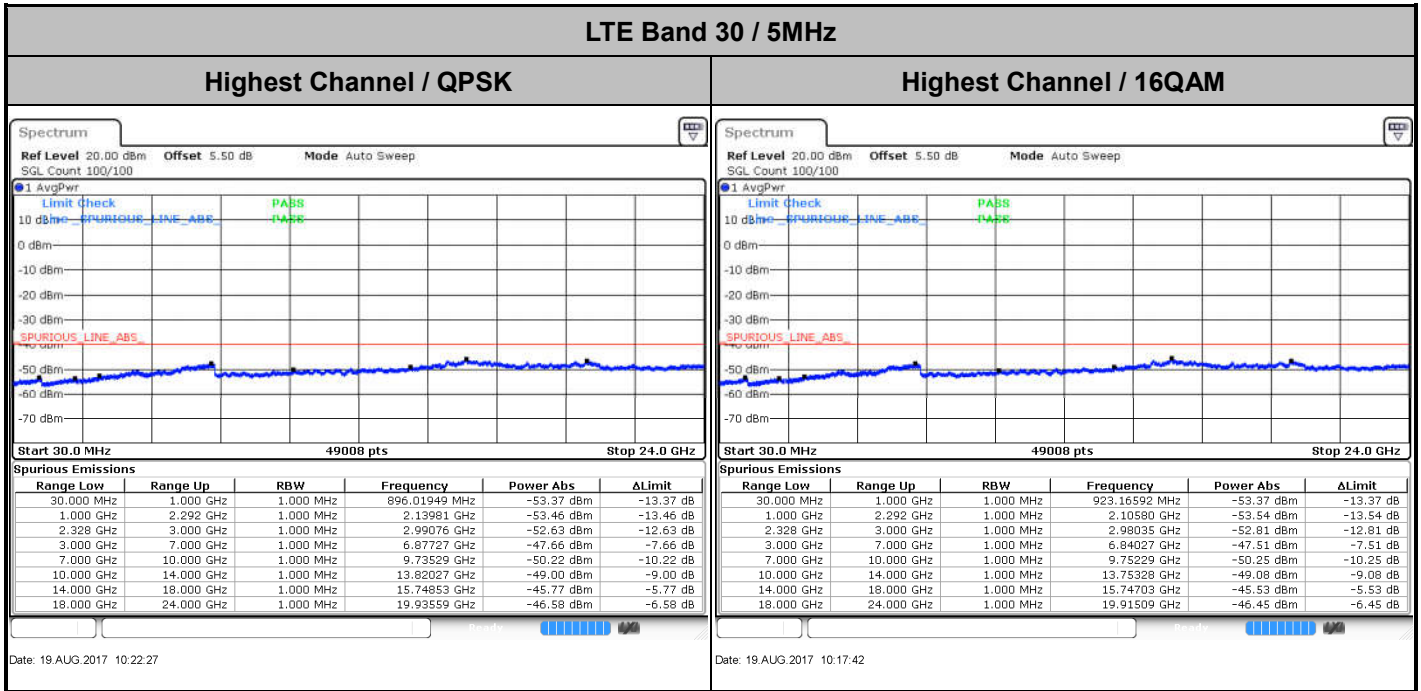



Frequency Stability

Test Conditions		LTE Band 30 (QPSK) / Middle Channel	Limit
Temperature (°C)	Voltage (Volt)	BW 10MHz	Note 2.
		Deviation (ppm)	Result
50	Normal Voltage	0.0007	PASS
40	Normal Voltage	0.0002	
30	Normal Voltage	0.0016	
20(Ref.)	Normal Voltage	0.0000	
10	Normal Voltage	0.0013	
0	Normal Voltage	0.0017	
-10	Normal Voltage	0.0016	
-20	Normal Voltage	0.0003	
-30	Normal Voltage	0.0001	
20	Maximum Voltage	0.0017	
20	Normal Voltage	0.0000	
20	Battery End Point	0.0015	

Note:

- 1. Normal Voltage =3.7 V. ; Battery End Point (BEP) =3.5 V. ; Maximum Voltage =4.2 V.
- 2. Note: The frequency fundamental emissions stay within the authorized frequency block.



Appendix B. Test Results of Radiated Test

Radiated Spurious Emission

LTE Band 30 / 5MHz / QPSK / RB Size 1 Offset 0									
Channel	Frequency (MHz)	EIRP (dBm)	Limit (dBm)	Over Limit (dB)	SPA Reading (dBm)	S.G. Power (dBm)	TX Cable loss (dB)	TX Antenna Gain (dBi)	Polarization (H/V)
Lowest	4610	-57.00	-40	-17.00	-77.09	-68.29	0.71	12.00	H
	6915	-53.39	-40	-13.39	-76.74	-63.48	0.93	11.02	H
	9221	-47.52	-40	-7.52	-76.56	-58.45	1.09	12.02	H
	11526	-44.23	-40	-4.23	-74.15	-54.51	1.21	11.49	H
	4610	-56.21	-40	-16.21	-77.51	-67.5	0.71	12.00	V
	6915	-52.74	-40	-12.74	-76.87	-62.83	0.93	11.02	V
	9221	-48.13	-40	-8.13	-76.6	-59.06	1.09	12.02	V
	11526	-45.27	-40	-5.27	-75.35	-55.55	1.21	11.49	V
Middle	4615	-56.95	-40	-16.95	-77.07	-68.24	0.71	12.00	H
	6923	-53.41	-40	-13.41	-76.75	-63.5	0.93	11.02	H
	9231	-47.75	-40	-7.75	-76.78	-58.67	1.09	12.02	H
	11538	-44.48	-40	-4.48	-74.42	-54.8	1.21	11.53	H
	4615	-55.84	-40	-15.84	-77.16	-67.13	0.71	12.00	V
	6923	-52.53	-40	-12.53	-76.65	-62.62	0.93	11.02	V
	9231	-48.52	-40	-8.52	-76.98	-59.44	1.09	12.02	V
	11538	-45.48	-40	-5.48	-75.56	-55.8	1.21	11.53	V
Highest	4620	-56.86	-40	-16.86	-76.98	-68.15	0.71	12.00	H
	6930	-53.18	-40	-13.18	-76.62	-63.26	0.93	11.01	H
	9241	-47.47	-40	-7.47	-76.51	-58.39	1.09	12.01	H
	4620	-55.89	-40	-15.89	-77.21	-67.18	0.71	12.00	V
	6930	-52.53	-40	-12.53	-76.74	-62.61	0.93	11.01	V
	9241	-47.80	-40	-7.80	-76.24	-58.71	1.09	12.01	V

Remark: Spurious emissions within 30-1000MHz were found more than 20dB below limit line.



LTE Band 30 / 10MHz / QPSK / RB Size 1 Offset 0									
Channel	Frequency (MHz)	EIRP (dBm)	Limit (dBm)	Over Limit (dB)	SPA Reading (dBm)	S.G. Power (dBm)	TX Cable loss (dB)	TX Antenna Gain (dBi)	Polarization (H/V)
Middle	4611	-57.54	-40	-17.54	-77.63	-68.83	0.71	12.00	H
	6916	-52.42	-40	-12.42	-75.77	-62.51	0.93	11.02	H
	9222	-47.61	-40	-7.61	-76.66	-58.54	1.09	12.02	H
	11527	-44.21	-40	-4.21	-74.13	-54.5	1.21	11.49	H
	4611	-56.13	-40	-16.13	-77.43	-67.42	0.71	12.00	V
	6916	-52.70	-40	-12.70	-76.83	-62.79	0.93	11.02	V
	9222	-48.47	-40	-8.47	-76.94	-59.4	1.09	12.02	V
	11527	-45.28	-40	-5.28	-75.36	-55.57	1.21	11.49	V

Remark: Spurious emissions within 30-1000MHz were found more than 20dB below limit line.