



FCC RF Test Report

APPLICANT : Sonim Technologies, Inc.
EQUIPMENT : LTE Phone
BRAND NAME : Sonim
MODEL NAME : XP5800(PC2111)
FCC ID : WYPPC2100
STANDARD : FCC 47 CFR Part 2, 90(R)
CLASSIFICATION : PCS Licensed Transmitter Held to Ear (PCE)

The product was received on Sep. 21, 2017 and completely tested on Nov. 15, 2017. We, Sporton International (Kunshan) Inc., would like to declare that the tested sample has been evaluated in accordance with the procedures given in ANSI/TIA-603-E and shown compliance with the applicable technical standards.

The test results in this report apply exclusively to the tested model / sample. Without written approval of Sporton International (Kunshan) Inc., the test report shall not be reproduced except in full.



Approved by: James Huang / Manager

Sporton International (Kunshan) Inc.

No.3-2 Ping-Xiang Rd, Kunshan Development Zone Kunshan City Jiangsu Province 215335
China



TABLE OF CONTENTS

REVISION HISTORY.....3
SUMMARY OF TEST RESULT4
1 GENERAL DESCRIPTION5
1.1 Applicant.....5
1.2 Manufacturer.....5
1.3 Feature of Equipment Under Test5
1.4 Maximum ERP Power, Frequency Tolerance, and Emission Designator6
1.5 Testing Site.....7
1.6 Applied Standards8
2 TEST CONFIGURATION OF EQUIPMENT UNDER TEST.....9
2.1 Test Mode.....9
2.2 Connection Diagram of Test System.....10
2.3 Support Unit used in test configuration and system10
2.4 Measurement Results Explanation Example.....11
3 CONDUCTED TEST ITEMS12
3.1 Measuring Instruments12
3.2 Test Setup12
3.3 Test Result of Conducted Test12
3.4 Conducted Output Power and ERP13
3.5 Occupied Bandwidth14
3.6 Conducted Band Edge Measurement15
3.7 Emission Mask.....16
3.8 Conducted Spurious Emission Measurement17
3.9 Frequency Stability Measurement18
4 RADIATED TEST ITEMS19
4.1 Measuring Instruments19
4.2 Test Setup19
4.3 Test Result of Radiated Test19
4.4 Radiated Spurious Emission Measurement20
5 LIST OF MEASURING EQUIPMENT21
6 UNCERTAINTY OF EVALUATION22
APPENDIX A. TEST RESULTS OF CONDUCTED TEST
APPENDIX B. TEST RESULTS OF RADIATED TEST
APPENDIX C. TEST SETUP PHOTOGRAPHS



SUMMARY OF TEST RESULT

Report Section	FCC Rule	Description	Limit	Result	Remark
3.4	§2.1046	Conducted Output Power	Reporting only	PASS	-
	§90.542 (a)(7)	Effective Radiated Power	ERP < 3Watt	PASS	-
3.5	§2.1049	Occupied Bandwidth	Reporting only	PASS	-
3.6	§2.1053 §90.543 (e)(2)(3)	Conducted Band Edge Measurement	Refer standard	PASS	-
3.7	§2.1051 §90.210(n)	Emission Mask	Mask B	PASS	
3.8	§2.1053 §90.543 (e)(3)	Conducted Spurious Emission	< 43+10log ₁₀ (P[Watts])	PASS	
3.9	§2.1055 §90.539 (e)	Frequency Stability Temperature & Voltage	< ±1.25 ppm	PASS	
4.4	§2.1053 §90.543 (e)(3) §90.543 (f)	Radiated Spurious Emission	< 43+10log ₁₀ (P[Watts])	PASS	Under limit 20.72 dB at 1577.000 MHz



1 General Description

1.1 Applicant

Sonim Technologies, Inc.
1825 S. Grant St., Suite 200., San Mateo, CA, 94402

1.2 Manufacturer

Sonim Technologies (Shenzhen) Limited
2nd Floor, No. 2 Building Phase B, Daqian Industrial park, Longchang Road, 67 District, Baoan, Shenzhen, P. R. China

1.3 Feature of Equipment Under Test

Product Feature	
Equipment	LTE Phone
Brand Name	Sonim
Model Name	XP5800(PC2111)
FCC ID	WYPPC2100
Tx Frequency	LTE Band 14: 790.5 MHz ~ 795.5 MHz
Rx Frequency	LTE Band 14: 760.5 MHz ~ 765.5 MHz
Bandwidth	5MHz / 10MHz
Maximum Output Power to Antenna	LTE Band 14: 22.75dBm
Type of Modulation	QPSK / 16QAM
IMEI Code	Conducted: 001080001908558/001080001908558 Radiation: 001080001911198/001080001911206
HW Version	A
SW Version	5SA.0.0-00-7.1.2-00.25.01
EUT Stage	Identical Prototype

Remark: The above EUT's information was declared by manufacturer. Please refer to the specifications or user's manual for more detailed description.



1.4 Maximum ERP Power, Frequency Tolerance, and Emission Designator

LTE Band 14		QPSK			16QAM		
BW (MHz)	Frequency Range (MHz)	Emission Designator (99%OBW)	Frequency Tolerance (ppm)	Maximum ERP(W)	Emission Designator (99%OBW)	Frequency Tolerance (ppm)	Maximum ERP(W)
5	790.5~795.5	4M48G7D	-	0.0536	4M51W7D	-	0.0459
10	793	8M99G7D	0.0049	0.0575	8M93W7D	-	0.0466



1.5 Testing Site

Sporton Lab is accredited to ISO 17025 by National Voluntary Laboratory Accreditation Program (NVLAP code: 600155-0) and the FCC designation No. is CN5013.

Test Site	Sporton International (Kunshan) Inc.	
Test Site Location	No.3-2 Ping-Xiang Rd, Kunshan Development Zone Kunshan City Jiangsu Province 215335 China TEL : +86-512-57900158 FAX : +86-512-57900958	
Test Site No.	Sporton Site No.	FCC Test Firm Registration No.
	TH01-KS	630927

Sporton Lab is accredited to ISO 17025 by National Voluntary Laboratory Accreditation Program (NVLAP code: 600156-0) and the FCC designation No. is CN5019.

Test Site	SPORTON International (ShenZhen) INC.	
Test Site Location	No. 3 Bldg the third floor of south, Shahe River west, Fengzeyuan Warehouse, Nanshan District Shenzhen City Guangdong Province 518055 China TEL: +86-755-3320-2398	
Test Site No.	Sporton Site No.	FCC Test Firm Registration No.
	03CH04-SZ	577730

Note: The test site complies with ANSI C63.4 2014 requirement.

1.6 Applied Standards

According to the specifications of the manufacturer, the EUT must comply with the requirements of the following standards:

- ♦ 47 CFR Part 2, Part 90(R)
- ♦ ANSI/TIA-603-E
- ♦ FCC KDB 971168 D01 Power Meas. License Digital Systems v03
- ♦ FCC KDB 412172 D01 Determining ERP and EIRP v01r01

Remark:

1. All test items were verified and recorded according to the standards and without any deviation during the test.
2. This EUT has also been tested and complied with the requirements of FCC Part 15, Subpart B, recorded in a separate test report.

2 Test Configuration of Equipment Under Test

2.1 Test Mode

Antenna port conducted and radiated test items listed below are performed according to KDB 971168 D01 Power Meas License Digital Systems v03 with maximum output power.

Radiated measurements are performed by rotating the EUT in three different orthogonal test planes to find the maximum emission.

Conducted Test Cases	Band	Bandwidth (MHz)						Modulation		RB #			Test Channel		
		1.4	3	5	10	15	20	QPSK	16QAM	1	Half	Full	L	M	H
Max. Output Power	14	-	-	V	-	-	-	V	V	V	V	V	V	V	V
	14	-	-		V	-	-	V	V	V	V	V		V	
26dB and 99% Bandwidth	14	-	-	V		-	-	V	V			V	V	V	V
	14	-	-		V	-	-	V	V			V		V	
Conducted Band Edge	14	-	-	V		-	-	V	V	V		V	V		V
	14	-	-		V	-	-	V	V	V		V		V	
Emission Mask	14	-	-	V		-	-	V	V	V		V	V	V	V
	14	-	-		V	-	-	V	V	V		V		V	
Conducted Spurious Emission	14	-	-	V		-	-	V	V	V			V	V	V
	14	-	-		V	-	-	V	V	V				V	
Frequency Stability	14	-	-		V	-	-	V				V		V	
E.R.P	14	-	-	V		-	-	V	V	V			V	V	V
	14	-	-		V	-	-	V	V	V				V	
Radiated Spurious Emission	14	-	-	V	V	-	-	V		V				V	
Note	<ol style="list-style-type: none"> The mark "v" means that this configuration is chosen for testing The mark "-" means that this bandwidth is not supported. The device is investigated from 30MHz to 10 times of fundamental signal for radiated spurious emission test under different RB size/offset and modulations in exploratory test. Subsequently, only the worst case emissions are reported. 														

2.2 Connection Diagram of Test System

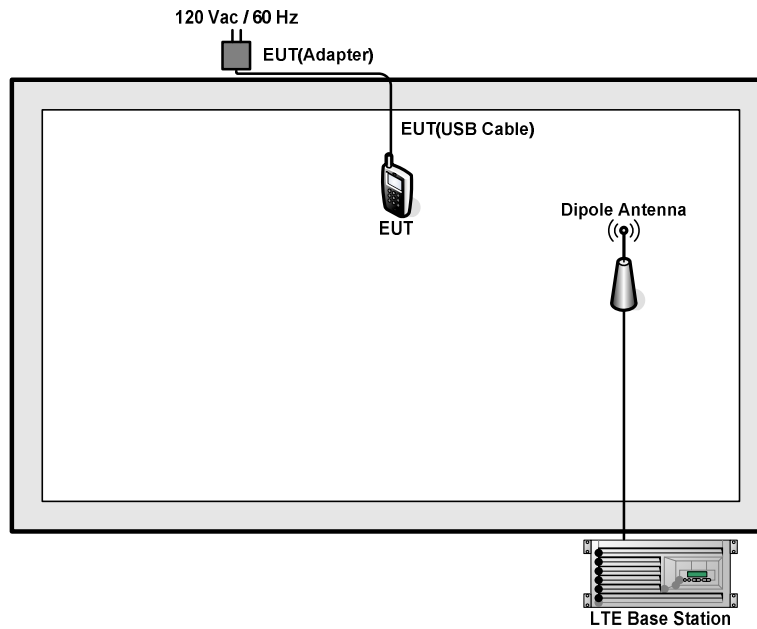

2.3 Support Unit used in test configuration and system

Item	Equipment	Trade Name	Model No.	FCC ID	Data Cable	Power Cord
1.	LTE Base Station	Anritsu	MT8820C	N/A	N/A	Unshielded, 1.8 m
2.	DC Power Supply	GW INSTRON	GPS-3030D	N/A	N/A	Unshielded, 1.8 m



2.4 Measurement Results Explanation Example

For all conducted test items:

The offset level is set in the spectrum analyzer to compensate the RF cable loss between EUT conducted output port and spectrum analyzer. With the offset compensation, the spectrum analyzer reading level is exactly the EUT RF output level.

The spectrum analyzer offset is derived from RF cable loss.

Offset = RF cable loss.

Following shows an offset computation example with cable loss 4.4 dB.

Example :

$$\begin{aligned} \text{Offset(dB)} &= \text{RF cable loss(dB)}. \\ &= 4.4 \text{ (dB)} \end{aligned}$$

3 Conducted Test Items

3.1 Measuring Instruments

See list of measuring instruments of this test report.

3.2 Test Setup

3.2.1 Conducted Output Power



3.2.2 Occupied / 26dB Bandwidth ,Band-Edge and Conducted Spurious Emission

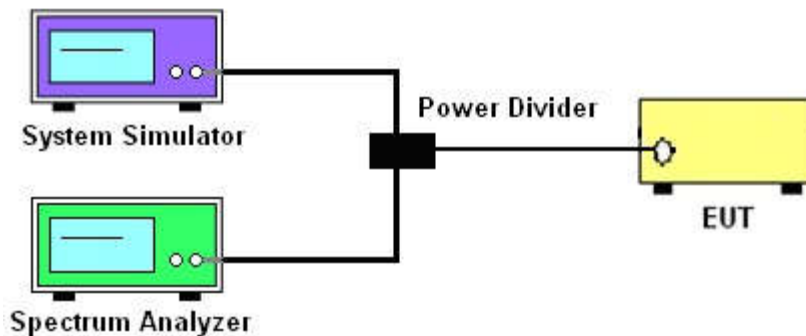

3.2.3 Frequency Stability

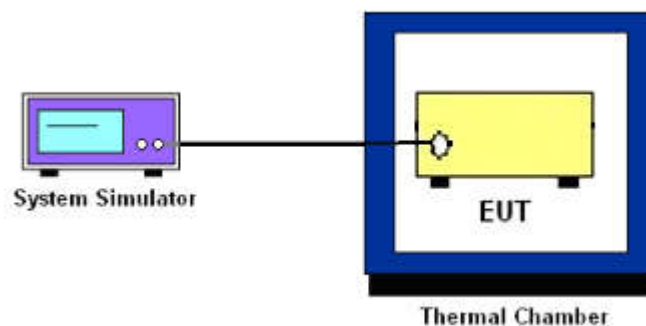

3.3 Test Result of Conducted Test

Please refer to Appendix A.

3.4 Conducted Output Power and ERP

3.4.1 Description of the Conducted Output Power Measurement and ERP

A base station simulator was used to establish communication with the EUT. Its parameters were set to transmit the maximum power on the EUT. The measured power in the radio frequency on the transmitter output terminals shall be reported.

The ERP of mobile transmitters must not exceed 3 Watts for LTE Band 14.

According to KDB 412172 D01 Power Approach,

$EIRP = P_T + G_T - L_C$, $ERP = EIRP - 2.15$, where

P_T = transmitter output power in dBm

G_T = gain of the transmitting antenna in dBi

L_C = signal attenuation in the connecting cable between the transmitter and antenna in dB

3.4.2 Test Procedures

1. The transmitter output port was connected to the system simulator.
2. Set EUT at maximum power through the system simulator.
3. Select lowest, middle, and highest channels for each band and different modulation.
4. Measure and record the power level from the system simulator.



3.5 Occupied Bandwidth

3.5.1 Description of Occupied Bandwidth Measurement

The occupied bandwidth is the width of a frequency band such that, below the lower and above the upper frequency limits, the mean powers emitted are each equal to a specified percentage 0.5% of the total mean transmitted power.

The 26 dB emission bandwidth is defined as the frequency range between two points, one above and one below the carrier frequency, at which the spectral density of the emission is attenuated 26 dB below the maximum in-band spectral density of the modulated signal. Spectral density (power per unit bandwidth) is to be measured with a detector of resolution bandwidth equal to approximately 1.0% of the emission bandwidth.

3.5.2 Test Procedures

1. The testing follows FCC KDB 971168 v03 Section 4.2.
2. The EUT was connected to spectrum analyzer and system simulator via a power divider.

3.6 Conducted Band Edge Measurement

3.6.1 Description of Conducted Band Edge Measurement

For operations in the 758-768 MHz and the 788-798 MHz bands

- (1) On all frequencies between 769-775 MHz and 799-805 MHz, by a factor not less than $76 + 10 \log (P)$ dB in a 6.25 kHz band segment, for base and fixed stations.
- (2) On all frequencies between 769-775 MHz and 799-805 MHz, by a factor not less than $65 + 10 \log (P)$ dB in a 6.25 kHz band segment, for mobile and portable stations.
- (3) On any frequency between 775-788 MHz, above 805 MHz, and below 758 MHz, by at least $43 + 10 \log (P)$ dB.

3.6.2 Test Procedures

1. The EUT was connected to Spectrum Analyzer and Base Station via power divider.
2. Set spectrum analyzer with RMS detector.
3. The RF fundamental frequency should be excluded against the limit line in the operating frequency band.
4. The limit line is derived from $43 + 10 \log(P)$ dB below the transmitter power P(Watts)
= $P(W) - [43 + 10 \log(P)]$ (dB)
= $[30 + 10 \log(P)]$ (dBm) - $[43 + 10 \log(P)]$ (dB)
= -13dBm.

3.7 Emission Mask

3.7.1 Test Procedures

1. The testing follows FCC KDB 971168 v03 Section 6.0.
2. The EUT was connected to spectrum analyzer and system simulator via a power divider.
3. The power of the modulated signal was measured on a spectrum analyzer using an RMS and 10 second sweep time in order to maximize the level.
4. The RF fundamental frequency should be excluded against the limit line in the operating frequency band.

3.7.2 Test Setup

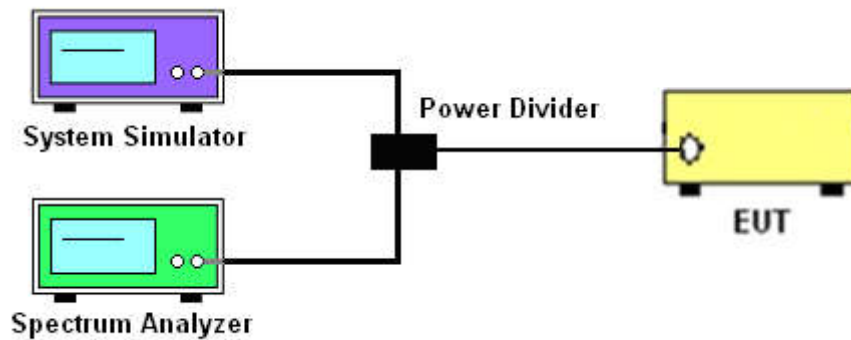

3.8 Conducted Spurious Emission Measurement

3.8.1 Description of Conducted Spurious Emission Measurement

The power of any emission outside of the authorized operating frequency ranges must be lower than the transmitter power (P) by a factor of at least $43 + 10 \log(P)$ dB.

It is measured by means of a calibrated spectrum analyzer and scanned from 30MHz up to a frequency including its 10th harmonic.

3.8.2 Test Procedures

1. The EUT was connected to spectrum analyzer and base station via power divider.
2. The RF output of EUT was connected to the spectrum analyzer by RF cable and attenuator. The path loss was compensated to the results for each measurement.
3. The middle channel for the highest RF power within the transmitting frequency was measured.
4. The conducted spurious emission for the whole frequency range was taken.
5. Make the measurement with the spectrum analyzer's, for under 1GHz RBW = 100kHz, VBW = 300kHz and for above 1GHz RBW = 1MHz, VBW = 3MHz, taking the record of maximum spurious emission.
6. Set spectrum analyzer with RMS detector.
7. The RF fundamental frequency should be excluded against the limit line in the operating frequency band.
8. The limit line is derived from $43 + 10\log(P)$ dB below the transmitter power P(Watts)
= $P(W) - [43 + 10\log(P)]$ (dB)
= $[30 + 10\log(P)]$ (dBm) - $[43 + 10\log(P)]$ (dB)
= -13dBm.

3.9 Frequency Stability Measurement

3.9.1 Description of Frequency Stability Measurement

The frequency stability shall be measured by variation of ambient temperature and variation of primary supply voltage to ensure that the fundamental emission stays within the authorized frequency block. The frequency stability of the transmitter shall be maintained within ± 1.25 ppm of the center frequency.

3.9.2 Test Procedures for Temperature Variation

1. The EUT was set up in the thermal chamber and connected with the base station.
2. With power OFF, the temperature was decreased to -30°C and the EUT was stabilized before testing. Power was applied and the maximum change in frequency was recorded within one minute.
3. With power OFF, the temperature was raised in 10°C step up to 50°C . The EUT was stabilized at each step for at least half an hour. Power was applied and the maximum frequency change was recorded within one minute.

3.9.3 Test Procedures for Voltage Variation

1. The EUT was placed in a temperature chamber at $25\pm 5^{\circ}\text{C}$ and connected with the base station.
2. The power supply voltage to the EUT was varied from 85% to 115% of the nominal value measured at the input to the EUT.
3. The variation in frequency was measured for the worst case.

4 Radiated Test Items

4.1 Measuring Instruments

See list of measuring instruments of this test report.

4.2 Test Setup

4.2.1 For radiated test from 30MHz to 1GHz

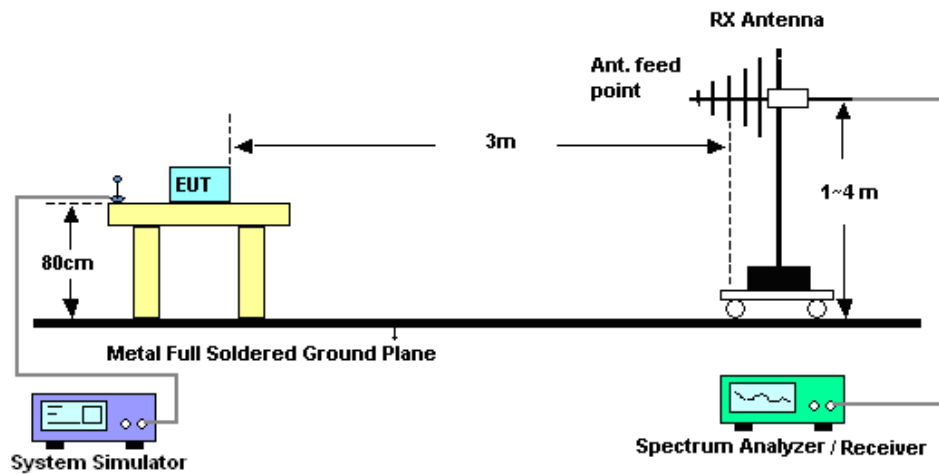

4.2.2 For radiated test above 1GHz

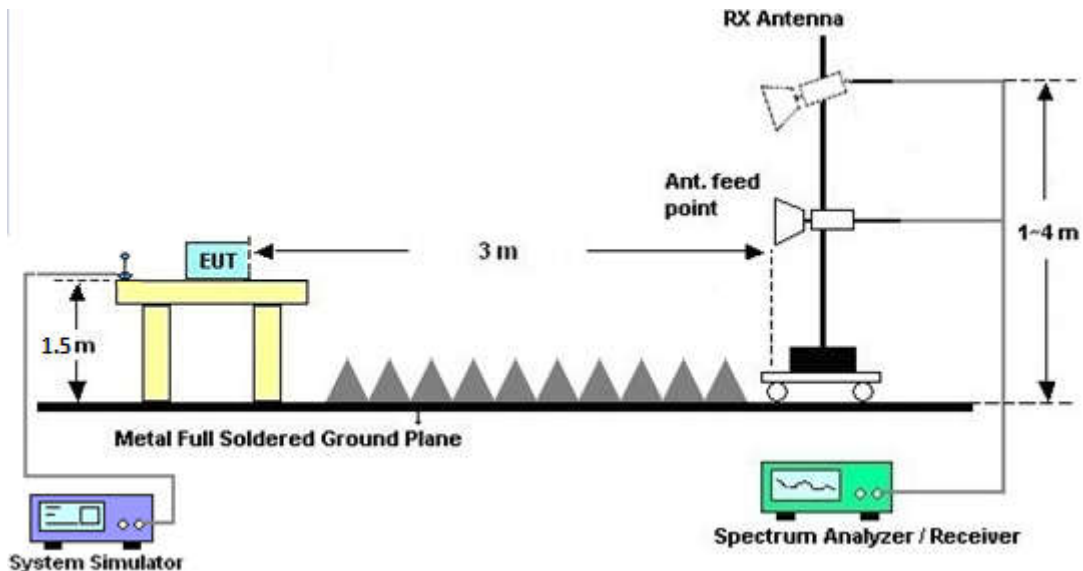

4.3 Test Result of Radiated Test

Please refer to Appendix B.

4.4 Radiated Spurious Emission Measurement

4.4.1 Description of Radiated Spurious Emission

The radiated spurious emission was measured by substitution method according to ANSI/TIA-603-E. The power of any emission outside of the authorized operating frequency ranges must be attenuated below the transmitter power (P) by a factor of at least $43 + 10 \log (P)$ dB.

For operations in the 758-775 MHz and 788-805 MHz bands, all emissions including harmonics in the band 1559–1610 MHz shall be limited to -70 dBW/MHz equivalent isotropically radiated power (EIRP) for wideband signals, and -80 dBW EIRP for discrete emissions of less than 700 Hz bandwidth. For the purpose of equipment authorization, a transmitter shall be tested with an antenna that is representative of the type that will be used with the equipment in normal operation.

4.4.2 Test Procedures

1. The testing follows FCC KDB 971168 v03 Section 5.8 and ANSI/TIA-603-E Section 2.2.12.
2. The EUT was placed on a turntable with 0.8 meter height for frequency below 1GHz and 1.5 meter height for frequency above 1GHz respectively above ground.
3. The EUT was set 3 meters from the receiving antenna, which was mounted on the antenna tower.
4. The table was rotated 360 degrees to determine the position of the highest spurious emission.
5. The height of the receiving antenna is varied between one meter and four meters to search the maximum spurious emission for both horizontal and vertical polarizations.
6. Make the measurement with the spectrum analyzer's RBW = 1MHz, VBW = 3MHz, Sweep = 500ms, Taking the record of maximum spurious emission.
7. A horn antenna was substituted in place of the EUT and was driven by a signal generator.
8. Tune the output power of signal generator to the same emission level with EUT maximum spurious emission.
9. Taking the record of output power at antenna port.
10. Repeat step 7 to step 8 for another polarization.
11. The RF fundamental frequency should be excluded against the limit line in the operating frequency band.

The limit line is derived from $43 + 10\log(P)$ dB below the transmitter power P(Watts)

$$= P(W) - [43 + 10\log(P)] \text{ (dB)}$$

$$= [30 + 10\log(P)] \text{ (dBm)} - [43 + 10\log(P)] \text{ (dB)}$$

$$= -13\text{dBm.}$$

12. $\text{EIRP (dBm)} = \text{S.G. Power} - \text{Tx Cable Loss} + \text{Tx Antenna Gain}$
 $\text{ERP (dBm)} = \text{EIRP} - 2.15$



5 List of Measuring Equipment

Instrument	Manufacturer	Model No.	Serial No.	Characteristics	Calibration Date	Test Date	Due Date	Remark
Spectrum Analyzer	R&S	FSV40	101040	10Hz~40GHz	Aug. 08, 2017	Oct. 10, 2017~ Nov. 15, 2017	Aug. 07, 2018	Conducted (TH01-KS)
Radio communication analyzer	Anritsu	MT8820C	6201300652	2G/3G/LTE_ full band	Aug. 08, 2017	Oct. 10, 2017~ Nov. 15, 2017	Aug. 07, 2018	Conducted (TH01-KS)
Thermal Chamber	Hongzhan	LP-150U	2306	-40~+150°C 20%~98%RH	Apr. 20, 2017	Oct. 10, 2017~ Nov. 15, 2017	Apr. 19, 2018	Conducted (TH01-KS)
EXA Spectrum Analyzer	KEYSIGHT	N9010A	MY55150213	10Hz~44GHz	Apr. 20, 2017	Oct. 03, 2017	Apr. 19, 2018	Radiation (03CH04-SZ)
Bilog Antenna	TeseQ	CBL6111D	41909	30MHz~1GHz	May 16, 2017	Oct. 03, 2017	May 15, 2018	Radiation (03CH04-SZ)
Double Ridge Horn Antenna	SCHWARZBECK	BBHA9120D	9120D-1474	1GHz~18GHz	Jan. 12, 2017	Oct. 03, 2017	Jan. 11, 2018	Radiation (03CH04-SZ)
Horn Antenna	SCHWARZBECK	BBHA9170	9170#679	15GHz~40GHz	May 17, 2017	Oct. 03, 2017	May 16, 2018	Radiation (03CH04-SZ)
Amplifier	Burgeon	BPA-530	102211	0.01Hz ~3000MHz	Oct. 11, 2016	Oct. 03, 2017	Oct. 10, 2017	Radiation (03CH04-SZ)
HF Amplifier	MITEQ	AMF-7D-00 101800-30-1	1989346	1GHz~18GHz	Jul. 27, 2017	Oct. 03, 2017	Jul. 26, 2018	Radiation (03CH04-SZ)
Amplifier	Agilent Technologies	83017A	MY53270156	500MHz~26.5GHz	Apr. 20, 2017	Oct. 03, 2017	Apr. 19, 2018	Radiation (03CH04-SZ)
AC Power Source	Chroma	61601	N/A	N/A	NCR	Oct. 03, 2017	NCR	Radiation (03CH04-SZ)
Turn Table	EM	EM1000	N/A	0~360 degree	NCR	Oct. 03, 2017	NCR	Radiation (03CH04-SZ)
Antenna Mast	EM	EM1000	N/A	1 m~4 m	NCR	Oct. 03, 2017	NCR	Radiation (03CH04-SZ)

NCR: No Calibration Required

6 Uncertainty of Evaluation

Uncertainty of Radiated Emission Measurement (30 MHz ~ 1000 MHz)

Measuring Uncertainty for a Level of Confidence of 95% ($U = 2Uc(y)$)	2.8 dB
---	--------

Uncertainty of Radiated Emission Measurement (1GHz ~ 18GHz)

Measuring Uncertainty for a Level of Confidence of 95% ($U = 2Uc(y)$)	3.1 dB
---	--------

Uncertainty of Radiated Emission Measurement (18GHz ~ 40GHz)

Measuring Uncertainty for a Level of Confidence of 95% ($U = 2Uc(y)$)	3.9 dB
---	--------

Appendix A. Test Results of Conducted Test

Conducted Output Power(Average power)

LTE Band 14 Maximum Average Power [dBm]						
BW [MHz]	RB Size	RB Offset	Mod	Lowest	Middle	Highest
5	1	0	QPSK	22.23	22.25	22.27
5	1	12		22.44	22.24	22.37
5	1	24		22.42	22.40	22.39
5	12	0		21.27	21.45	21.46
5	12	7		21.36	21.38	21.34
5	12	13		21.38	21.35	21.40
5	25	0		21.41	21.38	21.38
5	1	0	16-QAM	21.48	21.60	21.45
5	1	12		21.44	21.55	21.58
5	1	24		21.77	21.72	21.60
5	12	0		20.29	20.43	20.51
5	12	7		20.36	20.29	20.46
5	12	13		20.33	20.37	20.48
5	25	0		20.38	20.35	20.36



LTE Band 14 Maximum Average Power [dBm]						
BW [MHz]	RB Size	RB Offset	Mod	Lowest	Middle	Highest
10	1	0	QPSK		22.75	
10	1	25			22.39	
10	1	49			22.58	
10	25	0			21.50	
10	25	12			21.43	
10	25	25			21.44	
10	50	0			21.46	
10	1	0	16-QAM		21.83	
10	1	25			21.52	
10	1	49			21.68	
10	25	0			20.53	
10	25	12			20.38	
10	25	25			20.43	
10	50	0			20.40	



ERP

LTE Band 14 ($G_T - L_C = -3.00$ dB) QPSK						
Bandwidth	5M			10M		
Channel	23305	23330	23355		23330	
	(Low)	(Mid)	(High)		(Mid)	
Frequency	790.5	793	795.5		793	
(MHz)						
Conducted Power (dBm)	22.44	22.24	22.37		22.75	
Conducted Power (Watts)	0.1754	0.1675	0.1726		0.1884	
ERP(dBm)	17.29	17.09	17.22		17.60	
ERP(Watts)	0.0536	0.0512	0.0527		0.0575	

LTE Band 14 ($G_T - L_C = -3.00$ dB) 16QAM						
Bandwidth	5M			10M		
Channel	23305	23330	23355		23330	
	(Low)	(Mid)	(High)		(Mid)	
Frequency	790.5	793	795.5		793	
(MHz)						
Conducted Power (dBm)	21.77	21.72	21.60		21.83	
Conducted Power (Watts)	0.1503	0.1486	0.1445		0.1524	
ERP(dBm)	16.62	16.57	16.45		16.68	
ERP(Watts)	0.0459	0.0454	0.0442		0.0466	



26dB Bandwidth

Mode	LTE Band 14 : 26dB BW(MHz)							
	5MHz		10MHz					
BW								
Mod.	QPSK	16QAM	QPSK	16QAM				
Lowest CH	5.055	4.885	-	-				
Middle CH	5.025	4.905	9.65	9.67				
Highest CH	4.985	4.885	-	-				



LTE Band 14

Lowest Channel / 5MHz / QPSK

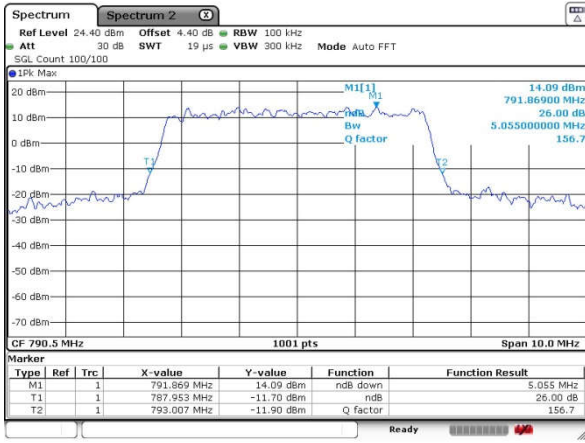

Date: 10.OCT.2017 11:39:15

Lowest Channel / 5MHz / 16QAM

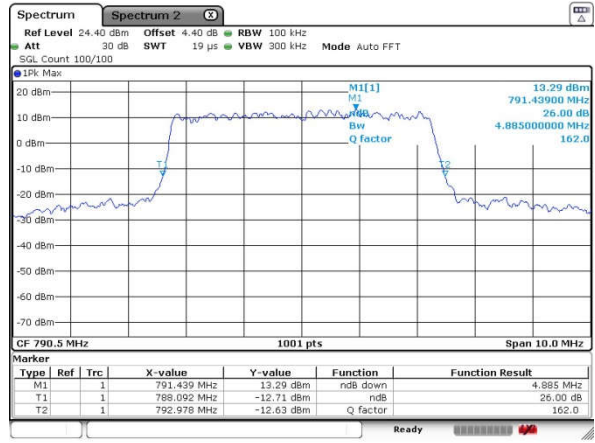

Date: 10.OCT.2017 11:39:53

Middle Channel / 5MHz / QPSK

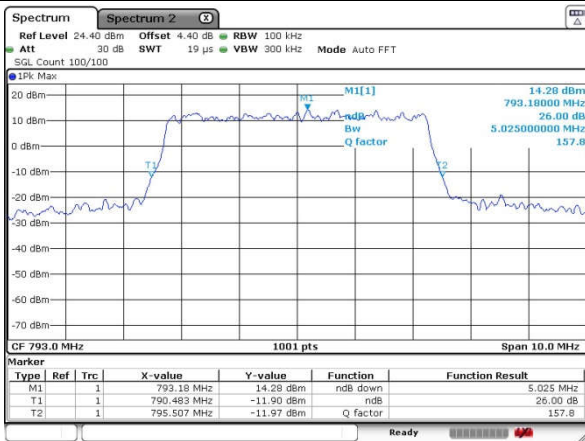

Date: 10.OCT.2017 11:41:50

Middle Channel / 5MHz / 16QAM

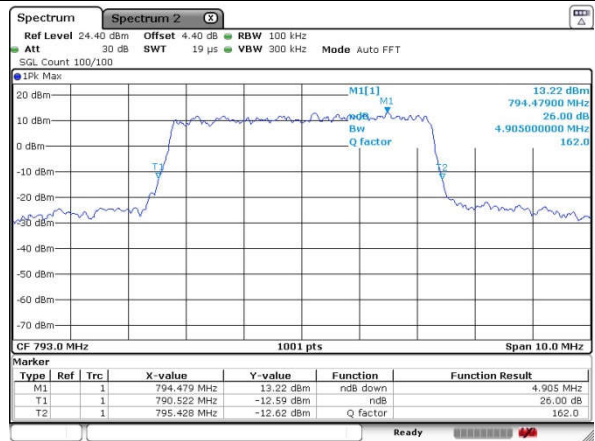

Date: 10.OCT.2017 11:41:31

Highest Channel / 5MHz / QPSK

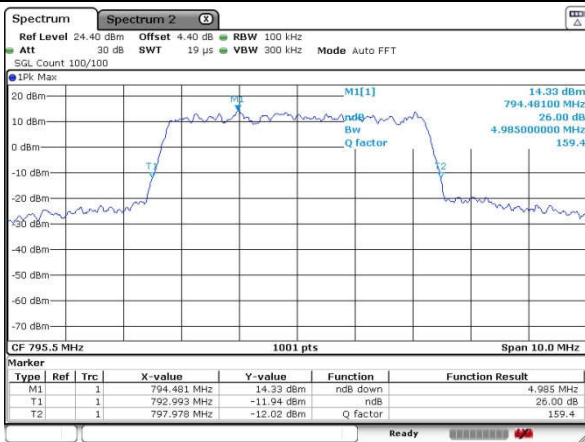

Date: 10.OCT.2017 11:42:31

Highest Channel / 5MHz / 16QAM

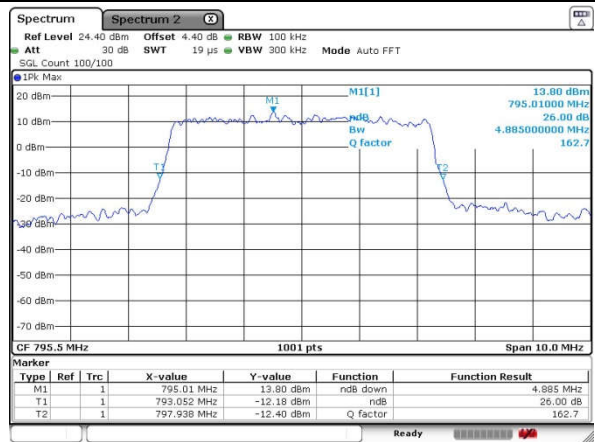

Date: 10.OCT.2017 11:42:58



LTE Band 14

Middle Channel / 10MHz / QPSK

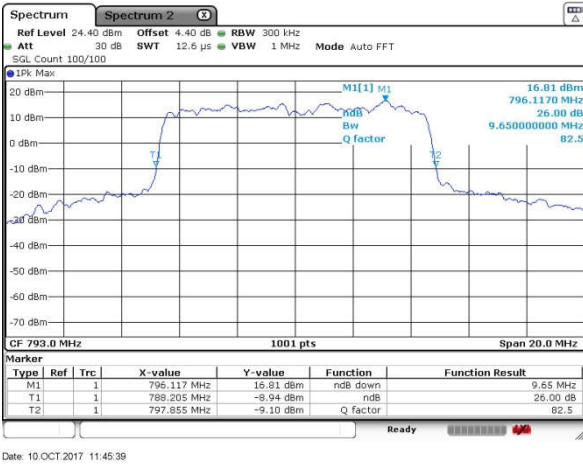

Date: 10.OCT.2017 11:45:39

Middle Channel / 10MHz / 16QAM

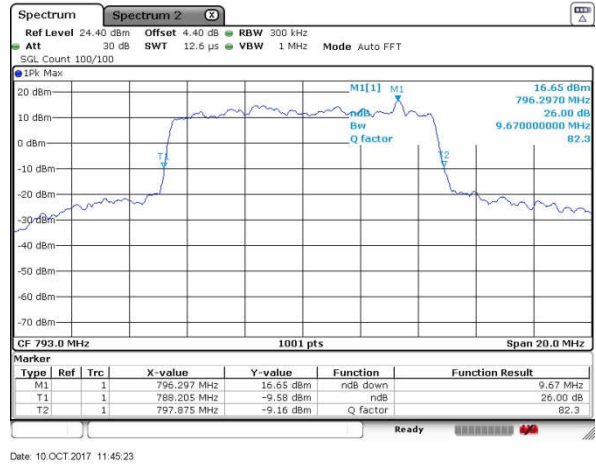

Date: 10.OCT.2017 11:45:23



Occupied Bandwidth

Mode	LTE Band 14 : 99%OBW(MHz)							
	5MHz		10MHz					
BW	QPSK	16QAM	QPSK	16QAM				
Mod.	QPSK	16QAM	QPSK	16QAM				
Lowest CH	4.47	4.51	-	-				
Middle CH	4.46	4.48	8.99	8.93				
Highest CH	4.48	4.50	-	-				



LTE Band 14

Lowest Channel / 5MHz / QPSK

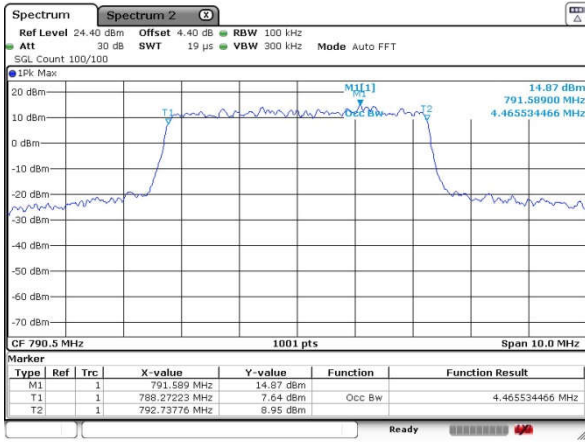

Date: 10.OCT.2017 11:48:55

Lowest Channel / 5MHz / 16QAM

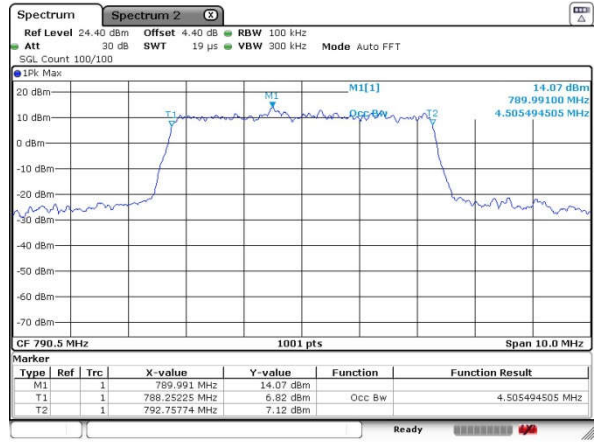

Date: 10.OCT.2017 11:49:10

Middle Channel / 5MHz / QPSK

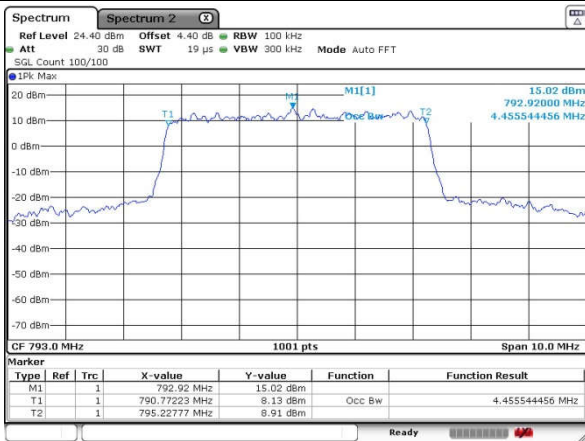

Date: 10.OCT.2017 11:48:25

Middle Channel / 5MHz / 16QAM

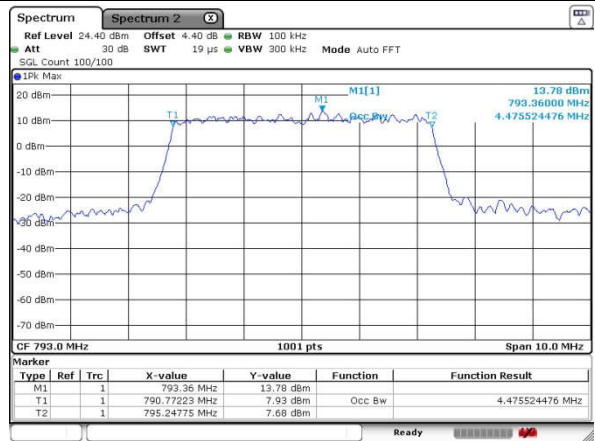

Date: 10.OCT.2017 11:48:11

Highest Channel / 5MHz / QPSK

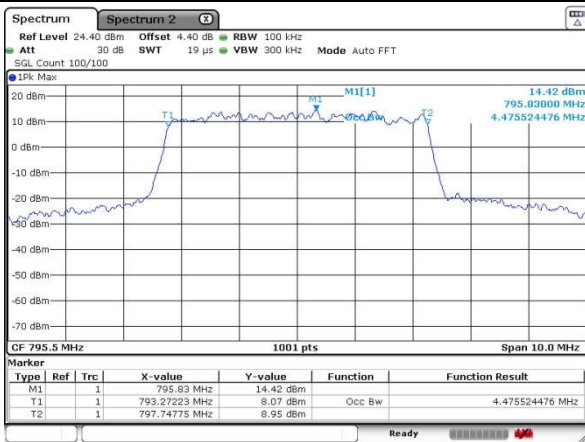

Date: 10.OCT.2017 11:50:43

Highest Channel / 5MHz / 16QAM

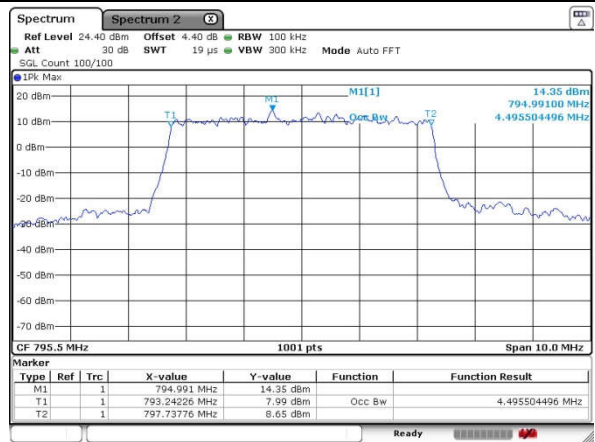

Date: 10.OCT.2017 11:50:20



LTE Band 14

Middle Channel / 10MHz / QPSK

Middle Channel / 10MHz / 16QAM

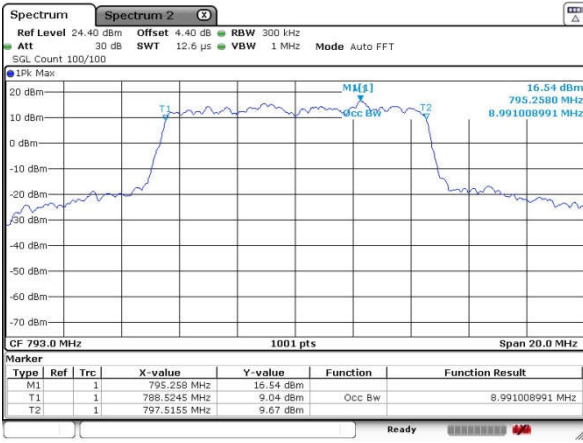

Date: 10.OCT.2017 11:46:24

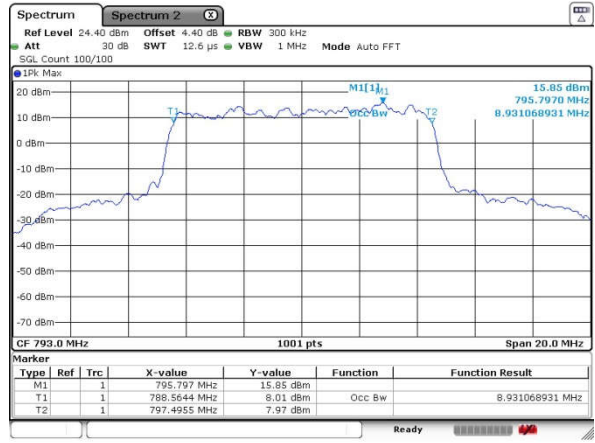

Date: 10.OCT.2017 11:46:47



Conducted Band Edge

LTE Band 14 / 5MHz / QPSK

Lowest Band Edge / 1 RB

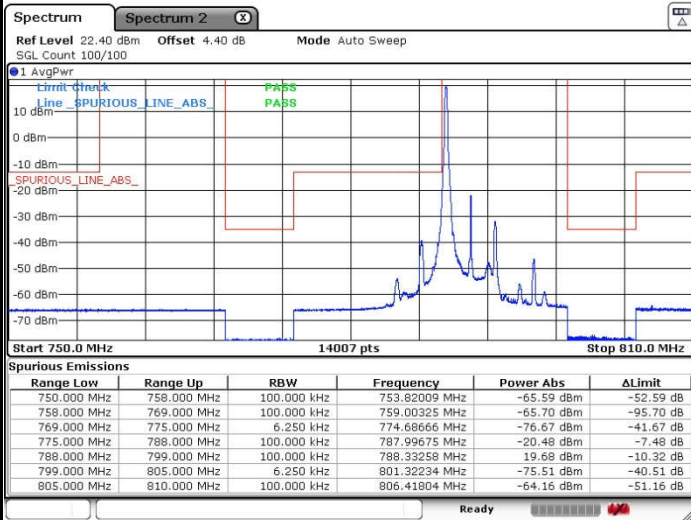

Highest Band Edge / 1 RB

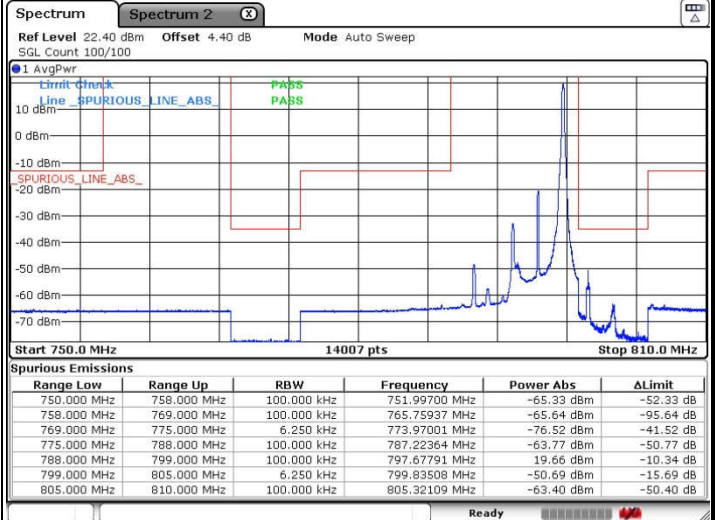

Lowest Band Edge / Full RB

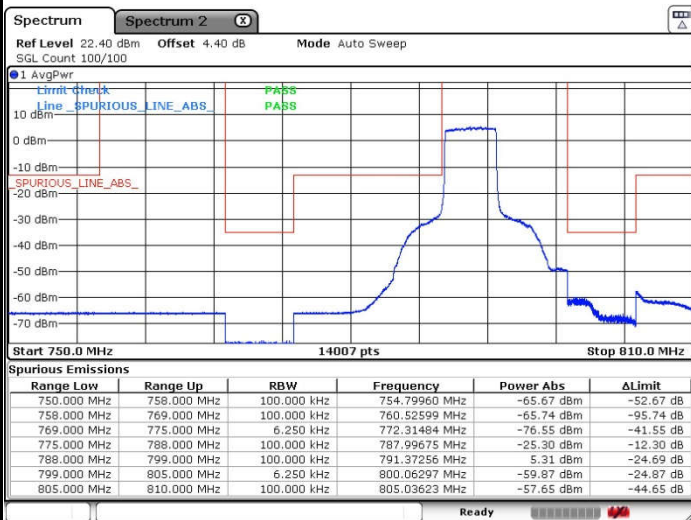

Highest Band Edge / Full RB

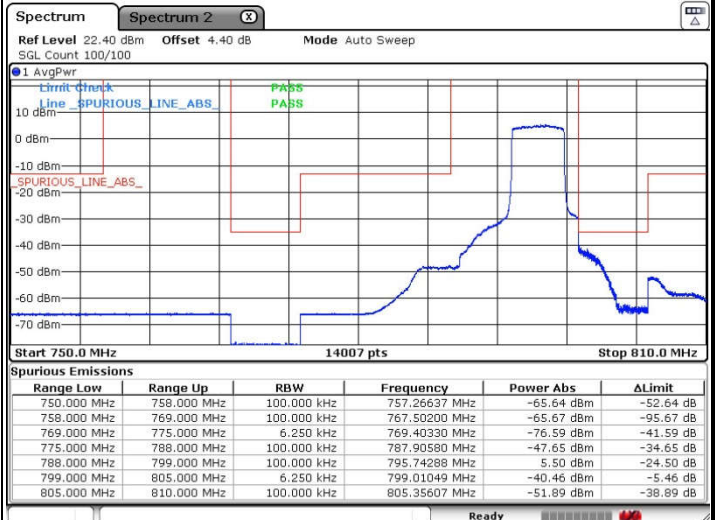



LTE Band 14 / 5MHz / 16QAM

Lowest Band Edge / 1 RB

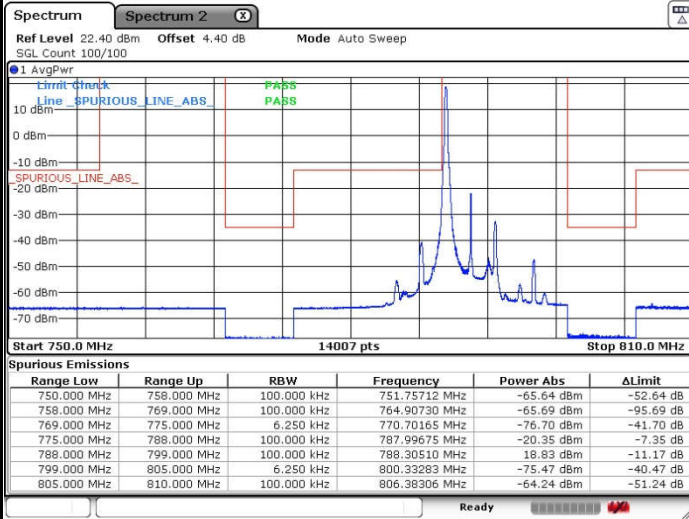

Date: 10.OCT.2017 10:16:51

Highest Band Edge / 1 RB

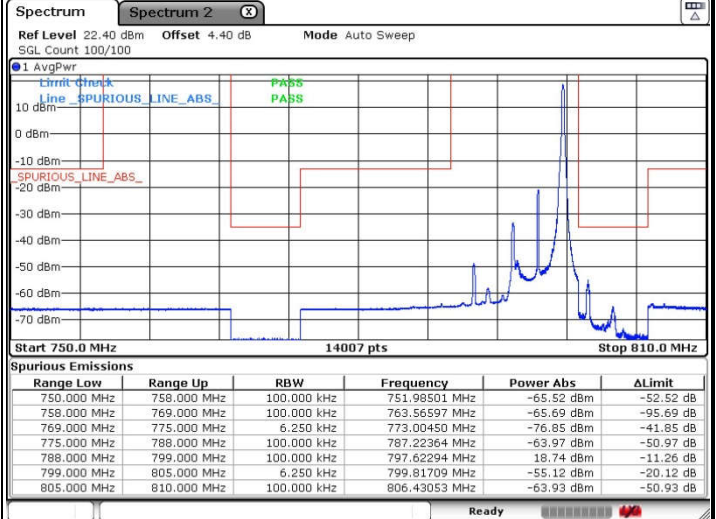

Date: 10.OCT.2017 10:31:56

Lowest Band Edge / Full RB

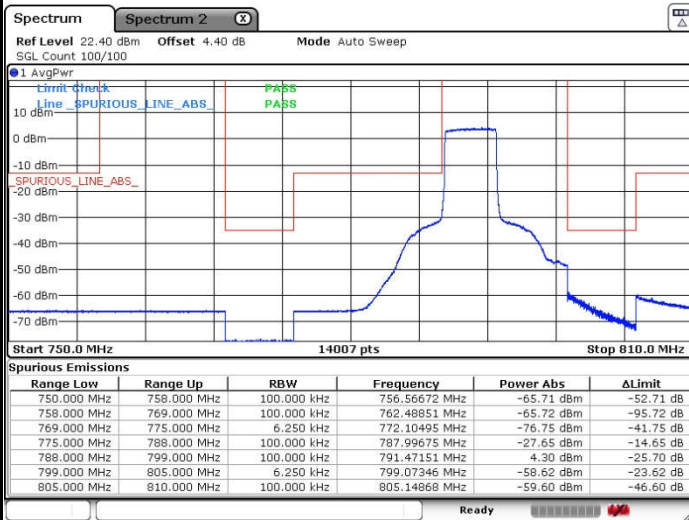

Date: 10.OCT.2017 10:09:24

Highest Band Edge / Full RB

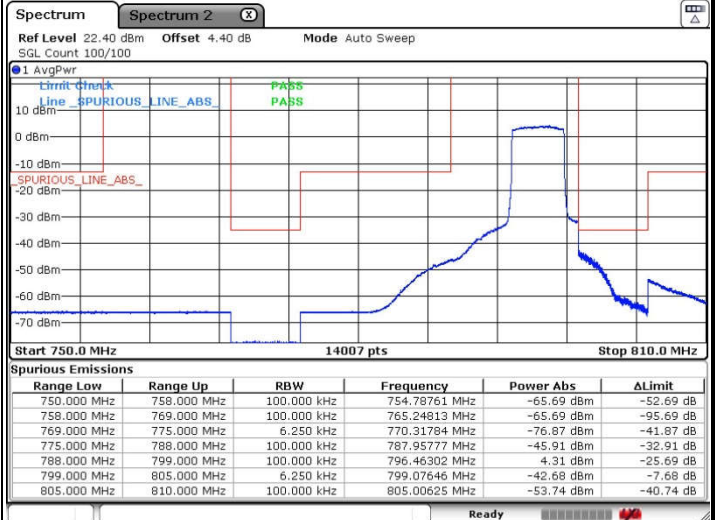

Date: 10.OCT.2017 10:39:07



LTE Band 14 / 10MHz / QPSK

Lowest Band Edge / 1 RB

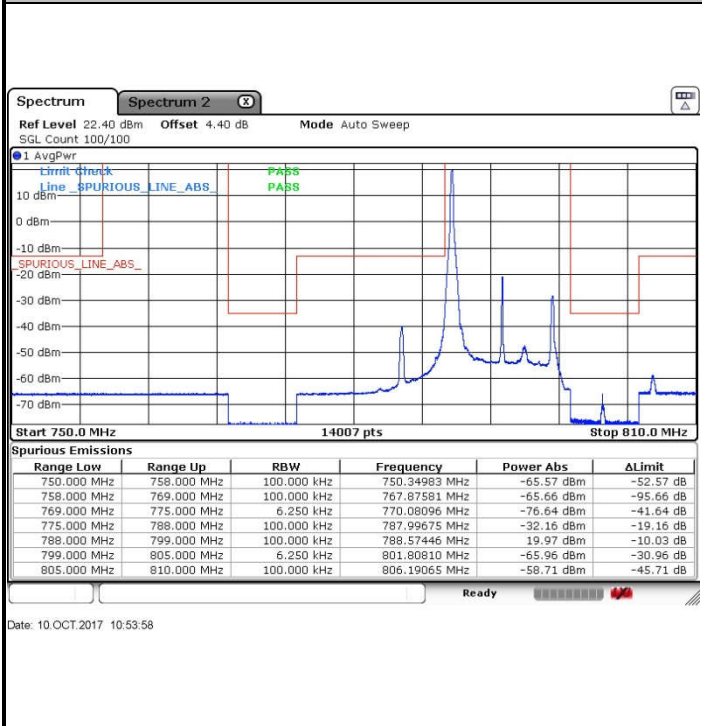

Highest Band Edge / 1 RB

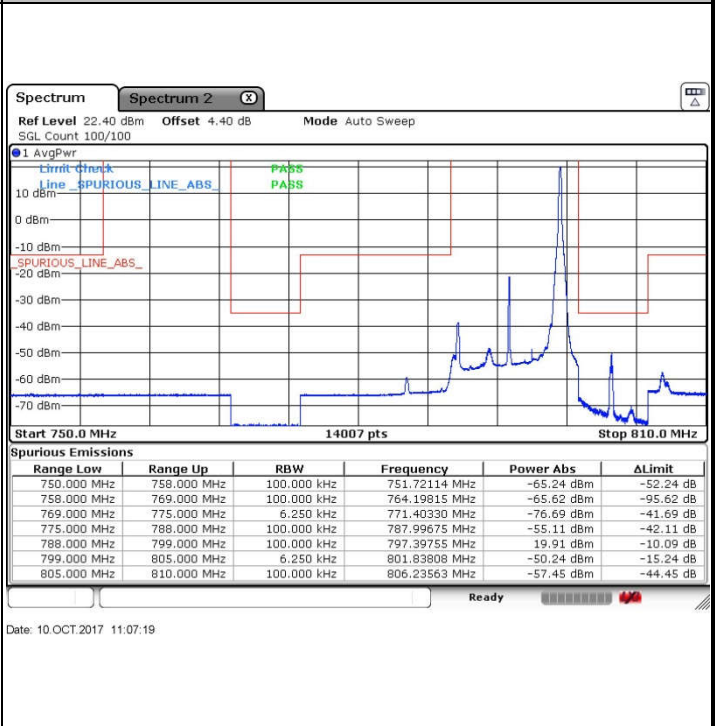

Band Edge / Full RB

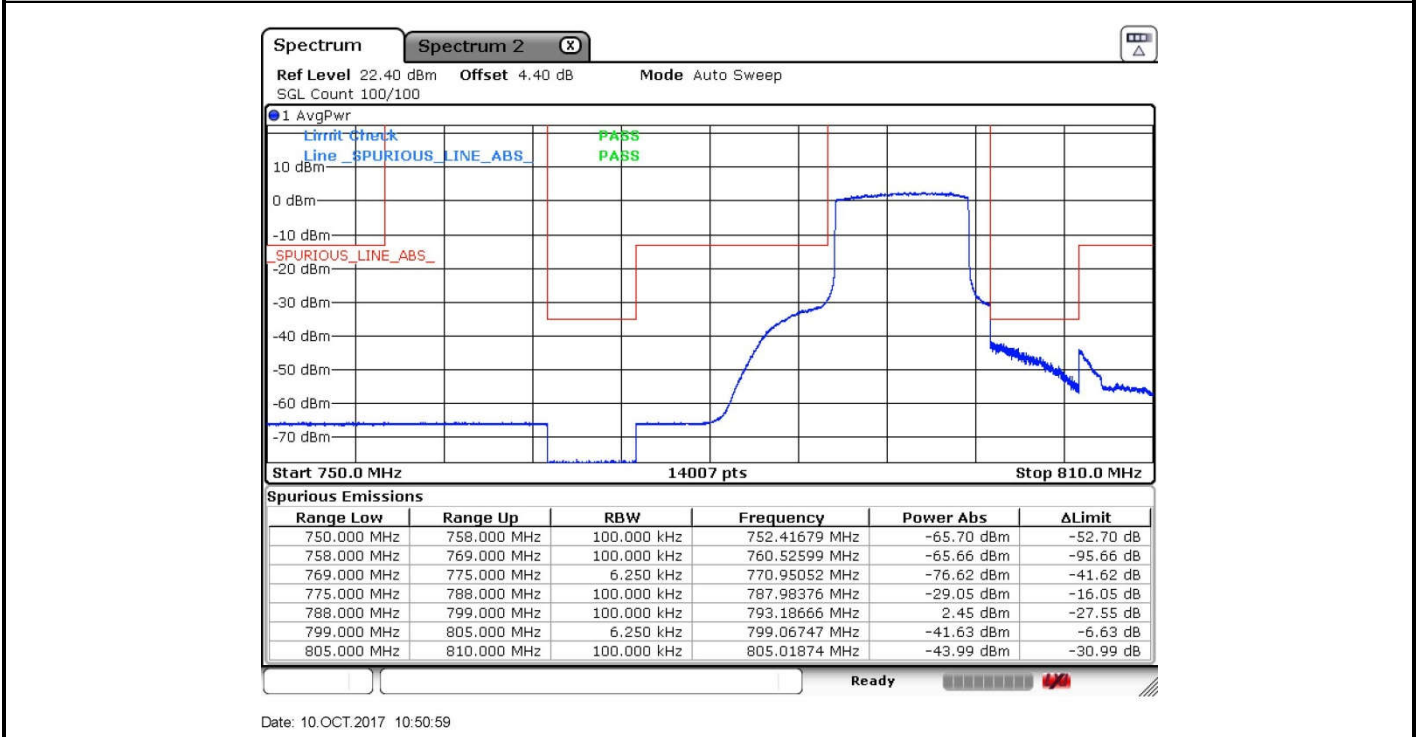



LTE Band 14 / 10MHz / 16QAM

Lowest Band Edge / 1 RB

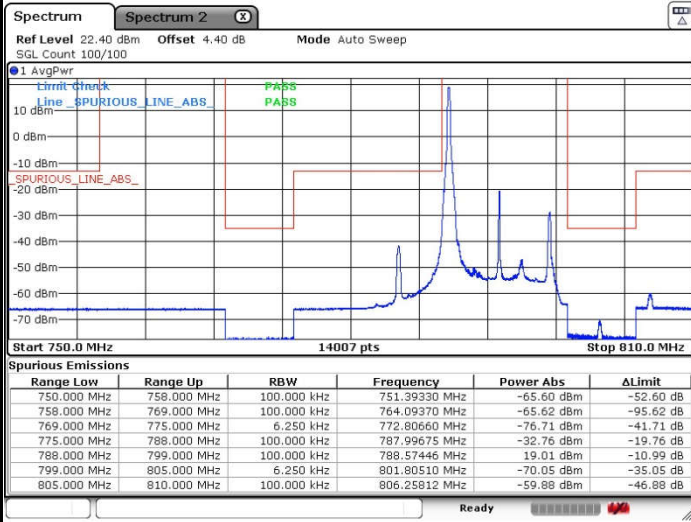

Date: 10.OCT.2017 10:56:45

Highest Band Edge / 1 RB

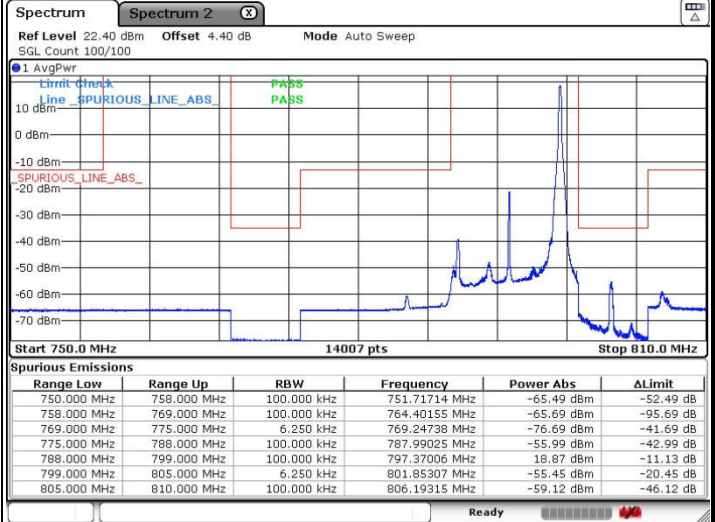

Date: 10.OCT.2017 11:04:36

Band Edge / Full RB

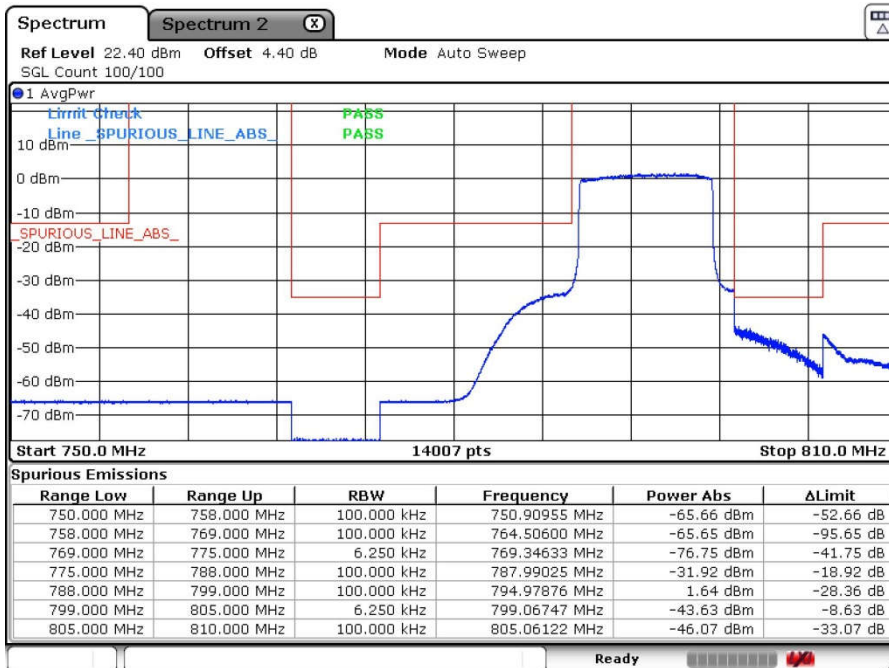

Date: 10.OCT.2017 10:48:05

Emission Mask

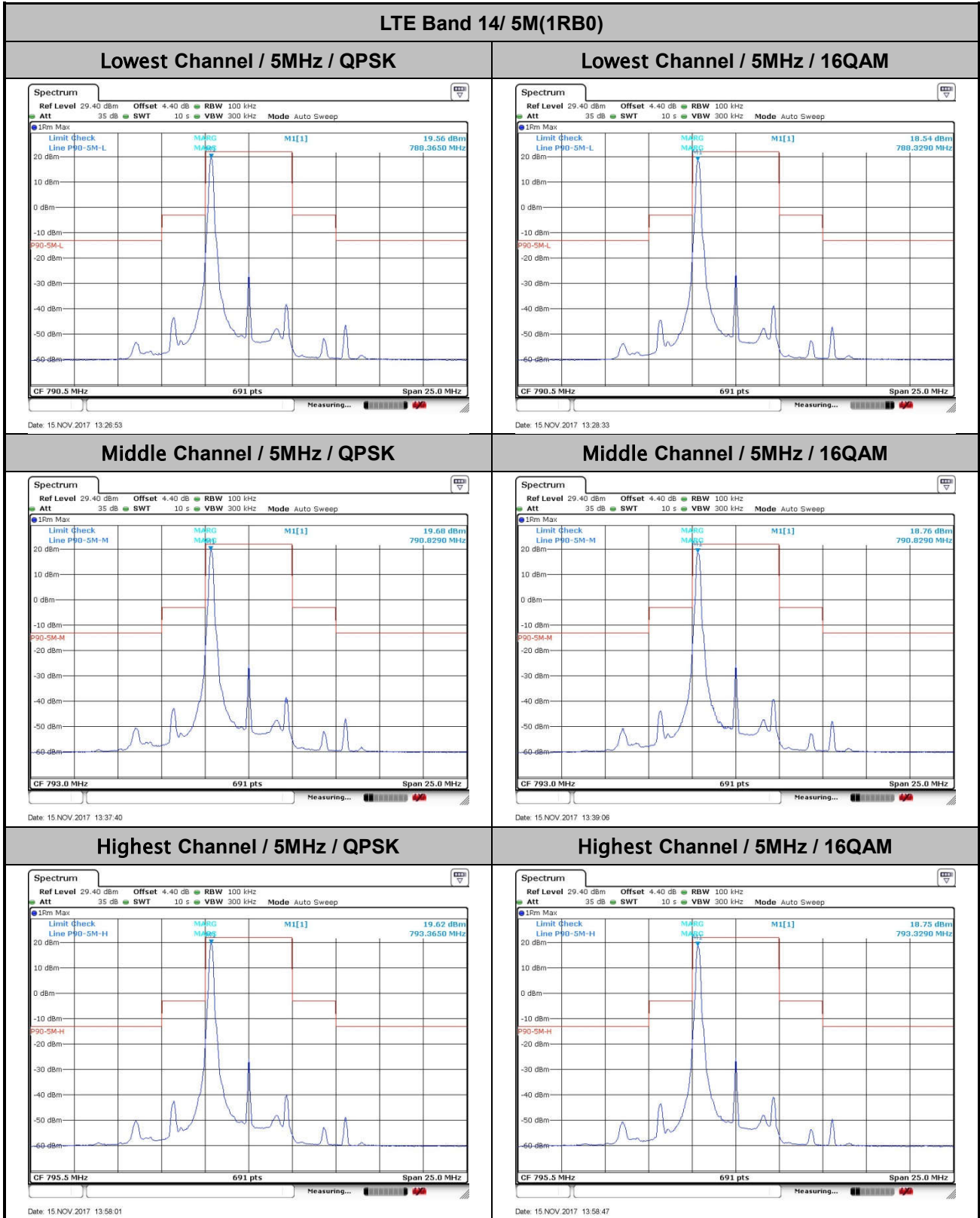



LTE Band 14/ 5M(1RBmax)

Lowest Channel / 5MHz / QPSK

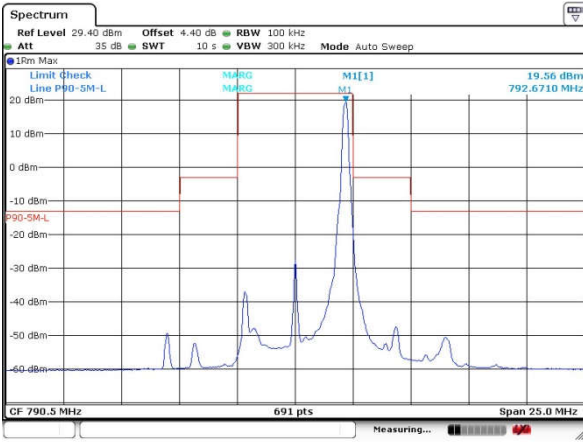

Date: 15 NOV 2017 13:30:25

Lowest Channel / 5MHz / 16QAM

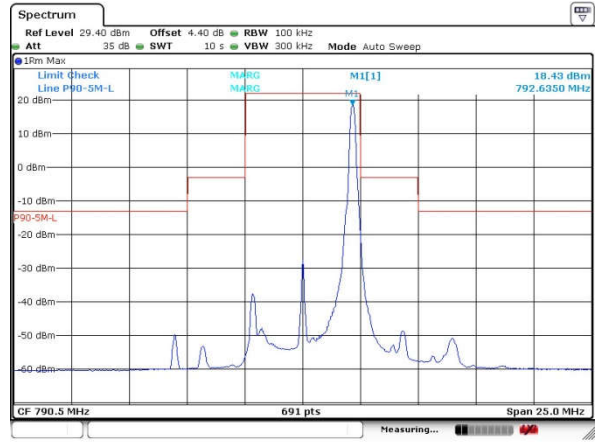

Date: 15 NOV 2017 13:29:24

Middle Channel / 5MHz / QPSK

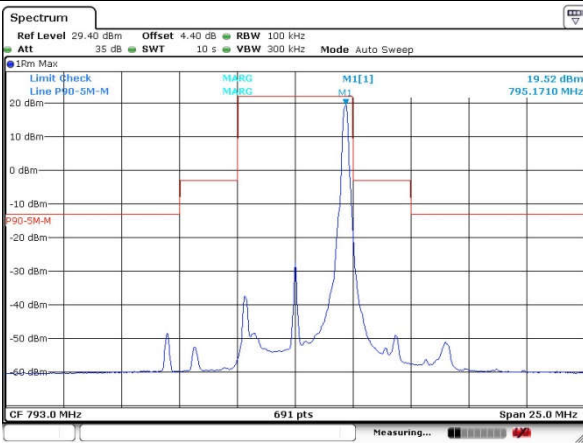

Date: 15 NOV 2017 13:46:53

Middle Channel / 5MHz / 16QAM

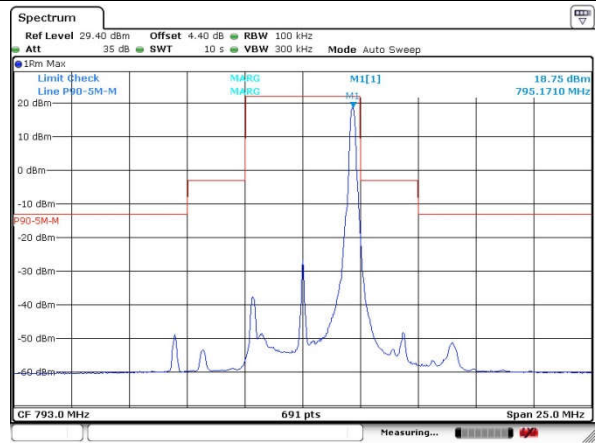

Date: 15 NOV 2017 13:42:59

Highest Channel / 5MHz / QPSK

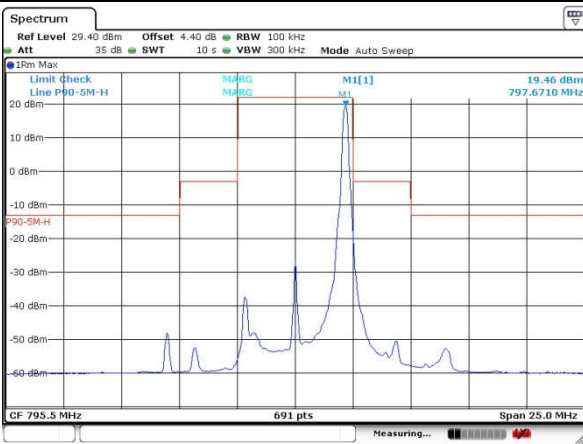

Date: 15 NOV 2017 14:02:53

Highest Channel / 5MHz / 16QAM

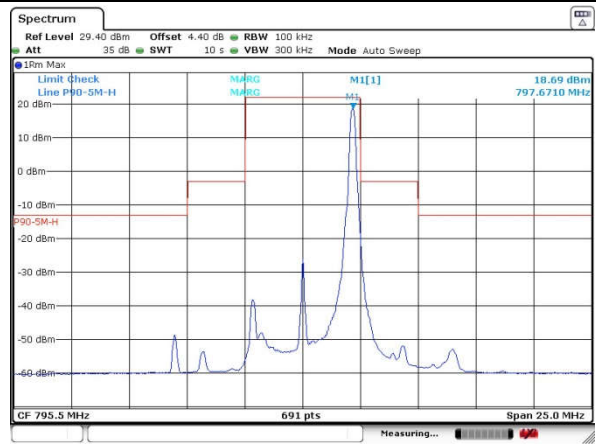

Date: 15 NOV 2017 14:01:33



LTE Band 14/ 5M(full RB)

Lowest Channel / 5MHz / QPSK

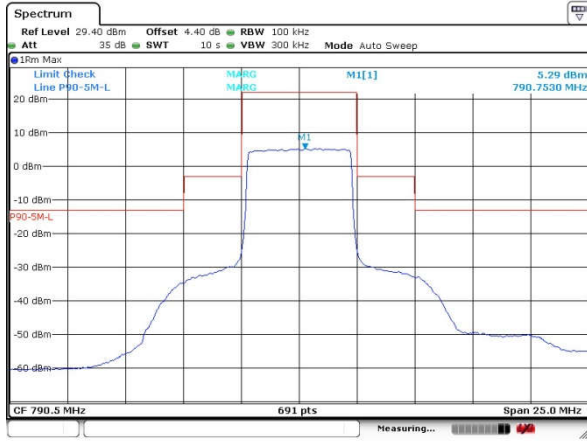

Lowest Channel / 5MHz / 16QAM

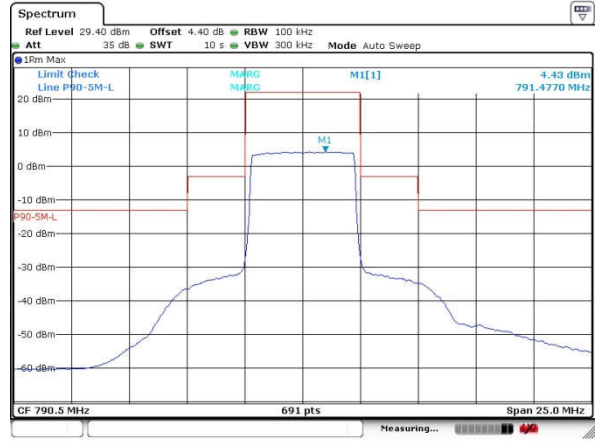

Middle Channel / 5MHz / QPSK



Middle Channel / 5MHz / 16QAM

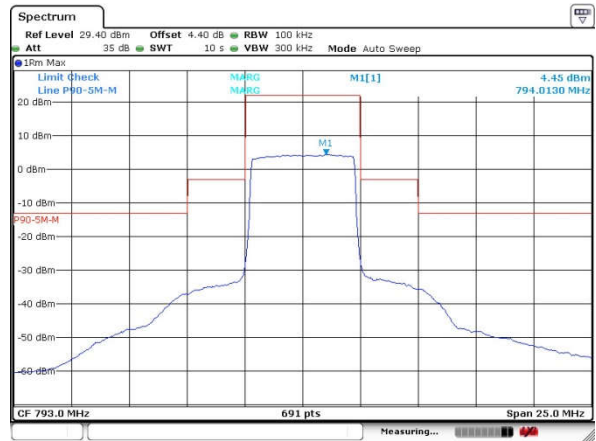

Highest Channel / 5MHz / QPSK

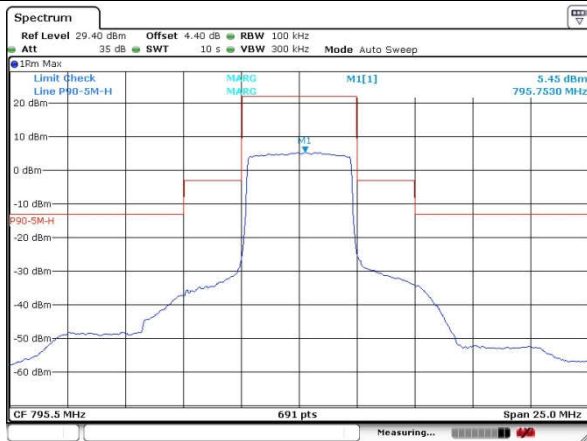

Highest Channel / 5MHz / 16QAM

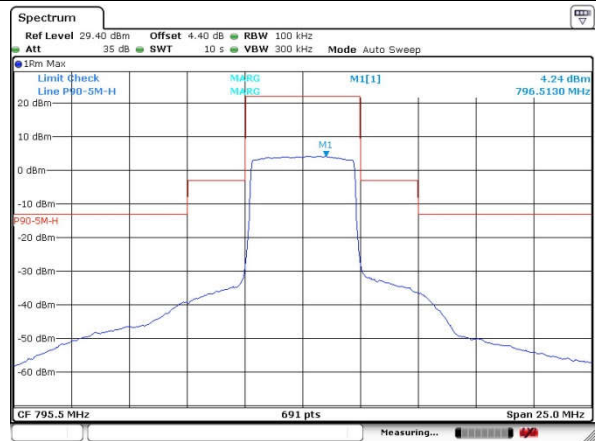



LTE Band 14/ 10MHz

Middle Channel / 1RB0 / QPSK

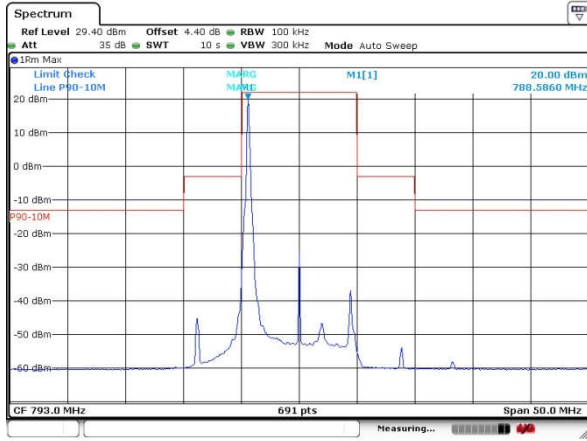

Date: 15 NOV 2017 14:08:58

Middle Channel / 1RB0 / 16QAM

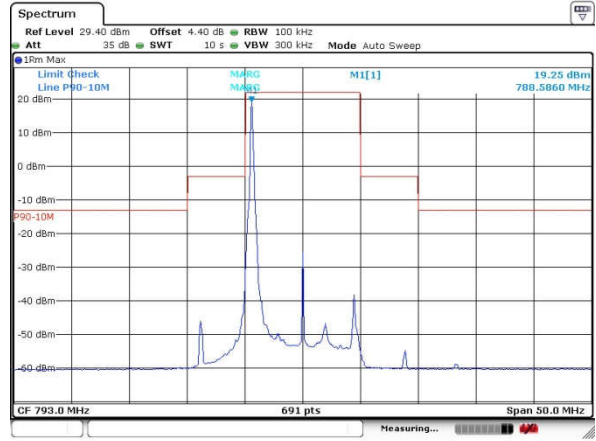

Date: 15 NOV 2017 14:08:18

Middle Channel / 1RBmax / QPSK

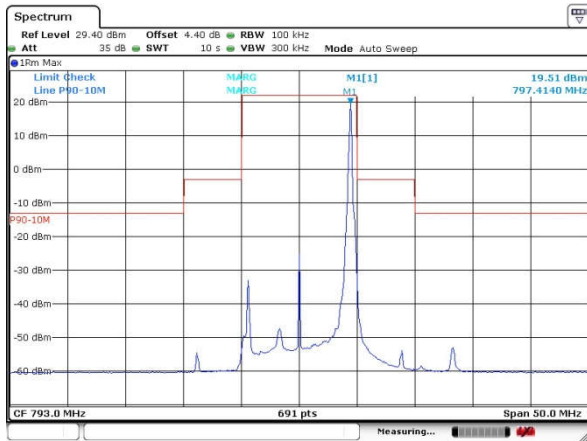

Date: 15 NOV 2017 14:09:48

Middle Channel / 1RBmax / 16QAM

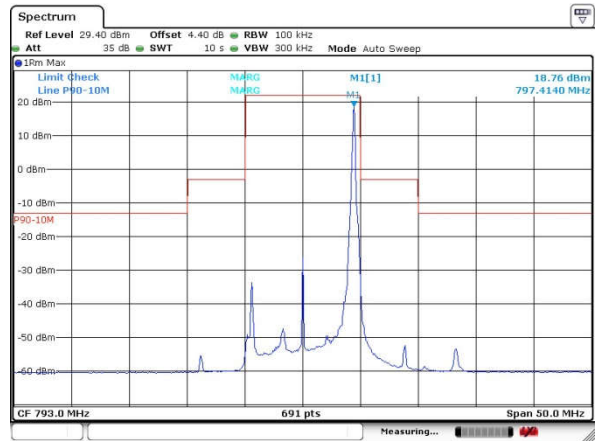

Date: 15 NOV 2017 14:10:37

Middle Channel / full RB / QPSK

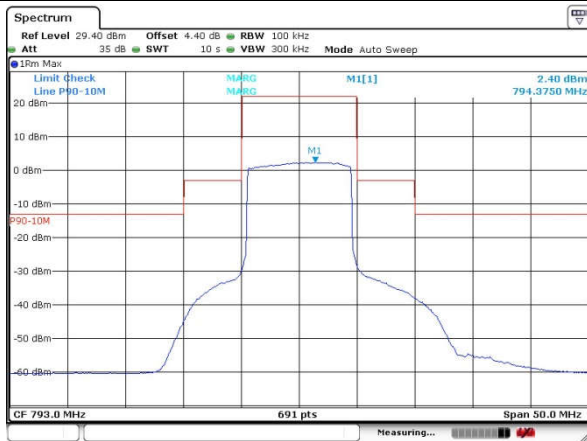

Date: 15 NOV 2017 14:04:43

Middle Channel / full RB / 16QAM

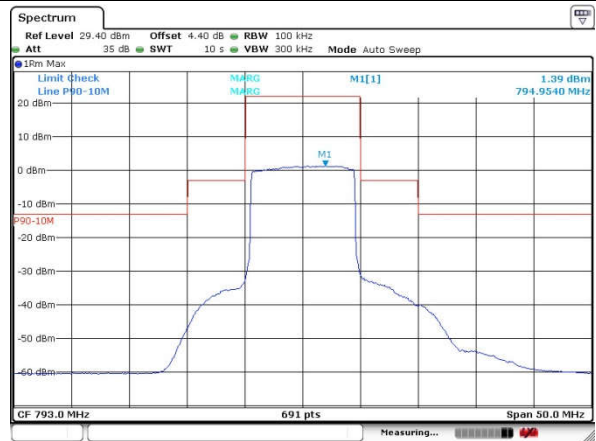

Date: 15 NOV 2017 14:05:49



Conducted Emission

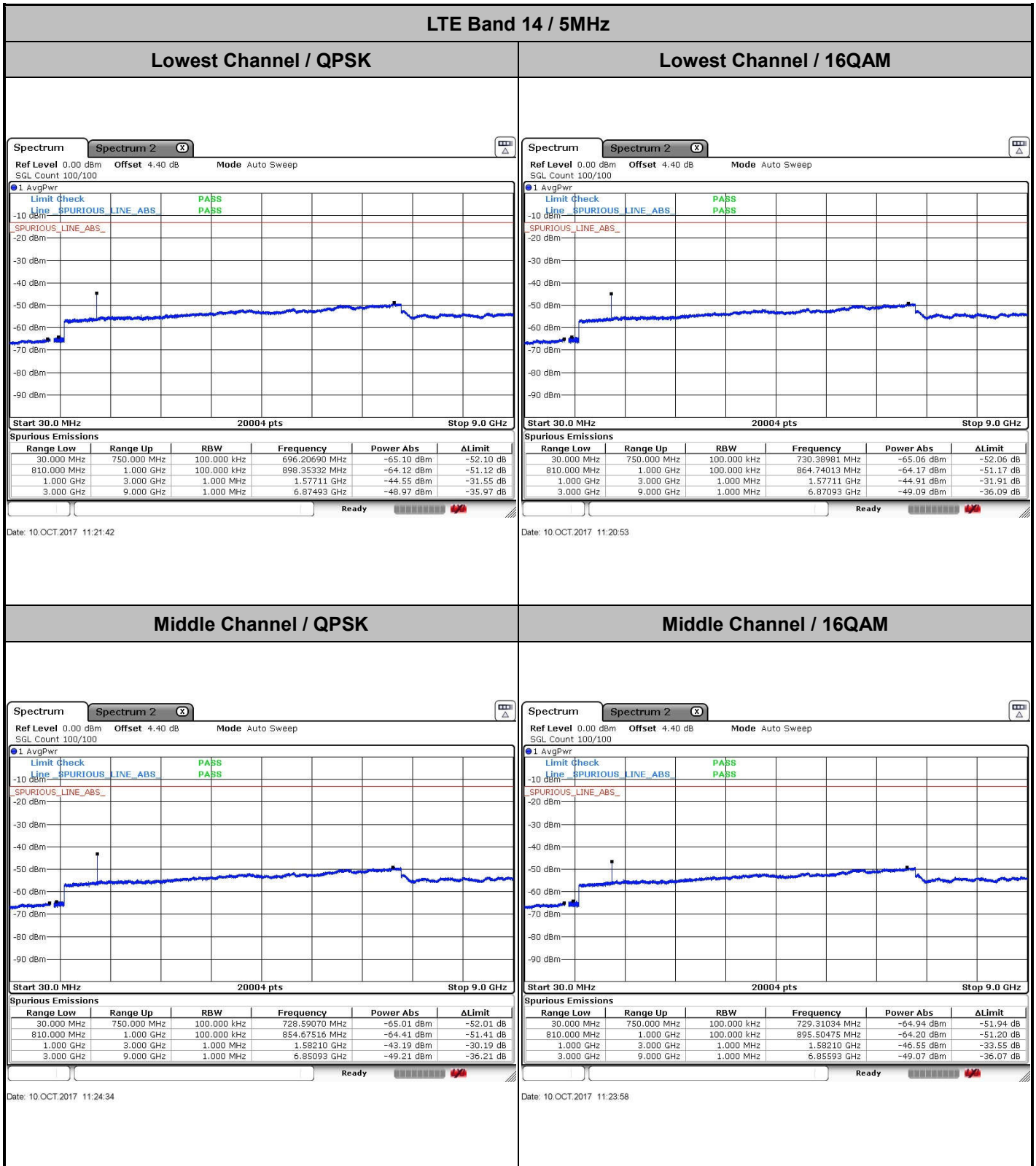



LTE Band 14 / 5MHz

Highest Channel / QPSK

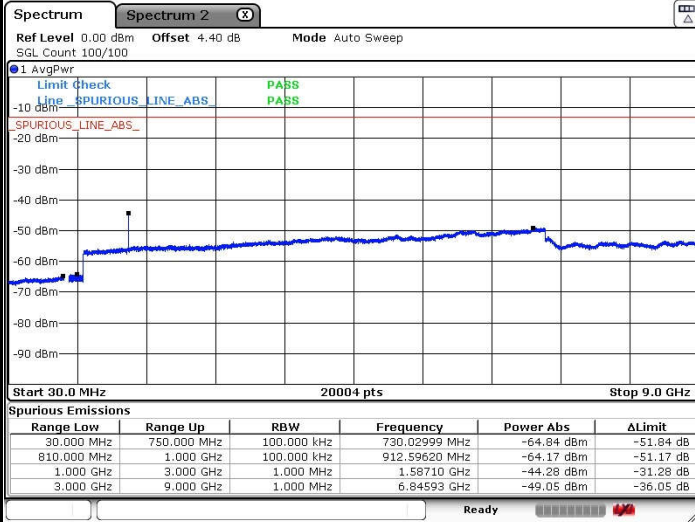

Date: 10.OCT.2017 11:25:17

Highest Channel / 16QAM

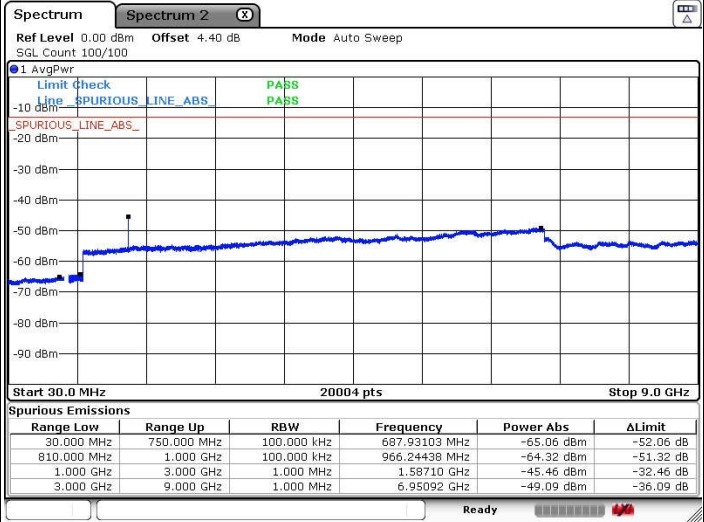

Date: 10.OCT.2017 11:25:48

LTE Band 14 / 10MHz

Middle Channel / QPSK

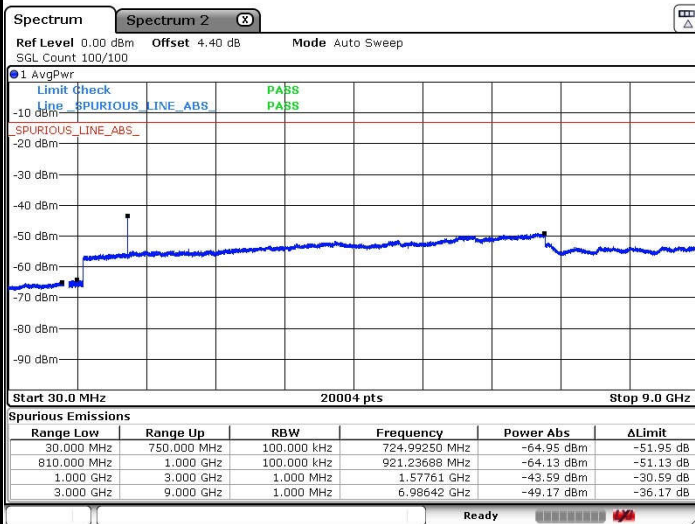

Date: 10.OCT.2017 11:16:06

Middle Channel / 16QAM

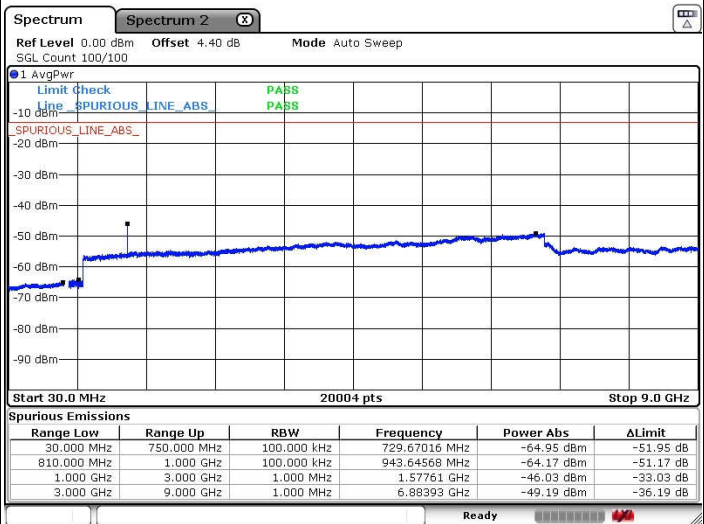

Date: 10.OCT.2017 11:16:53



Frequency Stability

Test Conditions		LTE Band 14(QPSK) / Middle Channel	Limit
Temperature (°C)	Voltage (Volt)	BW 10MHz	1.25ppm
		Deviation (ppm)	Result
50	Normal Voltage	0.0035	PASS
40	Normal Voltage	0.0004	
30	Normal Voltage	0.0042	
20(Ref.)	Normal Voltage	0.0000	
10	Normal Voltage	0.0028	
0	Normal Voltage	0.0024	
-10	Normal Voltage	0.0034	
-20	Normal Voltage	0.0049	
-30	Normal Voltage	0.0010	
20	Maximum Voltage	0.0024	
20	Normal Voltage	0.0025	
20	Battery End Point	0.0016	

Note: Normal Voltage =3.7 V. ; Battery End Point (BEP) =3.5 V. ; Maximum Voltage =4.2 V.



Appendix B. Test Results of Radiated Test

Field Strength of Spurious Radiated

LTE Band 14 / QPSK / RB Size 1 Offset 0									
Bandwidth	Frequency (MHz)	ERP (dBm)	Limit (dBm)	Over Limit (dB)	SPA Reading (dBm)	S.G. Power (dBm)	TX Cable loss (dB)	TX Antenna Gain (dBi)	Polarization (H/V)
5MHz	1581.5	-61.37	-40	-21.37	-71.20	-70.21	0.56	9.40	H
	2372.25	-64.69	-13	-51.69	-76.44	-72.40	0.74	10.60	H
	3163	-62.88	-13	-49.88	-76.54	-72.48	0.85	12.60	H
	1581.5	-61.09	-40	-21.09	-71.00	-69.93	0.56	9.40	V
	2372.25	-64.94	-13	-51.94	-76.31	-72.65	0.74	10.60	V
	3163	-62.97	-13	-49.97	-76.71	-72.57	0.85	12.60	V
10MHz	1577	-62.12	-40	-22.12	-76.13	-70.96	0.56	9.40	H
	2365.5	-64.71	-13	-51.71	-80.96	-72.42	0.74	10.60	H
	3154	-62.95	-13	-49.95	-80.71	-72.55	0.85	12.60	H
	1577	-60.72	-40	-20.72	-74.81	-69.56	0.56	9.40	V
	2365.5	-65.08	-13	-52.08	-81.01	-72.79	0.74	10.60	V
	3154	-63.32	-13	-50.32	-81.16	-72.92	0.85	12.60	V
Remark: Spurious emissions within 30-1000MHz were found more than 20dB below limit line.									
Test Result					PASS				