



FCC RF Test Report

APPLICANT : Sonim Technologies, Inc.
EQUIPMENT : LTE Phone
BRAND NAME : Sonim
MODEL NAME : XP5800(PC2111)
FCC ID : WYPPC2100
STANDARD : FCC 47 CFR Part 2, 22(H), 24(E), 27(L)
CLASSIFICATION : PCS Licensed Transmitter Held to Ear (PCE)

The product was received on Sep. 21, 2017 and testing was completed on Nov. 15, 2017. We, Sporton International (Kunshan) Inc., would like to declare that the tested sample has been evaluated in accordance with the test procedures given in ANSI/TIA-603-E and has been in compliance with the applicable technical standards.

This report contains data that were produced under subcontract by Laboratory SPORTON INTERNATIONAL INC.

The test results in this report apply exclusively to the tested model / sample. Without written approval of Sporton International (Kunshan) Inc., the test report shall not be reproduced except in full.



Approved by: James Huang / Manager

Sporton International (Kunshan) Inc.
No.3-2 Ping-Xiang Rd, Kunshan Development Zone Kunshan City Jiangsu Province 215335
China



TABLE OF CONTENTS

- 1 GENERAL DESCRIPTION 5**
 - 1.1 Applicant..... 5
 - 1.2 Manufacturer 5
 - 1.3 Product Feature of Equipment Under Test 5
 - 1.4 Product Specification of Equipment Under Test 6
 - 1.5 Modification of EUT 7
 - 1.6 Maximum ERP/EIRP Power, Frequency Tolerance, and Emission Designator 7
 - 1.7 Testing Location 7
 - 1.8 Applicable Standards 8
- 2 TEST CONFIGURATION OF EQUIPMENT UNDER TEST 9**
 - 2.1 Test Mode..... 9
 - 2.2 Connection Diagram of Test System 10
 - 2.3 Support Unit used in test configuration 10
 - 2.4 Measurement Results Explanation Example 10
- 3 CONDUCTED TEST RESULT 11**
 - 3.1 Measuring Instruments..... 11
 - 3.2 Test Setup 11
 - 3.3 Test Result of Conducted Test..... 11
 - 3.4 Conducted Output Power and ERP/EIRP 12
 - 3.5 Peak-to-Average Ratio 13
 - 3.6 99% Occupied Bandwidth and 26dB Bandwidth Measurement..... 14
 - 3.7 Conducted Band Edge 15
 - 3.8 Conducted Spurious Emission 16
 - 3.9 Frequency Stability..... 17
- 4 RADIATED TEST ITEMS 18**
 - 4.1 Measuring Instruments..... 18
 - 4.2 Test Setup 18
 - 4.3 Test Result of Radiated Test..... 18
 - 4.4 Field Strength of Spurious Radiation Measurement 19
- 5 LIST OF MEASURING EQUIPMENT 20**
- 6 UNCERTAINTY OF EVALUATION 22**
- APPENDIX A. TEST RESULTS OF CONDUCTED TEST**
- APPENDIX B. TEST RESULTS OF RADIATED TEST**
- APPENDIX C. TEST SETUP PHOTOGRAPHS**



REVISION HISTORY

REPORT NO.	VERSION	DESCRIPTION	ISSUED DATE
FG792101A	Rev. 01	Initial issue of report	Dec. 04, 2017



SUMMARY OF TEST RESULT

Report Section	FCC Rule	Description	Limit	Result	Remark
3.4	§2.1046	Conducted Output Power	Reporting Only	PASS	-
	§22.913(a)(2)	Effective Radiated Power	< 7 Watts	PASS	-
	§24.232(c)	Equivalent Isotropic Radiated Power	< 2 Watts	PASS	-
	§27.50(d)(4)	Equivalent Isotropic Radiated Power	< 1 Watts	PASS	-
3.5	§24.232(d)	Peak-to-Average Ratio	< 13 dB	PASS	-
3.6	§2.1049 §22.917(b) §24.238(b) §27.53(g)	Occupied Bandwidth	Reporting Only	PASS	-
3.7	§2.1051 §22.917(a) §24.238(a) §27.53(h)	Band Edge Measurement	< 43+10log10(P[Watts])	PASS	-
3.8	§2.1051 §22.917(a) §24.238(a) §27.53(h)	Conducted Emission	< 43+10log10(P[Watts])	PASS	-
3.9	§2.1055 §22.355	Frequency Stability for Temperature & Voltage	< 2.5 ppm for Part 22H	PASS	-
	§2.1055 §24.235		Within Authorized Band		
4.4	§2.1053 §22.917(a) §24.238(a) §27.53(h)	Field Strength of Spurious Radiation	< 43+10log10(P[Watts])	PASS	Under limit 32.67 dB at 1672.00 MHz



1 General Description

1.1 Applicant

Sonim Technologies, Inc.
1825 S. Grant St., Suite 200., San Mateo, CA, 94402

1.2 Manufacturer

Sonim Technologies (Shenzhen) Limited
2nd Floor, No. 2 Building Phase B, Daqian Industrial park, Longchang Road, 67 District, Baoan, Shenzhen, P. R. China

1.3 Product Feature of Equipment Under Test

Product Feature	
Equipment	LTE Phone
Brand Name	Sonim
Model Name	XP5800(PC2111)
FCC ID	WYPPC2100
EUT supports Radios application	CDMA/EV-DO/GSM/GPRS/EGPRS/WCDMA/HSPA/DC-HSDPA/HSPA+(16QAM uplink is not supported)/LTE WLAN 2.4GHz 802.11b/g/n HT20/HT40 WLAN 5GHz 802.11a/n HT20/HT40 Bluetooth v3.0 + EDR/Bluetooth v4.0 LE /Bluetooth v4.2 LE
IMEI Code	Conducted: 001080001908558/001080001908558 Radiation: 001080001912824/001080001912832 for GSM/WCDMA 001080001912451/ 001080001912444 for CDMA
HW Version	A
SW Version	5SA.0.0-00-7.1.2-00.25.01
EUT Stage	Identical Prototype

Remark: The above EUT's information was declared by manufacturer. Please refer to the specifications or user's manual for more detailed description.



1.4 Product Specification of Equipment Under Test

Standards-related Product Specification	
Tx Frequency	<p>GSM/GPRS/EDGE: 850: 824.2 MHz ~ 848.8 MHz 1900: 1850.2 MHz ~ 1909.8MHz</p> <p>WCDMA: Band V: 826.4 MHz ~ 846.6 MHz Band II: 1852.4 MHz ~ 1907.6 MHz Band IV: 1712.4 MHz ~ 1752.6 MHz</p> <p>CDMA2000: BC0: 824.70 MHz ~ 848.31 MHz BC1: 1851.25 MHz ~ 1908.75 MHz</p>
Rx Frequency	<p>GSM/GPRS/EDGE: 850: 869.2 MHz ~ 893.8 MHz 1900: 1930.2 MHz ~ 1989.8 MHz</p> <p>WCDMA: Band V: 871.4 MHz ~ 891.6 MHz Band II: 1932.4 MHz ~ 1987.6 MHz Band IV: 2112.4 MHz ~ 2152.6 MHz</p> <p>CDMA2000: BC0: 869.70 MHz ~ 893.31 MHz BC1: 1931.25 MHz ~ 1988.75 MHz</p>
Maximum Output Power to Antenna	<p>GSM/GPRS/EDGE: 850: 32.08 dBm 1900: 29.74 dBm</p> <p>WCDMA: Band V: 22.63 dBm Band II: 23.10 dBm Band IV: 23.04 dBm</p> <p>CDMA2000: BC0: 23.99 dBm BC1: 24.25 dBm</p>
Antenna Type	PIFA Antenna
Antenna Gain	Cellular Band: -1.0 dBi PCS Band: -1.0 dBi AWS Band: -1.0 dBi
Type of Modulation	GSM/GPRS: GMSK EDGE: GMSK / 8PSK HSDPA/DC-HSDPA : QPSK (Uplink) HSUPA: QPSK (Uplink) DC-HSDPA : 64QAM HSPA+ : 16QAM (uplink is not supported) CDMA2000 1xRTT: QPSK CDMA2000 1xEV-DO: QPSK/8PSK



1.5 Modification of EUT

No modifications are made to the EUT during all test items.

1.6 Maximum ERP/EIRP Power, Frequency Tolerance, and Emission Designator

FCC Rule	System	Type of Modulation	Maximum ERP/EIRP (W)	Frequency Tolerance (ppm)	Emission Designator
Part 22H	GSM850 GSM	GMSK	0.7816	0.0096 ppm	243KGXW
Part 22H	GSM850 EDGE class 8	8PSK	0.1845	0.0395 ppm	248KG7W
Part 22H	WCDMA Band V RMC 12.2Kbps	BPSK	0.0887	0.0239 ppm	4M15F9W
Part 22H	CDMA2000 BC0 1xRTT	QPSK	0.1213	0.0335 ppm	1M27F9W
Part 24E	GSM1900 GSM	GMSK	0.7482	0.0191 ppm	243KGXW
Part 24E	GSM1900 EDGE class 8	8PSK	0.2630	0.0218 ppm	245KG7W
Part 24E	WCDMA Band II RMC 12.2Kbps	BPSK	0.1622	0.0064 ppm	4M16F9W
Part 24E	CDMA2000 BC1 1xRTT	QPSK	0.2113	0.0122 ppm	1M28F9W
Part 27L	WCDMA Band IV RMC 12.2Kbps	BPSK	0.1600	0.0139 ppm	4M13F9W

1.7 Testing Location

Sporton Lab is accredited to ISO 17025 by National Voluntary Laboratory Accreditation Program (NVLAP code: 600155-0) and the FCC designation No. is CN5013.

Test Site	Sporton International (Kunshan) Inc.	
Test Site Location	No.3-2 Ping-Xiang Rd, Kunshan Development Zone Kunshan City Jiangsu Province 215335 China TEL: +86-512-57900158 FAX: +86-512-57900958	
Test Site No.	Sporton Site No.	
	TH01-KS	03CH03-KS
FCC Test Firm Registration No.	630927	

Note: The test site complies with ANSI C63.4 2014 requirement.



SPORTON INTERNATIONAL INC. is accredited to ISO 17025 by Taiwan Accreditation Foundation (TAF code : 1190) and the FCC designation No. TW0007 under the FCC-recognized accredited testing laboratories by Mutual Recognition Agreement (MRA) in FCC Test.

Test Site	SPORTON INTERNATIONAL INC.
Test Site Location	No.58, Aly. 75, Ln. 564, Wenhua 3rd Rd., Guishan Dist., Taoyuan City 333, Taiwan (R.O.C.) TEL: +886-3-327-3456 FAX: +886-3-328-4978
Test Site No.	Sporton Site No.
	03CH15-HY
FCC Test Firm Registration No.	214511

Note:

1. The test site complies with ANSI C63.4 2014 requirement.
2. Test data subcontracted: radiated spurious emissions for CDMA band only in section 4.4 of this report.

1.8 Applicable Standards

According to the specifications of the manufacturer, the EUT must comply with the requirements of the following standards:

- 47 CFR Part 2, 22(H), 24(E), 27(L)
- ANSI/TIA-603-E
- FCC KDB 971168 D01 Power Meas. License Digital Systems v03
- FCC KDB 412172 D01 Determining ERP and EIRP v01r01

Remark:

1. All test items were verified and recorded according to the standards and without any deviation during the test.
2. This EUT has also been tested and complied with the requirements of FCC Part 15, Subpart B, recorded in a separate test report.



2 Test Configuration of Equipment Under Test

2.1 Test Mode

Antenna port conducted and radiated test items were performed according to KDB 971168 D01 Power Meas. License Digital Systems v03 with maximum output power.

Radiated measurements were performed with rotating EUT in different three orthogonal test planes to find the maximum emission.

Radiated emissions were investigated as following frequency range:

1. 30 MHz to 10th harmonic for GSM850 and WCDMA Band V and CDMA BC0.
2. 30 MHz to 10th harmonic for WCDMA Band IV.
3. 30 MHz to 10th harmonic for GSM1900 and WCDMA Band II and CDMA BC1.

All modes and data rates and positions were investigated.

Test modes are chosen to be reported as the worst case configuration below:

Test Modes		
Band	Radiated TCs	Conducted TCs
GSM 850	<ul style="list-style-type: none"> ■ GSM Link ■ EDGE class 8 Link 	<ul style="list-style-type: none"> ■ GSM Link ■ EDGE class 8 Link
GSM 1900	<ul style="list-style-type: none"> ■ GSM Link ■ EDGE class 8 Link 	<ul style="list-style-type: none"> ■ GSM Link ■ EDGE class 8 Link
WCDMA Band V	<ul style="list-style-type: none"> ■ RMC 12.2Kbps Link 	<ul style="list-style-type: none"> ■ RMC 12.2Kbps Link
WCDMA Band II	<ul style="list-style-type: none"> ■ RMC 12.2Kbps Link 	<ul style="list-style-type: none"> ■ RMC 12.2Kbps Link
WCDMA Band IV	<ul style="list-style-type: none"> ■ RMC 12.2Kbps Link 	<ul style="list-style-type: none"> ■ RMC 12.2Kbps Link
CDMA BC0	<ul style="list-style-type: none"> ■ 1xRTT Link 	<ul style="list-style-type: none"> ■ 1xRTT Link
CDMA BC1	<ul style="list-style-type: none"> ■ 1xRTT Link 	<ul style="list-style-type: none"> ■ 1xRTT Link

2.2 Connection Diagram of Test System

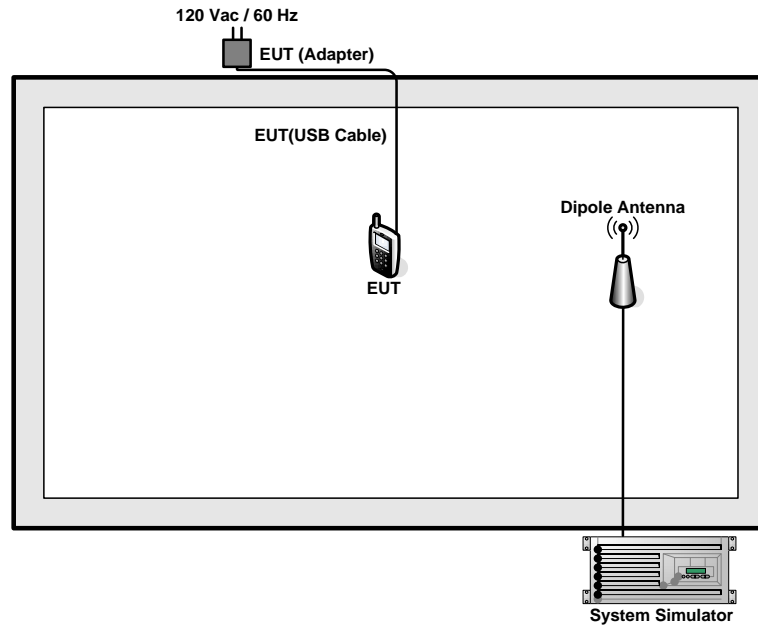

2.3 Support Unit used in test configuration

Item	Equipment	Trade Name	Model No.	FCC ID	Data Cable	Power Cord
1.	System Simulator	R&S	CMU 200	N/A	N/A	Unshielded, 1.8 m
2.	DC Power Supply	GW INSTRON	GPS-3030D	N/A	N/A	Unshielded, 1.8 m

2.4 Measurement Results Explanation Example

For all conducted test items:

The offset level is set in the spectrum analyzer to compensate the RF cable loss and attenuator factor between RF conducted output port and spectrum analyzer. With the offset compensation, the spectrum analyzer reading level will be exactly the RF output level.

The spectrum analyzer offset is derived from RF cable loss and attenuator factor.

$$\text{Offset} = \text{RF cable loss} + \text{attenuator factor}.$$

The following shows an offset computation example with RF cable loss 4.4 dB and a 10dB attenuator.

Example :

$$\begin{aligned} \text{Offset(dB)} &= \text{RF cable loss(dB)} + \text{attenuator factor(dB)}. \\ &= 4.4 + 10 = 14.4 \text{ (dB)} \end{aligned}$$

3 Conducted Test Result

3.1 Measuring Instruments

See list of measuring instruments of this test report.

3.2 Test Setup

3.2.1 Conducted Output Power

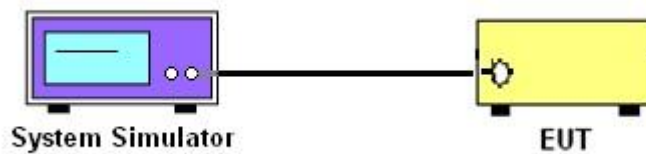

3.2.2 Peak-to-Average Ratio, Occupied Bandwidth, Conducted Band-Edge and Conducted Spurious Emission

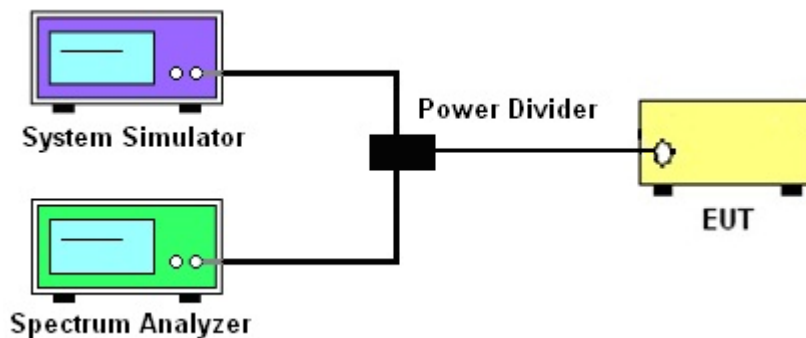

3.2.3 Frequency Stability

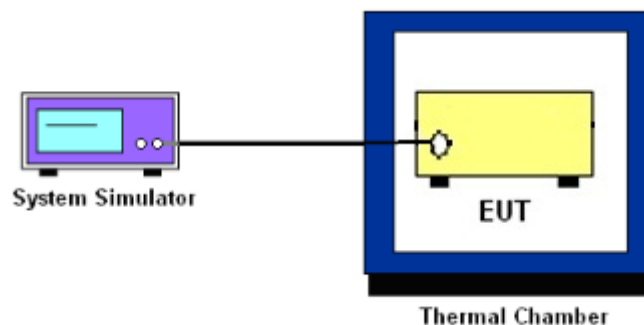

3.3 Test Result of Conducted Test

Please refer to Appendix A.



3.4 Conducted Output Power and ERP/EIRP

3.4.1 Description of the Conducted Output Power and ERP/EIRP

A system simulator was used to establish communication with the EUT. Its parameters were set to enforce EUT transmitting at the maximum power. The measured power in the radio frequency on the transmitter output terminals shall be reported.

The ERP of mobile transmitters must not exceed 7 Watts for GSM850 and WCDMA Band V and CDMA BC0.

The EIRP of mobile transmitters must not exceed 2 Watts for GSM1900 and WCDMA Band II and CDMA BC1.

The EIRP of mobile transmitters must not exceed 1 Watts for WCDMA Band IV.

According to KDB 412172 D01 Power Approach,

$EIRP = P_T + G_T - L_C$, $ERP = EIRP - 2.15$, where

P_T = transmitter output power in dBm

G_T = gain of the transmitting antenna in dBi

L_C = signal attenuation in the connecting cable between the transmitter and antenna in dB

3.4.2 Test Procedures

1. The transmitter output port was connected to the system simulator.
2. Set EUT at maximum power through system simulator.
3. Select lowest, middle, and highest channels for each band and different modulation.
4. Measure the maximum burst average power for GSM and maximum average power for other modulation signal.



3.5 Peak-to-Average Ratio

3.5.1 Description of the PAR Measurement

The peak-to-average ratio (PAR) of the transmission may not exceed 13 dB.

3.5.2 Test Procedures

1. The testing follows FCC KDB 971168 D01 v03 Section 5.7.1.
2. The EUT was connected to spectrum analyzer and system simulator via a power divider.
3. Set EUT to transmit at maximum output power.
4. When the duty cycle is less than 98%, then signal gating will be implemented on the spectrum analyzer by triggering from the system simulator.
5. Set the CCDF (Complementary Cumulative Distribution Function) option of the spectrum analyzer.
Record the maximum PAPR level associated with a probability of 0.1%.



3.6 99% Occupied Bandwidth and 26dB Bandwidth Measurement

3.6.1 Description of 99% Occupied Bandwidth and 26dB Bandwidth Measurement

The occupied bandwidth is the width of a frequency band such that, below the lower and above the upper frequency limits, the mean powers emitted are each equal to a specified percentage 0.5% of the total mean transmitted power.

The 26 dB emission bandwidth is defined as the frequency range between two points, one above and one below the carrier frequency, at which the spectral density of the emission is attenuated 26 dB below the maximum in-band spectral density of the modulated signal. Spectral density (power per unit bandwidth) is to be measured with a detector of resolution bandwidth equal to approximately 1.0% of the emission bandwidth.

3.6.2 Test Procedures

1. The testing follows FCC KDB 971168 v03 Section 4.2.
2. The EUT was connected to spectrum analyzer and system simulator via a power divider.
3. The spectrum analyzer center frequency is set to the nominal EUT channel center frequency. The span range for the spectrum analyzer shall be between two and five times the anticipated OBW.
4. The nominal resolution bandwidth (RBW) shall be in the range of 1 to 5 % of the anticipated OBW, and the VBW shall be at least 3 times the RBW.
5. Set the detection mode to peak, and the trace mode to max hold.
6. Determine the reference value: Set the EUT to transmit a modulated signal. Allow the trace to stabilize. Set the spectrum analyzer marker to the highest level of the displayed trace.
(this is the reference value)
7. Determine the “-26 dB down amplitude” as equal to (Reference Value – X).
8. Place two markers, one at the lowest and the other at the highest frequency of the envelope of the spectral display such that each marker is at or slightly below the “-X dB down amplitude” determined in step 6. If a marker is below this “-X dB down amplitude” value it shall be placed as close as possible to this value. The OBW is the positive frequency difference between the two markers.
9. Use the 99 % power bandwidth function of the spectrum analyzer and report the measured bandwidth.



3.7 Conducted Band Edge

3.7.1 Description of Conducted Band Edge Measurement

The power of any emission outside of the authorized operating frequency ranges must be lower than the transmitter power (P) by a factor of at least $43 + 10 \log (P)$ dB.

3.7.2 Test Procedures

1. The testing follows FCC KDB 971168 D01 v03 Section 6.0.
2. The EUT was connected to the spectrum analyzer and system simulator via a power divider.
3. The RF output of EUT was connected to the spectrum analyzer by an RF cable and attenuator. The path loss was compensated to the results for each measurement.
4. The band edges of low and high channels for the highest RF powers were measured.
5. The RF fundamental frequency should be excluded against the limit line in the operating frequency band.
6. The limit line is derived from $43 + 10\log(P)$ dB below the transmitter power P(Watts)
 $= P(W) - [43 + 10\log(P)]$ (dB)
 $= [30 + 10\log(P)]$ (dBm) - $[43 + 10\log(P)]$ (dB)
 $= -13\text{dBm}$.



3.8 Conducted Spurious Emission

3.8.1 Description of Conducted Spurious Emission Measurement

The power of any emission outside of the authorized operating frequency ranges must be lower than the transmitter power (P) by a factor of at least $43 + 10 \log (P)$ dB.

It is measured by means of a calibrated spectrum analyzer and scanned from 30 MHz up to a frequency including its 10th harmonic.

3.8.2 Test Procedures

1. The testing follows FCC KDB 971168 D01 v03 Section 6.0.
2. The EUT was connected to the spectrum analyzer and system simulator via a power divider.
3. The RF output of EUT was connected to the spectrum analyzer by an RF cable and attenuator. The path loss was compensated to the results for each measurement.
4. The middle channel for the highest RF power within the transmitting frequency was measured.
5. The conducted spurious emission for the whole frequency range was taken.
6. The RF fundamental frequency should be excluded against the limit line in the operating frequency band.
7. The limit line is derived from $43 + 10\log(P)$ dB below the transmitter power P(Watts)
= $P(W) - [43 + 10\log(P)]$ (dB)
= $[30 + 10\log(P)]$ (dBm) - $[43 + 10\log(P)]$ (dB)
= -13dBm.



3.9 Frequency Stability

3.9.1 Description of Frequency Stability Measurement

The frequency stability shall be measured by variation of ambient temperature and variation of primary supply voltage to ensure that the fundamental emission stays within the authorized frequency block. The frequency stability of the transmitter shall be maintained within $\pm 0.00025\%$ ($\pm 2.5\text{ppm}$) of the center frequency.

3.9.2 Test Procedures for Temperature Variation

1. The testing follows FCC KDB 971168 D01 v03 Section 9.0.
2. The EUT was set up in the thermal chamber and connected with the system simulator.
3. With power OFF, the temperature was decreased to -30°C and the EUT was stabilized before testing. Power was applied and the maximum change in frequency was recorded within one minute.
4. With power OFF, the temperature was raised in 10°C steps up to 50°C . The EUT was stabilized at each step for at least half an hour. Power was applied and the maximum frequency change was recorded within one minute.

3.9.3 Test Procedures for Voltage Variation

1. The testing follows FCC KDB 971168 D01 v03 Section 9.0.
2. The EUT was placed in a temperature chamber at $20\pm 5^{\circ}\text{C}$ and connected with the system simulator.
3. The power supply voltage to the EUT was varied from 85% to 115% of the nominal value measured at the input to the EUT.
4. The variation in frequency was measured for the worst case.

4 Radiated Test Items

4.1 Measuring Instruments

See list of measuring instruments of this test report.

4.2 Test Setup

4.2.1 For radiated test from 30MHz to 1GHz

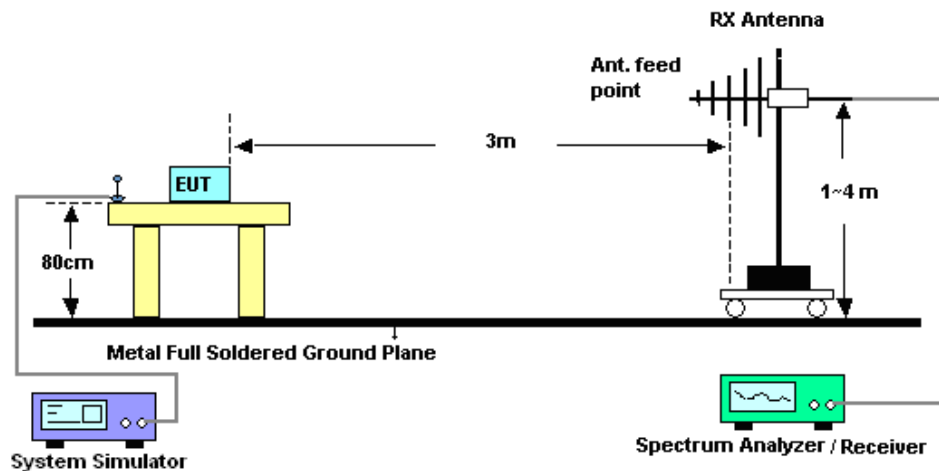

4.2.2 For radiated test above 1GHz

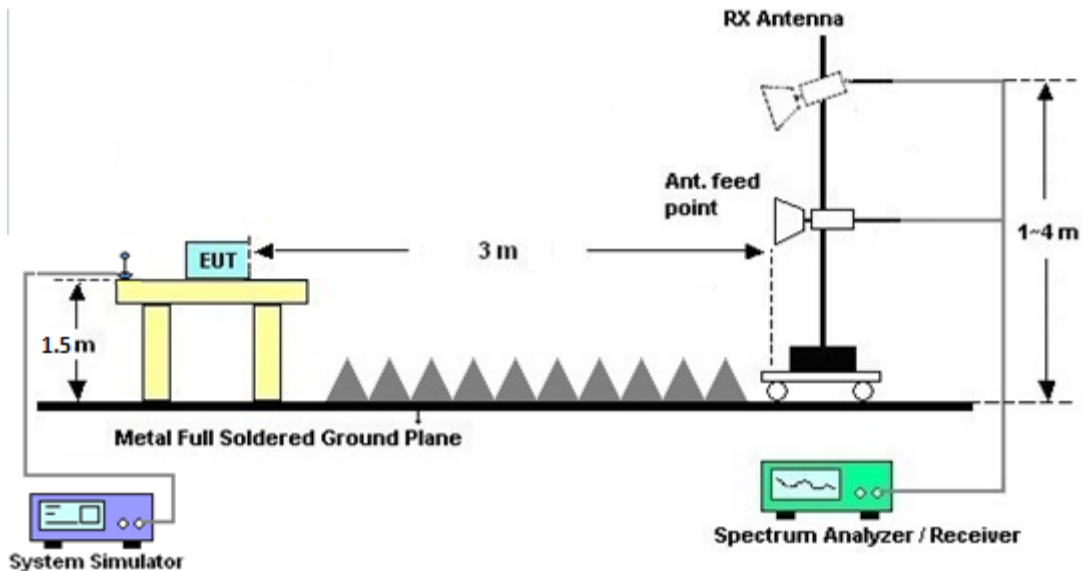

4.3 Test Result of Radiated Test

Please refer to Appendix B.



4.4 Field Strength of Spurious Radiation Measurement

4.4.1 Description of Field Strength of Spurious Radiated Measurement

The power of any emission outside of the authorized operating frequency ranges must be attenuated below the transmitter power (P) by a factor of at least $43 + 10 \log (P)$ dB. The spectrum is scanned from 30 MHz up to a frequency including its 10th harmonic.

4.4.2 Test Procedures

1. The testing follows FCC KDB 971168 D01 v03 Section 5.8 and ANSI/TIA-603-E Section 2.2.12.
2. The EUT was placed on a rotatable wooden table 0.8 meters for frequency below 1GHz and 1.5 meter for frequency above 1GHz above the ground.
3. The EUT was set 3 meters from the receiving antenna, which was mounted on the antenna tower.
4. The table was rotated 360 degrees to determine the position of the highest spurious emission.
5. The height of the receiving antenna is varied between one meter and four meters to search for the maximum spurious emission for both horizontal and vertical polarizations.
6. Make the measurement with the spectrum analyzer's RBW = 1MHz, VBW = 3MHz, taking record of maximum spurious emission.
7. A horn antenna was substituted in place of the EUT and was driven by a signal generator.
8. Tune the output power of signal generator to the same emission level with EUT maximum spurious emission.
9. Taking the record of output power at antenna port.
10. Repeat step 7 to step 8 for another polarization.
11. $EIRP \text{ (dBm)} = S.G. \text{ Power} - Tx \text{ Cable Loss} + Tx \text{ Antenna Gain}$
12. $ERP \text{ (dBm)} = EIRP - 2.15$
13. The RF fundamental frequency should be excluded against the limit line in the operating frequency band.
14. The limit line is derived from $43 + 10\log(P)$ dB below the transmitter power P(Watts)
 $= P(W) - [43 + 10\log(P)] \text{ (dB)}$
 $= [30 + 10\log(P)] \text{ (dBm)} - [43 + 10\log(P)] \text{ (dB)}$
 $= -13\text{dBm}.$



5 List of Measuring Equipment

Instrument	Manufacturer	Model No.	Serial No.	Characteristics	Calibration Date	Test Date	Due Date	Remark
Spectrum Analyzer	R&S	FSV40	101040	10Hz~40GHz	Aug. 08, 2017	Aug. 16, 2017~ Nov. 15, 2017	Aug. 07, 2018	Conducted (TH01-KS)
Radio communication analyzer	Anritsu	MT8820C	6201300652	2G/3G/LTE_ full band	Aug. 08, 2017	Aug. 16, 2017~ Nov. 15, 2017	Aug. 07, 2018	Conducted (TH01-KS)
Thermal Chamber	Humidity	LP-150U	HZ014011440	-40~+150°C 20%~95%RH	Apr. 18, 2017	Aug. 16, 2017~ Nov. 15, 2017	Apr. 17, 2018	Conducted (TH01-KS)
EXA Spectrum Analyzer	Keysight	N9010A	MY55150244	10Hz~44GHz	Apr. 18, 2017	Oct. 13, 2017	Apr. 17, 2018	Radiation (03CH03-KS)
Bilog Antenna	TeseQ	CBL6112D	35406	25MHz~2GHz	Apr. 22, 2017	Oct. 13, 2017	Apr. 21, 2018	Radiation (03CH03-KS)
Horn Antenna	Schwarzbeck	BBHA9120 D	9120D-1356	1GHz~18GHz	Apr. 22, 2017	Oct. 13, 2017	Apr. 21, 2018	Radiation (03CH03-KS)
SHF-EHF Horn	Schwarzbeck	BBHA 9170	BBHA170249	15GHz~40GHz	Feb. 15, 2017	Oct. 13, 2017	Feb. 14, 2018	Radiation (03CH03-KS)
Amplifier	com-power	PA-103A	161069	1MHz~1000MHz / 32 dB	Apr. 18, 2017	Oct. 13, 2017	Apr. 17, 2018	Radiation (03CH03-KS)
high gain Amplifier	MITEQ	AMF-7D-00 101800-30-	2025788	1GHz~18GHz	Apr. 18, 2017	Oct. 13, 2017	Apr. 17, 2018	Radiation (03CH03-KS)
Amplifier	Agilent	8449B	3008A02370	1GHz~26.5GHz	Oct. 12, 2017	Oct. 13, 2017	Oct. 11, 2018	Radiation (03CH03-KS)
AC Power Source	Chroma	61601	F104090004	N/A	NCR	Oct. 13, 2017	NCR	Radiation (03CH03-KS)
Turn Table	ChamPro	EM 1000-T	060762-T	0~360 degree	NCR	Oct. 13, 2017	NCR	Radiation (03CH03-KS)
Antenna Mast	ChamPro	EM 1000-A	060762-A	1 m~4 m	NCR	Oct. 13, 2017	NCR	Radiation (03CH03-KS)
Bilog Antenna	TESEQ	CBL6111D& 00800N1D0	41912&05	30MHz to 1GHz	Jan. 07, 2017	Oct. 02, 2017~ Oct. 11, 2017	Jan. 06, 2018	Radiation (03CH15-HY)
Horn Antenna	SCHWARZBECK	BBHA 9120D	BBHA 9120 D 1212	1G~18GHz	Mar. 17, 2017	Oct. 02, 2017~ Oct. 11, 2017	Mar. 16, 2018	Radiation (03CH15-HY)
SHF-EHF Horn Antenna	SCHWARZBECK	BBHA 9170	BBHA917058 4	18GHz- 40GHz	Nov. 08, 2016	Oct. 02, 2017~ Oct. 11, 2017	Nov. 07, 2017	Radiation (03CH15-HY)
Amplifier	SONOMA	310N	363440	9kHz~1GHz	Nov. 09, 2016	Oct. 02, 2017~ Oct. 11, 2017	Nov. 08, 2017	Radiation (03CH15-HY)
Preamplifier	MITEQ	AMF-7D-00 101800	2025787	1GHZ~18GHZ	Feb. 13, 2017	Oct. 02, 2017~ Oct. 11, 2017	Feb. 12, 2018	Radiation (03CH15-HY)
Preamplifier	MITEQ	TTA 1840-35-HG	1887435	18GHz ~ 40GHz	Oct. 13, 2016	Oct. 02, 2017~ Oct. 11, 2017	Oct. 12, 2017	Radiation (03CH15-HY)
Preamplifier	Keysight	83017A	MY53270195	1GHz~26.5GHz	Aug. 21, 2017	Oct. 02, 2017~ Oct. 11, 2017	Aug. 20, 2018	Radiation (03CH15-HY)
Spectrum Analyzer	Agilent	N9030A	MY52350276	3Hz~44GHz	Mar. 23, 2017	Oct. 02, 2017~ Oct. 11, 2017	Mar. 22, 2018	Radiation (03CH15-HY)
Controller	ChainTek	3000-1	N/A	Control Turn table & Ant Mast	NCR	Oct. 02, 2017~ Oct. 11, 2017	NCR	Radiation (03CH15-HY)
Antenna Mast	ChainTek	MBS-520-1	N/A	1m~4m	NCR	Oct. 02, 2017~ Oct. 11, 2017	NCR	Radiation (03CH15-HY)



Turn Table	ChainTek	T-200-S-1	N/A	0~360 Degree	NCR	Oct. 02, 2017~ Oct. 11, 2017	NCR	Radiation (03CH15-HY)
------------	----------	-----------	-----	--------------	-----	---------------------------------	-----	--------------------------

NCR: No Calibration Required



6 Uncertainty of Evaluation

Uncertainty of Radiated Emission Measurement (30 MHz ~ 1000 MHz) for 03CH03-KS

Measuring Uncertainty for a Level of Confidence of 95% (U = 2Uc(y))	2.8dB
---------------------------------------------------------------------	-------

Uncertainty of Radiated Emission Measurement (1 GHz ~ 40 GHz) for 03CH03-KS

Measuring Uncertainty for a Level of Confidence of 95% (U = 2Uc(y))	3.3dB
---------------------------------------------------------------------	-------

Uncertainty of Radiated Emission Measurement (30 MHz ~ 1000 MHz) for 03CH15-HY

Measuring Uncertainty for a Level of Confidence of 95% (U = 2Uc(y))	3.4dB
---------------------------------------------------------------------	-------

Uncertainty of Radiated Emission Measurement (1 GHz ~ 18 GHz) for 03CH15-HY

Measuring Uncertainty for a Level of Confidence of 95% (U = 2Uc(y))	3.7dB
---------------------------------------------------------------------	-------

Uncertainty of Radiated Emission Measurement (18 GHz ~ 40 GHz) for 03CH15-HY

Measuring Uncertainty for a Level of Confidence of 95% (U = 2Uc(y))	4.0dB
---------------------------------------------------------------------	-------



Appendix A. Test Results of Conducted Test

Conducted Output Power(Average power)

Conducted Power (*Unit: dBm)						
Band	GSM850			GSM1900		
Channel	128	189	251	512	661	810
Frequency	824.2	836.4	848.8	1850.2	1880.0	1909.8
GSM	32.08	31.87	32.08	29.67	29.74	29.72
GPRS class 8	32.06	31.85	32.06	29.62	29.69	29.68
GPRS class 10	28.89	28.8	29.01	27.78	27.92	27.95
GPRS class 11	26.9	26.92	26.93	25.82	25.99	25.97
GPRS class 12	25.48	25.45	25.64	24.57	24.64	24.73
EGPRS class 8	25.67	25.71	25.81	25.13	25.2	25.2
EGPRS class 10	22.59	22.64	22.72	22.08	22.15	22.15
EGPRS class 11	21.81	21.91	22.2	20.15	20.17	20.18
EGPRS class 12	20.44	20.55	20.71	18.74	18.71	18.75

Conducted Power (*Unit: dBm)									
Band	WCDMA Band V			WCDMA Band II			WCDMA Band IV		
Channel	4132	4182	4233	9262	9400	9538	1312	1413	1513
Frequency	826.4	836.4	846.6	1852.4	1880	1907.6	1712.4	1732.6	1752.6
AMR 12.2Kbps	22.50	22.59	22.61	22.92	23.06	23.07	22.85	23.01	22.74
RMC 12.2Kbps	22.53	22.62	22.63	22.95	23.08	23.10	22.87	23.04	22.77
HSDPA Subtest-1	21.48	21.65	21.66	22.06	22.33	22.26	22.11	22.20	22.02
HSDPA Subtest-2	21.47	21.66	21.67	22.05	22.31	22.21	22.12	22.17	22.07
HSDPA Subtest-3	21.06	21.16	21.17	21.56	21.81	21.72	21.58	21.72	21.50
HSDPA Subtest-4	21.03	21.17	21.13	21.56	21.80	21.73	21.59	21.69	21.54
DC-HSDPA Subtest-1	21.42	21.65	21.63	22.05	22.31	22.18	22.10	22.18	22.12
DC-HSDPA Subtest-2	21.45	21.61	21.52	22.01	22.30	22.16	22.12	22.10	22.02
DC-HSDPA Subtest-3	21.05	21.08	21.16	21.51	21.85	21.80	21.52	21.71	21.48
DC-HSDPA Subtest-4	21.02	21.13	21.15	21.53	21.82	21.63	21.55	21.66	21.52
HSUPA Subtest-1	21.60	21.66	21.67	22.06	22.31	22.2	22.09	22.19	22.02
HSUPA Subtest-2	19.56	19.62	19.66	20.06	20.34	20.24	20.10	20.22	20.03
HSUPA Subtest-3	20.56	20.67	20.68	21.04	21.32	21.23	21.08	21.15	21.03
HSUPA Subtest-4	19.55	19.67	19.68	20.06	20.30	20.28	20.08	20.19	20.02
HSUPA Subtest-5	21.60	21.70	21.70	22.10	22.30	22.20	22.10	22.20	22.00



Conducted Power (*Unit: dBm)						
Band	CDMA 2000 BC0			CDMA 2000 BC1		
Channel	1013	384	777	25	600	1175
Frequency	824.7	836.52	848.31	1851.25	1880	1908.75
1xRTT RC1 SO55	23.55	23.68	23.73	24.08	24.25	24.18
1xRTT RC3 SO55	23.77	23.91	23.99	23.93	24.02	23.99
1xRTT RC3 SO32 (+ F-SCH)	23.81	23.94	23.98	23.81	23.99	23.85
1xRTT RC3 SO32 (+SCH)	23.79	23.96	23.99	23.82	24.01	23.88
1xEVDO RTAP 153.6Kbps	23.46	23.55	23.65	23.58	23.77	23.67
1xEVDO RETAP 4096Bits	23.27	23.35	23.44	23.34	23.57	23.44



ERP/EIRP

GSM850 (G_T - L_C= -1.0dBi)			
Channel	128	189	251
	(Low)	(Mid)	(High)
Frequency	824.2	836.4	848.8
(MHz)			
Conducted Power (dBm)	32.08	31.87	32.08
Conducted Power (Watts)	1.6144	1.5382	1.6144
ERP(dBm)	28.93	28.72	28.93
ERP(Watts)	0.7816	0.7447	0.7816

EDGE850 (G_T - L_C=-1.0 dBi)			
Channel	128	189	251
	(Low)	(Mid)	(High)
Frequency	824.2	836.4	848.8
(MHz)			
Conducted Power (dBm)	25.67	25.71	25.81
Conducted Power (Watts)	0.3690	0.3724	0.3811
ERP(dBm)	22.52	22.56	22.66
ERP(Watts)	0.1786	0.1803	0.1845



GSM1900 (G _T - L _C = -1.0dBi)			
Channel	512	661	810
	(Low)	(Mid)	(High)
Frequency	1850.2	1880	1909.8
(MHz)			
Conducted Power (dBm)	29.67	29.74	29.72
Conducted Power (Watts)	0.9268	0.9419	0.9376
EIRP(dBm)	28.67	28.74	28.72
EIRP(Watts)	0.7362	0.7482	0.7447

EDGE1900 (G _T - L _C = -1.0dBi)			
Channel	512	661	810
	(Low)	(Mid)	(High)
Frequency	1850.2	1880	1909.8
(MHz)			
Conducted Power (dBm)	25.13	25.20	25.20
Conducted Power (Watts)	0.3258	0.3311	0.3311
EIRP(dBm)	24.13	24.20	24.20
EIRP(Watts)	0.2588	0.2630	0.2630



WCDMA Band V ($G_T - L_C = -1.0\text{dBi}$)			
Channel	4132	4182	4233
	(Low)	(Mid)	(High)
Frequency	826.4	836.4	846.6
(MHz)			
Conducted Power (dBm)	22.53	22.62	22.63
Conducted Power (Watts)	0.1791	0.1828	0.1832
ERP(dBm)	19.38	19.47	19.48
ERP(Watts)	0.0867	0.0885	0.0887

WCDMA Band II ($G_T - L_C = -1.0\text{dBi}$)			
Channel	9262	9400	9538
	(Low)	(Mid)	(High)
Frequency	1852.4	1880	1907.6
(MHz)			
Conducted Power (dBm)	22.95	23.08	23.10
Conducted Power (Watts)	0.1972	0.2032	0.2042
EIRP(dBm)	21.95	22.08	22.10
EIRP(Watts)	0.1567	0.1614	0.1622



WCDMA Band IV (G _T - L _C = -1.0dBi)			
Channel	1312	1413	1513
	(Low)	(Mid)	(High)
Frequency	1712.4	1732.6	1752.6
(MHz)			
Conducted Power (dBm)	22.87	23.04	22.77
Conducted Power (Watts)	0.1936	0.2014	0.1892
EIRP(dBm)	21.87	22.04	21.77
EIRP(Watts)	0.1538	0.1600	0.1503

CDMA BC0 (G _T - L _C =-1.0 dBi)			
Channel	824.7	836.52	848.31
	(Low)	(Mid)	(High)
Frequency	826.4	836.4	846.6
(MHz)			
Conducted Power (dBm)	23.77	23.91	23.99
Conducted Power (Watts)	0.2382	0.2460	0.2506
ERP(dBm)	20.62	20.76	20.84
ERP(Watts)	0.1153	0.1191	0.1213

CDMA BC1 (G _T - L _C = -1.0dBi)			
Channel	824.7	836.52	848.31
	(Low)	(Mid)	(High)
Frequency	1852.4	1880	1907.6
(MHz)			
Conducted Power (dBm)	24.08	24.25	24.18
Conducted Power (Watts)	0.2559	0.2661	0.2618
EIRP(dBm)	23.08	23.25	23.18
EIRP(Watts)	0.2032	0.2113	0.2080



Peak-to-Average Ratio

Mode	GSM850(dB)			Limit: 13dB
Mod.	GSM	EDGE class 8		Result
Lowest CH	0.29	3.25		PASS
Middle CH	0.26	3.39		
Highest CH	0.26	3.36		
Mode	GSM1900(dB)			Limit: 13dB
Mod.	GSM	EDGE class 8		Result
Lowest CH	0.20	3.36		PASS
Middle CH	0.23	3.42		
Highest CH	0.20	3.36		
Mode	WCDMA Band V(dB)	WCDMA Band II(dB)	WCDMA Band IV(dB)	Limit: 13dB
Mod.	RMC 12.2Kbps	RMC 12.2Kbps	RMC 12.2Kbps	Result
Lowest CH	2.75	2.75	3.13	PASS
Middle CH	2.93	2.90	3.19	
Highest CH	3.04	3.01	3.25	
Mode	CDMA BC0(dB)	CDMA BC1(dB)	-	
Mod.	1xRTT	1xRTT	-	
Lowest CH	3.39	3.01	-	
Middle CH	3.62	3.19	-	
Highest CH	3.39	3.48	-	

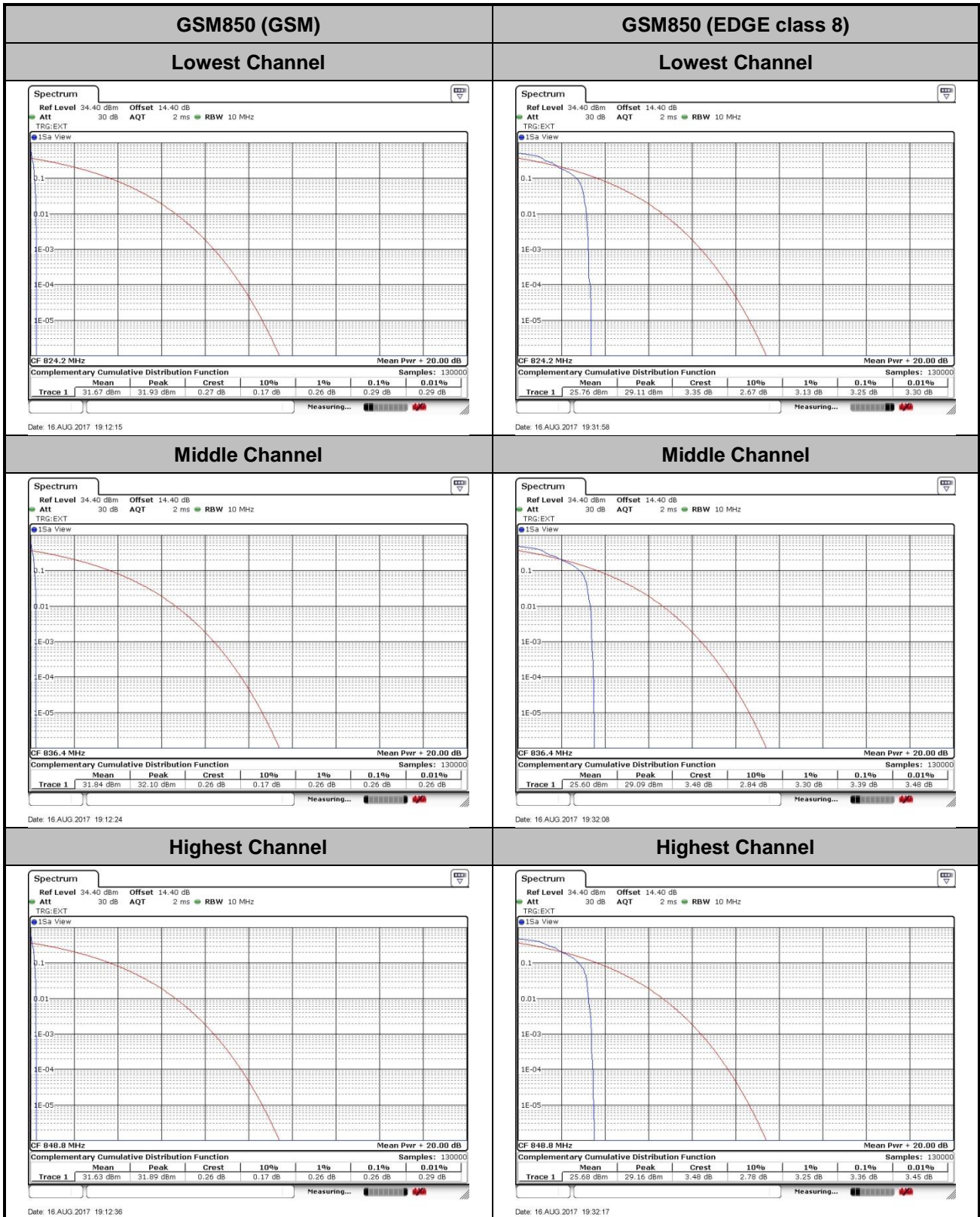

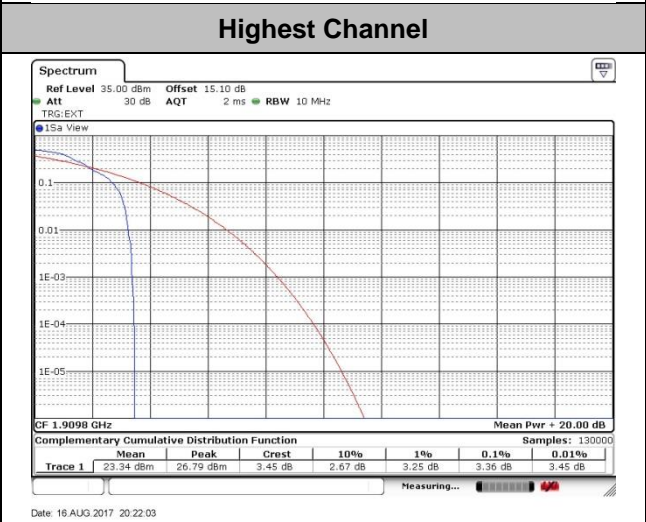
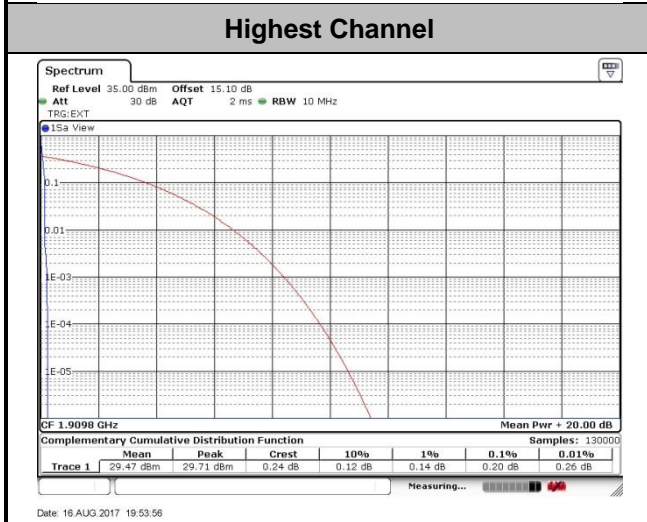
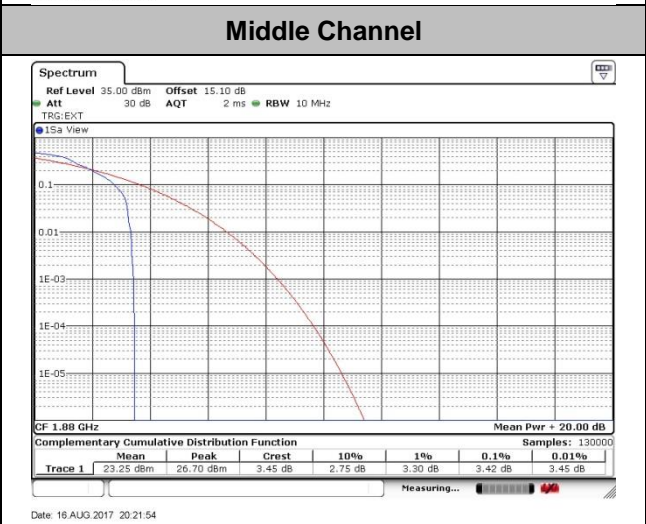
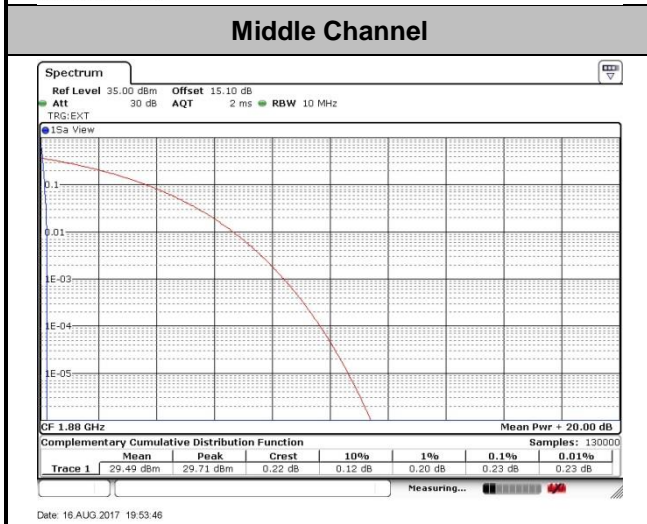
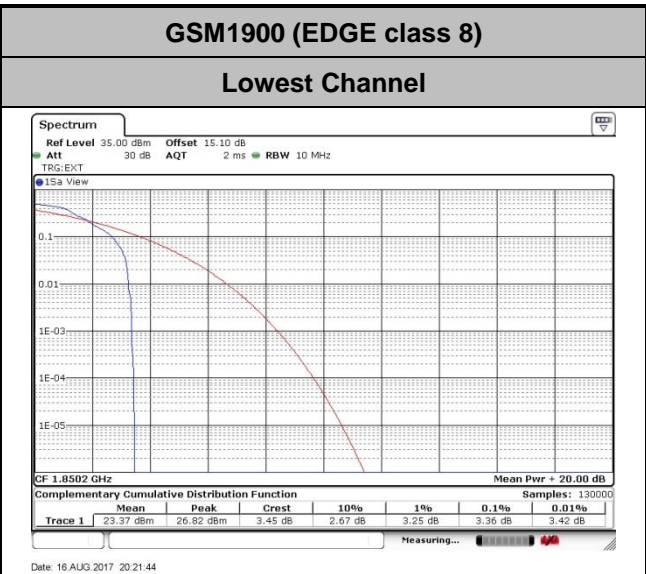
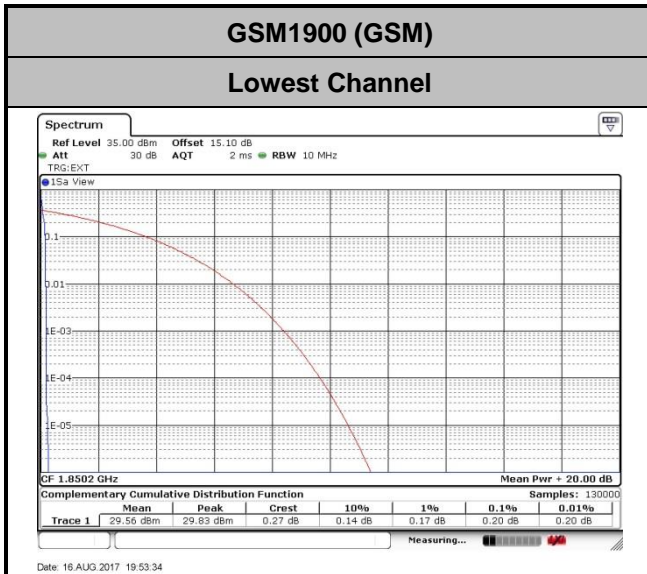



WCDMA Band V (RMC 12.2Kbps)

Lowest Channel

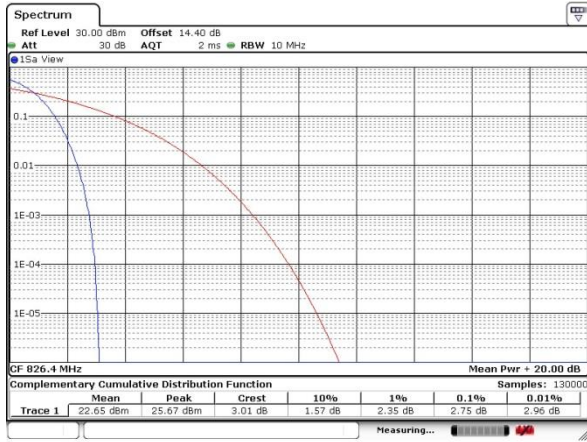

Date: 16 AUG 2017 23:17:34

WCDMA Band II (RMC 12.2Kbps)

Lowest Channel

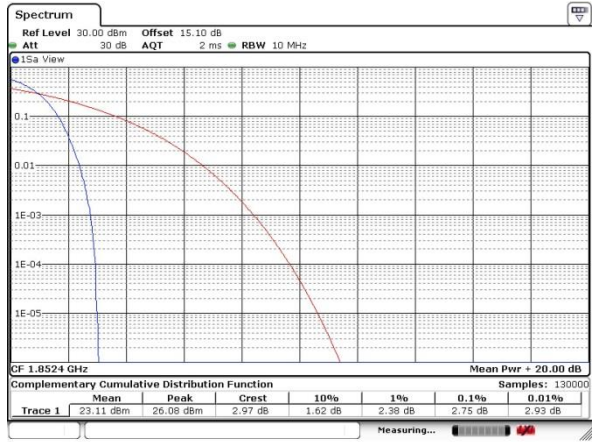

Date: 16 AUG 2017 21:11:35

Middle Channel

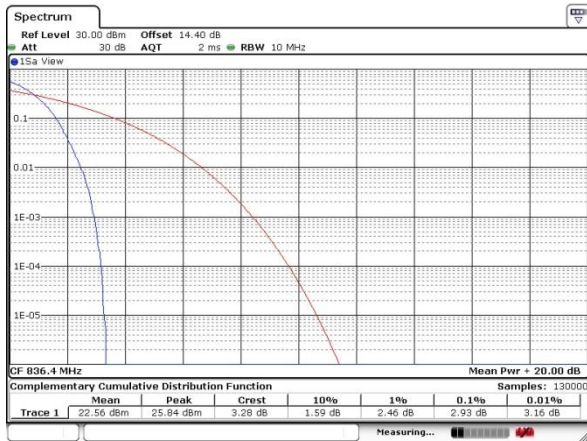

Date: 16 AUG 2017 23:17:47

Middle Channel

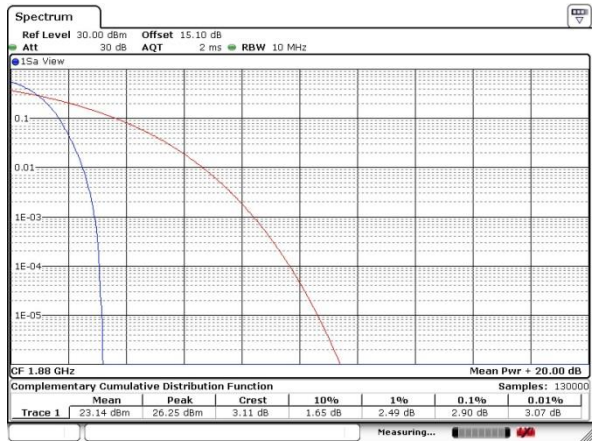

Date: 16 AUG 2017 21:12:03

Highest Channel

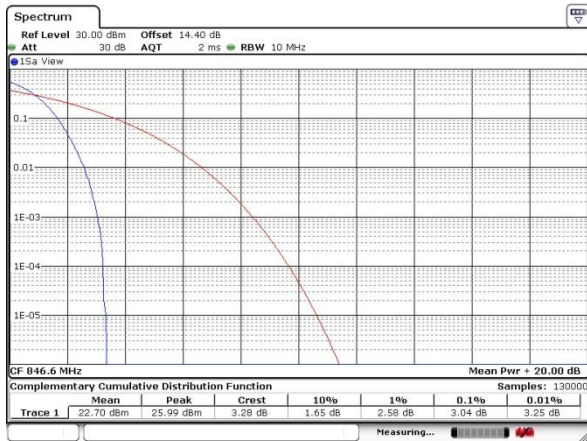

Date: 16 AUG 2017 23:17:56

Highest Channel

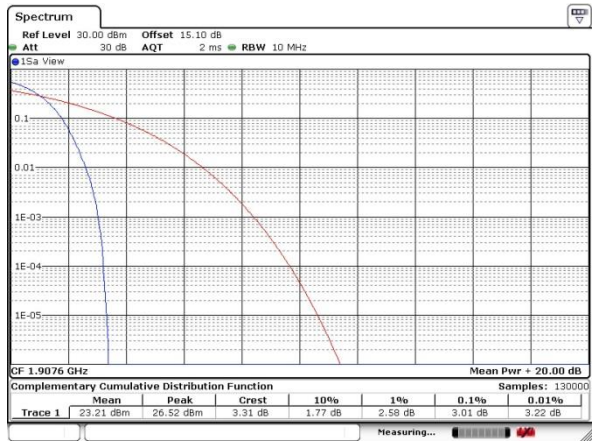

Date: 16 AUG 2017 21:12:19



WCDMA Band IV (RMC 12.2Kbps)

Lowest Channel

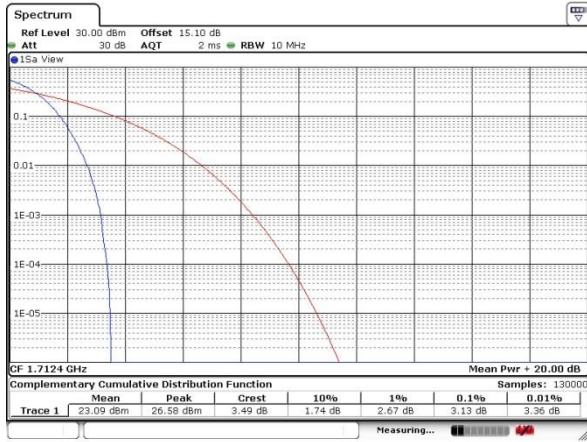

Date: 16 AUG 2017 22:47:45

Middle Channel

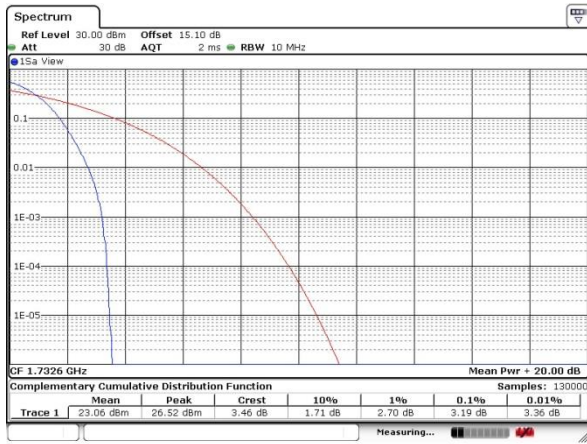

Date: 16 AUG 2017 22:47:53

Highest Channel



Date: 16 AUG 2017 22:48:03

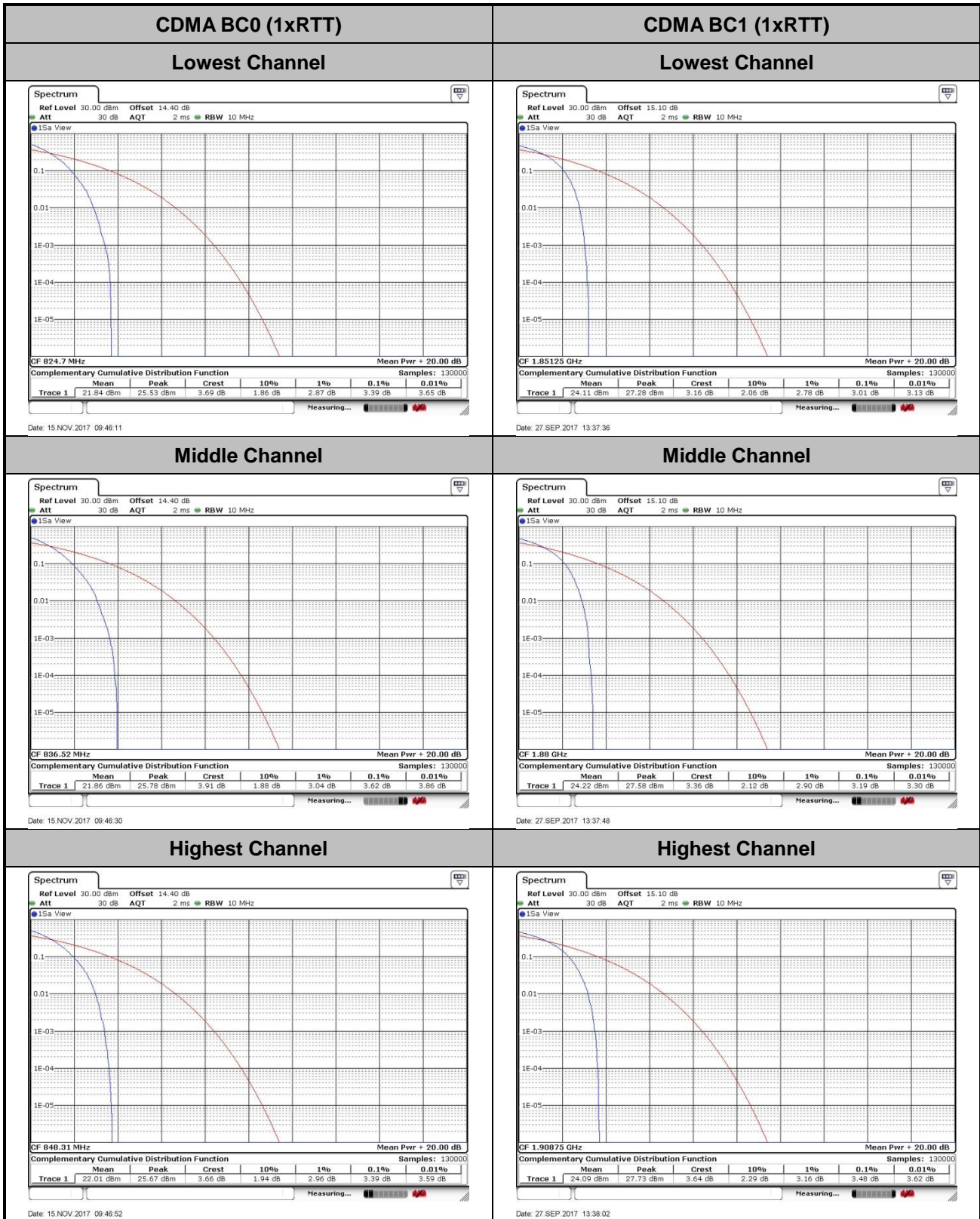



26dB Bandwidth

Mode	GSM850(MHz)		
Mod.	GSM	EDGE class 8	
Lowest CH	0.316	0.313	
Middle CH	0.317	0.313	
Highest CH	0.314	0.314	
Mode	GSM1900(MHz)		
Mod.	GSM	EDGE class 8	
Lowest CH	0.316	0.313	
Middle CH	0.314	0.314	
Highest CH	0.314	0.312	
Mode	WCDMA Band V(MHz)	WCDMA Band II(MHz)	WCDMA Band IV(MHz)
Mod.	RMC 12.2Kbps	RMC 12.2Kbps	RMC 12.2Kbps
Lowest CH	4.74	4.72	4.69
Middle CH	4.72	4.74	4.71
Highest CH	4.72	4.72	4.71
Mode	CDMA BC0(MHz)	CDMA BC1(MHz)	-
Mod.	1xRTT	1xRTT	-
Lowest CH	1.43	1.46	-
Middle CH	1.42	1.45	-
Highest CH	1.41	1.44	-



GSM850 (GSM)

Lowest Channel

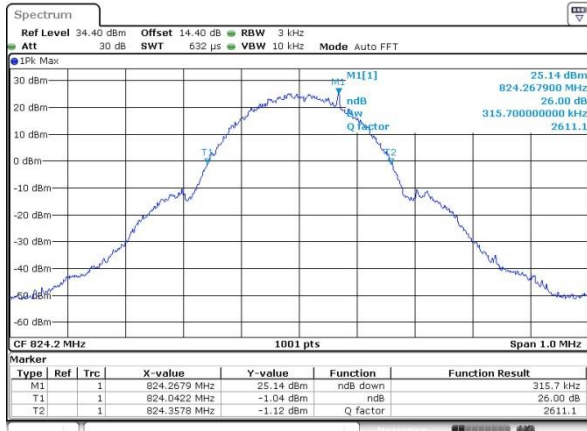

Date: 16 AUG 2017 18:56:22

GSM850 (EDGE class 8)

Lowest Channel

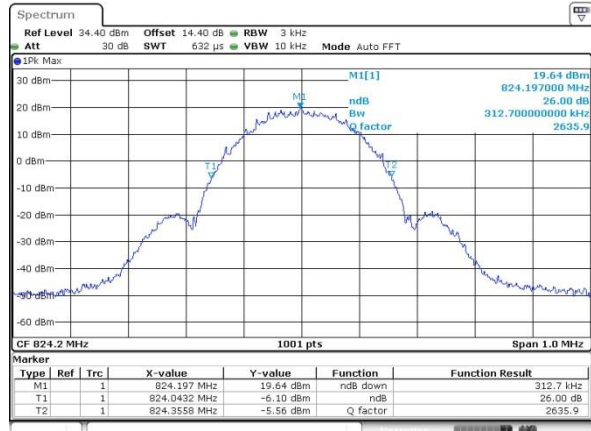

Date: 16 AUG 2017 19:15:04

Middle Channel

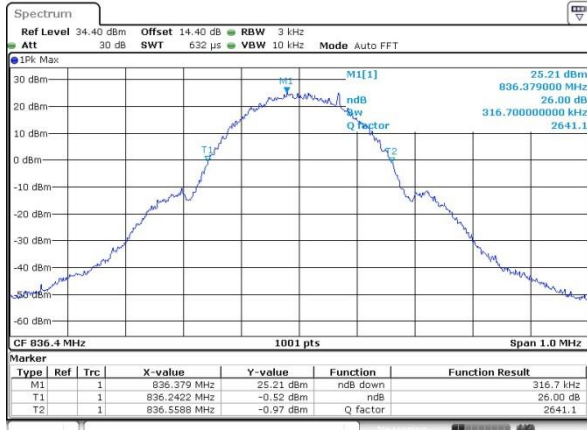

Date: 16 AUG 2017 18:57:02

Middle Channel

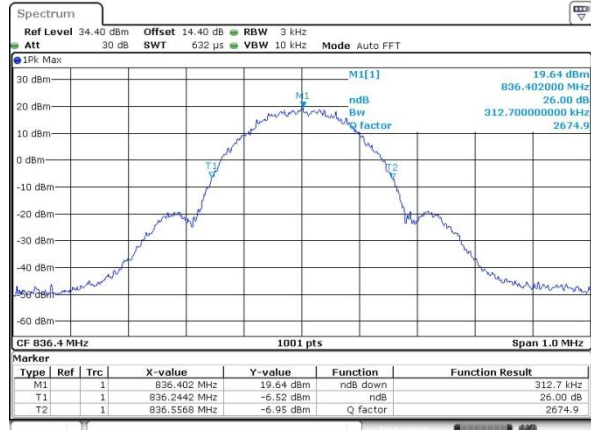

Date: 16 AUG 2017 19:15:48

Highest Channel

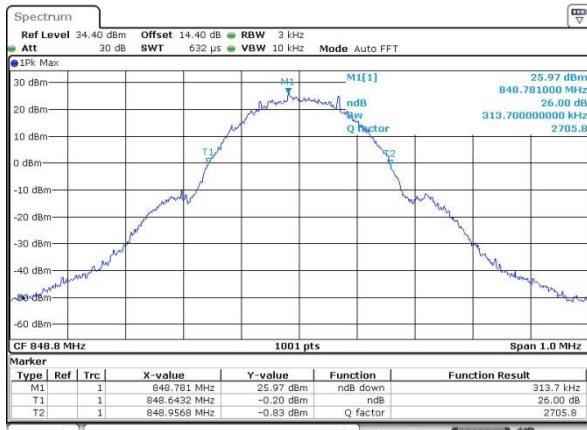

Date: 16 AUG 2017 18:57:35

Highest Channel

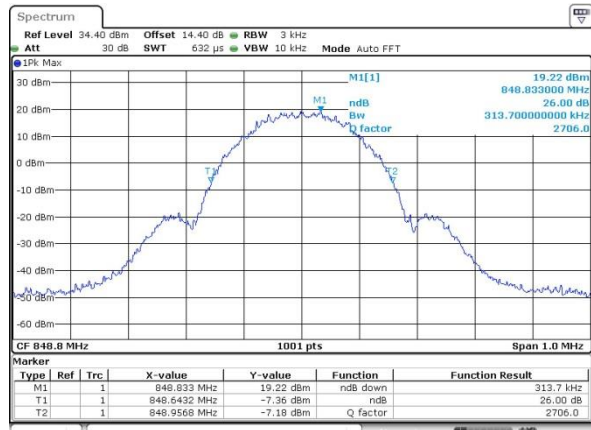

Date: 16 AUG 2017 19:16:19



GSM1900 (GSM)

Lowest Channel

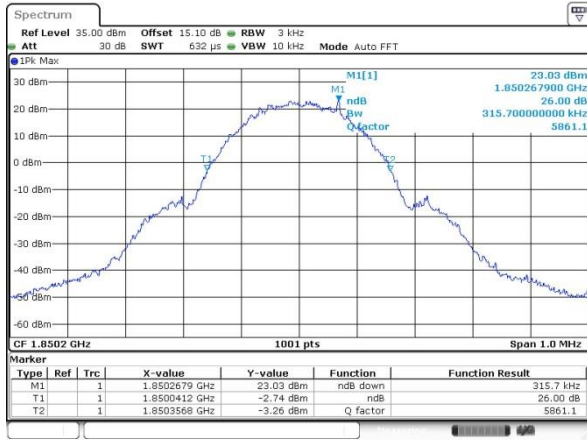

Date: 16 AUG 2017 19:35:04

GSM1900 (EDGE class 8)

Lowest Channel

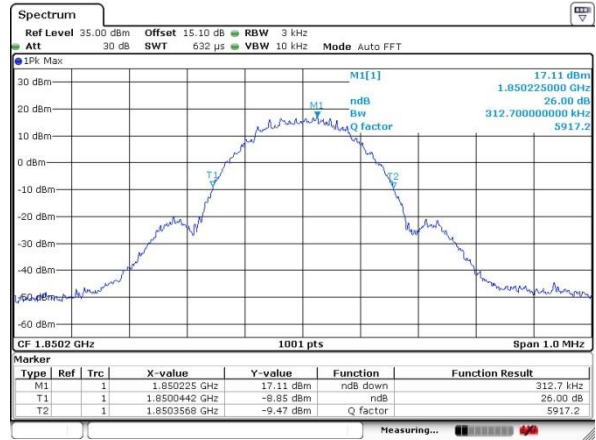

Date: 16 AUG 2017 20:09:05

Middle Channel

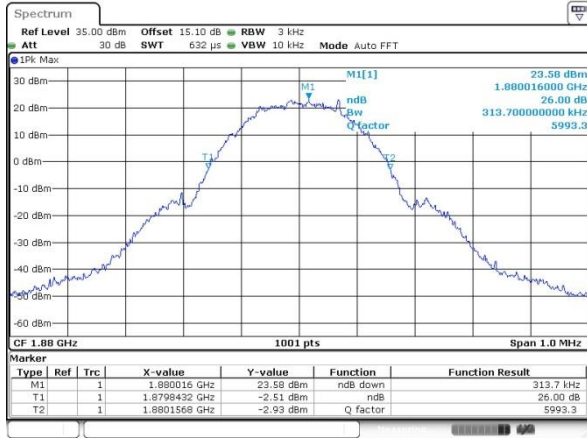

Date: 16 AUG 2017 19:35:41

Middle Channel

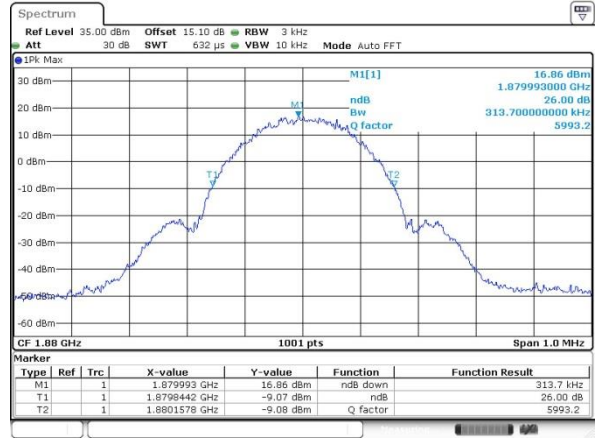

Date: 16 AUG 2017 19:57:06

Highest Channel

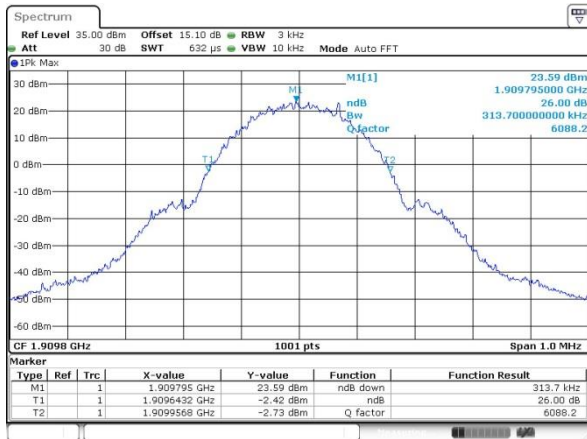

Date: 16 AUG 2017 19:36:16

Highest Channel

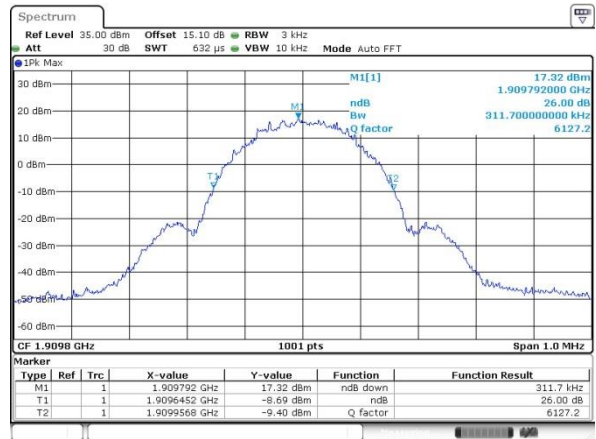

Date: 16 AUG 2017 19:57:37



WCDMA Band V (RMC 12.2Kbps)

Lowest Channel

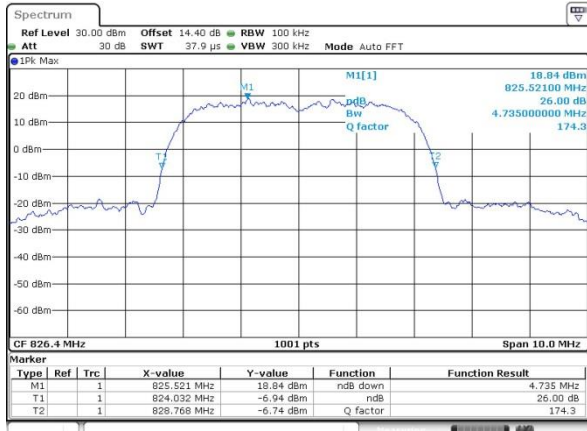

Date: 16 AUG 2017 22:57:10

WCDMA Band II (RMC 12.2Kbps)

Lowest Channel

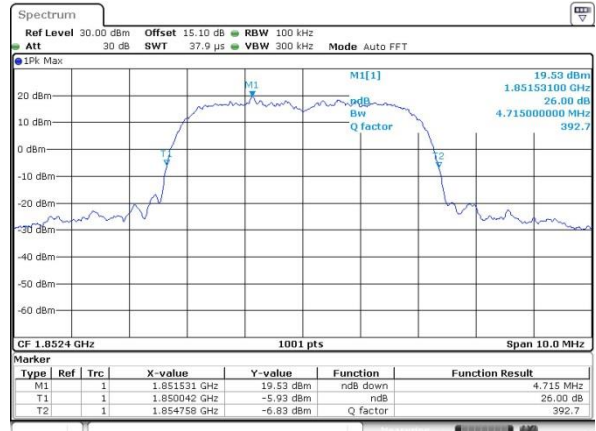

Date: 16 AUG 2017 20:25:58

Middle Channel

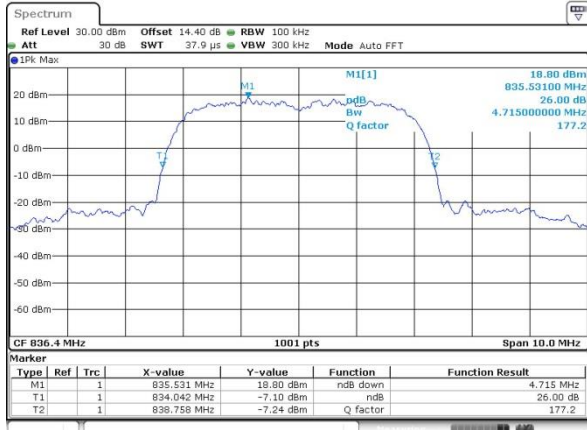

Date: 16 AUG 2017 22:57:52

Middle Channel

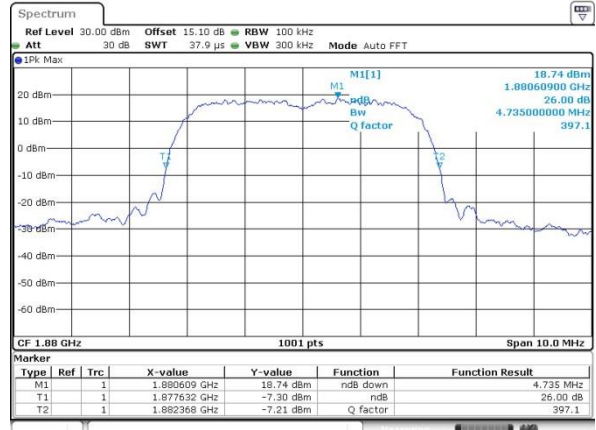

Date: 16 AUG 2017 20:26:33

Highest Channel

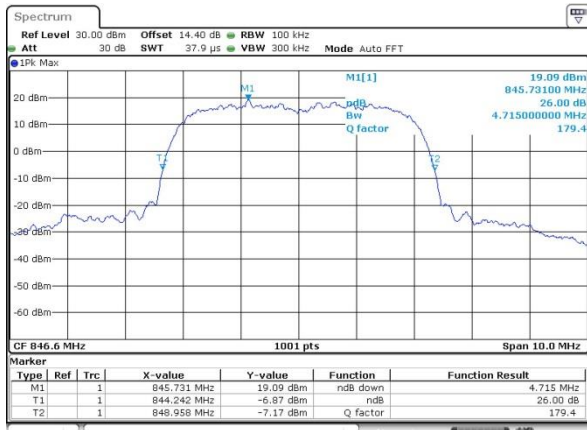

Date: 16 AUG 2017 22:58:23

Highest Channel

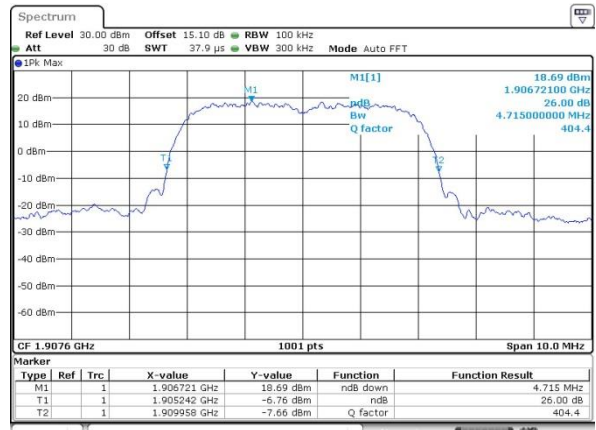

Date: 16 AUG 2017 20:27:07



WCDMA Band IV (RMC 12.2Kbps)

Lowest Channel

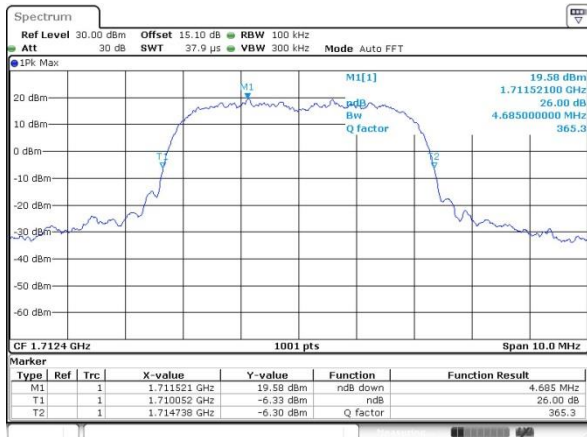

Date: 16 AUG 2017 21:13:50

Middle Channel

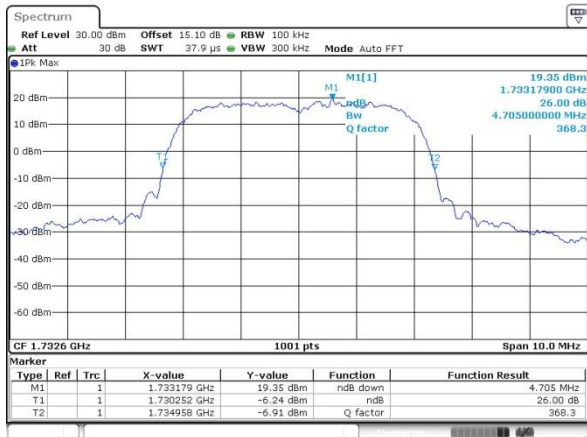

Date: 16 AUG 2017 21:14:50

Highest Channel

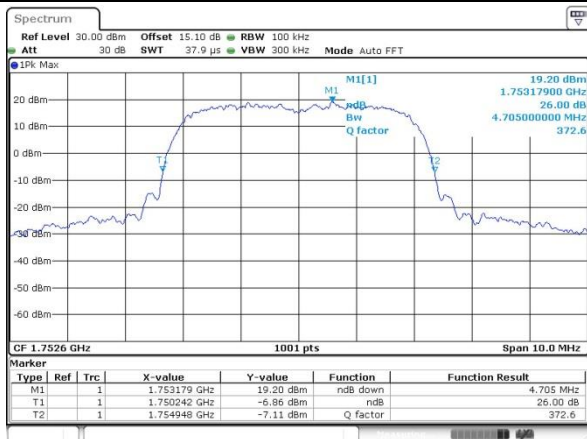

Date: 16 AUG 2017 21:16:09



CDMA BC0 (1xRTT)

Lowest Channel

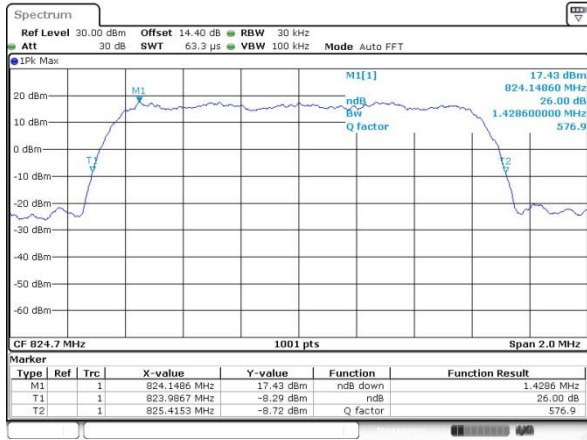

Date: 15 NOV 2017 09:28:13

CDMA BC1 (1xRTT)

Lowest Channel

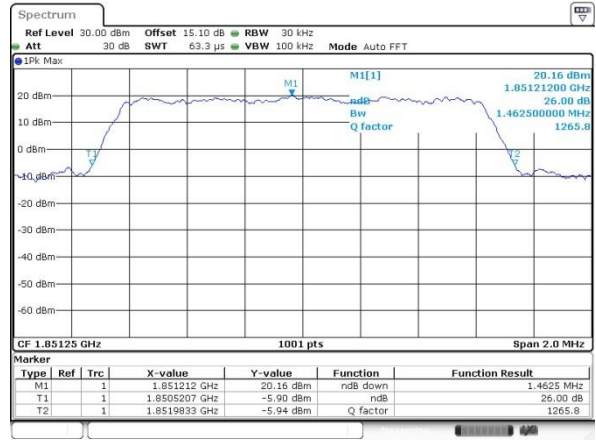

Date: 27 SEP 2017 11:51:08

Middle Channel

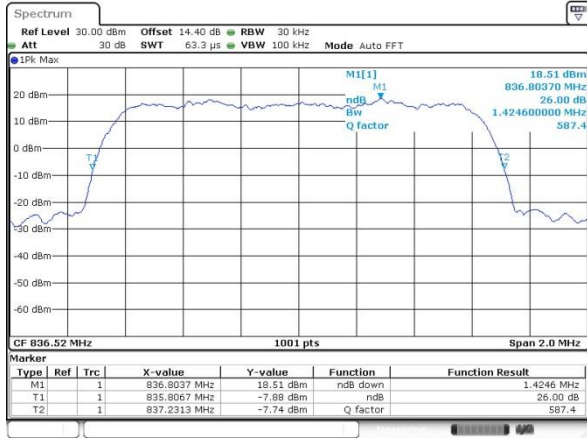

Date: 15 NOV 2017 09:28:51

Middle Channel

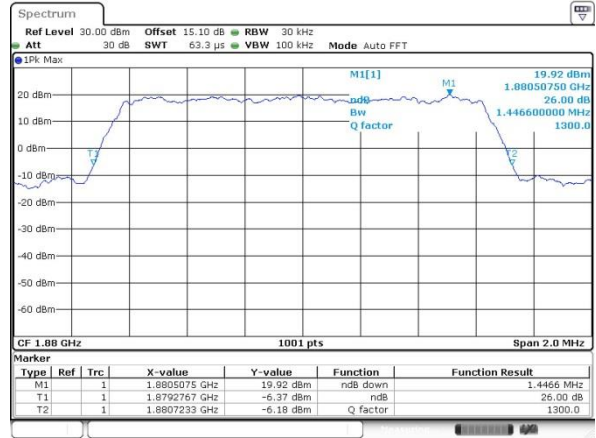

Date: 27 SEP 2017 11:51:43

Highest Channel

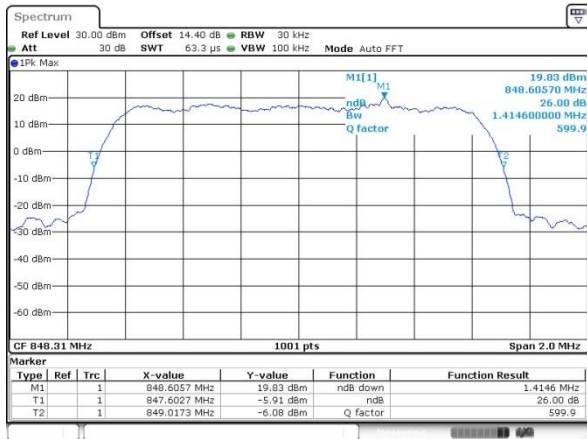

Date: 15 NOV 2017 09:27:31

Highest Channel

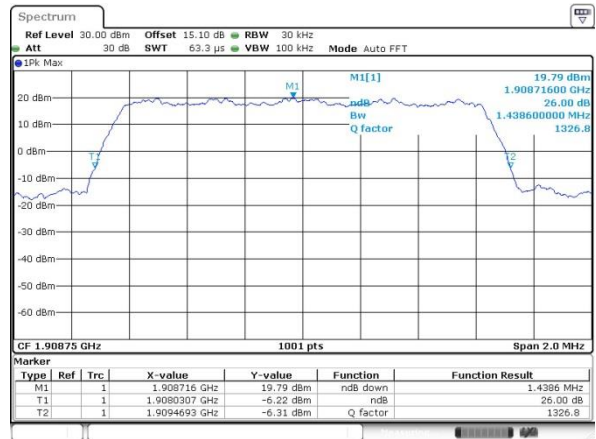

Date: 27 SEP 2017 11:52:17



Occupied Bandwidth

Mode	GSM850(MHz)		
Mod.	GSM	EDGE class 8	
Lowest CH	0.243	0.244	
Middle CH	0.242	0.248	
Highest CH	0.243	0.246	
Mode	GSM1900(MHz)		
Mod.	GSM	EDGE class 8	
Lowest CH	0.242	0.244	
Middle CH	0.243	0.241	
Highest CH	0.242	0.245	
Mode	WCDMA Band V(MHz)	WCDMA Band II(MHz)	WCDMA Band IV(MHz)
Mod.	RMC 12.2Kbps	RMC 12.2Kbps	RMC 12.2Kbps
Lowest CH	4.15	4.16	4.13
Middle CH	4.14	4.14	4.12
Highest CH	4.13	4.15	4.13
Mode	CDMA BC0(MHz)	CDMA BC1(MHz)	-
Mod.	1xRTT	1xRTT	-
Lowest CH	1.27	1.28	-
Middle CH	1.27	1.28	-
Highest CH	1.27	1.28	-



GSM850 (GSM)

Lowest Channel

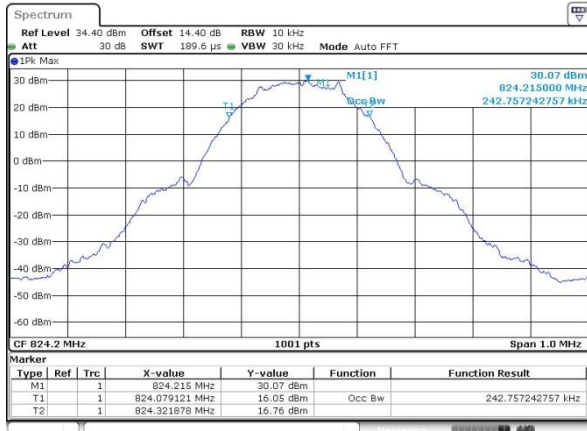

Date: 16 AUG 2017 19:00:40

GSM850 (EDGE class 8)

Lowest Channel

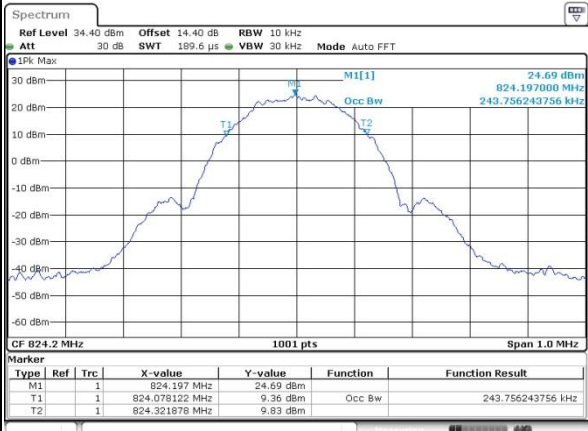

Date: 16 AUG 2017 19:20:01

Middle Channel

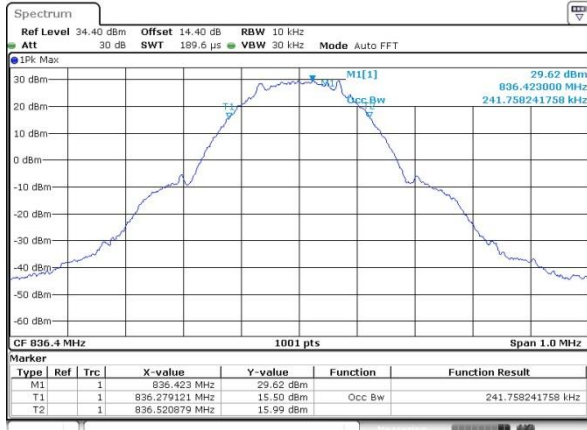

Date: 16 AUG 2017 19:01:13

Middle Channel

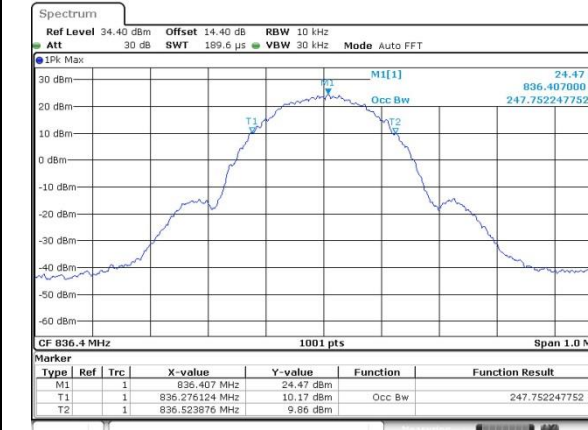

Date: 16 AUG 2017 19:20:51

Highest Channel

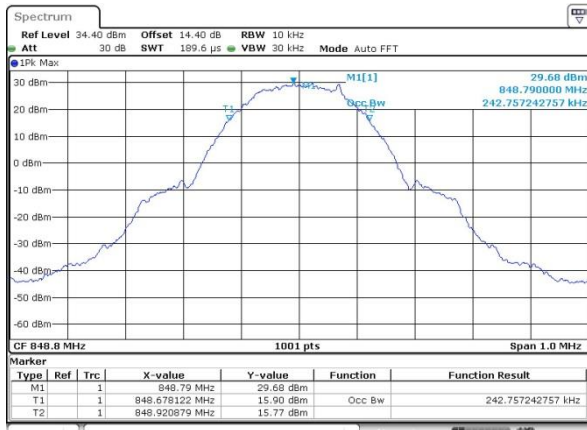

Date: 16 AUG 2017 19:01:48

Highest Channel

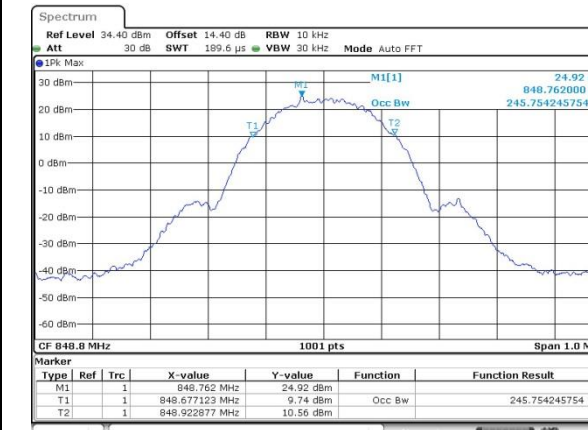

Date: 16 AUG 2017 19:21:23



GSM1900 (GSM)

Lowest Channel

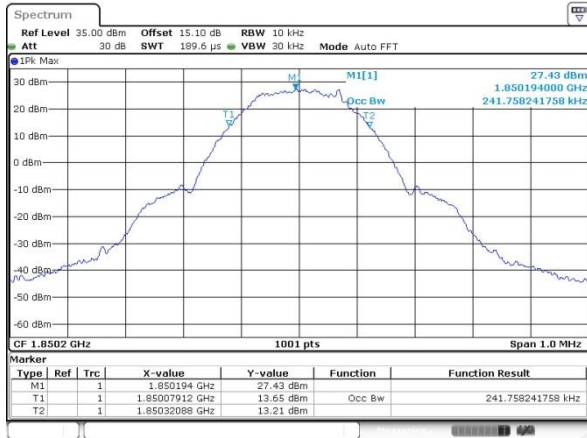

Date: 16 AUG 2017 19:40:14

GSM1900 (EDGE class 8)

Lowest Channel

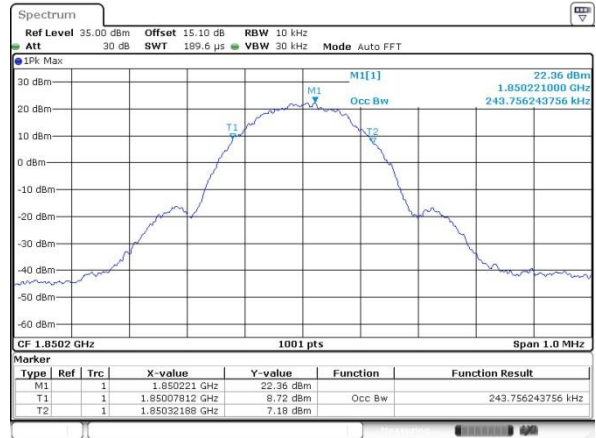

Date: 16 AUG 2017 20:11:55

Middle Channel

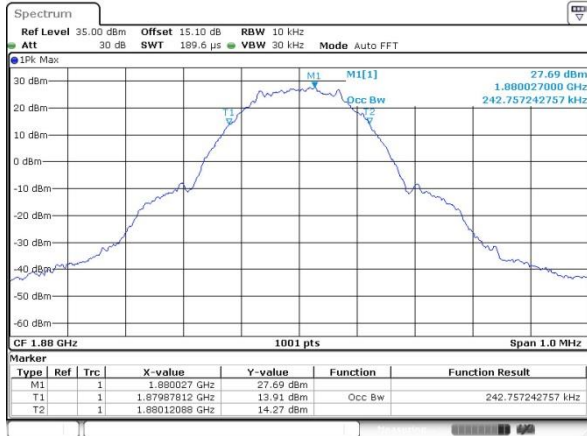

Date: 16 AUG 2017 19:40:45

Middle Channel

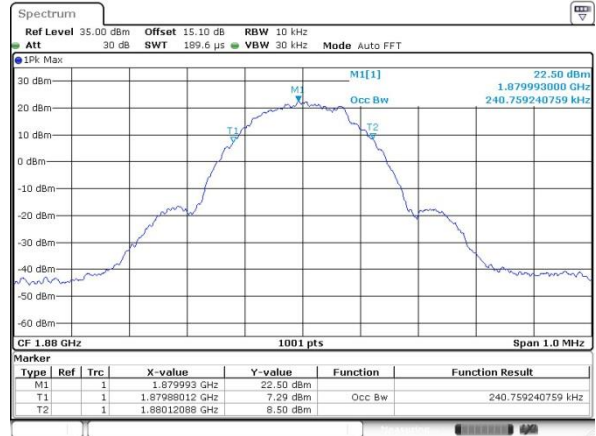

Date: 16 AUG 2017 20:12:28

Highest Channel

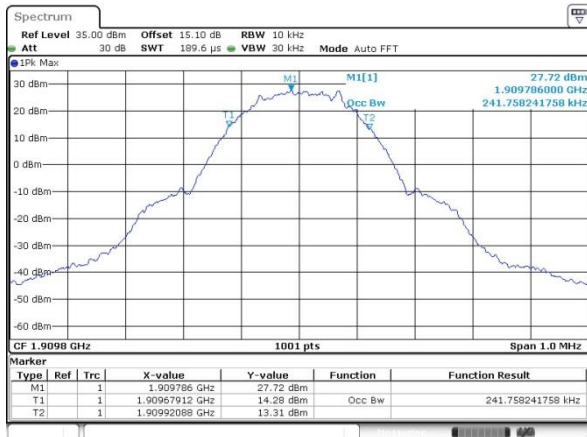

Date: 16 AUG 2017 19:41:55

Highest Channel

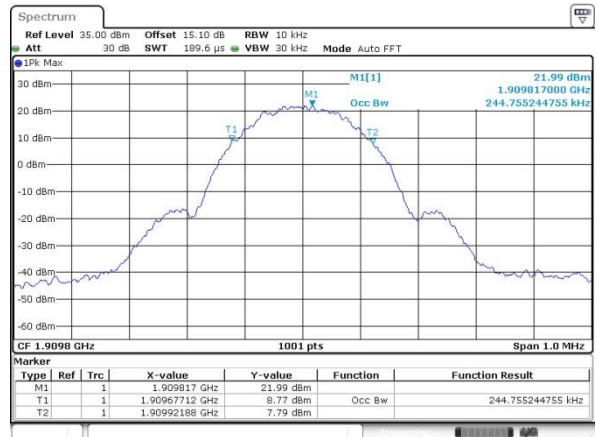

Date: 16 AUG 2017 20:12:57