



FCC RF Test Report

APPLICANT : Sonim Technologies, Inc.
EQUIPMENT : LTE Phone
BRAND NAME : Sonim
MODEL NAME : XP5800(PC2111)
FCC ID : WYPPC2100
STANDARD : FCC Part 15 Subpart C §15.247
CLASSIFICATION : (DTS) Digital Transmission System

The product was received on Sep. 21, 2017 and testing was completed on Nov. 23, 2017. We, Sporton International (Kunshan) Inc., would like to declare that the tested sample has been evaluated in accordance with the test procedures and has been in compliance with the applicable technical standards.

The test results in this report apply exclusively to the tested model / sample. Without written approval of Sporton International (Kunshan) Inc., the test report shall not be reproduced except in full.



Approved by: James Huang / Manager

Sporton International (Kunshan) Inc.
No.3-2 Ping-Xiang Rd, Kunshan Development Zone Kunshan City Jiangsu Province 215335
China



TABLE OF CONTENTS

- 1 GENERAL DESCRIPTION 5**
 - 1.1 Applicant 5
 - 1.2 Manufacturer 5
 - 1.3 Product Feature of Equipment Under Test 5
 - 1.4 Product Specification of Equipment Under Test 6
 - 1.5 Modification of EUT 6
 - 1.6 Testing Location 7
 - 1.7 Applicable Standards 7
- 2 TEST CONFIGURATION OF EQUIPMENT UNDER TEST 8**
 - 2.1 Carrier Frequency and Channel 8
 - 2.2 Test Mode 9
 - 2.3 Connection Diagram of Test System 10
 - 2.4 Support Unit used in test configuration and system 11
 - 2.5 EUT Operation Test Setup 11
 - 2.6 Measurement Results Explanation Example 12
- 3 TEST RESULT 13**
 - 3.1 6dB and 99% Bandwidth Measurement 13
 - 3.2 Output Power Measurement 15
 - 3.3 Power Spectral Density Measurement 16
 - 3.4 Conducted Band Edges and Spurious Emission Measurement 18
 - 3.5 Radiated Band Edges and Spurious Emission Measurement 31
 - 3.6 AC Conducted Emission Measurement 35
 - 3.7 Antenna Requirements 39
- 4 LIST OF MEASURING EQUIPMENT 40**
- 5 UNCERTAINTY OF EVALUATION 41**
- APPENDIX A. CONDUCTED TEST RESULTS**
- APPENDIX B. RADIATED SPURIOUS EMISSION**
- APPENDIX C. DUTY CYCLE PLOTS**
- APPENDIX D. SETUP PHOTOGRAPHS**



SUMMARY OF TEST RESULT

Report Section	FCC Rule	Description	Limit	Result	Remark
3.1	15.247(a)(2)	6dB Bandwidth	$\geq 0.5\text{MHz}$	Pass	-
3.1	-	99% Bandwidth	-	Pass	-
3.2	15.247(b)	Power Output Measurement	$\leq 30\text{dBm}$	Pass	-
3.3	15.247(e)	Power Spectral Density	$\leq 8\text{dBm}/3\text{kHz}$	Pass	-
3.4	15.247(d)	Conducted Band Edges	$\leq 20\text{dBc}$	Pass	-
		Conducted Spurious Emission		Pass	-
3.5	15.247(d)	Radiated Band Edges and Radiated Spurious Emission	15.209(a) & 15.247(d)	Pass	Under limit 0.28 dB at 2483.51 MHz
3.6	15.207	AC Conducted Emission	15.207(a)	Pass	Under limit 9.05 dB at 0.164 MHz
3.7	15.203 & 15.247(b)	Antenna Requirement	N/A	Pass	-



1 General Description

1.1 Applicant

Sonim Technologies, Inc.
1825 S. Grant St., Suite 200., San Mateo, CA, 94402

1.2 Manufacturer

Sonim Technologies (Shenzhen) Limited
2nd Floor, No. 2 Building Phase B, Daqian Industrial park, Longchang Road, 67 District, Baoan, Shenzhen, P. R. China

1.3 Product Feature of Equipment Under Test

Product Feature	
Equipment	LTE Phone
Brand Name	Sonim
Model Name	XP5800(PC2111)
FCC ID	WYPPC2100
EUT supports Radios application	CDMA/EV-DO/GSM/GPRS/EGPRS/WCDMA/HSPA/DC-HSDPA/HSPA+ (16QAM uplink is not supported)/LTE WLAN 2.4G 802.11b/g/n HT20/HT40 WLAN 5G 802.11a/n HT20/HT40 Bluetooth v3.0 + EDR/ Bluetooth v4.0 LE/ Bluetooth v4.2 LE
IMEI Code	Conducted: 001080001908574/ 001080001908574 Conduction: 001080001912444/ 001080001912451 Radiation: 001080001912568/ 001080001912576
HW Version	A
SW Version	5SA.0.0-00-7.1.2-00.25.01
EUT Stage	Identical Prototype

Remark: The above EUT's information was declared by manufacturer. Please refer to the specifications or user's manual for more detailed description.



1.4 Product Specification of Equipment Under Test

Standards-related Product Specification	
Tx/Rx Channel Frequency Range	2412 MHz ~ 2462 MHz
Maximum (Peak) Output Power to antenna	802.11b : 21.01 dBm (0.1262 W) 802.11g : 23.25 dBm (0.2113 W) 802.11n HT20 : 22.93 dBm (0.1963 W) 802.11n HT40 : 23.76 dBm (0.2377 W)
99% Occupied Bandwidth	802.11b : 13.44MHz 802.11g : 18.83MHz 802.11n HT20 : 19.33MHz 802.11n HT40 : 36.56MHz
Antenna Type / Gain	PIFA Antenna with gain 2.00 dBi
Type of Modulation	802.11b : DSSS (DBPSK / DQPSK / CCK) 802.11g/n : OFDM (BPSK / QPSK / 16QAM / 64QAM)

1.5 Modification of EUT

No modifications are made to the EUT during all test items.



1.6 Testing Location

Sporton International (Kunshan) Inc. is accredited to ISO 17025 by National Voluntary Laboratory Accreditation Program (NVLAP code: 600155-0) and the FCC designation No. is CN5013.

Test Site	Sporton International (Kunshan) Inc.			
Test Site Location	No.3-2 Ping-Xiang Rd, Kunshan Development Zone Kunshan City Jiangsu Province 215335 China TEL : +86-512-57900158 FAX : +86-512-57900958			
Test Site No.	Sporton Site No.			FCC Test Firm Registration No.
	TH01-KS	03CH02-KS	CO01-KS	630927

Note: The test site complies with ANSI C63.4 2014 requirement.

1.7 Applicable Standards

According to the specifications of the manufacturer, the EUT must comply with the requirements of the following standards:

- ♦ FCC Part 15 Subpart C §15.247
- ♦ FCC KDB Publication No. 558074 D01 DTS Meas. Guidance v04
- ♦ ANSI C63.10-2013

Remark:

1. All test items were verified and recorded according to the standards and without any deviation during the test.
2. This EUT has also been tested and complied with the requirements of FCC Part 15, Subpart B, recorded in a separate test report.



2 Test Configuration of Equipment Under Test

The EUT has been associated with peripherals and configuration operated in a manner tended to maximize its emission characteristics in a typical application. Frequency range investigated: conducted emission (150 kHz to 30 MHz) and radiated emission (9 kHz to the 10th harmonic of the highest fundamental frequency or to 40 GHz, whichever is lower). For radiated measurement, pre-scanned in three orthogonal panels, X, Y, Z. The worst cases (X plane) were recorded in this report.

2.1 Carrier Frequency and Channel

Frequency Band	Channel	Freq. (MHz)	Channel	Freq. (MHz)
2400-2483.5 MHz	1	2412	7	2442
	2	2417	8	2447
	3	2422	9	2452
	4	2427	10	2457
	5	2432	11	2462
	6	2437	-	-



2.2 Test Mode

Final test mode of conducted test items and radiated spurious emissions are considering the modulation and worse data rates as below table.

Modulation	Data Rate
802.11b	1 Mbps
802.11g	6 Mbps
802.11n HT20	MCS0
802.11n HT40	MCS0

Test Cases	
AC Conducted Emission	Mode 1: GSM850 Idle + Bluetooth Link + WLAN Link + USB Cable 1(Charging from Adapter)
Remark: For Radiated Test Cases, the tests were performed with Adapter and USB Cable 1.	

2.3 Connection Diagram of Test System

<WLAN Tx Mode>

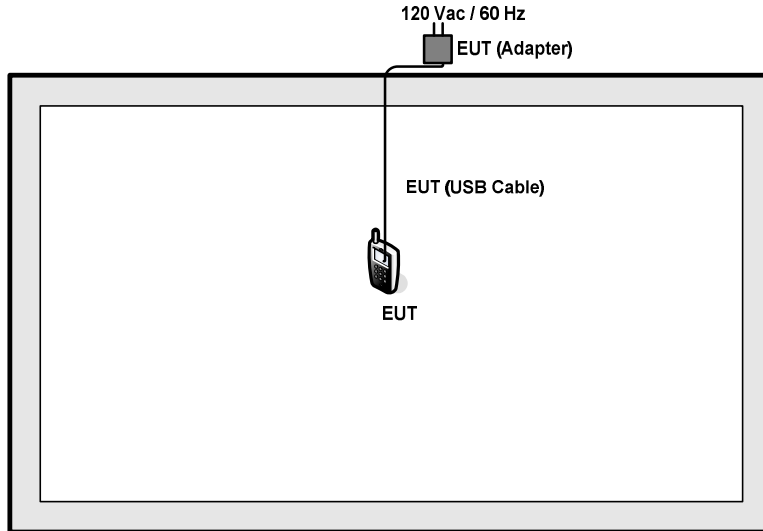

<AC Conducted Emission Mode>

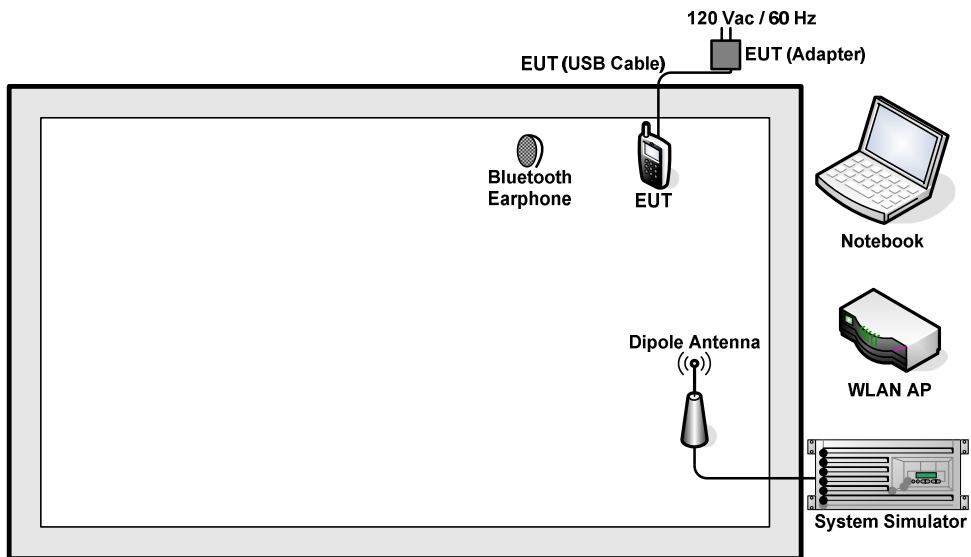



2.4 Support Unit used in test configuration and system

Item	Equipment	Trade Name	Model Name	FCC ID	Data Cable	Power Cord
1.	System Simulator	R&S	CMU 200	N/A	N/A	Unshielded, 1.8 m
2.	Notebook	Lenovo	G480	N/A	N/A	AC I/P: Unshielded, 1.2 m DC O/P: Shielded, 1.8 m
3.	WLAN AP	D-Link	DIR-855	KA2DIR855LA2	N/A	Unshielded,1.8m
4.	Bluetooth Earphone	Lenovo	LBH308	N/A	N/A	N/A

2.5 EUT Operation Test Setup

For WLAN RF test items, an engineering test program was provided and enabled to make EUT continuously transmit/receive.

For AC power line conducted emissions, the EUT was set to connect with the Notebook under large package sizes transmission.



2.6 Measurement Results Explanation Example

For all conducted test items:

The offset level is set in the spectrum analyzer to compensate the RF cable loss between EUT conducted output port and spectrum analyzer. With the offset compensation, the spectrum analyzer reading level is exactly the EUT RF output level.

Example :

The spectrum analyzer offset is derived from RF cable loss.

Offset = RF cable loss.

Following shows an offset computation example with cable loss 5.8 dB.

$$\begin{aligned} \text{Offset(dB)} &= \text{RF cable loss(dB)}. \\ &= 5.8 \text{ (dB)} \end{aligned}$$

3 Test Result

3.1 6dB and 99% Bandwidth Measurement

3.1.1 Limit of 6dB and 99% Bandwidth

The minimum 6 dB bandwidth shall be at least 500 kHz.

3.1.2 Measuring Instruments

The measuring equipment is listed in the section 4 of this test report.

3.1.3 Test Procedures

1. The testing follows FCC KDB Publication No. 558074 DTS D01 Meas. Guidance v04.
2. The RF output of EUT was connected to the spectrum analyzer by RF cable and attenuator. The path loss was compensated to the results for each measurement.
3. Set to the maximum power setting and enable the EUT transmit continuously.
4. Make the measurement with the spectrum analyzer's resolution bandwidth (RBW) = 100 kHz. Set the Video bandwidth (VBW) = 300 kHz. In order to make an accurate measurement. The 6 dB bandwidth must be greater than 500 kHz.
5. For 99% Bandwidth Measurement, the spectrum analyzer's resolution bandwidth (RBW) = 1MHz and set the Video bandwidth (VBW) = 3MHz.
6. Measure and record the results in the test report.

3.1.4 Test Setup

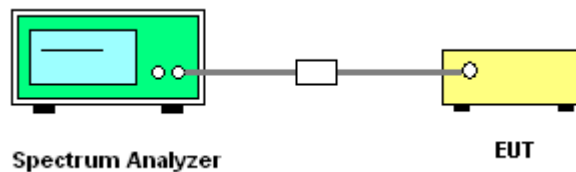



3.1.5 Test Result of 6dB and 99% Occupied Bandwidth

Please refer to Appendix A.

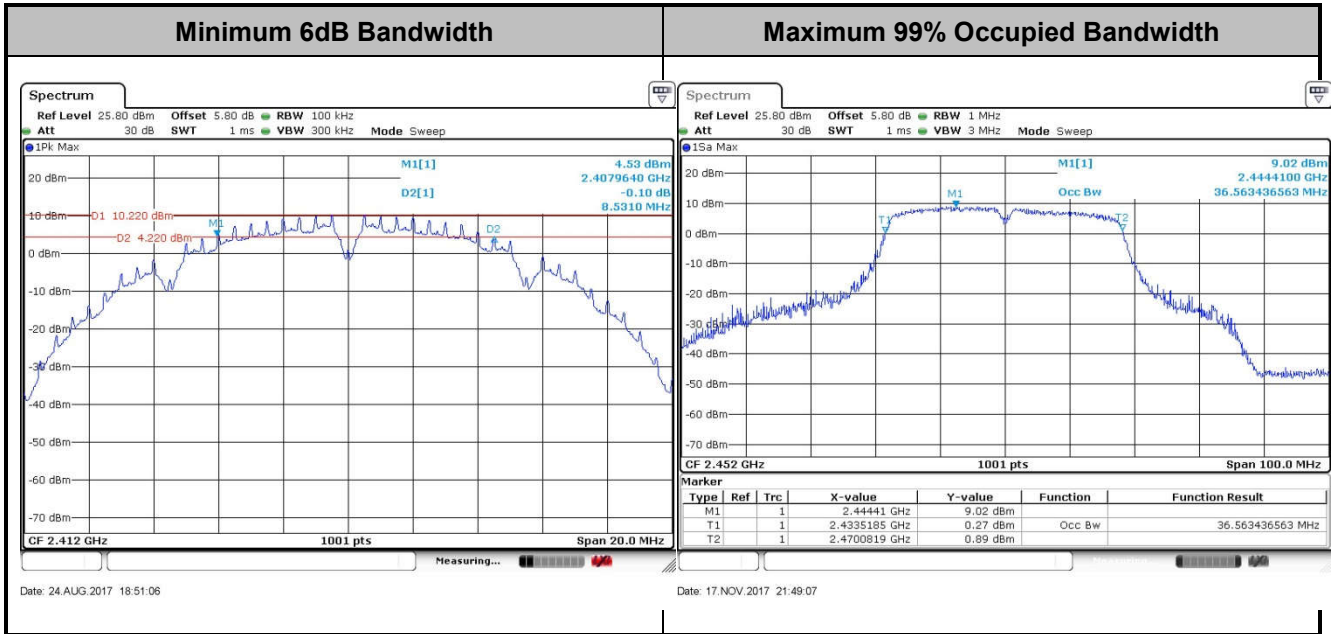

Note : The occupied channel bandwidth is maintained within the band of operation for all of the modulations.

3.2 Output Power Measurement

3.2.1 Limit of Output Power

For systems using digital modulation in the 2400-2483.5MHz, the limit for peak output power is 30dBm. If transmitting antenna of directional gain greater than 6dBi are used the peak output power from the intentional radiator shall be reduced below the above stated value by the amount in dB that the directional gain of the antenna exceeds 6 dBi. In case of point-to-point operation, the limit has to be reduced by 1dB for every 3dB that the directional gain of the antenna exceeds 6dBi.

3.2.2 Measuring Instruments

The measuring equipment is listed in the section 4 of this test report.

3.2.3 Test Procedures

1. The testing follows the Measurement Procedure of FCC KDB No. 558074 DTS D01 Meas. Guidance v04 section 9.1.2 PKPM1 Peak power meter method.
2. The RF output of EUT was connected to the power meter by RF cable and attenuator. The path loss was compensated to the results for each measurement.
3. Set to the maximum power setting and enable the EUT transmit continuously.
4. Measure the conducted output power and record the results in the test report.

3.2.4 Test Setup

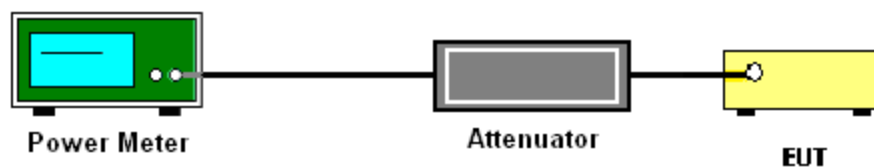

3.2.5 Test Result of Peak Output Power

Please refer to Appendix A.

3.2.6 Test Result of Average output Power (Reporting Only)

Please refer to Appendix A.

3.3 Power Spectral Density Measurement

3.3.1 Limit of Power Spectral Density

The peak power spectral density shall not be greater than 8dBm in any 3kHz band at any time interval of continuous transmission.

3.3.2 Measuring Instruments

The measuring equipment is listed in the section 4 of this test report.

3.3.3 Test Procedures

1. The testing follows Measurement Procedure 10.2 Method PKPSD of FCC KDB Publication No. 558074 D01 DTS Meas. Guidance v04
2. The RF output of EUT was connected to the spectrum analyzer by RF cable and attenuator. The path loss was compensated to the results for each measurement.
3. Set to the maximum power setting and enable the EUT transmit continuously.
4. Make the measurement with the spectrum analyzer's resolution bandwidth (RBW) = 3 kHz. Video bandwidth VBW = 10 kHz In order to make an accurate measurement, set the span to 1.5 times DTS Channel Bandwidth. (6dB BW)
5. Detector = peak, Sweep time = auto couple, Trace mode = max hold, Allow trace to fully stabilize. Use the peak marker function to determine the maximum power level.
6. Measure and record the results in the test report.

3.3.4 Test Setup

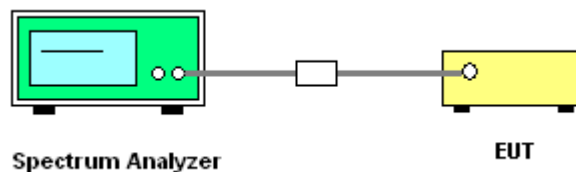



3.3.5 Test Result of Power Spectral Density

Please refer to Appendix A.

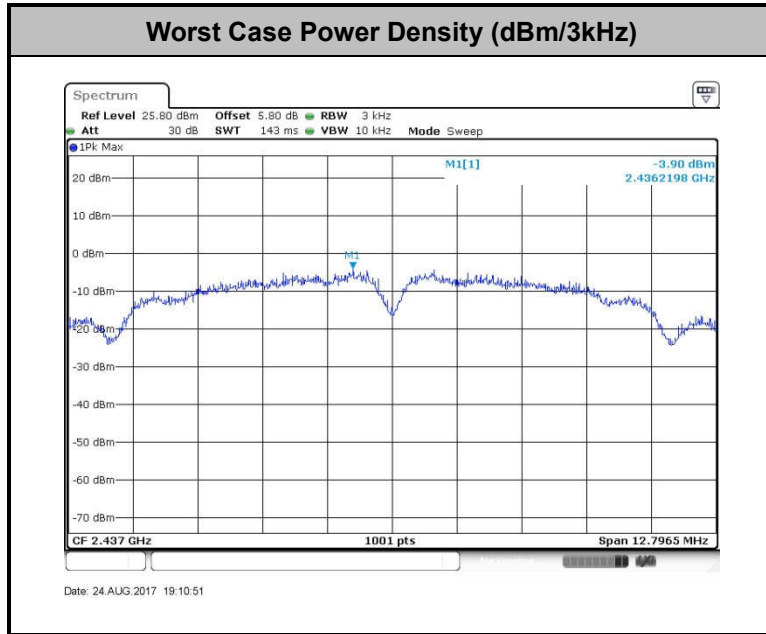

3.4 Conducted Band Edges and Spurious Emission Measurement

3.4.1 Limit of Conducted Band Edges and Spurious Emission Measurement

In any 100 kHz bandwidth outside of the authorized frequency band, the emissions which fall in the non-restricted bands shall be attenuated at least 20 dB / 30dB relative to the maximum PSD level in 100 kHz by RF conducted measurement.

3.4.2 Measuring Instruments

The measuring equipment is listed in the section 4 of this test report.

3.4.3 Test Procedures

1. The testing follows FCC KDB Publication No. 558074 D01 DTS Meas. Guidance v04.
2. The RF output of EUT was connected to the spectrum analyzer by RF cable and attenuator. The path loss was compensated to the results for each measurement.
3. Set to the maximum power setting and enable the EUT transmit continuously.
4. Set RBW = 100 kHz, VBW=300 kHz, Peak Detector. Unwanted Emissions measured in any 100 kHz bandwidth outside of the authorized frequency band shall be attenuated by at least 20 dB relative to the maximum in-band peak PSD level in 100 kHz when maximum peak conducted output power procedure is used. If the transmitter complies with the conducted power limits based on the use of RMS averaging over a time interval, the attenuation required under this paragraph shall be 30 dB instead of 20 dB.
5. Measure and record the results in the test report.
6. The RF fundamental frequency should be excluded against the limit line in the operating frequency band.

3.4.4 Test Setup

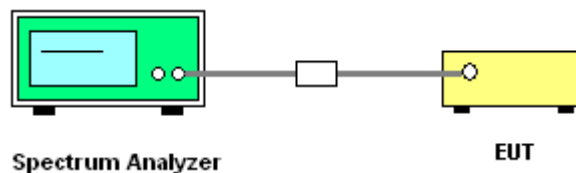



3.4.5 Test Result of Conducted Band Edges and Spurious Emission

Test Mode :	802.11b	Temperature :	21~25°C
Test Band :	2.4GHz Low	Relative Humidity :	51~55%
Test Channel :	01	Test Engineer :	Silent Hai

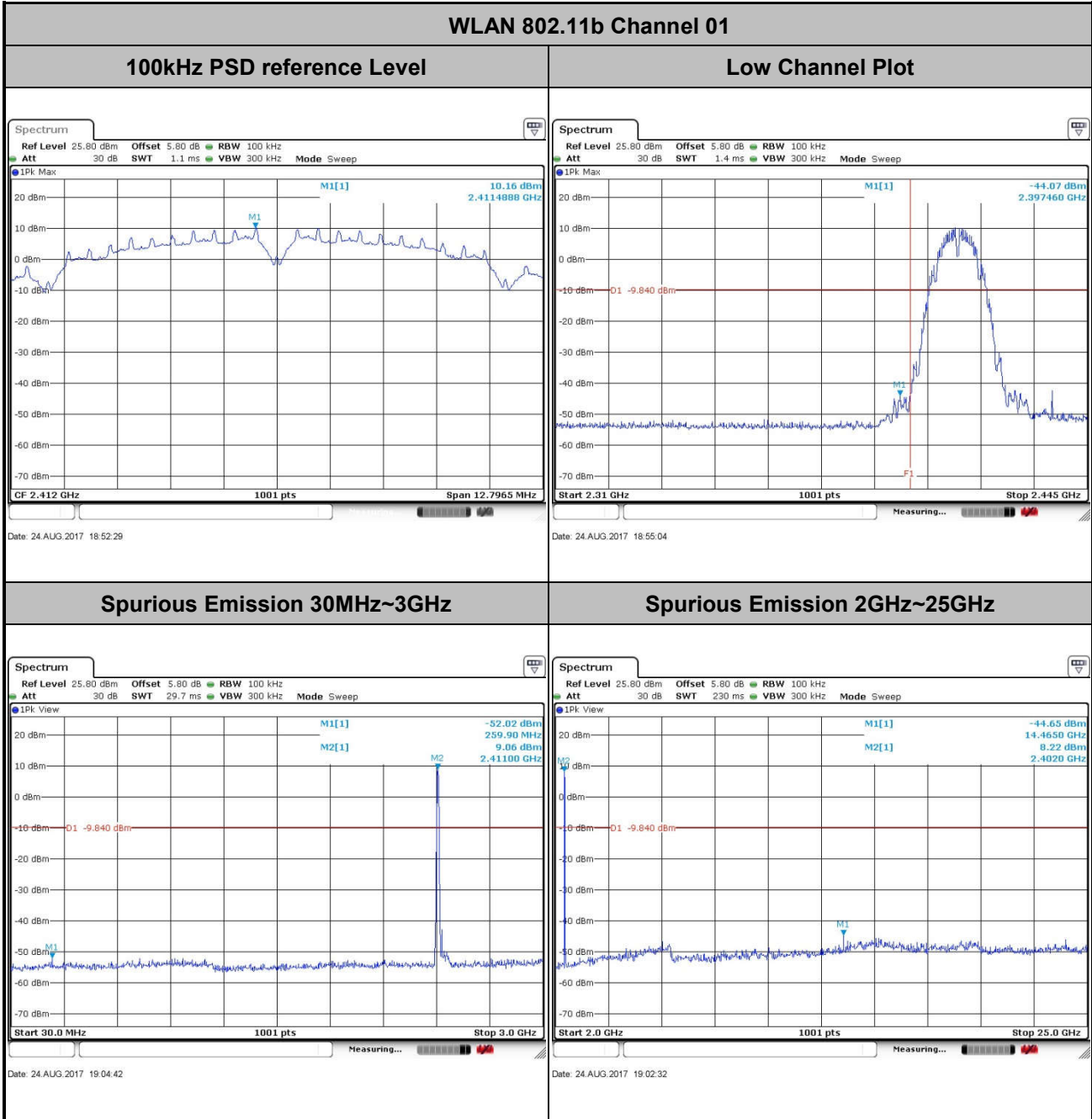



Test Mode :	802.11b	Temperature :	21~25°C
Test Band :	2.4GHz Mid	Relative Humidity :	51~55%
Test Channel :	06	Test Engineer :	Silent Hai

WLAN 802.11b Channel 06

100kHz PSD reference Level

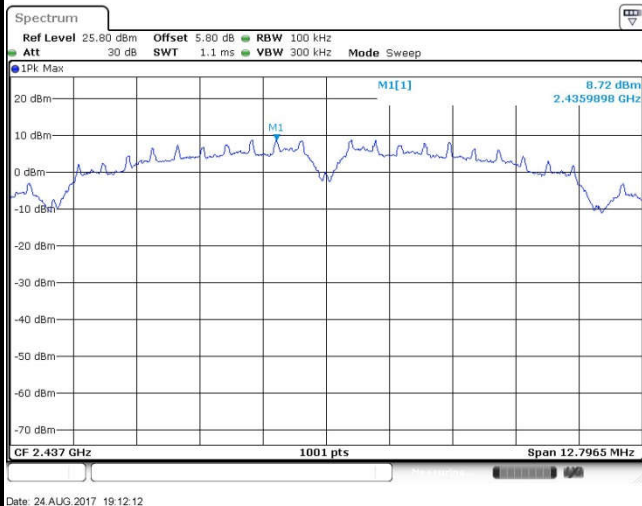

Spurious Emission 30MHz~3GHz

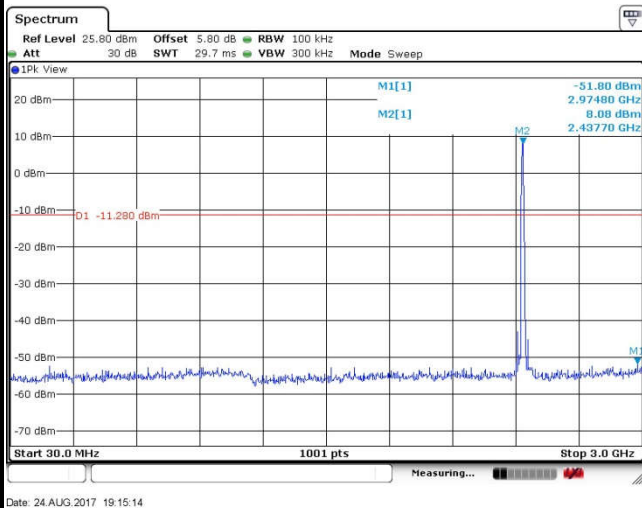

Spurious Emission 2GHz~25GHz

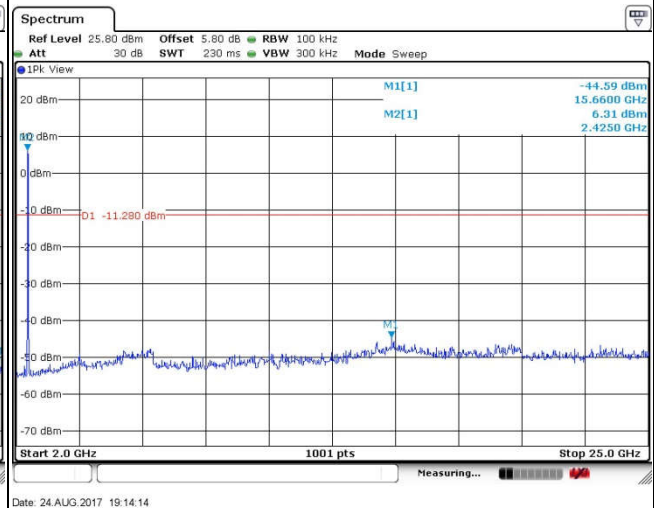



Test Mode :	802.11b	Temperature :	21~25°C
Test Band :	2.4GHz High	Relative Humidity :	51~55%
Test Channel :	11	Test Engineer :	Silent Hai

WLAN 802.11b Channel 11

100kHz PSD reference Level

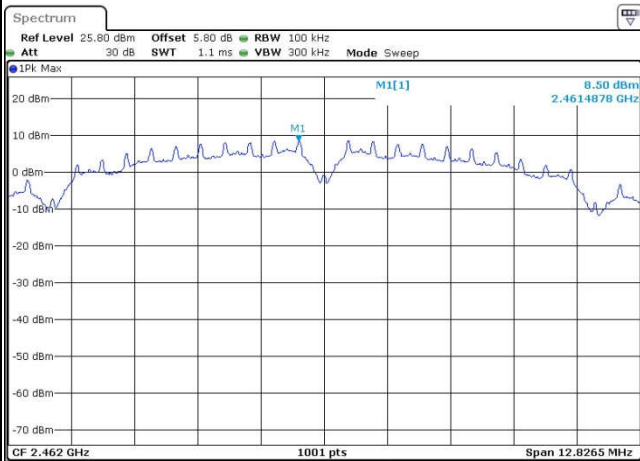

High Channel Plot

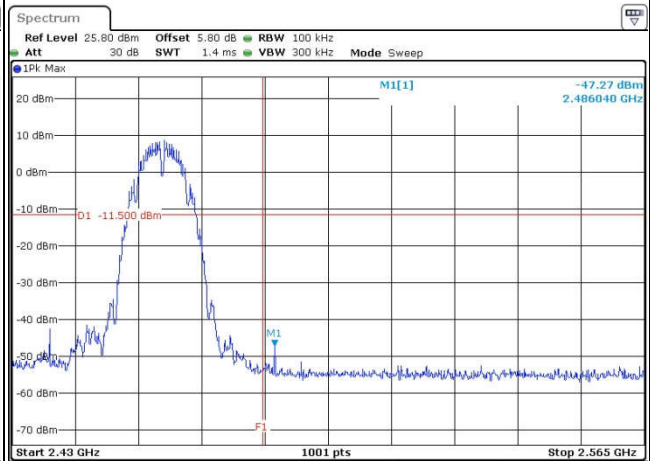

Spurious Emission 30MHz~3GHz

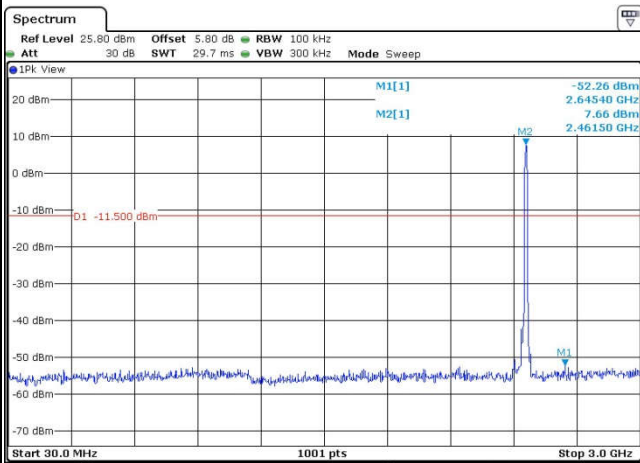

Spurious Emission 2GHz~25GHz

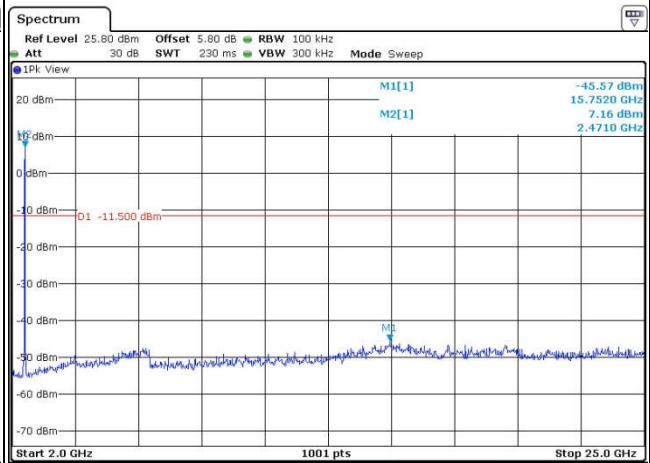



Test Mode :	802.11g	Temperature :	21~25°C
Test Band :	2.4GHz Low	Relative Humidity :	51~55%
Test Channel :	01	Test Engineer :	Silent Hai

WLAN 802.11g Channel 01

100kHz PSD reference Level

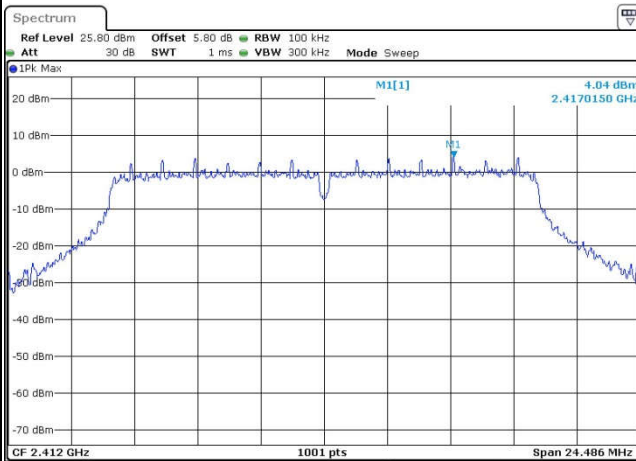

Date: 17.NOV.2017 20:57:55

Low Channel Plot

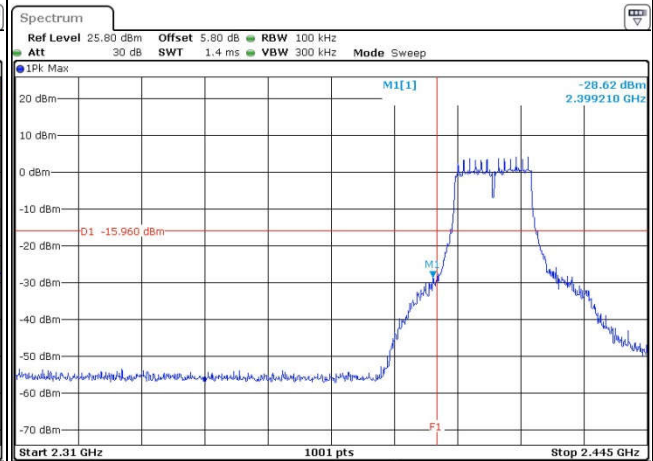

Date: 17.NOV.2017 20:58:33

Spurious Emission 30MHz~3GHz

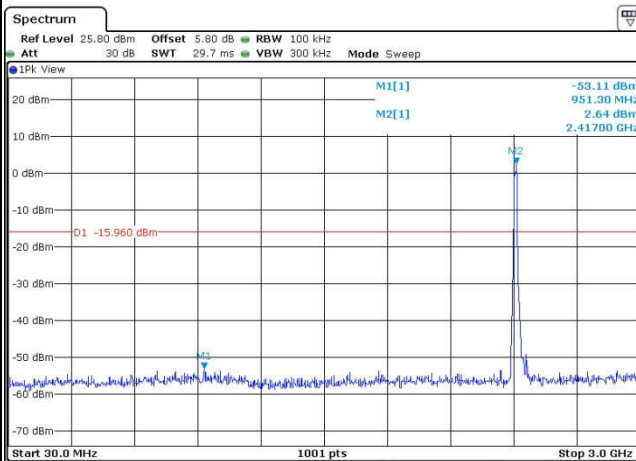

Date: 17.NOV.2017 20:59:46

Spurious Emission 2GHz~25GHz

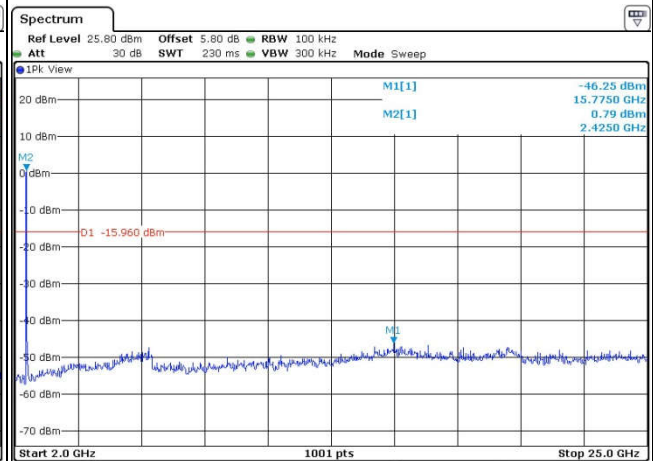

Date: 17.NOV.2017 20:59:11



Test Mode :	802.11g	Temperature :	21~25°C
Test Band :	2.4GHz Mid	Relative Humidity :	51~55%
Test Channel :	06	Test Engineer :	Silent Hai

WLAN 802.11g Channel 06

100kHz PSD reference Level

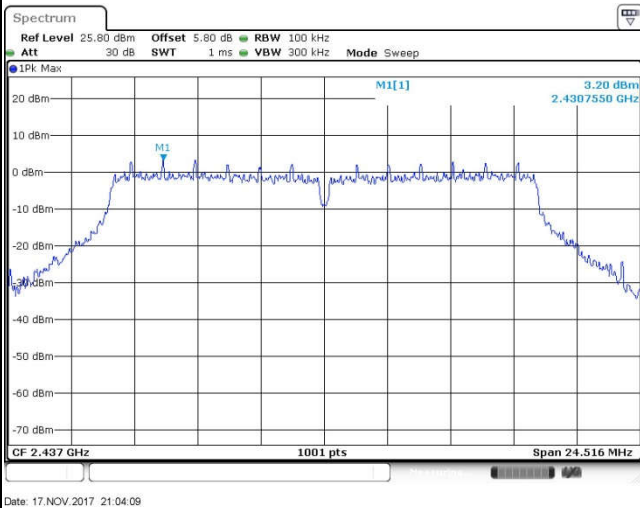

Spurious Emission 30MHz~3GHz

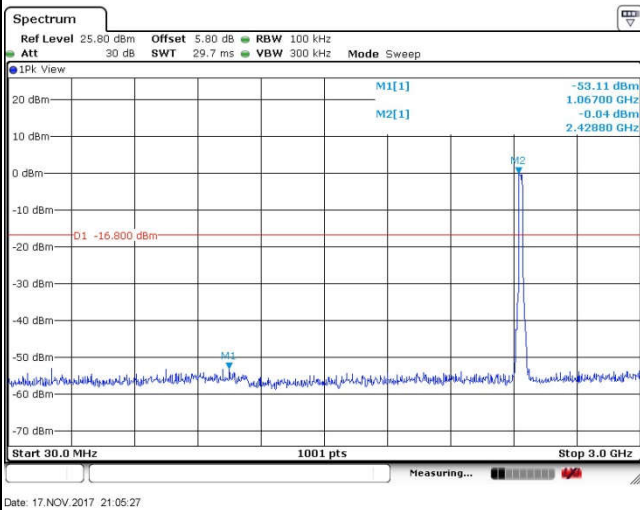

Spurious Emission 2GHz~25GHz

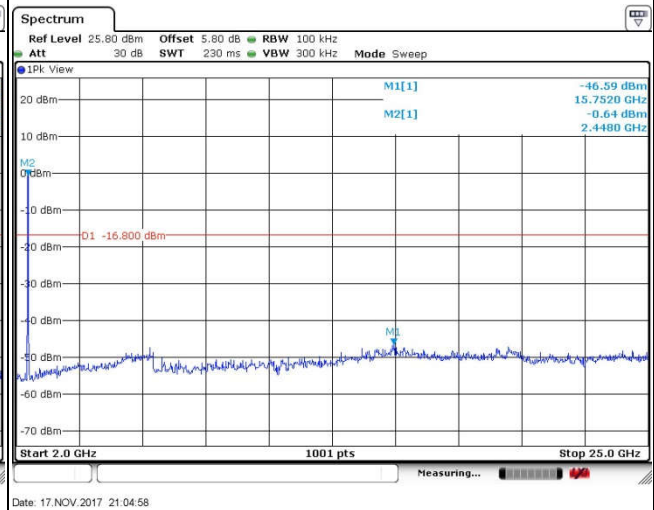



Test Mode :	802.11g	Temperature :	21~25°C
Test Band :	2.4GHz High	Relative Humidity :	51~55%
Test Channel :	11	Test Engineer :	Silent Hai

WLAN 802.11g Channel 11

100kHz PSD reference Level

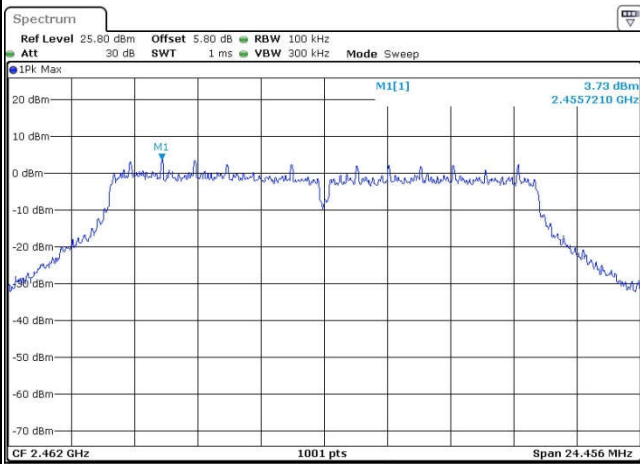

Date: 17.NOV.2017 21:08:48

High Channel Plot

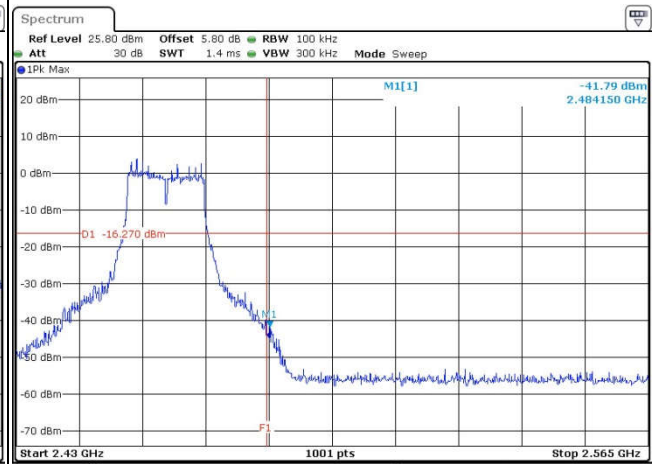

Date: 17.NOV.2017 21:09:17

Spurious Emission 30MHz~3GHz

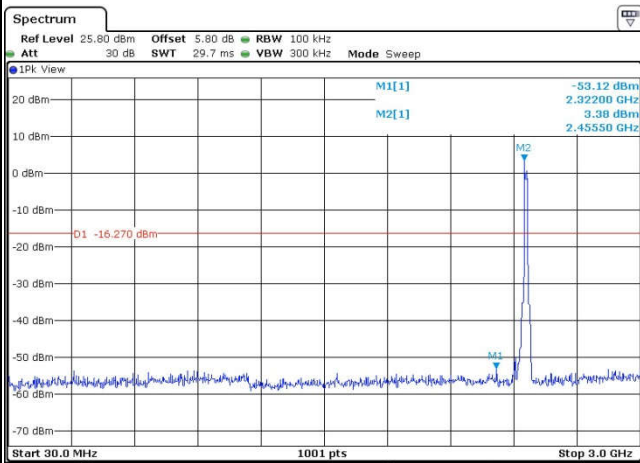

Date: 17.NOV.2017 21:11:09

Spurious Emission 2GHz~25GHz

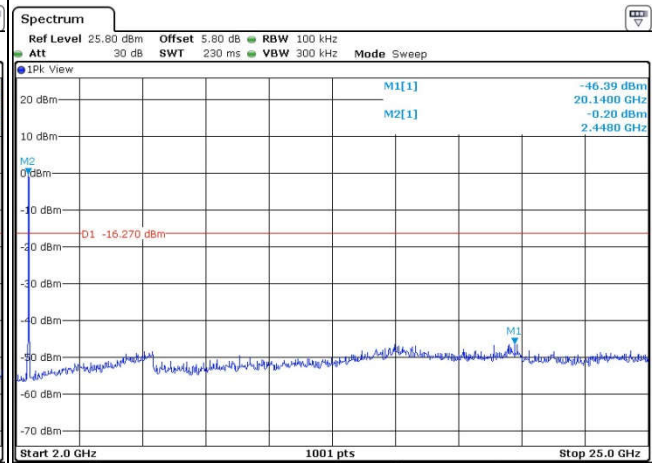

Date: 17.NOV.2017 21:10:33



Test Mode :	802.11n HT20	Temperature :	21~25°C
Test Band :	2.4GHz Low	Relative Humidity :	51~55%
Test Channel :	01	Test Engineer :	Silent Hai

WLAN 802.11n HT20 Channel 01

100kHz PSD reference Level

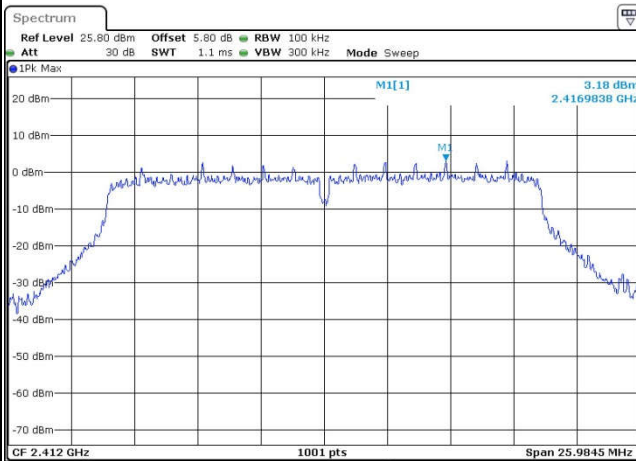

Date: 17.NOV.2017 21:16:31

Low Channel Plot

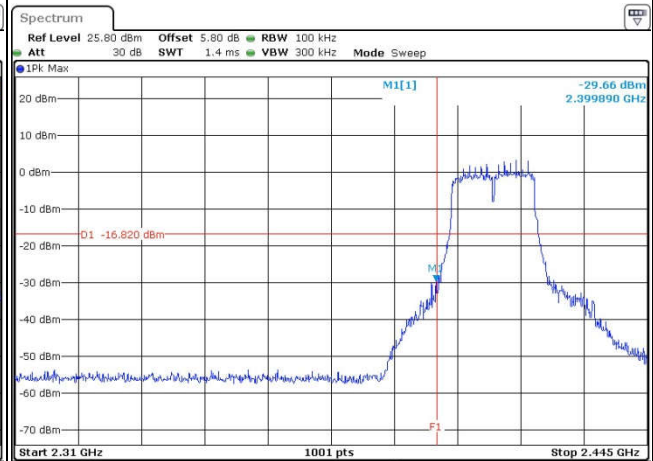

Date: 17.NOV.2017 21:16:47

Spurious Emission 30MHz~3GHz

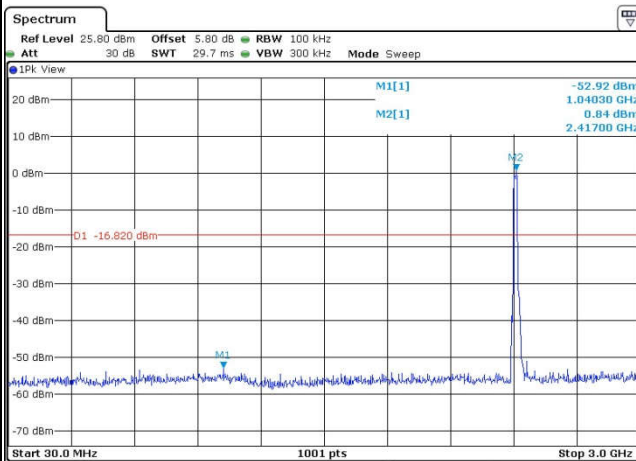

Date: 17.NOV.2017 21:17:55

Spurious Emission 2GHz~25GHz

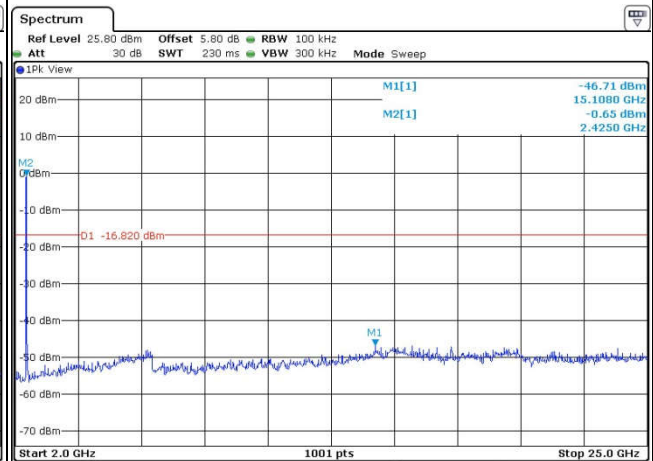

Date: 17.NOV.2017 21:17:26



Test Mode :	802.11n HT20	Temperature :	21~25°C
Test Band :	2.4GHz Mid	Relative Humidity :	51~55%
Test Channel :	06	Test Engineer :	Silent Hai

WLAN 802.11n HT20 Channel 06

100kHz PSD reference Level

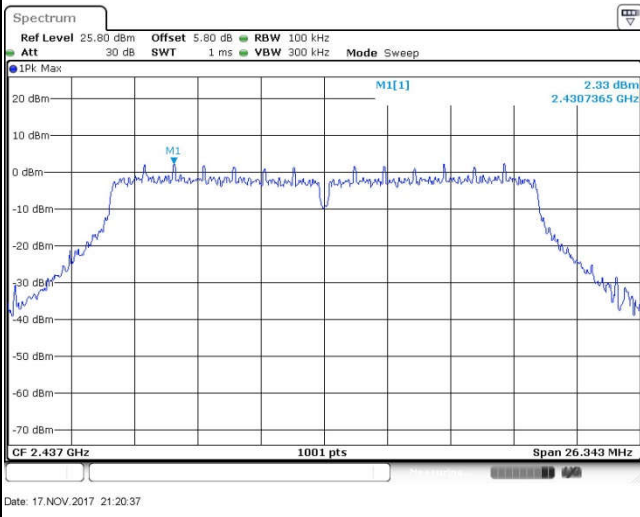

Spurious Emission 30MHz~3GHz

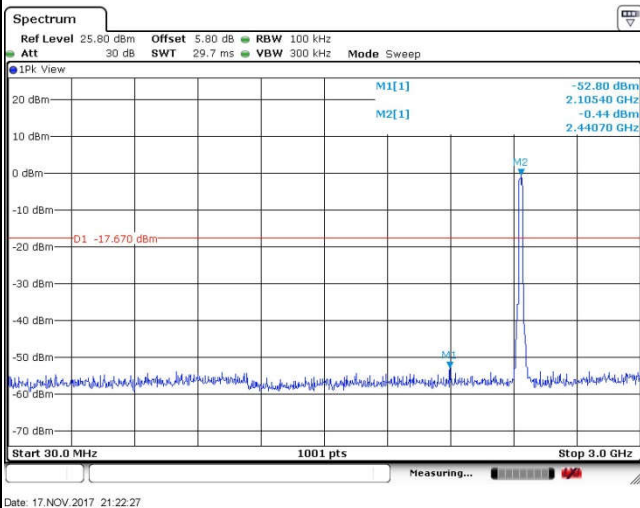

Spurious Emission 2GHz~25GHz

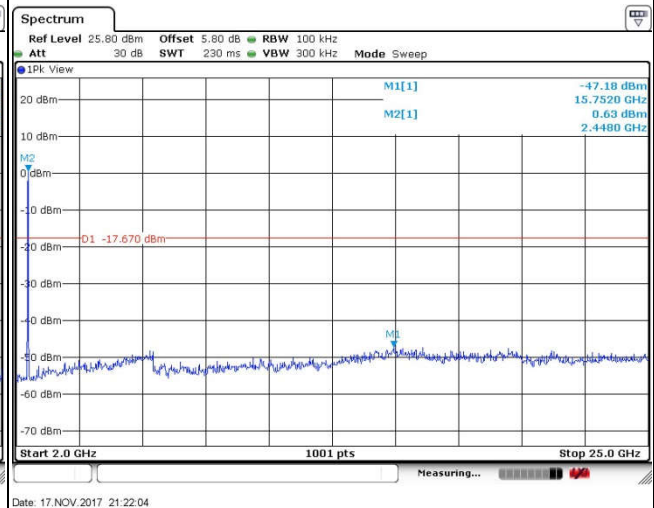



Test Mode :	802.11n HT20	Temperature :	21~25°C
Test Band :	2.4GHz High	Relative Humidity :	51~55%
Test Channel :	11	Test Engineer :	Silent Hai

WLAN 802.11n HT20 Channel 11

100kHz PSD reference Level

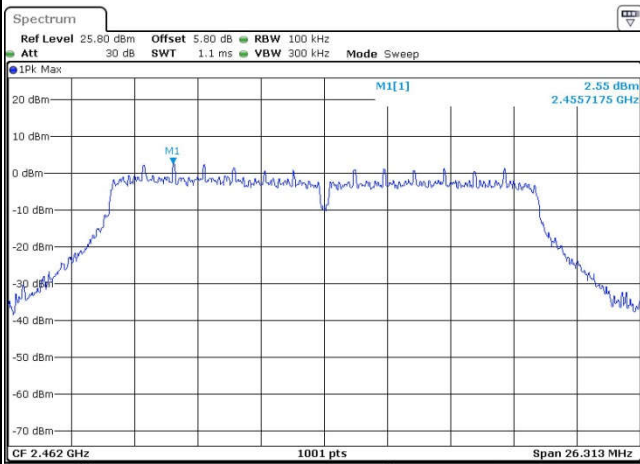

Date: 17.NOV.2017 21:29:33

High Channel Plot

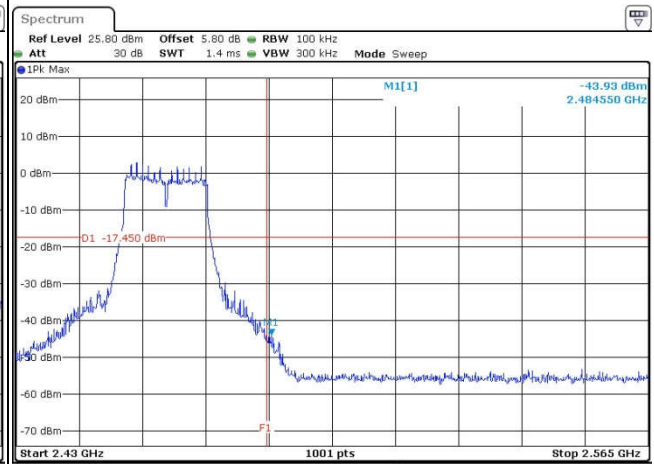

Date: 17.NOV.2017 21:30:03

Spurious Emission 30MHz~3GHz

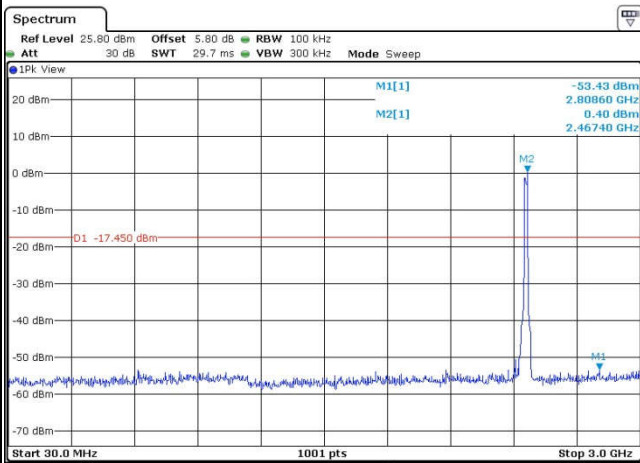

Date: 17.NOV.2017 21:31:25

Spurious Emission 2GHz~25GHz

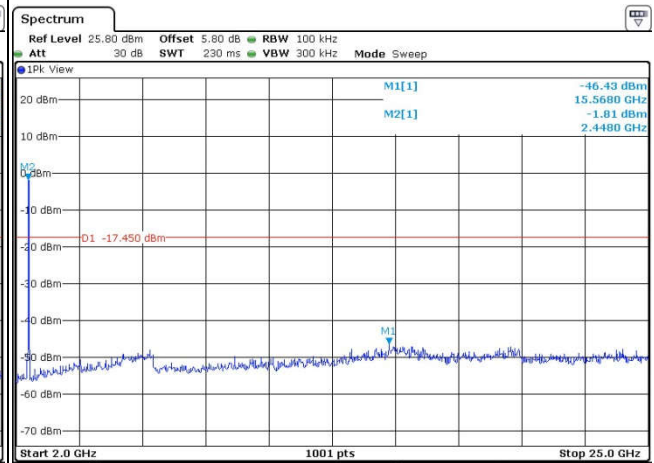

Date: 17.NOV.2017 21:30:46



Test Mode :	802.11n HT40	Temperature :	21~25°C
Test Band :	2.4GHz Low	Relative Humidity :	51~55%
Test Channel :	03	Test Engineer :	Silent Hai

WLAN 802.11n HT40 Channel 03

100kHz PSD reference Level

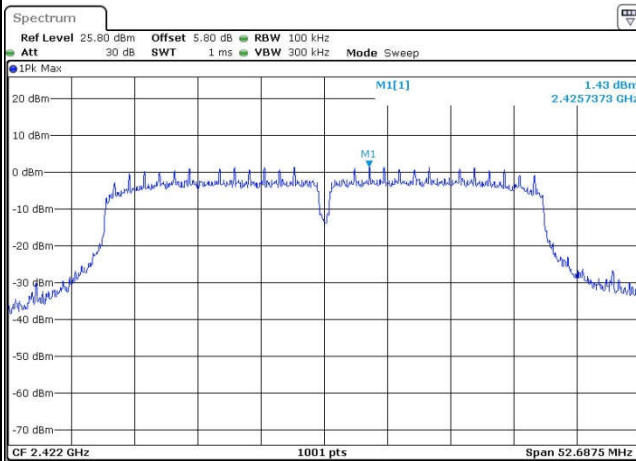

Date: 17.NOV.2017 21:34:53

Low Channel Plot

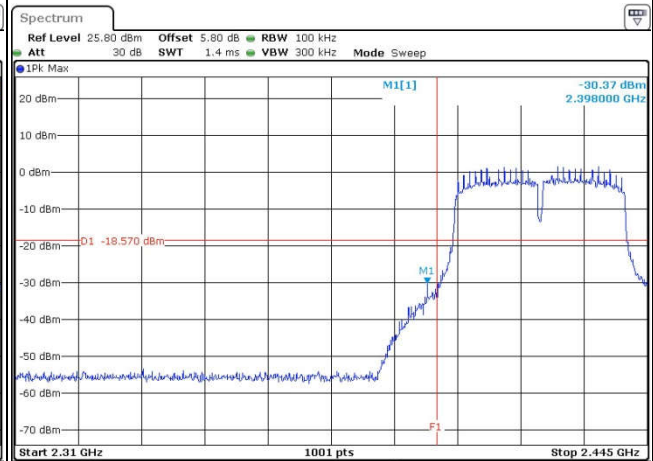

Date: 17.NOV.2017 21:35:14

Spurious Emission 30MHz~3GHz

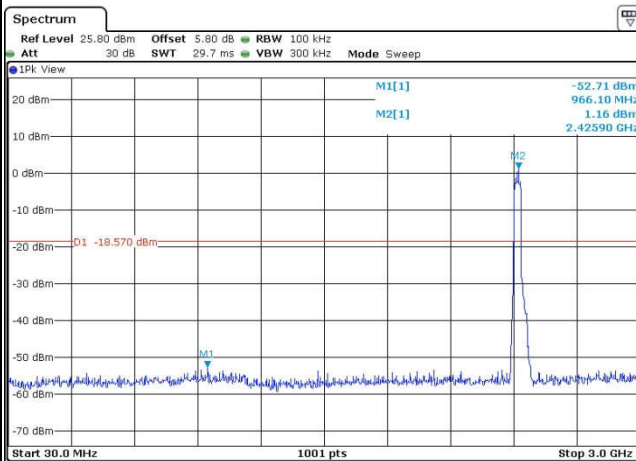

Date: 17.NOV.2017 21:36:16

Spurious Emission 2GHz~25GHz

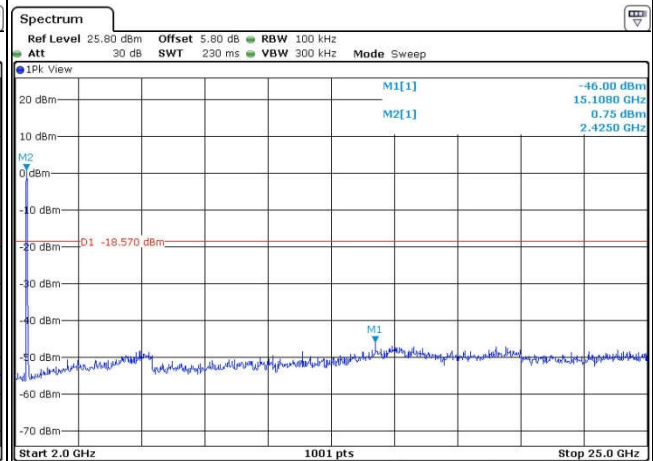

Date: 17.NOV.2017 21:35:49



Test Mode :	802.11n HT40	Temperature :	21~25°C
Test Band :	2.4GHz Mid	Relative Humidity :	51~55%
Test Channel :	06	Test Engineer :	Silent Hai

WLAN 802.11n HT40 Channel 06

100kHz PSD reference Level

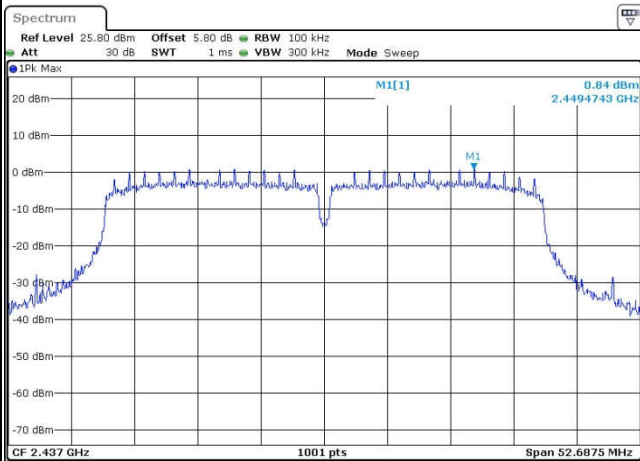

Date: 17.NOV.2017 21:41:05

Spurious Emission 30MHz~3GHz

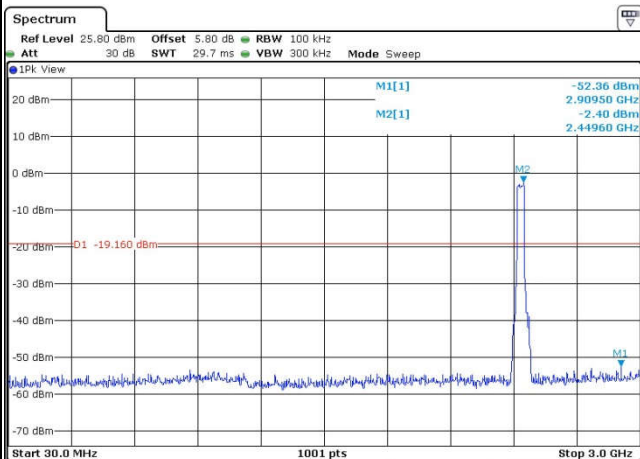

Date: 17.NOV.2017 21:42:32

Spurious Emission 2GHz~25GHz

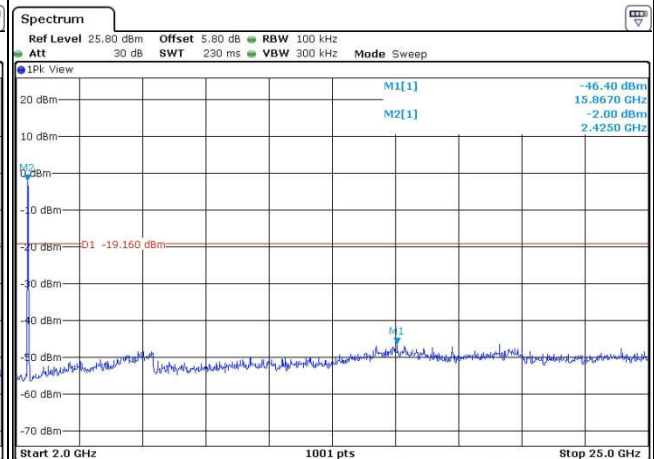

Date: 17.NOV.2017 21:41:51



Test Mode :	802.11n HT40	Temperature :	21~25°C
Test Band :	2.4GHz High	Relative Humidity :	51~55%
Test Channel :	09	Test Engineer :	Silent Hai

WLAN 802.11n HT40 Channel 09

100kHz PSD reference Level

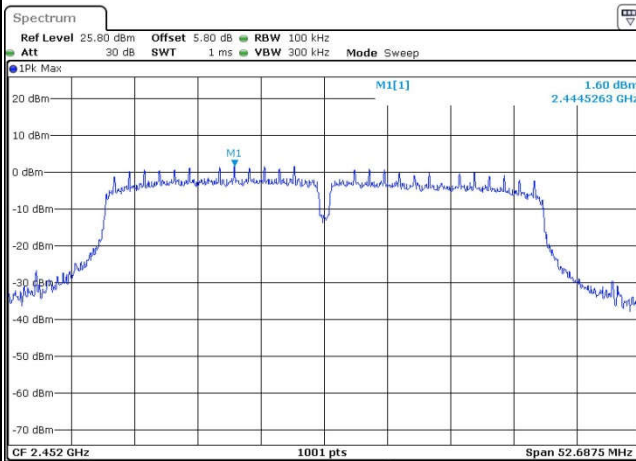

High Channel Plot

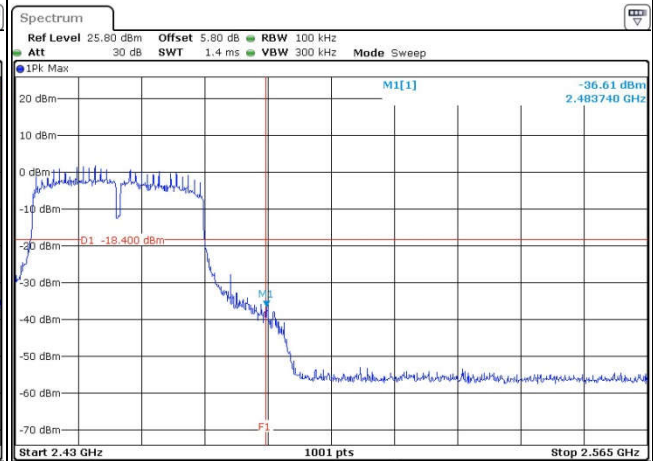

Spurious Emission 30MHz~3GHz

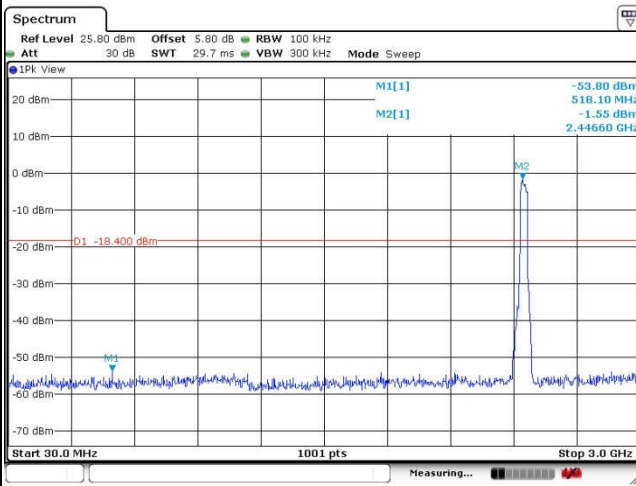

Spurious Emission 2GHz~25GHz

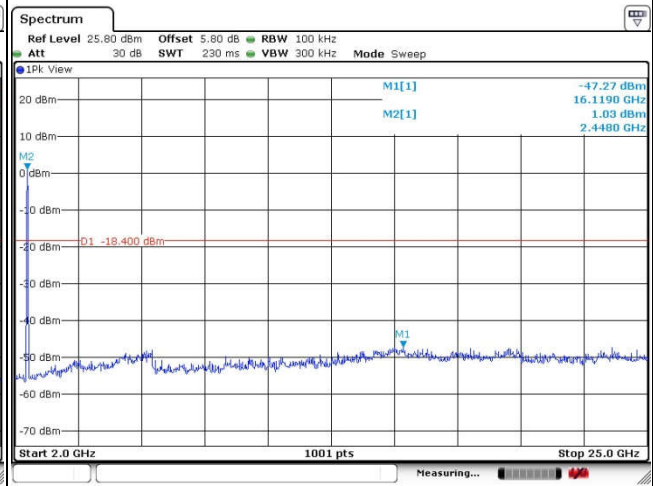



3.5 Radiated Band Edges and Spurious Emission Measurement

3.5.1 Limit of Radiated band edge and Spurious Emission Measurement

In any 100 kHz bandwidth outside the intentional radiator frequency band, all harmonics/spurious must be at least 20 dB below the highest emission level within the authorized band. If the output power of this device was measured by spectrum analyzer, the attenuation under this paragraph shall be 30 dB instead of 20 dB. In addition, radiated emissions which fall in the restricted bands must also comply with the limits as below.

Frequency (MHz)	Field Strength (microvolts/meter)	Measurement Distance (meters)
0.009 – 0.490	2400/F(kHz)	300
0.490 – 1.705	24000/F(kHz)	30
1.705 – 30.0	30	30
30 – 88	100	3
88 – 216	150	3
216 - 960	200	3
Above 960	500	3

3.5.2 Measuring Instruments

The measuring equipment is listed in the section 4 of this test report.



3.5.3 Test Procedures

1. The testing follows FCC KDB Publication No. 558074 D01 DTS Meas. Guidance v04.
2. The EUT was arranged to its worst case and then tune the antenna tower (from 1 m to 4 m) and turntable (from 0 degree to 360 degrees) to find the maximum reading. A pre-amp and a high pass filter are used for the test in order to get better signal level.
3. The EUT was placed on a turntable with 0.8 meter for frequency below 1GHz and 1.5 meter for frequency above 1GHz respectively above ground.
4. The EUT was set 3 meters from the interference receiving antenna, which was mounted on the top of a variable height antenna tower.
5. Corrected Reading: Antenna Factor + Cable Loss + Read Level - Preamp Factor = Level
6. For measurement below 1GHz, If the emission level of the EUT measured by the peak detector is 3 dB lower than the applicable limit, the peak emission level will be reported. Otherwise, the emission measurement will be repeated using the quasi-peak detector and reported.
7. Use the following spectrum analyzer settings:
 - (1) Span shall wide enough to fully capture the emission being measured;
 - (2) Set RBW=100 kHz for $f < 1$ GHz; $VBW \geq RBW$; Sweep = auto; Detector function = peak; Trace = max hold;
 - (3) Set RBW = 1 MHz, VBW= 3MHz for $f \geq 1$ GHz for peak measurement.

For average measurement:

 - $VBW = 10$ Hz, when duty cycle is no less than 98 percent.
 - $VBW \geq 1/T$, when duty cycle is less than 98 percent where T is the minimum transmission duration over which the transmitter is on and is transmitting at its maximum power control level for the tested mode of operation.

For average measurement:

 - Detector = power averaging (rms), set sweep point ≥ 2 span / RBW.
 - Averaging type = power averaging(RMS)
 - The correction factor shall be offset is $10 \log (1/x)$, where x is the duty cycle.

3.5.4 Test Setup

For radiated emissions below 30MHz

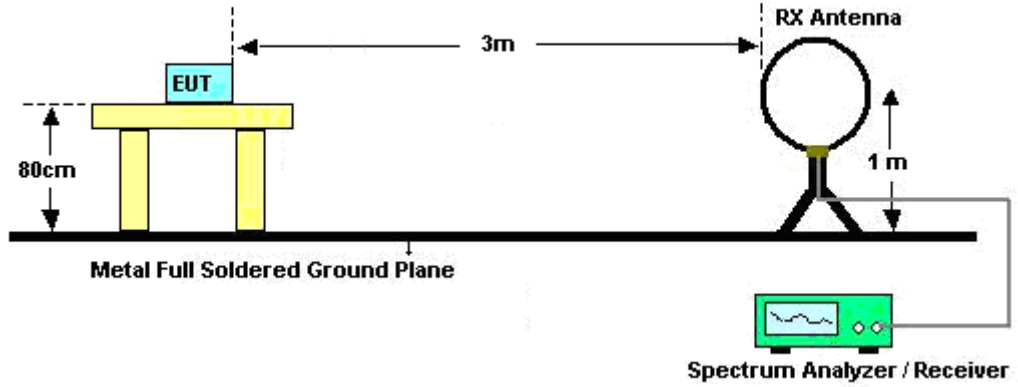

For radiated emissions from 30MHz to 1GHz

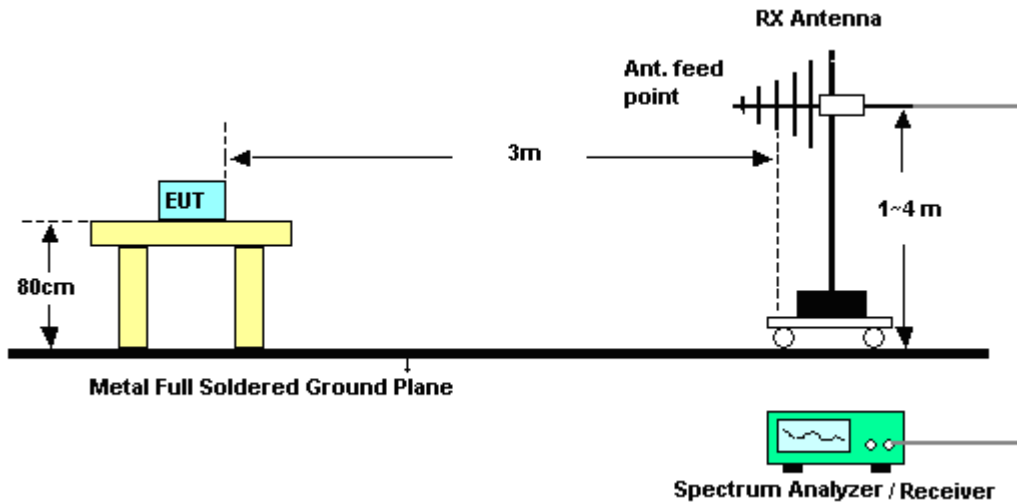

For radiated emissions above 1GHz

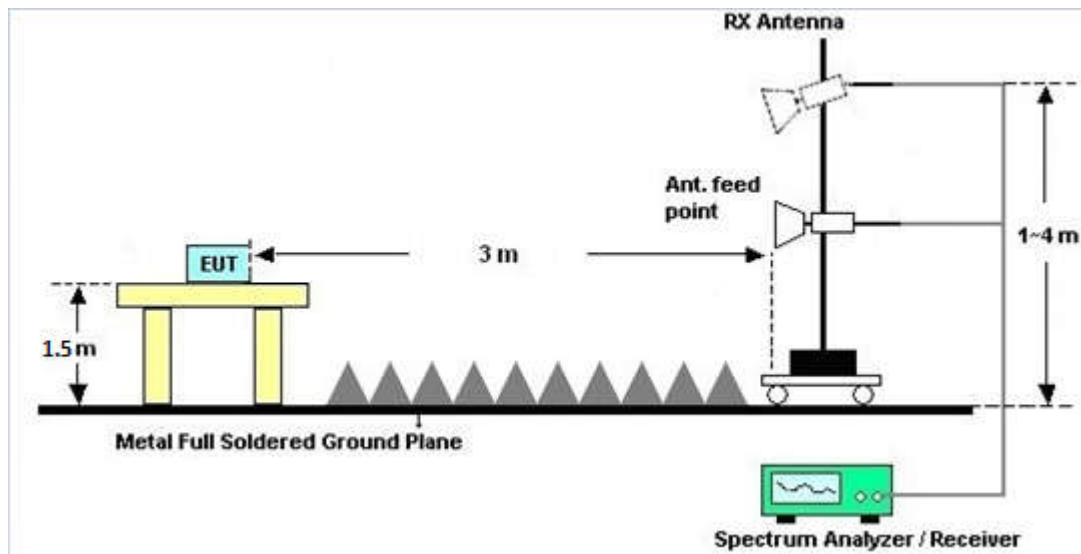

3.5.5 Test Results of Radiated Spurious Emissions (9kHz ~ 30MHz)

The low frequency, which started from 9 kHz to 30MHz, was pre-scanned and the result which was 20dB lower than the limit line was not reported.

3.5.6 Test Result of Radiated Spurious at Band Edges

Please refer to Appendix B.

3.5.7 Duty Cycle

Please refer to Appendix C.

3.5.8 Test Result of Radiated Spurious Emission (30MHz ~ 10th Harmonic)

Please refer to Appendix B.



3.6 AC Conducted Emission Measurement

3.6.1 Limit of AC Conducted Emission

For equipment that is designed to be connected to the public utility (AC) power line, the radio frequency voltage that is conducted back onto the AC power line on any frequency or frequencies within the band 150 kHz to 30 MHz shall not exceed the limits in the following table.

Frequency of Emission (MHz)	Conducted Limit (dBµV)	
	Quasi-Peak	Average
0.15-0.5	66 to 56*	56 to 46*
0.5-5	56	46
5-30	60	50

*Decreases with the logarithm of the frequency.

3.6.2 Measuring Instruments

The measuring equipment is listed in the section 4 of this test report.

3.6.3 Test Procedures

1. The EUT was placed 0.4 meter from the conducting wall of the shielding room, and it was kept at least 80 centimeters from any other grounded conducting surface.
2. Connect EUT to the power mains through a line impedance stabilization network (LISN).
3. All the support units are connecting to the other LISN.
4. The LISN provides 50 ohm coupling impedance for the measuring instrument.
5. The FCC states that a 50 ohm, 50 microhenry LISN should be used.
6. Both sides of AC line were checked for maximum conducted interference.
7. The frequency range from 150 kHz to 30 MHz was searched.
8. Set the test-receiver system to Peak Detect Function and specified bandwidth (IF bandwidth = 9kHz) with Maximum Hold Mode.

3.6.4 Test Setup

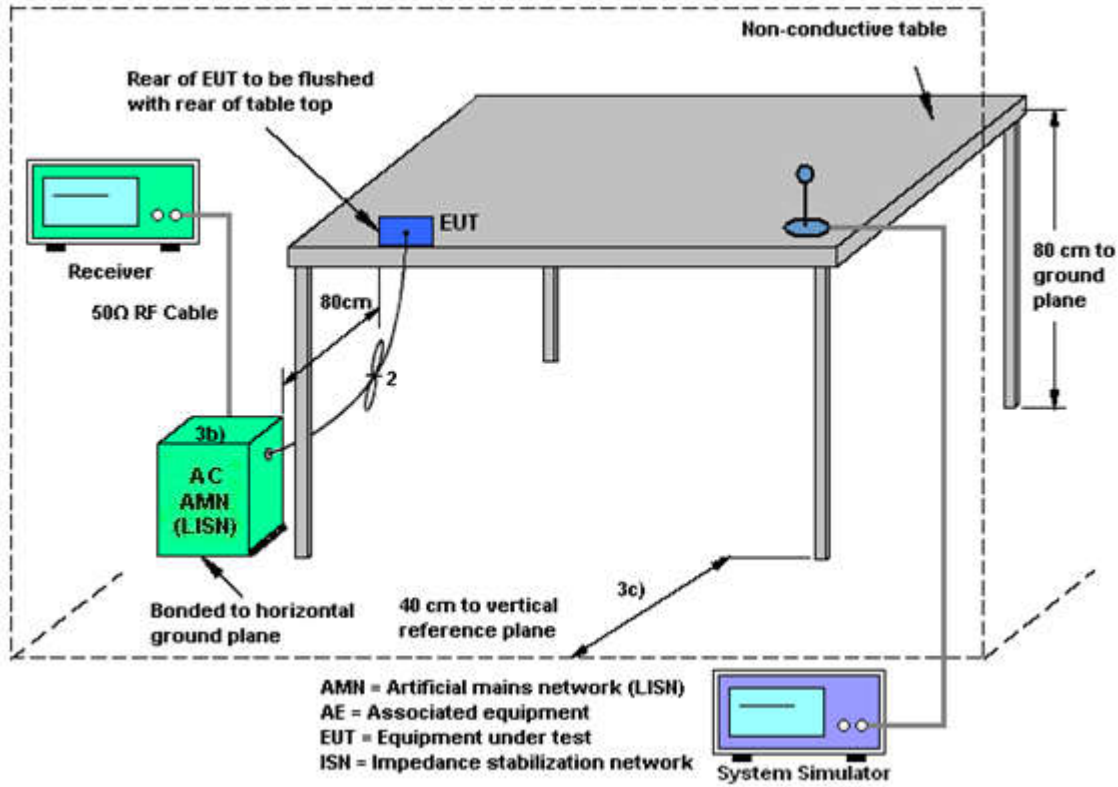



3.6.5 Test Result of AC Conducted Emission

Test Mode :	Mode 1	Temperature :	22~24°C
Test Engineer :	Amos Zhang	Relative Humidity :	42~46%
Test Voltage :	120Vac / 60Hz	Phase :	Line
Function Type :	GSM850 Idle + Bluetooth Link + WLAN Link + USB Cable 1(Charging from Adapter)		

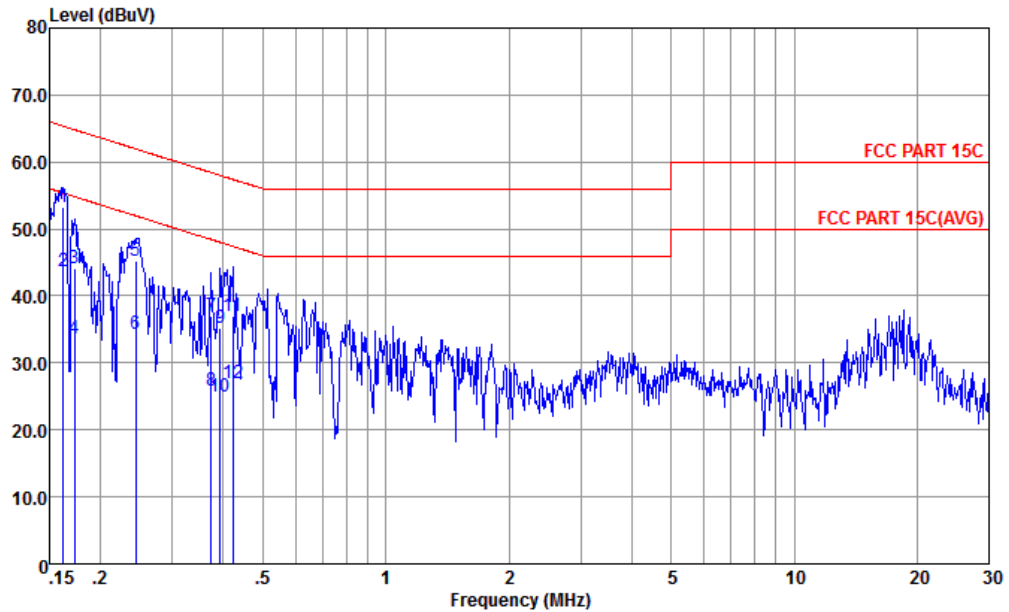

Site : CO01-KS
 Condition : FCC PART 15C LISN-L-161017-060103 LINE

:001080001912444/001080001912451 #11

Freq	Level	Over Limit	Limit	Read Line	LISN Level	Cable Factor	Cable Loss	Remark
MHz	dBuV		dB	dBuV	dBuV	dB	dB	
1	0.162	53.24	-12.10	65.34	42.20	0.47	10.57	QP
2 *	0.162	43.64	-11.70	55.34	32.60	0.47	10.57	Average
3	0.173	44.15	-20.66	64.81	33.20	0.41	10.54	QP
4	0.173	33.55	-21.26	54.81	22.60	0.41	10.54	Average
5	0.244	45.21	-16.74	61.95	34.50	0.27	10.44	QP
6	0.244	34.31	-17.64	51.95	23.60	0.27	10.44	Average
7	0.373	36.98	-21.45	58.43	26.30	0.27	10.41	QP
8	0.373	25.88	-22.55	48.43	15.20	0.27	10.41	Average
9	0.393	35.28	-22.71	57.99	24.60	0.27	10.41	QP
10	0.393	24.88	-23.11	47.99	14.20	0.27	10.41	Average
11	0.421	36.95	-20.47	57.42	26.30	0.27	10.38	QP
12	0.421	26.95	-20.47	47.42	16.30	0.27	10.38	Average



Test Mode :	Mode 1	Temperature :	22~24°C
Test Engineer :	Amos Zhang	Relative Humidity :	42~46%
Test Voltage :	120Vac / 60Hz	Phase :	Neutral
Function Type :	GSM850 Idle + Bluetooth Link + WLAN Link + USB Cable 1(Charging from Adapter)		

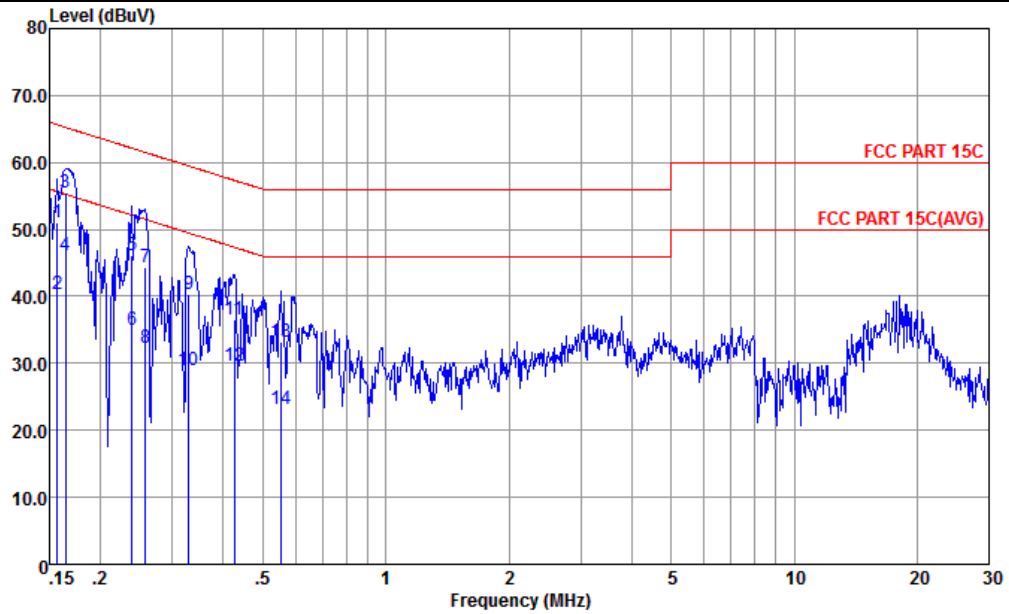

Site : CO01-KS
 Condition : FCC PART 15C LISN-N-161017-060103 NEUTRAL

:001080001912444/001080001912451 #11

	Freq	Level	Over Limit	Limit Line	Read Level	LISN Factor	Cable Loss	Remark
	MHz	dBuV	dB	dBuV	dBuV	dB	dB	
1	0.156	51.13	-14.52	65.65	40.20	0.34	10.59	QP
2	0.156	40.23	-15.42	55.65	29.30	0.34	10.59	Average
3	0.164	55.50	-9.75	65.25	44.59	0.34	10.57	QP
4 *	0.164	46.20	-9.05	55.25	35.29	0.34	10.57	Average
5	0.239	46.08	-16.05	62.13	35.30	0.34	10.44	QP
6	0.239	35.08	-17.05	52.13	24.30	0.34	10.44	Average
7	0.258	44.38	-17.13	61.51	33.60	0.34	10.44	QP
8	0.258	32.28	-19.23	51.51	21.50	0.34	10.44	Average
9	0.329	40.38	-19.11	59.49	29.60	0.36	10.42	QP
10	0.329	29.08	-20.41	49.49	18.30	0.36	10.42	Average
11	0.426	36.55	-20.78	57.33	25.80	0.37	10.38	QP
12	0.426	29.55	-17.78	47.33	18.80	0.37	10.38	Average
13	0.555	33.24	-22.76	56.00	22.60	0.38	10.26	QP
14	0.555	23.14	-22.86	46.00	12.50	0.38	10.26	Average



3.7 Antenna Requirements

3.7.1 Standard Applicable

If directional gain of transmitting antennas is greater than 6dBi, the power shall be reduced by the same level in dB comparing to gain minus 6dBi. For the fixed point-to-point operation, the power shall be reduced by one dB for every 3 dB that the directional gain of the antenna exceeds 6 dBi. The use of a permanently attached antenna or of an antenna that uses a unique coupling to the intentional radiator shall be considered sufficient to comply with the rule.

3.7.2 Antenna Anti-Replacement Construction

An embedded-in antenna design is used.

3.7.3 Antenna Gain

The antenna peak gain of EUT is less than 6 dBi. Therefore, it is not necessary to reduce maximum peak output power limit.



4 List of Measuring Equipment

Instrument	Manufacturer	Model No.	Serial No.	Characteristics	Calibration Date	Test Date	Due Date	Remark
Spectrum Analyzer	R&S	FSV40	101040	10Hz~40GHz	Aug. 08, 2017	Aug. 24, 2017~ Nov. 17, 2017	Aug. 07, 2018	Conducted (TH01-KS)
Pulse Power Sensor	Anritsu	MA2411B	0917070	300MHz~40GHz	Jan. 19, 2017	Aug. 24, 2017~ Nov. 17, 2017	Jan. 19, 2018	Conducted (TH01-KS)
Power Meter	Anritsu	ML2495A	1005002	50MHz Bandwidth	Jan. 19, 2017	Aug. 24, 2017~ Nov. 17, 2017	Jan. 19, 2018	Conducted (TH01-KS)
EMI Test Receiver	R&S	ESR7	101403	9kHz~7GHz; Max 30dBm	Aug. 08, 2017	Nov. 23, 2017	Aug. 07, 2018	Radiation (03CH02-KS)
EXA Spectrum Analyzer	Keysight	N9010A	MY55150208	10Hz~44GHz, MAX 30dB	Apr. 18, 2017	Nov. 23, 2017	Apr. 17, 2018	Radiation (03CH02-KS)
Loop Antenna	R&S	HFH2-Z2	100321	9kHz~30MHz	Nov. 22, 2017	Nov. 23, 2017	Nov.21, 2018	Radiation (03CH02-KS)
Bilog Antenna	TeseQ	CBL6112D	23182	30MHz~2GHz	Jan. 22, 2017	Nov. 23, 2017	Jan. 21, 2018	Radiation (03CH02-KS)
Double Ridge Horn Antenna	ETS-Lindgren	3117	75957	1GHz~18GHz	Oct. 21, 2017	Nov. 23, 2017	Oct. 20, 2018	Radiation (03CH02-KS)
SHF-EHF Horn	Schwarzbeck	BBHA 9170	BBHA170249	15GHz~40GHz	Feb. 15, 2017	Nov. 23, 2017	Feb. 14, 2018	Radiation (03CH02-KS)
Amplifier	SONOMA	310N	187289	9kHz~1GHz	Aug. 07, 2017	Nov. 23, 2017	Aug. 06, 2018	Radiation (03CH02-KS)
Amplifier	Agilent	8449B	3008A02384	1GHz~26.5GHz	Oct. 12, 2017	Nov. 23, 2017	Oct. 11, 2018	Radiation (03CH02-KS)
Amplifier	MITEQ	TTA1840-35-HG	1887435	18GHz~40GHz	Oct. 12, 2017	Nov. 23, 2017	Oct. 11, 2018	Radiation (03CH02-KS)
AC Power Source	Chroma	61601	616010002473	N/A	NCR	Nov. 23, 2017	NCR	Radiation (03CH02-KS)
Turn Table	MF	MF7802	N/A	0~360 degree	NCR	Nov. 23, 2017	NCR	Radiation (03CH02-KS)
Antenna Mast	MF	MF7802	N/A	1 m~4 m	NCR	Nov. 23, 2017	NCR	Radiation (03CH02-KS)
EMI Receiver	R&S	ESCI7	100768	9kHz~7GHz;	Apr. 20, 2017	Sep. 28, 2017	Apr. 19, 2018	Conduction (CO01-KS)
AC LISN	MessTec	AN3016	060103	9kHz~30MHz	Oct. 13, 2016	Sep. 28, 2017	Oct. 12, 2017	Conduction (CO01-KS)
AC LISN (for auxiliary equipment)	MessTec	AN3016	060105	9kHz~30MHz	Oct. 13, 2016	Sep. 28, 2017	Oct. 12, 2017	Conduction (CO01-KS)
AC Power Source	Chroma	61602	ABP00000811	AC 0V~300V, 45Hz~1000Hz	Oct. 13, 2016	Sep. 28, 2017	Oct. 12, 2017	Conduction (CO01-KS)



5 Uncertainty of Evaluation

Uncertainty of Conducted Emission Measurement (150kHz ~ 30MHz)

Measuring Uncertainty for a Level of Confidence of 95% ($U = 2Uc(y)$)	2.3dB
---	-------

Uncertainty of Radiated Emission Measurement (30 MHz ~ 1000 MHz)

Measuring Uncertainty for a Level of Confidence of 95% ($U = 2Uc(y)$)	5.2dB
---	-------

Uncertainty of Radiated Emission Measurement (1000 MHz ~ 18000 MHz)

Measuring Uncertainty for a Level of Confidence of 95% ($U = 2Uc(y)$)	4.7dB
---	-------

Uncertainty of Radiated Emission Measurement (18000 MHz ~ 40000 MHz)

Measuring Uncertainty for a Level of Confidence of 95% ($U = 2Uc(y)$)	5.3dB
---	-------



Appendix A. Conducted Test Results

A1 - DTS Part

Test Engineer:	Silent Hai	Temperature:	21~25	°C
Test Date:	2017/8/24 ~ 2017/11/17	Relative Humidity:	51~55	%

TEST RESULTS DATA
6dB and 99% Occupied Bandwidth

2.4GHz Band								
Mod.	Data Rate	N _{TX}	CH.	Freq. (MHz)	99% Occupied BW (MHz)	6dB BW (MHz)	6dB BW Limit (MHz)	Pass/Fail
11b	1Mbps	1	1	2412	13.34	8.53	0.50	Pass
11b	1Mbps	1	6	2437	13.34	8.53	0.50	Pass
11b	1Mbps	1	11	2462	13.44	8.55	0.50	Pass
11g	6Mbps	1	1	2412	18.53	16.32	0.50	Pass
11g	6Mbps	1	6	2437	18.58	16.34	0.50	Pass
11g	6Mbps	1	11	2462	18.83	16.30	0.50	Pass
HT20	MCS0	1	1	2412	19.18	17.32	0.50	Pass
HT20	MCS0	1	6	2437	19.33	17.56	0.50	Pass
HT20	MCS0	1	11	2462	19.33	17.54	0.50	Pass
HT40	MCS0	1	3	2422	36.46	35.13	0.50	Pass
HT40	MCS0	1	6	2437	36.46	35.13	0.50	Pass
HT40	MCS0	1	9	2452	36.56	35.13	0.50	Pass

TEST RESULTS DATA
Peak Power Table

2.4GHz Band										
Mod.	Data Rate	N _{TX}	CH.	Freq. (MHz)	Peak Conducted Power (dBm)	Conducted Power Limit (dBm)	DG (dBi)	EIRP Power (dBm)	EIRP Power Limit (dBm)	Pass /Fail
11b	1Mbps	1	1	2412	21.01	30.00	2.00	23.01	36.00	Pass
11b	1Mbps	1	6	2437	20.37	30.00	2.00	22.37	36.00	Pass
11b	1Mbps	1	11	2462	19.52	30.00	2.00	21.52	36.00	Pass
11g	6Mbps	1	1	2412	23.25	30.00	2.00	25.25	36.00	Pass
11g	6Mbps	1	6	2437	23.16	30.00	2.00	25.16	36.00	Pass
11g	6Mbps	1	11	2462	22.85	30.00	2.00	24.85	36.00	Pass
HT20	MCS0	1	1	2412	22.93	30.00	2.00	24.93	36.00	Pass
HT20	MCS0	1	6	2437	22.72	30.00	2.00	24.72	36.00	Pass
HT20	MCS0	1	11	2462	22.51	30.00	2.00	24.51	36.00	Pass
HT40	MCS0	1	3	2422	23.76	30.00	2.00	25.76	36.00	Pass
HT40	MCS0	1	6	2437	23.58	30.00	2.00	25.58	36.00	Pass
HT40	MCS0	1	9	2452	23.63	30.00	2.00	25.63	36.00	Pass

TEST RESULTS DATA
Average Power Table
(Reporting Only)

2.4GHz Band						
Mod.	Data Rate	N _{TX}	CH.	Freq. (MHz)	Duty Factor (dB)	Average Conducted Power (dBm)
11b	1Mbps	1	1	2412	0.11	18.53
11b	1Mbps	1	6	2437	0.11	17.66
11b	1Mbps	1	11	2462	0.11	16.98
11g	6Mbps	1	1	2412	0.58	15.59
11g	6Mbps	1	6	2437	0.58	15.20
11g	6Mbps	1	11	2462	0.58	14.87
HT20	MCS0	1	1	2412	0.62	14.83
HT20	MCS0	1	6	2437	0.62	14.25
HT20	MCS0	1	11	2462	0.62	13.93
HT40	MCS0	1	3	2422	0.67	15.68
HT40	MCS0	1	6	2437	0.67	15.29
HT40	MCS0	1	9	2452	0.67	15.55

TEST RESULTS DATA
Peak Power Density

2.4GHz Band								
Mod.	Data Rate	N _{TX}	CH.	Freq. (MHz)	Peak PSD (dBm /3kHz)	DG (dBi)	Peak PSD Limit (dBm /3kHz)	Pass/Fail
11b	1Mbps	1	1	2412	-4.07	2.00	8.00	Pass
11b	1Mbps	1	6	2437	-3.90	2.00	8.00	Pass
11b	1Mbps	1	11	2462	-5.32	2.00	8.00	Pass
11g	6Mbps	1	1	2412	-8.47	2.00	8.00	Pass
11g	6Mbps	1	6	2437	-11.22	2.00	8.00	Pass
11g	6Mbps	1	11	2462	-10.14	2.00	8.00	Pass
HT20	MCS0	1	1	2412	-11.12	2.00	8.00	Pass
HT20	MCS0	1	6	2437	-11.89	2.00	8.00	Pass
HT20	MCS0	1	11	2462	-12.15	2.00	8.00	Pass
HT40	MCS0	1	3	2422	-11.59	2.00	8.00	Pass
HT40	MCS0	1	6	2437	-13.18	2.00	8.00	Pass
HT40	MCS0	1	9	2452	-14.07	2.00	8.00	Pass



Appendix B. Radiated Spurious Emission

15C 2.4GHz 2400~2483.5MHz

WIFI 802.11b (Band Edge @ 3m)

WIFI	Note	Frequency	Level	Over	Limit	Read	Antenna	Cable	Preamp	Ant	Table	Peak	Pol.
Ant.				Limit	Line	Level	Factor	Loss	Factor	Pos	Pos	Avg.	
1		(MHz)	(dBμV/m)	(dB)	(dBμV/m)	(dBμV)	(dB/m)	(dB)	(dB)	(cm)	(deg)	(P/A)	(H/V)
802.11b CH 01 2412MHz		2389.95	53.37	-20.63	74	47.75	31.3	5.14	30.82	100	270	P	H
		2389.95	46.09	-7.91	54	40.47	31.3	5.14	30.82	100	270	A	H
	*	2412	108.86	-	-	103.19	31.33	5.16	30.82	100	270	P	H
	*	2414	105.59	-	-	99.92	31.33	5.16	30.82	100	270	A	H
		2387.48	51.19	-22.81	74	45.93	31.3	5.14	31.18	390	238	P	V
		2389.95	42.6	-11.4	54	36.98	31.3	5.14	30.82	390	238	A	V
	*	2414	106.09	-	-	100.42	31.33	5.16	30.82	390	238	P	V
	*	2414	102.64	-	-	96.97	31.33	5.16	30.82	390	238	A	V
802.11b CH 06 2437MHz		2389.3	50.61	-23.39	74	45.35	31.3	5.14	31.18	114	275	P	H
		2389.69	39.84	-14.16	54	34.58	31.3	5.14	31.18	114	275	A	H
	*	2436	108.4	-	-	102.61	31.36	5.19	30.76	114	275	P	H
	*	2436	105.19	-	-	99.4	31.36	5.19	30.76	114	275	A	H
		2491.36	50.6	-23.4	74	44.52	31.47	5.24	30.63	114	275	P	H
		2483.51	39.67	-14.33	54	33.62	31.44	5.24	30.63	114	275	A	H
		2382.8	50.45	-23.55	74	45.22	31.27	5.14	31.18	384	249	P	V
		2388.13	39.59	-14.41	54	34.33	31.3	5.14	31.18	384	249	A	V
	*	2436	106.33	-	-	100.54	31.36	5.19	30.76	384	249	P	V
	*	2436	102.67	-	-	96.88	31.36	5.19	30.76	384	249	A	V
		2494.84	50.34	-23.66	74	44.2	31.47	5.24	30.57	384	249	P	V
	2499.46	39.32	-14.68	54	33.18	31.47	5.24	30.57	384	249	A	V	



802.11b CH 11 2462MHz	*	2462	109.28	-	-	103.35	31.41	5.21	30.69	100	273	P	H
	*	2462	106	-	-	100.07	31.41	5.21	30.69	100	273	A	H
		2486.02	53.17	-20.83	74	47.12	31.44	5.24	30.63	100	273	P	H
		2483.56	44.84	-9.16	54	38.79	31.44	5.24	30.63	100	273	A	H
	*	2462	107.14	-	-	101.21	31.41	5.21	30.69	370	242	P	V
	*	2462	103.77	-	-	97.84	31.41	5.21	30.69	370	242	A	V
		2483.56	51.86	-22.14	74	45.81	31.44	5.24	30.63	370	242	P	V
		2483.51	42.71	-11.29	54	36.66	31.44	5.24	30.63	370	242	A	V
Remark	1. No other spurious found. 2. All results are PASS against Peak and Average limit line.												



**15C 2.4GHz 2400~2483.5MHz
WIFI 802.11b (Harmonic @ 3m)**

WIFI	Note	Frequency	Level	Over	Limit	Read	Antenna	Cable	Preamp	Ant	Table	Peak	Pol.
Ant.				Limit	Line	Level	Factor	Loss	Factor	Pos	Pos	Avg.	
1		(MHz)	(dBμV/m)	(dB)	(dBμV/m)	(dBμV)	(dB/m)	(dB)	(dB)	(cm)	(deg)	(P/A)	(H/V)
802.11b CH 01 2412MHz		4824	47.11	-26.89	74	68.27	35.65	7.72	64.53	100	360	P	H
		14472	59.1	-14.9	85.28	69.74	40.81	13.14	64.59	100	0	P	H
		4824	45.13	-28.87	74	66.29	35.65	7.72	64.53	100	360	P	V
		14472	58.21	-15.79	80.66	68.85	40.81	13.14	64.59	100	0	P	V
802.11b CH 06 2437MHz		4872	46.56	-27.44	74	67.8	35.61	7.75	64.6	100	360	P	H
		7308	40.41	-33.59	74	60.24	35.89	9.29	65.01	100	360	P	H
		14625	57.32	-16.68	82.06	67.44	40.95	13.26	64.33	100	0	P	H
		4872	45.2	-28.8	74	66.44	35.61	7.75	64.6	100	360	P	V
		7308	41.14	-32.86	74	60.97	35.89	9.29	65.01	100	360	P	V
		14625	58.78	-15.22	77.48	68.9	40.95	13.26	64.33	100	0	P	V
802.11b CH 11 2462MHz		4926	46.02	-27.98	74	67.33	35.57	7.8	64.68	100	360	P	H
		7386	40.18	-33.82	74	59.92	35.94	9.37	65.05	100	360	P	H
		14769	56.82	-17.18	85.08	66.43	41.09	13.36	64.06	100	0	P	H
		4926	42.54	-31.46	74	63.85	35.57	7.8	64.68	100	360	P	V
		7386	41.14	-32.86	74	60.88	35.94	9.37	65.05	100	360	P	V
		14769	59.25	-14.75	80.03	68.86	41.09	13.36	64.06	100	0	P	V
Remark	1. No other spurious found. 2. All results are PASS against Peak and Average limit line.												



**15C 2.4GHz 2400~2483.5MHz
WIFI 802.11g (Band Edge @ 3m)**

WIFI	Note	Frequency	Level	Over	Limit	Read	Antenna	Cable	Preamp	Ant	Table	Peak	Pol.
Ant.				Limit	Line	Level	Factor	Loss	Factor	Pos	Pos	Avg.	
1		(MHz)	(dBμV/m)	(dB)	(dBμV/m)	(dBμV)	(dB/m)	(dB)	(dB)	(cm)	(deg)	(P/A)	(H/V)
802.11g CH 01 2412MHz		2389.95	66.2	-7.8	74	60.58	31.3	5.14	30.82	100	289	P	H
	!	2389.95	52.1	-1.9	54	46.48	31.3	5.14	30.82	100	289	A	H
	*	2418	108.18	-	-	102.45	31.33	5.16	30.76	100	289	P	H
	*	2416	100.17	-	-	94.44	31.33	5.16	30.76	100	289	A	H
		2389.95	58.8	-15.2	74	53.18	31.3	5.14	30.82	102	56	P	V
		2389.95	45.05	-8.95	54	39.43	31.3	5.14	30.82	102	56	A	V
	*	2416	101.23	-	-	95.5	31.33	5.16	30.76	102	56	P	V
	*	2416	93.75	-	-	88.02	31.33	5.16	30.76	102	56	A	V
802.11g CH 06 2437MHz		2389.95	51.51	-22.49	74	45.89	31.3	5.14	30.82	100	103	P	H
		2389.3	40.36	-13.64	54	35.1	31.3	5.14	31.18	100	103	A	H
	*	2432	107.26	-	-	101.47	31.36	5.19	30.76	100	103	P	H
	*	2430	99.65	-	-	93.86	31.36	5.19	30.76	100	103	A	H
		2483.56	50.54	-23.46	74	44.49	31.44	5.24	30.63	100	103	P	H
		2488.54	39.84	-14.16	54	33.76	31.47	5.24	30.63	100	103	A	H
		2380.46	50.87	-23.13	74	45.64	31.27	5.14	31.18	380	87	P	V
		2382.02	40.3	-13.7	54	35.07	31.27	5.14	31.18	380	87	A	V
	*	2430	104.38	-	-	98.59	31.36	5.19	30.76	380	87	P	V
	*	2430	96.71	-	-	90.92	31.36	5.19	30.76	380	87	A	V
		2496.1	49.7	-24.3	74	43.56	31.47	5.24	30.57	380	87	P	V
		2498.8	40.11	-13.89	54	33.97	31.47	5.24	30.57	380	87	A	V



802.11g CH 11 2462MHz	*	2462	107.11	-	-	101.18	31.41	5.21	30.69	100	104	P	H
	*	2464	98.56	-	-	92.63	31.41	5.21	30.69	100	104	A	H
	!	2483.56	72.07	-1.93	74	66.02	31.44	5.24	30.63	100	104	P	H
	!	2483.51	53.72	-0.28	54	47.67	31.44	5.24	30.63	100	104	A	H
	*	2458	103.54	-	-	97.61	31.41	5.21	30.69	371	66	P	V
	*	2458	95.24	-	-	89.31	31.41	5.21	30.69	371	66	A	V
		2483.92	66.65	-7.35	74	60.6	31.44	5.24	30.63	371	66	P	V
	!	2483.51	49.92	-4.08	54	43.87	31.44	5.24	30.63	371	66	A	V
Remark	1. No other spurious found. 2. All results are PASS against Peak and Average limit line.												



15C 2.4GHz 2400~2483.5MHz

WIFI 802.11g (Harmonic @ 3m)

WIFI	Note	Frequency	Level	Over	Limit	Read	Antenna	Cable	Preamp	Ant	Table	Peak	Pol.
Ant.				Limit	Line	Level	Factor	Loss	Factor	Pos	Pos	Avg.	
1		(MHz)	(dBμV/m)	(dB)	(dBμV/m)	(dBμV)	(dB/m)	(dB)	(dB)	(cm)	(deg)	(P/A)	(H/V)
802.11g		4824	42.07	-31.93	74	63.23	35.65	7.72	64.53	100	360	P	H
CH 01		4824	41.75	-32.25	74	62.91	35.65	7.72	64.53	100	360	P	V
2412MHz													
802.11g		4872	41.95	-32.05	74	63.19	35.61	7.75	64.6	100	360	P	H
CH 06		7308	40.47	-33.53	74	60.3	35.89	9.29	65.01	100	360	P	H
2437MHz		4872	40.95	-33.05	74	62.19	35.61	7.75	64.6	100	360	P	V
		7308	40.83	-33.17	74	60.66	35.89	9.29	65.01	100	360	P	V
802.11g		4926	41.56	-32.44	74	62.87	35.57	7.8	64.68	100	360	P	H
CH 11		7386	41.2	-32.8	74	60.94	35.94	9.37	65.05	100	360	P	H
2462MHz		4926	41.14	-32.86	74	62.45	35.57	7.8	64.68	100	360	P	V
		7386	40.89	-33.11	74	60.63	35.94	9.37	65.05	100	360	P	V
Remark	<ol style="list-style-type: none"> No other spurious found. All results are PASS against Peak and Average limit line. 												



**15C 2.4GHz 2400~2483.5MHz
WIFI 802.11n HT20 (Band Edge @ 3m)**

WIFI	Note	Frequency	Level	Over	Limit	Read	Antenna	Cable	Preamp	Ant	Table	Peak	Pol.
Ant.				Limit	Line	Level	Factor	Loss	Factor	Pos	Pos	Avg.	
1		(MHz)	(dBμV/m)	(dB)	(dBμV/m)	(dBμV)	(dB/m)	(dB)	(dB)	(cm)	(deg)	(P/A)	(H/V)
802.11n HT20 CH 01 2412MHz		2389.82	65.99	-8.01	74	60.37	31.3	5.14	30.82	100	101	P	H
	!	2389.82	50.49	-3.51	54	44.87	31.3	5.14	30.82	100	101	A	H
	*	2420	106.58	-	-	100.82	31.36	5.16	30.76	100	101	P	H
	*	2420	98.87	-	-	93.11	31.36	5.16	30.76	100	101	A	H
		2389.3	55.88	-18.12	74	50.62	31.3	5.14	31.18	380	60	P	V
		2389.95	43.16	-10.84	54	37.54	31.3	5.14	30.82	380	60	A	V
	*	2418	103.71	-	-	97.98	31.33	5.16	30.76	380	60	P	V
	*	2420	95.7	-	-	89.94	31.36	5.16	30.76	380	60	A	V
802.11n HT20 CH 06 2437MHz		2388	50.98	-23.02	74	45.72	31.3	5.14	31.18	100	100	P	H
		2389.82	39.92	-14.08	54	34.3	31.3	5.14	30.82	100	100	A	H
	*	2430	106.23	-	-	100.44	31.36	5.19	30.76	100	100	P	H
	*	2430	97.55	-	-	91.76	31.36	5.19	30.76	100	100	A	H
		2496.1	50.51	-23.49	74	44.37	31.47	5.24	30.57	100	100	P	H
		2488.54	39.64	-14.36	54	33.56	31.47	5.24	30.63	100	100	A	H
		2363.69	50.14	-23.86	74	45.31	31.25	5.12	31.54	326	7	P	V
		2376.95	39.76	-14.24	54	34.55	31.27	5.12	31.18	326	7	A	V
	*	2430	102.63	-	-	96.84	31.36	5.19	30.76	326	7	P	V
	*	2430	95.04	-	-	89.25	31.36	5.19	30.76	326	7	A	V
		2497.6	50.26	-23.74	74	44.12	31.47	5.24	30.57	326	7	P	V
	2495.92	39.54	-14.46	54	33.4	31.47	5.24	30.57	326	7	A	V	



802.11n HT20 CH 11 2462MHz	*	2460	105.4	-	-	99.47	31.41	5.21	30.69	100	100	P	H
	*	2464	97.48	-	-	91.55	31.41	5.21	30.69	100	100	A	H
	!	2483.5	71.27	-2.73	74	65.22	31.44	5.24	30.63	100	100	P	H
	!	2483.5	52.01	-1.99	54	45.96	31.44	5.24	30.63	100	100	A	H
	*	2466	101.77	-	-	95.84	31.41	5.21	30.69	323	72	P	V
	*	2466	93.4	-	-	87.47	31.41	5.21	30.69	323	72	A	V
		2483.98	67.18	-6.82	74	61.13	31.44	5.24	30.63	323	72	P	V
	!	2483.5	51.07	-2.93	54	45.02	31.44	5.24	30.63	323	72	A	V
Remark	1. No other spurious found. 2. All results are PASS against Peak and Average limit line.												



15C 2.4GHz 2400~2483.5MHz
WIFI 802.11n HT20 (Harmonic @ 3m)

WIFI	Note	Frequency	Level	Over	Limit	Read	Antenna	Cable	Preamp	Ant	Table	Peak	Pol.
Ant.				Limit	Line	Level	Factor	Loss	Factor	Pos	Pos	Avg.	
1		(MHz)	(dBμV/m)	(dB)	(dBμV/m)	(dBμV)	(dB/m)	(dB)	(dB)	(cm)	(deg)	(P/A)	(H/V)
802.11n HT20 CH 01 2412MHz		4824	41.22	-32.78	74	62.38	35.65	7.72	64.53	100	360	P	H
		4824	41.59	-32.41	74	62.75	35.65	7.72	64.53	100	360	P	V
802.11n HT20 CH 06 2437MHz		4872	41.39	-32.61	74	62.63	35.61	7.75	64.6	100	360	P	H
		7308	41.55	-32.45	74	61.38	35.89	9.29	65.01	100	360	P	H
		4872	42.45	-31.55	74	63.69	35.61	7.75	64.6	100	360	P	V
		7308	40.9	-33.1	74	60.73	35.89	9.29	65.01	100	360	P	V
802.11n HT20 CH 11 2462MHz		4926	41.91	-32.09	74	63.22	35.57	7.8	64.68	100	360	P	H
		7386	41.52	-32.48	74	61.26	35.94	9.37	65.05	100	360	P	H
		4926	41.31	-32.69	74	62.62	35.57	7.8	64.68	100	360	P	V
		7386	41.62	-32.38	74	61.36	35.94	9.37	65.05	100	360	P	V
Remark	1. No other spurious found. 2. All results are PASS against Peak and Average limit line.												



**15C 2.4GHz 2400~2483.5MHz
WIFI 802.11n HT40 (Band Edge @ 3m)**

WIFI	Note	Frequency	Level	Over	Limit	Read	Antenna	Cable	Preamp	Ant	Table	Peak	Pol.
Ant.				Limit	Line	Level	Factor	Loss	Factor	Pos	Pos	Avg.	
1		(MHz)	(dBμV/m)	(dB)	(dBμV/m)	(dBμV)	(dB/m)	(dB)	(dB)	(cm)	(deg)	(P/A)	(H/V)
802.11n HT40 CH 03 2422MHz	!	2389.69	69.56	-4.44	74	64.3	31.3	5.14	31.18	100	101	P	H
	!	2389.95	51.87	-2.13	54	46.25	31.3	5.14	30.82	100	101	A	H
	*	2430	104.23	-	-	98.44	31.36	5.19	30.76	100	101	P	H
	*	2430	96.06	-	-	90.27	31.36	5.19	30.76	100	101	A	H
		2483.86	55.53	-18.47	74	49.48	31.44	5.24	30.63	100	101	P	H
		2483.51	43.92	-10.08	54	37.87	31.44	5.24	30.63	100	101	A	H
		2389.95	59.97	-14.03	74	54.35	31.3	5.14	30.82	100	67	P	V
		2389.95	45.54	-8.46	54	39.92	31.3	5.14	30.82	100	67	A	V
	*	2430	99.57	-	-	93.78	31.36	5.19	30.76	100	67	P	V
	*	2430	91.85	-	-	86.06	31.36	5.19	30.76	100	67	A	V
		2489.26	50.75	-23.25	74	44.67	31.47	5.24	30.63	100	67	P	V
		2483.62	40.67	-13.33	54	34.62	31.44	5.24	30.63	100	67	A	V
802.11n HT40 CH 06 2437MHz		2389.43	58.17	-15.83	74	52.91	31.3	5.14	31.18	100	105	P	H
		2389.95	44.75	-9.25	54	39.13	31.3	5.14	30.82	100	105	A	H
	*	2430	103.94	-	-	98.15	31.36	5.19	30.76	100	105	P	H
	*	2430	95.3	-	-	89.51	31.36	5.19	30.76	100	105	A	H
		2483.98	63.52	-10.48	74	57.47	31.44	5.24	30.63	100	105	P	H
	!	2483.86	48.07	-5.93	54	42.02	31.44	5.24	30.63	100	105	A	H
		2348.22	50.97	-23.03	74	46.2	31.22	5.09	31.54	100	81	P	V
		2389.95	40.36	-13.64	54	34.74	31.3	5.14	30.82	100	81	A	V
	*	2430	98.44	-	-	92.65	31.36	5.19	30.76	100	81	P	V
	*	2430	89.45	-	-	83.66	31.36	5.19	30.76	100	81	A	V
		2483.51	54.14	-19.86	74	48.09	31.44	5.24	30.63	100	81	P	V
		2483.62	42.37	-11.63	54	36.32	31.44	5.24	30.63	100	81	A	V



802.11n HT40 CH 09 2452MHz		2389.95	52.61	-21.39	74	46.99	31.3	5.14	30.82	100	102	P	H
		2389.82	42.1	-11.9	54	36.48	31.3	5.14	30.82	100	102	A	H
	*	2460	103.94	-	-	98.01	31.41	5.21	30.69	100	102	P	H
	*	2462	95.3	-	-	89.37	31.41	5.21	30.69	100	102	A	H
	!	2485.72	71.07	-2.93	74	65.02	31.44	5.24	30.63	100	102	P	H
	!	2483.51	53.65	-0.35	54	47.6	31.44	5.24	30.63	100	102	A	H
		2371.62	50.41	-23.59	74	45.2	31.27	5.12	31.18	100	23	P	V
		2389.56	40.35	-13.65	54	35.09	31.3	5.14	31.18	100	23	A	V
	*	2462	98.1	-	-	92.17	31.41	5.21	30.69	100	23	P	V
	*	2462	90.75	-	-	84.82	31.41	5.21	30.69	100	23	A	V
		2483.5	65.52	-8.48	74	59.47	31.44	5.24	30.63	100	23	P	V
	!	2483.86	49.31	-4.69	54	43.26	31.44	5.24	30.63	100	23	A	V
Remark	1. No other spurious found. 2. All results are PASS against Peak and Average limit line.												



15C 2.4GHz 2400~2483.5MHz
WIFI 802.11n HT40 (Harmonic @ 3m)

WIFI	Note	Frequency	Level	Over	Limit	Read	Antenna	Cable	Preamp	Ant	Table	Peak	Pol.
Ant.				Limit	Line	Level	Factor	Loss	Factor	Pos	Pos	Avg.	
1		(MHz)	(dBμV/m)	(dB)	(dBμV/m)	(dBμV)	(dB/m)	(dB)	(dB)	(cm)	(deg)	(P/A)	(H/V)
802.11n		4842	41.67	-32.33	74	62.86	35.63	7.73	64.55	100	360	P	H
HT40		7266	40.56	-33.44	74	60.44	35.87	9.24	64.99	100	360	P	H
CH 03		4842	43.26	-30.74	74	64.45	35.63	7.73	64.55	100	360	P	V
2422MHz		7266	41.02	-32.98	74	60.9	35.87	9.24	64.99	100	360	P	V
802.11n		4872	41.45	-32.55	74	62.69	35.61	7.75	64.6	100	360	P	H
HT40		7308	41.18	-32.82	74	61.01	35.89	9.29	65.01	100	360	P	H
CH 06		4872	41.08	-32.92	74	62.32	35.61	7.75	64.6	100	360	P	V
2437MHz		7308	41.74	-32.26	74	61.57	35.89	9.29	65.01	100	360	P	V
802.11n		4902	40.44	-33.56	74	61.72	35.58	7.79	64.65	100	360	P	H
HT40		7356	40.86	-33.14	74	60.63	35.92	9.34	65.03	100	360	P	H
CH 09		4902	39.65	-34.35	74	60.93	35.58	7.79	64.65	100	360	P	V
2452MHz		7356	41.13	-32.87	74	60.9	35.92	9.34	65.03	100	360	P	V
Remark	1. No other spurious found. 2. All results are PASS against Peak and Average limit line.												



15C Emission below 1GHz

2.4GHz WIFI 802.11g (LF)

WIFI	Note	Frequency	Level	Over	Limit	Read	Antenna	Cable	Preamp	Ant	Table	Peak	Pol.
Ant.				Limit	Line	Level	Factor	Loss	Factor	Pos	Pos	Avg.	
1		(MHz)	(dBμV/m)	(dB)	(dBμV/m)	(dBμV)	(dB/m)	(dB)	(dB)	(cm)	(deg)	(P/A)	(H/V)
2.4GHz 802.11g LF		30.97	22.3	-17.7	40	28.14	25.6	0.59	32.03	100	0	P	H
		175.5	17.79	-25.71	43.5	31.56	16.62	1.36	31.75	-	-	P	H
		211.39	23.35	-20.15	43.5	37.43	16.05	1.51	31.64	-	-	P	H
		407.33	24.99	-21.01	46	28.06	25.52	2.09	30.68	-	-	P	H
		554.77	24.89	-21.11	46	27.77	24.51	2.56	29.95	-	-	P	H
		839.95	27.61	-18.39	46	25.66	26.98	2.97	28	-	-	P	H
		35.82	26.84	-13.16	40	33.74	24.5	0.64	32.04	-	-	P	V
		43.58	31.47	-8.53	40	42.34	20.57	0.66	32.1	100	0	P	V
		55.22	28.54	-11.46	40	45.78	14.1	0.77	32.11	-	-	P	V
		206.54	19.47	-24.03	43.5	33.66	15.97	1.49	31.65	-	-	P	V
		399.57	25.14	-20.86	46	28.07	25.7	2.08	30.71	-	-	P	V
	878.75	27.25	-18.75	46	24.52	27.33	3.08	27.68	-	-	P	V	
Remark	1. No other spurious found. 2. All results are PASS against limit line.												



Note symbol

*	Fundamental Frequency which can be ignored. However, the level of any unwanted emissions shall not exceed the level of the fundamental frequency per 15.209(c).
!	Test result is not under limit 6dB
P/A	Peak or Average
H/V	Horizontal or Vertical



A calculation example for radiated spurious emission is shown as below:

WIFI	Note	Frequency	Level	Over	Limit	Read	Antenna	Cable	Preamp	Ant	Table	Peak	Pol.
Ant.				Limit	Line	Level	Factor	Loss	Factor	Pos	Pos	Avg.	
1+2		(MHz)	(dBμV/m)	(dB)	(dBμV/m)	(dBμV)	(dB/m)	(dB)	(dB)	(cm)	(deg)	(P/A)	(H/V)
802.11b		2390	55.45	-18.55	74	54.51	32.22	4.58	35.86	103	308	P	H
CH 01													
2412MHz		2390	43.54	-10.46	54	42.6	32.22	4.58	35.86	103	308	A	H

- Level(dBμV/m) =
Antenna Factor(dB/m) + Cable Loss(dB) + Read Level(dBμV) - Preamp Factor(dB)
- Over Limit(dB) = Level(dBμV/m) – Limit Line(dBμV/m)

For Peak Limit @ 2390MHz:

- Level(dBμV/m)
= Antenna Factor(dB/m) + Cable Loss(dB) + Read Level(dBμV) - Preamp Factor(dB)
= 32.22(dB/m) + 4.58(dB) + 54.51(dBμV) – 35.86 (dB)
= 55.45 (dBμV/m)
- Over Limit(dB)
= Level(dBμV/m) – Limit Line(dBμV/m)
= 55.45(dBμV/m) – 74(dBμV/m)
= -18.55(dB)

For Average Limit @ 2390MHz:

- Level(dBμV/m)
= Antenna Factor(dB/m) + Cable Loss(dB) + Read Level(dBμV) - Preamp Factor(dB)
= 32.22(dB/m) + 4.58(dB) + 42.6(dBμV) – 35.86 (dB)
= 43.54 (dBμV/m)
- Over Limit(dB)
= Level(dBμV/m) – Limit Line(dBμV/m)
= 43.54(dBμV/m) – 54(dBμV/m)
= -10.46(dB)

Both peak and average measured complies with the limit line, so test result is “PASS”.



Appendix C. Duty Cycle Plots

Band	Duty Cycle(%)	T(ms)	1/T(kHz)	VBW Setting
802.11b	97.59	8.232	0.121	300Hz
802.11g	87.50	1.370	0.730	1kHz
802.11n HT20	86.70	1.275	0.784	1kHz
802.11n HT40	85.79	1.225	0.816	1kHz



802.11b

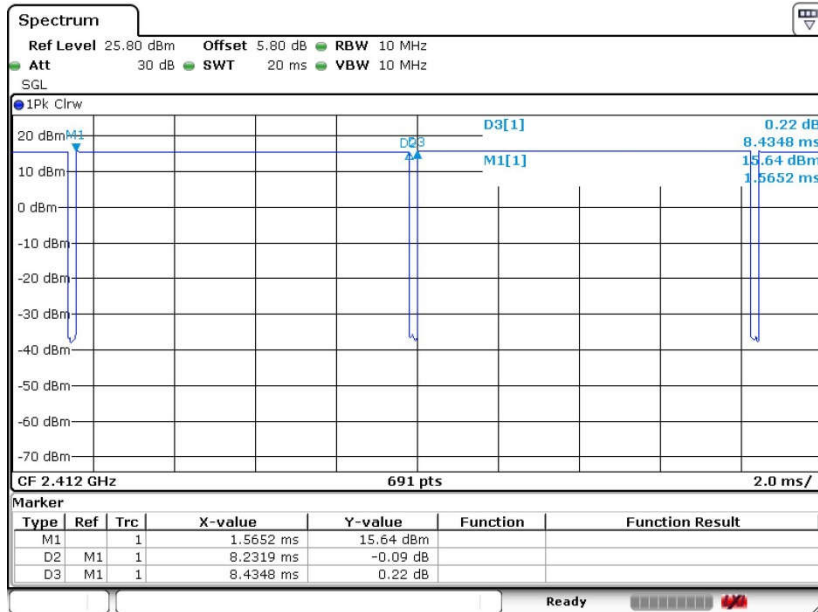



802.11g

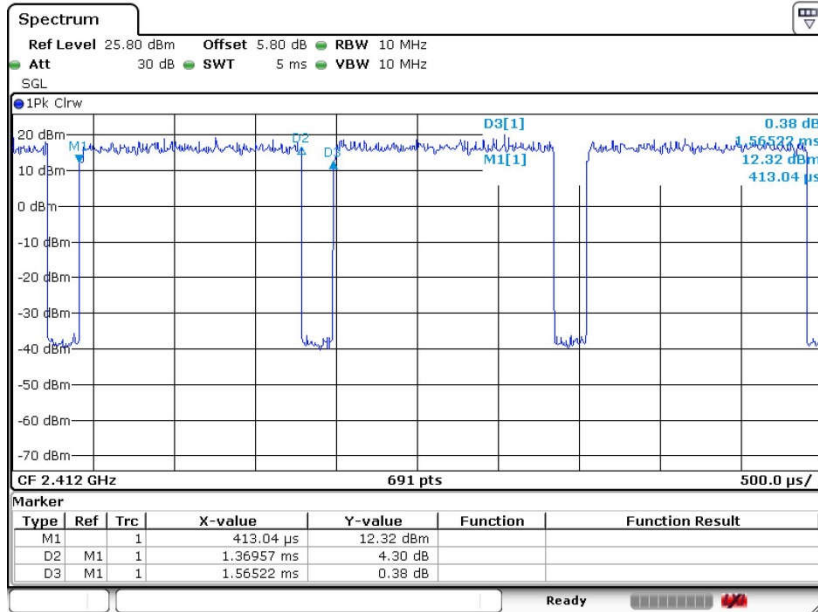



802.11n HT20

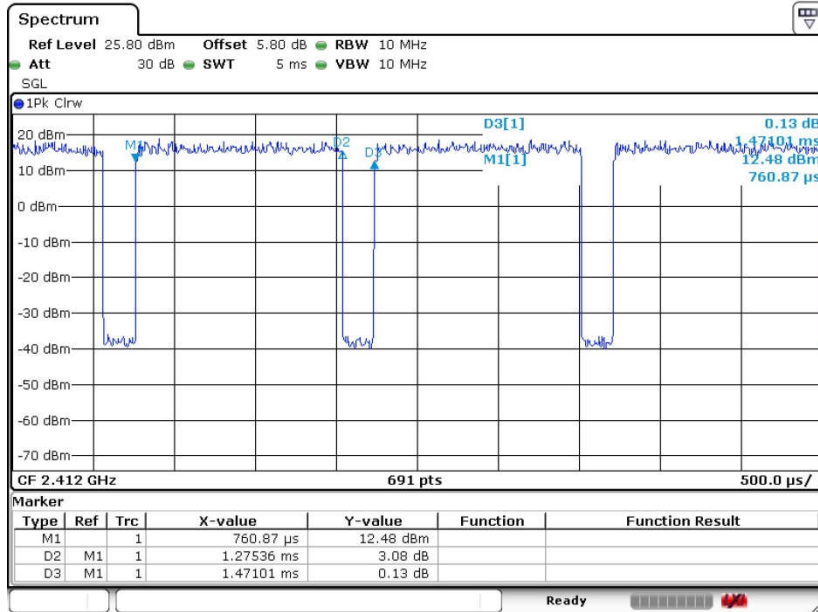



802.11n HT40

