



TEST REPORT

Report No.: SRTC2011-H024-E0063

Product Name: GSM/GPRS/EGPRS Mobile Phone

Marketing Name: Sonim XP3300 Z1

Product Model: Sonim XP3300-A-X1 / Sonim XP3300-A-Y1

Type Number: P25C005AJ

Applicant: Sonim Technologies Inc.

Manufacturer: Sonim Technologies Inc.

Specification: FCC Part15B (Certification)

(October 1, 2009 edition)

FCC ID: WYPP25C005AJ

The State Radio_monitoring_center Testing Center (SRTC)

No.80 Beilishi Road Xicheng District Beijing, China

Tel: 86-10-68009202 Fax: 86-10-68009205

CONTENTS

1. General information	3
1.1 Notes of the test report	3
1.2 Information about the testing laboratory.....	3
1.3 Applicant's details	3
1.4 Manufacturer's details.....	3
1.5 Application details	4
1.6 Reference specification.....	4
1.7 Information of EUT	4
1.7.1 General information.....	4
1.7.2 EUT details	5
1.7.3 Auxiliary equipment details.....	5
2. Test information	6
2.1 Summary of the test results.....	6
2.2 Test result.....	7
2.2.1 Conducted Emissions-FCC Part15.107	7
2.2.2 Radiated Emissions-FCC Part15.109	14
2.3. List of test equipments	20
Appendix	21

1. General information

1.1 Notes of the test report

The test report may only be reproduced or published in full. Reproduction or publication of extracts from the report requires the prior written permission of The State Radio_monitoring_center Testing Center (SRTC).

The test results relate only to individual items of the samples which have been tested.

1.2 Information about the testing laboratory

Company: The State Radio_monitoring_center Testing Center (SRTC)
Address: No.80 Beilishi Road, Xicheng District, Beijing China
City: Beijing
Country or Region: China
Contacted person: Wang Junfeng
Tel: +86 10 68009181 +86 10 68009202
Fax: +86 10 68009195 +86 10 68009205
Email: wangjf@srrc.org.cn / wangjunfeng@srtc.org.cn

1.3 Applicant's details

Company: Sonim Technologies Inc.
Address: 1875 S. Grant Street, Suite 620, San Mateo, CA 94402, USA
City: San Mateo
Country or Region: USA
Grantee Code: WYP
Contacted Person: Jasen Kolev
Tel: +1 650 504 4411
Fax: +1 650 378 8190
Email: jasen@sonimtech.com

1.4 Manufacturer's details

Company: Sonim Technologies Inc.
Address: 1875 S. Grant Street, Suite 620, San Mateo, CA 94402, USA
City: San Mateo
Country or Region: USA
Contacted Person: Jasen Kolev
Tel: +1 650 504 4411
Fax: +1 650 378 8190
Email: jasen@sonimtech.com

1.5 Application details

Date of reception of test sample: 1st Jun 2011

Date of test: 1st Jun 2011 to 12th Jun 2011

1.6 Reference specification

FCC Part 15B October 1, 2009 (Certification)

1.7 Information of EUT

1.7.1 General information

Name of EUT	GSM/GPRS/EGPRS Mobile Phone
FCC ID	WYPP25C005AJ
Frequency range	GSM850: Tx:824~849MHz Rx:869~894MHz PCS1900: Tx:1850~1910MHz Rx:1930~1990MHz
Rated output power	GSM850:33.0dBm PCS1900:30.0dBm
E.R.P. & E.I.R.P.	E.R.P.:31.22dBm E.I.R.P.:27.23dBm
Modulation type	GSM/GPRS:GMSK EDGE:8PSK
Emission Designator	GSM/GPRS:300KGXW EDGE:300KG7W
Duplex mode	FDD
Equipment Class	Class B
Duplex spacing	GSM850:45MHz PCS1900:80MHz
Antenna type	Fixed Internal
Power Supply	Battery or charger
Rated Power Supply Voltage	3.7V
Extreme Temperature	Lowest: -30°C Highest: +50°C
Extreme Voltage	Minimum: 3.4V Maximum: 4.2V
HW Version	A
SW Version	500030SW03A00_Ex-Handy_07_2

1.7.2 EUT details

Product Name	Marketing Name	Product Model	Type Number	IMEI
GSM/GPRS/EGPRS Mobile Phone	Sonim XP3300 Z1	Sonim XP3300-A-X1	P25C005AJ	001800000192112

1.7.3 Auxiliary equipment details

AE (Auxiliary Equipment) 1#: Charger

Equipment	Charger
Manufacturer	DEE VAN ENTERPRISE CO., LTD
Model Number	DSA-3PFC-05 FUS 050065

AE (Auxiliary Equipment) 2#: Battery

Equipment	Battery
Manufacturer	ecom instruments GmbH
Model Number	Ex-BPH 07 HC
Capacity	2000mAh
Rated Voltage	3.7V d.c.

AE (Auxiliary Equipment) 3#: Battery

Equipment	Battery
Manufacturer	ecom instruments GmbH
Model Number	Ex-BPH 07 SC
Capacity	1280mAh
Rated Voltage	3.7V d.c.

Note 1: The Sonim XP3300-A-X1 and Sonim XP3300-A-Y1 are all the GSM/GPRS/EDGE Digital Mobile Phones with bluetooth operating in the 850MHz and 1900MHz frequency bands. These two devices are all the same at nearly every functional aspect. The only difference between these two models of mobile phones is that Sonim XP3300-A-X1 can supports camera, and Sonim XP3300-A-Y1 can not. Therefore, the test values of Sonim XP3300-A-X1 provide a worst result which we could get in these two devices. And also the results could represent all the features which Sonim XP3300-A-Y1 has. So this report is just to provide the test values of The Sonim XP3300-A-X1.

Note 2: As the information described in section 1.7.3, there are two different models of battery manufactured by the same company. The only difference between these two models of battery is the capacity. The relevant tests have been performed in order to verify that the EUT has the same features when exercised by each model. So all the tests except conducted emissions (please refer to the section 2.2.1 for details) shown in this test report are performed when the EUT exercised by only one model of these two batteries. The model which is chosen for testing is Ex-BPH 07 HC.

2. Test information

2.1 Summary of the test results

No.	Test case	FCC reference	Verdict
1	Conducted emissions	15.107	Pass
2	Radiated emissions	15.109	Pass

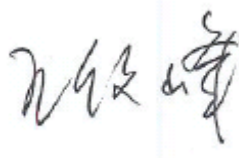
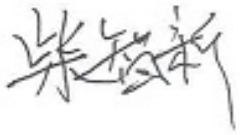
This Test Report Is Issued by: Mr. Song Qizhu Director of the test lab 	Checked by: Mr. Wang Junfeng Deputy director of the test lab 
Tested by: Mr. Chai Zhixin Test engineer 	Issued date: <p style="text-align: center;">2011.08.22</p>

2.2 Test result

2.2.1 Conducted Emissions-FCC Part15.107

Ambient condition:

Temperature	Relative humidity	Pressure
20°C	48.6%	99.7kPa

Test Setup:

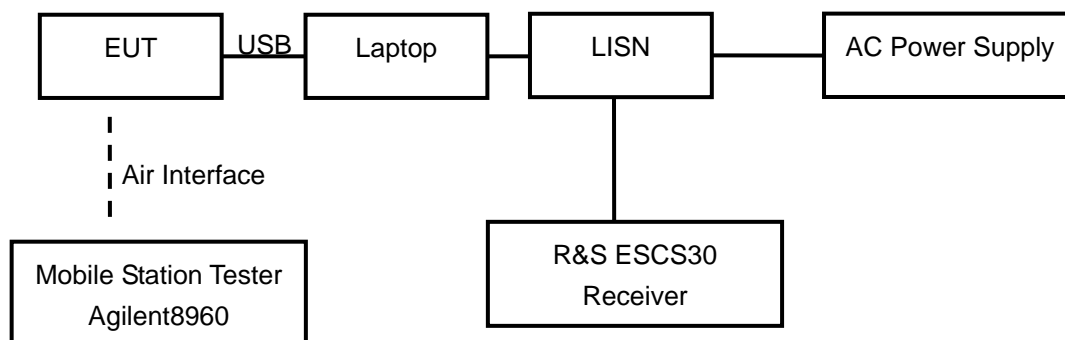

Figure 1

Test Procedure:

The EUT is placed on a non-metallic table 0.4m above the horizontal metal reference ground plane. The EUT connect with a laptop via the USB cable. The accessories of the EUT are connected with the EUT such as headset etc. During the test the data transferring via USB cable between EUT and laptop is maintained.

The AC main power supply of the laptop is connected to LISN and LISN is connected to the reference ground. The test set-up and the test methods are performed according to ANSI C63.4:2009.

Then start the test software ES-K1. Sweep the whole frequency band through the range from 150 KHz to 30 MHz. The measurement should be done for both L line and N line. During pre-test, the receiver uses both peak detector and average detector. And the final test, the receiver uses both average detector and Quasi-peak detector.

The data of cable loss has been calibrated in full testing frequency range before the testing.

Limit:

Frequency of Emission(MHz)	Limits(dBμV)	
	Quasi-peak	Average
0.15~0.5	66 to 56*	56 to 46*
0.5~5	56	46
5~30	60	50

Note: * Decreases with the logarithm of the frequency

Test result:

Refer to the following figures:

Noise Level of The Measuring Instrument

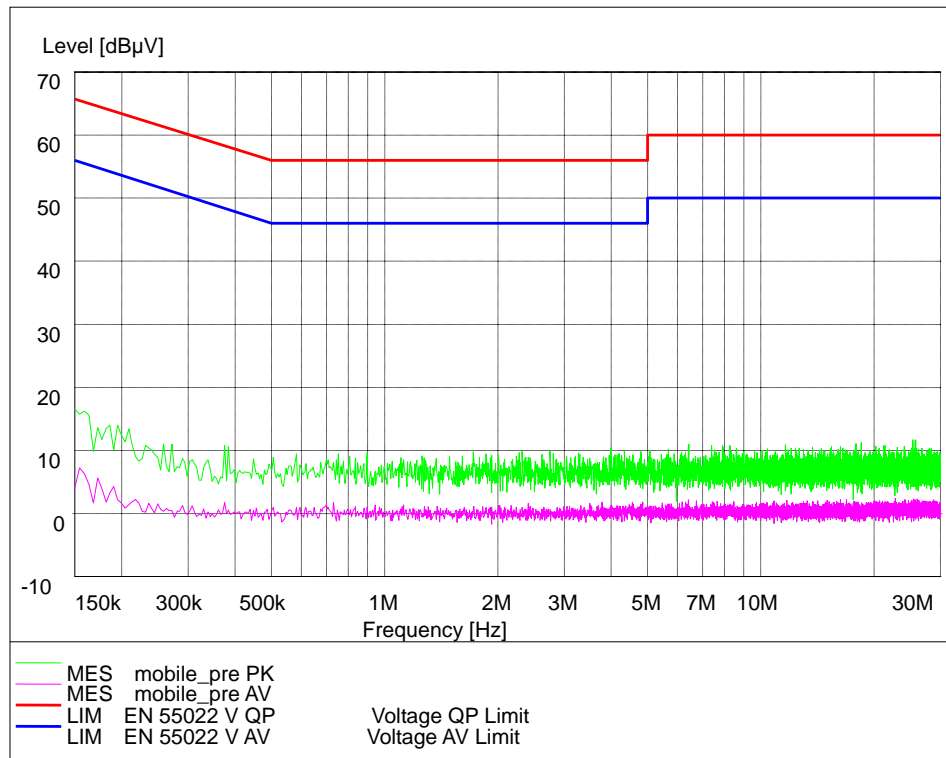

L and N Line

GSM 850 Laptop+AE2#

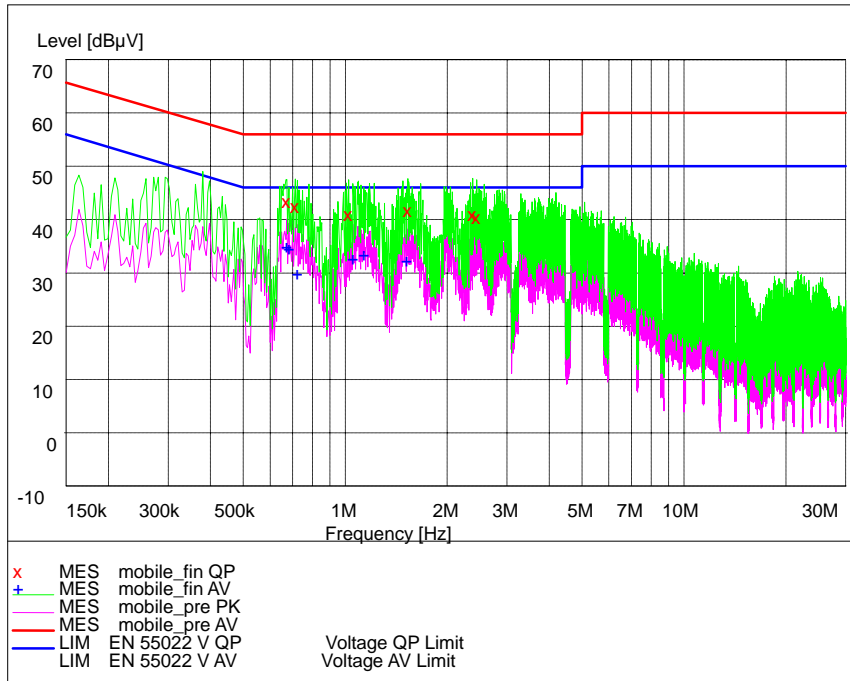

L and N Line

MEASUREMENT RESULT: "mobile_fin QP"

Frequency	Level	Transd	Limit	Margin	Line	PE
MHz	dBμV		dB	dBμV	dB	
0.672000	45.60	20.4	56	10.4	---	---
0.712500	44.80	20.3	56	11.2	---	---
1.023000	43.20	20.2	56	12.8	---	---
1.531500	43.90	20.2	56	12.1	---	---
2.377500	43.10	20.3	56	12.9	---	---
2.445000	42.50	20.3	56	13.5	---	---

MEASUREMENT RESULT: "mobile_fin AV"

Frequency	Level	Transd	Limit	Margin	Line	PE
MHz	dBμV		dB	dBμV	dB	
0.672000	37.30	20.4	46	8.7	---	---
0.681000	36.80	20.3	46	9.2	---	---
0.721500	32.10	20.3	46	13.9	---	---
1.054500	34.90	20.2	46	11.1	---	---
1.135500	35.60	20.2	46	10.4	---	---
1.518000	34.50	20.2	46	11.5	---	---

GSM 850 Laptop+AE3#

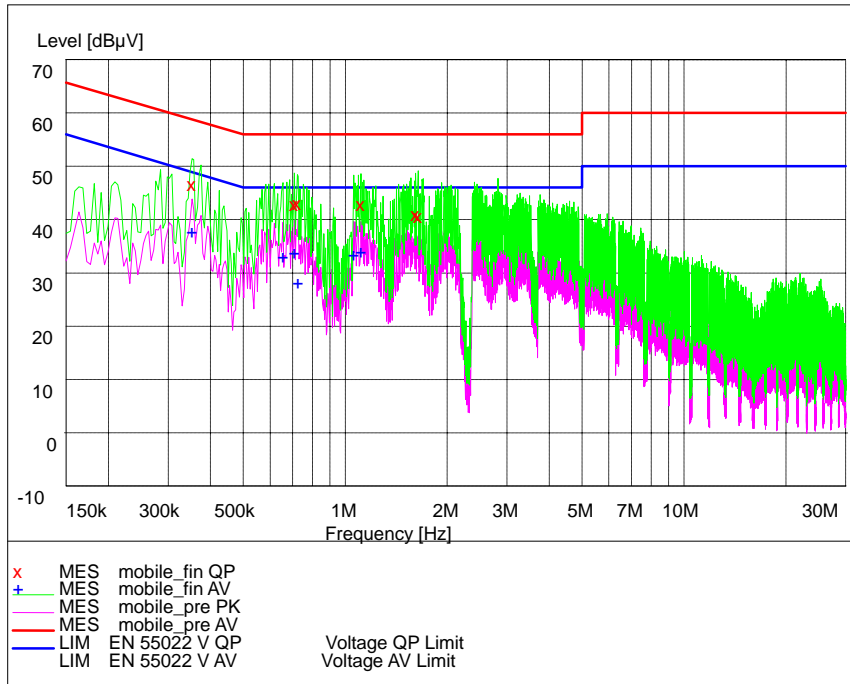

L and N Line

MEASUREMENT RESULT: "mobile_fin QP"

Frequency	Level	Transd	Limit	Margin	Line	PE
MHz	dBμV		dB	dBμV	dB	
0.352500	48.80	20.2	59	10.1	---	---
0.708000	45.00	20.3	56	11.0	---	---
0.721500	45.20	20.3	56	10.8	---	---
1.113000	45.00	20.2	56	11.0	---	---
1.612500	43.10	20.2	56	12.9	---	---
1.639500	42.70	20.2	56	13.3	---	---

MEASUREMENT RESULT: "mobile_fin AV"

Frequency	Level	Transd	Limit	Margin	Line	PE
MHz	dBμV		dB	dBμV	dB	
0.352500	39.90	20.2	49	9.0	---	---
0.654000	35.30	20.3	46	10.7	---	---
0.708000	36.10	20.3	46	9.9	---	---
0.726000	30.40	20.3	46	15.6	---	---
1.059000	35.60	20.2	46	10.4	---	---
1.113000	36.20	20.2	46	9.8	---	---

GSM 1900 Laptop+AE2#

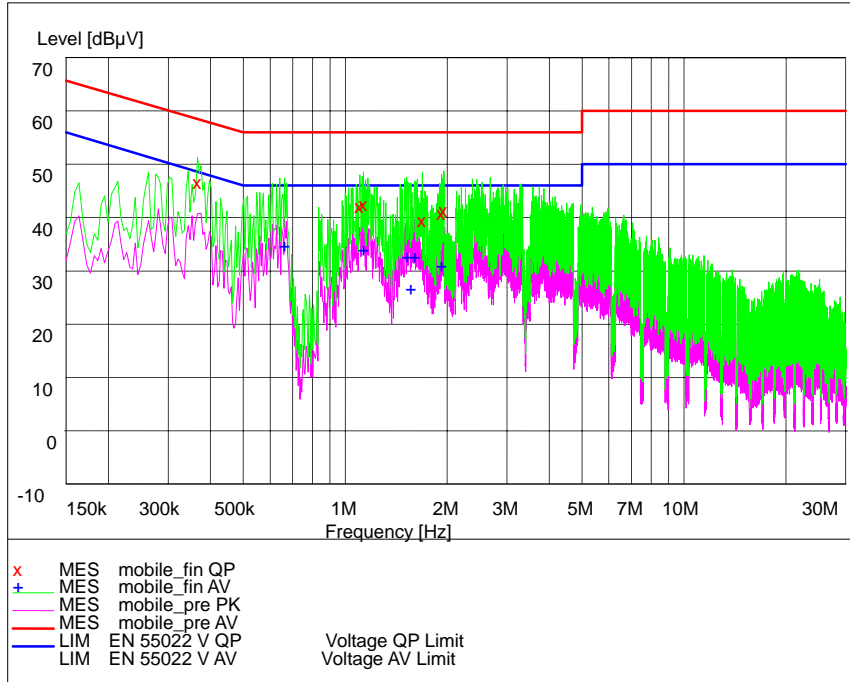

L and N Line

MEASUREMENT RESULT: "mobile_fin QP"

Frequency	Level	Transd	Limit	Margin	Line	PE
MHz	dBμV		dB	dBμV	dB	
0.366000	48.80	20.2	59	9.7	---	---
1.104000	44.30	20.2	56	11.7	---	---
1.131000	44.80	20.2	56	11.2	---	---
1.689000	41.60	20.2	56	14.4	---	---
1.923000	43.00	20.2	56	13.0	---	---
1.954500	43.50	20.2	56	12.5	---	---

MEASUREMENT RESULT: "mobile_fin AV"

Frequency	Level	Transd	Limit	Margin	Line	PE
MHz	dBμV		dB	dBμV	dB	
0.663000	37.00	20.3	46	9.0	---	---
1.131000	36.30	20.2	46	9.7	---	---
1.527000	34.90	20.2	46	11.1	---	---
1.563000	28.90	20.2	46	17.1	---	---
1.608000	34.90	20.2	46	11.1	---	---
1.923000	33.20	20.2	46	12.8	---	---

GSM 1900 Laptop+AE3#

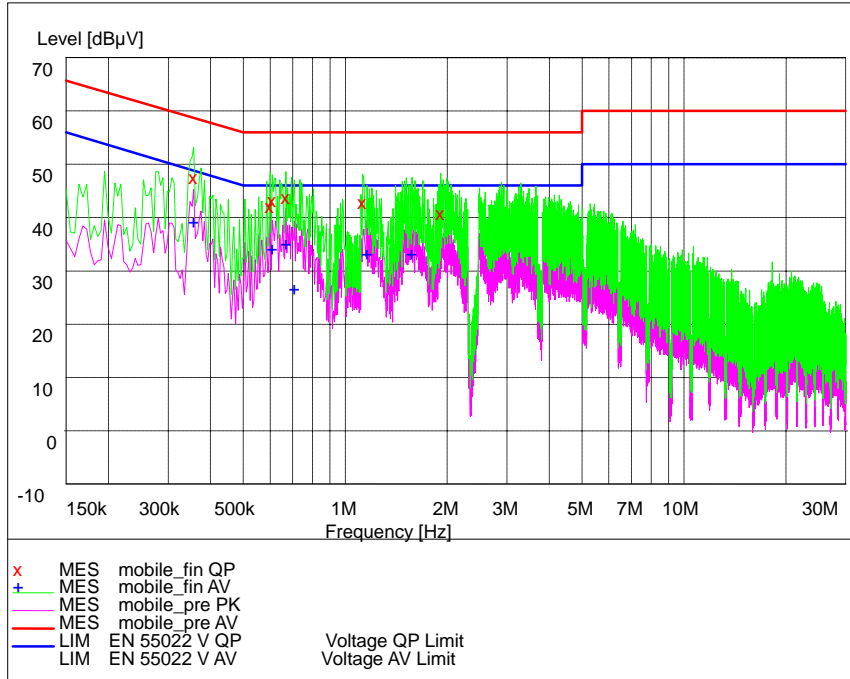

L and N Line

MEASUREMENT RESULT: "mobile_fin QP"

Frequency	Level	Transd	Limit	Margin	Line	PE
MHz	dBμV		dB	dBμV	dB	
0.357000	49.80	20.2	59	8.9	---	---
0.600000	44.30	20.3	56	11.7	---	---
0.609000	45.40	20.3	56	10.6	---	---
0.667500	46.00	20.3	56	10.0	---	---
1.126500	45.00	20.2	56	11.0	---	---
1.914000	42.90	20.2	56	13.1	---	---

MEASUREMENT RESULT: "mobile_fin AV"

Frequency	Level	Transd	Limit	Margin	Line	PE
MHz	dBμV		dB	dBμV	dB	
0.357000	41.50	20.2	49	7.3	---	---
0.609000	36.50	20.3	46	9.5	---	---
0.667500	37.40	20.3	46	8.6	---	---
0.708000	28.90	20.3	46	17.1	---	---
1.158000	35.50	20.2	46	10.5	---	---
1.572000	35.50	20.2	46	10.5	---	---

Camera Laptop+AE2#

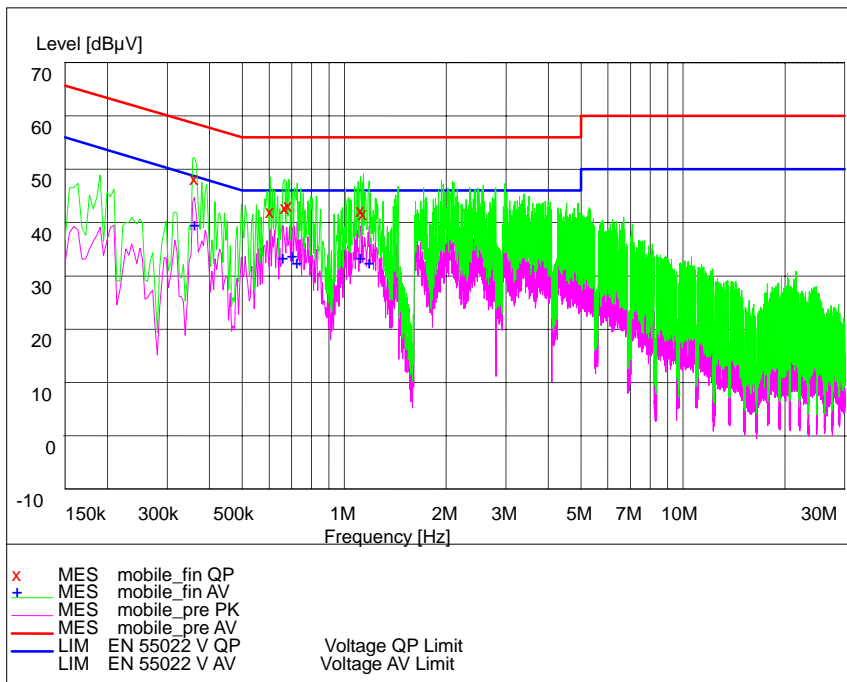

L Line

MEASUREMENT RESULT: "mobile_fin QP"

Frequency	Level	Transd	Limit	Margin	Line	PE
MHz	dBμV		dB	dBμV	dB	
0.361500	50.40	20.2	59	8.2	---	---
0.604500	44.30	20.3	56	11.7	---	---
0.667500	45.10	20.3	56	10.9	---	---
0.685500	45.30	20.3	56	10.7	---	---
1.117500	44.50	20.2	56	11.5	---	---
1.140000	44.00	20.2	56	12.0	---	---

MEASUREMENT RESULT: "mobile_fin AV"

Frequency	Level	Transd	Limit	Margin	Line	PE
MHz	dBμV		dB	dBμV	dB	
0.361500	41.90	20.2	49	6.8	---	---
0.658500	35.70	20.3	46	10.3	---	---
0.703500	36.00	20.3	46	10.0	---	---
0.726000	34.70	20.3	46	11.3	---	---
1.117500	35.70	20.2	46	10.3	---	---
1.185000	34.80	20.2	46	11.2	---	---

2.2.2 Radiated Emissions-FCC Part15.109

Ambient condition:

Temperature	Relative humidity	Pressure
19.7°C	49.1%	99.9kPa

Test Setup:

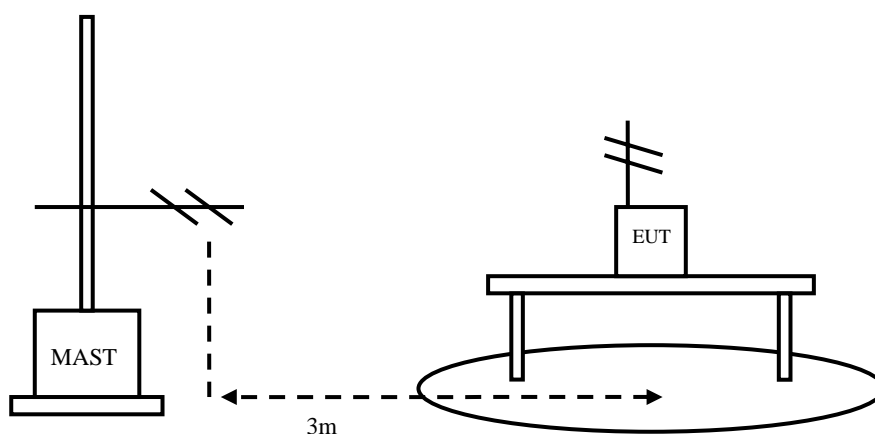

Figure 2

Test Procedure:

The EUT should be placed on a non-metallic table 80cm above the ground plane. The receive antennas shall be moved from 1 to 4 meters. The distance between EUT and receive antenna should be 3 meters.

The EUT should work in idle mode. The accessories of the EUT are connected with the EUT such as headset etc. The test set-up and the test methods are performed according to ANSI C63.4:2009.

Then start the test software ES-K1. Sweep the whole frequency band through the range from 30MHz to 1GHz, using receive log period antenna HL562.

During the test, the height of receive antenna shall be moved from 1 to 4 meters, and the antenna shall be performed under horizontal and vertical polarization. The turn table shall be rotated from 0 to 360 degrees for detecting the maximum of radiated spurious signal level. The measurements shall be repeated with orthogonal polarization of the test antenna. The EUT is laid in two modes as follow: 1. put the EUT in horizontal direction; 2. put the EUT in vertical direction.

The data of cable loss and antenna factor have been calibrated in full testing frequency range before the testing.

A “reference path loss” is established and the A_{Rpl} is the attenuation of “reference path loss”, and including the gain of receive antenna, the gain of the preamplifier, the cable loss.

The measurement results are obtained as described below:

$$\text{Result} = P_{\text{mea}} + A_{Rpl}$$

Limit:

Frequency of Emission(MHz)	Limits	
	Detector	Unit (dB μ V/m)
30~88	Quasi-peak	40
88~216	Quasi-peak	43.5
216~960	Quasi-peak	46
960~1000	Quasi-peak	54
1000~5th harmonic of the highest frequency or 40GHz, whichever is lower	Average	54
	Peak	74

Test result:

GSM 850 Mode

Frequency(MHz)	Result(dBuV/m)	A_{Rpl} (dB)	P_{mea} (dBuV/m)	Polarity
52.02	25.28	3.1	22.18	Vertical
62.31	25.15	3.1	22.05	Vertical
107.54	22.31	3.2	19.11	Vertical
178.57	26.59	3.2	23.39	Horizontal
541.78	23.58	3.9	19.68	Horizontal
945.89	30.12	5.7	24.42	Vertical

PCS1900 Mode

Frequency(MHz)	Result(dBuV/m)	A_{Rpl} (dB)	P_{mea} (dBuV/m)	Polarity
53.48	22.36	3.1	19.26	Vertical
85.79	31.42	3.1	28.32	Horizontal
107.87	22.47	3.2	19.27	Vertical
946.29	29.68	5.7	23.98	Vertical
6997.25	34.92	-14.2	49.12	Horizontal
10000.00	35.13	-9.6	44.73	Horizontal

Camera Mode

Frequency(MHz)	Result(dBuV/m)	A _{Rpl} (dB)	P _{mea} (dBuV/m)	Polarity
36.24	23.85	3.1	20.75	Horizontal
53.78	22.34	3.1	19.24	Horizontal
73.59	24.48	3.1	21.38	Vertical
107.54	21.32	3.2	18.12	Vertical
175.84	20.17	3.2	16.97	Horizontal
947.98	30.02	5.7	24.32	Horizontal

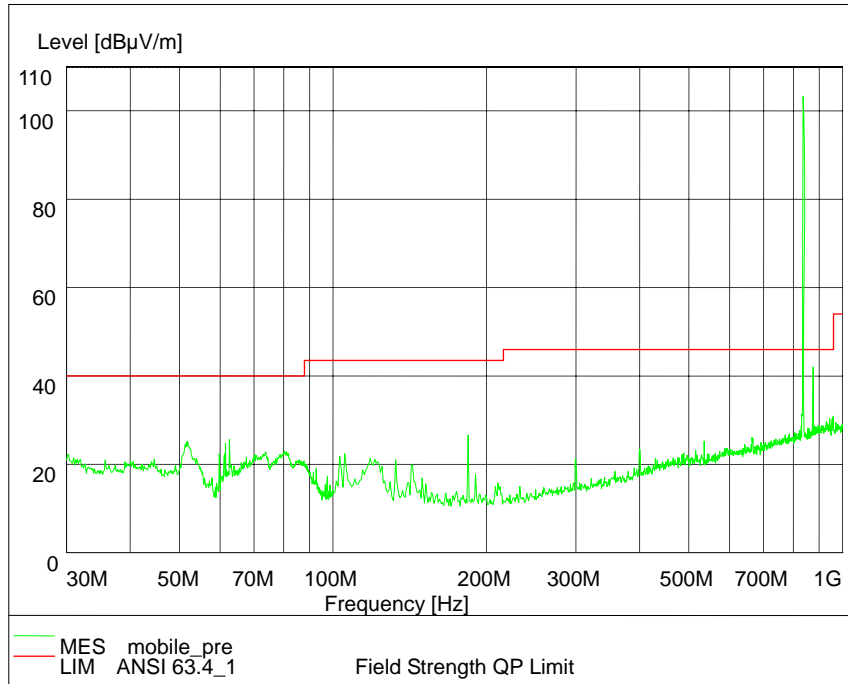

GSM 850(30MHz – 1GHz)

Note: The signal beyond the limit is the base station simulator carrier.

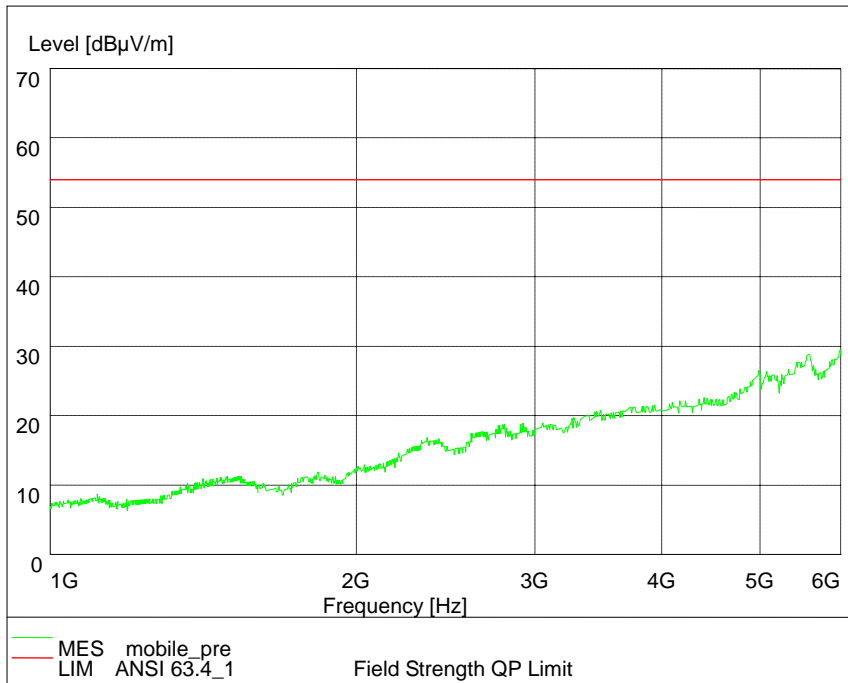

GSM 850(1GHz – 6GHz)

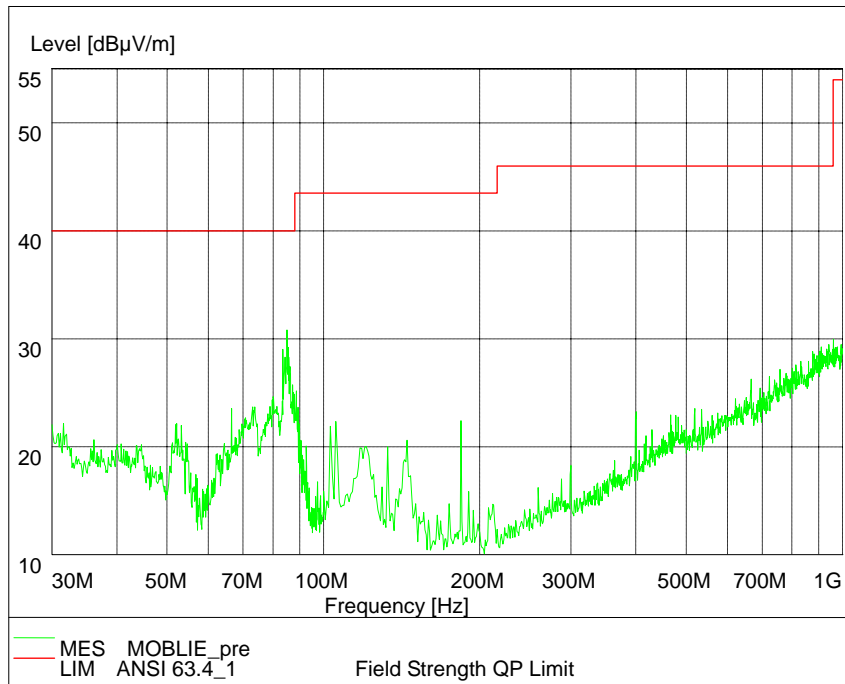

PCS 1900(30MHz – 1GHz)

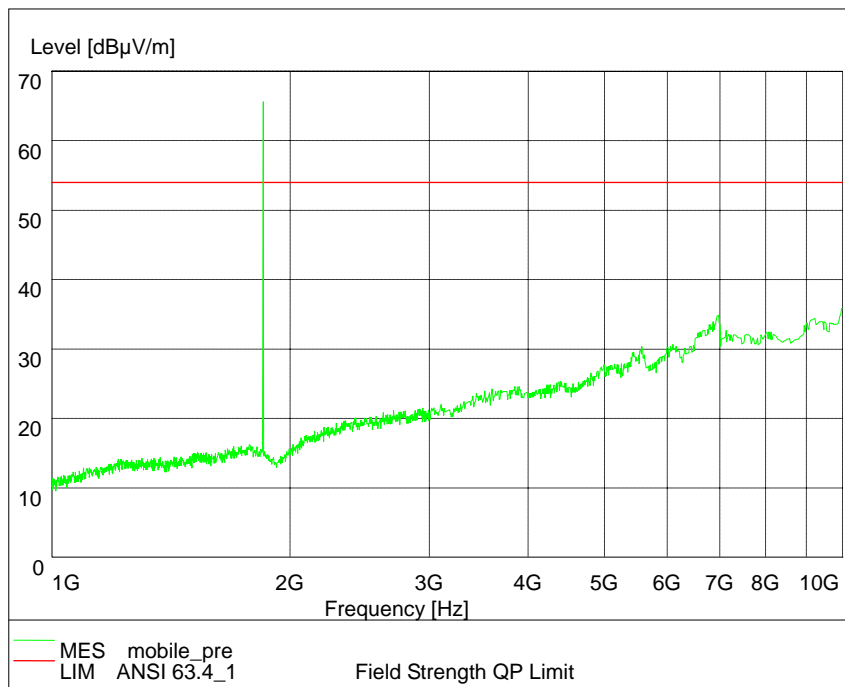

PCS 1900(1GHz – 10GHz)

Note: The signals beyond the limit are the base station and simulator carrier.

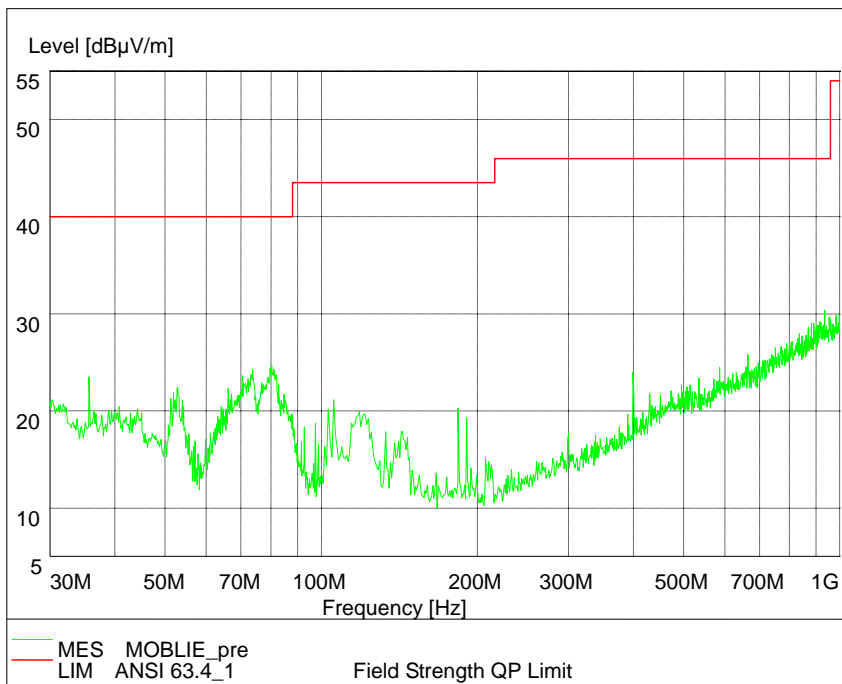

Camera (30MHz – 1GHz)

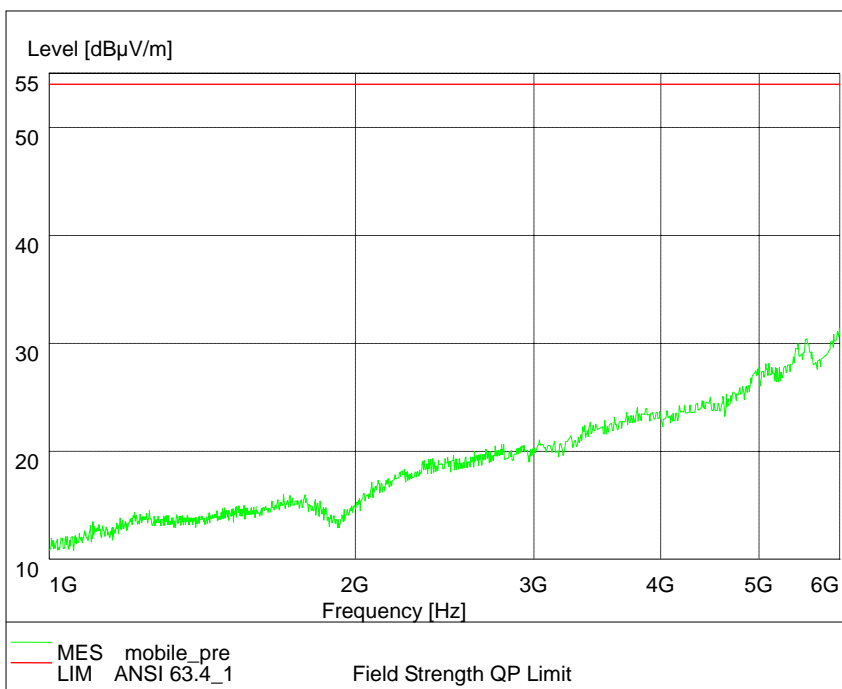

Camera (1GHz – 6GHz)

2.3. List of test equipments

No.	Name/Model	Manufacturer	S/N	Calibration Due Date
1	23.18m×16.88m×9.60m Semi-Anechoic Chamber	FRANKONIA	-----	19 th Aug. 2011
2	ESI 40 EMI test receiver	R&S	100015	19 th Aug. 2011
3	E5515C(8960) Mobile Station Tester	Agilent	GB44050904	19 th Aug. 2011
4	9.080m×5.255m×3.525m Shielding room	FRANKONIA	-----	19 th Aug. 2011
5	ESCS30 EMI test receiver	R&S	100029	19 th Aug. 2011
6	HL562 Ultra log test antenna	R&S	100016	19 th Aug. 2011
7	ESH3-Z2 Pulse limiter	R&S	10002	19 th Aug. 2011
8	ESH3-Z5 Attenuator	R&S	100020	19 th Aug. 2011
9	ESH2Z11 LISN	R&S	50FH-020-10	19 th Aug. 2011
10	HF 906 Double-Ridged Waveguide Horn Antenna	R&S	100030	19 th Aug. 2011
11	HF 906 Double-Ridged Waveguide Horn Antenna	R&S	100029	19 th Aug. 2011
12	PS2000 Turn Table	FRANKONIA	-----	19 th Aug. 2011
13	MA260 Antenna Master	FRANKONIA	-----	19 th Aug. 2011
14	ES-K1EMI test software	R&S	-----	19 th Aug. 2011
15	HL562 Receive antenna	R&S	100167	19 th Aug. 2011

Appendix