

TEST REPORT

REPORT NUMBER: I10GC0567-FCC-Part22

ON

Type of Equipment: GSM/GPRS/EGPRS mobile phone
Model Number: Sonim XP3300-A-R1
Type Number: P25C005AA
Manufacturer: Sonim Technologies, Inc

ACCORDING TO
FCC CFR Part 2, FREQUENCY ALLOCATIONS AND RADIO
TREATY MATTERS; GENERAL RULES AND REGULATIONS;
e-CFR, Oct 1,2009
PART 22, PUBLIC MOBILE SERVICES (Oct 1, 2009)
PART 24, PERSONAL COMMUNICATIONS SERVICES (Oct 1,
2009)

China Telecommunication Technology Labs.

Month date, year
Dec, 24, 2010

Signature



He Guili
Director

FCC ID: WYPP25C005AA

Report Date: 2010-11-25

Test Firm Name: China Telecommunication Technology Labs

Registration Number: 840587

Statement

The measurements shown in this report were made in accordance with the procedures described on test pages. All reported tests were carried out on a sample equipment to demonstrate limited compliance with FCC CFR 47 Parts 2, 22 and 24. The sample tested was found to comply with the requirements defined in the applied rules.

CONTENTS

1 GENERAL INFORMATION	4
1.1 NOTES	4
1.2 TESTERS	5
1.3 TESTING LABORATORY INFORMATION	6
1.4 DETAILS OF APPLICANT OR MANUFACTURER	7
2 TEST ITEM	8
2.1 GENERAL INFORMATION	8
2.2 OUTLINE OF EUT	8
2.3 MODIFICATIONS INCORPORATED IN EUT	8
2.4 EQUIPMENT CONFIGURATION	8
2.5 OTHER INFORMATION	8
3 SUMMARY OF TEST RESULTS	9
4 TEST RESULTS	10
4.1 RADIATED SPURIOUS EMISSION	10
4.2 RADIATED RF POWER OUTPUT	24
4.3 OCCUPIED BANDWIDTH	27
4.4 FREQUENCY STABILITY OVER TEMPERATURE VARIATION	38
4.5 FREQUENCY STABILITY OVER VOLTAGE VARIATION	42
4.6 CONDUCTED RF POWER OUTPUT	45
4.7 CONDUCTED SPURIOUS EMISSION	48
4.8 BAND-EDGE (CONDUCTED)	52
ANNEX A EXTERNAL PHOTOS	60
ANNEX B INTERNAL PHOTOS	61
ANNEX C DEVIATIONS FROM PRESCRIBED TEST METHODS	62

1 General Information

1.1 Notes

All reported tests were carried out on a sample equipment to demonstrate limited compliance with FCC CFR 47 Parts 2, 22 and 24.

The test results of this test report relate exclusively to the item(s) tested as specified in section 2.

The following deviation from, additions to, or exclusions from the test specifications have been made. See Annex C.

China Telecommunication Technology Labs.(CTTL) authorizes the applicant or manufacturer (see section 1.4) to reproduce this report provided, and the test report may only be reproduced or published in full. Reproduction or publication of extracts from the report requires the prior written approval of CTTL Mr. He Guili.

Any use which a third party makes of this report, or any reliance on or decisions to be made based on it, are the responsibility of such third parties. CTTL accepts no responsibility for damages, if any, suffered by any third party as a result of decisions made or actions based on this report.

1.2 Testers

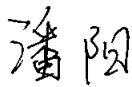
Name: Pan Yang
Position: Engineer
Department: Department of EMC test
Duration of the test: From 2010-11-14 to 2010-11-19
Signature: 

Editor of this test report:

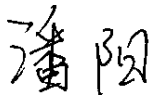
Name: Pan Yang
Position: Engineer
Department: Department of EMC test
Date: 2010-12-24
Signature: 

Technical responsibility for area of testing:

Name: Zou Dongyi
Position: Manager
Department: Department of EMC test
Date: 2010-12-24
Signature: 

1.3 Testing Laboratory information

1.3.1 Location

Name: China Telecommunication Technology Labs.
Address: No. 11, Yue Tan Nan Jie, Xi Cheng District
BEIJING
P. R. CHINA, 100083
Tel: +86 10 68094053
Fax: +86 10 68011404
Email: emc@chinattl.com

1.3.2 Details of accreditation status

Accredited by: China National Accreditation for Laboratory (CNAL)
Registration number: CNAL Registration No.L0570
Standard: ISO/IEC 17025

1.3.3 Test location, where different from section 1.3.1

Name: -----
Street: -----
City: -----
Country: -----
Telephone: -----
Fax: -----
Postcode: -----

1.4 Details of applicant or manufacturer

1.4.1 Applicant

Name: Sonim Technologies, Inc
Address: 1875 S. Grant Street, Suite 800 San Mateo, CA 94402
Country: United States
Telephone: +1 650 504 4411
Fax: +1 650 378 8190
Contact: Jasen Kolev
Telephone: +1 650 504 4411
Email: jasen@sonimtech.com

1.4.2 Manufacturer (if different from applicant in section 1.4.1)

Name: --
Address: --
City: --
Country: --

2 Test Item

2.1 General Information

Manufacturer: Sonim Technologies, Inc

Name: GSM/GPRS/EGPRS mobile phone

Model Number: Sonim XP3300-A-R1

Type Number: P25C005AA

Serial Number: --

Production Status: Production

Receipt date of test item: 2010-10-28

2.2 Outline of EUT

EUT is a GSM850/ PCS1900 Dual-band Terminal Equipment. It supports GSM mode, with the frequency range of 824 MHz to 849 MHz for GSM/GPRS/EGPRS band 850 and 1 850 MHz to 1 910 MHz for GSM/GPRS/EGPRS band 1900. Its modulation type is GMSK.

2.3 Modifications Incorporated in EUT

The EUT has not been modified from what is described by the brand name and unique type identification stated above.

2.4 Equipment Configuration

Equipment configuration list:

Item	Generic Description	Manufacturer	Type	Serial No.	Remarks
A	Mobile phone	Sonim Technologies, Inc	Sonim XP3300-A-R1	--	None
B	Battery	Sunwoda Electronic Co., Ltd.	XP-0001100	--	None

2.5 Other Information

(a) Multislot Class of GPRS

The multislot class of the GPRS mode is class 12 with 5 active timeslots.

(b) About Power Source

Items	Relative Information
Battery	Capacity: 1750mAh Voltage:3.7V

(c) Emission Designator is 285KGXW

3 Summary of Test Results

A brief summary of the tests carried out is shown as following.

Specification Clause	Name of Test	Result
2.1051, 24.238, 2.1053,22.917	Radiated Spurious Emission	Pass
2.1046,24.232	Radiated RF Power Output	Pass
22.913(a)	Effective Radiated Power (ERP)	Pass
2.1049,22.917(b), 24.238(b)	Occupied Bandwidth	*Note 1
2.1055,22.355, 24.235	Frequency Stability over Temperature Variation	Pass
2.1046,22.809,24. 232(b)	Conducted RF Power Output	Pass
2.1057,22.357,24. 238	Conducted spurious emissions	Pass
2.1055,22.355, 24.235	Frequency Stability over Voltage Variation	Pass
2.1051, 24.238, 2.1053, 22.917	Band-edge (conducted)	Pass
Note 1: No applicable performance criteria.		

4 Test Results

4.1 Radiated Spurious Emission

Specifications:	2.1051, 24.238,2.1053,22.917					
Date of Tests	2010-11-11~2010-11-14					
Test conditions:	Ambient Temperature:15°C-35°C Relative Humidity:30%-60% Air pressure: 86-106kPa					
Operation Mode	TX on, channel 190 and 661					
Test Results:	Pass					
Test equipment Used:						
Asset Number	Description	Manufacturer	Model Number	Serial Number	Cal Due	State
7805	EMI Test Receiver	R/S	ESI26	100211	2011-01-11	Normal
7330	Ultra Broadband Antenna	R/S	VULB 9160	vulb9160-3252	2013-09-05	Normal
7330	Double-Ridged Horn Antenna	R/S	HF906	100037	2011-01-24	Normal
713	Fully-Anechoic Chamber	ETS	11.8m×6.5m×6.3m	--	2013-11-16	Normal
111835	Wireless Communications Test Set	R/S	CMU200	1100000802	2011-06-08	Normal

Limit Level Construction:

According to Part 24.238 (a), i.e., Out of band emissions. The power of any emission outside of the authorized operating frequency ranges must be attenuated below the transmitting power (P) by a factor of at least $43 + 10 \log(P)$ dB, so the limit level is:
 $P(\text{dBm}) - (43 + 10 \log(P)) \text{ dB} = -13\text{dBm}$

Limits for Radiated spurious emissions(UE)

Frequency range	Limit Level /Resolution Bandwidth
30 MHz to 20000 MHz	-13dBm/1MHz

Test Setup:

The EUT was placed in an anechoic chamber, see figure SP. The CMU 200 was used to set the TX channel and power level and modulate the TX signal with different bit patterns. The test was done using an automated test system, where all test equipments were controlled by a computer.



Figure SP

Test Method:

1 The maximum spurious emissions were searched by turning the azimuth of the turntable, shifting the polarization of the measuring antenna and changing the pose of the EUT.

2 Levels of EUT's transmitter harmonics and suspicious signals were recorded.

3 The recorded levels were corrected in the automated test system with the correction factors given by a substitution calibration made before the measurement. The calibration was made separately for vertical and horizontal polarization and the system uses different correction factors depending on the measuring antenna polarization.

4 The corrected values of radiated spurious emissions indicated as EIRP are reported.

Note:

1 A fully charged battery was used during the test.

2 The investigated ARFCNs are 190 (836.6 MHz) and 661 (1880.0 MHz), which are the middle channel of GSM 850 MHz band and PCS 1900 MHz band respectively.

3 The investigated frequency range is 30 MHz ~ 20 GHz, including out of band emission and band-edge emission measurements.

Test Results for GSM mode:

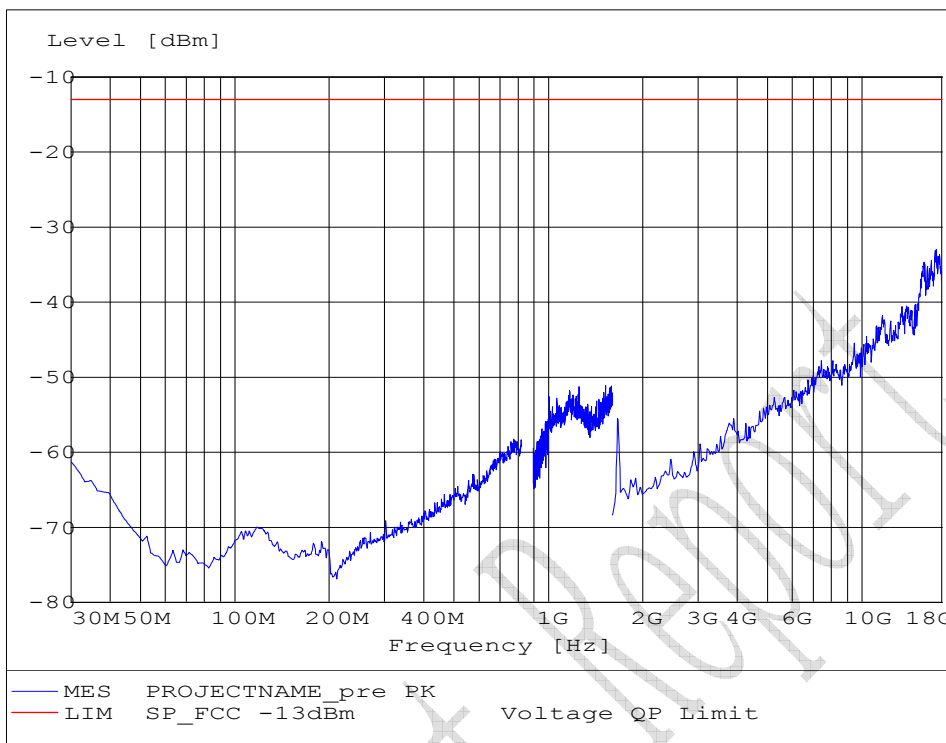

S190HF

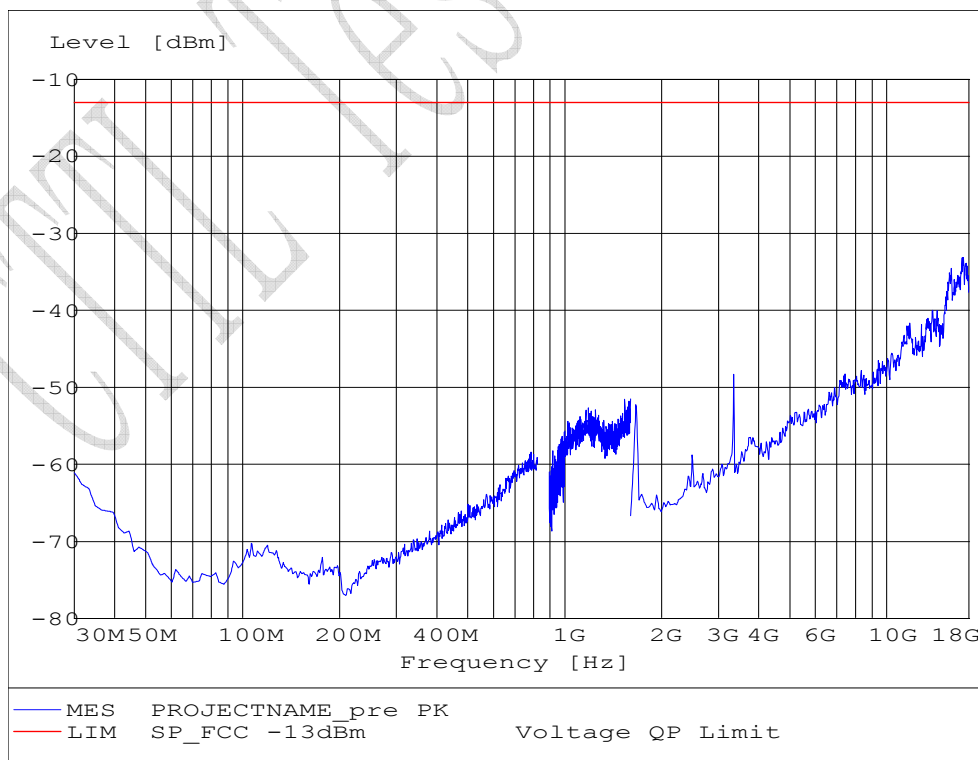

S190HT

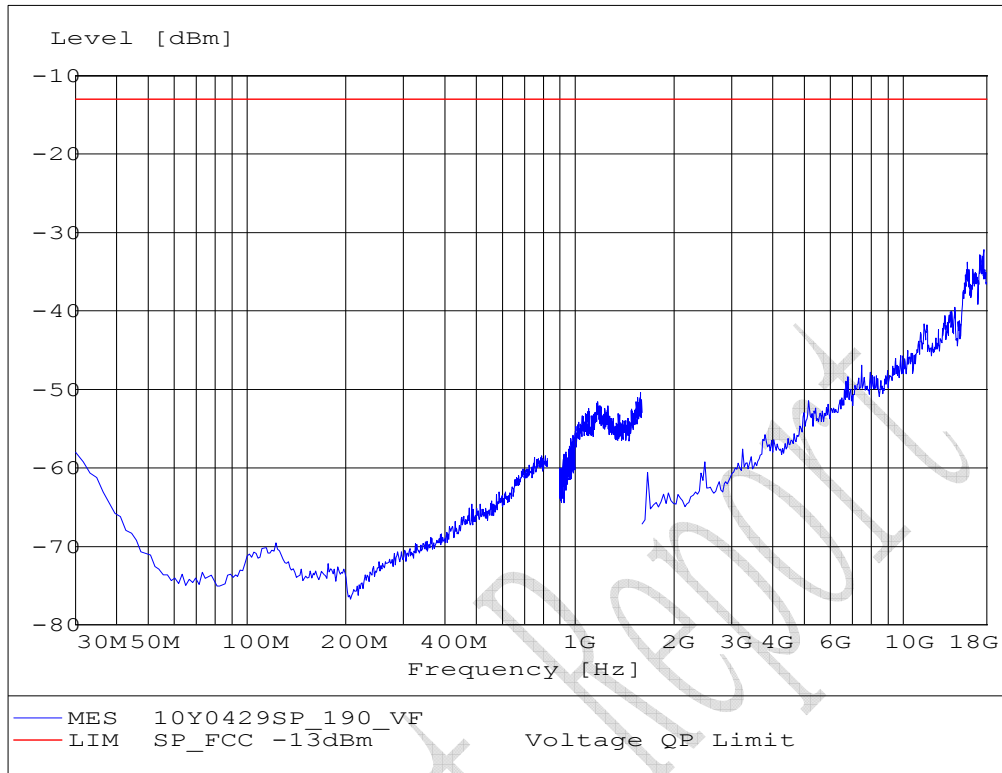

S190VF

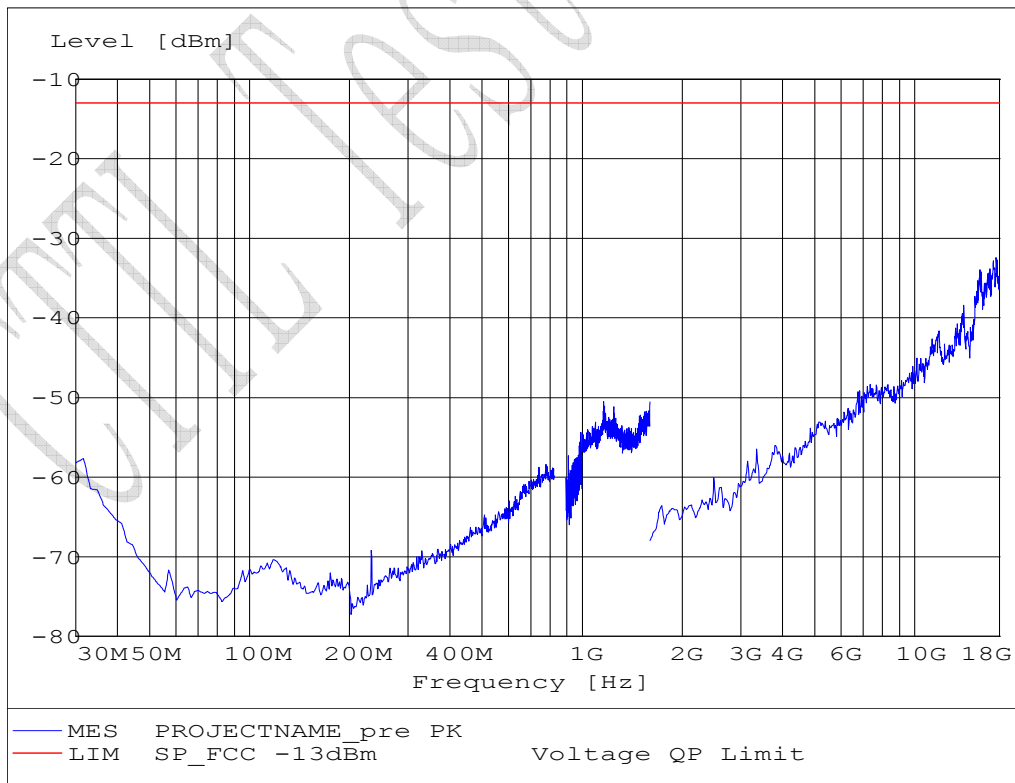

S190VT

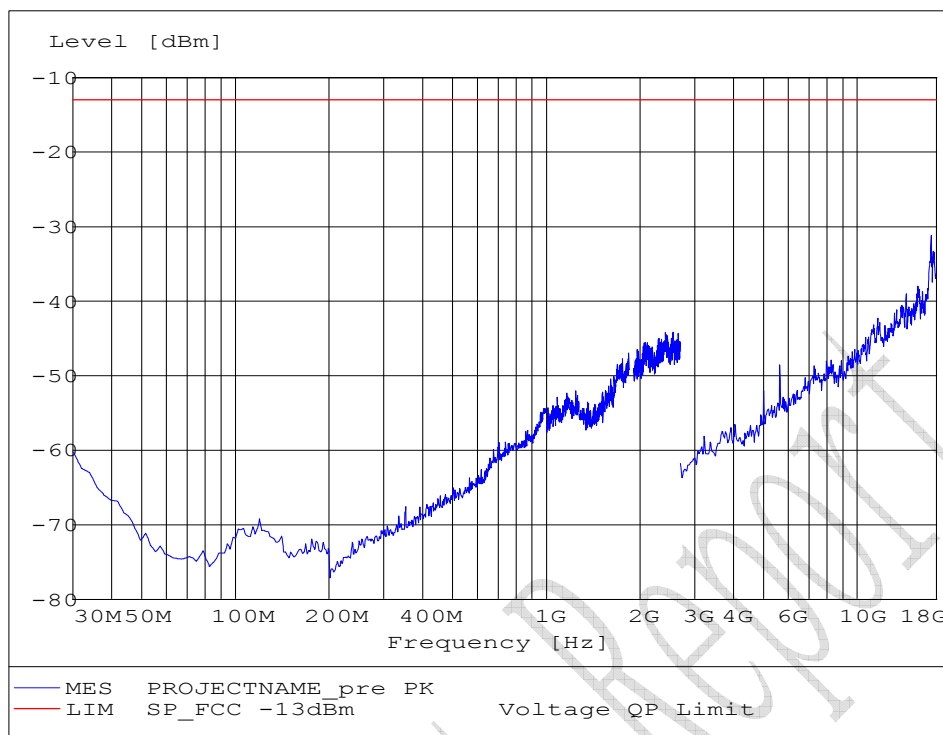

S661HF

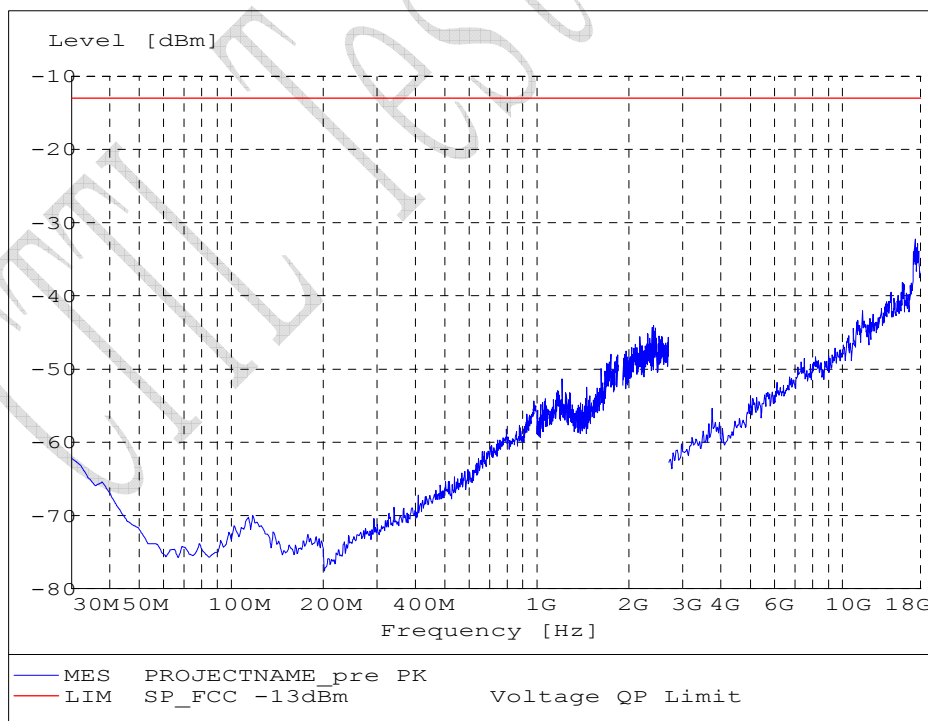

S661HT

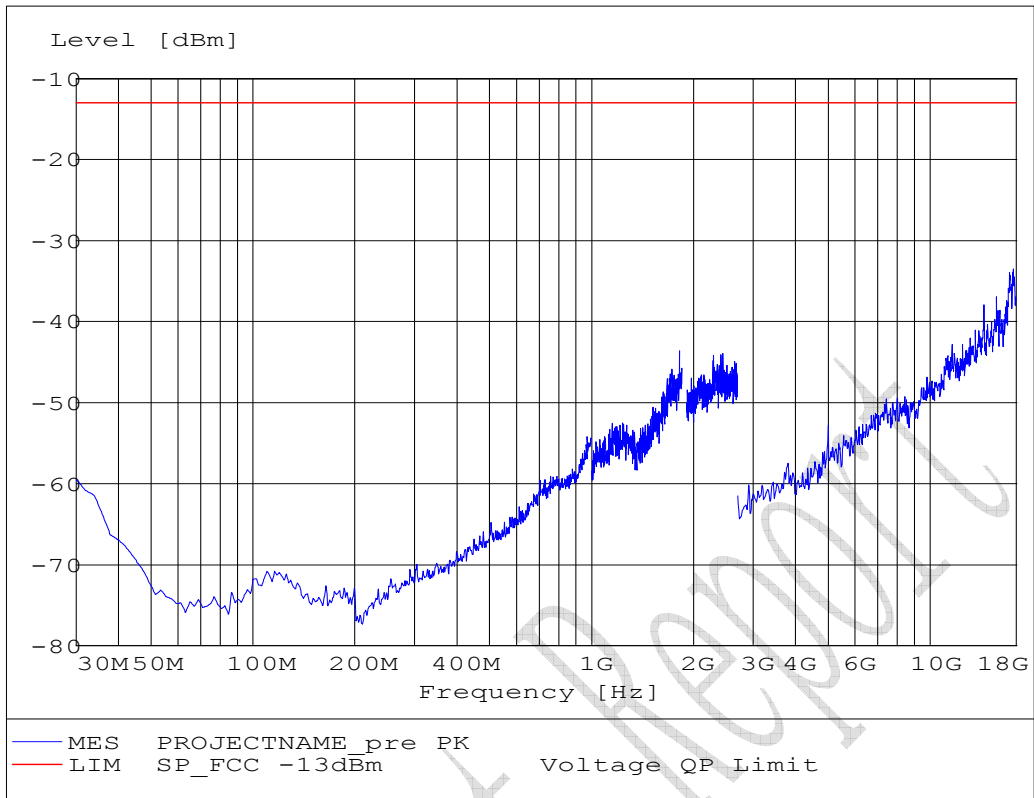

S661VF

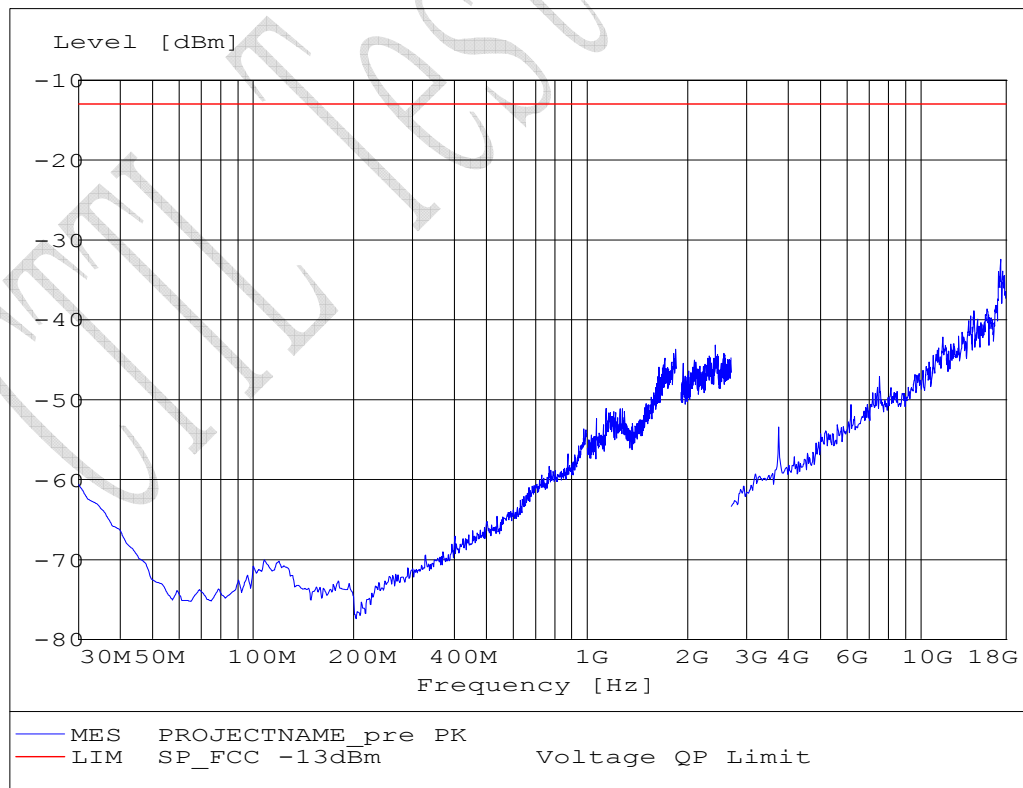

S661VT

Test Results for GPRS mode:

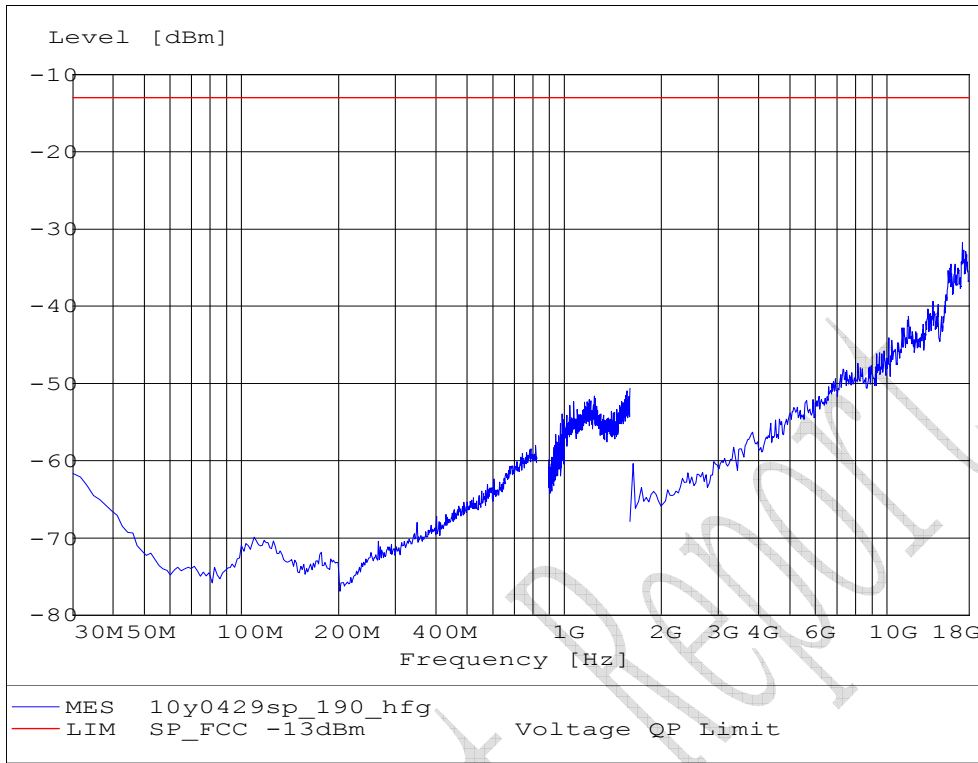

S190HFG

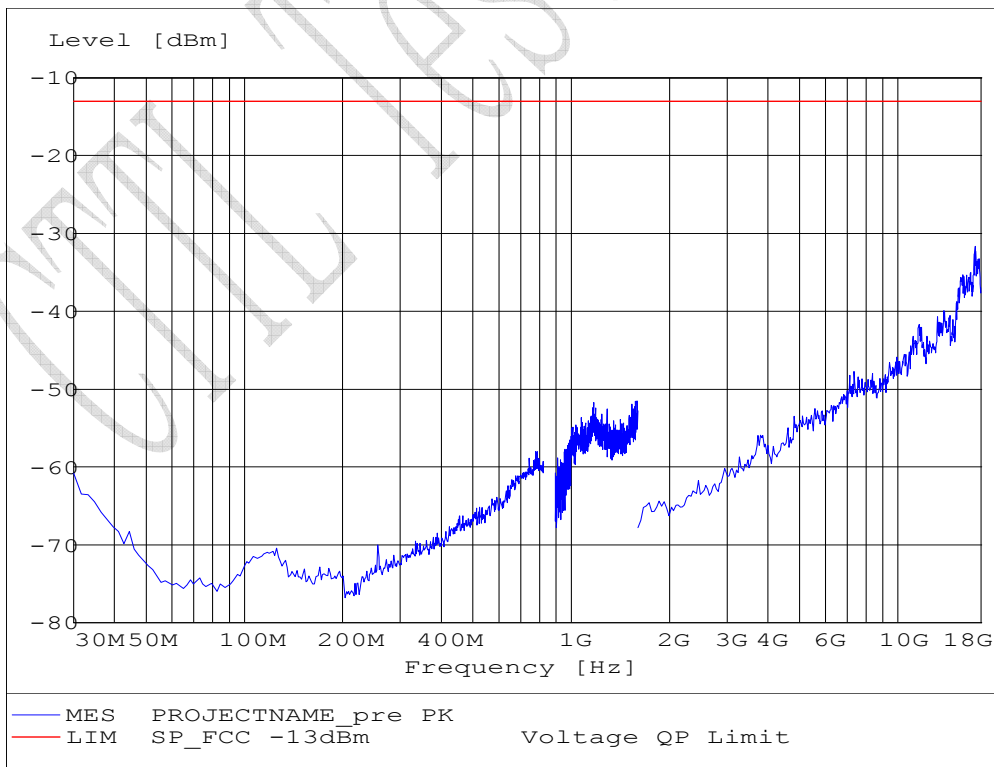

S190HTG

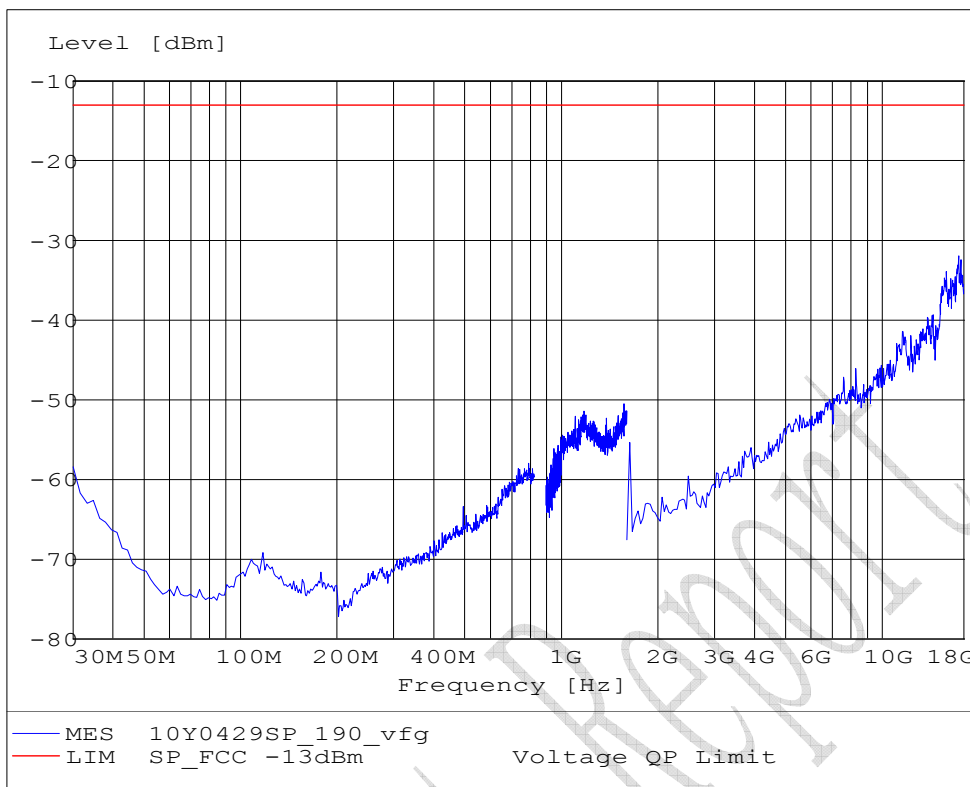

S190VFG

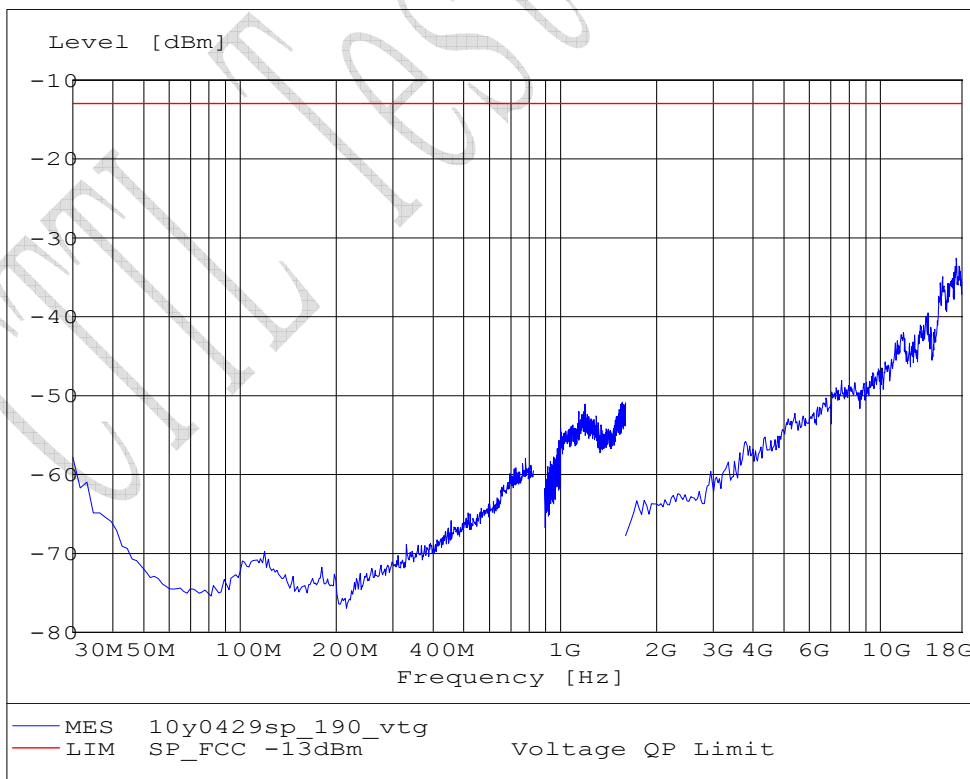

S190VTG

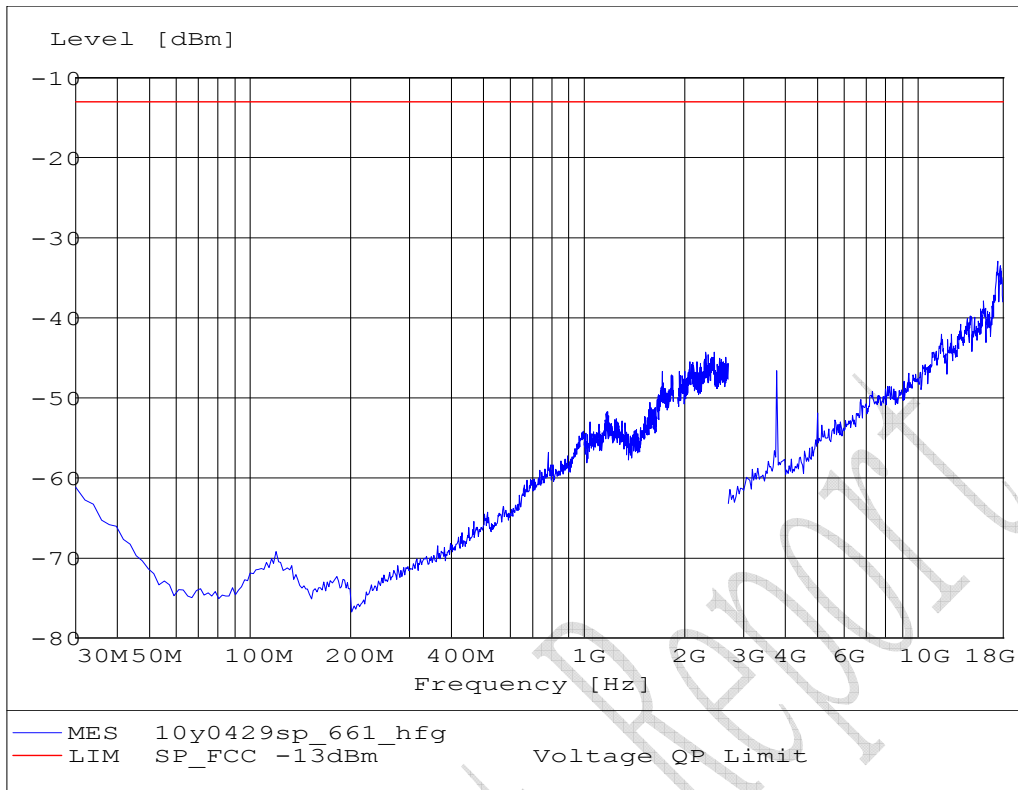

S661HFG

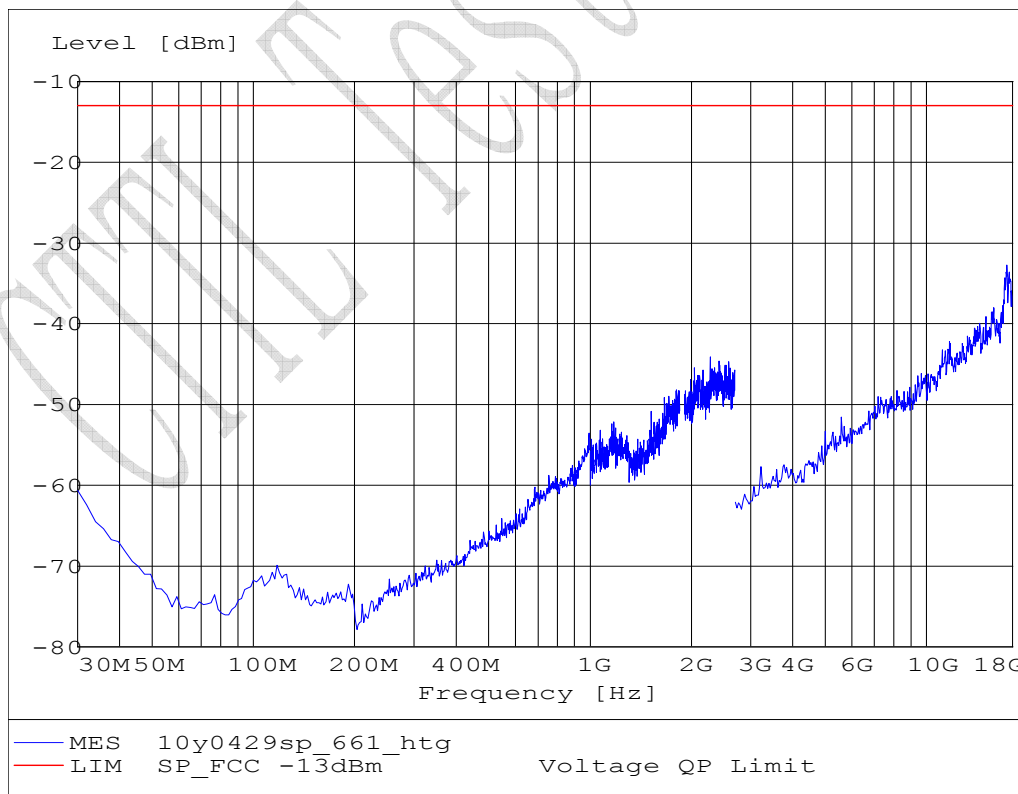

S661HTG

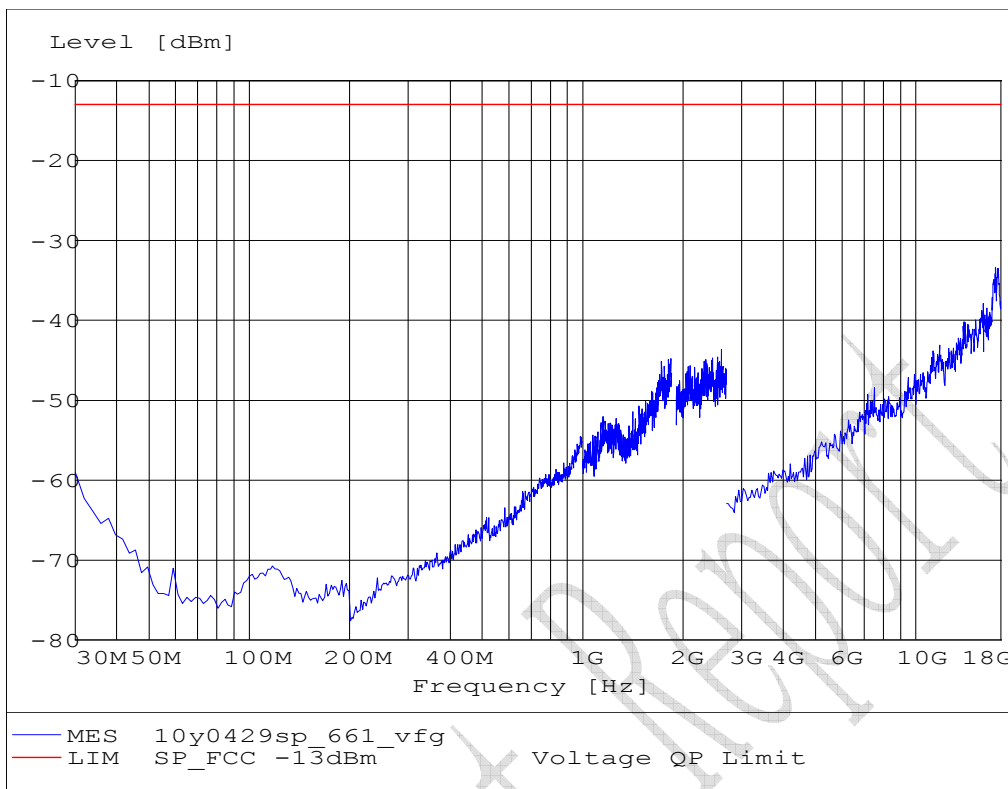

S661VFG

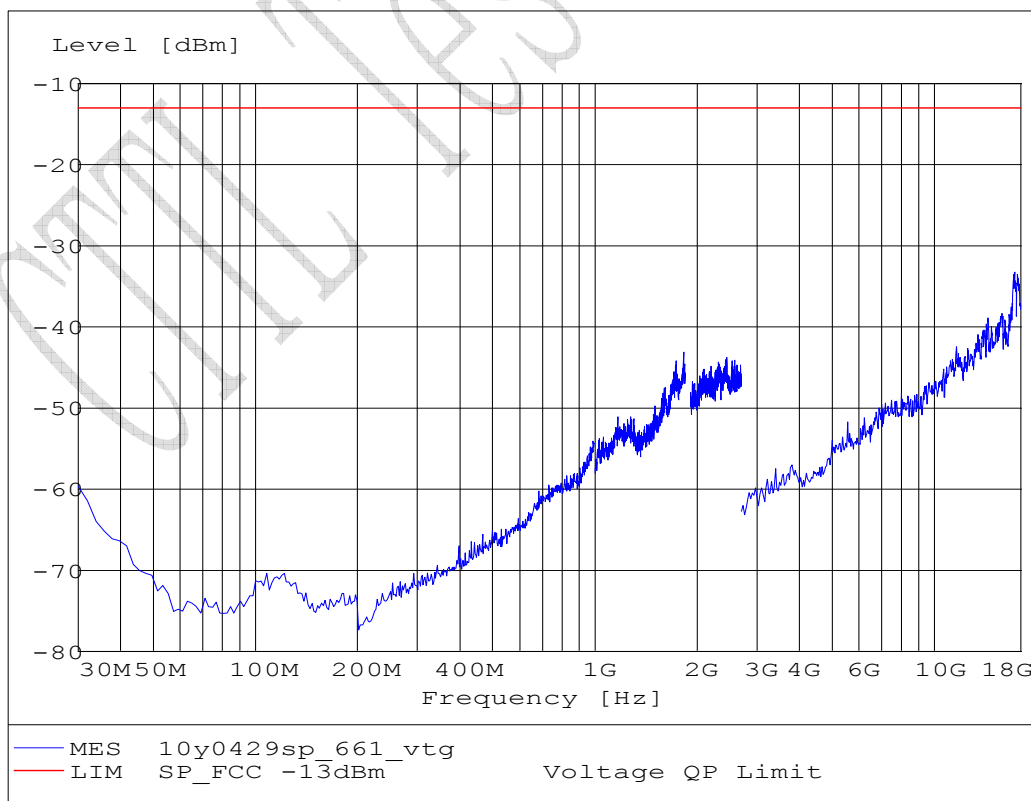

S661VTG

Test Results for EGPRS mode:

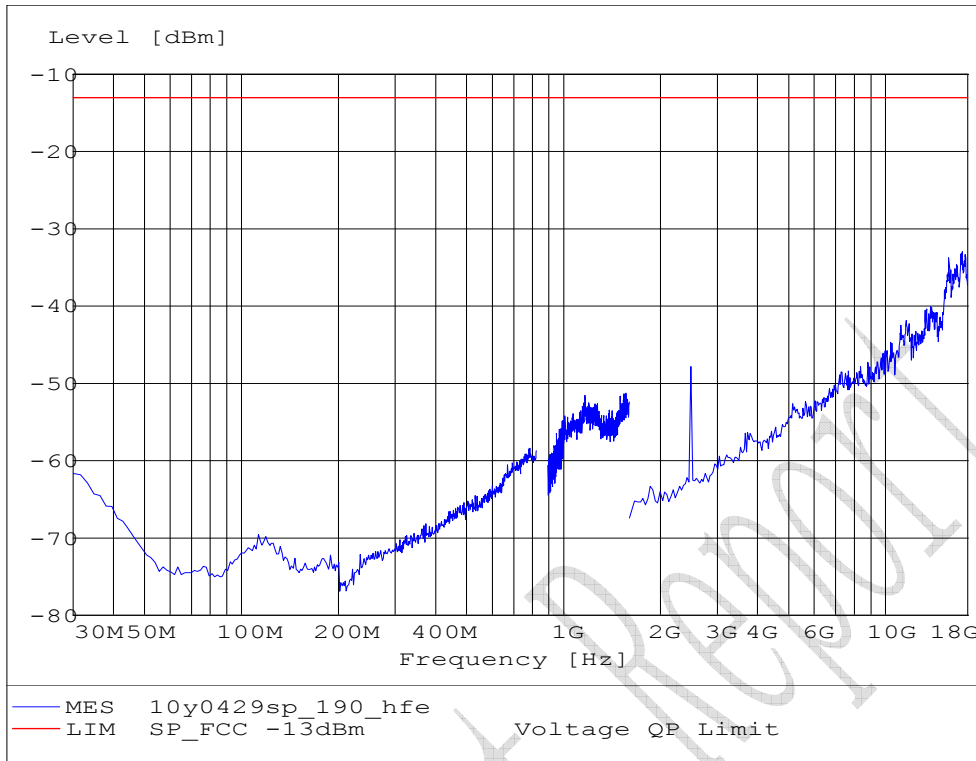

S190HFE

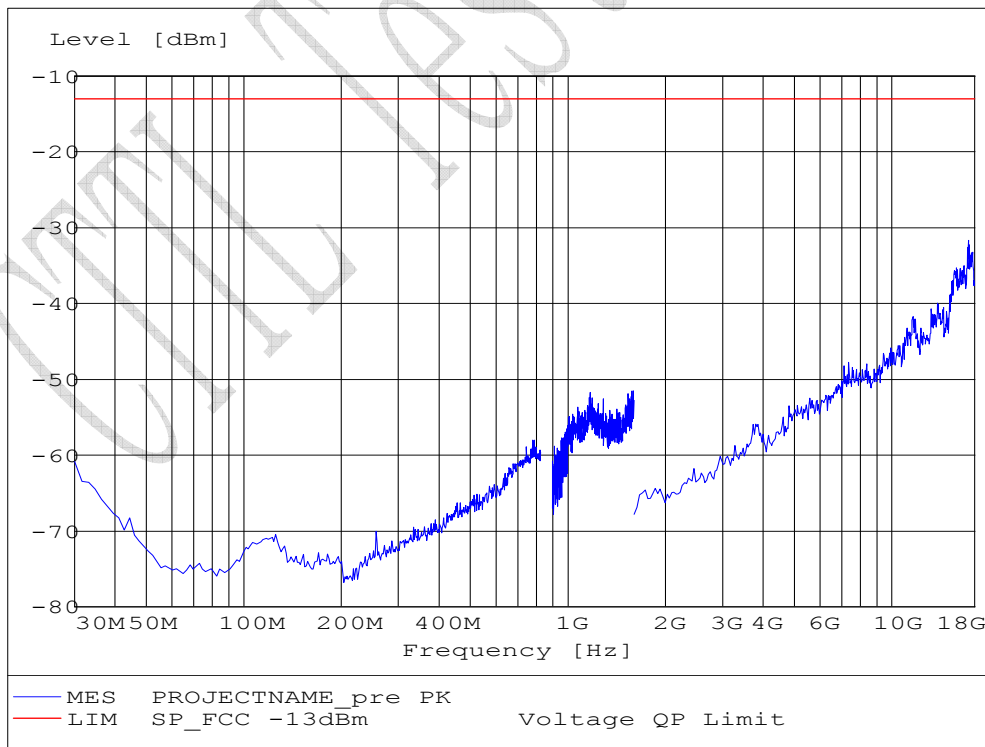

S190HTE

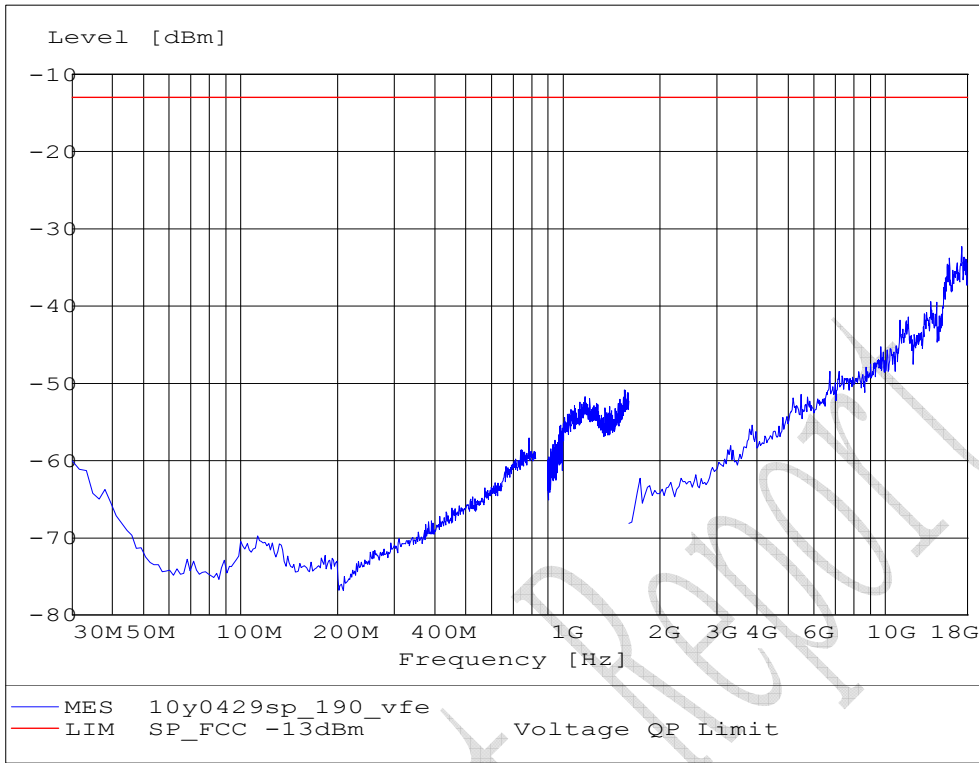

S190VFE

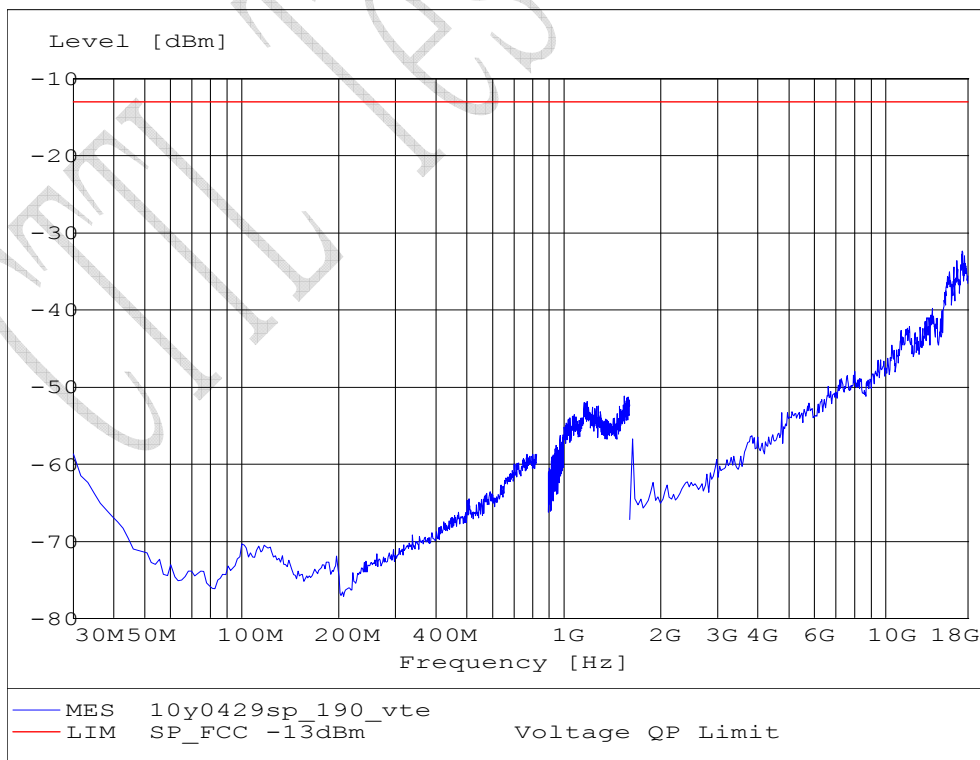

S190VTE

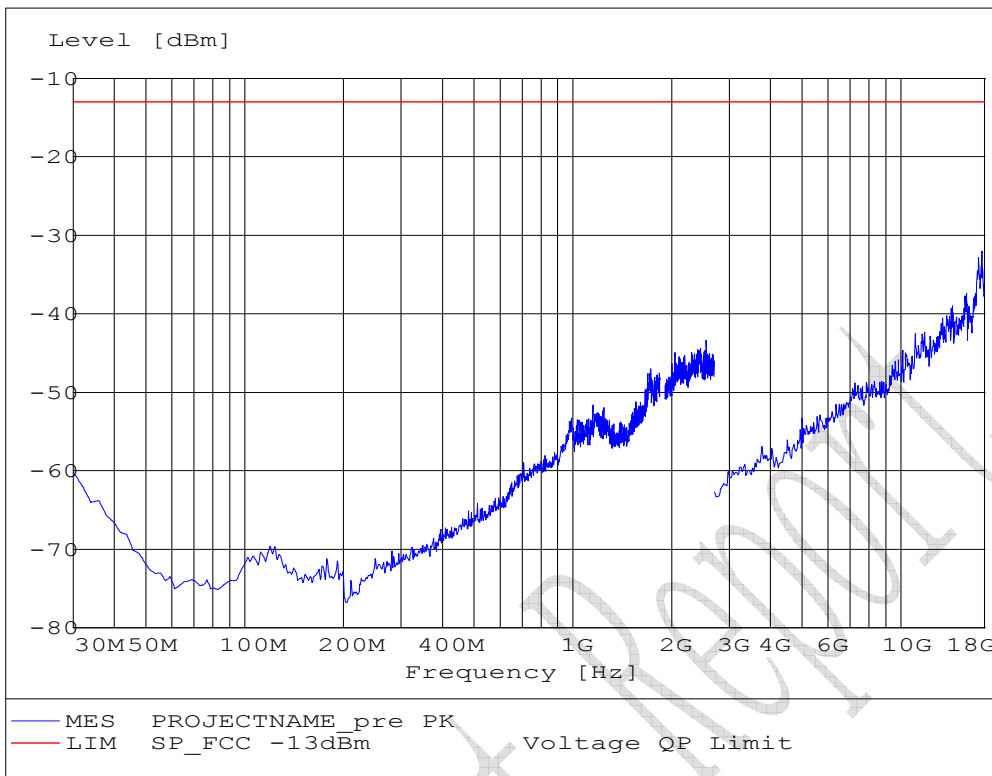

S661HFE

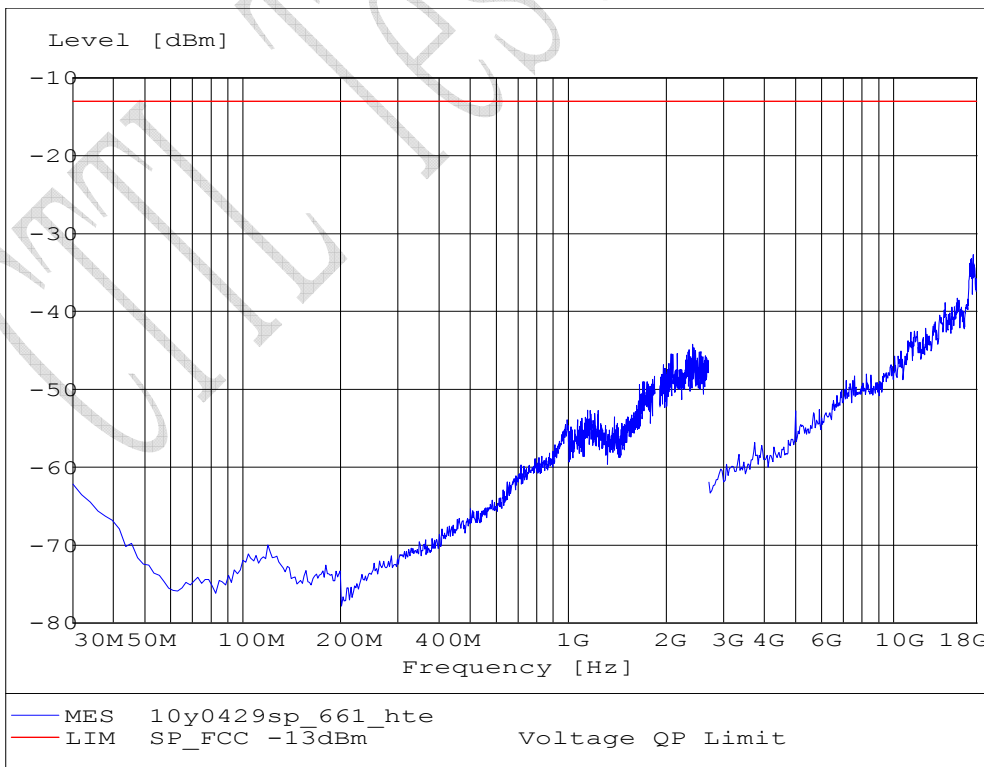

S661HTE

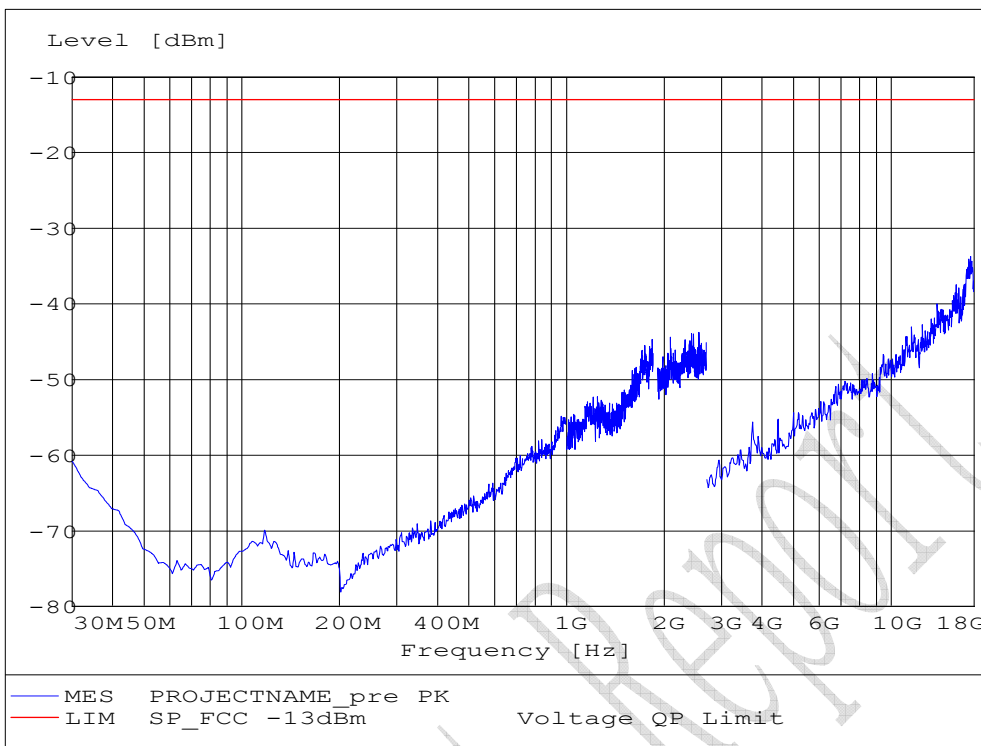

S661VFE

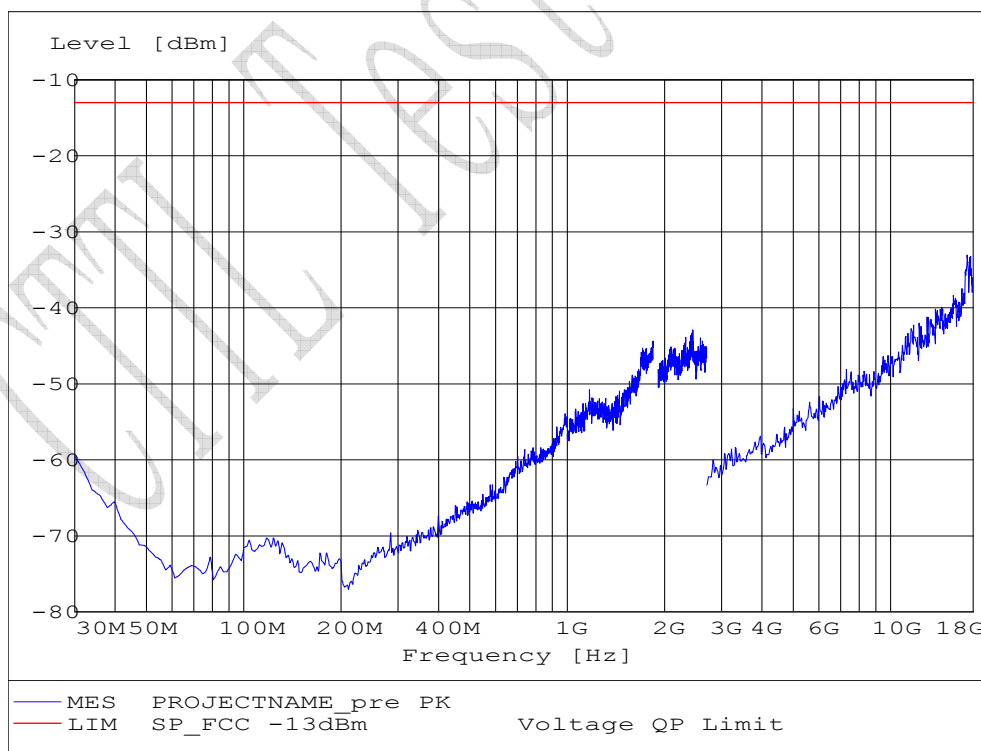

S661VTE

4.2 Radiated RF Power Output

Specifications:	2.1046,24.232,22.913(a)					
Date of Tests	2010.11.14					
Test conditions:	Ambient Temperature:15°C-35°C Relative Humidity:30%-60% Air pressure: 86-106kPa					
Operation Mode	TX on, channel 128, 190, 251, 512, 661 and 810					
Test Results:	Pass					
Test equipment Used:						
Asset Number	Description	Manufacturer	Model Number	Serial Number	Cal Due	State
7805	EMI Test Receiver	R/S	ESI26	100211	2011-01-11	Normal
7330	Ultra Broadband Antenna	R/S	VULB9160	vulb9160-3252	2013-09-06	Normal
7330	Double-Ridged Horn Antenna	R/S	HF906	100037	2011-01-24	Normal
713	Fully-Anechoic Chamber	ETS	11.8m×6.5m×6.3m	--	2013-11-16	Normal
7330	Universal Radio Communications Tester	R/S	CMU200	100233	2011-06-08	Normal

Limit Level Construction:

(a) Radiated RF Power Output
According to Part 24.232(b), i.e., Mobile/portable stations are limited to 2 watts EIRP peak power and the equipment must employ means to limit the power to the minimum necessary for successful communications, so the limit level is 2 W or 33 dBm.

(b) ERP
According to Part 22.913(a), the ERP of mobile transmitters and auxiliary test transmitters must not exceed 7 Watts.

Limits for Radiated RF Power Output

Frequency range	Limit Level (EIRP)/Resolution Bandwidth
TX channel	33dBm/1MHz
Limits for ERP	
Frequency range	Limit Level (ERP)
TX channel	7W

Test Setup:

The EUT was set in an anechoic chamber, see Figure P. In the corner of the chamber there is a communication antenna, which is connected to the CMU 200 located outside the chamber. The test was done using an automated test system, where all test equipments were controlled by a computer.



Figure P

Test Method

- 1 The maximum power was searched by turning the azimuth of the turntable, shifting the polarization of the measuring antenna and changing the pose of the EUT.
- 2 The measured levels are EIRP values corrected in the automated test system with the correction factors given by a substitution calibration made before the measurement. The calibration is made separately for vertical and horizontal polarization and the system uses different correction factors depending on the measuring antenna polarization.
- 3 The corrected maximum levels were reported for EIRP values, and ERP values can be calculated from EIRP values.

Note:

- 1 A fully charged battery was used during the test.
- 2 For GSM 850 MHz band, the ARFCN 128 (824.2 MHz), 190 (836.6 MHz) and 251 (848.8 MHz) are investigated, which are the lowest, middle and highest channel. For PCS 1900 MHz band, the ARFCN 512 (1850.2 MHz), 661 (1880.0 MHz) and 810 (1909.8 MHz) are investigated, which are the lowest, middle and highest channel.
- 3 $ERP\text{ dBm} = EIRP\text{ dBm} - 2.15\text{dB}$.

ERP Value for GSM 850 band mode:

ARFCN	Frequency [MHz]	ERP [dBm]
128	824.23	25.53
190	836.55	28.23
251	848.78	27.03

EIRP Value for PCS 1900 band mode:

ARFCN	Frequency [MHz]	EIRP [dBm]
512	1850.22	26.30
661	1880.08	28.06
810	1909.74	27.90

ERP Value for GPRS 850 band mode:

ARFCN	Frequency [MHz]	ERP [dBm]
128	824.23	24.53
190	836.65	23.37
251	848.88	25.02

EIRP Value for GPRS 1900 band mode:

ARFCN	Frequency [MHz]	EIRP [dBm]
512	1850.02	22.47
661	1879.88	22.51
810	1909.74	24.24

ERP Value for EGPRS 850 band mode:

ARFCN	Frequency [MHz]	ERP [dBm]
128	824.23	28.94
190	836.65	29.60
251	848.88	28.21

EIRP Value for EGPRS 1900 band mode:

ARFCN	Frequency [MHz]	EIRP [dBm]
512	1850.02	26.15
661	1880.08	27.74
810	1909.74	27.90

4.3 Occupied bandwidth

Specifications:	2.1049,22.917(b),24.238(b)					
Date of Test	2010.11.15					
Test conditis:	Ambient Temperature:15°C-35°C Relative Humidity:30%-60% Air pressure: 86-106kPa					
Operation Mode	TX on, channel 128, 190, 251, 512, 661 and 810					
Test Results:	Pass					
Test equipment Used:						
Asset Number	Description	Manufacturer	Model Number	Serial Number	Cal Due	State
7805	EMI Test Receiver	R/S	ESI26	100211	2011-01-11	Normal
7330	Universal Radio Communications Tester	R/S	CMU200	100233	2011-06-08	Normal
---	Power spliter	Jie sai	---	1000132	2011-01-04	Normal

Test Setup

The situation under which maximum EIRP values were found in the measurement of the radiated RF power output was used to determine the 99% occupied bandwidth. The CMU 200 was used to set the TX channel, power level and modulation.

Test Method

The 99% occupied bandwidth was calculated form the spectrum analyzer. Markers in the spectrum analyzer were then placed between the calculated frequencies to show the calculated 99% power band, see screenshots.

Note:

- 1 A fully charged battery was used during the test.
- 2 The ARFCN 128, 190 and 251 for GSM 850 MHz band and 512, 661 and 810 for PCS 1900 MHz band are investigated.

4.3.1 Results for GSM mode:

EUT channel	99% occupied bandwidth [kHz]
128	244.48
190	244.48
251	244.48
512	244.48
661	244.48
810	244.48

FCC Parts 2, 22 and 24
Equipment: Sonim XP3300-A-R1

REPORT NO.: I10GC0567-FCC-Part22

Screenshots:

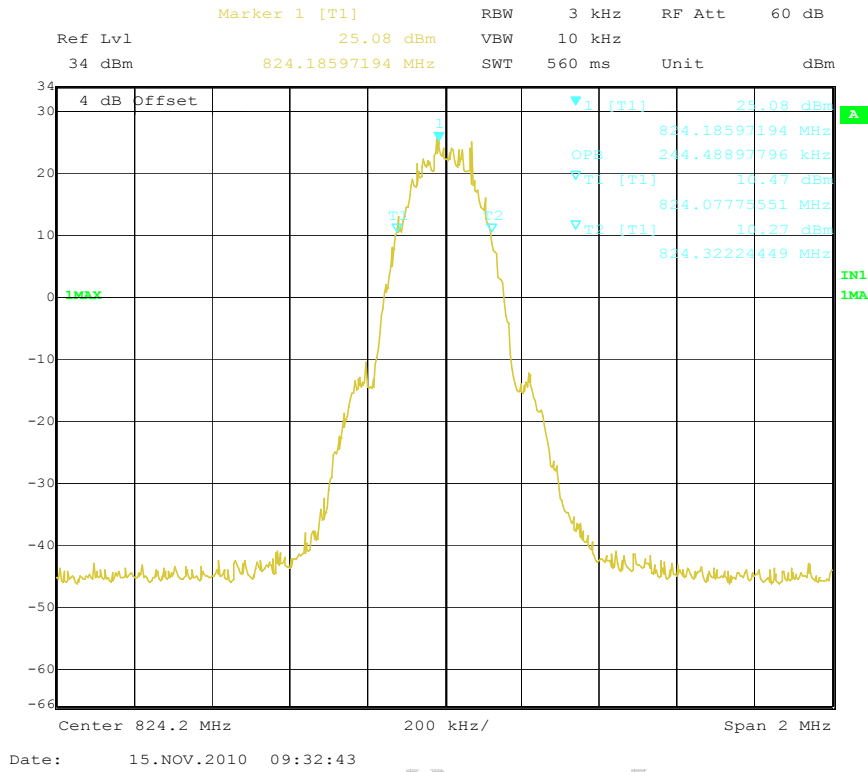

Screenshot 1 Channel 128

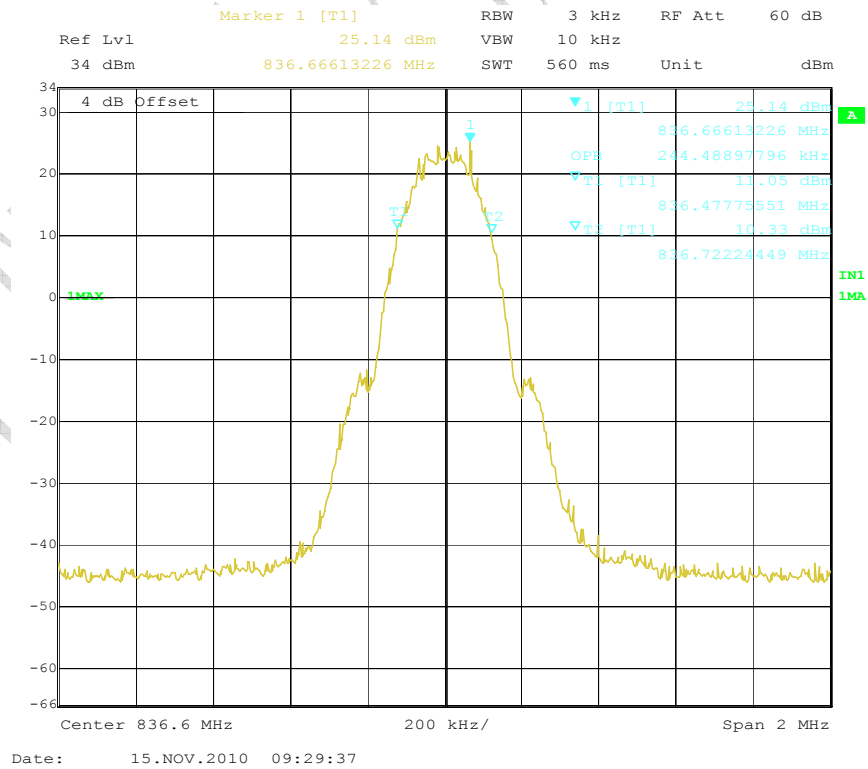

Screenshot 2 Channel 190

FCC Parts 2, 22 and 24
Equipment: Sonim XP3300-A-R1

REPORT NO.: I10GC0567-FCC-Part22

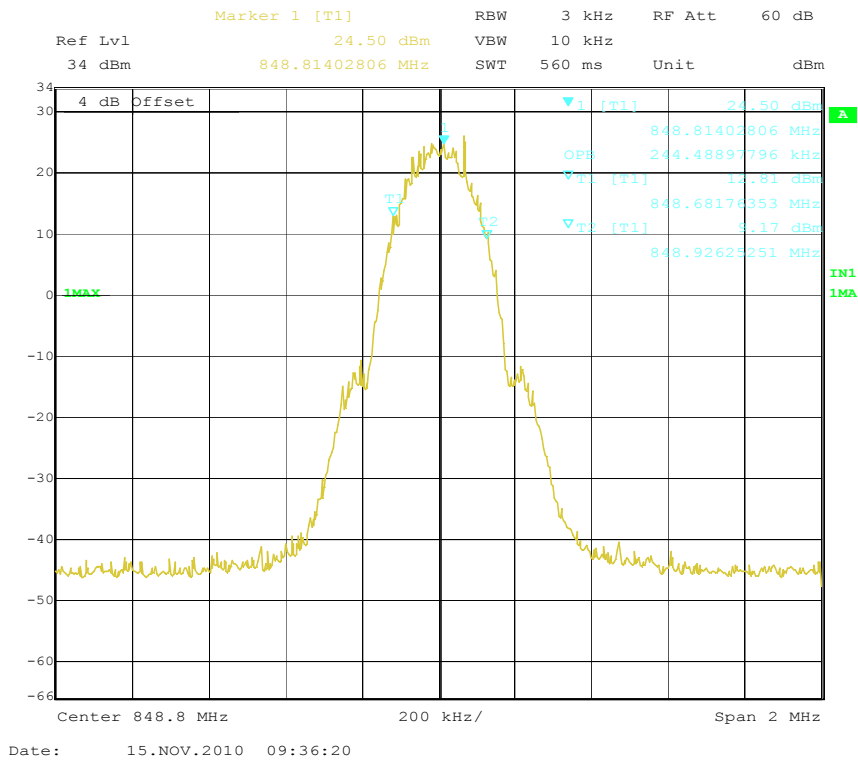

Screenshot 3 Channel 251

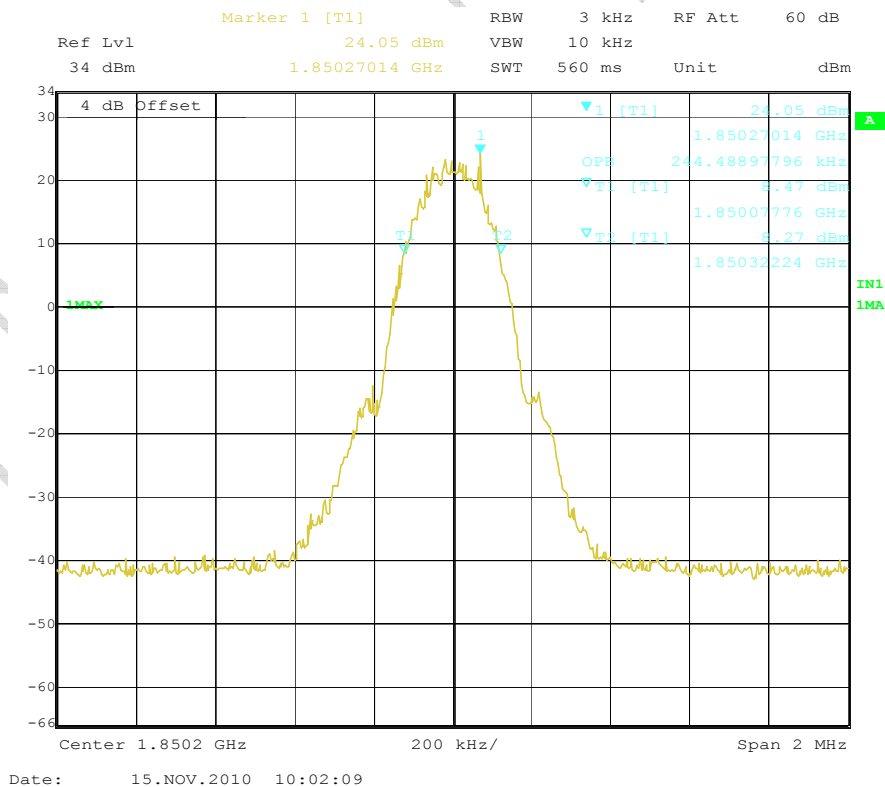

Screenshot 4 Channel 512

FCC Parts 2, 22 and 24
Equipment: Sonim XP3300-A-R1

REPORT NO.: I10GC0567-FCC-Part22

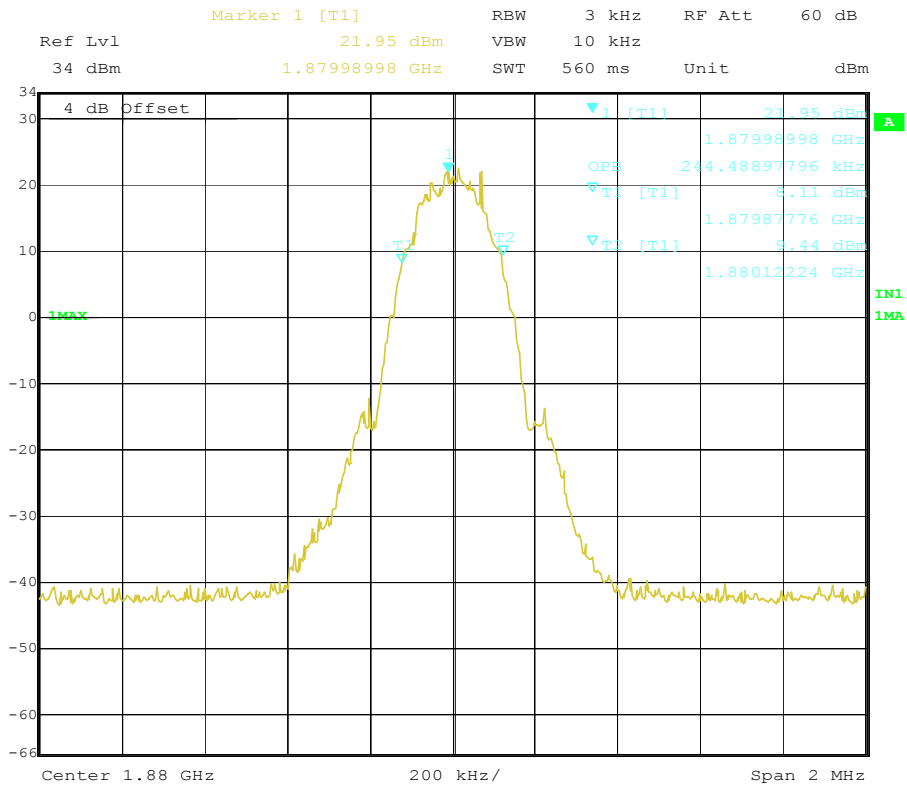

Date: 15.NOV.2010 10:05:49

Screenshot 5 Channel 661

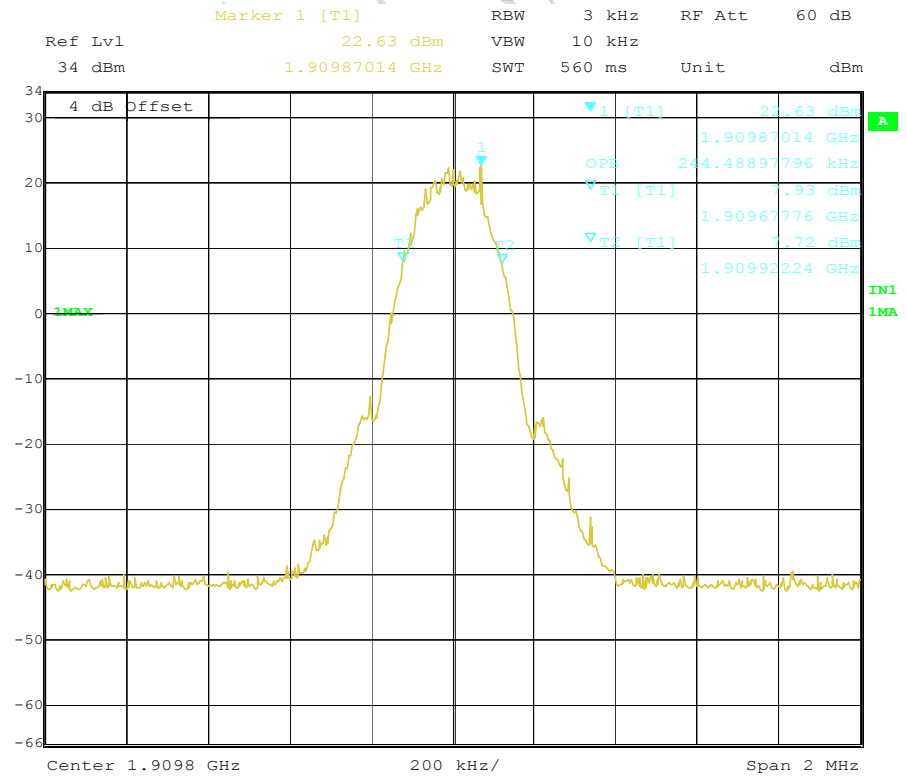

Date: 15.NOV.2010 10:19:04

Screenshot 6 Channel 810

4.3.2 Results for GPRS mode:

EUT channel	99% occupied bandwidth [kHz]
128	244.48
190	240.48
251	244.48
512	244.48
661	244.48
810	244.48

Screenshots:

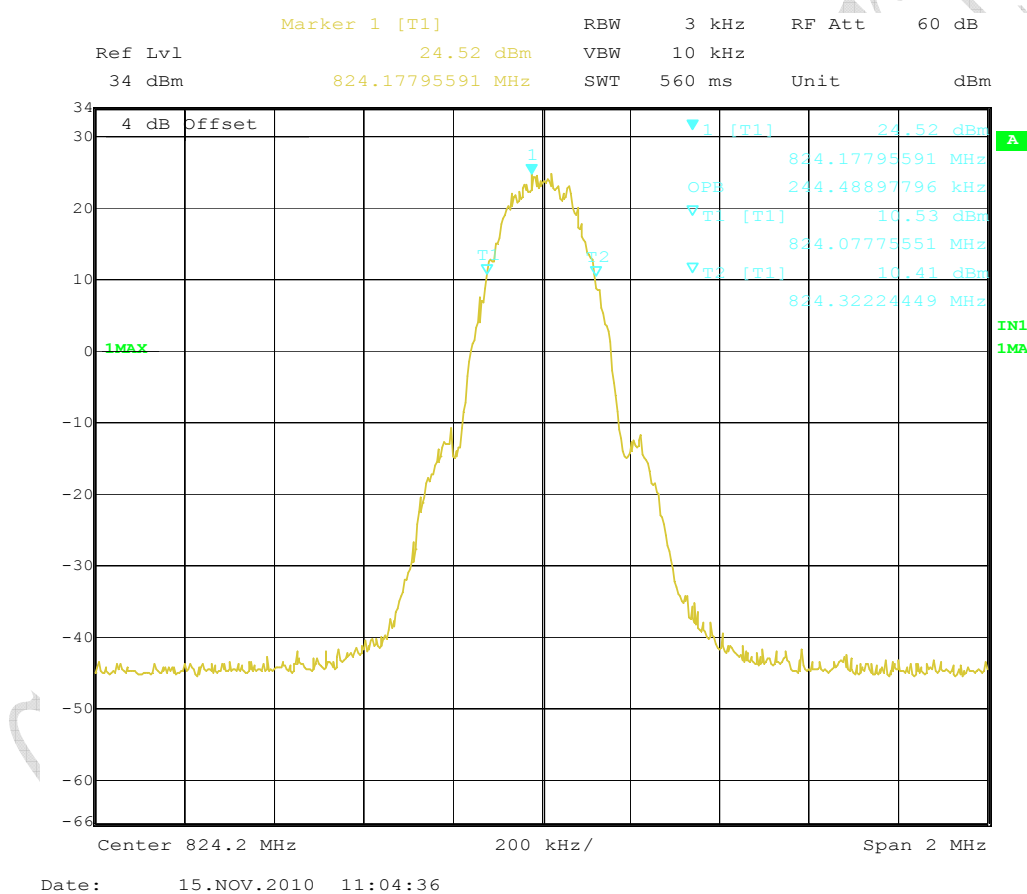

Screenshot 7 Channel 128

FCC Parts 2, 22 and 24
Equipment: Sonim XP3300-A-R1

REPORT NO.: I10GC0567-FCC-Part22

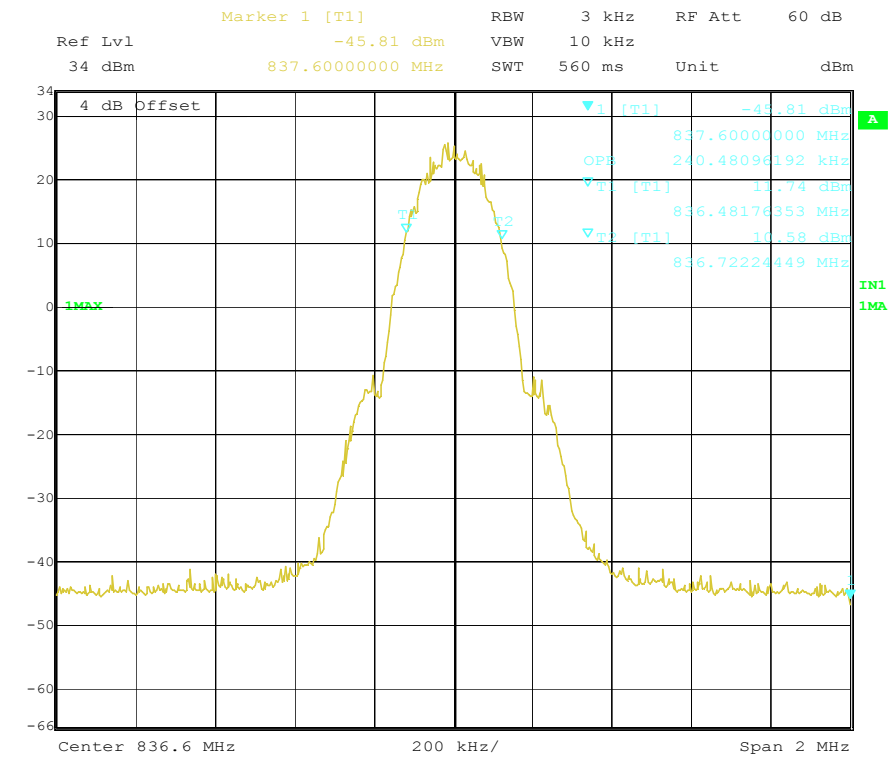

Date: 15.NOV.2010 10:55:03

Screenshot 8 Channel 190

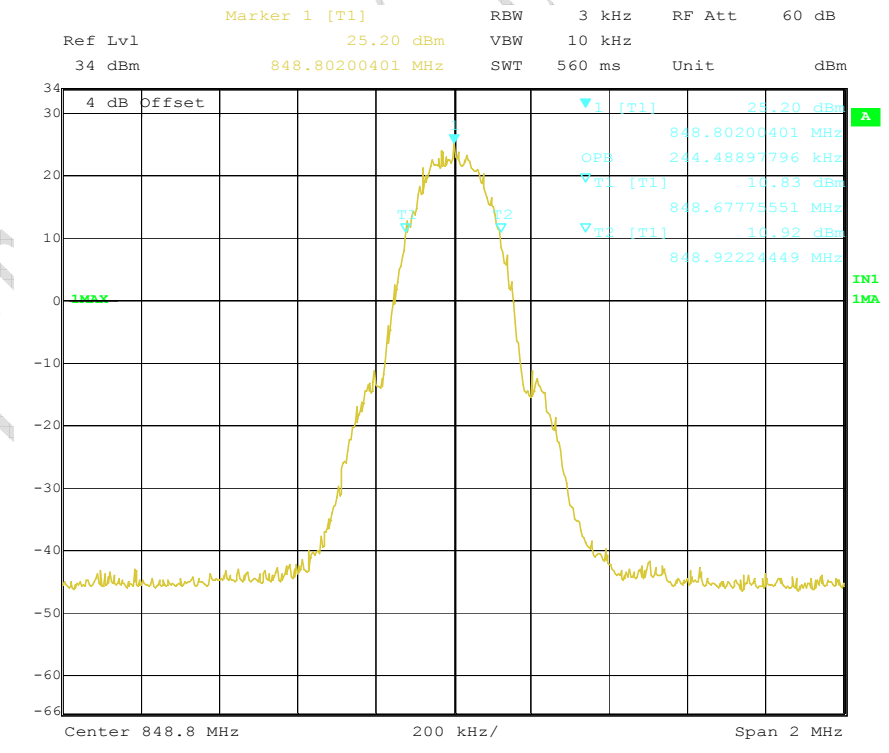

Date: 15.NOV.2010 11:09:49

Screenshot 9 Channel 251

FCC Parts 2, 22 and 24
Equipment: Sonim XP3300-A-R1

REPORT NO.: I10GC0567-FCC-Part22

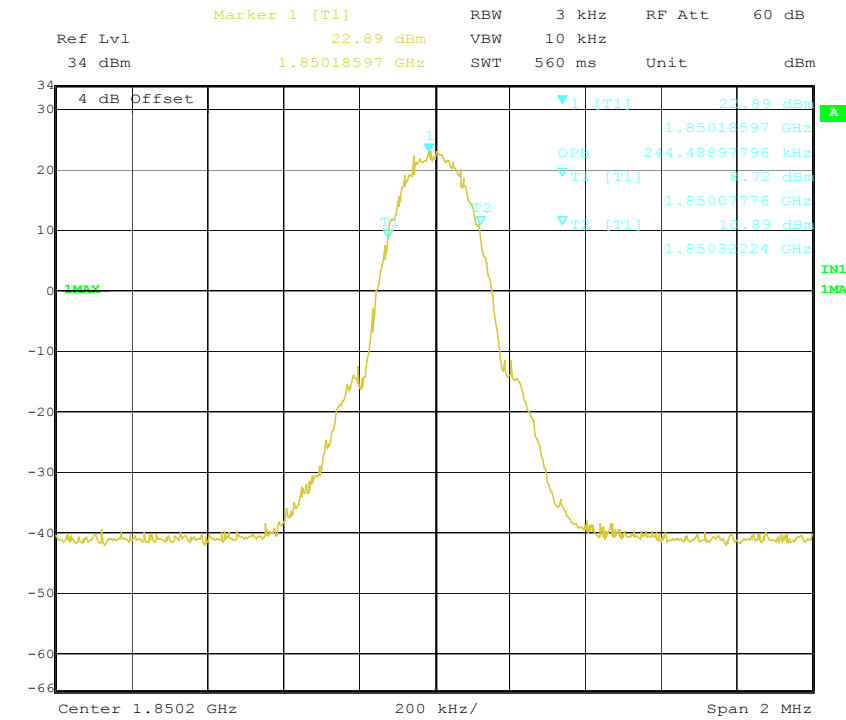

Date: 15.NOV.2010 13:58:53

Screenshot 10 Channel 512

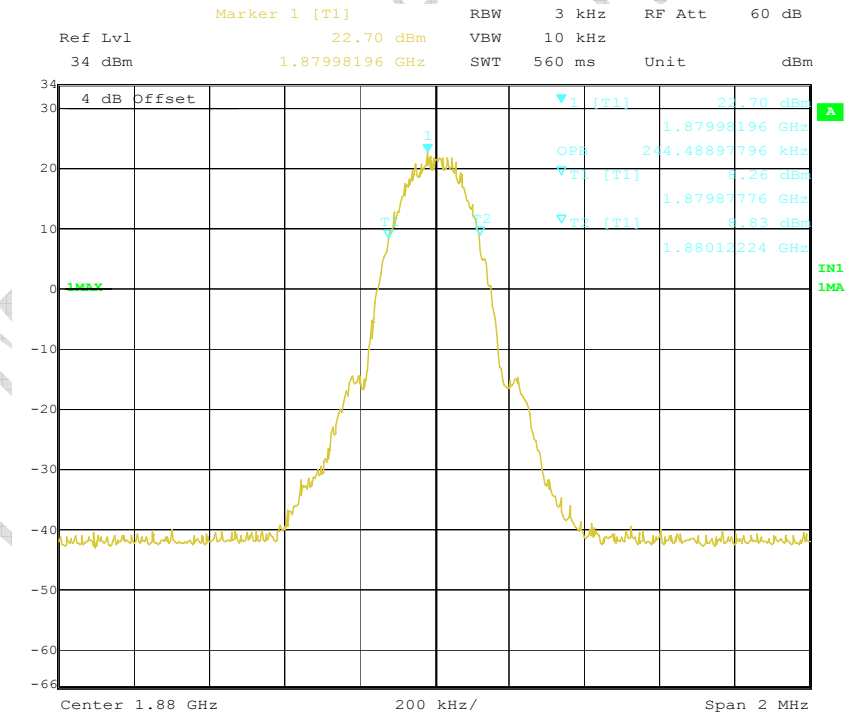

Date: 15.NOV.2010 13:44:18

Screenshot 11 Channel 661

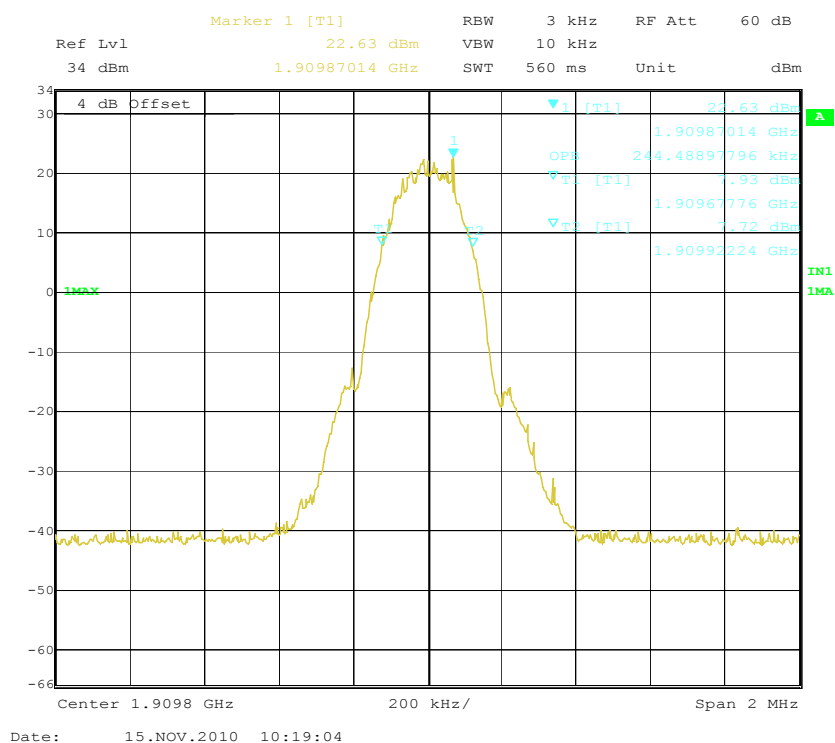

Screenshot 12 Channel 810

4.3.3 Results for EGPRS mode:

EUT channel	99% occupied bandwidth [kHz]
128	244.48
190	244.48
251	244.48
512	244.48
661	244.48
810	244.48

Screenshots:

FCC Parts 2, 22 and 24
Equipment: Sonim XP3300-A-R1

REPORT NO.: I10GC0567-FCC-Part22

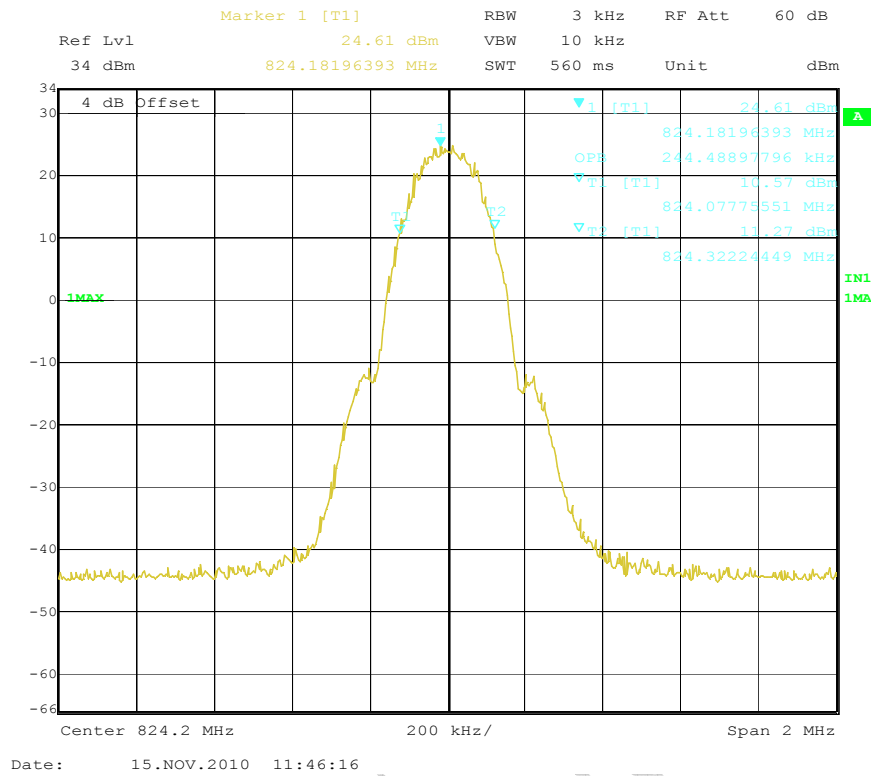

Screenshot 13 Channel 128

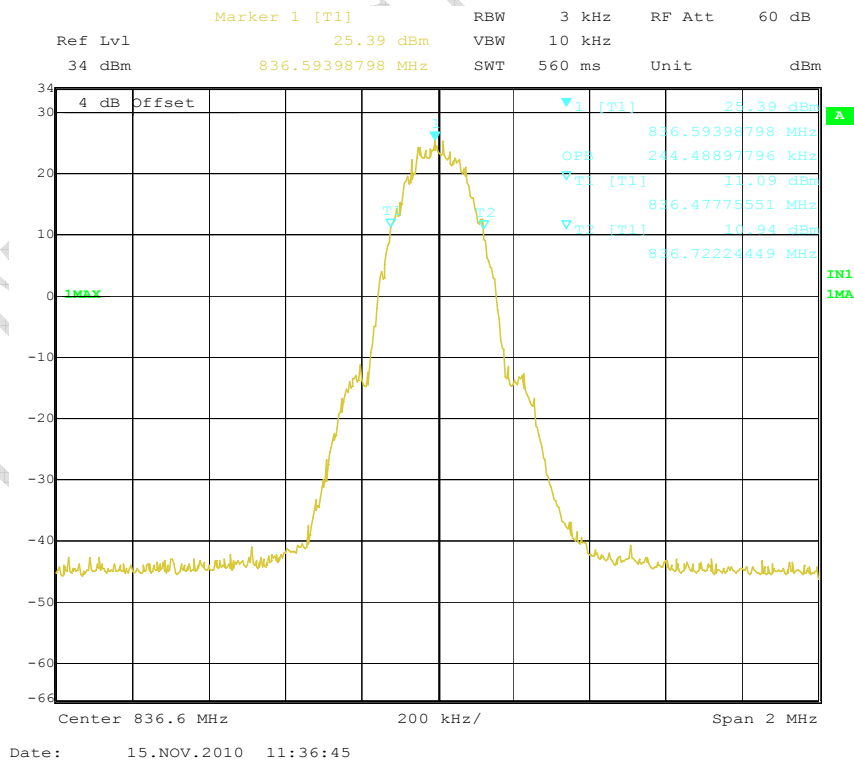

Screenshot 14 Channel 190

FCC Parts 2, 22 and 24
Equipment: Sonim XP3300-A-R1

REPORT NO.: I10GC0567-FCC-Part22

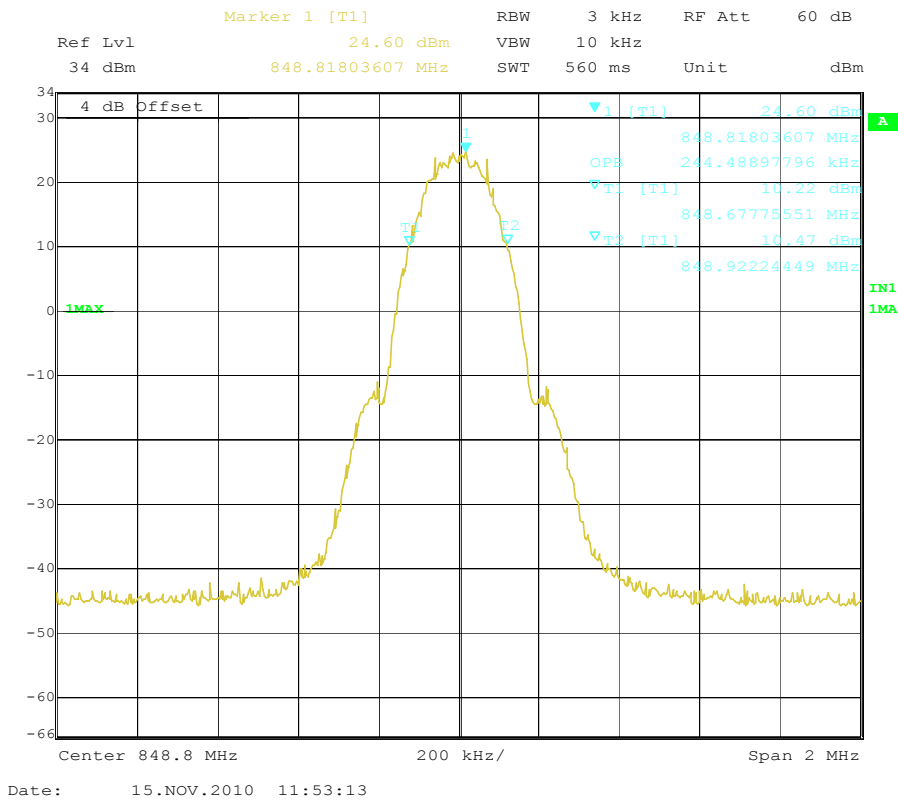

Screenshot 15 Channel 251

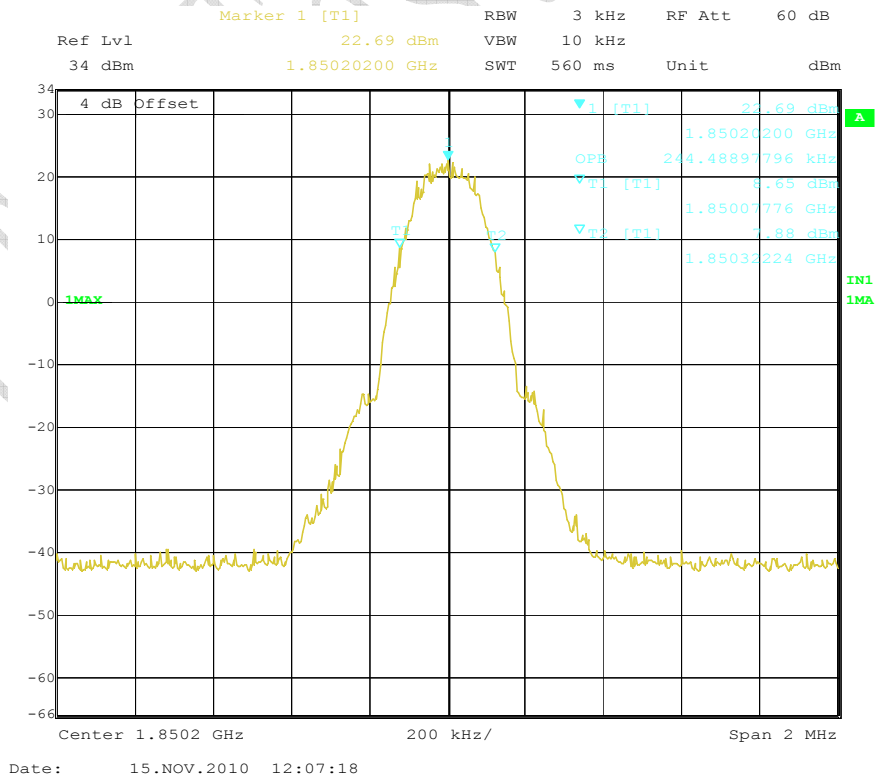

Screenshot 16 Channel 512

FCC Parts 2, 22 and 24
Equipment: Sonim XP3300-A-R1

REPORT NO.: I10GC0567-FCC-Part22

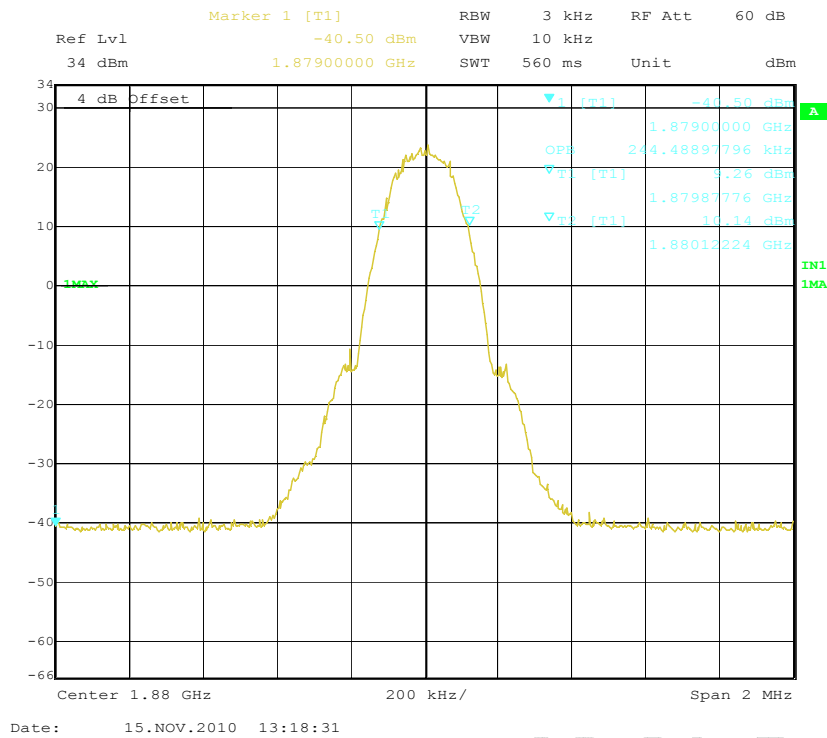

Screenshot 17 Channel 661

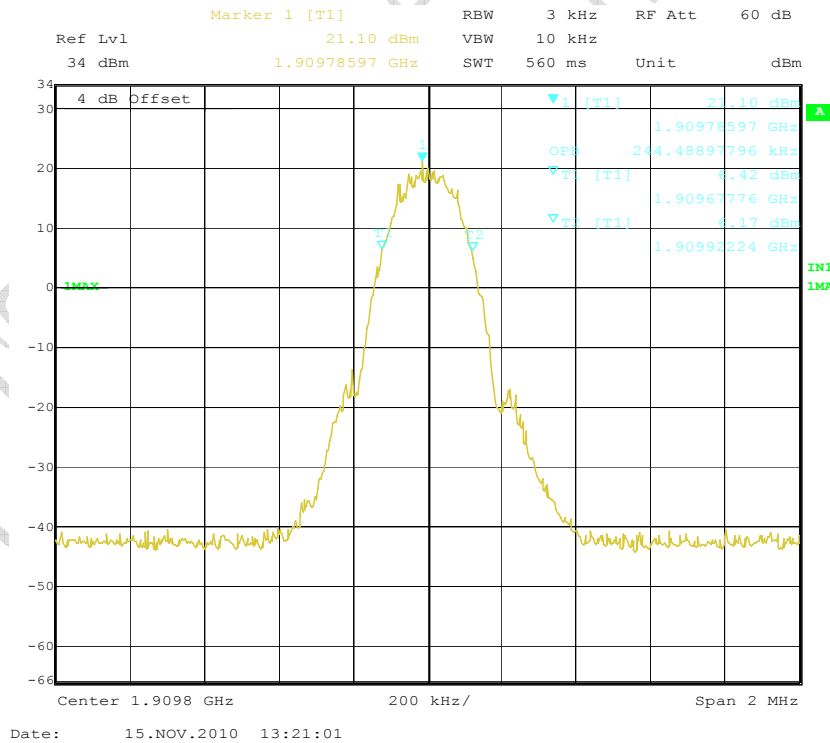

Screenshot 18 Channel 810

4.4 Frequency Stability over Temperature Variation

Specifications:	2.1055,22.355,24.235					
Date of Test	2010.11.15					
Test conditions:	Ambient Temperature:-30°C-50°C Relative Humidity:30%-60% Air pressure: 86-106kPa					
Operation Mode	TX on, channel 190 and 661					
Test Results:	Pass					
Test equipment Used:						
Asset Number	Description	Manufacturer	Model Number	Serial Number	Cal Due	State
7330	Universal Radio Communications Tester	R/S	CMU200	100233	2011-06-08	Normal
7353-2	DC power	Agilent.	66319B	MY43000149	2011-03-03	Normal
Limit						
Frequency deviation [ppm]	±2.5					

Test Setup

The EUT was placed in a temperature chamber, demonstrated as figure T. The CMU 200 was used to set the TX channel and power level, modulate the TX signal with different bit patterns and measure the frequency of TX. A dummy battery powered by a DC power supply is used to provide a constant power source.

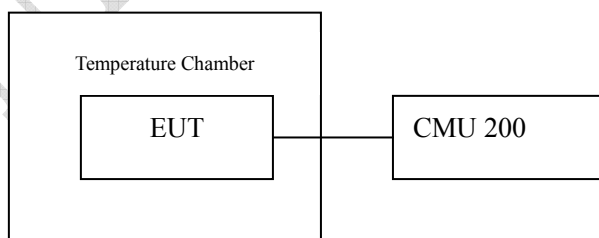

Figure T: setup for measurement of frequency stability over temperature variation

Test Method

1. The EUT was turned off and placed in the temperature chamber.
2. The temperature of the chamber was set to -30°C and allowed to stabilize.
3. The EUT temperature was allowed to stabilize for 45 minutes.

4. The EUT was turned on and set to transmit with CMU 200.
5. The maximum transmit frequency deviation during one minute period was measured by CMU 200.
6. The steps 3-5 were repeated for -20°C, -10°C, 0°C, 10°C, 20°C, 30°C, 40°C and 50°C.

4.4.1 Test results for GSM mode

The frequency deviation from the centre frequency over temperature variation is showed as table T1 and T2 for channel 190 and 661 respectively.

Table T1: frequency deviation from the centre frequency over temperature variation for channel 190

Temperature[°C]	Deviation[Hz]	Deviation[ppm]	Remarks
-30	2	0.00	Pass
-20	-1	0.00	Pass
-10	-1	0.00	Pass
0	-5	-0.01	Pass
10	-7	-0.01	Pass
20	-8	-0.01	Pass
30	-12	-0.01	Pass
40	-15	-0.02	Pass
50	-20	-0.02	Pass

Table T2: frequency deviation from the centre frequency over temperature variation for channel 661

Temperature[°C]	Deviation[Hz]	Deviation[ppm]	Remarks
-30	45	0.05	Pass
-20	38	0.05	Pass
-10	35	0.04	Pass
0	33	0.04	Pass
10	29	0.03	Pass
20	19	0.02	Pass
30	14	0.02	Pass
40	8	0.01	Pass
50	6	0.01	Pass

4.4.2 Test results for GPRS mode

The frequency deviation from the centre frequency over temperature variation is showed as table T3 and T4 for channel 190 and 661 respectively.

Table T3: frequency deviation from the centre frequency over temperature

variation for channel 190

Temperature[°C]	Deviation[Hz]	Deviation[ppm]	Remarks
-30	-9	-0.01	Pass
-20	-4	0.00	Pass
-10	6	0.01	Pass
0	3	0.00	Pass
10	-2	0.00	Pass
20	-7	-0.01	Pass
30	-13	-0.02	Pass
40	-18	-0.02	Pass
50	-25	-0.03	Pass

Table T4: frequency deviation from the centre frequency over temperature variation for channel 661

Temperature[°C]	Deviation[Hz]	Deviation[ppm]	Remarks
-30	37	0.04	Pass
-20	41	0.05	Pass
-10	45	0.05	Pass
0	51	0.06	Pass
10	58	0.07	Pass
20	61	0.07	Pass
30	13	-0.02	Pass
40	6	0.01	Pass
50	-5	-0.01	Pass

4.4.3 Test results for EGPRS mode

The frequency deviation from the centre frequency over temperature variation is showed as table T3 and T4 for channel 190 and 661 respectively.

Table T3: frequency deviation from the centre frequency over temperature variation for channel 190

Temperature[°C]	Deviation[Hz]	Deviation[ppm]	Remarks
-30	11	0.04	Pass
-20	8	0.05	Pass
-10	6	0.05	Pass
0	-1	0.06	Pass
10	-7	0.07	Pass
20	-14	0.07	Pass
30	-17	0.02	Pass
40	-22	0.01	Pass
50	-27	-0.01	Pass

Table T4: frequency deviation from the centre frequency over temperature

variation for channel 661

Temperature[°C]	Deviation[Hz]	Deviation[ppm]	Remarks
-30	18	0.04	Pass
-20	57	0.05	Pass
-10	53	0.05	Pass
0	51	0.06	Pass
10	45	0.07	Pass
20	39	0.07	Pass
30	23	0.02	Pass
40	3	0.01	Pass
50	-11	-0.01	Pass

TTL Test Report

4.5 Frequency Stability over Voltage Variation

Specifications:	2.1055,22.355,24.235					
Date of Test	2010.11.15					
Test conditions:	Ambient Temperature: 15°C-35°C Relative Humidity: 30%-60% Air pressure: 86-106kPa					
Operation Mode	TX on, channel 190 and 661					
Test Results:	Pass					
Test equipment Used:						
Asset Number	Description	Manufacturer	Model Number	Serial Number	Cal Due	State
7330	Universal Radio Communication s Tester	R/S	CMU200	100233	2011-06-08	7330
7353-2	DC power	Agilent.	66319B	MY43000149	2011-03-03	Normal
Limit						
Frequency deviation [ppm]	±2.5					

Test Setup

The EUT was placed in a shielding chamber and powered by an adjustable DC power supply, demonstrated as figure V. The CMU 200 was used to set the TX channel and power level, modulate the TX signal with different bit patterns and measure the frequency of TX.

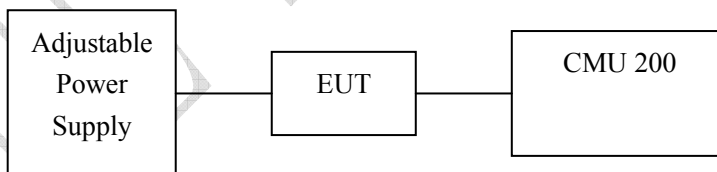

Figure V: test setup for measurement of frequency stability over voltage variation

Test Method

The EUT battery was replaced with an adjustable DC power supply. The frequency stability measured at nominal voltage and at the cut-off point.

Test Results for GSM mode:

The frequency deviation from the centre frequency over voltage variation is showed as table V1 and V2 for channel 190 and 661 respectively.

Table V1: frequency deviation from the centre frequency over temperature variation for channel 190

Level	Voltage[V]	Deviation[Hz]	Deviation[ppm]	Remarks
Nominal	3.7	7	0.01	Pass
Cut-off point	3.3	-11	-0.01	Pass

Table V2: frequency deviation from the centre frequency over temperature variation for channel 661

Level	Voltage[V]	Deviation[Hz]	Deviation[ppm]	Remarks
Nominal	3.7	15	0.02	Pass
Cut-off point	3.4	21	0.03	Pass

Test Results for GPRS mode:

The frequency deviation from the centre frequency over voltage variation is showed as table V3 and V4 for channel 190 and 661 respectively.

Table V3: frequency deviation from the centre frequency over temperature variation for 190

Level	Voltage[V]	Deviation[Hz]	Deviation[ppm]	Remarks
Nominal	3.7	-7	-0.01	Pass
Cut-off point	3.3	-10	-0.01	Pass

Table V4: frequency deviation from the centre frequency over temperature variation for 661

Level	Voltage[V]	Deviation[Hz]	Deviation[ppm]	Remarks
Nominal	3.7	54	0.06	Pass
Cut-off point	3.4	57	0.07	Pass

Test Results for EGPRS mode:

The frequency deviation from the centre frequency over voltage variation is showed as table V3 and V4 for channel 190 and 661 respectively.

Table V3: frequency deviation from the centre frequency over temperature variation for 190

FCC Parts 2, 22 and 24
Equipment: Sonim XP3300-A-R1

REPORT NO.: I10GC0567-FCC-Part22

Level	Voltage[V]	Deviation[Hz]	Deviation[ppm]	Remarks
Nominal	3.7	-7	-0.01	Pass
Cut-off point	3.3	-10	-0.01	Pass

Table V4: frequency deviation from the centre frequency over temperature variation for 661

Level	Voltage[V]	Deviation[Hz]	Deviation[ppm]	Remarks
Nominal	3.7	54	0.06	Pass
Cut-off point	3.4	57	0.07	Pass

TTL Test Report

4.6 Conducted RF Power Output

Specifications:	2.1046,22.913(a),24.232(c)					
Date of Tests	2010.11.15					
Test conditions:	Ambient Temperature:15°C-35°C Relative Humidity:30%-60% Air pressure: 86-106kPa					
Operation Mode	TX on, channel 128, 190, 251, 512, 661 and 810					
Test Results:	Pass					
Test equipment Used:						
Asset Number	Description	Manufacturer	Model Number	Serial Number	Cal Due	State
7805	EMI Test Receiver	R/S	ESI26	100211	2011-01-11	Normal
7330	Universal Radio Communications Tester	R/S	CMU200	100233	2011-06-08	Normal
---	Power splitter	Jie sai	---	1000132	2011-01-04	Normal

Limits for conducted RF Power Output	
Frequency range	Nominal Peak output power(dBm)
TX channel	30dBm/1MHz

Test Setup:

During the process of testing, the EUT was controlled via Rhode & Schwarz Digital Radio Communication tester (CMU-200) to ensure max power transmission and proper modulation and measured by Rhode & Schwarz EMI test receiver (ESI26)

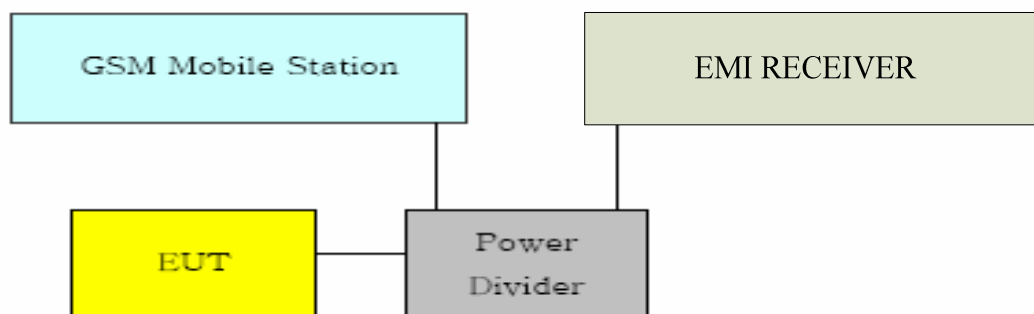

Test Method

1) The EUT was coupled to the EMI and the base station simulator through a power divider. The radio frequency load attached to the EUT antenna terminal

was 50 Ohm. The rest of the cables the test system is calibrated to correct the reading.

2) The spectrum analyzer was set to Maxpeak Detector function and Maximum hold mode.

3) The resolution bandwidth of the spectrum analyzer was comparable to the emission bandwidth.

In GSM 850 band these measurements were done at 3 channels, channel 128, 190 and 251.

In GSM 1900 band these measurements were done at 3 channels, channel 512, 661 and 810.

Note:

1 A fully charged battery was used during the test.

2 For GSM 850 MHz band, the ARFCN 128 (824.2 MHz), 190 (836.6 MHz) and 251 (848.8 MHz) are investigated, which are the lowest, middle and highest channel. For PCS 1900 MHz band, the ARFCN 512 (1850.2 MHz), 661 (1880.0 MHz) and 810 (1909.8 MHz) are investigated, which are the lowest, middle and highest channel.

Value for GSM 850 band mode:

ARFCN	Peak output power [dBm]
128	31.23
190	31.40
251	31.34

Value for PCS 1900 band mode:

ARFCN	Peak output power [dBm]
512	29.09
661	27.85
810	28.71

Value for GPRS 850 band mode:

ARFCN	Peak output power [dBm]
128	31.11
190	30.99
251	31.22

Value for GPRS 1900 band mode:

ARFCN	Peak output power [dBm]
512	29.75
661	27.58
810	28.75

Value for EGPRS 850 band mode:

ARFCN	Peak output power [dBm]
128	31.47
190	31.47
251	31.66

Value for EGPRS 1900 band mode:

ARFCN	Peak output power [dBm]
512	27.03
661	27.68
810	26.98

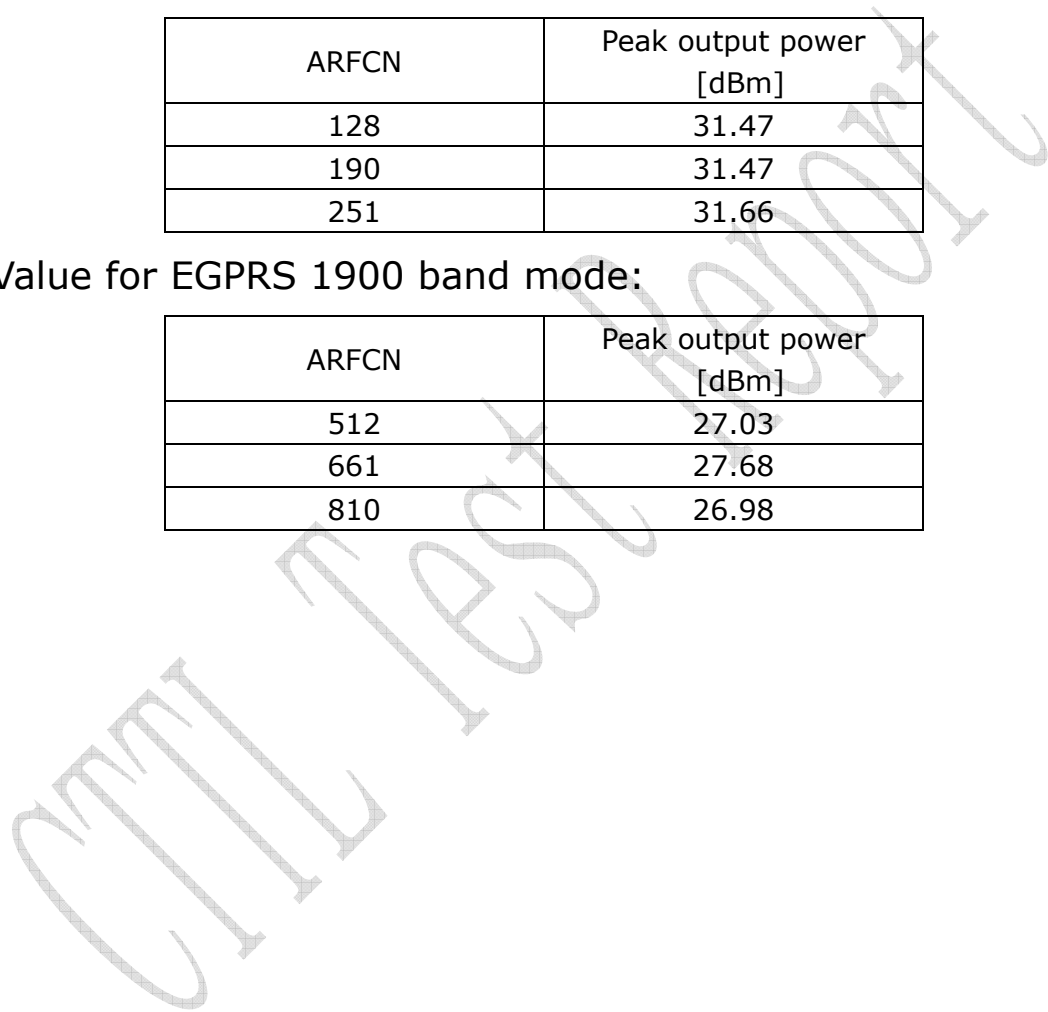

4.7 Conducted Spurious Emission

Specifications:	2.1057,22.359,24.238					
Date of Tests	2010.11.16					
Test conditions:	Ambient Temperature:15°C-35°C Relative Humidity:30%-60% Air pressure: 86-106kPa					
Operation Mode	TX on, channel 128, 190, 251, 512, 661 and 810					
Test Results:	Pass					
Test equipment Used:						
Asset Number	Description	Manufacturer	Model Number	Serial Number	Cal Due	State
7805	EMI Test Receiver	R/S	ESI26	100211	2011-01-11	Normal
7330	Universal Radio Communications Tester	R/S	CMU200	100233	2011-06-08	Normal
---	Power splitter	Jie sai	---	1000132	2011-01-04	Normal

Limit Level Construction:

According to Part 24.238 (a), i.e., Out of band emissions. The power of any emission outside of the authorized operating frequency ranges must be attenuated below the transmitting power (P) by a factor of at least $43 + 10 \log(P)$ dB, so the limit level is:
 $P(\text{dBm}) - (43 + 10 \log(P)) \text{ dB} = -13\text{dBm}$

Limits for Radiated spurious emissions(UE)

Frequency range	Limit Level /Resolution Bandwidth
30 MHz to 20000 MHz	-13dBm/1MHz

Test Setup:

During the process of testing, the EUT was controlled via Rhode & Schwarz Digital Radio Communication tester (CMU-200) to ensure max power transmission and proper modulation and measured by Rhode & Schwarz EMI test receiver (ESI26)

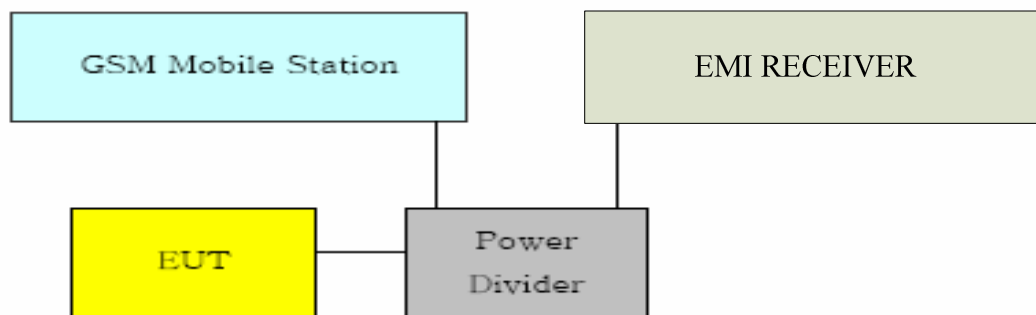

Test Method

The following steps outline the procedure used to measure the conducted emissions from the EUT.

1. Determine frequency range for measurements: From CFR 2.1057 the spectrum should be investigated from the lowest radio frequency generated in the equipment up to at least the 10th harmonic of the carrier frequency. For the equipment under test, this equates to a frequency range of 30 MHz to 19.1 GHz, data taken from 30 MHz to 20 GHz.
2. Determine EUT transmit frequencies: below outlines the band edge frequencies pertinent to conducted emissions testing.

In GSM 850 band these measurements were done at 3 channels, channel 128, 190 and 251.

In GSM 1900 band these measurements were done at 3 channels, channel 512, 661 and 810.

Note:

- 1 A fully charged battery was used during the test.
- 2 For GSM 850 MHz band, the ARFCN 128 (824.2 MHz), 190 (836.6 MHz) and 251 (848.8 MHz) are investigated, which are the lowest, middle and highest channel. For PCS 1900 MHz band, the ARFCN 512 (1850.2 MHz), 661 (1880.0 MHz) and 810 (1909.8 MHz) are investigated, which are the lowest, middle and highest channel.

Test Results for GSM mode:

Out of band emission	
Frequency [MHz]	Level (dBm)
--	--

Test Results for GPRS mode:

Out of band emission	
Frequency [MHz]	Level (dBm)
--	--

Test Results for EGPRS mode:

Out of band emission	
Frequency [MHz]	Level (dBm)
--	--

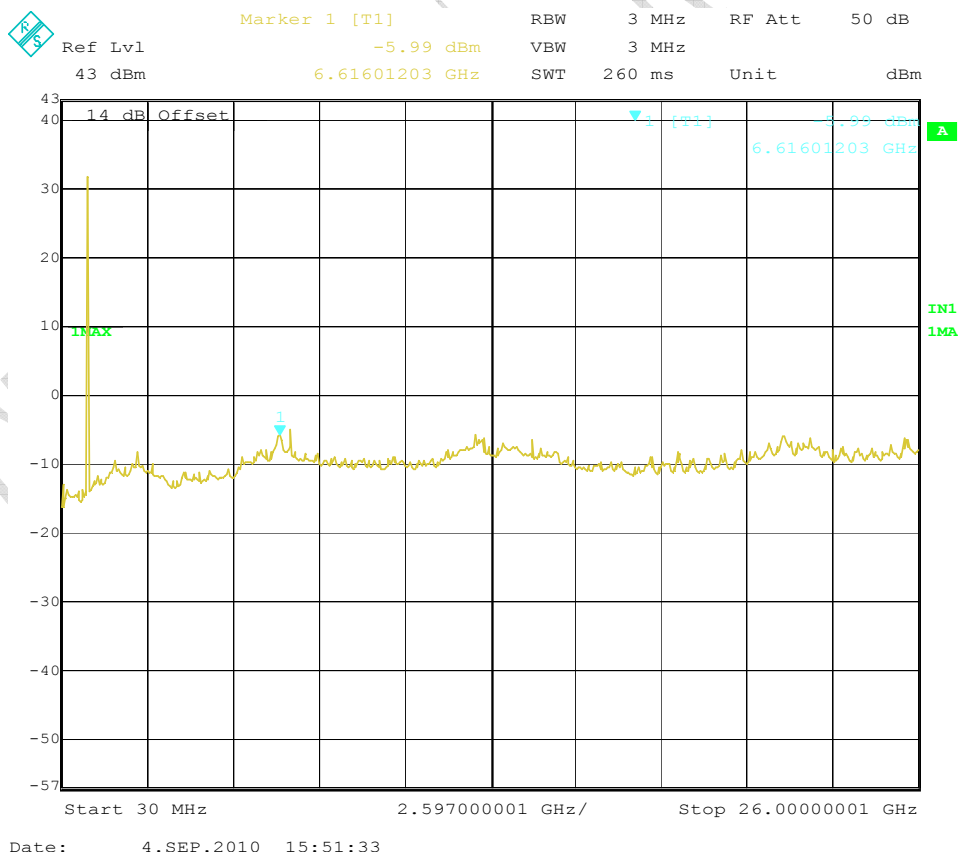

Note: The peak power is in mobile phone transmission band.
GSM

FCC Parts 2, 22 and 24
Equipment: Sonim XP3300-A-R1

REPORT NO.: I10GC0567-FCC-Part22

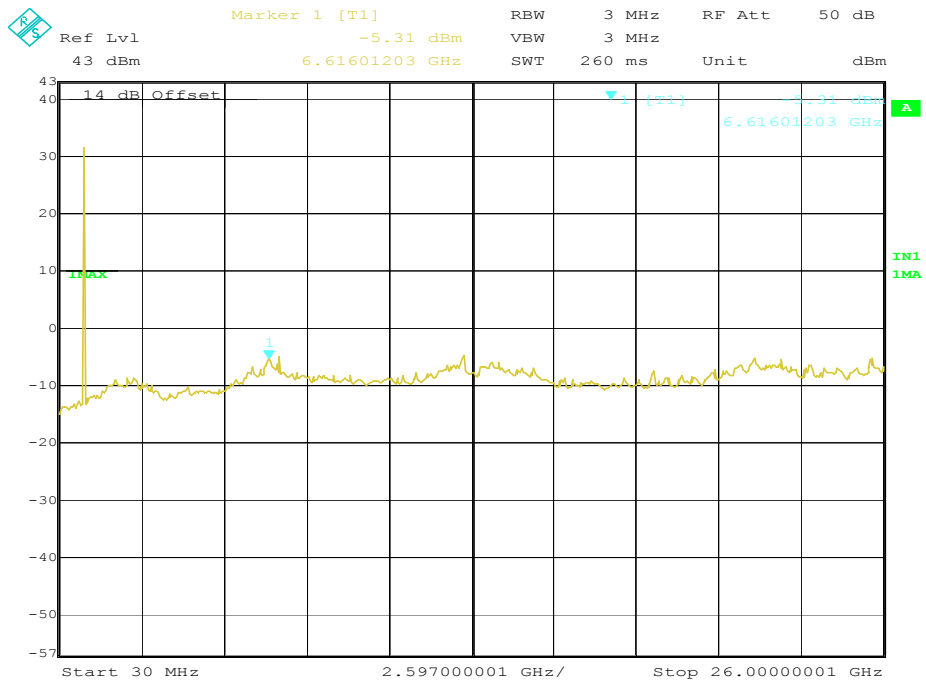

Date: 4.SEP.2010 15:49:40

Note: The peak power is in mobile phone transmission band.

GPRS

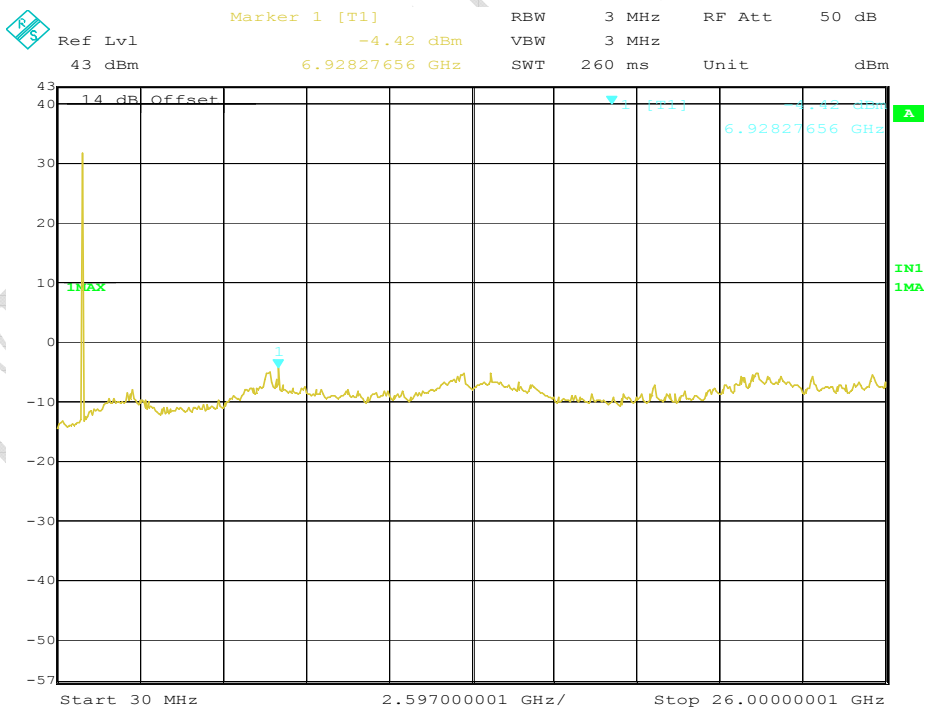

Date: 4.SEP.2010 16:03:29

Note: The peak power is in mobile phone transmission band.

EGPRS

4.8 Band-edge (conducted)

Specifications:	2.1051, 24.238, 2.1053, 22.917
Date of Tests	2010-11-15
Test conditions:	Ambient Temperature:15°C-35°C Relative Humidity:30%-60% Air pressure: 86-106kPa
Operation Mode	TX on
Test Results:	Pass

Test equipment Used:

Asset Number	Description	Manufacturer	Model Number	Serial Number	Cal Due	State
7805	EMI Test Receiver	R/S	ESI26	100211	2011-01-11	Normal
7330	Universal Radio Communications Tester	R/S	CMU200	100233	2011-06-08	Normal
---	Power splitter	Jie sai	---	1000132	2011-01-04	Normal

Limit Level Construction:

According to Part 24.238 (a), i.e., Out of band emissions. The power of any emission outside of the authorized operating frequency ranges must be attenuated below the transmitting power (P) by a factor of at least $43 + 10 \log(P)$ dB, so the limit level is:
 $P(\text{dBm}) - (43 + 10 \log(P)) \text{ dB} = -13\text{dBm}$

Limits for Radiated spurious emissions

Frequency range	Limit Level
Band edge	-13dBm

Test Setup:

During the test, the EUT was controlled via the Wireless Communications Test Set to ensure max power transmission and proper modulation and measured by spectrum analyzer.

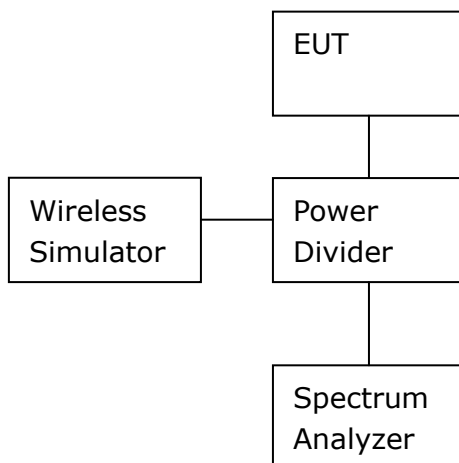

Test Method

- 1) The EUT was coupled to the EMI test receiver analyzer mode and the base station simulator through a power divider. The lost of the cables the test system is calibrated to correct the readings.
- 2) The spectrum analyzer was set to Maxpeak Detector function and Maximum hold mode.
- 3) The resolution bandwidth of the spectrum analyzer was a little greater than 1% of the 26dB emission bandwidth.

Note: --

Test Results:

band-edge emission for GSM

Band-edge emission		
EUT Channel	Frequency [MHz]	Level [dBm]
128 left band edge	824.0056	-13.23
251 right band edge	848.9984	-14.02

Band-edge emission		
EUT Channel	Frequency [MHz]	Level [dBm]
512 left band edge	1850.0016	-17.15
810 right band edge	1910.0024	-16.91

band-edge emission for GPRS

Band-edge emission		
EUT Channel	Frequency [MHz]	Level [dBm]
128 left band edge	823.9895	-14.11
251 right band edge	848.9984	-14.73

Band-edge emission		
EUT Channel	Frequency [MHz]	Level [dBm]
512 left band edge	1850.0016	-16.83
810 right band edge	1909.9984	-15.71

band-edge emission for EGPRS

Band-edge emission		
EUT Channel	Frequency [MHz]	Level [dBm]
128 left band edge	824.0056	-14.90
251 right band edge	849.0024	-14.28

Band-edge emission		
EUT Channel	Frequency [MHz]	Level [dBm]
512 left band edge	1850.0016	-16.17
810 right band edge	1910.0024	-18.18

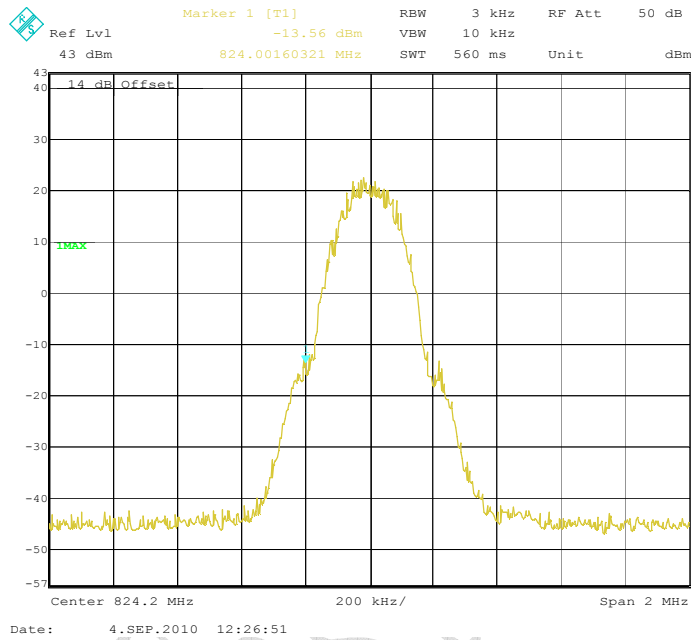

Channel 128 Left band edge (GSM)

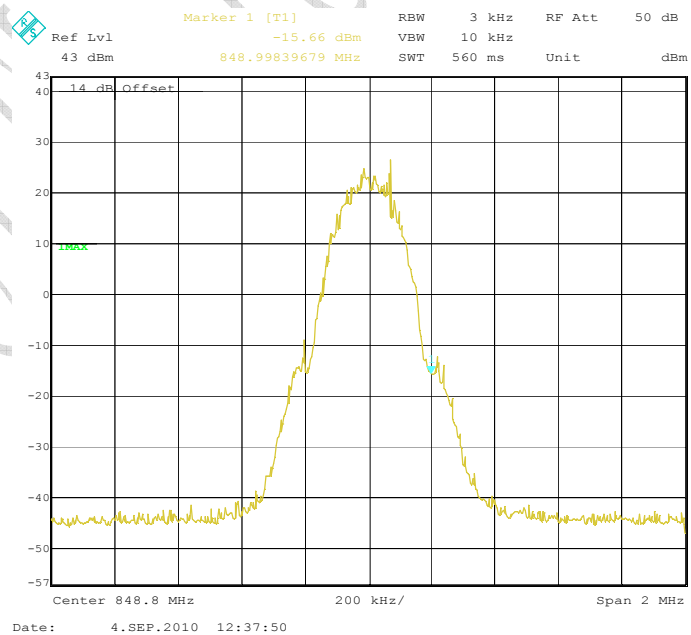

Channel 251 Left band edge (GSM)

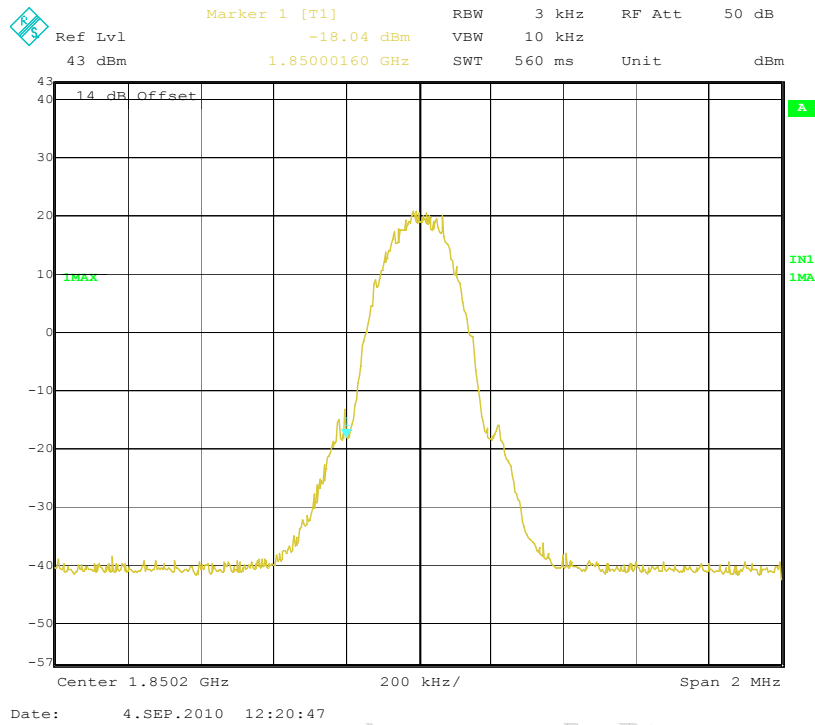

Channel 512 Left band edge (GSM)

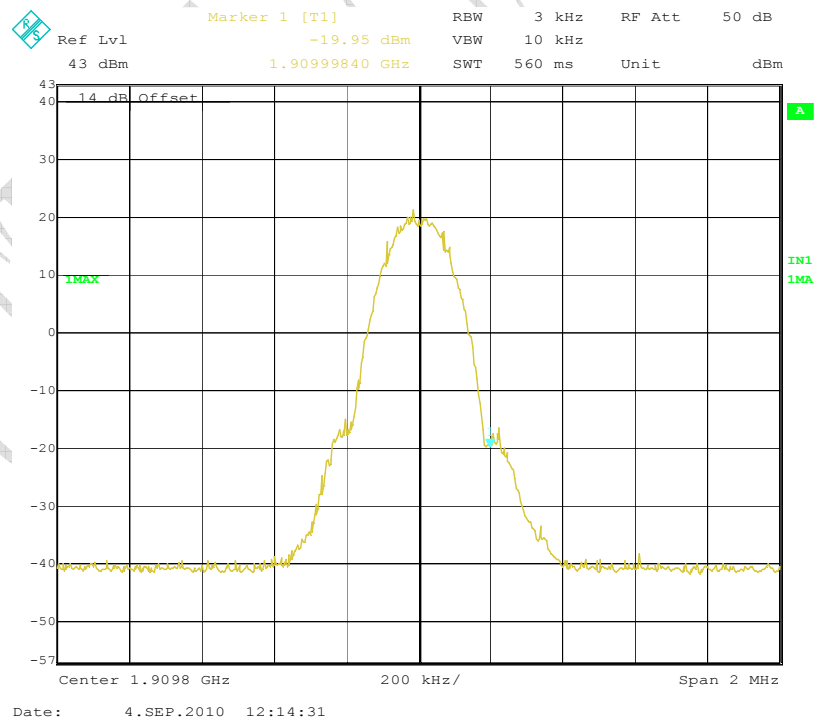

Channel 810 Left band edge (GSM)

FCC Parts 2, 22 and 24
Equipment: Sonim XP3300-A-R1

REPORT NO.: I10GC0567-FCC-Part22

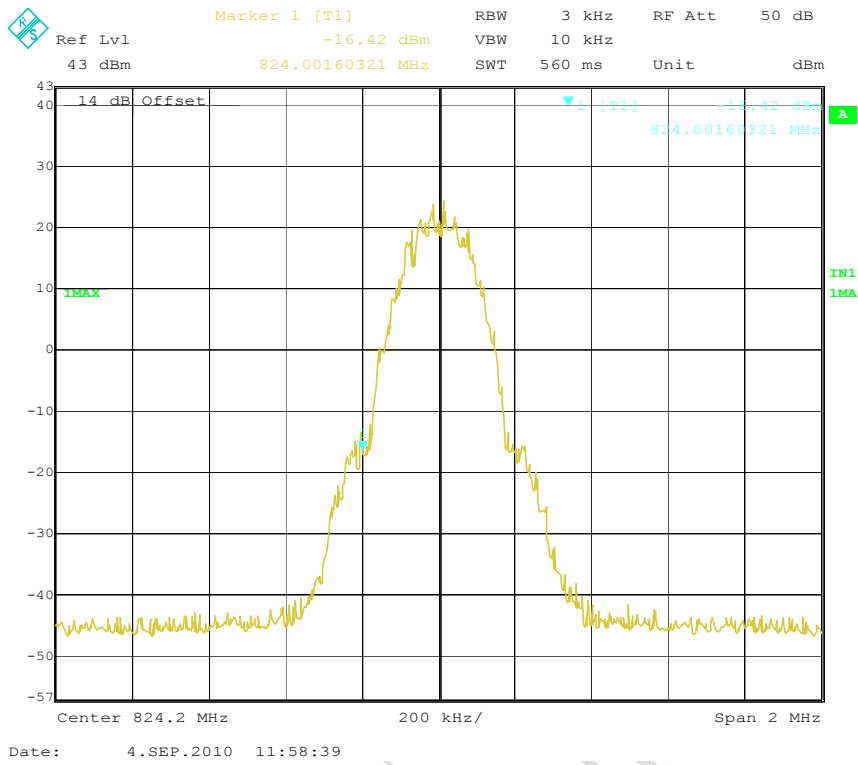

Channel 128 Left band edge (GPRS)

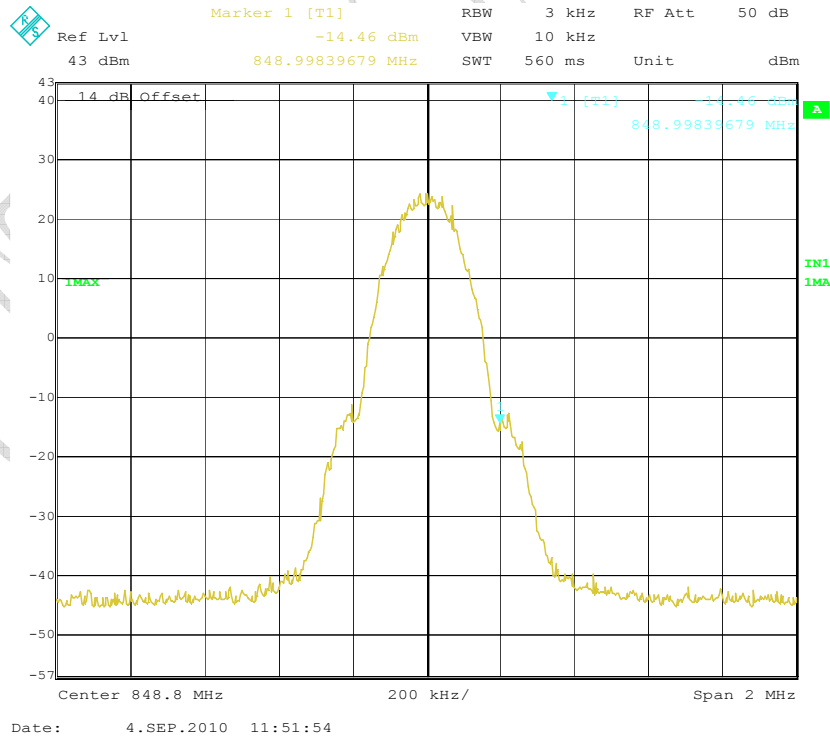

Channel 251 Left band edge (GPRS)

FCC Parts 2, 22 and 24
Equipment: Sonim XP3300-A-R1

REPORT NO.: I10GC0567-FCC-Part22

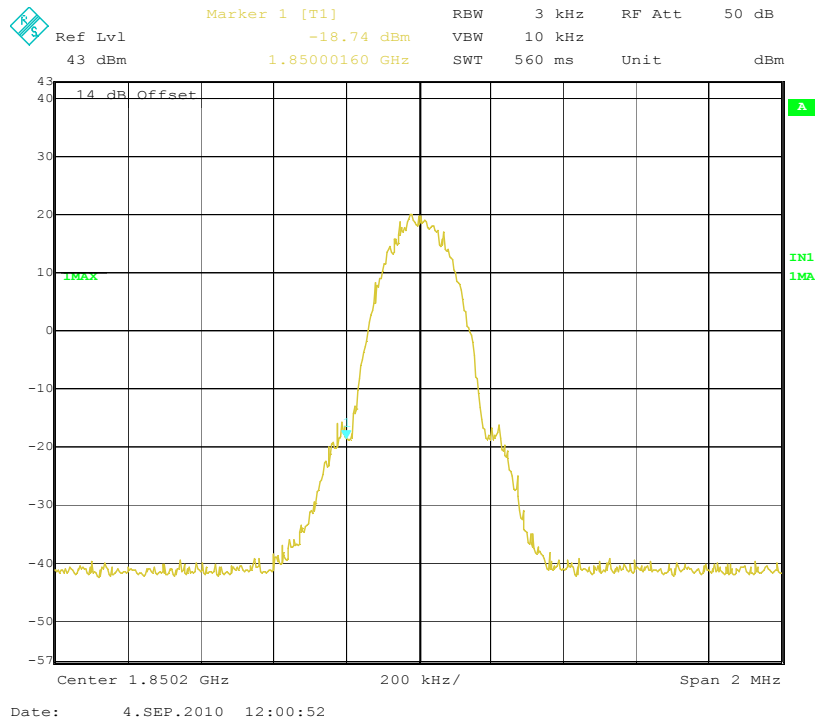

Channel 512 Left band edge (GPRS)

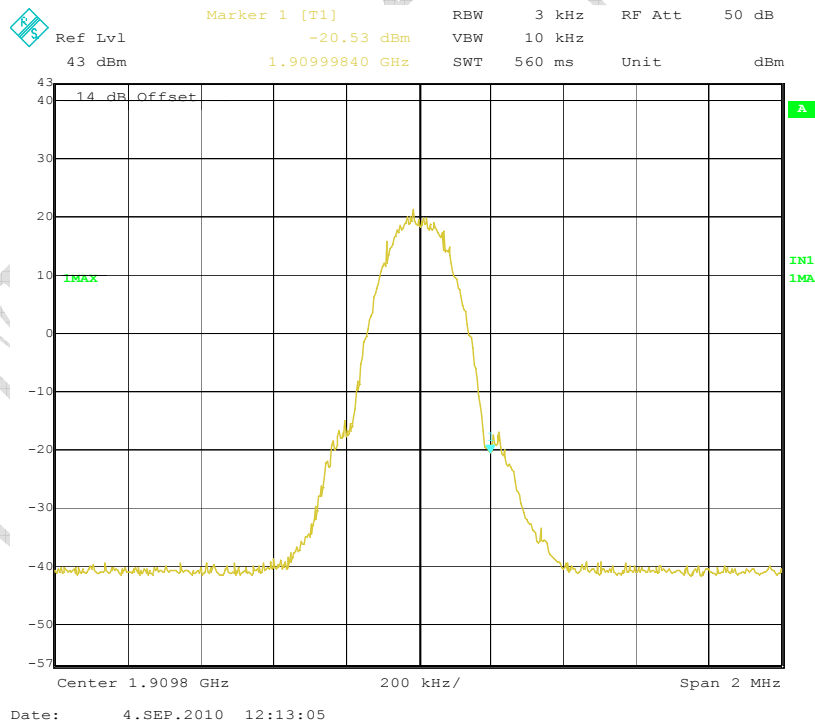

Channel 810 Left band edge (GPRS)

FCC Parts 2, 22 and 24
Equipment: Sonim XP3300-A-R1

REPORT NO.: I10GC0567-FCC-Part22

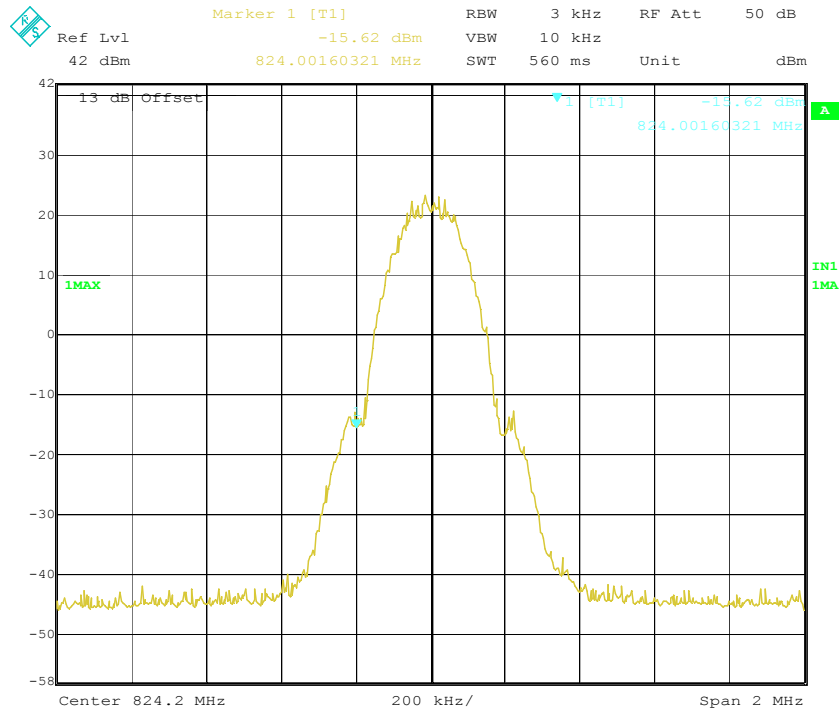

Date: 6.SEP.2010 12:01:57

Channel 128 Left band edge (EGPRS)

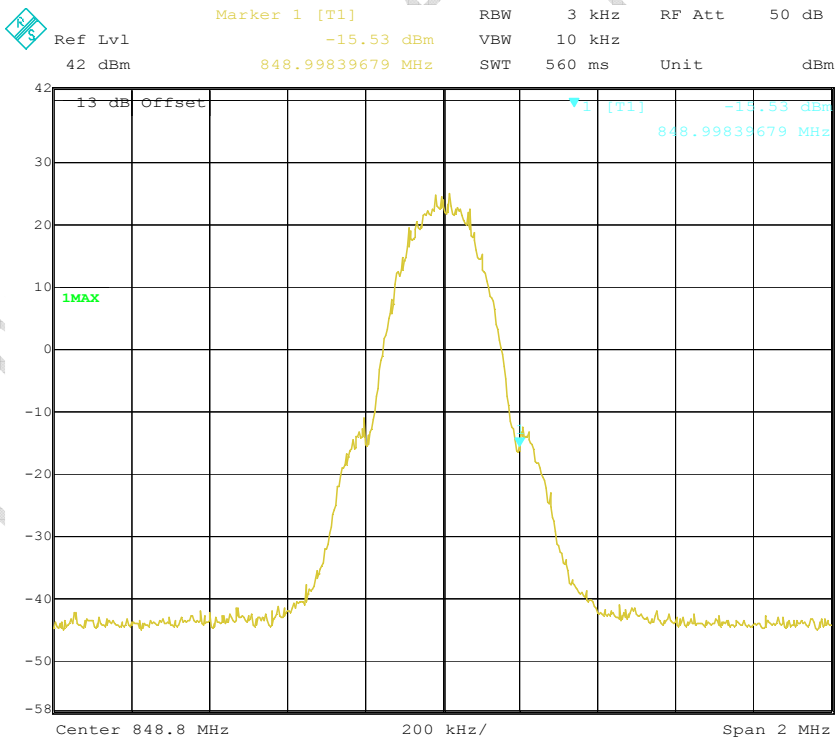

Date: 6.SEP.2010 12:15:11

Channel 251 Left band edge (EGPRS)

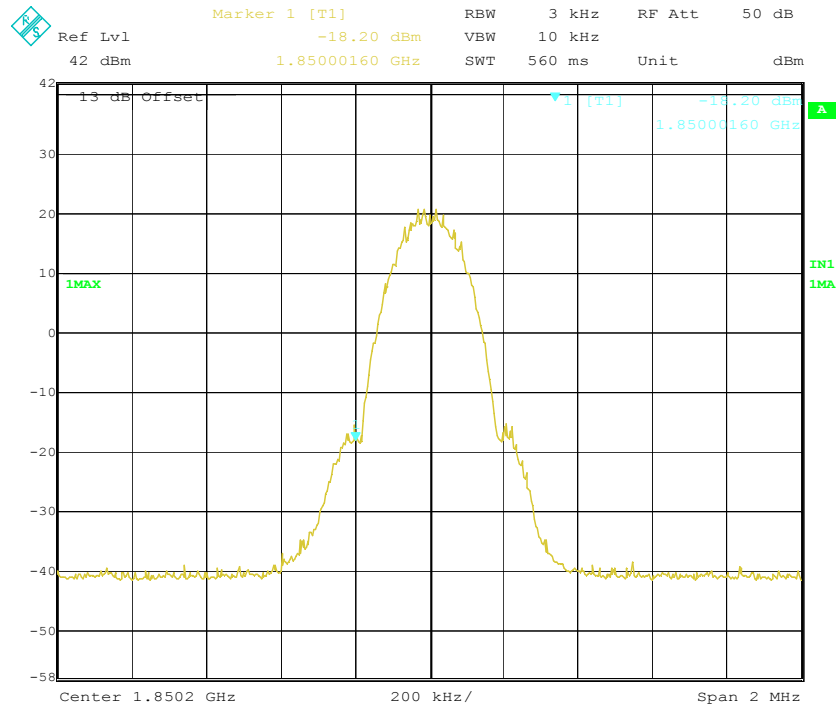

Channel 512 Left band edge (EGPRS)

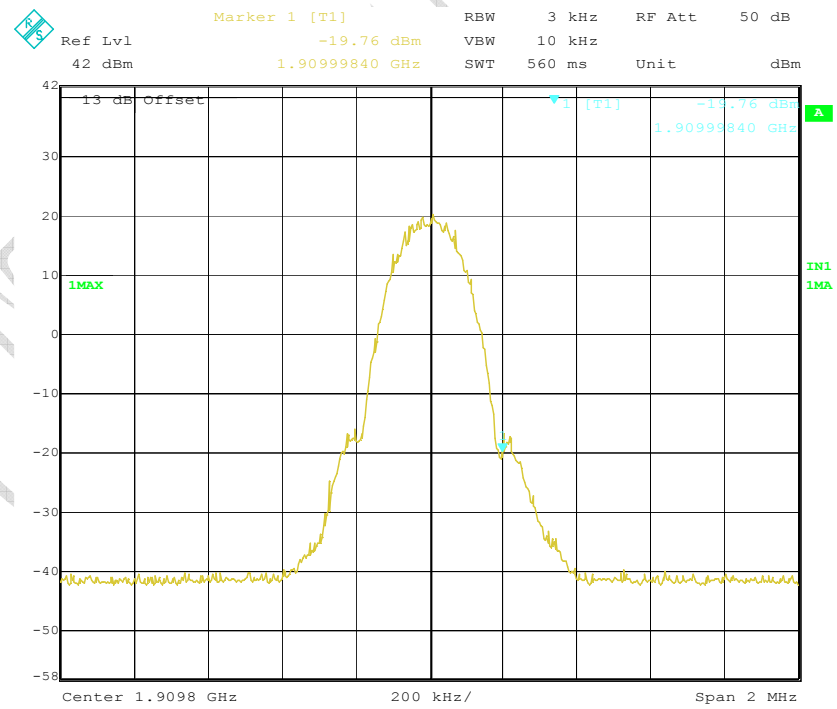

Channel 810 Left band edge (EGPRS)

Annex A External Photos



Picture 1 Front view of the handset



Picture 2 Back view of the handset

Annex B Internal Photos



Picture 3 Front view of the internal structure

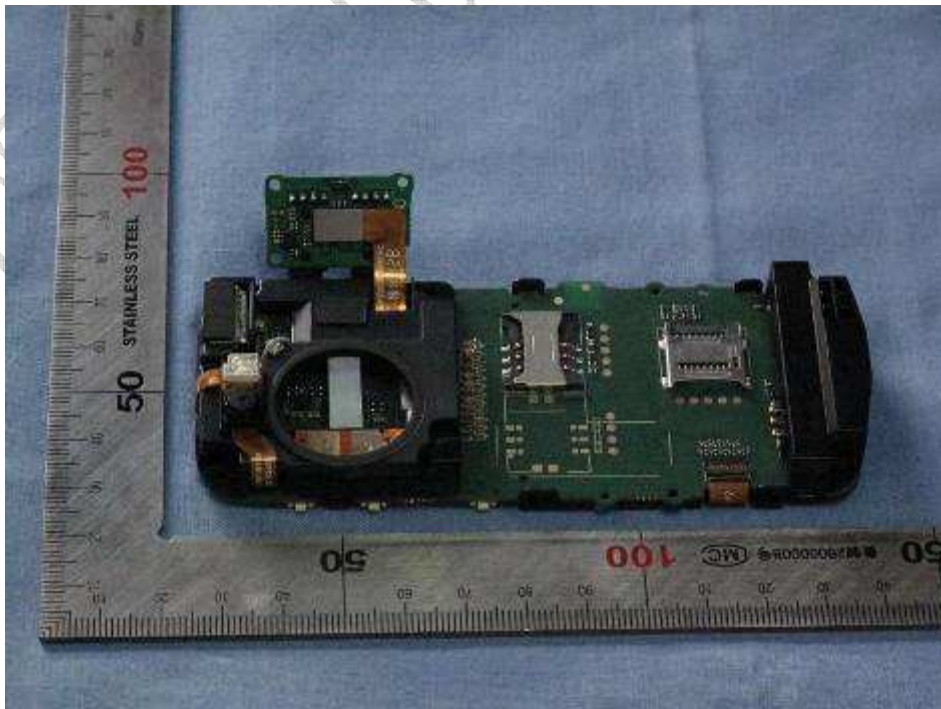

Picture 4 Back view of the internal structure

ANNEX C Deviations from Prescribed Test Methods

No deviation from Prescribed Test Methods.

_____ **The End of this Report** _____

TTL Test Report