

# TEST REPORT

**REPORT NUMBER: I10GC0429-FCC-SAR**

**ON**

**Type of Equipment:** GSM/GPRS/EGPRS mobile phone  
**Type of Designation:** Sonim XP1300-A-R1  
**Type Name:** P25B005AA  
**Manufacturer:** Sonim Technologies, Inc

**ACCORDING TO**

**FCC Part 2.1093: Radiofrequency radiation exposure evaluation: portable devices, 2009-10-01**

**FCC OET Bulletin 65 Supplement C (Edition 01-01): Additional Information for Evaluating Compliance of Mobile and Portable Devices with FCC Limits for Human Exposure to Radiofrequency Emissions**

**IEEE Std 1528™-2003: IEEE Recommended Practice for Determining the Peak Spatial-Average Specific Absorption Rate (SAR) in the Human Head from Wireless Communications Devices: Measurement Techniques**

**China Telecommunication Technology Labs.**

*Month date, year*  
*September 13, 2010*

*Signature*

He Guili  
**Director**



**FCC ID:** Sonim Technologies, Inc  
**Report Date:** 2010-09-13

**Test Firm Name:** China Telecommunication Technology Labs  
**Registration Number:** 840587

### Statement

The measurements shown in this report were made in accordance with the procedures described on test pages. All reported tests were carried out on a sample equipment to demonstrate limited compliance with FCC CFR 47 Part 2.1093. The sample tested was found to comply with the requirements defined in the applied rules.

## Table of Contents

<b>1. General Information .....</b>	<b>4</b>
1.1 NOTES .....	4
1.2 TESTERS .....	5
1.3 TESTING LABORATORY INFORMATION .....	6
1.4 DETAILS OF APPLICANT OR MANUFACTURER .....	7
<b>2 Test Item.....</b>	<b>8</b>
2.1 GENERAL INFORMATION .....	8
2.2 OUTLINE OF EUT .....	8
2.3 MODIFICATIONS INCORPORATED IN EUT .....	8
2.4 EQUIPMENT CONFIGURATION.....	8
2.5 OTHER INFORMATION .....	8
2.6 EUT PHOTOGRAPHS .....	9
<b>3 Measurement Systems.....</b>	<b>9</b>
3.1 SAR MEASUREMENT SYSTEMS SETUP .....	9
3.2 E-FIELD PROBE .....	10
3.3 PHANTOM .....	12
3.4 DEVICE HOLDER .....	12
<b>4 Test Results.....</b>	<b>13</b>
4.1 OPERATIONAL CONDITION.....	13
4.2 TEST EQUIPMENT USED.....	13
4.3 APPLICABLE LIMIT REGULATIONS.....	13
4.4 TEST RESULTS .....	14
4.5 TEST SETUP AND PROCEDURES .....	14
4.6 TEST ENVIRONMENT AND LIQUID PARAMETERS.....	15
4.7 SYSTEM VALIDATION CHECK .....	15
4.8 MAXIMUM OUTPUT POWER MEASUREMENT .....	17
4.9 TEST DATA .....	19
4.10 MEASUREMENT UNCERTAINTY.....	23
<b>ANNEX A Photographs .....</b>	<b>23</b>
<b>ANNEX B Graphical Results.....</b>	<b>30</b>
<b>Annex C System Performance Check Graphical Results .....</b>	<b>38</b>
<b>ANNEX D Probes Calibration Certificates .....</b>	<b>46</b>
<b>ANNEX E Deviations from Prescribed Test Methods .....</b>	<b>58</b>

## 1. General Information

### 1.1 Notes

All reported tests were carried out on a sample equipment to demonstrate limited compliance with the requirements of FCC CFR 47 Part 2.1093.

The test results of this test report relate exclusively to the item(s) tested as specified in section 2.

The following deviations from, additions to, or exclusions from the test specifications have been made. See Annex E.

China Telecommunication Technology Labs.(CTTL) authorizes the applicant or manufacturer (see section 1.4) to reproduce this report provided, and the test report may only be reproduced or published in full. Reproduction or publication of extracts from the report requires the prior written approval of CTTL Mr. He Guili.

Any use which a third party makes of this report, or any reliance on or decisions to be made based on it, are the responsibility of such third parties. CTTL accepts no responsibility for damages, if any, suffered by any third party as a result of decisions made or actions based on this report.

## 1.2 Testers

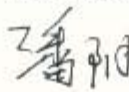
Name: Pan Yang  
Position: Engineer  
Department: Department of EMC test  
Duration of the test: From 2010-09-01 to 2010-09-10  
Signature: 

Editor of this test report:

Name: Pan Yang  
Position: Engineer  
Department: Department of EMC test  
Date: 2010-09-15  
Signature: 

Technical responsibility for area of testing:

Name: Zhang Xia  
Position: Manager  
Department: Department of EMC test  
Date: 2010-09-15  
Signature: 

### 1.3 Testing Laboratory information

#### 1.3.1 Location

Name: China Telecommunication Technology Labs.  
Address: No. 11, Yue Tan Nan Jie, Xi Cheng District,  
BEIJING  
P. R. CHINA, 100045  
Tel: +86 10 68094053  
Fax: +86 10 68011404  
Email: [emc@chinattl.com](mailto:emc@chinattl.com)

#### 1.3.2 Details of accreditation status

Accredited by: China National Accreditation Service for Conformity  
Assessment (CNAS)  
Registration number: CNAS Registration No. CNAS L0570  
Standard: ISO/IEC 17025:2005

#### 1.3.3 Test location, where different from section 1.3.1

Name: -----  
Address: -----

## 1.4 Details of applicant or manufacturer

### 1.4.1 Applicant

Name: Sonim Technologies, Inc  
Address: 1875 S. Grant Street, Suite 800 San Mateo, CA 94402  
Country: United States  
Telephone: +1 650 504 4411  
Fax: +1 650 378 8190  
Contact: Jasen Kolev  
Telephone: +1 650 504 4411  
Email: jasen@sonimtech.com

### 1.4.2 Manufacturer (if different from applicant in section 1.4.1)

Name: --  
Address: --

### 1.4.3 Manufactory (if different from applicant in section 1.4.1)

Name: --  
Address: --

## 2 Test Item

### 2.1 General Information

Manufacturer: Sonim Technologies, Inc  
 Model Name: Sonim XP1300-A-R1  
 Type Name: P25B005AA  
 Product Name: GSM/GPRS/EGPRS mobile phone  
 Serial Number: EO110823Q00084  
 Production Status: Product  
 Receipt date of test item: 2010-08-24

### 2.2 Outline of EUT

EUT is a cellular and PCS band GSM mobile phone, supporting GPRS and EGPRS with multi-time of class 12.

### 2.3 Modifications Incorporated in EUT

The EUT has not been modified from what is described by the brand name and unique type identification stated above.

### 2.4 Equipment Configuration

Equipment configuration list:

Item	Generic Description	Manufacturer	Type	Serial No.	Remarks
A	handset	Sonim Technologies, Inc	Sonim XP1300-A-R1	EO110823 Q00084	--
B	adapter	Dee Van Enterprises Co., Ltd.	DSA-3RNA-05 FUS 050065	--	--
C	battery	Sunwoda Electronic Co., Ltd.	XP-0001100	WD100800 0046	--
D	Earphone	MINAMI ACOUSTICS LIMITED	ME-816B5-C	--	--

### 2.5 Other Information

Version of hardware and software:

HW Version: PIR

SW Version: 09\_0\_0-12\_0-1-0000-9\_00

Adaptor information:

Input: 100-240V AC 50/60Hz 0.3A

Output: 5.0V 0.65A

Battery information: 1750mAh Nominal Voltage: 3.7V



## 2.6 EUT Photographs



Face view



Back view

## 3 Measurement Systems

### 3.1 SAR Measurement Systems Setup

All measurements were performed using the automated near-field scanning system, DASY5, from Schmid & Partner Engineering AG (SPEAG). The system is based on a high precision industrial robot which positions the probes with a positional repeatability of better than 0.02mm. Special E- and H-field probes have been developed for measurements close to material discontinuity, the sensors of which are directly loaded with a Schottky diode and connected via highly resistive lines (length = 300mm) to the data acquisition unit.

A cell controller system containing the power supply, robot controller, teach pendant (Joystick) and remote control, is used to drive the robot motors. The PC consists of the Micron Pentium III 800 MHz computer with Windows 2000 system and SAR Measurement Software DASY5, A/D interface card, monitor, mouse, and keyboard. The Stäubli Robot is connected to the cell controller to allow software manipulation of the robot. A data acquisition electronic (DAE) performs the signal amplification, signal multiplexing, AD-conversion, offset measurements, mechanical surface detection, collision detection, etc., which is connected to the Electro-optical coupler (EOC). The EOC performs the conversion from the optical signal to digital electric signal of the DAE and transfers data to the PC plug-in card.

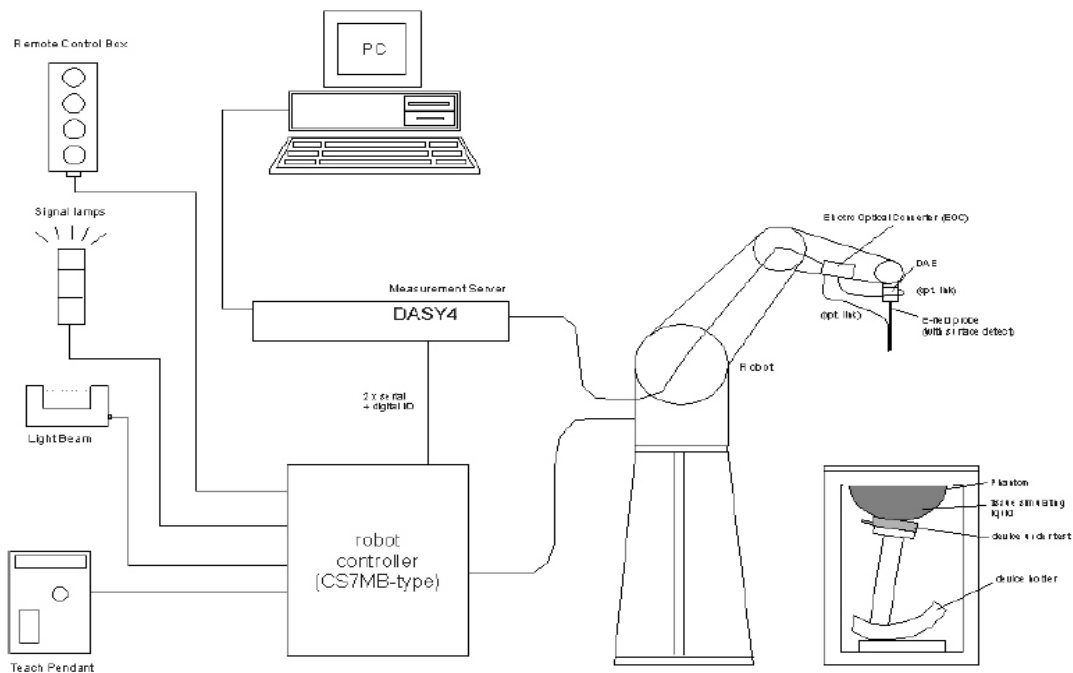

Demonstration of measurement system setup

The DAE4 consists of a highly sensitive electrometer-grade preamplifier with auto-zeroing, a channel and gain-switching multiplexer, a fast 16 bit AD-converter and a command decoder and control logic unit. Transmission to the PC-card is accomplished through an optical downlink for data and status information and an optical uplink for commands and clock lines. The mechanical probe mounting device includes two different sensor systems for frontal and sidewise probe contacts. They are also used for mechanical surface detection and probe collision detection. The robot uses its own controller with a built-in VME-bus computer.

### 3.2 E-field Probe

#### 3.2.1 E-field Probe Description

The SAR measurements were conducted with the dosimetric probe ES3DV3 (manufactured by SPEAG), designed in the classical triangular configuration and optimized for dosimetric evaluation. The probe has been calibrated according to the

standard procedure with an accuracy of better than  $\pm 10\%$ . The spherical isotropy was evaluated and found to be better than  $\pm 0.25\text{dB}$ .

Items	Specification
Construction	Symmetrical design with triangular core Built-in optical fiber for surface detection System Built-in shielding against static charges PEEK enclosure material(resistant to organic solvents, e.g., glycol)
Calibration	In air from 10 MHz to 2.5 GHz In brain and muscle simulating tissue at frequencies of 450MHz, 900MHz and 1.8GHz (accuracy $\pm 8\%$ ) Calibration for other liquids and frequencies upon request
Frequency	10 MHz to > 6 GHz; Linearity: $\pm 0.2\text{ dB}$ (30 MHz to 3 GHz)
Directivity	$\pm 0.2\text{ dB}$ in brain tissue (rotation around probe axis) $\pm 0.4\text{ dB}$ in brain tissue (rotation normal probe axis)
Dynamic Range	5 $\mu\text{W/g}$ to > 100mW/g; Linearity: $\pm 0.2\text{dB}$
Surface Detection	$\pm 0.2\text{ mm}$ repeatability in air and clear liquids over diffuse reflecting surface
Dimensions	Overall length: 330mm Tip length: 16mm Body diameter: 12mm Tip diameter: 6.8mm Distance from probe tip to dipole centers: 2.7mm
Application	General dosimetry up to 3GHz Compliance tests of mobile phones Fast automatic scanning in arbitrary phantoms

### 3.2.2 E-field Probe Calibration

The Annex C is the copy of the calibration certificate of the used probes.

Each probe is calibrated according to a dosimetric assessment procedure with accuracy better than  $\pm 10\%$ . The spherical isotropy was evaluated and found to be better than  $\pm 0.25\text{dB}$ . The sensitivity parameters (NormX, NormY, NormZ), the diode compression parameter (DCP) and the conversion factor (ConvF) of the probe are tested.

The free space E-field from amplified probe outputs is determined in a test chamber. This is performed in a TEM cell for frequencies bellow 1 GHz, and in a wave guide above 1 GHz for free space. For the free space calibration, the probe is placed in the volumetric center of the cavity and at the proper orientation with the field. The probe is then rotated 360 degrees.

E-field temperature correlation calibration is performed in a flat phantom filled with

the appropriate simulated brain tissue. The free-space E-field measured in the medium correlates to temperature increase in a dielectric medium. For temperature correlation calibration a RF transparent thermistor-based temperature probe is used in conjunction with the E-field probe.

$$SAR = C \frac{\Delta T}{\Delta t}$$

Where:  $\Delta t$  = Exposure time (30 seconds),

C = Heat capacity of tissue (brain or muscle),

$\Delta T$  = Temperature increase due to RF exposure.

Or

$$SAR = \frac{|E|^2 \sigma}{\rho}$$

Where:

$\sigma$  = Simulated tissue conductivity,

$\rho$  = Tissue density (kg/m<sup>3</sup>).

### 3.3 Phantom

The Generic Twin Phantom is constructed of a fiberglass shell integrated in a wooden table. The shape of the shell is based on data from an anatomical study designed to determine the maximum exposure in at least 90% of all users. It enables the dosimetric evaluation of left and right hand phone usage as well as body mounted usage at the flat phantom region. A cover prevents the evaporation of the liquid. Reference markings on the Phantom allow the complete setup of all predefined phantom positions and measurement grids by manually teaching three points in the robot.

Specifications:

Shell Thickness: 2±0.1mm

Filling Volume: Approx. 20 liters

Dimensions: 810 x 1000 x 500 mm (H x L x W)

Liquid depth when testing: at least 150 mm

### 3.4 Device Holder

In combination with the Generic Twin Phantom V3.0, the Mounting Device (POM) enables the rotation of the mounted transmitter in spherical coordinates whereby the rotation points is the ear opening. The devices can be easily, accurately, and repeat ably positioned according to the FCC and CENELEC specifications. The device holder can be locked at different phantom locations (left head, right head, flat phantom etc).

## 4 Test Results

### 4.1 Operational Condition

**Specifications** FCC OET 65C (01-01), IEEE Std 1528™-2003

**Date of Tests** from 2010-08-27 to 2010-09-02

**Operation Mode** TX at the highest output peak power level

**Method of measurement:** FCC OET 65C (01-01), IEEE Std 1528™-2003

### 4.2 Test Equipment Used

ITEM	TYPE	S/N	CALIBRATION DATE	DUE DATE
probe	ES3DV3	3158	2010-05-20	2011-05-19
DAE	DAE4	549	2010-05-20	2011-05-20
D835V2	dipole	473	2010-05-21	2011-05-20
D1900V2	dipole	5d024	2010-05-26	2011-05-25
Power Meter	E4417A	GB41050460	2010-05-25	2012-05-20
Radio Communication Analyzer	CMU200	1100000802	2010-04-02	2011-04-01
Signal Generator	SMP04	100064	2010-05-24	2011-05-23
Power Sensor	E9327A	US40440198	2010-07-13	2011-07-12
Power Sensor	E9327A	US40440326	2010-07-26	2011-07-25
Power Amplifier	150W1000	150W1000	NA	NA
Attenuator	20dB	836471/003	NA	NA
Attenuator	20dB	836471/004	NA	NA
Attenuator	2	BL1250	NA	NA
Attenuator	2	BK774	NA	NA
Dual directional coupler	4242-20	04200	NA	NA
Probe kit	85070E	3G-S-00139	NA	NA
Network Analyzer	8753ES	MY40002093	2010-05-26	2011-05-25

### 4.3 Applicable Limit Regulations

Item	Limit Level
Local Specific Absorption Rate (SAR) (1g)	1.6W/kg

## 4.4 Test Results

The EUT complies.

**Note:**

All measurements are traceable to national standards.

## 4.5 Test Setup and Procedures

The test setup is showed as in the annex A.

The evaluation was performed according to the following procedure:

Step 1: The SAR value at a fixed location above the ear point was measured and was used as a reference value for assessing the power drift.

Step 2: The SAR distribution at the exposed side of the head was measured at a distance of 4 mm from the inner surface of the shell. The area covered the entire dimension of the head and the horizontal grid spacing was 15 mm x 15 mm. Based on these data, the area of the maximum absorption was determined by interpolation.

Step 3: Around this point, a volume of 30 mm x 30 mm x 30 mm was assessed by measuring 7 x 7 x 7 points. On this basis of this data set, the spatial peak SAR value was evaluated with the following procedure:

a. The data at the surface were extrapolated, since the center of the dipoles is 2.7 mm away from the tip of the probe and the distance between the surface and the lowest measuring point is 1.2 mm. The extrapolation was based on the least square algorithm. A polynomial of the fourth order was calculated through the points in z-axes. This polynomial was then used to evaluate the points between the surface and the probe tip.

b. The maximum interpolated value was searched with a straightforward algorithm. Around this maximum the SAR values averaged over the spatial volumes (1g or 10g) were computed using the 3D-Spline interpolation algorithm. The 3D-spline is composed of three one-dimensional splines with the "Not a knot"-condition (in x ~ y and z-directions). The volume was integrated with the trapezoidal algorithm. One thousand points (10 x 10 x 10) were interpolated to calculate the average.

c. All neighboring volumes were evaluated until no neighboring volume with a higher average value was found.

Step 4: Re-measurement the SAR value at the same location as in Step 1. If the value changed by more than 5%, the evaluation should be repeated.

## 4.6 Test Environment and Liquid Parameters

### 4.6.1 Test Environment

Date:	Liquid Temperature (°C)	Ambient Temperature (°C)	Ambient Humidity (%)
	20~24	20~25	30~70
2010-08-27	52.1	22.3	22
2010-08-30	51.6	23.1	23
2010-09-02	49.1	22.9	23

### 4.6.2 Liquid Parameters

2010-08-27

Frequency	Tissue Type	Type	Dielectric Parameters	
			permittivity	conductivity
835 MHz	Head	Target	41.5	0.9
		±5% window	39.4~43.6	0.855~0.945
		Measured	41.27	0.975

2010-08-27

Frequency	Tissue Type	Type	Dielectric Parameters	
			permittivity	conductivity
1900 MHz	Head	Target	40.0	1.40
		±5% window	38.00~42.00	1.33~1.47
		Measured	40.42	1.435

2010-09-02

Frequency	Tissue Type	Type	Dielectric Parameters	
			permittivity	conductivity
835 MHz	Body	Target	55.2	0.97
		±5% window	52.44~57.96	0.922~1.019
		Measured	55.43	0.957

2010-08-30

Frequency	Tissue Type	Type	Dielectric Parameters	
			permittivity	conductivity
1900 MHz	Body	Target	53.3	1.52
		±5% window	50.64~55.97	1.444~1.596
		Measured	51.44	1.569

#### 4.7 System Validation Check

##### Validation Method:

The setup of system validation check or performance check is demonstrated as figure 5. The amplifier, low pass filter and attenuators are optional. The dipole shall be positioned and centered below the phantom, paralleling to the longest side of the phantom. A low loss and low dielectric constant spacer on the dipole may be used to guarantee the correct distance between the dipole top surface and the phantom bottom surface.

The separation  $d$ , which is defined as the distance from the liquid bottom surface to the dipole's central axis at location of the feed-point, should be as following: for 835 MHz dipole,  $d = 15$  mm. The dipole arms shall be parallel to the flat phantom surface.

First the power meter PM1 is connected to the cable and it measures the forward power at the location of the dipole connector (X). The signal generator is adjusted for the desired forward power at the dipole connector (taking into account the (Att1) value) and the power meter PM2 is read at that level. Then after connecting the cable to the dipole, the signal generator is readjusted for the same reading at the power meter PM2.

The system validation check procedures are the same as all measurement procedures used for compliance tests. A complete 1 g averaged SAR measurement is performed using the flat part of the phantom. The reference dipole input power is adjusted to produce a 1 g averaged SAR value falling in the range of 0.4 – 10 mW/g. The 1 g averaged SAR is measured at 835 MHz using corresponding dipole. Then the results are normalized to 1 W forward input power and compared with the reference SAR values.



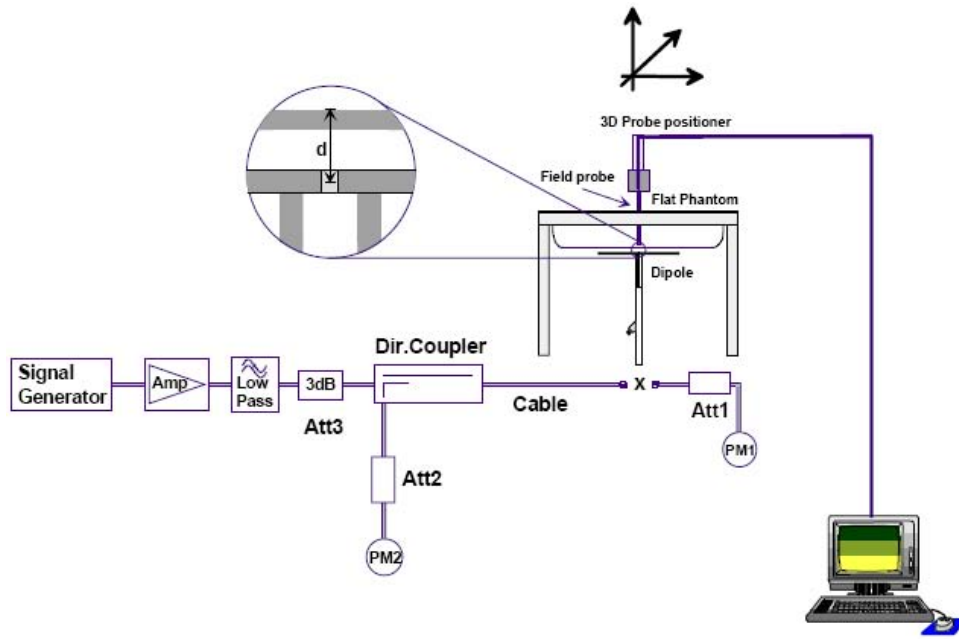

Figure 5 Illustration of system validation test setup

**Validation Results**

Date:	Tissue	Input Power (dBm)	Measured SAR <sub>10g</sub> (mW/g)	Normalized to 1W (mW/g)	Targeted SAR <sub>10g</sub> (mW/g)	Deviation (%) (<±10%)
2010-08-27	Head 835MHz	24.00	2.59	10.36	9.62	7.7
2009-09-02	Body 835MHz	24.00	2.32	9.28	9.88	-6.5
2010-08-27	Head 1900MHz	24.00	10.3	41.2	39.7	3.8
2009-08-30	Body 1900MHz	24.00	10.1	40.4	41.3	-2.2

**4.8 Conducted Power Measurement**

According to FCC OET 65c, Conducted power shall be measured before SAR test. The test setup and method are described as following.

Test setup

The output power measurement test setup is demonstrated as figure 6.



Figure 6 Demonstration of Conducted power measurement

The power control level settings and measurement value are as following table.

Conducted Power Measurement

System and Channel	Power (dBm)	Average factor (dB)	Time Average (dBm)
GSM850 Ch128 (1TS)	32.61	-9.03	23.58
GSM850 Ch190 (1TS)	32.62	-9.03	23.59
GSM850 Ch251 (1TS)	32.60	-9.03	23.57
GPRS850 Ch190			
1TS	32.58	-9.03	23.55
2TS	31.67	-6.02	25.65
3TS	30.14	-4.26	25.88
4TS	29.41	-3.01	26.40
EGPRS850 Ch190			
1TS	26.75	-9.03	17.72
2TS	25.95	-6.02	19.93
3TS	24.20	-4.26	19.94
4TS	23.01	-3.01	20.00
PCS1900 Ch512 (1TS)	29.99	-9.03	20.96
PCS1900 Ch661 (1TS)	29.99	-9.03	20.96
PCS1900 Ch810 (1TS)	29.96	-9.03	20.93
GPRS1900 Ch661			
1TS	30.00	-9.03	20.97
2TS	29.00	-6.02	22.98
3TS	27.04	-4.26	22.78
4TS	26.08	-3.01	23.07
EGPRS1900 Ch661			
1TS	25.65	-9.03	16.62
2TS	24.50	-6.02	18.48
3TS	22.40	-4.26	18.14
4TS	21.05	-3.01	18.04

Note:

TS = Time Slot(s)

Explanation about average factor of conducted power:

For time division signal, to average the power, the factor should be as following:

Time slots number	Total time slots number	Average factor	Average factor (dB)
1	8	8/1	-9.03
2	8	8/2	-6.02
3	8	8/3	-4.26
4	8	8/4	-3.01

## 4.9 Test Data

### 4.9.1 Test Specifications

#### (a) Duty Factor and Crest Factor

For GSM mode (1TS), the duty factor is 1:8.3, and for GPRS and EGPRS, the duty factor is as following table:

Time slots number	Duty Factor
1	1:8.3
2	1:4.15
3	1:2.77
4	1:2

#### (b) Test configurations pictures:

Configurations	pictures no. in Annex A
Head Right touch position:	2
Head Right tilt position:	3
Head Left touch position:	4
Head Left tilt position:	5
Body SAR Back to the phantom:	6
Body SAR Front to the phantom:	7
Body SAR Back to the phantom with earphone:	8
Body SAR Front to the phantom with earphone:	9
Body SAR Back to the	10

phantom with belt:	
Body SAR Back to the phantom with belt clip and earphone:	11

**(c) Test description for body-worn mode**

For common mode, the distance between the handset and the bottom of the flat section is 15 mm; for belt mode, the distance is constrained to the belt thickness.

**(d) Liquid recipe**

INGREDIENTS	TISSUE TYPE			
	835MHz Head	835MHz body	1900MHz Head	1900MHz body
Water	40.29	50.75	55.24	70.17
DGBE	0	0	44.45	29.44
Sugar	57.90	48.21	0	0
Salt	1.38	0.94	0.31	0.39
Cellulose	0.24	0.00	0	0
Preventol	0.18	0.10	0	0

**(e) General Test procedure for body-worn mode**

Step 1: GSM850 band, test the middle channel of each of the front side and back side mode with the specified distance between the handset and the bottom of the phantom. Find out the worst case.

Step 2: For the worst case of step 1, test the low and high channel. And then test the low/middle/high channels of back side with belt.

Step 3: Find out the worst case of step 1 and 2, and for this case, test the modes with GPRS and EGPRS with suitable time slots according to the average conducted powers, and Bluetooth and earphone using voice traffic mode.

Step 4: Repeat all the above steps for other bands.

#### 4.9.2 Test Data for Head mode

##### GSM850 head

Test configuration	Test position	SAR <sub>1g</sub> [W/kg] / Power Drift [dB]								
		Channel 128 [low] 824.2 MHz		Channel 190 [Mid] 836.6 MHz		Channel 251 [high] 848.8 MHz				
Right side of Head	Cheek	0.779	/	-0.112	0.766	/	0.023	0.818	/	-0.146
	Tilted	--	/	--	0.512	/	-0.007	--	/	--
Left side of Head	Cheek	--	/	--	0.710	/	-0.261	--	/	--
	Tilted	--	/	--	0.476	/	-0.968	--	/	--

##### PCS1900 head

Test configuration	Test position	SAR <sub>1g</sub> [W/kg] / Power Drift [dB]								
		Channel 512 [low] 1850.2 MHz		Channel 661 [Mid] 1880.0 MHz		Channel 810 [high] 1909.8 MHz				
Right side of Head	Cheek	0.708	/	0.046	0.829	/	-0.026	0.901	/	-0.295
	Tilted	--	/	--	0.342	/	0.037	--	/	--
Left side of Head	Cheek	--	/	--	0.652	/	0.013	--	/	--
	Tilted	--	/	--	0.396	/	-0.024	--	/	--

### 4.9.3 Test Data for Body-Worn mode

#### GSM850 body

Test configuration	SAR <sub>1g</sub> [W/kg] / Power Drift [dB]		
	Channel 128 [low] 824.2 MHz	Channel 190 [Mid] 836.6 MHz	Channel 251 [high] 848.8 MHz
Face towards phantom	-- / --	0.576 / 0.234	-- / --
Back toward phantom	0.616 / 0.100	0.605 / -0.065	0.519 / 0.0456
Back toward phantom with belt	0.657 / -0.024	0.569 / 0.148	0.549 / 0.146
Back toward phantom with earphone	0.453 / -0.0156	-- / --	-- / --
Back toward phantom with BT on	0.513 / -0.0336	-- / --	-- / --
Back toward phantom with GPRS (4TS)	0.478 / 0.117	-- / --	-- / --
Back toward phantom with EGPRS (4TS)	0.555 / 0.0396	-- / --	-- / --

#### PCS1900 body

Test configuration	SAR <sub>1g</sub> [W/kg] / Power Drift [dB]		
	Channel 512 [low] 1850.2 MHz	Channel 661 [Mid] 1880.0 MHz	Channel 810 [high] 1909.8 MHz
Face towards phantom	0.267 / 0.260	0.313 / -0.0811	0.306 / 0.235
Back toward phantom	-- / --	0.297 / 0.371	-- / --
Back toward phantom with belt	0.253 / 0.238	0.286 / -0.208	0.303 / -0.064
Face toward phantom with earphone	-- / --	0.280 / -0.016	-- / --
Face toward phantom with BT on	-- / --	0.275 / 0.210	-- / --
Face toward phantom with GPRS (4TS)	-- / --	0.310 / -0.052	-- / --
Face toward phantom with EGPRS (2TS)	-- / --	0.267 / 0.002	-- / --

### 4.10 Measurement uncertainty

Error Description	Unc. value, ±%	Prob. Dist.	Div.	c <sub>i</sub> 1g	c <sub>i</sub> 10g	Std.Unc. ±%,1g	Std.Unc. ±%,10g	V <sub>i</sub> V <sub>eff</sub>
<b>Measurement System</b>								
Probe Calibration	5.9	N	1	1	1	5.9	5.9	∞
Axial Isotropy	0.5	R	√3	0.7	0.7	0.2	0.2	∞
Hemispherical Isotropy	2.6	R	√3	0.7	0.7	1.1	1.1	∞
Boundary Effects	0.8	R	√3	1	1	0.5	0.5	∞
Linearity	0.6	R	√3	1	1	0.3	0.3	∞
System Detection Limits	1.0	R	√3	1	1	0.6	0.6	∞
Readout Electronics	0.7	N	1	1	1	0.7	0.7	∞
Response Time	0	R	√3	1	1	0	0	∞
Integration Time	2.6	R	√3	1	1	1.5	1.5	∞
RF Ambient Noise	3.0	R	√3	1	1	1.7	1.7	∞
RF Ambient Reflections	3.0	R	√3	1	1	1.7	1.7	∞
Probe Positioner	1.5	R	√3	1	1	0.9	0.9	∞
Probe Positioning	2.9	R	√3	1	1	1.7	1.7	∞
Max. SAR Eval.	1.0	R	√3	1	1	0.6	0.6	∞
<b>Test Sample Related</b>								
Device Positioning	2.9	N	1	1	1	2.9	2.9	145
Device Holder	3.6	N	1	1	1	3.6	3.6	5
Power Drift	5.0	R	√3	1	1	2.9	2.9	∞
Dipole Positioning	2.0	N	1	1	1	2.0	2.0	∞
Dipole Input Power	5.0	N	1	1	1	5.0	5.0	∞
<b>Phantom and Setup</b>								
Phantom Uncertainty	4.0	R	√3	1	1	2.3	2.3	∞
Liquid Conductivity (target)	5.0	R	√3	0.64	0.43	1.8	1.2	∞
Liquid Conductivity (meas.)	2.5	N	1	0.64	0.43	1.6	1.1	∞
Liquid Permittivity (target)	5.0	R	√3	0.6	0.49	1.7	1.4	∞
Liquid Permittivity (meas.)	2.5	N	1	0.6	0.49	1.5	1.2	∞
<b>Combined Std Uncertainty</b>						±11.2%	±10.9%	387
<b>Expanded Std Uncertainty</b>						±22.4%	±21.8%	

## ANNEX A Photographs



Picture 1 test setup



Picture 2: Head Right touch position





Picture 3: Head Right tilt position



Picture 4: Head Left touch position



Picture 5: Head Left tilt position



Picture 6: Body SAR Back to the phantom



Picture 7: Body SAR Front to the phantom



Picture 8: Body SAR Back to the phantom with earphone



Picture 9: Body SAR Front to the phantom with earphone



Picture 10: Body SAR Back to the phantom with belt



Picture 11: Body SAR Back to the phantom with belt and earphone

TTL Test Report

## ANNEX B Graphical Results

### B.1 Maximum head SAR of GSM850 Mode – High channel, Right cheek mode

Test Laboratory: CTTL

#### FCC\_Head\_Sonim\_GSM850\_XP1300-A\_RC\_High

**DUT: SONIM XP 1300-A; Type: SONIM XP 1300-A; Serial: --**

Communication System: GSM 850; Frequency: 848.8 MHz; Duty Cycle: 1:8.3

Medium parameters used:  $f = 849$  MHz;  $\sigma = 0.93$  mho/m;  $\epsilon_r = 41.8$ ;  $\rho = 1000$  kg/m<sup>3</sup>

Phantom section: Right Section

Measurement Standard: DASYS (IEEE/IEC)

DASY4 Configuration:

- Probe: ES3DV3 - SN3158; ConvF(5.97, 5.97, 5.97); Calibrated: 2010-5-20
- Sensor-Surface: 4mm (Mechanical Surface Detection)
- Electronics: DAE4 Sn549; Calibrated: 2010-5-20
- Phantom: North SAM; Type: SAM; Serial: TP-1472
- Measurement SW: DASYS, V5.0 Build 119; SEMCAD X Version 13.2 Build 87

**Sonim\_Right\_Touch\_High/Zoom Scan (7x7x6)/Cube 0:** Measurement grid:  
dx=5mm, dy=5mm, dz=5mm

Reference Value = 11.7 V/m; Power Drift = 0.146 dB

Peak SAR (extrapolated) = 1.03 W/kg

**SAR(1 g) = 0.818 mW/g; SAR(10 g) = 0.607 mW/g**

Maximum value of SAR (measured) = 0.860 mW/g

**Sonim\_Right\_Touch\_High/Area Scan (81x41x1):** Measurement grid:

dx=15mm, dy=15mm

Maximum value of SAR (interpolated) = 0.868 mW/g

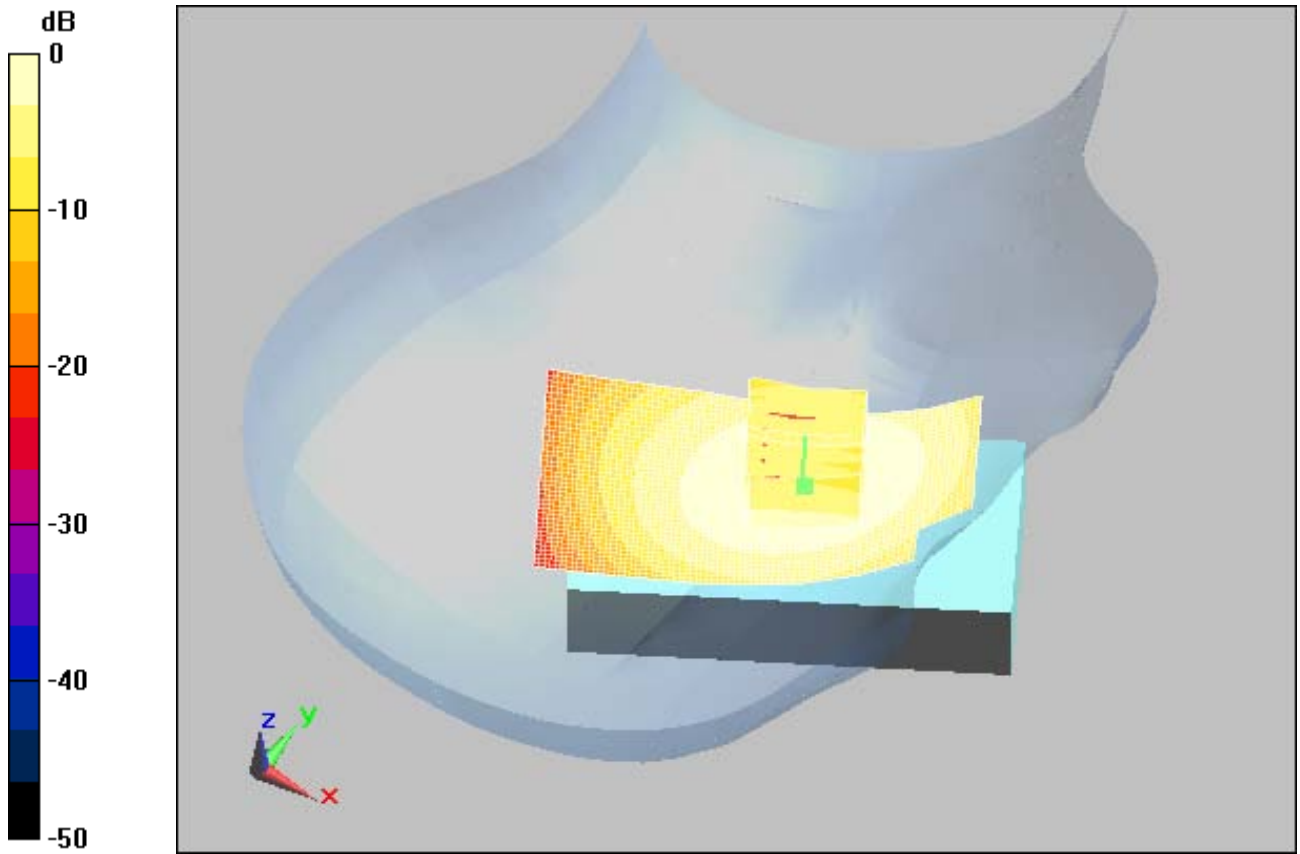

0 dB = 0.868mW/g

TTL TEST

## B.2 Maximum head SAR of GSM1900 Mode – High channel, Right cheek mode

Test Laboratory: CTTL

### FCC\_Head\_Sonim\_PCS1900\_XP1300-A\_RC\_High

**DUT: SONIM XP 1300-A; Type: SONIM XP 1300-A; Serial: --**

Communication System: PCS 1900; Frequency: 1909.8 MHz; Duty Cycle: 1:8.3  
Medium parameters used:  $f = 1910$  MHz;  $\sigma = 1.54$  mho/m;  $\epsilon_r = 40.2$ ;  $\rho = 1000$  kg/m<sup>3</sup>

Phantom section: Right Section

Measurement Standard: DASY5 (IEEE/IEC)

DASY4 Configuration:

- Probe: ES3DV3 - SN3158; ConvF(5.00, 5.00, 5.00); Calibrated: 2010-5-20
- Sensor-Surface: 4mm (Mechanical Surface Detection)
- Electronics: DAE4 Sn549; Calibrated: 2010-5-20
- Phantom: West SAM; Type: SAM; Serial: --
- Measurement SW: DASY5, V5.0 Build 119; SEMCAD X Version 13.2 Build 87

**PCS\_Touch\_Right\_High/Area Scan (81x41x1):** Measurement grid: dx=15mm, dy=15mm

Maximum value of SAR (interpolated) = 1 mW/g

**PCS\_Touch\_Right\_High/Zoom Scan (7x7x6)/Cube 0:** Measurement grid:

dx=5mm, dy=5mm, dz=5mm

Reference Value = 6.76 V/m; Power Drift = 0.295 dB

Peak SAR (extrapolated) = 1.36 W/kg

**SAR(1 g) = 0.901 mW/g; SAR(10 g) = 0.537 mW/g**

Maximum value of SAR (measured) = 0.984 mW/g



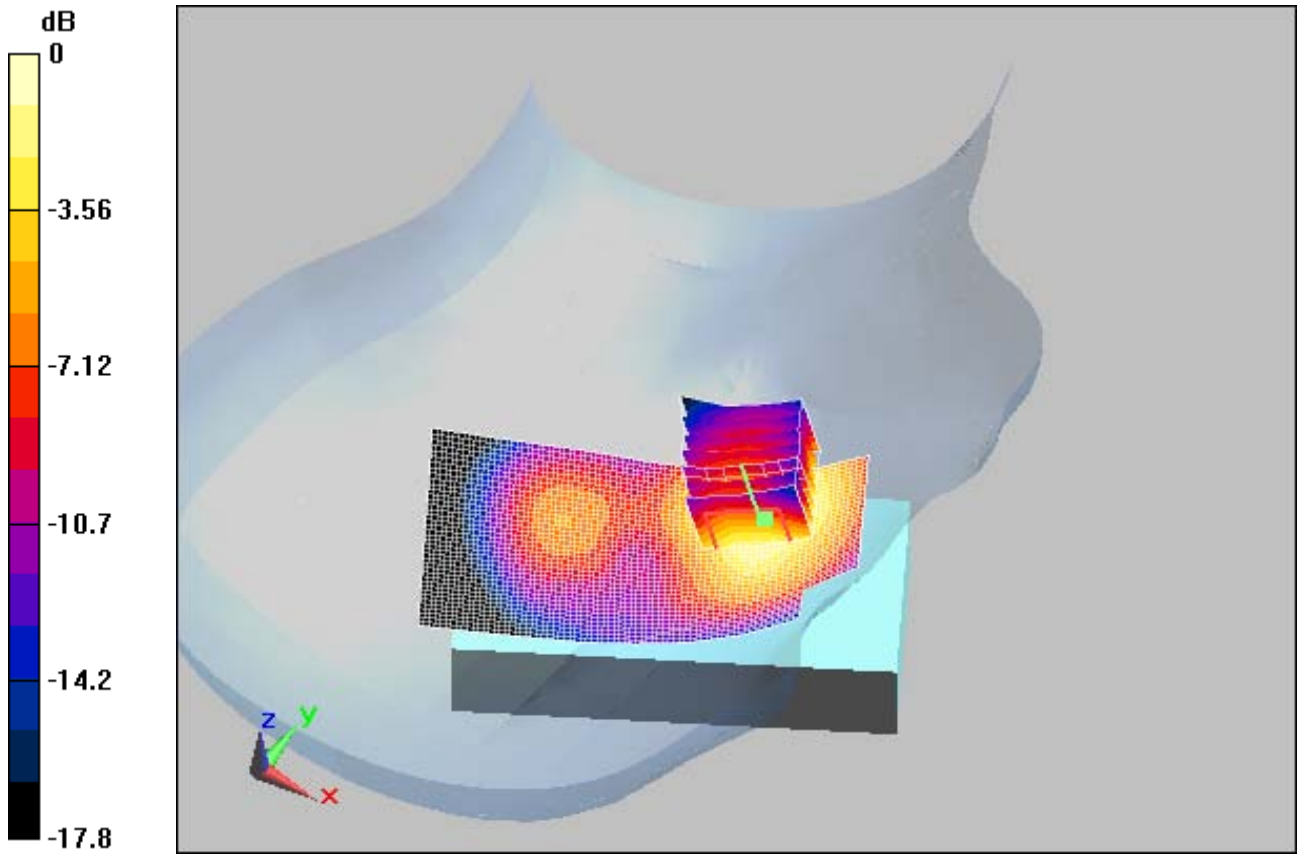

0 dB = 0.984mW/g

TTL Test

### **B.3 Maximum body SAR of GSM850 mode– Low channel, Back side with Belt,**

Test Laboratory: CTTL

#### **FCC\_Body\_GSM850\_Back\_B\_Low**

**DUT: SONIM XP 1300-A; Type: SONIM XP 1300-A; Serial: EO110823Q00084**

Communication System: GSM 850; Frequency: 824.2 MHz; Duty Cycle: 1:8.3  
Medium parameters used (interpolated):  $f = 824.2$  MHz;  $\sigma = 0.953$  mho/m;  $\epsilon_r = 55.6$ ;  $\rho = 1000$  kg/m<sup>3</sup>  
Phantom section: Flat Section  
Measurement Standard: DASY5 (IEEE/IEC)

DASY4 Configuration:

- Probe: ES3DV3 - SN3158; ConvF(5.93, 5.93, 5.93); Calibrated: 2010-5-20
- Sensor-Surface: 4mm (Mechanical Surface Detection)
- Electronics: DAE4 Sn549; Calibrated: 2010-5-20
- Phantom: ELI 4.0; Type: QDOVA001BA; Serial: TP-1472
- Measurement SW: DASY5, V5.0 Build 119; SEMCAD X Version 13.2 Build 87

**GSM\_Belt\_Back\_Low/Zoom Scan (7x7x7)/Cube 0:** Measurement grid:

$dx=5$ mm,  $dy=5$ mm,  $dz=5$ mm

Reference Value = 10.5 V/m; Power Drift = -0.024 dB

Peak SAR (extrapolated) = 0.849 W/kg

**SAR(1 g) = 0.657 mW/g; SAR(10 g) = 0.483 mW/g**

Maximum value of SAR (measured) = 0.695 mW/g

**GSM\_Belt\_Back\_Low/Area Scan (31x81x1):** Measurement grid:  $dx=15$ mm,  $dy=15$ mm

Maximum value of SAR (interpolated) = 0.697 mW/g

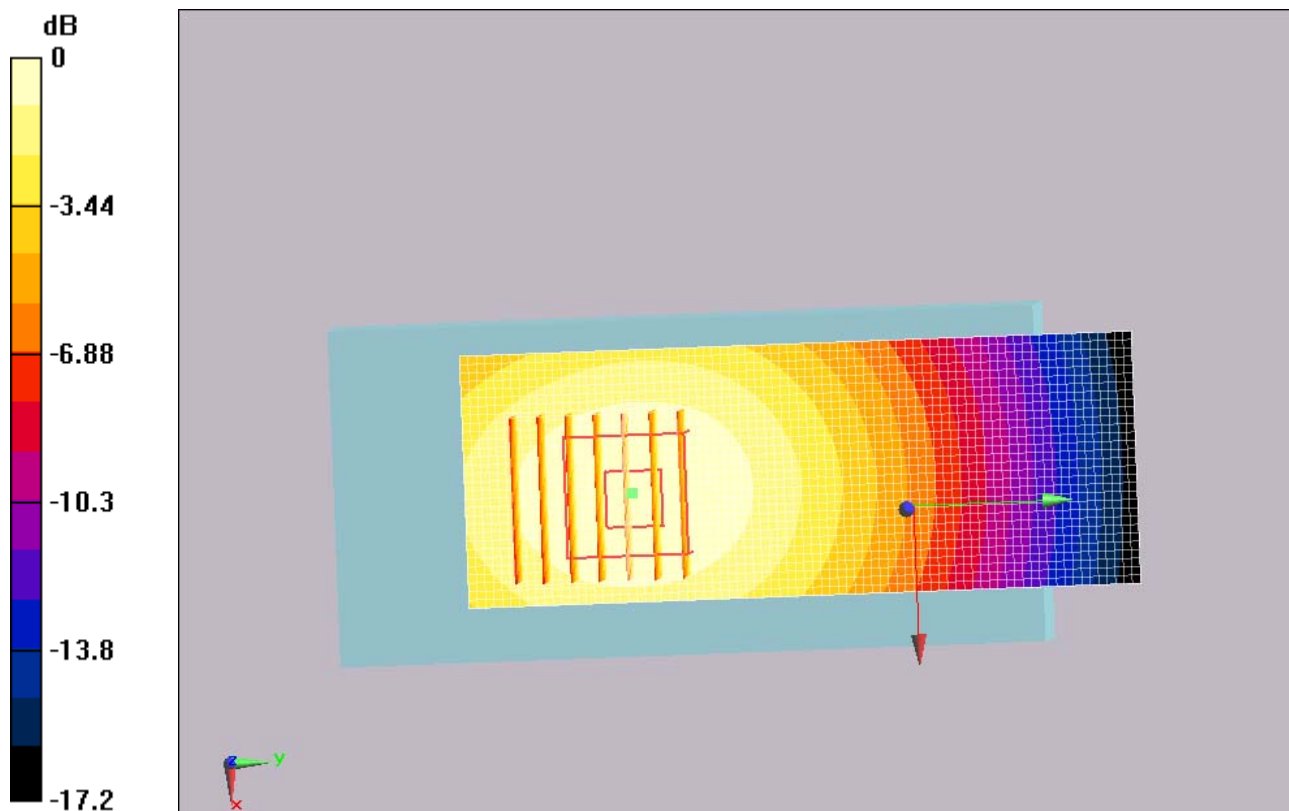

0 dB = 0.697mW/g

CITL Test

## B.4 Maximum body SAR of PCS1900 mode– Low channel, Back side with Belt,

Test Laboratory: CT Test Laboratory: CTTL

### FCC\_Body\_PCS1900\_Face\_Mid

**DUT: SONIM XP 1300-A; Type: SONIM XP 1300-A; Serial: EO110823Q00084**

Communication System: PCS 1900; Frequency: 1880 MHz; Duty Cycle: 1:8.3

Medium parameters used:  $f = 1880$  MHz;  $\sigma = 1.57$  mho/m;  $\epsilon_r = 53.5$ ;  $\rho = 1000$  kg/m<sup>3</sup>

Phantom section: Flat Section

Measurement Standard: DASY5 (IEEE/IEC)

DASY4 Configuration:

- Probe: ES3DV3 - SN3158; ConvF(4.58, 4.58, 4.58); Calibrated: 2010-5-20
- Sensor-Surface: 4mm (Mechanical Surface Detection)
- Electronics: DAE4 Sn549; Calibrated: 2010-5-20
- Phantom: ELI 4.0; Type: QDOVA001BA; Serial: TP-1472
- Measurement SW: DASY5, V5.0 Build 119; SEMCAD X Version 13.2 Build 87

**GSM\_Face\_Mid/Area Scan (51x91x1):** Measurement grid: dx=15mm, dy=15mm

Maximum value of SAR (interpolated) = 0.347 mW/g

**GSM\_Face\_Mid/Zoom Scan (7x7x6)/Cube 0:** Measurement grid: dx=5mm, dy=5mm, dz=5mm

Reference Value = 9.66 V/m; Power Drift = -0.081 dB

Peak SAR (extrapolated) = 0.492 W/kg

**SAR(1 g) = 0.313 mW/g; SAR(10 g) = 0.193 mW/g**

Maximum value of SAR (measured) = 0.339 mW/g

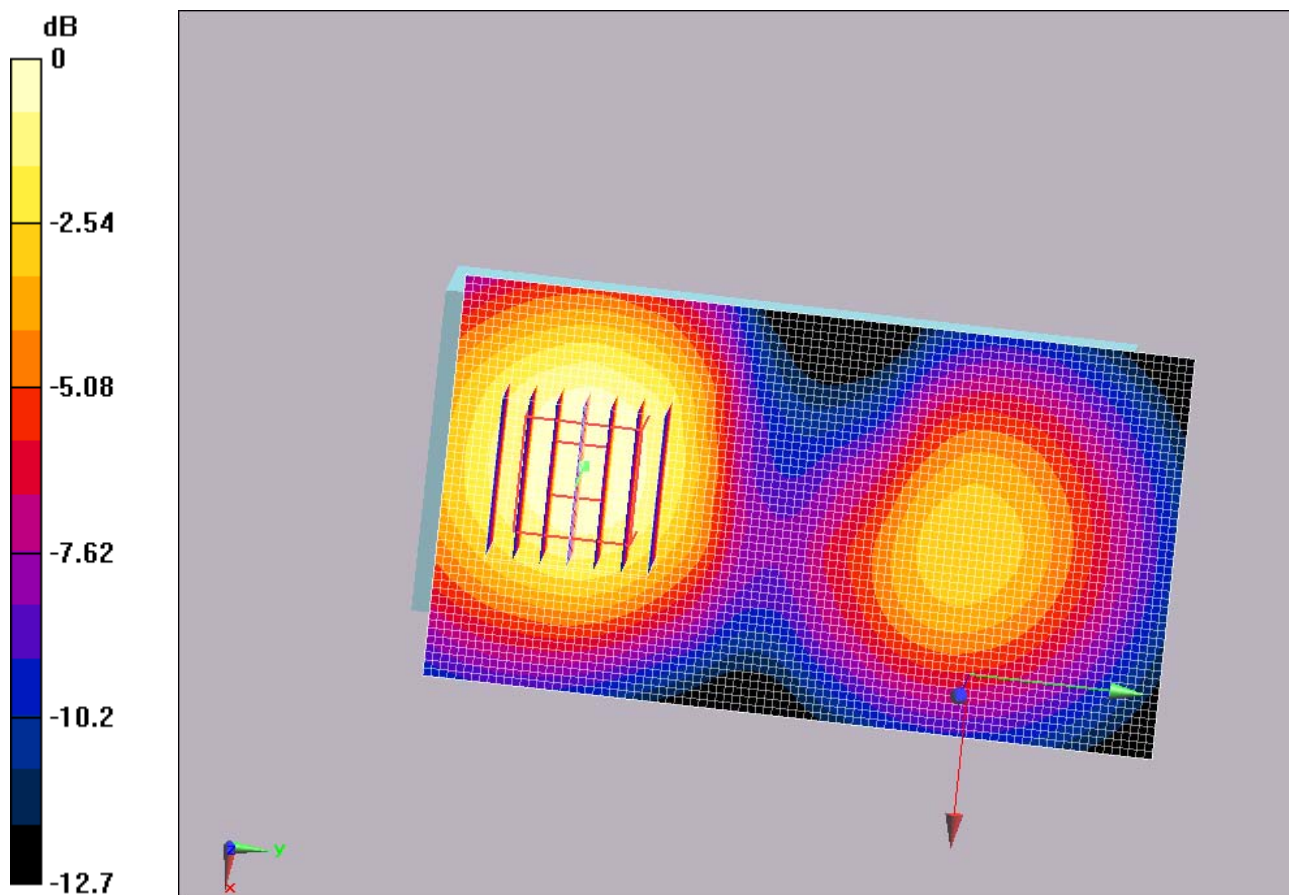

0 dB = 0.339mW/g

TTL Test

## Annex C System Performance Check Graphical Results

### C.1 Head 835 band

Test Laboratory: CTTL

#### Head\_Check\_D835

**DUT: Dipole 835 MHz; Type: D835V2; Serial: D835V2 - SN: 473**

Communication System: CW; Frequency: 835 MHz; Duty Cycle: 1:1

Medium parameters used:  $f = 835$  MHz;  $\sigma = 0.918$  mho/m;  $\epsilon_r = 42.3$ ;  $\rho = 1000$  kg/m<sup>3</sup>

Phantom section: Flat Section

Measurement Standard: DASYS (IEEE/IEC)

DASY4 Configuration:

- Probe: ES3DV3 - SN3158; ConvF(5.97, 5.97, 5.97); Calibrated: 2010-5-20
- Sensor-Surface: 3.4mm (Mechanical Surface Detection)
- Electronics: DAE4 Sn549; Calibrated: 2010-5-20
- Phantom: North SAM; Type: SAM; Serial: TP-1472
- Measurement SW: DASYS, V5.0 Build 119; SEMCAD X Version 13.2 Build 87

**d=15mm, Pin=24.00 dBm/Area Scan (31x91x1):** Measurement grid:

dx=15mm, dy=15mm

Maximum value of SAR (interpolated) = 2.94 mW/g

**d=15mm, Pin=24.00 dBm/Zoom Scan (7x7x7) (7x7x7)/Cube 0:**

Measurement grid: dx=5mm, dy=5mm, dz=5mm

Reference Value = 58.7 V/m; Power Drift = -0.364 dB

Peak SAR (extrapolated) = 3.93 W/kg

**SAR(1 g) = 2.59 mW/g; SAR(10 g) = 1.68 mW/g**

Maximum value of SAR (measured) = 2.94 mW/g

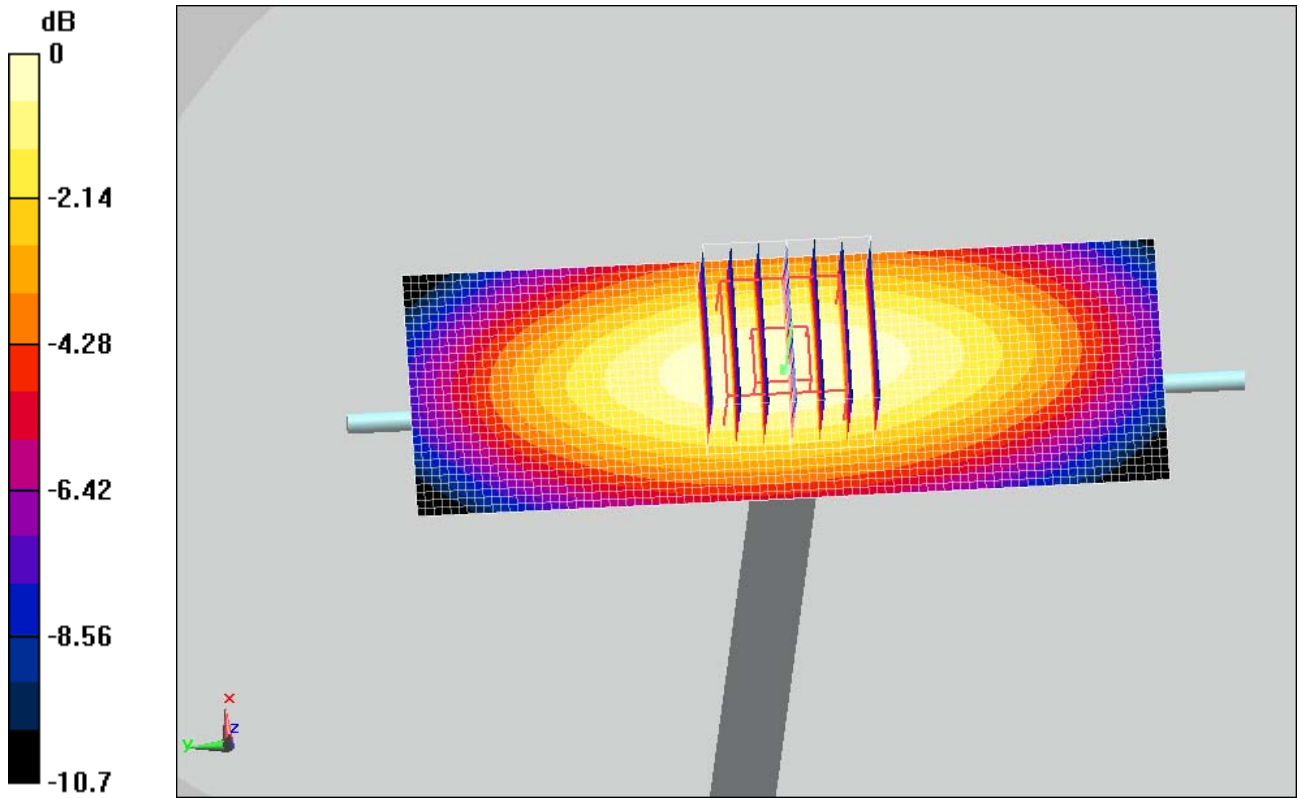

0 dB = 2.94mW/g

CITL TEST

## C.2 Head 1900 band

Test Laboratory: CTTL

### Head\_check\_D1900

**DUT: Dipole 1900 MHz; Type: D1900V2; Serial: D1900V2 - SN: 5d024**

Communication System: CW; Frequency: 1900 MHz; Duty Cycle: 1:1

Medium parameters used:  $f = 1900$  MHz;  $\sigma = 1.53$  mho/m;  $\epsilon_r = 40.2$ ;  $\rho = 1000$  kg/m<sup>3</sup>

Phantom section: Flat Section

Measurement Standard: DASYS (IEEE/IEC)

DASY4 Configuration:

- Probe: ES3DV3 - SN3158; ConvF(5, 5, 5); Calibrated: 2010-5-20
- Sensor-Surface: 3.4mm (Mechanical Surface Detection)
- Electronics: DAE4 Sn549; Calibrated: 2010-5-20
- Phantom: West SAM; Type: SAM; Serial: TP-1472
- Measurement SW: DASYS, V5.0 Build 119; SEMCAD X Version 13.2 Build 87

**d=10mm, Pin=24.00 dBm 2/Zoom Scan (7x7x7) (7x7x7)/Cube 0:**

Measurement grid: dx=5mm, dy=5mm, dz=5mm

Reference Value = 92.1 V/m; Power Drift = 0.00587 dB

Peak SAR (extrapolated) = 19.2 W/kg

**SAR(1 g) = 10.3 mW/g; SAR(10 g) = 5.32 mW/g**

Maximum value of SAR (measured) = 12.5 mW/g

**d=10mm, Pin=24.00 dBm 2/Area Scan (31x91x1):** Measurement grid:

dx=15mm, dy=15mm

Maximum value of SAR (interpolated) = 12.9 mW/g



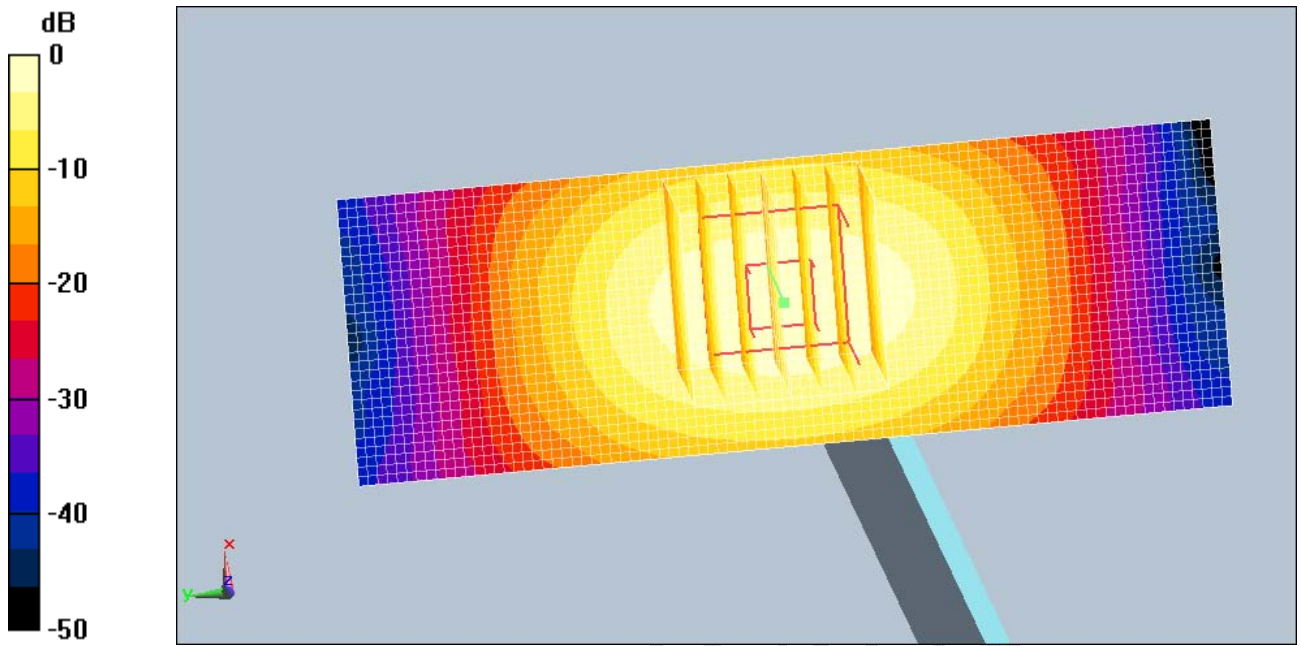

0 dB = 12.9mW/g

CITL Test Report

### C.3 Body 835 band

Test Laboratory: CTTL

#### Body\_Check\_D835

**DUT: Dipole 835 MHz; Type: D835V2; Serial: D835V2 - SN: 473**

Communication System: CW; Frequency: 835 MHz; Duty Cycle: 1:1

Medium parameters used:  $f = 835$  MHz;  $\sigma = 0.957$  mho/m;  $\epsilon_r = 55.4$ ;  $\rho = 1000$  kg/m<sup>3</sup>

Phantom section: Flat Section

Measurement Standard: DASYS (IEEE/IEC)

DASY4 Configuration:

- Probe: ES3DV3 - SN3158; ConvF(5.93, 5.93, 5.93); Calibrated: 2010-5-20
- Sensor-Surface: 3.4mm (Mechanical Surface Detection)
- Electronics: DAE4 Sn549; Calibrated: 2010-5-20
- Phantom: ELI 4.0; Type: QDOVA001BA; Serial: xxxx
- Measurement SW: DASYS, V5.0 Build 119; SEMCAD X Version 13.2 Build 87

**d=10mm, Pin=9.24 dBm/Area Scan (31x81x1):** Measurement grid: dx=15mm, dy=15mm

Maximum value of SAR (interpolated) = 2.6 mW/g

**d=10mm, Pin=9.24 dBm/Zoom Scan (7x7x7) (7x7x7)/Cube 0:**

Measurement grid: dx=5mm, dy=5mm, dz=5mm

Reference Value = 53.1 V/m; Power Drift = 0.017 dB

Peak SAR (extrapolated) = 3.35 W/kg

**SAR(1 g) = 2.32 mW/g; SAR(10 g) = 1.54 mW/g**

Maximum value of SAR (measured) = 2.61 mW/g

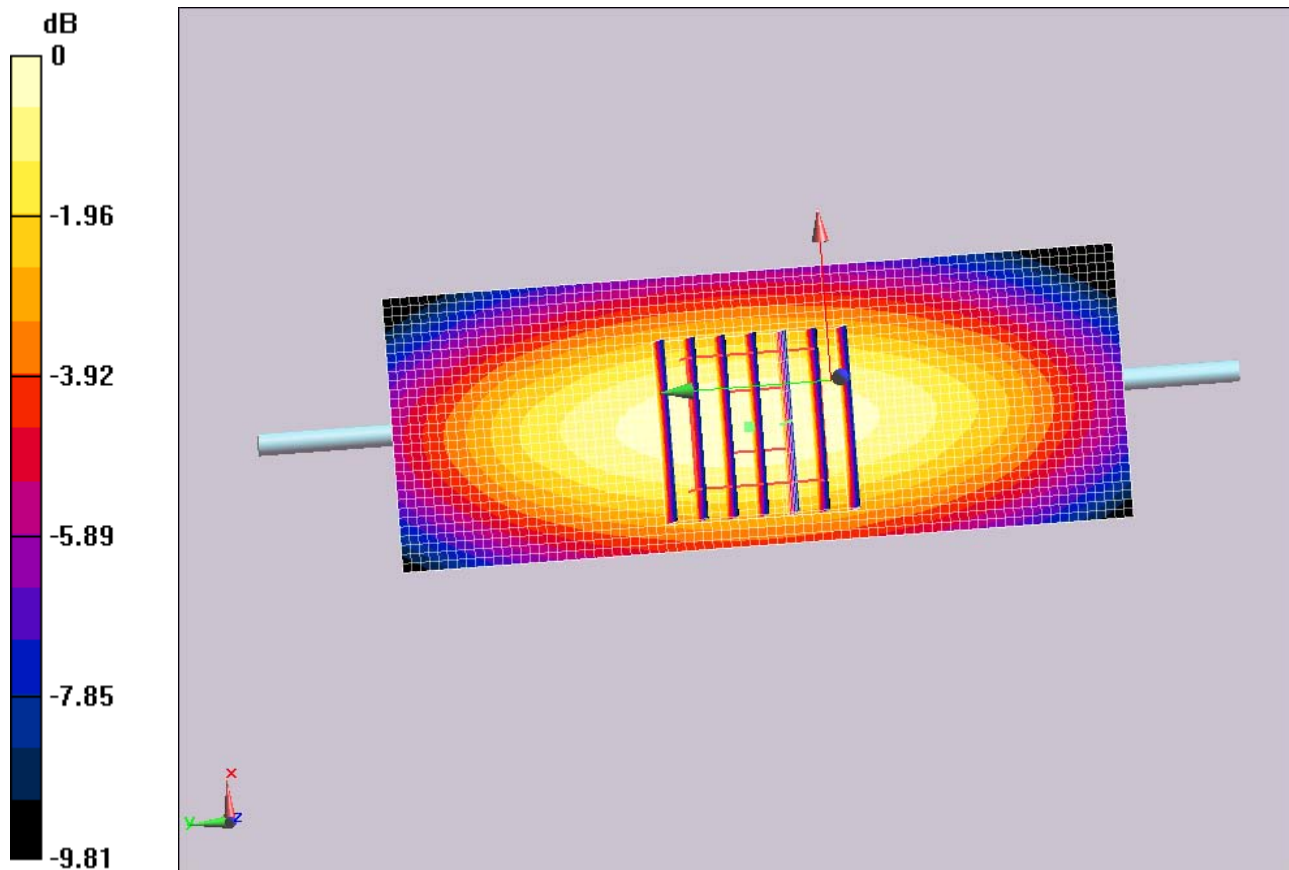

0 dB = 2.61mW/g

TTL TEST

## C.4 Body 1900 band

### Body\_Check\_D1900

**DUT: Dipole 1900 MHz; Type: D1900V2; Serial: D1900V2 - SN: 5d024**

Communication System: CW; Frequency: 1900 MHz; Duty Cycle: 1:1

Medium parameters used:  $f = 1900$  MHz;  $\sigma = 1.59$  mho/m;  $\epsilon_r = 53.4$ ;  $\rho = 1000$  kg/m<sup>3</sup>

Phantom section: Flat Section

Measurement Standard: DASYS (IEEE/IEC)

DASY4 Configuration:

- Probe: ES3DV3 - SN3158; ConvF(4.58, 4.58, 4.58); Calibrated: 2010-5-20
- Sensor-Surface: 3.4mm (Mechanical Surface Detection)
- Electronics: DAE4 Sn549; Calibrated: 2010-5-20
- Phantom: ELI 4.0; Type: QDOVA001BA; Serial: xxxx
- Measurement SW: DASYS, V5.0 Build 119; SEMCAD X Version 13.2 Build 87

**d=10mm, Pin=24 dBm 3/Area Scan (61x81x1):** Measurement grid: dx=15mm, dy=15mm

Maximum value of SAR (interpolated) = 13.3 mW/g

**d=10mm, Pin=24 dBm 3/Zoom Scan (7x7x7) (7x7x7)/Cube 0:** Measurement grid: dx=5mm, dy=5mm, dz=5mm

Reference Value = 89.6 V/m; Power Drift = 0.025 dB

Peak SAR (extrapolated) = 18.3 W/kg

**SAR(1 g) = 10.2 mW/g; SAR(10 g) = 5.23 mW/g**

Maximum value of SAR (measured) = 12.5 mW/g

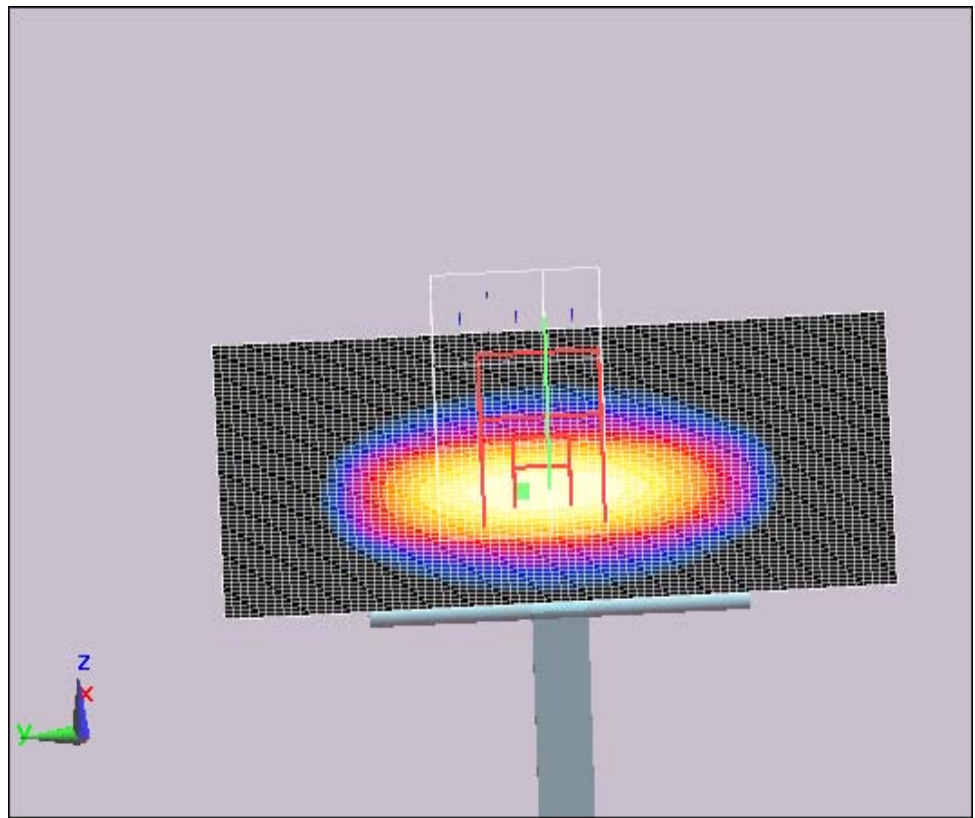
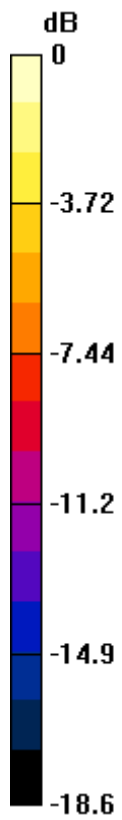

CITL TEST

## ANNEX D Probes Calibration Certificates

The System Validation was conducted following the requirements of standard IEEE 1528: 2003 Clause 8.3.

The scanned copy of the calibration certificate of the probe used is as following.

*China Test Report*

**Calibration Laboratory of  
Schmid & Partner  
Engineering AG**  
Zeughausstrasse 43, 8004 Zurich, Switzerland



**S** Schweizerischer Kalibrierdienst  
**C** Service suisse d'étalonnage  
**S** Servizio svizzero di taratura  
**S** Swiss Calibration Service

Accredited by the Swiss Accreditation Service (SAS)  
The Swiss Accreditation Service is one of the signatories to the EA  
Multilateral Agreement for the recognition of calibration certificates

Accreditation No.: **SCS 108**

Client **CTTL**

Certificate No: **ES3-3158\_May10**

### CALIBRATION CERTIFICATE

Object: **ES3DV3 - SN:3158**

Calibration procedure(s): **QA CAL-01.v6, QA CAL-23.v3 and QA CAL-25.v2  
Calibration procedure for dosimetric E-field probes**



Calibration date: **May 20, 2010**

This calibration certificate documents the traceability to national standards, which realize the physical units of measurements (SI).  
The measurements and the uncertainties with confidence probability are given on the following pages and are part of the certificate.

All calibrations have been conducted in the closed laboratory facility: environment temperature (22 ± 3)°C and humidity < 70%.

Calibration Equipment used (M&TE critical for calibration)

Primary Standards	ID #	Cal Date (Certificate No.)	Scheduled Calibration
Power meter E4419B	GB41293874	1-Apr-10 (No. 217-01138)	Apr-11
Power sensor E4412A	MY41495277	1-Apr-10 (No. 217-01138)	Apr-11
Power sensor E4412A	MY41498087	1-Apr-10 (No. 217-01138)	Apr-11
Reference 3 dB Attenuator	SN: S5054 (3c)	30-Mar-10 (No. 217-01159)	Mar-11
Reference 20 dB Attenuator	SN: S5086 (20b)	30-Mar-10 (No. 217-01161)	Mar-11
Reference 30 dB Attenuator	SN: S5129 (30b)	30-Mar-10 (No. 217-01160)	Mar-11
Reference Probe ES3DV2	SN: 3013	30-Dec-09 (No. ES3-3013_Dec09)	Dec-10
D4E4	SN: 860	20-Apr-10 (No. D4E4-060_Apr10)	Apr-11
Secondary Standards	ID #	Check Date (in house)	Scheduled Check
RF generator HP 8648C	US3842U01700	4-Aug-09 (in house check Oct-09)	In house check: Oct-11
Network Analyzer HP 8753E	US37390585	18-Oct-01 (in house check Oct-09)	In house check: Oct10

Calibrated by:	Name: <b>Jeton Kastrati</b>	Function: <b>Laboratory Technician</b>	Signature: 
Approved by:	Name: <b>Katja Pokovic</b>	Function: <b>Technical Manager</b>	Signature: 

Issued: May 22, 2010

This calibration certificate shall not be reproduced except in full without written approval of the laboratory.

**Calibration Laboratory of  
Schmid & Partner  
Engineering AG**  
Zeughausstrasse 43, 8004 Zurich, Switzerland



**S** Schweizerischer Kalibrierdienst  
**C** Service suisse d'étalonnage  
**S** Servizio svizzero di taratura  
**S** Swiss Calibration Service

Accredited by the Swiss Accreditation Service (SAS)  
The Swiss Accreditation Service is one of the signatories to the EA  
Multilateral Agreement for the recognition of calibration certificates

Accreditation No.: **SCS 108**

**Glossary:**

TSL	tissue simulating liquid
NORM <sub>x,y,z</sub>	sensitivity in free space
ConvF	sensitivity in TSL / NORM <sub>x,y,z</sub>
DCP	diode compression point
CF	crest factor (1/duty_cycle) of the RF signal
A, B, C	modulation dependent linearization parameters
Polarization $\varphi$	$\varphi$ rotation around probe axis
Polarization $\theta$	$\theta$ rotation around an axis that is in the plane normal to probe axis (at measurement center), i.e., $\theta = 0$ is normal to probe axis

**Calibration is Performed According to the Following Standards:**

- a) IEEE Std 1528-2003, "IEEE Recommended Practice for Determining the Peak Spatial-Averaged Specific Absorption Rate (SAR) in the Human Head from Wireless Communications Devices: Measurement Techniques", December 2003
- b) IEC 62209-1, "Procedure to measure the Specific Absorption Rate (SAR) for hand-held devices used in close proximity to the ear (frequency range of 300 MHz to 3 GHz)", February 2005

**Methods Applied and Interpretation of Parameters:**

- **NORM<sub>x,y,z</sub>:** Assessed for E-field polarization  $\theta = 0$  ( $f \leq 900$  MHz in TEM-cell;  $f > 1800$  MHz: R22 waveguide). NORM<sub>x,y,z</sub> are only intermediate values, i.e., the uncertainties of NORM<sub>x,y,z</sub> does not effect the E<sup>2</sup>-field uncertainty inside TSL (see below ConvF).
- **NORM(f)<sub>x,y,z</sub> = NORM<sub>x,y,z</sub> \* frequency\_response** (see Frequency Response Chart). This linearization is implemented in DASY4 software versions later than 4.2. The uncertainty of the frequency response is included in the stated uncertainty of ConvF.
- **DCP<sub>x,y,z</sub>:** DCP are numerical linearization parameters assessed based on the data of power sweep with CW signal (no uncertainty required). DCP does not depend on frequency nor media.
- **A<sub>x,y,z</sub>; B<sub>x,y,z</sub>; C<sub>x,y,z</sub>; VR<sub>x,y,z</sub>:** A, B, C are numerical linearization parameters assessed based on the data of power sweep for specific modulation signal. The parameters do not depend on frequency nor media. VR is the maximum calibration range expressed in RMS voltage across the diode.
- **ConvF and Boundary Effect Parameters:** Assessed in flat phantom using E-field (or Temperature Transfer Standard for  $f \leq 800$  MHz) and inside waveguide using analytical field distributions based on power measurements for  $f > 800$  MHz. The same setups are used for assessment of the parameters applied for boundary compensation (alpha, depth) of which typical uncertainty values are given. These parameters are used in DASY4 software to improve probe accuracy close to the boundary. The sensitivity in TSL corresponds to NORM<sub>x,y,z</sub> \* ConvF whereby the uncertainty corresponds to that given for ConvF. A frequency dependent ConvF is used in DASY version 4.4 and higher which allows extending the validity from  $\pm 50$  MHz to  $\pm 100$  MHz.
- **Spherical isotropy (3D deviation from isotropy):** in a field of low gradients realized using a flat phantom exposed by a patch antenna.
- **Sensor Offset:** The sensor offset corresponds to the offset of virtual measurement center from the probe tip (on probe axis). No tolerance required.



ES3DV3 SN:3158

May 20, 2010

# Probe ES3DV3

## SN:3158

Manufactured:	August 13, 2007
Last calibrated:	April 14, 2009
Recalibrated:	May 20, 2010

Calibrated for DASY/EASY Systems

(Note: non-compatible with DASY2 system!)

Certificate No: ES3-3158\_May10

Page 3 of 11

ES3DV3 SN:3158

May 20, 2010

**DASY/EASY - Parameters of Probe: ES3DV3 SN:3158**

**Basic Calibration Parameters**

	Sensor X	Sensor Y	Sensor Z	Unc (k=2)
Norm ( $\mu V/(V/m)^2$ ) <sup>A</sup>	1.14	1.23	1.22	± 10.1%
DCP (mV) <sup>B</sup>	93.9	93.8	91.6	

**Modulation Calibration Parameters**

UID	Communication System Name	PAR		A dB	B dBuV	C	VR mV	Unc <sup>E</sup> (k=2)
10000	CW	0.00	X	0.00	0.00	1.00	300.0	± 1.5%
			Y	0.00	0.00	1.00	300.0	
			Z	0.00	0.00	1.00	300.0	

The reported uncertainty of measurement is stated as the standard uncertainty of measurement multiplied by the coverage factor k=2, which for a normal distribution corresponds to a coverage probability of approximately 95%.

<sup>A</sup> The uncertainties of NormX,Y,Z do not affect the E<sup>2</sup>-field uncertainty inside TSL (see Pages 5 and 6).

<sup>B</sup> Numerical linearization parameter, uncertainty not required.

<sup>E</sup> Uncertainty is determined using the maximum deviation from linear response applying rectangular distribution and is expressed for the square of the field value.

ES3DV3 SN:3158

May 20, 2010

## DASY/EASY - Parameters of Probe: ES3DV3 SN:3158

### Calibration Parameter Determined in Head Tissue Simulating Media

f [MHz]	Validity [MHz] <sup>c</sup>	Permittivity	Conductivity	ConvF X	ConvF Y	ConvF Z	Alpha	Depth Unc (k=2)
835	± 50 / ± 100	41.5 ± 5%	0.90 ± 5%	5.97	5.97	5.97	0.69	1.18 ± 11.0%
900	± 50 / ± 100	41.5 ± 5%	0.97 ± 5%	5.86	5.86	5.86	0.73	1.16 ± 11.0%
1750	± 50 / ± 100	40.1 ± 5%	1.37 ± 5%	5.13	5.13	5.13	0.37	1.72 ± 11.0%
1900	± 50 / ± 100	40.0 ± 5%	1.40 ± 5%	5.00	5.00	5.00	0.41	1.58 ± 11.0%
1950	± 50 / ± 100	40.0 ± 5%	1.40 ± 5%	4.84	4.84	4.84	0.37	1.76 ± 11.0%
2450	± 50 / ± 100	39.2 ± 5%	1.80 ± 5%	4.43	4.43	4.43	0.44	1.68 ± 11.0%

<sup>c</sup> The validity of ± 100 MHz only applies for DASY v1.4 and higher (see Page 2). The uncertainty is the RSS of the ConvF uncertainty at calibration frequency and the uncertainty for the indicated frequency band.

ES3DV3 SN:3158

May 20, 2010

## DASY/EASY - Parameters of Probe: ES3DV3 SN:3158

### Calibration Parameter Determined in Body Tissue Simulating Media

f [MHz]	Validity [MHz] <sup>c</sup>	Permittivity	Conductivity	ConvF X	ConvF Y	ConvF Z	Alpha	Depth Unc (k=2)
835	± 50 / ± 100	55.2 ± 5%	0.97 ± 5%	5.93	5.93	5.93	0.77	1.20 ± 11.0%
900	± 50 / ± 100	55.0 ± 5%	1.05 ± 5%	5.84	5.84	5.84	0.83	1.13 ± 11.0%
1750	± 50 / ± 100	53.4 ± 5%	1.49 ± 5%	4.81	4.81	4.81	0.36	2.06 ± 11.0%
1900	± 50 / ± 100	53.3 ± 5%	1.52 ± 5%	4.58	4.58	4.58	0.32	2.41 ± 11.0%
1950	± 50 / ± 100	53.3 ± 5%	1.52 ± 5%	4.69	4.69	4.69	0.31	2.43 ± 11.0%
2450	± 50 / ± 100	52.7 ± 5%	1.95 ± 5%	4.20	4.20	4.20	0.66	1.29 ± 11.0%

<sup>c</sup> The validity of ± 100 MHz only applies for DASY v4.4 and higher (see Page 2). The uncertainty is the RSS of the ConvF uncertainty at calibration frequency and the uncertainty for the indicated frequency band.

ES3DV3 SN:3158

May 20, 2010

### Frequency Response of E-Field

(TEM-Cell:ifi110 EXX, Waveguide: R22)

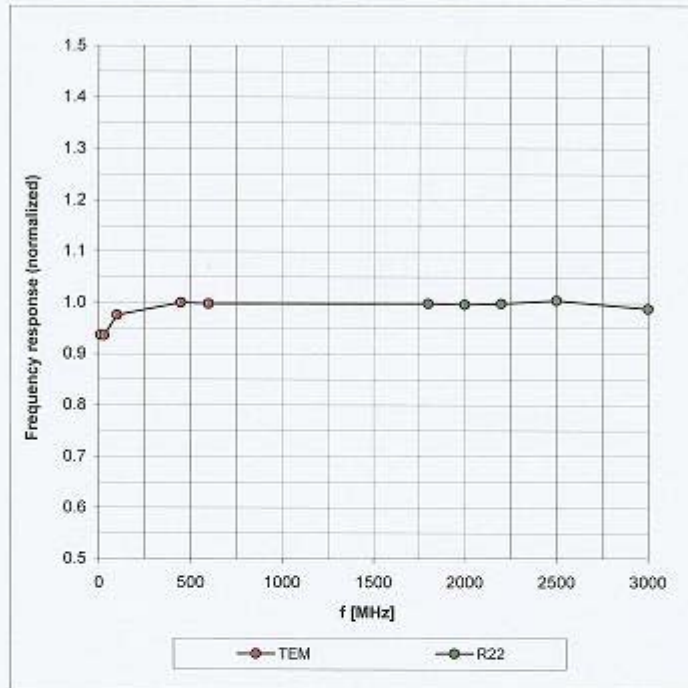

Uncertainty of Frequency Response of E-field:  $\pm 6.3\%$  (k=2)

ES3DV3 SN:3158

May 20, 2010

Receiving Pattern ( $\phi$ ),  $\vartheta = 0^\circ$

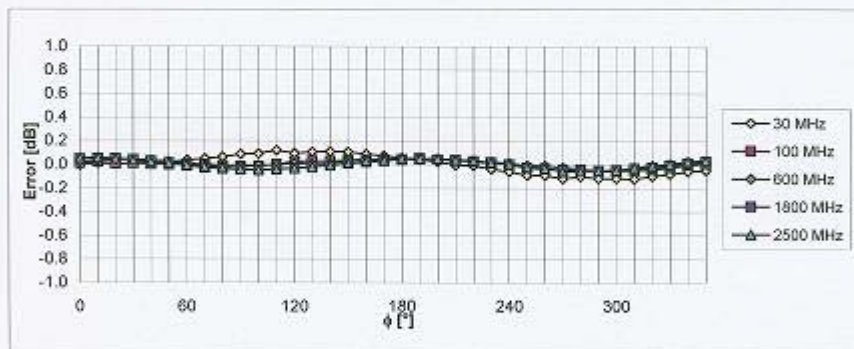
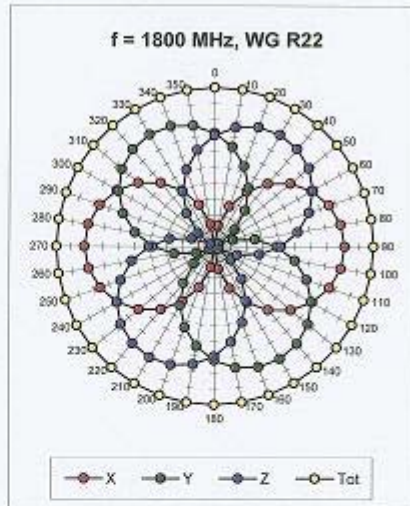
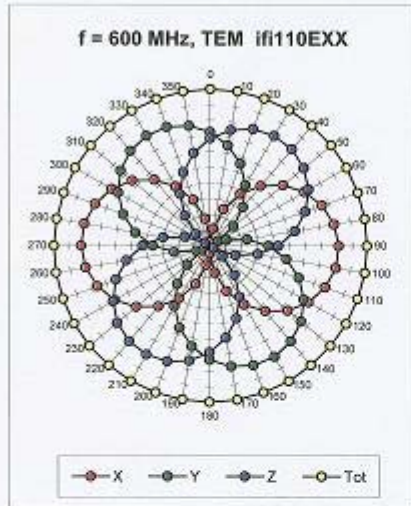

Uncertainty of Axial Isotropy Assessment:  $\pm 0.5\%$  ( $k=2$ )

ES3DV3 SN:3158

May 20, 2010

### Dynamic Range $f(\text{SAR}_{\text{head}})$ (Waveguide R22, $f = 1800 \text{ MHz}$ )

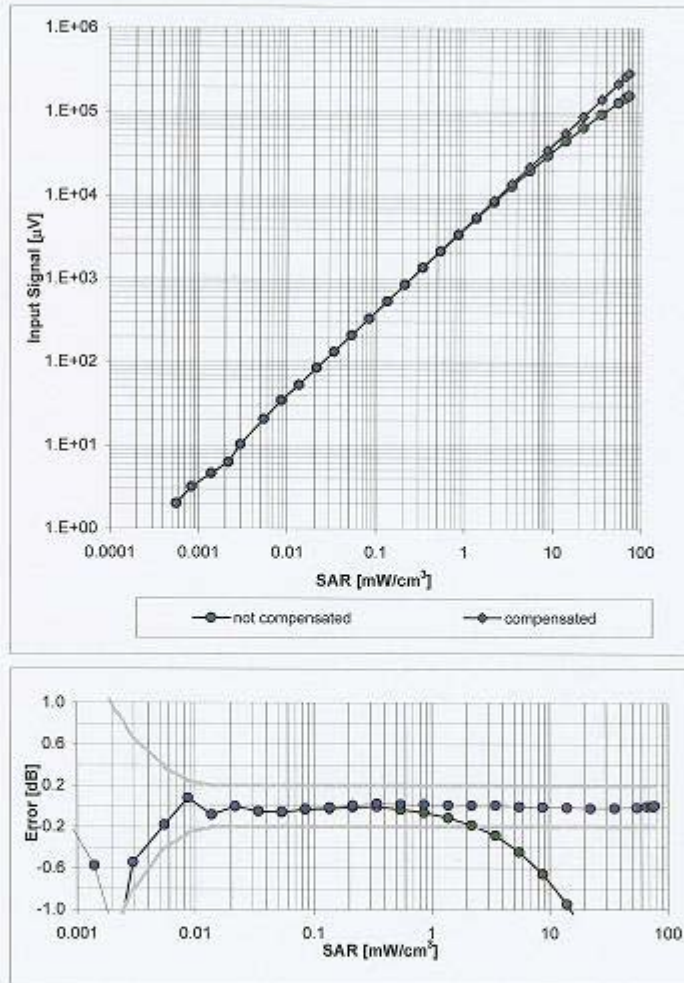

Uncertainty of Linearity Assessment:  $\pm 0.6\%$  ( $k=2$ )

ES3DV3 SN:3158

May 20, 2010

### Conversion Factor Assessment

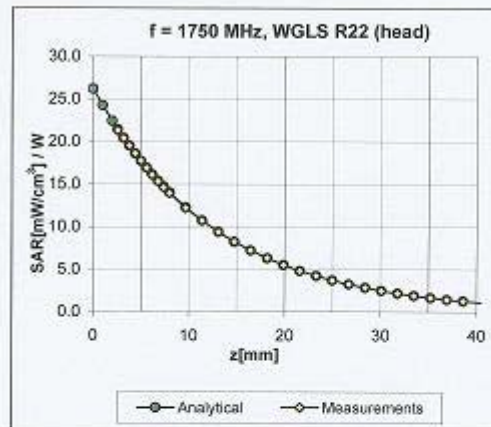
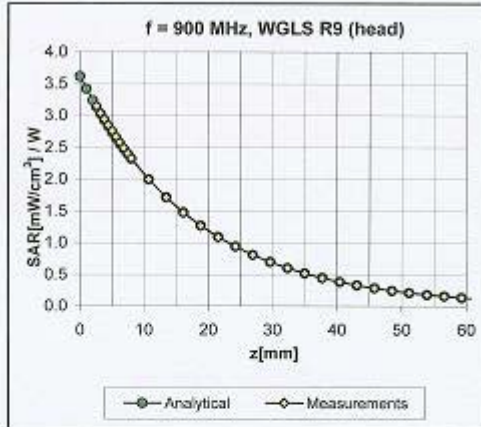

### Deviation from Isotropy in HSL

Error ( $\phi, \theta$ ),  $f = 900$  MHz

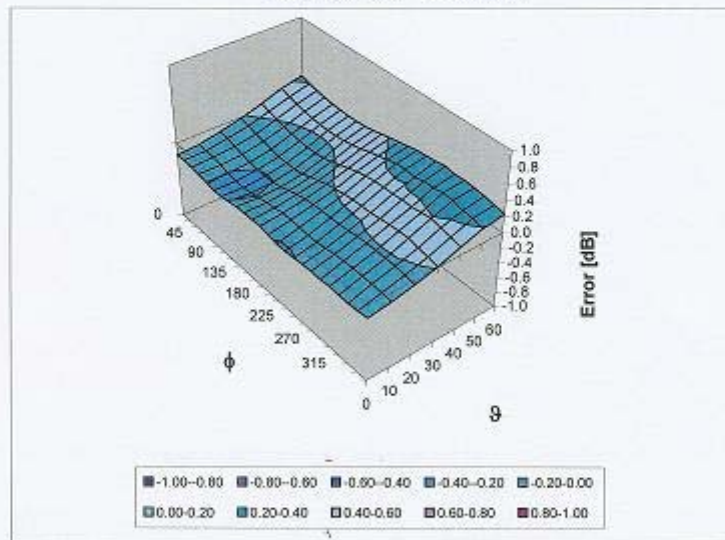

Uncertainty of Spherical Isotropy Assessment:  $\pm 2.6\%$  ( $k=2$ )



ES3DV3 SN:3158

May 20, 2010

### Other Probe Parameters

Sensor Arrangement	Triangular
Connector Angle (°)	Not applicable
Mechanical Surface Detection Mode	enabled
Optical Surface Detection Mode	disabled
Probe Overall Length	337 mm
Probe Body Diameter	10 mm
Tip Length	10 mm
Tip Diameter	4.0 mm
Probe Tip to Sensor X Calibration Point	2 mm
Probe Tip to Sensor Y Calibration Point	2 mm
Probe Tip to Sensor Z Calibration Point	2 mm
Recommended Measurement Distance from Surface	3 mm

## ANNEX E Deviations from Prescribed Test Methods

No deviation from Prescribed Test Methods.

————— **The End of this Report** —————

*China Test Report*