



TEST REPORT

No.B22N01626-SAR

For

Sonim Technologies, Inc.

Smart Phone

**Model Name: XP9900 (P14001), XP9900 (P14002), XP9900 (P14003),
XP9900 (P14004), XP9900 (P14005), XP9900 (P14006), XP9900
(P14010)**

With

Hardware Version: V1.0

Software Version: 10.0.0-01-12.0.0-10.60.10

FCC ID: WYPP14010

Issued Date: 2022-09-08

Designation Number: CN1210

Note:

The test results in this test report relate only to the devices specified in this report. This report shall not be reproduced except in full without the written approval of SAICT.

Test Laboratory:

SAICT, Shenzhen Academy of Information and Communications Technology

Building G, Shenzhen International Innovation Center, No.1006 Shennan Road, Futian District, Shenzhen,
Guangdong, P. R. China 518000.

Tel:+86(0)755-33322000, Fax:+86(0)755-33322001

Email: yewu@caict.ac.cn www.saict.ac.cn



REPORT HISTORY

Report Number	Revision	Description	Issue Date
B22N01626-SAR	Rev.0	1st edition	2022-09-08



TCONTENTS

1. SUMMARY OF TEST REPORT	5
1.1. TEST ITEMS	5
1.2. TEST STANDARDS	5
1.3. TEST RESULT.....	5
1.4. TESTING LOCATION	5
1.5. PROJECT DATA	5
1.6. SIGNATURE	5
2. STATEMENT OF COMPLIANCE	6
3. CLIENT INFORMATION	7
3.1. APPLICANT INFORMATION.....	7
3.2. MANUFACTURER INFORMATION	7
4. EQUIPMENT UNDER TEST (EUT) AND ANCILLARY EQUIPMENT (AE)	8
4.1. ABOUT EUT	8
4.2. INTERNAL IDENTIFICATION OF EUT USED DURING THE TEST	8
4.3. INTERNAL IDENTIFICATION OF AE USED DURING THE TEST	8
5. TEST METHODOLOGY	9
5.1. APPLICABLE LIMIT REGULATIONS.....	9
5.2. APPLICABLE MEASUREMENT STANDARDS	9
6. SPECIFIC ABSORPTION RATE (SAR).....	10
6.1. INTRODUCTION.....	10
6.2. SAR DEFINITION.....	10
7. TISSUE SIMULATING LIQUIDS	11
7.1. TARGETS FOR TISSUE SIMULATING LIQUID	11
7.2. DIELECTRIC PERFORMANCE	11
8. SYSTEM VERIFICATION	12
8.1. SYSTEM SETUP.....	12
8.2. SYSTEM VERIFICATION	13
9. MEASUREMENT PROCEDURES	14
9.1. TESTS TO BE PERFORMED.....	14
9.2. GENERAL MEASUREMENT PROCEDURE	16
9.3. SAR MEASUREMENT FOR LTE.....	17
9.4. LTE (TDD) CONSIDERATIONS.....	17
9.5. POWER DRIFT.....	18
10. CONDUCTED OUTPUT POWER	19
10.1. LTE MEASUREMENT RESULT.....	20



11. TRANSMIT ANTENNA32

 11.1. TRANSMIT ANTENNA SEPARATION DISTANCES 32

 11.2. SAR MEASUREMENT POSITIONS..... 33

12. EVALUATION OF SIMULTANEOUS.....34

13. SUMMARY OF TEST RESULTS.....35

 13.1. TESTING ENVIRONMENT 35

 13.2. TEST RESULT FOR SAR 36

14. SAR MEASUREMENT VARIABILITY37

15. MEASUREMENT UNCERTAINTY38

 15.1. MEASUREMENT UNCERTAINTY FOR NORMAL SAR TESTS (3GHZ~6GHZ) 38

16. MAIN TEST INSTRUMENTS.....39

ANNEX A: GRAPH RESULTS40

ANNEX B: SYSTEMVERIFICATION RESULTS.....42

ANNEX C: SAR MEASUREMENT SETUP.....43

 C.1. MEASUREMENT SET-UP 43

 C.2. DASY5 E-FIELD PROBE SYSTEM 44

 C.3. E-FIELD PROBE CALIBRATION..... 45

 C.4. OTHER TEST EQUIPMENT..... 46

ANNEX D: POSITION OF THE WIRELESS DEVICE IN RELATION TO THE PHANTOM49

 D.1. GENERAL CONSIDERATIONS 49

 D.2. BODY-WORN DEVICE 50

 D.3. DESKTOP DEVICE..... 50

 D.4. DUT SETUP PHOTOS..... 51

ANNEX E: EQUIVALENT MEDIA RECIPES52

ANNEX F: SYSTEM VALIDATION.....53

ANNEX G: DAE CALIBRATION CERTIFICATE54

ANNEX H: PROBE CALIBRATION CERTIFICATE57

ANNEX I: DIPOLE CALIBRATION CERTIFICATE66

ANNEX J: EXTENDED CALIBRATION SAR DIPOLE.....72



No.B22N01626-SAR

1. Summary of Test Report

1.1. Test Items

Description: Smart Phone
Model Name: XP9900 (P14001), XP9900 (P14002), XP9900 (P14003), XP9900 (P14004), XP9900 (P14005), XP9900 (P14006), XP9900 (P14010)
Applicant's Name: Sonim Technologies, Inc.
Manufacturer's Name: Sonim Technologies, Inc.

1.2. Test Standards

ANSI C95.1:1992, IEEE 1528:2013

1.3. Test Result

Pass. Please refer to "13. Summary of Test Results"

1.4. Testing Location

Address: Building G, Shenzhen International Innovation Center, No.1006 Shennan Road, Futian District, Shenzhen, Guangdong, P. R. China

1.5. Project Data

Testing Start Date: 2022-06-20

Testing End Date: 2022-06-20

1.6. Signature

Li Yongfu
(Prepared this test report)

Zhang Yunzhan
(Reviewed this test report)

Cao Junfei
(Approved this test report)

2. Statement of Compliance

The maximum results of Specific Absorption Rate (SAR) found during testing for Sonim Technologies, Inc. Smart Phone XP9900 (P14001), XP9900 (P14002), XP9900 (P14003), XP9900 (P14004), XP9900 (P14005), XP9900 (P14006), XP9900 (P14010) are as follows:

Table 2.1: Highest Reported SAR (1g)

Exposure Configuration	Technology Band	Highest Reported SAR 1g(W/Kg)	Equipment Class
Head (Separation Distance 0mm)	LTE Band 42 Part 27Q	0.20	PCE
Hotspot (Separation Distance 10mm)	LTE Band 42 Part 27Q	0.59	
Body-worn (Separation Distance 15mm)	LTE Band 42 Part 27Q	0.52	
Note: LTE Band 42(3550 - 3600MHz) / LTE Band 43(3600 - 3650MHz) SAR test is covered by LTE Band 48, due to similar frequency range, same maximum tune-up limit and same channel bandwidth. The LTE Band 48 SAR data is referenced to B22N01108-SAR report.			

The SAR values found for the Mobile Phone are below the maximum recommended levels of 1.6 W/Kg as averaged over any 1g tissue according to the ANSI C95.1-1992.

The measurement together with the test system set-up is described in annex C of this test report. A detailed description of the equipment under test can be found in chapter 4 of this test report.

The highest reported SAR value is obtained at the case of **(Table 2.1)**, Head value is **0.20 kg (1g)**, Hotspot value is **0.59 kg (1g)** and Body-worn value is **0.52 kg (1g)**.

Table 2.2: The sum of reported SAR values for WWAN and WLAN/Bluetooth antenna

/	Position	WWAN (W/kg)	WLAN + Bluetooth (W/kg)	Sum (W/kg)
Highest reported SAR value for Head	Left Cheek	0.14	0.61	0.75
Highest reported SAR value for Hotspot	Rear Side	0.59	0.39	0.98
Highest reported SAR value for Body-worn	Rear Side	0.52	0.52	1.04

Note: The test positions of above tables are for the worse case that has been evaluated.

According to the above tables, the highest sum of reported SAR values is **1.04 W/kg (1g)**.

The detail for simultaneous transmission consideration is described in chapter 12.



3. Client Information

3.1. Applicant Information

Company Name:	Sonim Technologies, Inc.
Address:	6500 River Place Blvd.Building 7, Suite 250 Austin, TX 78730 USA
City:	Austin
Country:	USA
Telephone:	1-650-378-8100

3.2. Manufacturer Information

Company Name:	Sonim Technologies, Inc.
Address:	6500 River Place Blvd.Building 7, Suite 250 Austin, TX 78730 USA
City:	Austin
Country:	USA
Telephone:	1-650-378-8100

4. Equipment under Test (EUT) and Ancillary Equipment (AE)

4.1. About EUT

Description:	Smart Phone
Model Name:	XP9900 (P14001), XP9900 (P14002), XP9900 (P14003), XP9900 (P14004), XP9900 (P14005), XP9900 (P14006), XP9900 (P14010)
Condition of EUT as received:	No obvious damage in appearance
Frequency Bands:	LTE Band 42/43
Tested Tx Frequency:	3400 - 3550MHz, 3550 - 3600MHz (LTE Band 42) 3600 - 3650MHz (LTE Band 43)
Test device Production information:	Production unit
Device type:	Portable device
Antenna type:	Integrated antenna
Hotspot mode:	Support
Product Dimensions:	Long 161mm; Wide 77.5mm
Display diagonal dimension:	153.5 mm
Remark:	
<p>1. All test results are based on XP9900 (P14001).</p> <p>2. LTE Band 42(3550 - 3600MHz) / LTE Band 43(3600 - 3650MHz) SAR test is covered by LTE Band 48, due to similar frequency range, same maximum tune-up limit and same channel bandwidth. The LTE Band 48 SAR data is referenced to B22N01108-SAR report.</p>	

4.2. Internal Identification of EUT used during the test

EUT ID*	IMEI	HW Version	SW Version	Receipt Date
UT01aa	016188000001367	V1.0	10.0.0-01-12.0.0-10.60.10	2022-05-12
UT02aa	016188000001334	V1.0	10.0.0-01-12.0.0-10.60.10	2022-05-12
UT06aa	016188000000192	V1.0	10.0.0-01-12.0.0-10.60.10	2022-05-12
UT08aa	016188000000187	V1.0	10.0.0-01-12.0.0-10.60.10	2022-05-12

*EUT ID: is used to identify the test sample in the lab internally.

Note: It is performed to test SAR with the UT06aa & UT08aa, and conducted power with the UT01aa & UT02aa.

4.3. Internal Identification of AE used during the test

AE ID*	Description	Model	Manufacturer
AE1	Battery	BAT-05000-01S	Dongguan Veken Battery Co., Ltd.

*AE ID: is used to identify the test sample in the lab internally.



5. Test Methodology

5.1. Applicable Limit Regulations

ANSI C95.1:1992 IEEE Standard for Safety Levels with Respect to Human Exposure to Radio Frequency Electromagnetic Fields, 3 kHz to 300 GHz.

It specifies the maximum exposure limit of **1.6 W/kg** as averaged over any 1 gram of tissue for portable devices being used within 20 cm of the user in the uncontrolled environment.

5.2. Applicable Measurement Standards

IEEE 1528:2013 Recommended Practice for Determining the Peak Spatial-Average Specific Absorption Rate (SAR) in the Human Head from Wireless Communications Devices: Experimental Techniques.

KDB 447498 D01 General RF Exposure Guidance v06 RF Exposure Procedures and Equipment Authorization Policies for Mobile and Portable Devices

KDB 648474 D04 Handset SAR v01r03 SAR Evaluation Considerations for Wireless Handsets.

KDB 941225 D05 SAR for LTE Devices v02r05 SAR Evaluation Considerations for LTE Devices

KDB 941225 D06 Hot Spot SAR v02r01 SAR Evaluation Procedures for Portable Devices with Wireless Router Capabilities

KDB 865664 D01 SAR measurement 100 MHz to 6 GHz v01r04 SAR Measurement Requirements for 100 MHz to 6 GHz

KDB 865664 D02 RF Exposure Reporting v01r02 RF Exposure Compliance Reporting and Documentation Considerations

KDB 941225 D07 UMPC Mini Tablet v01r02 SAR Evaluation Procedures for UMPC Mini-Tablet Devices

TCB workshop April 2019; RF Exposure Procedures (Tissue Simulating Liquids)

6. Specific Absorption Rate (SAR)

6.1. Introduction

SAR is related to the rate at which energy is absorbed per unit mass in an object exposed to a radio field. The SAR distribution in a biological body is complicated and is usually carried out by experimental techniques or numerical modeling. The standard recommends limits for two tiers of groups, occupational/controlled and general population/uncontrolled, based on a person's awareness and ability to exercise control over his or her exposure. In general, occupational/controlled exposure limits are higher than the limits for general population/uncontrolled.

6.2. SAR Definition

The SAR definition is the time derivative (rate) of the incremental energy (dW) absorbed by (dissipated in) an incremental mass (dm) contained in a volume element (dv) of a given density (ρ). The equation description is as below:

$$SAR = \frac{d}{dt} \left(\frac{dW}{dm} \right) = \frac{d}{dt} \left(\frac{dW}{\rho dv} \right)$$

SAR is expressed in units of Watts per kilogram (W/kg)

SAR measurement can be either related to the temperature elevation in tissue by

$$SAR = c \left(\frac{\delta T}{\delta t} \right)$$

Where: C is the specific heat capacity, δT is the temperature rise and δt is the exposure duration, or related to the electrical field in the tissue by

$$SAR = \frac{\sigma |E|^2}{\rho}$$

Where: σ is the conductivity of the tissue, ρ is the mass density of tissue and E is the RMS electrical field strength.

However for evaluating SAR of low power transmitter, electrical field measurement is typically applied.

7. Tissue Simulating Liquids

7.1. Targets for tissue simulating liquid

Table 7.1: Targets for tissue simulating liquid

Frequency (MHz)	Liquid Type	Conductivity (σ)	$\pm 5\%$ Range	Permittivity (ϵ)	$\pm 5\%$ Range
3500	Head	2.91	2.77~3.05	37.9	36.0~39.7

7.2. Dielectric Performance

Table 7.2: Dielectric Performance of Tissue Simulating Liquid

Measurement Date (yyyy-mm-dd)	Frequency (MHz)	Type	Conductivity σ (S/m)	Drift (%)	Permittivity ϵ	Drift (%)
2022-06-20	3500	Head	2.878	-1.10	38.46	1.48

Note: The liquid temperature is 22.0°C.



Picture 7-1: Liquid depth in the Head Phantom(3500MHz)

8. System verification

8.1. System Setup

In the simplified setup for system evaluation, the DUT is replaced by a calibrated dipole and the power source is replaced by a continuous wave that comes from a signal generator. The calibrated dipole must be placed beneath the flat phantom section of the SAM twin phantom with the correct distance holder. The distance holder should touch the phantom surface with a light pressure at the reference marking and be oriented parallel to the long side of the phantom. The equipment setup is shown below:

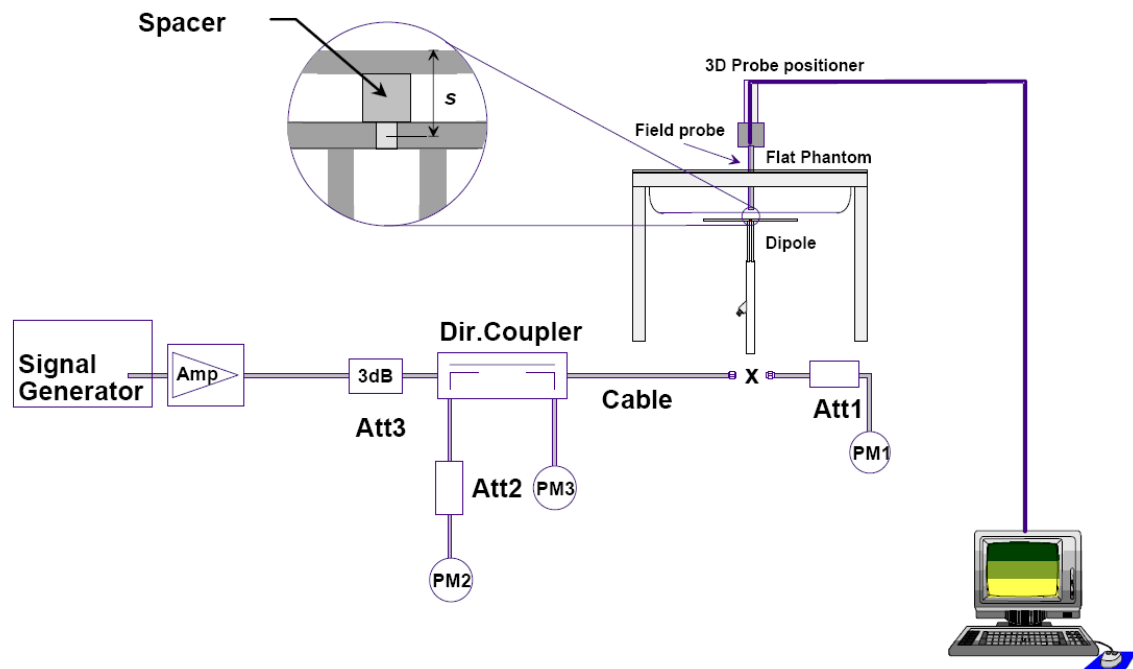

Picture 8.1 System Setup for System Evaluation

For the dipole below 3GHz, the output power on dipole port must be calibrated to 24 dBm (250mW) before dipole is connected.

For the dipole above 3GHz, the output power on dipole port must be calibrated to 20 dBm (100mW) before dipole is connected.

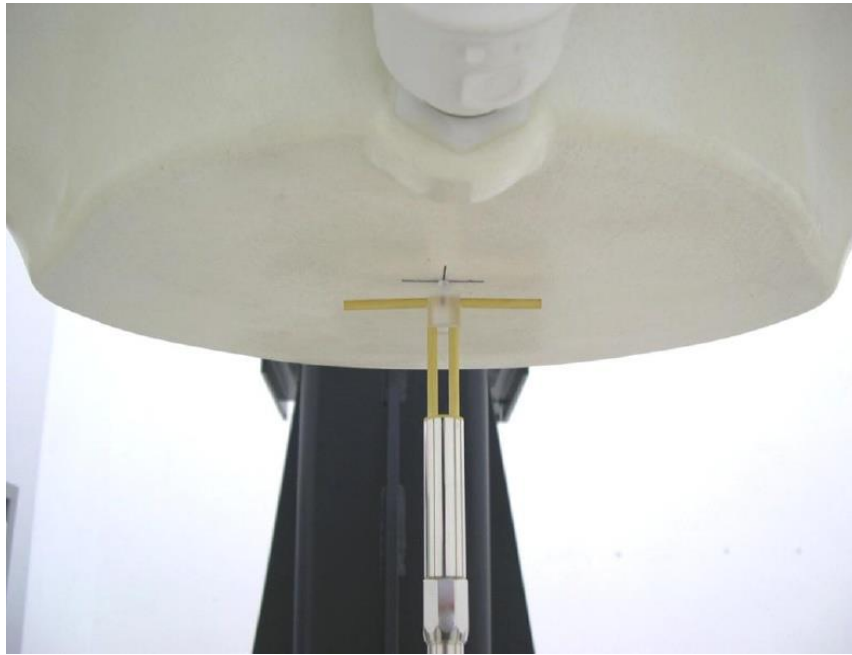

Picture 8.2 Photo of Dipole Setup

8.2. System Verification

SAR system verification is required to confirm measurement accuracy, according to the tissue dielectric media, probe calibration points and other system operating parameters required for measuring the SAR of a test device. The system verification must be performed for each frequency band and within the valid range of each probe calibration point required for testing the device.

Table 8.1: System Verification of Head

Measurement Date	Frequency (MHz)	Target value (W/kg)		Measured value (W/kg)				Deviation (%)	
		10 g	1 g	/		Normalize to 1W		10 g	1 g
				10 g	1 g	10 g	1 g		
2022-06-20	3500	25.20	66.80	2.45	6.39	24.50	63.90	-2.78	-4.34

9. Measurement Procedures

9.1. Tests to be performed

In order to determine the highest value of the peak spatial-average SAR of a handset, all device positions, configurations and operational modes shall be tested for each frequency band according to steps 1 to 3 below. A flowchart of the test process is shown in picture 9.1.

Step 1: The tests described in 9.2 shall be performed at the channel that is closest to the center of the transmit frequency band (f_c) for:

- a) all device positions (cheek and tilt, for both left and right sides of the SAM phantom, as described in annex D),
- b) all configurations for each device position in a), e.g., antenna extended and retracted, and
- c) all operational modes, e.g., analogue and digital, for each device position in a) and configuration in b) in each frequency band.

If more than three frequencies need to be tested according to 11.1 (i.e., $N_c > 3$), then all frequencies, configurations and modes shall be tested for all of the above test conditions.

Step 2: For the condition providing highest peak spatial-average SAR determined in Step 1, perform all tests described in 9.2 at all other test frequencies, i.e., lowest and highest frequencies. In addition, for all other conditions (device position, configuration and operational mode) where the peak spatial-average SAR value determined in Step 1 is within 3 dB of the applicable SAR limit, it is recommended that all other test frequencies shall be tested as well.

Step 3: Examine all data to determine the highest value of the peak spatial-average SAR found in Steps 1 to 2.

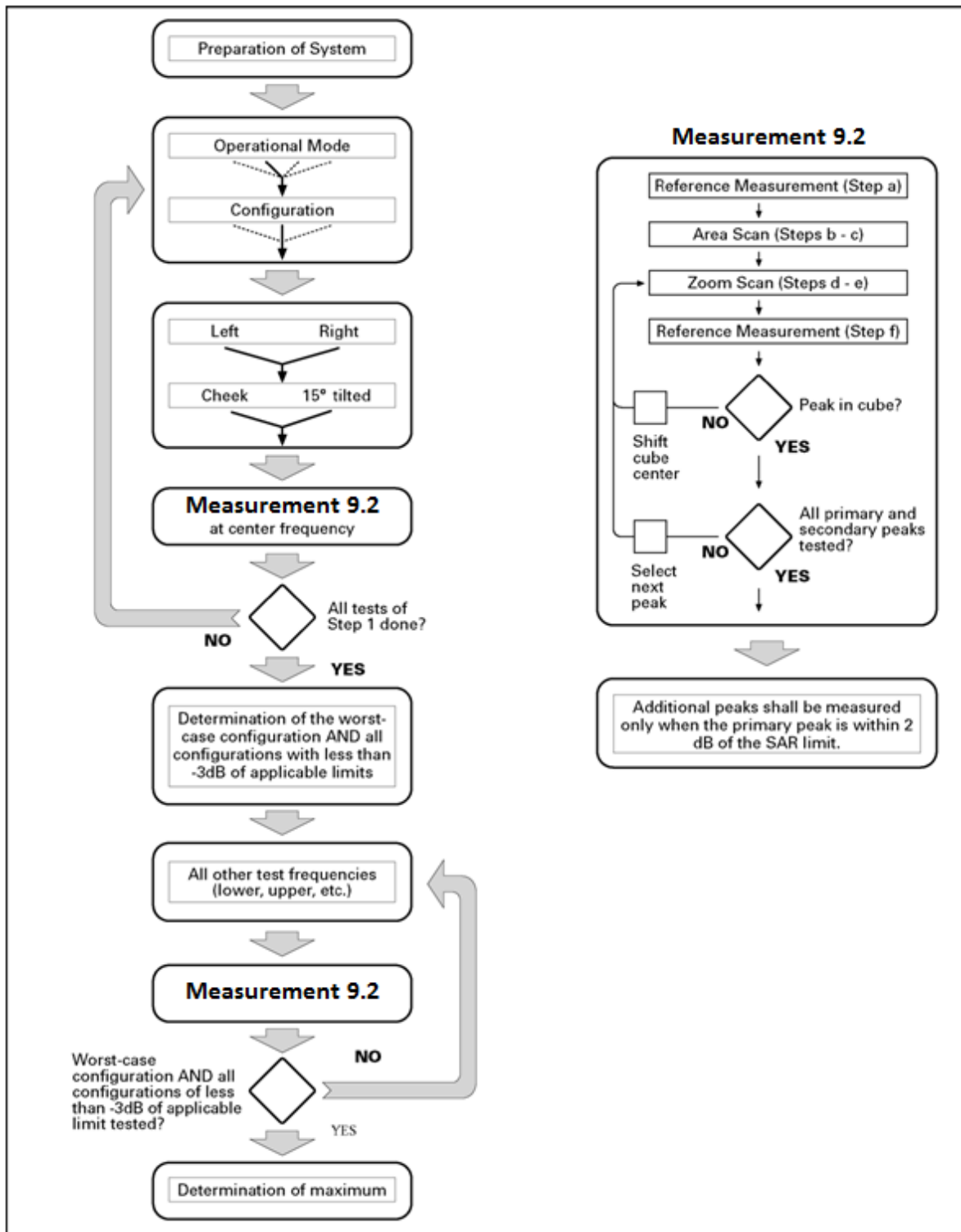

Picture 9.1 Block diagram of the tests to be performed

9.2. General Measurement Procedure

The area and zoom scan resolutions specified in the table below must be applied to the SAR measurements and fully documented in SAR reports to qualify for TCB approval. Probe boundary effect error compensation is required for measurements with the probe tip closer than half a probe tip diameter to the phantom surface. Both the probe tip diameter and sensor offset distance must satisfy measurement protocols; to ensure probe boundary effect errors are minimized and the higher fields closest to the phantom surface can be correctly measured and extrapolated to the phantom surface for computing 1-g SAR. Tolerances of the post-processing algorithms must be verified by the test laboratory for the scan resolutions used in the SAR measurements, according to the reference distribution functions specified in IEEE Std 1528-2013. The results should be documented as part of the system validation records and may be requested to support test results when all the measurement parameters in the following table are not satisfied.

		≤ 3 GHz	> 3 GHz	
Maximum distance from closest measurement point (geometric center of probe sensors) to phantom surface		5 ± 1 mm	$\frac{1}{2} \cdot \delta \cdot \ln(2) \pm 0.5$ mm	
Maximum probe angle from probe axis to phantom surface normal at the measurement location		$30^\circ \pm 1^\circ$	$20^\circ \pm 1^\circ$	
Maximum area scan spatial resolution: Δx_{Area} , Δy_{Area}		≤ 2 GHz: ≤ 15 mm 2 – 3 GHz: ≤ 12 mm	3 – 4 GHz: ≤ 12 mm 4 – 6 GHz: ≤ 10 mm	
		When the x or y dimension of the test device, in the measurement plane orientation, is smaller than the above, the measurement resolution must be \leq the corresponding x or y dimension of the test device with at least one measurement point on the test device.		
Maximum zoom scan spatial resolution: Δx_{Zoom} , Δy_{Zoom}		≤ 2 GHz: ≤ 8 mm 2 – 3 GHz: ≤ 5 mm*	3 – 4 GHz: ≤ 5 mm* 4 – 6 GHz: ≤ 4 mm*	
Maximum zoom scan spatial resolution, normal to phantom surface	uniform grid: $\Delta z_{Zoom}(n)$	≤ 5 mm	3 – 4 GHz: ≤ 4 mm 4 – 5 GHz: ≤ 3 mm 5 – 6 GHz: ≤ 2 mm	
	graded grid	$\Delta z_{Zoom}(1)$: between 1 st two points closest to phantom surface	≤ 4 mm	3 – 4 GHz: ≤ 3 mm 4 – 5 GHz: ≤ 2.5 mm 5 – 6 GHz: ≤ 2 mm
		$\Delta z_{Zoom}(n>1)$: between subsequent points	$\leq 1.5 \cdot \Delta z_{Zoom}(n-1)$	
Minimum zoom scan volume	x, y, z	≥ 30 mm	3 – 4 GHz: ≥ 28 mm 4 – 5 GHz: ≥ 25 mm 5 – 6 GHz: ≥ 22 mm	
Note: δ is the penetration depth of a plane-wave at normal incidence to the tissue medium; see draft standard IEEE P1528-2011 for details. * When zoom scan is required and the <i>reported</i> SAR from the area scan based 1-g SAR estimation procedures of KDB 447498 is ≤ 1.4 W/kg, ≤ 8 mm, ≤ 7 mm and ≤ 5 mm zoom scan resolution may be applied, respectively, for 2 GHz to 3 GHz, 3 GHz to 4 GHz and 4 GHz to 6 GHz.				

9.3. SAR Measurement for LTE

SAR tests for LTE are performed with a base station simulator, Anristu MT8820C. Closed loop power control was used so the UE transmits with maximum output power during SAR testing. All powers were measured with the Anristu MT8820C. It is performed for conducted power and SAR based on the KDB941225 D05.

SAR is evaluated separately according to the following procedures for the different test positions in each exposure condition – head, body, body-worn accessories and other use conditions. The procedures in the following subsections are applied separately to test each LTE frequency band.

1) QPSK with 1 RB allocation

Start with the largest channel bandwidth and measure SAR for QPSK with 1 RB allocation, using the RB offset and required test channel combination with the highest maximum output power among RB offsets at the upper edge, middle and lower edge of each required test channel. When the reported SAR is ≤ 0.8 W/kg, testing of the remaining RB offset configurations and required test channels is not required for 1 RB allocation; otherwise, SAR is required for the remaining required test channels and only for the RB offset configuration with the highest output power for that channel. When the reported SAR of a required test channel is > 1.45 W/kg, SAR is required for all three RB offset configurations for that required test channel.

2) QPSK with 50% RB allocation

The procedures required for 1 RB allocation in 1) are applied to measure the SAR for QPSK with 50% RB allocation.

3) QPSK with 100% RB allocation

For QPSK with 100% RB allocation, SAR is not required when the highest maximum output power for 100 % RB allocation is less than the highest maximum output power in 50% and 1 RB allocations and the highest reported SAR for 1 RB and 50% RB allocation in 1) and 2) are ≤ 0.8 W/kg. Otherwise, SAR is measured for the highest output power channel; and if the reported SAR is > 1.45 W/kg, the remaining required test channels must also be tested.

9.4. LTE (TDD) Considerations

According to KDB 941225 D05 SAR for LTE Devices, for Time-Division Duplex (TDD) systems, SAR must be tested using a fixed periodic duty factor according to the highest transmission duty factor implemented for the device and supported by the defined 3GPP LTE TDD configurations.

SAR was tested with the highest transmission duty factor (63.33%) using Uplink-downlink configuration 0 and Special subframe configuration 7.

LTE TDD Band 42/43 support 3GPP TS 36.211 section 4.2 for Type 2 Frame Structure and Table 4.2-2 for uplink-downlink configurations and Table 4.2-1 for Special subframe configurations.

Special subframe configuration	Normal cyclic prefix in downlink			Extended cyclic prefix in downlink		
	DwPTS	UpPTS		DwPTS	UpPTS	
		Normal cyclic prefix in uplink	Extended cyclic prefix in uplink		Normal cyclic prefix in uplink	Extended cyclic prefix in uplink
0	$6592 \cdot T_s$	$2192 \cdot T_s$	$2560 \cdot T_s$	$7680 \cdot T_s$	$2192 \cdot T_s$	$2560 \cdot T_s$
1	$19760 \cdot T_s$			$20480 \cdot T_s$		
2	$21952 \cdot T_s$			$23040 \cdot T_s$		
3	$24144 \cdot T_s$			$25600 \cdot T_s$		
4	$26336 \cdot T_s$			$7680 \cdot T_s$		
5	$6592 \cdot T_s$	$4384 \cdot T_s$	$5120 \cdot T_s$	$20480 \cdot T_s$	$4384 \cdot T_s$	$5120 \cdot T_s$
6	$19760 \cdot T_s$			$23040 \cdot T_s$		
7	$21952 \cdot T_s$			$12800 \cdot T_s$		
8	$24144 \cdot T_s$			-		
9	$13168 \cdot T_s$			-		

Configuration of special subframe (lengths of DwPTS/GP/UpPTS)

Uplink-Downlink Configuration	Downlink-to-Uplink Switch-point Periodicity	Subframe Number										Calculated Duty Cycle (%)
		0	1	2	3	4	5	6	7	8	9	
0	5 ms	D	S	U	U	U	D	S	U	U	U	63.33
1	5 ms	D	S	U	U	D	D	S	U	U	D	43.33
2	5 ms	D	S	U	D	D	D	S	U	D	D	23.33
3	10 ms	D	S	U	U	U	D	D	D	D	D	31.67
4	10 ms	D	S	U	U	D	D	D	D	D	D	21.67
5	10 ms	D	S	U	D	D	D	D	D	D	D	11.67
6	5 ms	D	S	U	U	U	D	S	U	U	D	53.33

Calculated Duty Cycle

Calculated Duty Cycle = Extended cyclic prefix in uplink x (T_s) x # of S + # of U

Example for Calculated Duty Cycle for Uplink-Downlink Configuration 0:

Calculated Duty Cycle = $5120 \times [1/(15000 \times 2048)] \times 2 + 6 \text{ ms} = 63.33\%$

Where

$T_s = 1/(15000 \times 2048)$ seconds

9.5. Power Drift

To control the output power stability during the SAR test, DASY5 system calculates the power drift by measuring the E-field at the same location at the beginning and at the end of the measurement for each test position. These drift values can be found in Section 14 labeled as: (Power Drift [dB]). This ensures that the power drift during one measurement is within 5%.



10. Conducted Output Power

Table 10.1: Summary of reduced power level - WWAN antenna

Receiver on (Head)	Receiver off + Hotspot on (Body) – Hotspot	Receiver off + Hotspot off (Body) – Body-Worn
Power Level A1	Power Level B1	Power Level C1

Maximum Target Power for Production Unit – Power Level A1/B1/C1

Band	Tune up (dBm)		
	Power Level A1	Power Level B1	Power Level C1
LTE Band 42 27Q	24.0	21.0	23.0

10.1. LTE Measurement result

According to April 2015 TCB workshop, SAR Test exclusion can be applied for testing overlapping LTE Bands as follows:

- a) The maximum out power, including tolerance, for the smaller band must be \leq the larger band to qualify for SAR test exclusion.
- b) The channel bandwidth and other operating parameters for the smaller band must be fully supported by the larger band.

LTE Band 42(3550 - 3600MHz) / LTE Band 43(3600 - 3650MHz) is covered by LTE Band 48(3550 - 3700MHz)

Table 10.2: The conducted Power for LTE

Power Level A1						
LTE Band 42 Part 27Q			Actual output Power (dBm)			
Band-width	RB No. / RB offset	Frequency (MHz)	Modulation			
			QPSK	16QAM	64QAM	256QAM
5 MHz	1RB_24	3547.5	22.72	22.03	20.69	17.65
		3500.0	22.91	22.30	20.87	17.90
		3452.5	23.13	22.49	21.05	17.98
	1RB_12	3547.5	22.86	22.04	20.75	17.81
		3500.0	23.00	22.21	20.74	17.67
		3452.5	23.13	22.45	21.04	17.98
	1RB_0	3547.5	22.76	22.13	20.72	17.67
		3500.0	22.95	22.19	20.81	17.76
		3452.5	23.19	22.55	21.05	18.10
	12RB_13	3547.5	21.82	20.91	19.91	17.95
		3500.0	22.01	21.00	20.03	18.02
		3452.5	22.27	21.31	20.29	18.27
	12RB_6	3547.5	21.84	20.95	20.03	17.98
		3500.0	22.07	21.18	20.14	18.08
		3452.5	22.35	21.37	20.48	18.43
	12RB_0	3547.5	21.85	21.01	19.91	17.88
		3500.0	22.07	20.98	19.98	17.93
		3452.5	22.33	21.43	20.36	18.27
	25RB_0	3547.5	21.84	20.95	19.93	17.92
		3500.0	22.00	21.12	20.15	18.18
		3452.5	22.29	21.34	20.45	18.24

Power Level A1						
LTE Band 42 Part 27Q			Actual output Power (dBm)			
Band-width	RB No. / RB offset	Frequency (MHz)	Modulation			
			QPSK	16QAM	64QAM	256QAM
10 MHz	1RB_49	3545.0	22.68	22.08	20.74	17.68
		3500.0	22.86	22.11	20.64	17.62
		3455.0	23.21	22.55	20.97	18.04
	1RB_24	3545.0	22.83	22.02	20.64	17.87
		3500.0	22.93	22.15	20.80	17.85
		3455.0	23.14	22.47	21.18	18.19
	1RB_0	3545.0	22.79	22.12	20.74	17.81
		3500.0	23.07	22.38	20.91	17.89
		3455.0	23.28	22.62	21.09	18.13
	25RB_25	3545.0	21.88	20.94	20.00	17.98
		3500.0	22.00	20.98	20.06	18.08
		3455.0	22.33	21.33	20.37	18.41
	25RB_12	3545.0	21.96	21.00	20.03	18.06
		3500.0	22.00	21.08	20.19	18.13
		3455.0	22.30	21.40	20.48	18.29
	25RB_0	3545.0	21.92	20.99	20.05	18.11
		3500.0	22.01	21.08	20.09	18.12
		3455.0	22.31	21.42	20.45	18.27
	50RB_0	3545.0	21.96	20.98	19.89	17.86
		3500.0	21.93	20.98	19.98	17.99
		3455.0	22.32	21.34	20.28	18.35

Power Level A1						
LTE Band 42 Part 27Q			Actual output Power (dBm)			
Band-width	RB No. / RB offset	Frequency (MHz)	Modulation			
			QPSK	16QAM	64QAM	256QAM
15 MHz	1RB_74	3542.5	22.46	21.76	20.34	17.92
		3500.0	22.68	21.99	20.42	18.01
		3457.5	22.79	22.22	20.71	18.38
	1RB_37	3542.5	22.55	21.88	20.43	18.10
		3500.0	22.65	22.01	20.60	18.15
		3457.5	22.88	22.28	20.76	18.32
	1RB_0	3542.5	22.57	21.97	20.52	18.17
		3500.0	22.67	22.06	20.59	18.19
		3457.5	22.99	22.28	20.88	18.32
	36RB_38	3542.5	21.70	20.70	19.77	18.24
		3500.0	21.87	20.85	19.79	18.25
		3457.5	22.11	21.11	20.02	18.46
	36RB_19	3542.5	21.74	20.80	19.76	18.22
		3500.0	21.82	20.86	19.84	18.20
		3457.5	22.10	21.17	20.17	18.23
	36RB_0	3542.5	21.83	20.82	19.79	18.18
		3500.0	21.99	20.93	19.89	18.36
		3457.5	22.21	21.22	20.11	18.55
	75RB_0	3542.5	21.83	20.81	19.76	18.10
		3500.0	21.88	20.86	19.90	18.37
		3457.5	22.18	21.16	20.07	18.41

Power Level A1						
LTE Band 42 Part 27Q			Actual output Power (dBm)			
Band-width	RB No. / RB offset	Frequency (MHz)	Modulation			
			QPSK	16QAM	64QAM	256QAM
20 MHz	1RB_99	3540.0	22.76	21.90	20.33	17.99
		3500.0	22.79	21.97	20.44	18.05
		3460.0	22.81	22.16	20.69	18.27
	1RB_50	3540.0	22.80	21.90	20.38	17.92
		3500.0	22.79	22.02	20.53	18.19
		3460.0	22.80	22.22	20.76	18.38
	1RB_0	3540.0	22.88	21.99	20.52	18.05
		3500.0	22.89	22.03	20.63	18.27
		3460.0	22.98	22.34	20.85	18.37
	50RB_50	3540.0	21.73	20.79	19.73	18.29
		3500.0	21.81	20.85	19.76	18.36
		3460.0	22.09	21.06	20.01	18.37
	50RB_25	3540.0	21.79	20.84	19.82	18.19
		3500.0	21.81	20.91	19.81	18.16
		3460.0	22.13	21.18	20.15	18.25
	50RB_0	3540.0	21.85	20.85	19.85	18.16
		3500.0	21.94	20.98	19.95	18.27
		3460.0	22.22	21.28	20.21	18.27
	100RB_0	3540.0	21.82	20.82	19.86	18.23
		3500.0	21.81	20.88	19.86	18.21
		3460.0	22.16	21.14	20.20	18.30

Power Level B1						
LTE Band 42 Part 27Q			Actual output Power (dBm)			
Band-width	RB No. / RB offset	Frequency (MHz)	Modulation			
			QPSK	16QAM	64QAM	256QAM
5 MHz	1RB_24	3547.5	19.79	18.91	18.64	17.63
		3500.0	19.73	18.93	18.62	17.94
		3452.5	20.09	19.28	19.02	17.98
	1RB_12	3547.5	19.79	18.83	18.54	17.88
		3500.0	19.68	18.92	18.60	17.92
		3452.5	19.97	19.17	18.94	17.95
	1RB_0	3547.5	19.79	18.87	18.65	17.73
		3500.0	19.71	18.90	18.67	17.71
		3452.5	20.14	19.24	19.07	18.05
	12RB_13	3547.5	18.74	17.82	17.78	17.98
		3500.0	18.78	17.75	17.80	17.99
		3452.5	19.20	18.14	18.18	18.27
	12RB_6	3547.5	18.78	17.86	17.75	18.02
		3500.0	18.82	17.84	17.84	18.03
		3452.5	19.18	18.20	18.16	18.37
	12RB_0	3547.5	18.83	17.83	17.84	17.89
		3500.0	18.81	17.84	17.85	17.90
		3452.5	19.20	18.19	18.15	18.12
	25RB_0	3547.5	18.79	17.89	17.83	17.87
		3500.0	18.76	17.81	17.75	18.18
		3452.5	19.17	18.23	18.04	18.22

Power Level B1						
LTE Band 42 Part 27Q			Actual output Power (dBm)			
Band-width	RB No. / RB offset	Frequency (MHz)	Modulation			
			QPSK	16QAM	64QAM	256QAM
10 MHz	1RB_49	3545.0	19.44	18.67	18.63	17.73
		3500.0	19.51	18.73	18.56	17.99
		3455.0	19.88	19.01	18.99	18.03
	1RB_24	3545.0	19.47	18.69	18.60	17.85
		3500.0	19.61	18.76	18.61	17.89
		3455.0	20.01	19.12	18.94	18.18
	1RB_0	3545.0	19.58	18.75	18.72	17.88
		3500.0	19.65	18.79	18.68	17.82
		3455.0	19.95	18.73	19.04	18.11
	25RB_25	3545.0	18.66	17.69	17.81	18.03
		3500.0	18.60	17.66	17.76	18.11
		3455.0	19.05	17.78	18.07	18.27
	25RB_12	3545.0	18.64	17.80	17.87	18.12
		3500.0	18.73	17.76	17.76	18.11
		3455.0	19.15	17.83	18.18	18.42
	25RB_0	3545.0	18.62	17.72	17.85	18.05
		3500.0	18.73	17.81	17.76	18.15
		3455.0	19.05	17.91	18.11	18.30
	50RB_0	3545.0	18.72	17.65	17.78	17.83
		3500.0	18.73	17.74	17.76	17.92
		3455.0	19.06	17.79	18.18	18.25

Power Level B1						
LTE Band 42 Part 27Q			Actual output Power (dBm)			
Band-width	RB No. / RB offset	Frequency (MHz)	Modulation			
			QPSK	16QAM	64QAM	256QAM
15 MHz	1RB_74	3542.5	19.31	18.44	18.13	17.95
		3500.0	19.30	18.53	18.21	18.01
		3457.5	19.56	18.78	18.47	18.41
	1RB_37	3542.5	19.28	18.45	18.25	18.04
		3500.0	19.42	18.52	18.24	18.19
		3457.5	19.67	18.83	18.48	18.27
	1RB_0	3542.5	19.39	18.59	18.25	18.18
		3500.0	19.42	18.61	18.32	18.19
		3457.5	19.75	18.95	18.63	18.27
	36RB_38	3542.5	18.45	17.45	17.51	18.32
		3500.0	18.51	17.46	17.52	18.39
		3457.5	18.81	17.77	17.75	18.11
	36RB_19	3542.5	18.51	17.50	17.54	18.15
		3500.0	18.46	17.46	17.48	18.20
		3457.5	18.78	17.74	17.75	18.38
	36RB_0	3542.5	18.55	17.55	17.54	18.11
		3500.0	18.60	17.61	17.56	18.30
		3457.5	18.90	17.95	17.92	18.25
	75RB_0	3542.5	18.63	17.61	17.57	18.15
		3500.0	18.61	17.56	17.51	18.13
		3457.5	18.92	17.89	17.82	18.16

Power Level B1						
LTE Band 42 Part 27Q			Actual output Power (dBm)			
Band-width	RB No. / RB offset	Frequency (MHz)	Modulation			
			QPSK	16QAM	64QAM	256QAM
20 MHz	1RB_99	3540.0	19.29	18.36	18.13	17.92
		3500.0	19.37	18.44	18.18	18.08
		3460.0	19.54	18.66	18.41	18.32
	1RB_50	3540.0	19.33	18.45	18.17	17.95
		3500.0	19.43	18.52	18.22	18.24
		3460.0	19.64	18.77	18.49	18.15
	1RB_0	3540.0	19.40	18.58	18.32	18.05
		3500.0	19.46	18.58	18.36	18.02
		3460.0	19.76	18.91	18.61	18.20
	50RB_50	3540.0	18.48	17.51	17.53	18.01
		3500.0	18.54	17.48	17.46	18.11
		3460.0	18.70	17.86	17.73	18.09
	50RB_25	3540.0	18.52	17.56	17.61	18.14
		3500.0	18.57	17.54	17.48	18.20
		3460.0	18.75	17.79	17.79	18.11
	50RB_0	3540.0	18.56	17.65	17.57	18.13
		3500.0	18.69	17.64	17.59	18.27
		3460.0	18.94	17.94	17.93	18.10
	100RB_0	3540.0	18.62	17.64	17.64	18.20
		3500.0	18.65	17.62	17.62	18.19
		3460.0	18.89	17.91	17.86	18.26



Power Level C1						
LTE Band 42 Part 27Q			Actual output Power (dBm)			
Band-width	RB No. / RB offset	Frequency (MHz)	Modulation			
			QPSK	16QAM	64QAM	256QAM
5 MHz	1RB_24	3547.5	21.88	21.03	20.82	17.63
		3500.0	22.00	21.26	20.96	17.94
		3452.5	22.16	21.36	21.14	17.98
	1RB_12	3547.5	22.04	21.04	20.73	17.88
		3500.0	22.10	21.15	20.85	17.92
		3452.5	22.12	21.32	21.04	17.95
	1RB_0	3547.5	21.96	21.03	20.88	17.73
		3500.0	22.04	21.11	21.04	17.71
		3452.5	22.19	21.36	21.11	18.05
	12RB_13	3547.5	20.98	19.97	19.89	17.98
		3500.0	21.02	19.99	19.91	17.99
		3452.5	21.23	20.24	20.20	18.27
	12RB_6	3547.5	21.02	20.03	19.96	18.02
		3500.0	21.09	20.11	20.07	18.03
		3452.5	21.27	20.31	20.20	18.37
	12RB_0	3547.5	21.02	20.00	19.97	17.89
		3500.0	21.11	20.11	20.05	17.90
		3452.5	21.28	20.24	20.17	18.12
	25RB_0	3547.5	21.03	20.01	20.04	17.87
		3500.0	21.04	20.08	19.94	18.18
		3452.5	21.25	20.32	20.14	18.22

Power Level C1						
LTE Band 42 Part 27Q			Actual output Power (dBm)			
Band-width	RB No. / RB offset	Frequency (MHz)	Modulation			
			QPSK	16QAM	64QAM	256QAM
10 MHz	1RB_49	3545.0	21.87	20.94	20.77	17.73
		3500.0	21.89	21.04	20.88	17.99
		3455.0	22.06	21.20	21.07	18.03
	1RB_24	3545.0	21.82	21.02	20.77	17.85
		3500.0	21.90	21.13	20.90	17.89
		3455.0	22.15	21.20	21.04	18.18
	1RB_0	3545.0	21.91	21.07	20.84	17.88
		3500.0	21.98	21.23	20.98	17.82
		3455.0	22.18	21.32	21.12	18.11
	25RB_25	3545.0	20.94	19.99	19.96	18.03
		3500.0	20.94	19.98	19.91	18.11
		3455.0	21.23	20.24	20.15	18.27
	25RB_12	3545.0	21.01	20.06	19.92	18.12
		3500.0	21.04	20.07	19.89	18.11
		3455.0	21.27	20.28	20.19	18.42
	25RB_0	3545.0	20.97	20.00	19.93	18.05
		3500.0	21.10	20.13	20.01	18.15
		3455.0	21.26	20.25	20.18	18.30
	50RB_0	3545.0	21.00	20.09	20.00	17.83
		3500.0	21.02	20.05	19.98	17.92
		3455.0	21.25	20.31	20.19	18.25

Power Level C1						
LTE Band 42 Part 27Q			Actual output Power (dBm)			
Band-width	RB No. / RB offset	Frequency (MHz)	Modulation			
			QPSK	16QAM	64QAM	256QAM
15 MHz	1RB_74	3542.5	21.53	20.71	20.38	17.95
		3500.0	21.65	20.83	20.49	18.01
		3457.5	21.80	20.95	20.68	18.41
	1RB_37	3542.5	21.64	20.75	20.47	18.04
		3500.0	21.71	20.83	20.58	18.19
		3457.5	21.84	20.98	20.71	18.27
	1RB_0	3542.5	21.69	20.86	20.56	18.18
		3500.0	21.77	20.93	20.65	18.19
		3457.5	21.90	21.03	20.79	18.27
	36RB_38	3542.5	20.78	19.84	19.79	18.32
		3500.0	20.82	19.80	19.81	18.39
		3457.5	20.96	19.91	19.94	18.11
	36RB_19	3542.5	20.86	19.81	19.85	18.15
		3500.0	20.85	19.89	19.87	18.20
		3457.5	20.97	19.97	19.97	18.38
	36RB_0	3542.5	20.87	19.84	19.87	18.11
		3500.0	20.93	19.93	19.92	18.30
		3457.5	21.06	20.06	20.10	18.25
	75RB_0	3542.5	20.89	19.88	19.85	18.15
		3500.0	20.86	19.88	19.97	18.13
		3457.5	20.94	20.00	20.16	18.16

Power Level C1						
LTE Band 42 Part 27Q			Actual output Power (dBm)			
Band-width	RB No. / RB offset	Frequency (MHz)	Modulation			
			QPSK	16QAM	64QAM	256QAM
20 MHz	1RB_99	3540.0	21.57	20.64	20.40	17.92
		3500.0	21.60	20.75	20.45	18.08
		3460.0	21.66	20.96	20.63	18.32
	1RB_50	3540.0	21.61	20.76	20.39	17.95
		3500.0	21.73	20.81	20.62	18.24
		3460.0	21.74	20.90	20.65	18.15
	1RB_0	3540.0	21.75	20.79	20.45	18.05
		3500.0	21.74	20.92	20.63	18.02
		3460.0	21.76	21.03	20.76	18.20
	50RB_50	3540.0	20.73	19.76	19.72	18.01
		3500.0	20.78	19.76	19.74	18.11
		3460.0	20.88	19.88	19.84	18.09
	50RB_25	3540.0	20.83	19.87	19.77	18.14
		3500.0	20.83	19.83	19.86	18.20
		3460.0	20.93	19.96	19.95	18.11
	50RB_0	3540.0	20.84	19.94	19.85	18.13
		3500.0	20.92	19.91	19.90	18.27
		3460.0	21.04	20.09	19.98	18.10
	100RB_0	3540.0	20.85	19.82	19.86	18.20
		3500.0	20.79	19.84	20.00	18.19
		3460.0	20.91	19.95	20.09	18.26

11. Transmit Antenna

11.1. Transmit Antenna Separation Distances

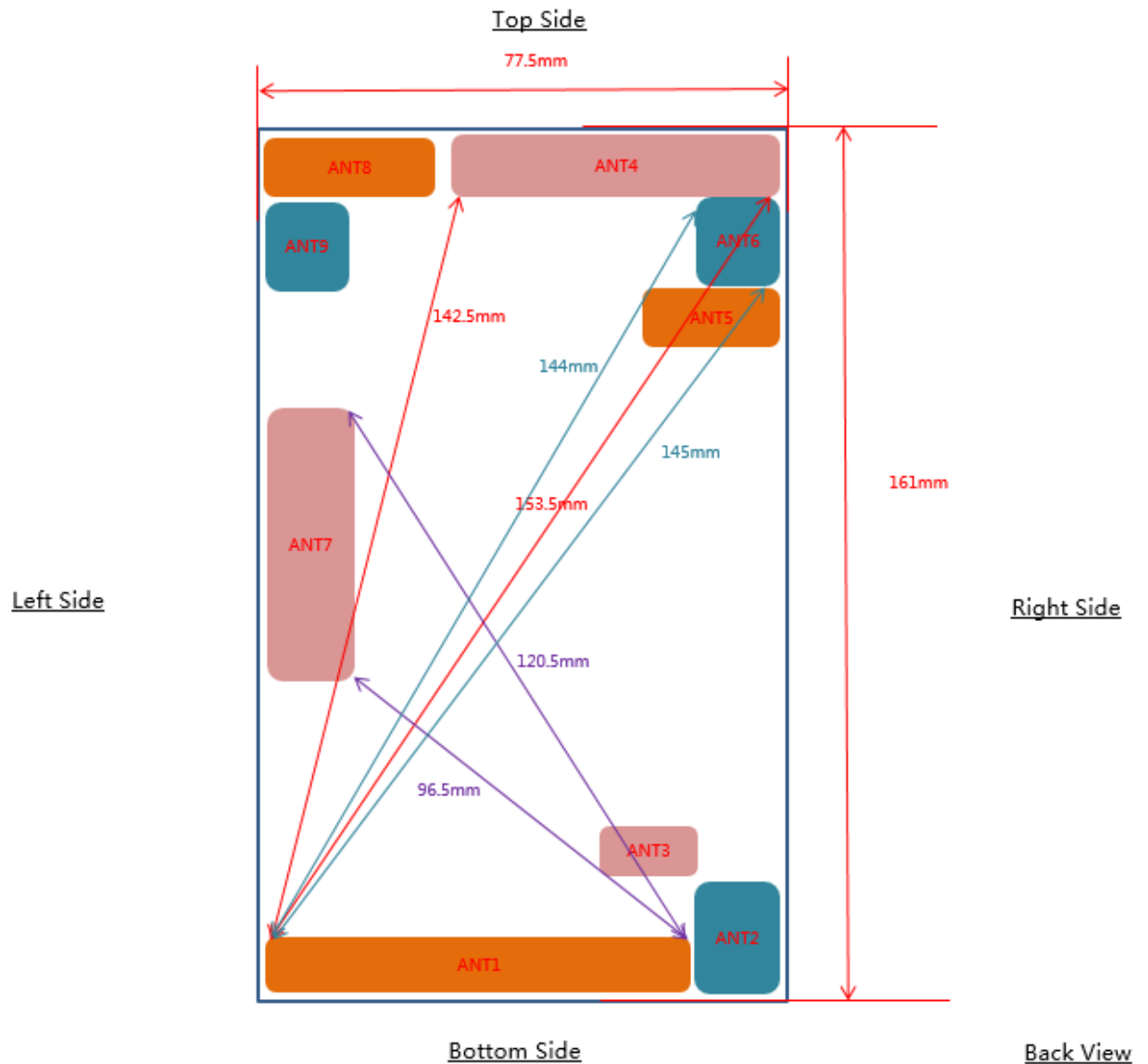

Picture 11.1 Antenna Locations (Back View)

Note:

Antenna	Frequency Bands
Ant.1	WCDMA Band 2/4/5 TX LTE Band 2/4/5/12/13/14/25/26/30/40/66/71 TX ENDC: NR n2/n5/n14/n66/n71 TX
Ant.2	LTE Band 7/38/41 TX ENDC:NR n41 TX
Ant.3	SRS: NR n77 TX
Ant.4	DRX
Ant.5	LTE Band 42/43/48 TX ENDC: NR n77/n78 TX
Ant.6	UL CA: LTE Band 2/4/30/66 TX ENDC: NR n2/n25/n30/n66/n77 TX SRS: NR n77 TX
Ant.7	SRS: NR n41/n77 TX
Ant.8	WLAN TX
Ant.9	GPS/Bluetooth/WLAN TX

11.2. SAR Measurement Positions

According to the KDB941225 D06 Hot Spot SAR, the edges with less than 25mm distance to the antennas need to be tested for SAR.

SAR measurement positions						
Antenna	Front	Rear	Left edge	Right edge	Top edge	Bottom edge
Ant.5	Yes	Yes	Yes	Yes	Yes	No

12. Evaluation of Simultaneous

Table 12.1: The sum of reported SAR values for WWAN and WLAN/Bluetooth antenna

/	Position	WWAN (W/kg)	WLAN + Bluetooth (W/kg)	Sum (W/kg)
Highest reported SAR value for Head	Left Cheek	0.14	0.61	0.75
Highest reported SAR value for Hotspot	Rear Side	0.59	0.39	0.98
Highest reported SAR value for Body-worn	Rear Side	0.52	0.52	1.04

Note:

1. The test positions of above tables are for the worse case that has been evaluated.
2. The Bluetooth/WLAN SAR data is referenced to B22N01108-SAR report.

13. Summary of Test Results

According to the client's decision rule in the test registration form, which is "based on the measurement results as the basis of the conformity statement", the test conclusion of this report meets the limit requirements.

The calculated SAR is obtained by the following formula:

$$\text{Reported SAR} = \text{Measured SAR} \times 10^{(P_{\text{Target}} - P_{\text{Measured}})/10}$$

Where P_{Target} is the power of manufacturing upper limit;

P_{Measured} is the measured power in chapter 10.

General Note:

1. Per KDB648474 D04v01r03, for smart phones with a display diagonal dimension > 15.0 cm or an overall diagonal dimension > 16.0 cm, when hotspot mode applies, 10-g extremity SAR is required only for the surfaces and edges with hotspot mode 1-g reported SAR > 1.2 W/kg, however, when power reduction applies to hotspot mode the measured SAR must be scaled to the maximum output power, including tolerance, allowed for phablet modes to compare with the 1.2 W/kg SAR test reduction threshold.

a. When 10-g product specific 10g SAR is considered, SAR thresholds is specified in the procedures for SAR test reduction and exclusion should be multiplied by 2.5.

Duty Cycle

Mode	Duty Cycle
TDD_LTE	1:1.58

13.1. Testing Environment

Temperature:	18°C~25°C
Relative humidity:	30%~70%
Ground system resistance:	<4Ω
Ambient noise & Reflection:	< 0.012 W/kg

13.2. Test result for SAR

Note: SAR for LTE Band 42(3550 - 3600MHz) / LTE Band 43(3600 - 3650MHz) is covered by LTE Band 48 due to similar frequency range, same maximum tune-up limit and same channel bandwidth. The LTE Band 48 SAR data is referenced to B22N01108-SAR report.

Table 13.1: SAR Values (LTE Band 42 Part 27Q - Head)

Frequency		Test Mode	Test Position	Figure No./ Note	Conducted Power (dBm)	Max. tune-up Power (dBm)	Measured SAR(1g) (W/kg)	Reported SAR(1g) (W/kg)	Power Drift(dB)
Ch.	MHz								
Power Level A1									
42190	3460.0	1RB0	Left Cheek	/	22.98	24.0	0.108	0.14	0.06
42190	3460.0	50RB0	Left Cheek	/	22.22	23.0	0.105	0.13	0.01
42190	3460.0	1RB0	Left Tilt	/	22.98	24.0	0.030	0.04	0.06
42190	3460.0	50RB0	Left Tilt	/	22.22	23.0	0.036	0.04	0.04
42190	3460.0	1RB0	Right Cheek	1	22.98	24.0	0.162	0.20	0.02
42190	3460.0	50RB0	Right Cheek	/	22.22	23.0	0.146	0.17	0.03
42190	3460.0	1RB0	Right Tilt	/	22.98	24.0	0.061	0.08	0.08
42190	3460.0	50RB0	Right Tilt	/	22.22	23.0	0.052	0.06	0.16

Table 13.2: SAR Values (LTE Band 42 Part 27Q - Body)

Frequency		Test Mode	Test Position	Figure No./ Note	Conducted Power (dBm)	Max. tune-up Power (dBm)	Measured SAR(1g) (W/kg)	Reported SAR(1g) (W/kg)	Power Drift(dB)
Ch.	MHz								
Hotspot Test Data (10mm) - Power Level B1									
42190	3460.0	1RB0	Front	/	19.76	21.0	0.022	0.03	0.19
42190	3460.0	50RB0	Front	/	18.94	20.0	0.017	0.02	-0.14
42190	3460.0	1RB0	Rear	2	19.76	21.0	0.444	0.59	0.17
42190	3460.0	50RB0	Rear	/	18.94	20.0	0.370	0.47	-0.11
42190	3460.0	1RB0	Left	/	19.76	21.0	0.162	0.22	-0.14
42190	3460.0	50RB0	Left	/	18.94	20.0	0.086	0.11	0.16
42190	3460.0	1RB0	Right	/	19.76	21.0	0.007	0.01	0.18
42190	3460.0	50RB0	Right	/	18.94	20.0	0.010	0.01	0.10
42190	3460.0	1RB0	Top	/	19.76	21.0	0.032	0.04	-0.12
42190	3460.0	50RB0	Top	/	18.94	20.0	0.026	0.03	-0.06
Body-Worn Test Data (15mm) - Power Level C1									
42190	3460.0	1RB0	Front	/	21.76	23.0	0.024	0.03	0.06
42190	3460.0	50RB0	Front	/	21.04	22.0	0.019	0.02	0.02
42190	3460.0	1RB0	Rear	/	21.76	23.0	0.392	0.52	0.08
42190	3460.0	50RB0	Rear	/	21.04	22.0	0.317	0.40	0.06

14. SAR Measurement Variability

SAR measurement variability must be assessed for each frequency band, which is determined by the SAR probe calibration point and tissue-equivalent medium used for the device measurements. When both head and body tissue-equivalent media are required for SAR measurements in a frequency band, the variability measurement procedures should be applied to the tissue medium with the highest measured SAR, using the highest measured SAR configuration for that tissue-equivalent medium.

The following procedures are applied to determine if repeated measurements are required.

- 1) Repeated measurement is not required when the original highest measured SAR is < 0.80 W/kg; steps 2) through 4) do not apply.
- 2) When the original highest measured SAR is ≥ 0.80 W/kg, repeat that measurement once.
- 3) Perform a second repeated measurement only if the ratio of largest to smallest SAR for the original and first repeated measurements is > 1.20 or when the original or repeated measurement is ≥ 1.45 W/kg (~ 10% from the 1-g SAR limit).
- 4) Perform a third repeated measurement only if the original, first or second repeated measurement is ≥ 1.5 W/kg and the ratio of largest to smallest SAR for the original, first and second repeated measurements is > 1.20 .

15. Measurement Uncertainty

15.1. Measurement Uncertainty for Normal SAR Tests (3GHz~6GHz)

No.	Error Description	Type	Uncertainty value	Probably Distribution	Div.	(Ci) 1g	(Ci) 10g	Std. Unc. (1g)	Std. Unc. (10g)	Degree of freedom
Measurement system										
1	Probe calibration	B	13.1	N	2	1	1	6.65	6.65	∞
2	Axial isotropy	B	4.7	R	$\sqrt{3}$	$\sqrt{0.5}$	$\sqrt{0.5}$	4.3	4.3	∞
3	Hemispherical isotropy	B	9.6	R	$\sqrt{3}$	1	1	4.8	4.8	∞
4	Boundary effect	B	1.1	R	$\sqrt{3}$	1	1	0.6	0.6	∞
5	Linearity	B	4.7	R	$\sqrt{3}$	1	1	2.7	2.7	∞
6	Detection limit	B	1.0	R	$\sqrt{3}$	1	1	0.6	0.6	∞
7	modulation response	B	4.0	R	$\sqrt{3}$	1	1	2.3	2.3	∞
8	Readout electronics	B	1.0	N	1	1	1	1.0	1.0	∞
9	Response time	B	0.0	R	$\sqrt{3}$	1	1	0.0	0.0	∞
10	Integration time	B	1.7	R	$\sqrt{3}$	1	1	1.0	1.0	∞
11	RF ambient conditions-noise	B	3.0	R	$\sqrt{3}$	1	1	1.7	1.7	∞
12	RF ambient conditions-reflection	B	3.0	R	$\sqrt{3}$	1	1	1.7	1.7	∞
13	Probe positioned mech. Restrictions	B	0.35	R	$\sqrt{3}$	1	1	0.2	0.2	∞
14	Probe positioning with respect to phantom shell	B	2.9	R	$\sqrt{3}$	1	1	1.7	1.7	∞
15	Post-processing	B	1.0	R	$\sqrt{3}$	1	1	0.6	0.6	∞
Test sample related										
16	Test sample positioning	A	3.3	N	1	1	1	3.3	3.3	5
17	Device holder uncertainty	A	3.4	N	1	1	1	3.4	3.4	5
18	Drift of output power	B	5.0	R	$\sqrt{3}$	1	1	2.9	2.9	∞
Phantom and set-up										
19	Phantom uncertainty	B	1.0	R	$\sqrt{3}$	1	1	0.6	0.6	∞
20	Liquid conductivity (target)	B	5.0	R	$\sqrt{3}$	0.64	0.43	1.8	1.2	∞
21	Liquid conductivity (meas.)	A	1.3	N	1	0.64	0.43	0.83	0.56	43
22	Liquid permittivity (target)	B	5.0	R	$\sqrt{3}$	0.6	0.49	1.7	1.4	∞
23	Liquid permittivity (meas.)	A	1.6	N	1	0.6	0.49	0.96	0.78	521
Combined standard uncertainty		$u_c = \sqrt{\sum_{i=1}^{22} c_i^2 u_i^2}$						11.6	11.5	257
Expanded uncertainty (Confidence interval of 95 %)		$u_e = 2u_c$						23.2	23.0	

16. Main Test Instruments

Table 16.1: List of Main Instruments

No.	Name	Type	Serial Number	Calibration Date	Valid Period
01	Network analyzer	E5071C	MY46103759	2021-11-15	One year
02	Dielectric probe	85070E	MY44300317	/	/
03	Power meter	E4418B	MY50000366	2021-12-12	One year
04	Power sensor	E9304A	MY50000188	2021-12-12	One year
05	Power meter	NRP	101260	2021-12-30	One year
06	Power sensor	NRP-Z91	102211	2021-12-30	One year
07	Signal Generator	E8257D	MY47461211	2022-01-14	One year
08	Amplifier	VTL5400	0404	/	/
09	DAE	DAE4	1527	2022-01-12	One year
10	E-field Probe	EX3DV4	7621	2022-05-06	One year
11	Dipole Validation Kit	D3500V2	1084	2019-09-20	Three years
12	BTS	MT8820C	6201341853	2022-01-14	One year
13	BTS	CMW500	152499	2021-07-16	One year
14	Software	DASY5	/	/	/

ANNEX A: Graph Results

LTE Band 42 Part 27Q Head

Date: 2022-6-20

Electronics: DAE4 Sn1527

Medium: Head 3500MHz

Medium parameters used: $f = 3460$ MHz; $\sigma = 2.926$ S/m; $\epsilon_r = 37.403$; $\rho = 1000$ kg/m³

Communication System: UID 0, LTE_TDD (0) Frequency: 3460 MHz Duty Cycle: 1:1.58

Probe: EX3DV4 - SN7621 ConvF (7.56, 7.56, 7.56)

Right Cheek Low 1RB0/Area Scan (111x91x1): Interpolated grid: dx=1.000 mm, dy=1.000 mm

Maximum value of SAR (interpolated) = 0.276 W/kg

Right Cheek Low 1RB0/Zoom Scan (7x7x7)/Cube 0: Measurement grid: dx=5mm, dy=5mm, dz=5mm

Reference Value = 3.227 V/m; Power Drift = 0.02 dB

Peak SAR (extrapolated) = 0.400 W/kg

SAR(1 g) = 0.162 W/kg; SAR(10 g) = 0.073 W/kg

Maximum value of SAR (measured) = 0.253 W/kg

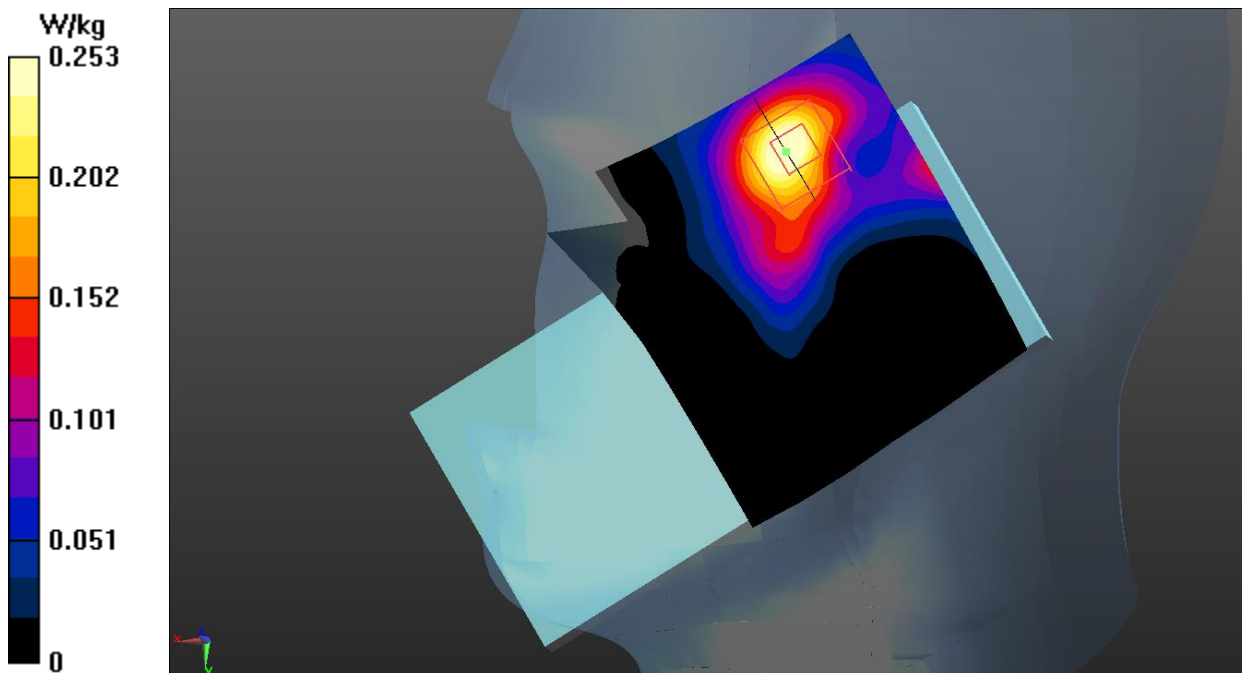

Fig.1 LTE Band 42 Head

LTE Band 42 Part 27Q Body

Date: 2022-6-20

Electronics: DAE4 Sn1527

Medium: Head 3500MHz

Medium parameters used: $f = 3460$ MHz; $\sigma = 2.926$ S/m; $\epsilon_r = 37.403$; $\rho = 1000$ kg/m³

Communication System: UID 0, LTE_TDD (0) Frequency: 3460 MHz Duty Cycle: 1:1.58

Probe: EX3DV4 - SN7621 ConvF (7.56, 7.56, 7.56)

Rear Side Low 1RB0/Area Scan (91x91x1): Interpolated grid: dx=1.000 mm, dy=1.000 mm

Maximum value of SAR (interpolated) = 0.729 W/kg

Rear Side Low 1RB0/Zoom Scan (7x7x7)/Cube 0: Measurement grid: dx=5mm, dy=5mm, dz=5mm

Reference Value = 4.095 V/m; Power Drift = 0.17 dB

Peak SAR (extrapolated) = 1.04 W/kg

SAR(1 g) = 0.444 W/kg; SAR(10 g) = 0.189 W/kg

Maximum value of SAR (measured) = 0.725 W/kg

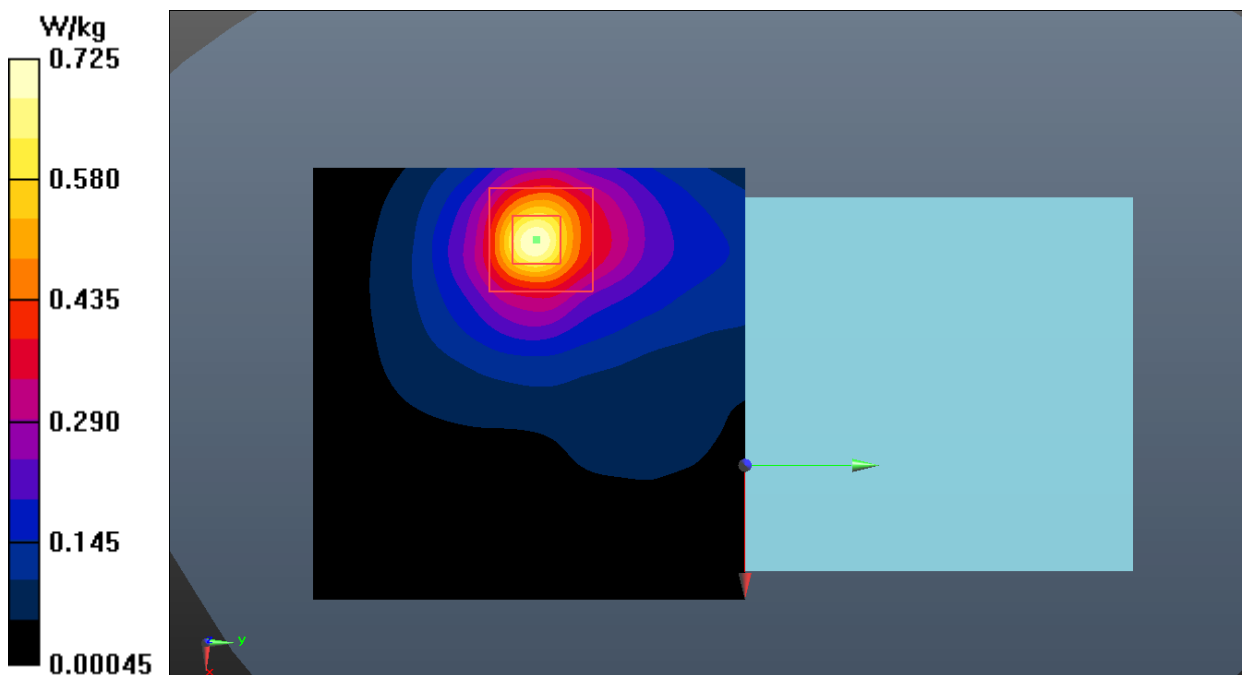
**Fig.2 LTE Band 42 Body**

ANNEX B: SystemVerification Results

3500MHz

Date: 2022-6-20

Electronics: DAE4 Sn1527

Medium: Head 3500MHz

Medium parameters used: $f = 3500$ MHz; $\sigma = 2.878$ S/m; $\epsilon_r = 38.456$; $\rho = 1000$ kg/m³

Communication System: CW_TMC Frequency: 3500 MHz Duty Cycle: 1:1

Probe: EX3DV4 - SN7621 ConvF (7.56, 7.56, 7.56)

System Validation/Area Scan (61x61x1): Interpolated grid: $dx=1.000$ mm, $dy=1.000$ mm

Reference Value = 68.752 V/m; Power Drift = -0.03 dB

SAR(1 g) = 6.58 W/kg; SAR(10 g) = 2.50 W/kg

Maximum value of SAR (interpolated) = 7.71 W/kg

System Validation/Zoom Scan (7x7x7)/Cube0: Measurement grid: $dx=5$ mm, $dy=5$ mm, $dz=5$ mm

Reference Value = 68.752 V/m; Power Drift = -0.03 dB

Peak SAR (extrapolated) = 17.2 W/kg

SAR(1 g) = 6.39 W/kg; SAR(10 g) = 2.45 W/kg

Maximum value of SAR (measured) = 7.67 W/kg

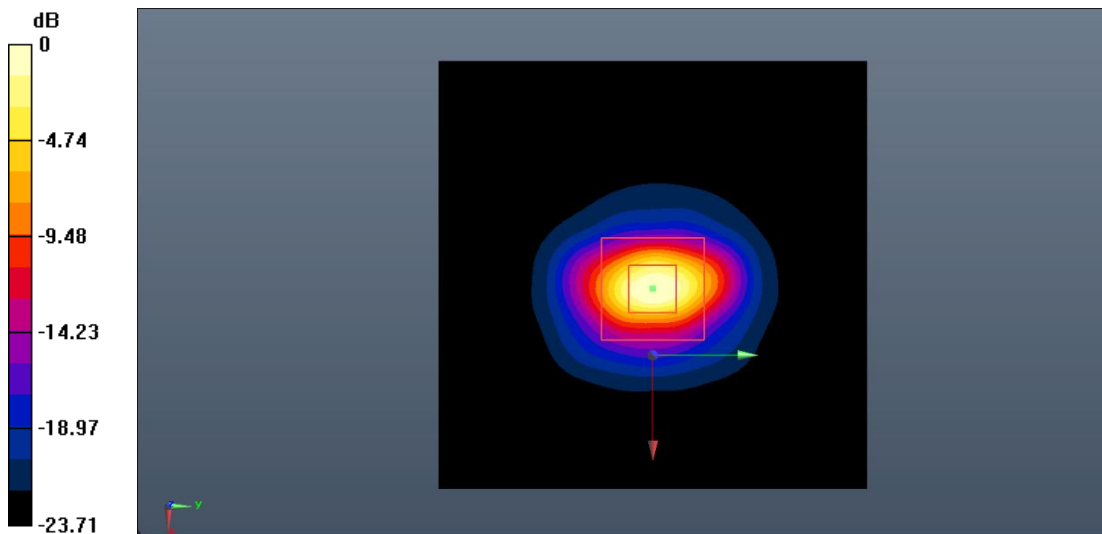

0 dB = 7.67 W/kg = 8.85 dB W/kg

Fig.B.1. Validation 3500MHz 100mW

ANNEX C: SAR Measurement Setup

C.1. Measurement Set-up

DASY5 system for performing compliance tests is illustrated above graphically. This system consists of the following items:

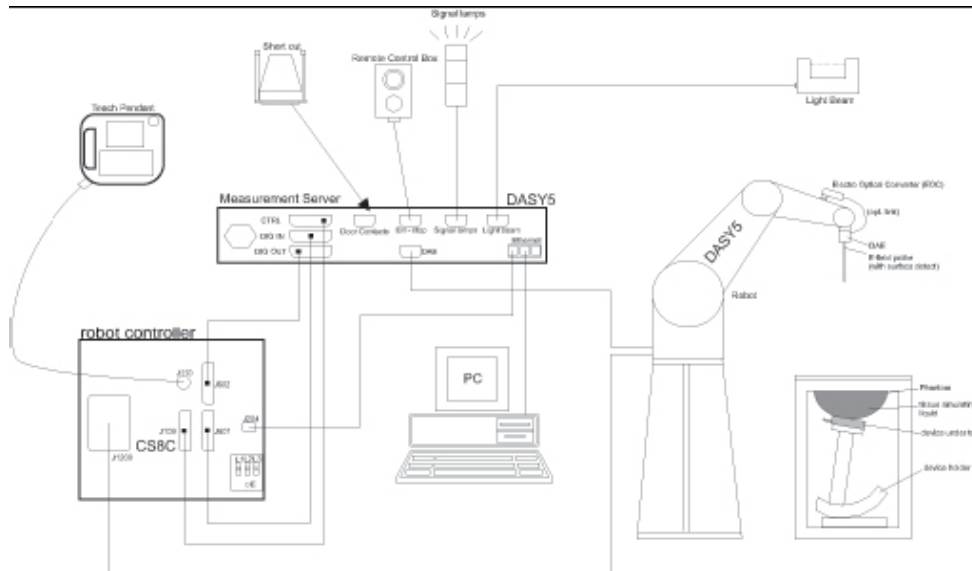

Picture C.1 SAR Lab Test Measurement Set-up

- A standard high precision 6-axis robot (Stäubli TX=RX family) with controller, teach pendant and software. An arm extension for accommodating the data acquisition electronics (DAE).
- An isotropic field probe optimized and calibrated for the targeted measurement.
- A data acquisition electronics (DAE) which performs the signal amplification, signal multiplexing, AD-conversion, offset measurements, mechanical surface detection, collision detection, etc. The unit is battery powered with standard or rechargeable batteries. The signal is optically transmitted to the EOC.
- The Electro-optical converter (EOC) performs the conversion from optical to electrical signals for the digital communication to the DAE. To use optical surface detection, a special version of the EOC is required. The EOC signal is transmitted to the measurement server.
- The function of the measurement server is to perform the time critical tasks such as signal filtering, control of the robot operation and fast movement interrupts.
- The Light Beam used is for probe alignment. This improves the (absolute) accuracy of the probe positioning.
- A computer running WinXP and the DASY5 software.
- Remote control and teach pendant as well as additional circuitry for robot safety such as
- warning lamps, etc.
- The phantom, the device holder and other accessories according to the targeted measurement.

C.2. DASY5 E-field Probe System

The SAR measurements were conducted with the dosimetric probe designed in the classical triangular configuration and optimized for dosimetric evaluation. The probe is constructed using the thick film technique; with printed resistive lines on ceramic substrates. The probe is equipped with an optical multifiber line ending at the front of the probe tip. It is connected to the EOC box on the robot arm and provides an automatic detection of the phantom surface. Half of the fibers are connected to a pulsed infrared transmitter, the other half to a synchronized receiver. As the probe approaches the surface, the reflection from the surface produces a coupling from the transmitting to the receiving fibers. This reflection increases first during the approach, reaches maximum and then decreases. If the probe is flatly touching the surface, the coupling is zero. The distance of the coupling maximum to the surface is independent of the surface reflectivity and largely independent of the surface to probe angle. The DASY5 software reads the reflection during a software approach and looks for the maximum using 2nd order curve fitting. The approach is stopped at reaching the maximum.

Probe Specifications:

Model:	ES3DV3, EX3DV4
Frequency	10MHz — 6.0GHz(EX3DV4)
Range:	10MHz — 4GHz(ES3DV3)
Calibration:	In head and body simulating tissue at Frequencies from 835 up to 5800MHz
Linearity:	± 0.2 dB(30 MHz to 6 GHz) for EX3DV4 ± 0.2 dB(30 MHz to 4 GHz) for ES3DV3
Dynamic Range:	10 mW/kg — 100W/kg
Probe Length:	330 mm
Probe Tip	
Length:	20 mm
Body Diameter:	12 mm
Tip Diameter:	2.5 mm (3.9 mm for ES3DV3)
Tip-Center:	1 mm (2.0mm for ES3DV3)
Application:	SAR Dosimetry Testing Compliance tests of mobile phones Dosimetry in strong gradient fields



Picture C.2 Near-field Probe



Picture C.3 E-field Probe

C.3. E-field Probe Calibration

Each E-Probe/Probe Amplifier combination has unique calibration parameters. A TEM cell calibration procedure is conducted to determine the proper amplifier settings to enter in the probe parameters. The amplifier settings are determined for a given frequency by subjecting the probe to a known E-field density (1 mW/cm²) using an RF Signal generator, TEM cell, and RF Power Meter.

The free space E-field from amplified probe outputs is determined in a test chamber. This calibration can be performed in a TEM cell if the frequency is below 1 GHz and in a waveguide or other methodologies above 1 GHz for free space. For the free space calibration, the probe is placed in the volumetric center of the cavity and at the proper orientation with the field. The probe is then rotated 360 degrees until the three channels show the maximum reading. The power density readings equate to 1 mW/cm².

E-field temperature correlation calibration is performed in a flat phantom filled with the appropriate simulated brain tissue. The E-field in the medium correlates with the temperature rise in the dielectric medium. For temperature correlation calibration a RF transparent thermistor-based temperature probe is used in conjunction with the E-field probe.

$$SAR = C \frac{\Delta T}{\Delta t}$$

Where:

Δt = Exposure time (30 seconds),

C = Heat capacity of tissue (brain or muscle),

ΔT = Temperature increase due to RF exposure.

$$SAR = \frac{|E|^2 \cdot \sigma}{\rho}$$

Where:

σ = Simulated tissue conductivity,

ρ = Tissue density (kg/m³).

C.4. Other Test Equipment

C.4.1. Data Acquisition Electronics (DAE)

The data acquisition electronics consist of a highly sensitive electrometer-grade preamplifier with auto-zeroing, a channel and gain-switching multiplexer, a fast 16 bit AD-converter and a command decoder with a control logic unit. Transmission to the measurement server is accomplished through an optical downlink for data and status information, as well as an optical uplink for commands and the clock.

The mechanical probe mounting device includes two different sensor systems for frontal and sideways probe contacts. They are used for mechanical surface detection and probe collision detection.

The input impedance of the DAE is 200 MOhm; the inputs are symmetrical and floating. Common mode rejection is above 80 dB.



PictureC.4: DAE

C.4.2. Robot

The SPEAG DASY system uses the high precision robots (DASY5: RX160L) type from Stäubli SA (France). For the 6-axis controller system, the robot controller version from Stäubli is used. The Stäubli robot series have many features that are important for our application:

- High precision (repeatability 0.02mm)
- High reliability (industrial design)
- Low maintenance costs (virtually maintenance free due to direct drive gears; no belt drives)
- Jerk-free straight movements (brushless synchron motors; no stepper motors)
- Low ELF interference (motor control fields shielded via the closed metallic construction shields)



Picture C.5 DASY 5

C.4.3. Measurement Server

The Measurement server is based on a PC/104 CPU board with CPU (DASY5: 400 MHz, Intel Celeron), chipdisk (DASY5:128MB), RAM (DASY5:128MB). The necessary circuits for communication with the DAE electronic box, as well as the 16 bit AD converter system for optical detection and digital I/O interface are contained on the DASY I/O board, which is directly connected to the PC/104 bus of the CPU board.

The measurement server performs all real-time data evaluation of field measurements and surface detection, controls robot movements and handles safety operation. The PC operating system cannot interfere with these time critical processes. All connections are supervised by a watchdog, and disconnection of any of the cables to the measurement server will automatically disarm the robot and disable all program-controlled robot movements. Furthermore, the measurement server is equipped with an expansion port which is reserved for future applications. Please note that this expansion port does not have a standardized pinout, and therefore only devices provided by SPEAG can be connected. Devices from any other supplier could seriously damage the measurement server.



Picture C.6 Server for DASY 5

C.4.4. Device Holder for Phantom

The SAR in the phantom is approximately inversely proportional to the square of the distance between the source and the liquid surface. For a source at 5mm distance, a positioning uncertainty of $\pm 0.5\text{mm}$ would produce a SAR uncertainty of $\pm 20\%$. Accurate device positioning is therefore crucial for accurate and repeatable measurements. The positions in which the devices must be measured are defined by the standards.

The DASY device holder is designed to cope with the different positions given in the standard. It has two scales for device rotation (with respect to the body axis) and device inclination (with respect to the line between the ear reference points). The rotation centers for both scales is the ear reference point (ERP). Thus the device needs no repositioning when changing the angles.

The DASY device holder is constructed of low-loss POM material having the following dielectric

parameters: relative permittivity $\epsilon = 3$ and loss tangent $\delta = 0.02$. The amount of dielectric material has been reduced in the closest vicinity of the device, since measurements have suggested that the influence of the clamp on the test results could thus be lowered.

<Laptop Extension Kit>

The extension is lightweight and made of POM, acrylic glass and foam. It fits easily on the upper part of the Mounting Device in place of the phone positioner. The extension is fully compatible with the Twin-SAM and ELI phantoms.



Picture C.7-1: Device Holder

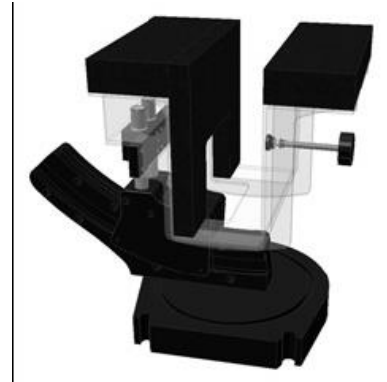

Picture C.7-2: Laptop Extension Kit

C.4.5. Phantom

The SAM Twin Phantom V4.0 is constructed of a fiberglass shell integrated in a table. The shape of the shell is based on data from an anatomical study designed to represent the 90th percentile of the population. The phantom enables the dissymmetric evaluation of SAR for both left and right handed handset usage, as well as body-worn usage using the flat phantom region. Reference markings on the Phantom allow the complete setup of all predefined phantom positions and measurement grids by manually teaching three points in the robot. The shell phantom has a 2mm shell thickness (except the ear region where shell thickness increases to 6 mm).

Shell Thickness: 2 ± 0.2 mm
Filling Volume: Approx. 25 liters
Dimensions: 810 x 1000 x 500 mm (H x L x W)
Available: Special



Picture C.8: SAM Twin Phantom

ANNEX D: Position of the wireless device in relation to the phantom

D.1. General considerations

This standard specifies two handset test positions against the head phantom – the “cheek” position and the “tilt” position.

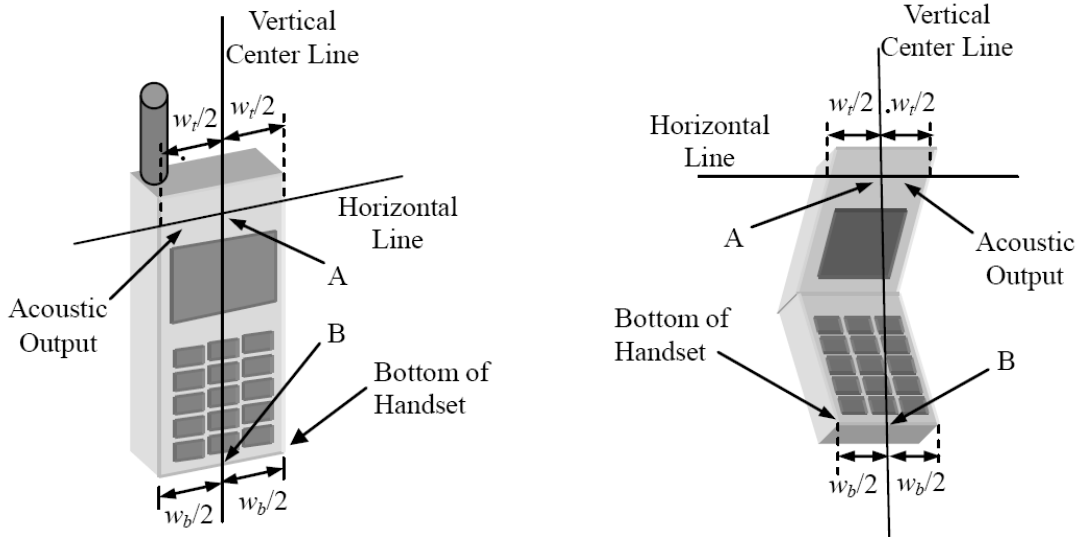

- w_t Width of the handset at the level of the acoustic
- w_b Width of the bottom of the handset
- A Midpoint of the width w_t of the handset at the level of the acoustic output
- B Midpoint of the width w_b of the bottom of the handset

Picture D.1-a Typical “fixed” case handset Picture D.1-b Typical “clam-shell” case handset

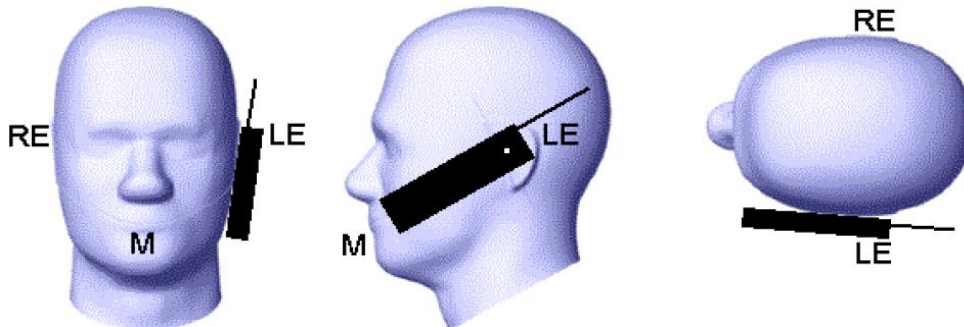

Picture D.2 Cheek position of the wireless device on the left side of SAM

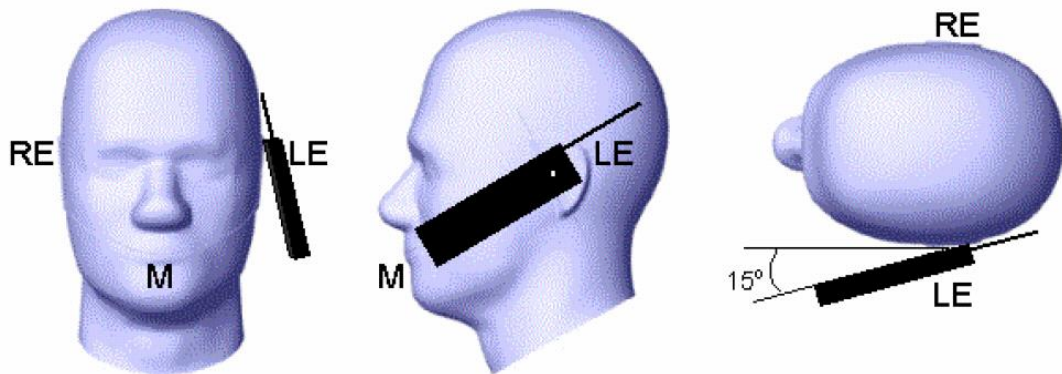

Picture D.3 Tilt position of the wireless device on the left side of SAM

D.2. Body-worn device

A typical example of a body-worn device is a mobile phone, wireless enabled PDA or other battery operated wireless device with the ability to transmit while mounted on a person's body using a carry accessory approved by the wireless device manufacturer.

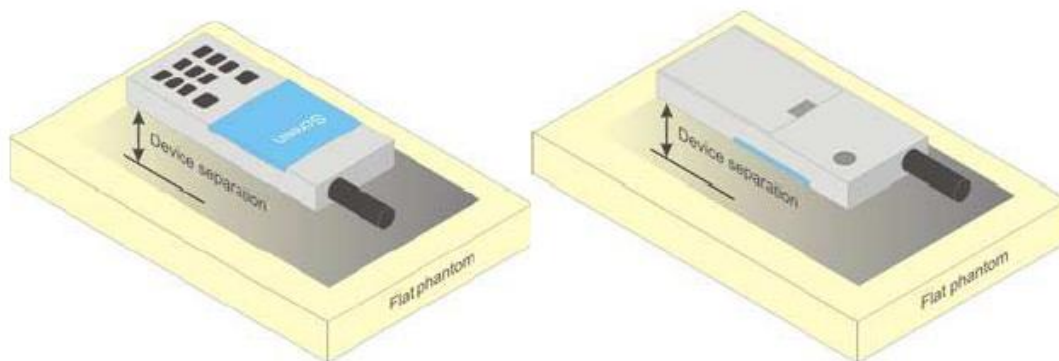

Picture D.4 Test positions for body-worn devices

D.3. Desktop device

A typical example of a desktop device is a wireless enabled desktop computer placed on a table or desk when used.

The DUT shall be positioned at the distance and in the orientation to the phantom that corresponds to the intended use as specified by the manufacturer in the user instructions. For devices that employ an external antenna with variable positions, tests shall be performed for all antenna positions specified. Picture 8.5 show positions for desktop device SAR tests. If the intended use is not specified, the device shall be tested directly against the flat phantom.

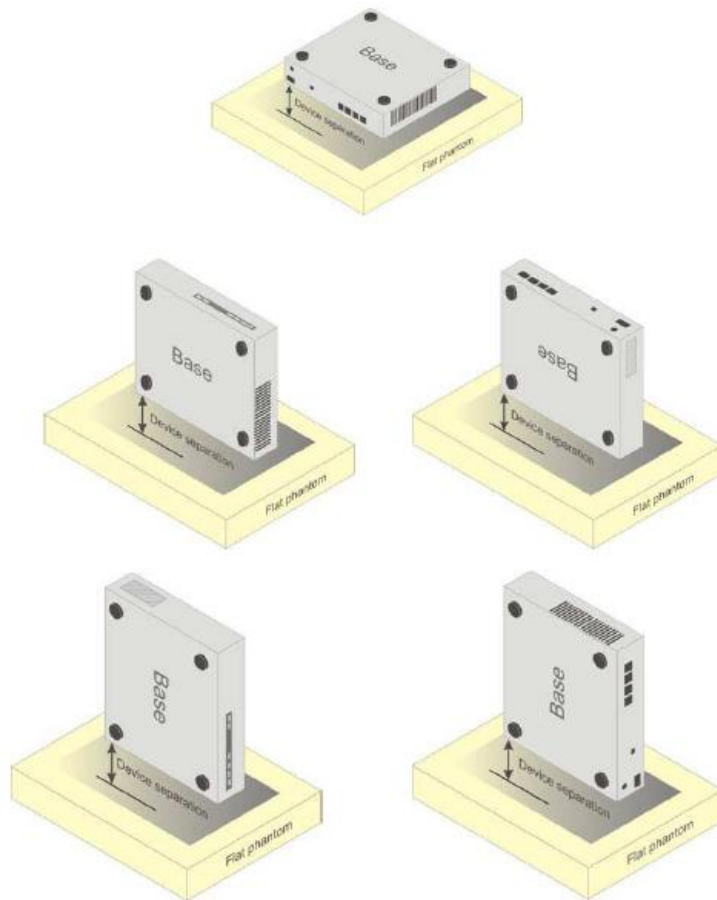

Picture D.5 Test positions for desktop devices

D.4. DUT Setup Photos



Picture D.6

ANNEX E: Equivalent Media Recipes

The liquid used for the frequency range of 700-6000 MHz consisted of water, sugar, salt, preventol, glycol monobutyl and Cellulose. The liquid has been previously proven to be suited for worst-case. The Table E.1 shows the detail solution. It's satisfying the latest tissue dielectric parameters requirements proposed by the IEEE 1528 and IEC 62209.

Table E.1: Composition of the Tissue Equivalent Matter

Frequency (MHz)	835	1750	1900	2450	2600	5200	5800
Water	41.45	55.242	55.242	58.79	58.79	65.53	66.10
Sugar	56.0	/	/	/	/	/	/
Salt	1.45	0.306	0.306	0.06	0.06		
Preventol	0.1	/	/	/	/	17.24	16.95
Cellulose	1.0	/	/	/	/	17.24	16.95
Glycol Monobutyl	/	44.452	44.452	41.15	41.15	/	/
Diethylenglycol monohexylether	/	/	/	/	/	/	/
Triton X-100	/	/	/	/	/	/	/
Dielectric Parameters Target Value	$\epsilon=41.5$ $\sigma=0.90$	$\epsilon=40.08$ $\sigma=1.37$	$\epsilon=40.0$ $\sigma=1.40$	$\epsilon=39.20$ $\sigma=1.80$	$\epsilon=39.01$ $\sigma=1.96$	$\epsilon=35.99$ $\sigma=4.66$	$\epsilon=35.30$ $\sigma=5.27$

Note: There is a little adjustment respectively for 750, 5300 and 5600, based on the recipe of closest frequency in table E.1

ANNEX F: System Validation

The SAR system must be validated against its performance specifications before it is deployed. When SAR probes, system components or software are changed, upgraded or recalibrated, these must be validated with the SAR system(s) that operates with such components.

Table F.1: System Validation

Probe SN.	Liquid name	Validation date	Frequency point	Status (OK or Not)
7621	Head 750MHz	2022-05-09	750MHz	OK
7621	Head 835MHz	2022-05-09	835MHz	OK
7621	Head 1750MHz	2022-05-09	1750MHz	OK
7621	Head 1900MHz	2022-05-09	1900MHz	OK
7621	Head 2300MHz	2022-05-09	2300MHz	OK
7621	Head 2450MHz	2022-05-08	2450MHz	OK
7621	Head 2550MHz	2022-05-08	2550MHz	OK
7621	Head 3500MHz	2022-05-10	3500MHz	OK
7621	Head 3700MHz	2022-05-10	3700MHz	OK
7621	Head 3900MHz	2022-05-10	3900MHz	OK
7621	Head 5250MHz	2022-05-08	5250MHz	OK
7621	Head 5600MHz	2022-05-08	5600MHz	OK
7621	Head 5750MHz	2022-05-08	5750MHz	OK



ANNEX G: DAE Calibration Certificate



Add: No.52 HuaYuanBei Road, Haidian District, Beijing, 100191, China
Tel: +86-10-62304633-2512 Fax: +86-10-62304633-2504
E-mail: cttl@chinattl.com [Http://www.chinattl.cn](http://www.chinattl.cn)



中国认可
国际互认
校准
CALIBRATION
CNAS L0570



Client : SAICT

Certificate No: Z22-60003

CALIBRATION CERTIFICATE

Object: DAE4 - SN: 1527

Calibration Procedure(s): FF-Z11-002-01
Calibration Procedure for the Data Acquisition Electronics (DAEx)

Calibration date: January 12, 2022

This calibration Certificate documents the traceability to national standards, which realize the physical units of measurements(SI). The measurements and the uncertainties with confidence probability are given on the following pages and are part of the certificate.

All calibrations have been conducted in the closed laboratory facility: environment temperature(22±3)°C and humidity<70%.

Calibration Equipment used (M&TE critical for calibration)

Primary Standards	ID #	Cal Date(Calibrated by, Certificate No.)	Scheduled Calibration
Process Calibrator 753	1971018	15-Jun-21 (CTTL, No.J21X04465)	Jun-22

	Name	Function	Signature
Calibrated by:	Yu Zongying	SAR Test Engineer	
Reviewed by:	Lin Hao	SAR Test Engineer	
Approved by:	Qi Dianyuan	SAR Project Leader	

Issued: January 14, 2022

This calibration certificate shall not be reproduced except in full without written approval of the laboratory.



Add: No.52 HuaYuanBei Road, Haidian District, Beijing, 100191, China
Tel: +86-10-62304633-2512 Fax: +86-10-62304633-2504
E-mail: cttl@chinattl.com Http://www.chinattl.cn

Glossary:

DAE data acquisition electronics
Connector angle information used in DASY system to align probe sensor X to the robot coordinate system.

Methods Applied and Interpretation of Parameters:

- *DC Voltage Measurement:* Calibration Factor assessed for use in DASY system by comparison with a calibrated instrument traceable to national standards. The figure given corresponds to the full scale range of the voltmeter in the respective range.
- *Connector angle:* The angle of the connector is assessed measuring the angle mechanically by a tool inserted. Uncertainty is not required.
- The report provide only calibration results for DAE, it does not contain other performance test results.



Add: No.52 HuaYuanBei Road, Haidian District, Beijing, 100191, China
Tel: +86-10-62304633-2512 Fax: +86-10-62304633-2504
E-mail: cttl@chinattl.com Http://www.chinattl.cn

DC Voltage Measurement

A/D - Converter Resolution nominal

High Range: 1LSB = 6.1μV, full range = -100...+300 mV

Low Range: 1LSB = 61nV, full range = -1.....+3mV

DASY measurement parameters: Auto Zero Time: 3 sec; Measuring time: 3 sec

Calibration Factors	X	Y	Z
High Range	403.864 ± 0.15% (k=2)	403.585 ± 0.15% (k=2)	403.806 ± 0.15% (k=2)
Low Range	3.95854 ± 0.7% (k=2)	3.98858 ± 0.7% (k=2)	3.96746 ± 0.7% (k=2)

Connector Angle

Connector Angle to be used in DASY system	224° ± 1 °
---	------------

ANNEX H: Probe Calibration Certificate



In Collaboration with
SPEAG
CALIBRATION LABORATORY

Add: No.52 HuaYuanBei Road, Haidian District, Beijing, 100191, China
Tel: +86-10-62304633-2117
E-mail: cttl@chinattl.com http://www.caict.ac.cn



中国认可
国际互认
校准
CALIBRATION
CNAS L0570



Client **SAICT**
Certificate No: **Z22-60124**

CALIBRATION CERTIFICATE			
Object	EX3DV4 - SN : 7621		
Calibration Procedure(s)	FF-Z11-004-02 Calibration Procedures for Dosimetric E-field Probes		
Calibration date:	May 06, 2022		
<p>This calibration Certificate documents the traceability to national standards, which realize the physical units of measurements(SI). The measurements and the uncertainties with confidence probability are given on the following pages and are part of the certificate.</p> <p>All calibrations have been conducted in the closed laboratory facility: environment temperature(22±3)°C and humidity<70%.</p> <p>Calibration Equipment used (M&TE critical for calibration)</p>			
Primary Standards	ID #	Cal Date(Calibrated by, Certificate No.)	Scheduled Calibration
Power Meter NRP2	101919	15-Jun-21(CTTL, No.J21X04466)	Jun-22
Power sensor NRP-Z91	101547	15-Jun-21(CTTL, No.J21X04466)	Jun-22
Power sensor NRP-Z91	101548	15-Jun-21(CTTL, No.J21X04466)	Jun-22
Reference 10dBAttenuator	18N50W-10dB	20-Jan-21(CTTL, No.J21X00486)	Jan-23
Reference 20dBAttenuator	18N50W-20dB	20-Jan-21(CTTL, No.J21X00485)	Jan-23
Reference Probe EX3DV4	SN 7464	26-Jan-22(SPEAG, No.EX3-7464_Jan22)	Jan-23
DAE4	SN 1555	20-Aug-21(SPEAG, No.DAE4-1555_Aug21/2)	Aug-22
Secondary Standards	ID #	Cal Date(Calibrated by, Certificate No.)	Scheduled Calibration
SignalGenerator MG3700A	6201052605	16-Jun-21(CTTL, No.J21X04467)	Jun-22
Network Analyzer E5071C	MY46110673	14-Jan-22(CTTL, No.J22X00406)	Jan-23
Calibrated by:	Name Yu Zongying	Function SAR Test Engineer	Signature 
Reviewed by:	Name Lin Hao	Function SAR Test Engineer	Signature 
Approved by:	Name Qi Dianyuan	Function SAR Project Leader	Signature 
Issued: May 23, 2022			
This calibration certificate shall not be reproduced except in full without written approval of the laboratory.			



In Collaboration with
s p e a g
CALIBRATION LABORATORY



Add: No.52 HuaYuanBei Road, Haidian District, Beijing, 100191, China
Tel: +86-10-62304633-2117
E-mail: cttl@chinattl.com <http://www.caict.ac.cn>

Glossary:

TSL	tissue simulating liquid
NORM _{x,y,z}	sensitivity in free space
ConvF	sensitivity in TSL / NORM _{x,y,z}
DCP	diode compression point
CF	crest factor (1/duty_cycle) of the RF signal
A,B,C,D	modulation dependent linearization parameters
Polarization Φ	Φ rotation around probe axis
Polarization θ	θ rotation around an axis that is in the plane normal to probe axis (at measurement center), i $\theta=0$ is normal to probe axis

Connector Angle information used in DASY system to align probe sensor X to the robot coordinate system

Calibration is Performed According to the Following Standards:

- IEEE Std 1528-2013, "IEEE Recommended Practice for Determining the Peak Spatial-Averaged Specific Absorption Rate (SAR) in the Human Head from Wireless Communications Devices: Measurement Techniques", June 2013
- IEC 62209-1, "Measurement procedure for the assessment of Specific Absorption Rate (SAR) from hand-held and body-mounted devices used next to the ear (frequency range of 300 MHz to 6 GHz)", July 2016
- IEC 62209-2, "Procedure to determine the Specific Absorption Rate (SAR) for wireless communication devices used in close proximity to the human body (frequency range of 30 MHz to 6 GHz)", March 2010
- KDB 865664, "SAR Measurement Requirements for 100 MHz to 6 GHz"

Methods Applied and Interpretation of Parameters:

- NORM_{x,y,z}**: Assessed for E-field polarization $\theta=0$ ($f \leq 900$ MHz in TEM-cell; $f > 1800$ MHz: waveguide). NORM_{x,y,z} are only intermediate values, i.e., the uncertainties of NORM_{x,y,z} does not effect the E^2 -field uncertainty inside TSL (see below ConvF).
- NORM(f)_{x,y,z}** = NORM_{x,y,z} * frequency_response (see Frequency Response Chart). This linearization is implemented in DASY4 software versions later than 4.2. The uncertainty of the frequency response is included in the stated uncertainty of ConvF.
- DCP_{x,y,z}**: DCP are numerical linearization parameters assessed based on the data of power sweep (no uncertainty required). DCP does not depend on frequency nor media.
- PAR**: PAR is the Peak to Average Ratio that is not calibrated but determined based on the signal characteristics.
- A_{x,y,z}; B_{x,y,z}; C_{x,y,z}; VR_{x,y,z}; A,B,C** are numerical linearization parameters assessed based on the data of power sweep for specific modulation signal. The parameters do not depend on frequency nor media. VR is the maximum calibration range expressed in RMS voltage across the diode.
- ConvF and Boundary Effect Parameters**: Assessed in flat phantom using E-field (or Temperature Transfer Standard for $f \leq 800$ MHz) and inside waveguide using analytical field distributions based on power measurements for $f > 800$ MHz. The same setups are used for assessment of the parameters applied for boundary compensation (alpha, depth) of which typical uncertainty valued are given. These parameters are used in DASY4 software to improve probe accuracy close to the boundary. The sensitivity in TSL corresponds to NORM_{x,y,z} * ConvF whereby the uncertainty corresponds to that given for ConvF. A frequency dependent ConvF is used in DASY version 4.4 and higher which allows extending the validity from ± 50 MHz to ± 100 MHz.
- Spherical isotropy (3D deviation from isotropy)**: in a field of low gradients realized using a flat phantom exposed by a patch antenna.
- Sensor Offset**: The sensor offset corresponds to the offset of virtual measurement center from the probe tip (on probe axis). No tolerance required.
- Connector Angle**: The angle is assessed using the information gained by determining the NORM_x (no uncertainty required).



Add: No.52 HuaYuanBei Road, Haidian District, Beijing, 100191, China
 Tel: +86-10-62304633-2117
 E-mail: cttl@chinattl.com http://www.caict.ac.cn

DASY/EASY – Parameters of Probe: EX3DV4 – SN:7621

Basic Calibration Parameters

	Sensor X	Sensor Y	Sensor Z	Unc (k=2)
Norm($\mu\text{V}/(\text{V}/\text{m})^2$) ^A	0.71	0.71	0.56	$\pm 10.0\%$
DCP(mV) ^B	111.7	111.8	115.7	

Modulation Calibration Parameters

UID	Communication System Name		A dB	B dB- μV	C	D dB	VR mV	Unc ^E (k=2)
0	CW	X	0.0	0.0	1.0	0.00	210.8	$\pm 3.5\%$
		Y	0.0	0.0	1.0		218.6	
		Z	0.0	0.0	1.0		190.8	

The reported uncertainty of measurement is stated as the standard uncertainty of Measurement multiplied by the coverage factor $k=2$, which for a normal distribution Corresponds to a coverage probability of approximately 95%.

^A The uncertainties of Norm X, Y, Z do not affect the E^2 -field uncertainty inside TSL (see Page 4).

^B Numerical linearization parameter: uncertainty not required.

^E Uncertainty is determined using the max. deviation from linear response applying rectangular distribution and is expressed for the square of the field value.

DASY/EASY – Parameters of Probe: EX3DV4 – SN:7621

Calibration Parameter Determined in Head Tissue Simulating Media

f [MHz] ^C	Relative Permittivity ^F	Conductivity (S/m) ^F	ConvF X	ConvF Y	ConvF Z	Alpha ^G	Depth ^G (mm)	Unct. (k=2)
750	41.9	0.89	11.12	11.12	11.12	0.18	1.14	±12.1%
900	41.5	0.97	10.68	10.68	10.68	0.14	1.14	±12.1%
1450	40.5	1.20	9.65	9.65	9.65	0.21	0.91	±12.1%
1750	40.1	1.37	9.22	9.22	9.22	0.31	0.90	±12.1%
1900	40.0	1.40	8.90	8.90	8.90	0.35	0.84	±12.1%
2100	39.8	1.49	8.95	8.95	8.95	0.23	1.13	±12.1%
2300	39.5	1.67	8.60	8.60	8.60	0.44	0.78	±12.1%
2450	39.2	1.80	8.17	8.17	8.17	0.49	0.78	±12.1%
2600	39.0	1.96	7.93	7.93	7.93	0.51	0.75	±12.1%
3300	38.2	2.71	7.74	7.74	7.74	0.45	0.92	±13.3%
3500	37.9	2.91	7.56	7.56	7.56	0.44	1.00	±13.3%
3700	37.7	3.12	7.18	7.18	7.18	0.38	1.05	±13.3%
3900	37.5	3.32	7.26	7.26	7.26	0.35	1.35	±13.3%
4100	37.2	3.53	7.21	7.21	7.21	0.25	1.30	±13.3%
4400	36.9	3.84	7.01	7.01	7.01	0.25	1.55	±13.3%
4600	36.7	4.04	6.90	6.90	6.90	0.30	1.72	±13.3%
4800	36.4	4.25	6.79	6.79	6.79	0.30	1.85	±13.3%
4950	36.3	4.40	6.44	6.44	6.44	0.30	1.80	±13.3%
5250	35.9	4.71	5.98	5.98	5.98	0.35	1.63	±13.3%
5600	35.5	5.07	5.47	5.47	5.47	0.40	1.55	±13.3%
5750	35.4	5.22	5.40	5.40	5.40	0.40	1.55	±13.3%

^C Frequency validity above 300 MHz of ±100MHz only applies for DASY v4.4 and higher (Page 2), else it is restricted to ±50MHz. The uncertainty is the RSS of ConvF uncertainty at calibration frequency and the uncertainty for the indicated frequency band. Frequency validity below 300 MHz is ± 10, 25, 40, 50 and 70 MHz for ConvF assessments at 30, 64, 128, 150 and 220 MHz respectively. Above 5 GHz frequency validity can be extended to ± 110 MHz.

^F At frequency below 3 GHz, the validity of tissue parameters (ϵ and σ) can be relaxed to ±10% if liquid compensation formula is applied to measured SAR values. At frequencies above 3 GHz, the validity of tissue parameters (ϵ and σ) is restricted to ±5%. The uncertainty is the RSS of the ConvF uncertainty for indicated target tissue parameters.

^G Alpha/Depth are determined during calibration. SPEAG warrants that the remaining deviation due to the boundary effect after compensation is always less than ± 1% for frequencies below 3 GHz and below ± 2% for the frequencies between 3-6 GHz at any distance larger than half the probe tip diameter from the boundary.

Frequency Response of E-Field (TEM-Cell: ifi110 EXX, Waveguide: R22)

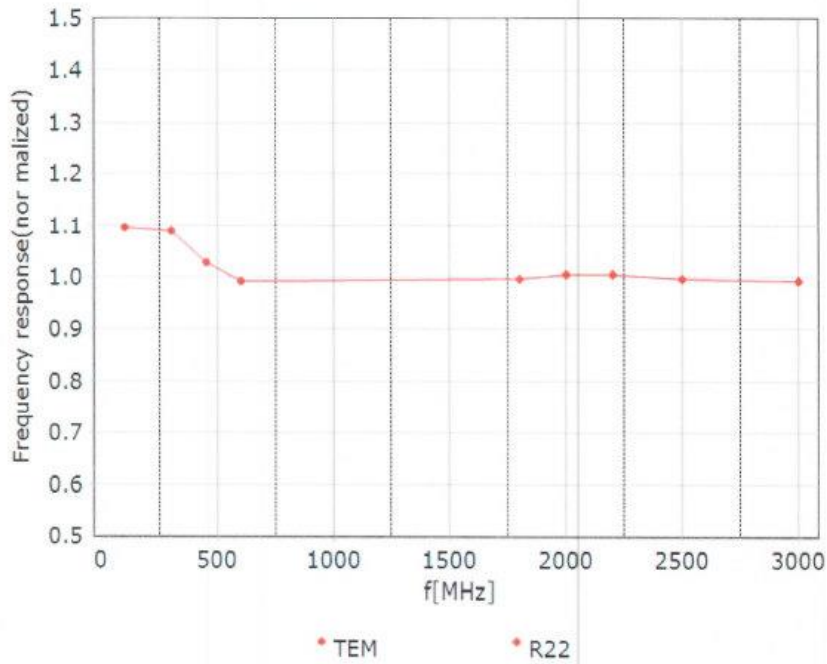

Uncertainty of Frequency Response of E-field: $\pm 7.4\%$ ($k=2$)

Receiving Pattern (Φ), $\theta=0^\circ$

f=600 MHz, TEM

f=1800 MHz, R22

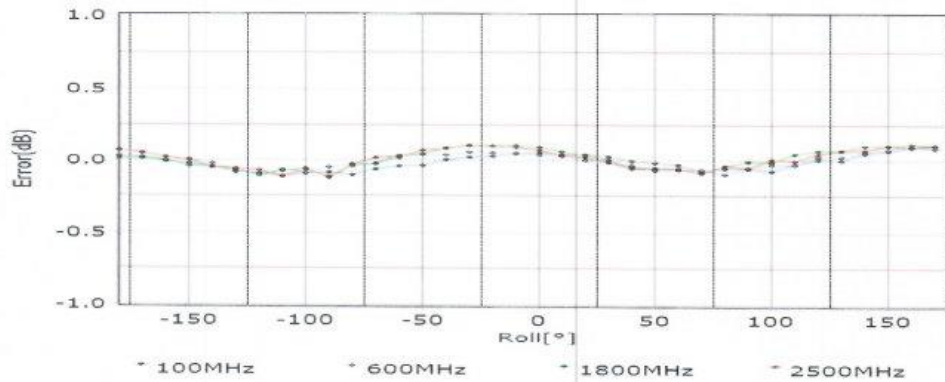
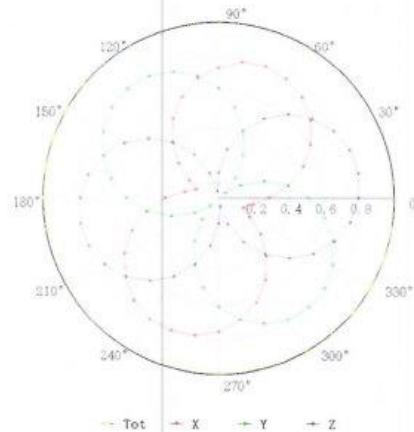
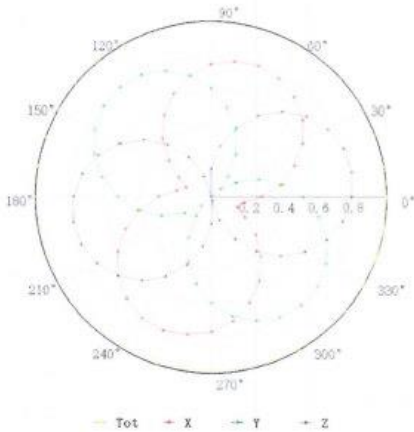

Uncertainty of Axial Isotropy Assessment: $\pm 1.2\%$ ($k=2$)

Dynamic Range f(SAR_{head}) (TEM cell, f = 900 MHz)

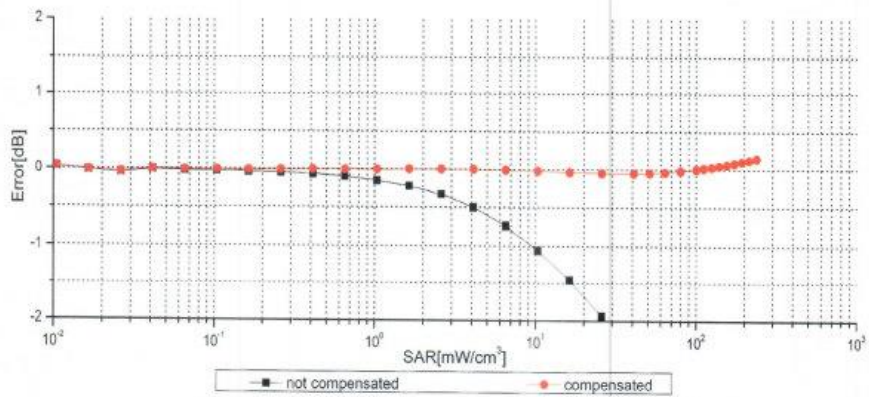
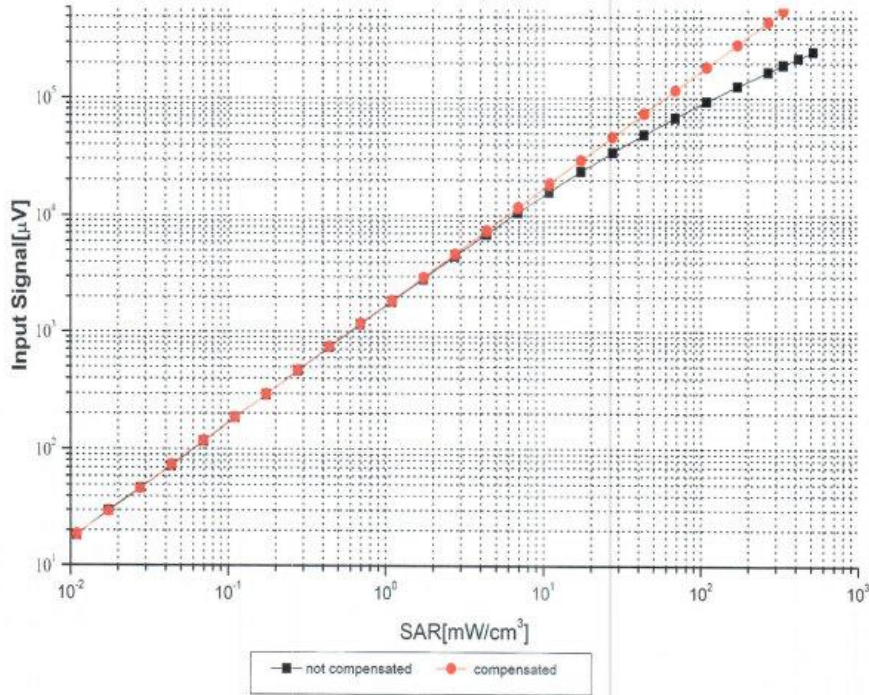

Uncertainty of Linearity Assessment: ±0.9% (k=2)

Conversion Factor Assessment

f=750 MHz,WGLS R9(H_convF)

f=1750 MHz,WGLS R22(H_convF)

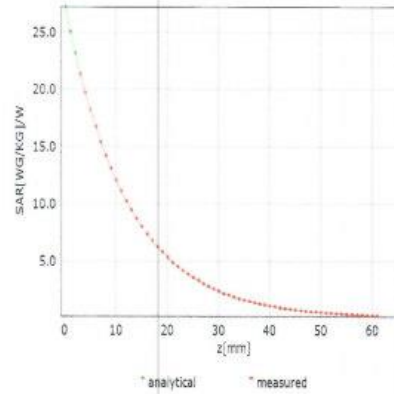
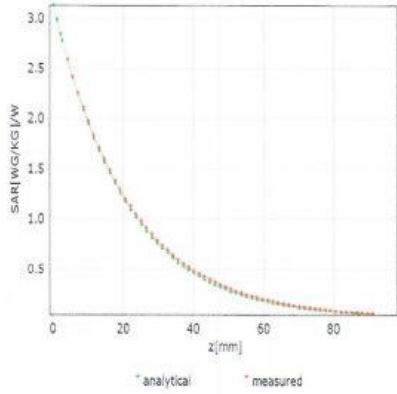

Deviation from Isotropy in Liquid

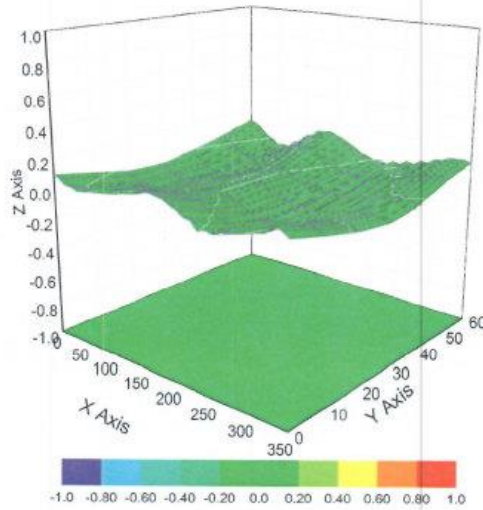

Uncertainty of Spherical Isotropy Assessment: $\pm 3.2\%$ ($k=2$)

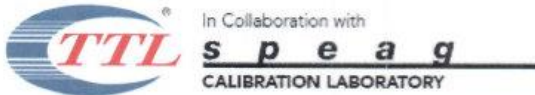

Add: No.52 HuaYuanBei Road, Haidian District, Beijing, 100191, China
Tel: +86-10-62304633-2117
E-mail: cttl@chinattf.com <http://www.caict.ac.cn>



DASY/EASY – Parameters of Probe: EX3DV4 – SN:7621

Other Probe Parameters

Sensor Arrangement	Triangular
Connector Angle (°)	95.4
Mechanical Surface Detection Mode	enabled
Optical Surface Detection Mode	disable
Probe Overall Length	337mm
Probe Body Diameter	10mm
Tip Length	9mm
Tip Diameter	2.5mm
Probe Tip to Sensor X Calibration Point	1mm
Probe Tip to Sensor Y Calibration Point	1mm
Probe Tip to Sensor Z Calibration Point	1mm
Recommended Measurement Distance from Surface	1.4mm

ANNEX I: Dipole Calibration Certificate

3500MHz Dipole

Calibration Laboratory of
Schmid & Partner
Engineering AG
 Zeughausstrasse 43, 8004 Zurich, Switzerland





S Schweizerischer Kalibrierdienst
C Service suisse d'étalonnage
S Servizio svizzero di taratura
S Swiss Calibration Service

Accredited by the Swiss Accreditation Service (SAS)
 The Swiss Accreditation Service is one of the signatories to the EA
 Multilateral Agreement for the recognition of calibration certificates

Accreditation No.: **SCS 0108**

Client **CAICT-SZ (Auden)**

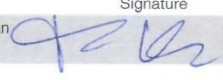
Certificate No: **D3500V2-1084_Sep19**

CALIBRATION CERTIFICATE																																																											
Object	D3500V2 - SN:1084																																																										
Calibration procedure(s)	QA CAL-22.v4 Calibration Procedure for SAR Validation Sources between 3-6 GHz																																																										
Calibration date:	September 20, 2019																																																										
<p>This calibration certificate documents the traceability to national standards, which realize the physical units of measurements (SI). The measurements and the uncertainties with confidence probability are given on the following pages and are part of the certificate.</p> <p>All calibrations have been conducted in the closed laboratory facility: environment temperature (22 ± 3)°C and humidity < 70%.</p> <p>Calibration Equipment used (M&TE critical for calibration)</p> <table border="1"> <thead> <tr> <th>Primary Standards</th> <th>ID #</th> <th>Cal Date (Certificate No.)</th> <th>Scheduled Calibration</th> </tr> </thead> <tbody> <tr> <td>Power meter NRP</td> <td>SN: 104778</td> <td>03-Apr-19 (No. 217-02892/02893)</td> <td>Apr-20</td> </tr> <tr> <td>Power sensor NRP-Z91</td> <td>SN: 103244</td> <td>03-Apr-19 (No. 217-02892)</td> <td>Apr-20</td> </tr> <tr> <td>Power sensor NRP-Z91</td> <td>SN: 103245</td> <td>03-Apr-19 (No. 217-02893)</td> <td>Apr-20</td> </tr> <tr> <td>Reference 20 dB Attenuator</td> <td>SN: 5058 (20k)</td> <td>04-Apr-19 (No. 217-02894)</td> <td>Apr-20</td> </tr> <tr> <td>Type-N mismatch combination</td> <td>SN: 5047.2 / 06327</td> <td>04-Apr-19 (No. 217-02895)</td> <td>Apr-20</td> </tr> <tr> <td>Reference Probe EX3DV4</td> <td>SN: 3503</td> <td>25-Mar-19 (No. EX3-3503_Mar19)</td> <td>Mar-20</td> </tr> <tr> <td>DAE4</td> <td>SN: 601</td> <td>30-Apr-19 (No. DAE4-601_Apr19)</td> <td>Apr-20</td> </tr> </tbody> </table> <table border="1"> <thead> <tr> <th>Secondary Standards</th> <th>ID #</th> <th>Check Date (in house)</th> <th>Scheduled Check</th> </tr> </thead> <tbody> <tr> <td>Power meter E4419B</td> <td>SN: GB39512475</td> <td>30-Oct-14 (in house check Feb-19)</td> <td>In house check: Oct-20</td> </tr> <tr> <td>Power sensor HP 8481A</td> <td>SN: US37292783</td> <td>07-Oct-15 (in house check Oct-18)</td> <td>In house check: Oct-20</td> </tr> <tr> <td>Power sensor HP 8481A</td> <td>SN: MY41092317</td> <td>07-Oct-15 (in house check Oct-18)</td> <td>In house check: Oct-20</td> </tr> <tr> <td>RF generator R&S SMT-06</td> <td>SN: 100972</td> <td>15-Jun-15 (in house check Oct-18)</td> <td>In house check: Oct-20</td> </tr> <tr> <td>Network Analyzer Agilent E8358A</td> <td>SN: US41080477</td> <td>31-Mar-14 (in house check Oct-18)</td> <td>In house check: Oct-19</td> </tr> </tbody> </table>				Primary Standards	ID #	Cal Date (Certificate No.)	Scheduled Calibration	Power meter NRP	SN: 104778	03-Apr-19 (No. 217-02892/02893)	Apr-20	Power sensor NRP-Z91	SN: 103244	03-Apr-19 (No. 217-02892)	Apr-20	Power sensor NRP-Z91	SN: 103245	03-Apr-19 (No. 217-02893)	Apr-20	Reference 20 dB Attenuator	SN: 5058 (20k)	04-Apr-19 (No. 217-02894)	Apr-20	Type-N mismatch combination	SN: 5047.2 / 06327	04-Apr-19 (No. 217-02895)	Apr-20	Reference Probe EX3DV4	SN: 3503	25-Mar-19 (No. EX3-3503_Mar19)	Mar-20	DAE4	SN: 601	30-Apr-19 (No. DAE4-601_Apr19)	Apr-20	Secondary Standards	ID #	Check Date (in house)	Scheduled Check	Power meter E4419B	SN: GB39512475	30-Oct-14 (in house check Feb-19)	In house check: Oct-20	Power sensor HP 8481A	SN: US37292783	07-Oct-15 (in house check Oct-18)	In house check: Oct-20	Power sensor HP 8481A	SN: MY41092317	07-Oct-15 (in house check Oct-18)	In house check: Oct-20	RF generator R&S SMT-06	SN: 100972	15-Jun-15 (in house check Oct-18)	In house check: Oct-20	Network Analyzer Agilent E8358A	SN: US41080477	31-Mar-14 (in house check Oct-18)	In house check: Oct-19
Primary Standards	ID #	Cal Date (Certificate No.)	Scheduled Calibration																																																								
Power meter NRP	SN: 104778	03-Apr-19 (No. 217-02892/02893)	Apr-20																																																								
Power sensor NRP-Z91	SN: 103244	03-Apr-19 (No. 217-02892)	Apr-20																																																								
Power sensor NRP-Z91	SN: 103245	03-Apr-19 (No. 217-02893)	Apr-20																																																								
Reference 20 dB Attenuator	SN: 5058 (20k)	04-Apr-19 (No. 217-02894)	Apr-20																																																								
Type-N mismatch combination	SN: 5047.2 / 06327	04-Apr-19 (No. 217-02895)	Apr-20																																																								
Reference Probe EX3DV4	SN: 3503	25-Mar-19 (No. EX3-3503_Mar19)	Mar-20																																																								
DAE4	SN: 601	30-Apr-19 (No. DAE4-601_Apr19)	Apr-20																																																								
Secondary Standards	ID #	Check Date (in house)	Scheduled Check																																																								
Power meter E4419B	SN: GB39512475	30-Oct-14 (in house check Feb-19)	In house check: Oct-20																																																								
Power sensor HP 8481A	SN: US37292783	07-Oct-15 (in house check Oct-18)	In house check: Oct-20																																																								
Power sensor HP 8481A	SN: MY41092317	07-Oct-15 (in house check Oct-18)	In house check: Oct-20																																																								
RF generator R&S SMT-06	SN: 100972	15-Jun-15 (in house check Oct-18)	In house check: Oct-20																																																								
Network Analyzer Agilent E8358A	SN: US41080477	31-Mar-14 (in house check Oct-18)	In house check: Oct-19																																																								
Calibrated by:	Name Jeton Kastrati	Function Laboratory Technician	Signature 																																																								
Approved by:	Name Katja Pokovic	Function Technical Manager	Signature 																																																								
Issued: September 24, 2019																																																											
This calibration certificate shall not be reproduced except in full without written approval of the laboratory.																																																											

Calibration Laboratory of
Schmid & Partner
Engineering AG
Zeughausstrasse 43, 8004 Zurich, Switzerland



S Schweizerischer Kalibrierdienst
C Service suisse d'étalonnage
S Servizio svizzero di taratura
S Swiss Calibration Service

Accredited by the Swiss Accreditation Service (SAS)
The Swiss Accreditation Service is one of the signatories to the EA
Multilateral Agreement for the recognition of calibration certificates

Accreditation No.: **SCS 0108**

Glossary:

TSL	tissue simulating liquid
ConvF	sensitivity in TSL / NORM x,y,z
N/A	not applicable or not measured

Calibration is Performed According to the Following Standards:

- IEEE Std 1528-2013, "IEEE Recommended Practice for Determining the Peak Spatial-Averaged Specific Absorption Rate (SAR) in the Human Head from Wireless Communications Devices: Measurement Techniques", June 2013
- IEC 62209-1, "Measurement procedure for the assessment of Specific Absorption Rate (SAR) from hand-held and body-mounted devices used next to the ear (frequency range of 300 MHz to 6 GHz)", July 2016
- IEC 62209-2, "Procedure to determine the Specific Absorption Rate (SAR) for wireless communication devices used in close proximity to the human body (frequency range of 30 MHz to 6 GHz)", March 2010
- KDB 865664, "SAR Measurement Requirements for 100 MHz to 6 GHz"

Additional Documentation:

- DASY4/5 System Handbook

Methods Applied and Interpretation of Parameters:

- Measurement Conditions:* Further details are available from the Validation Report at the end of the certificate. All figures stated in the certificate are valid at the frequency indicated.
- Antenna Parameters with TSL:* The dipole is mounted with the spacer to position its feed point exactly below the center marking of the flat phantom section, with the arms oriented parallel to the body axis.
- Feed Point Impedance and Return Loss:* These parameters are measured with the dipole positioned under the liquid filled phantom. The impedance stated is transformed from the measurement at the SMA connector to the feed point. The Return Loss ensures low reflected power. No uncertainty required.
- Electrical Delay:* One-way delay between the SMA connector and the antenna feed point. No uncertainty required.
- SAR measured:* SAR measured at the stated antenna input power.
- SAR normalized:* SAR as measured, normalized to an input power of 1 W at the antenna connector.
- SAR for nominal TSL parameters:* The measured TSL parameters are used to calculate the nominal SAR result.

The reported uncertainty of measurement is stated as the standard uncertainty of measurement multiplied by the coverage factor $k=2$, which for a normal distribution corresponds to a coverage probability of approximately 95%.

Measurement Conditions

DASY system configuration, as far as not given on page 1.

DASY Version	DASY5	V52.10.2
Extrapolation	Advanced Extrapolation	
Phantom	Modular Flat Phantom	
Distance Dipole Center - TSL	10 mm	with Spacer
Zoom Scan Resolution	dx, dy = 4 mm, dz = 1.4 mm	Graded Ratio = 1.4 (Z direction)
Frequency	3500 MHz ± 1 MHz	

Head TSL parameters

The following parameters and calculations were applied.

	Temperature	Permittivity	Conductivity
Nominal Head TSL parameters	22.0 °C	37.9	2.91 mho/m
Measured Head TSL parameters	(22.0 ± 0.2) °C	37.6 ± 6 %	2.91 mho/m ± 6 %
Head TSL temperature change during test	< 0.5 °C	----	----

SAR result with Head TSL

SAR averaged over 1 cm ³ (1 g) of Head TSL	Condition	
SAR measured	100 mW input power	6.69 W/kg
SAR for nominal Head TSL parameters	normalized to 1W	66.8 W/kg ± 19.9 % (k=2)

SAR averaged over 10 cm ³ (10 g) of Head TSL	condition	
SAR measured	100 mW input power	2.52 W/kg
SAR for nominal Head TSL parameters	normalized to 1W	25.2 W/kg ± 19.5 % (k=2)

Appendix (Additional assessments outside the scope of SCS 0108)**Antenna Parameters with Head TSL**

Impedance, transformed to feed point	50.7 Ω + 2.4 j Ω
Return Loss	- 32.0 dB

General Antenna Parameters and Design

Electrical Delay (one direction)	1.142 ns
----------------------------------	----------

After long term use with 100W radiated power, only a slight warming of the dipole near the feedpoint can be measured.

The dipole is made of standard semirigid coaxial cable. The center conductor of the feeding line is directly connected to the second arm of the dipole. The antenna is therefore short-circuited for DC-signals. On some of the dipoles, small end caps are added to the dipole arms in order to improve matching when loaded according to the position as explained in the "Measurement Conditions" paragraph. The SAR data are not affected by this change. The overall dipole length is still according to the Standard.

No excessive force must be applied to the dipole arms, because they might bend or the soldered connections near the feedpoint may be damaged.

Additional EUT Data

Manufactured by	SPEAG
-----------------	-------

DASY5 Validation Report for Head TSL

Date: 20.09.2019

Test Laboratory: SPEAG, Zurich, Switzerland

DUT: Dipole 3500 MHz; Type: D3500V2; Serial: D3500V2 - SN:1084

Communication System: UID 0 - CW; Frequency: 3500 MHz

Medium parameters used: $f = 3500$ MHz; $\sigma = 2.91$ S/m; $\epsilon_r = 37.6$; $\rho = 1000$ kg/m³

Phantom section: Flat Section

Measurement Standard: DASY5 (IEEE/IEC/ANSI C63.19-2011)

DASY52 Configuration:

- Probe: EX3DV4 - SN3503; ConvF(7.75, 7.75, 7.75) @ 3500 MHz; Calibrated: 25.03.2019
- Sensor-Surface: 1.4mm (Mechanical Surface Detection)
- Electronics: DAE4 Sn601; Calibrated: 30.04.2019
- Phantom: Flat Phantom 5.0 (front); Type: QD 000 P50 AA; Serial: 1001
- DASY52 52.10.2(1504); SEMCAD X 14.6.12(7470)

Dipole Calibration for Head Tissue/Pin=100 mW, d=10mm 3500/Zoom Scan, dist=1.4mm**(8x8x8)/Cube 0:** Measurement grid: dx=4mm, dy=4mm, dz=1.4mm

Reference Value = 72.01 V/m; Power Drift = -0.06 dB

Peak SAR (extrapolated) = 18.5 W/kg

SAR(1 g) = 6.69 W/kg; SAR(10 g) = 2.52 W/kg

Maximum value of SAR (measured) = 12.9 W/kg

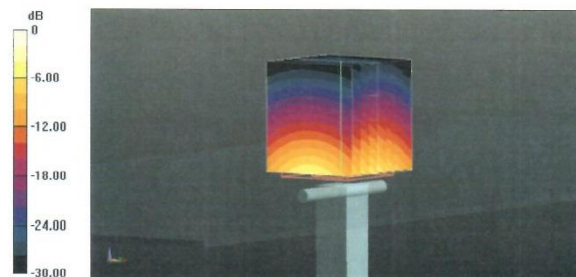

0 dB = 12.9 W/kg = 11.11 dBW/kg

Impedance Measurement Plot for Head TSL

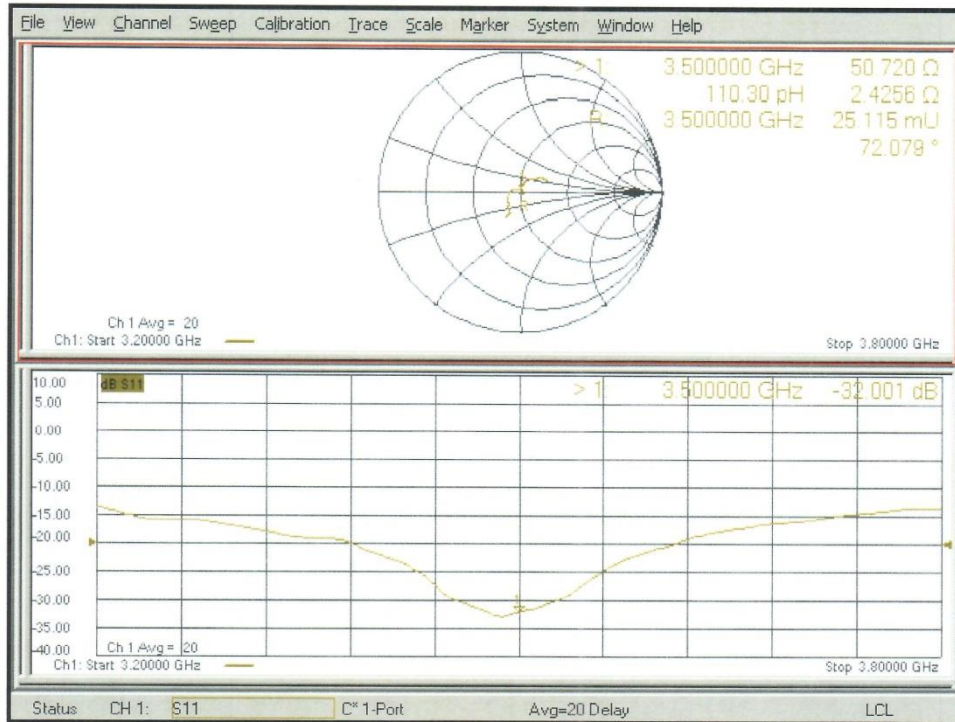



ANNEX J: Extended Calibration SAR Dipole

Referring to KDB865664 D01, if dipoles are verified in return loss (<-20dBm, within 20% of prior calibration), and in impedance (within 5 ohm of prior calibration), the annual calibration is not necessary and the calibration interval can be extended.

Justification of Extended Calibration SAR Dipole D3500V2– serial no.1084

Head						
Date of Measurement	Return-Loss (dB)	Delta (%)	Real Impedance (ohm)	Delta (ohm)	Imaginary Impedance (johm)	Delta (johm)
2019-09-20	-32.0	/	50.7	/	2.40	/
2020-09-19	-30.3	5.3	51.5	0.8	2.53	0.13
2021-09-18	-29.2	8.8	52.1	1.4	2.66	0.26

The Return-Loss is <-20dB, and within 20% of prior calibration; the impedance is within 5 ohm of prior calibration. Therefore the value result should support extended cabration.

*****END OF REPORT*****